

# ACORN USER

BBC MICRO · ELECTRON · ATOM NOVEMBER 1984 £1

*39 LEAF*  
**GREAT CONTEST!**  
Win a £66  
computer desk

**QUIZ FOR SCHOOLS:**  
10 software packs  
to be won  
from BBC Radio

**EDUCATION:**  
Getting children to  
write with confidence

**CLASHING ROMS:**  
The software  
solution

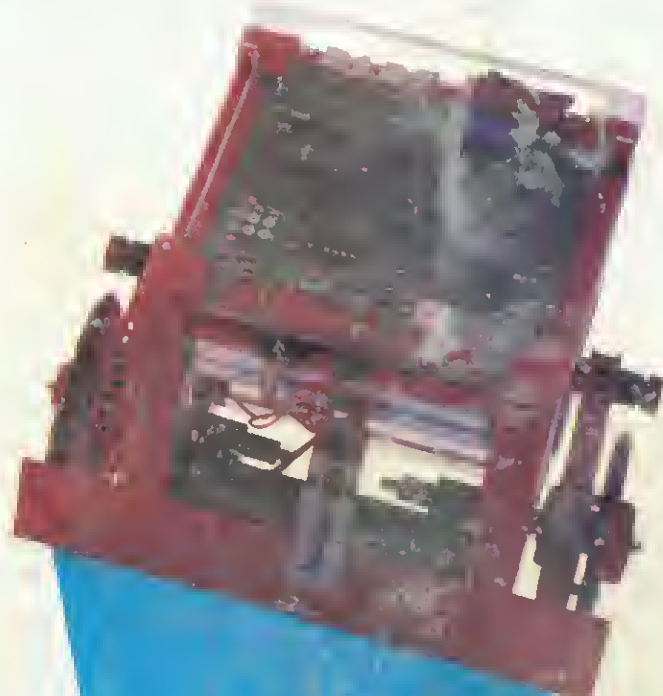

## BUGGIES SIX OF THE BEST

**REVIEWS:**  
Two digitisers  
to trace pictures

**MICRO LIVE ON TV:**  
Behind the scenes  
with the Producer



**SPECIAL OFFER:  
CUT-PRICE INSURANCE  
FOR YOUR  
MICRO**

# DOUBLE MEASURE...



AVAILABLE FROM ALL LVL DEALERS. (FOR FURTHER INFORMATION TELEPHONE 0602 394000)

**T**wice as much storage capacity on your present or proposed discs.

The LVL *true double density* printed circuit board offers an amazing 1,474,560 Bytes of on-line storage, on a twin 80 track double density drive.

Removed is the 8271; (it is not capable of supporting double density). In its place, a small printed circuit board with a new disc controller and support circuitry provides a much improved data retrieval.

This drastically reduces read errors by using a phased locked loop data separator, which is superior to the standard window circuit.

Your BBC micro will now recognise the media density in the drive, and inform you if it is correct. You may define what density you require, 40 or 80 track, and which sides of the disc to use.

The device gives complete flexibility and comes with an Eprom containing firmware; manual, and a 40/80 track utilities disc. On a dual drive it is simplicity itself to copy existing software from single density to double density.

- Double Density
- Automatically checks for correct density
- No 8271 (Rare & expensive)
- Utilities provided
- Defaults to single density on power up
- 40 or 80 track
- Own PCB with separate 8Mhz clock
- Simple to fit
- User definable density
- Phase lock loop data separator circuit.



Scientific House,  
Bridge Street, Sandlacre  
Nottingham. NG10 5BA  
Telephone (0602) 394000

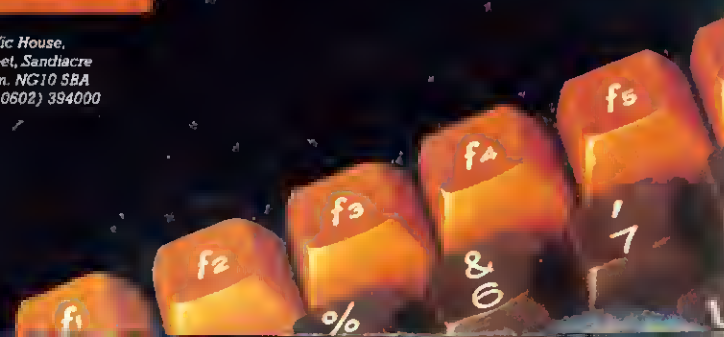



# AMX AMX MOUSE

## POINTS THE WAY TO...

- **Faster interaction**
- **Creative Graphics**
- **Enhanced Programs**

With the **AMX MOUSE**, from Advanced Memory Systems Ltd, the BBC Micro joins a new league of powerful user-friendly computers. Natural hand-eye co-ordination allows the **MOUSE** to position the cursor quickly and accurately. Alternatively by moving the **MOUSE** you can input specially written new software such as **ARTWORX**.

**ARTWORX** is a powerful graphics program allowing scope to produce amazingly vivid pictures and designs on your screen and printer. Simply point to any of the **ICONS** (small illustrations) and you select options of patterns and implements. Other options are offered by pull-down menus. All features can be activated using just the **MOUSE**.

The **AMX MOUSE** package includes **ARTWORX** and an EPROM with software to enable you to use the **MOUSE** with existing programs and also lets you use the **MOUSE**'s versatility in your own software. Just plug the **MOUSE** into the user port on a BBC Micro (model B) and the EPROM into a spare sideways socket.

Now simply fill in the coupon and we will send you an **AMX MOUSE** with **ARTWORX** with our full no quibble money back guarantee. OR phone 0925 602690/62907 for instant Access or Visa orders.

### ARTWORX graphics program

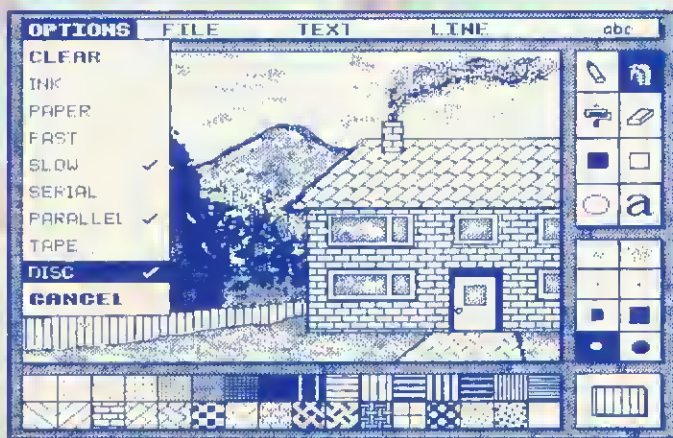

Please send No \_\_\_\_\_ **AMX MOUSE** packages (including **ARTWORX** and EPROM) at £89.95 inc. VAT and P&P. I enclose a cheque/PO for £ \_\_\_\_\_ or debit my credit card.

Card No   Visa  Access

Name \_\_\_\_\_

Address \_\_\_\_\_

Signature \_\_\_\_\_ Date \_\_\_\_\_

(Please tick choice of media for **ARTWORX**)  Cassette  3" Disc  5 1/4" Disc

To: Advanced Memory Systems Ltd., Woodside Technology Centre, Green Lane, Appleton, Warrington, WA4 5NG, England.

# ACORN USER

BBC MICRO · ELECTRON · ATOM NOVEMBER 1984 £1

**GREAT CONTEST!**  
Win a £65 computer desk

**QUIZ FOR SCHOOLS**  
10 software packs to be won from BBC Radio

**EDUCATION**  
Getting children to write with confidence

**CLASHING ROMS**  
The software solution

**REVIEWS**  
Two digitisers to trace pictures

**MICRO LIVE ON TV**  
Behind the scenes with the Producer



## BUGGIES SIX OF THE BEST

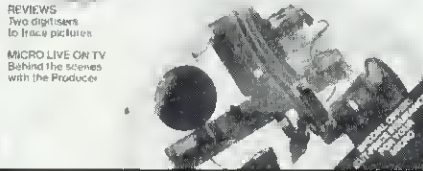

November 1984

No 28

Cover photograph by John Barlow

THE ONE AND ONLY BBC, ELECTRON AND ATOM MAGAZINE

## New Users

### First Byte

41

Tessie Revivis introduces techniques for drawing shapes on the screen and assembling them into your own designs

### Hints & Tips

45

Four pages bursting with good advice on converting TVs, polishing your programs, testing joysticks, sound-proofing acoustic couplers, and achieving 3D-effect printing - Martin Phillips is in the chair

### Letters

58

Hints on RTTY; why do peripherals cost so much?; the search for schools software; *Wordwise* in Spanish; and a suicide theory... Readers speak their minds

### Dear Kitty...

59

Mystery of the 'Bad mode' message; history of the Beeb. Kitty answers the questions that confuse the inexperienced micro-user

## Features

### Sprites cloned

65

You've drawn your sprite and learnt how to move it around the screen. Now in part 3 of his sprite generator series Harry Sinclair shows you how to produce clone and mirror images

### Floating point

74

Bruce Smith launches a new series which aims to take the aggro out of assembler. He tackles the subject of floating point variables

### ROM juggler

119

With Beeb and board full of ROMs, how can you be sure of calling up the one you want? David Blakey has the answer

### Beeb in the glasshouse

171

Second in our Trailblazer series is a report from Danny Green on how Reading researchers are using the BBC micro to monitor plant life

## Communications

### Tele tales

28

*Micro Live* producer David Allen recalls the traumas of putting live messages on the air

## Education

### News round-up

127

A new feature covering current issues, with news, opinion and feedback from teachers, pupils and other involved parties, edited by Nick Evans

### Edword at work

131

A classroom project presented Ron Gandolfo with the ideal opportunity to introduce wordprocessing to his pupils. How did Edword work out for them?

## Atom

### Atom Forum

121

The emphasis this month is on hardware modifications, so warm up your soldering iron while Barry Pickles introduces readers' wheezes

## Yellow listing pages

You'll find all the main listings of this issue in the yellow pages

<b>Barcode listing</b>	97
<i>Win a barcode reader worth £50!</i>	
<b>Program of the month</b>	99
<i>James Clarke's life-saver</i>	
<b>First byte</b>	100
<i>CALL me a car!</i>	
<b>Hints &amp; tips</b>	101
<i>A program polished up</i>	
<b>Graphics</b>	103
<i>The final version of 'Design'</i>	
<b>Floating point</b>	108
<i>Easy-to-follow demos</i>	
<b>Beeb Forum</b>	110
<i>Readers' routines</i>	
<b>ROM-con utility</b>	111
<i>Selection by software</i>	

Editor **Tony Quinn**  
 Production editor **Keith Parish**  
 Technical editors **Alex van Someren, Bruce Smith**  
 Editorial assistant **Kitty Milne**  
 Art editor **Nigel Wingrove**  
 Art assistant **Tacye Davis**  
 Publishing director **Michael Potter**  
 Editorial director **Christopher Ward**

### Editorial

Redwood Publishing,  
68 Long Acre, London  
WC2E 9JH. Tel: 01-836 2441



### Advertising

Computer Marketplace Ltd, 20  
Orange St, London WC2H 7ED.  
Tel: 01-930 1612

### Subscriptions

Jan Potter, Subscriptions manager.  
Tel: Nutfield Ridge (073782) 2957.  
Correspondence: Redwood Publishing, 68 Long Acre, London WC2E 9JH.

### Annual subscription rates:

UK	£15
Europe	£25
Middle East	£30
The Americas and Africa	£30
Rest of the World	£35

Prices include p&p for 12 issues

*Acorn User* welcomes submissions from readers. Articles should be typed, double-spaced text, with diagrams on separate sheets. Please enclose programs on disc or cassette, with a listing if possible. Photos should be 35mm, or larger, transparencies, or 5in by 7in black and white prints. Ensure your name is on everything. Please include a suitable stamped, addressed envelope for return. Articles are acknowledged on receipt.

Typeset and printed in Great Britain by Watmoughs Ltd, Bradford. Print production by Aquarius Print and Design, London. Distributed to the news trade by Comag, Tavistock Rd, West Drayton, Middlesex UB7 7QE. Tel: (0895) 44405.

### © Redwood Publishing 1984

All rights reserved. No part of this publication may be reproduced without prior written permission of the publisher. The publisher cannot accept any responsibility for claims or errors in articles, programs or advertisements published. The opinions expressed on the pages of this magazine are those of the authors and do not necessarily represent those of the publisher, Acorn Computers Ltd, or Acornsoft Ltd. Acorn, Acornsoft, and the Acorn symbol are the registered trademarks of Acorn Computers Ltd and Acornsoft Ltd.



## IN THIS ISSUE...

### AUTO Atom 125

Bruce Smith puts a finishing touch to the recent series of converting Beeb programs to AtomBasic with the AUTO command

## Reviews

### Joe's Jottings 82

Our man Telford tests a mixed batch: Toad's extension socket and Watford's Speech Synthesiser and Beebfont ROM

### Games 179

*Eagle's Wing* and *Spooks and Spiders* by Software Invasion; *Vision's Digger*

### Accent on WP 181

Chris Drage assesses Bbtype, a multi character-set wordprocessor offering foreign accents and technical/mathematical symbols

### Hardware 191

Ian Rowlings on the Romex 13 ROM board, and Barry Pickles on Philips' TP200 monitor

### Language learners 193

Simon Dally's report on language coaching packages from Beebugsoft, Salamander and Kosmos

### New books 195

## Regulars

### The News 7

Acorn results, Torch develops Unix, Beebs in India, South America and China, and Beeb could be prescribed for doctors

### Noticeboard 16

A new page to keep you primed about events you won't want to miss!

### Competition 87

Simon Dally picks another puzzle from his compendium - what do all the additions add up to  
**Plus** All the June winners!

### Beeb Forum 113

A useful bundle of tips, presented by Bruce Smith

### Top 20 Software 177

*Frak!* still f-f-first

### Acorn Abuser's Diary 224

Not the *Radio Times*...

### Buggies and turtles 164

With various full versions of the graphics-based Logo language set to appear, Geoff Nairn takes to the floor with six simple robots to explain what they can and cannot do

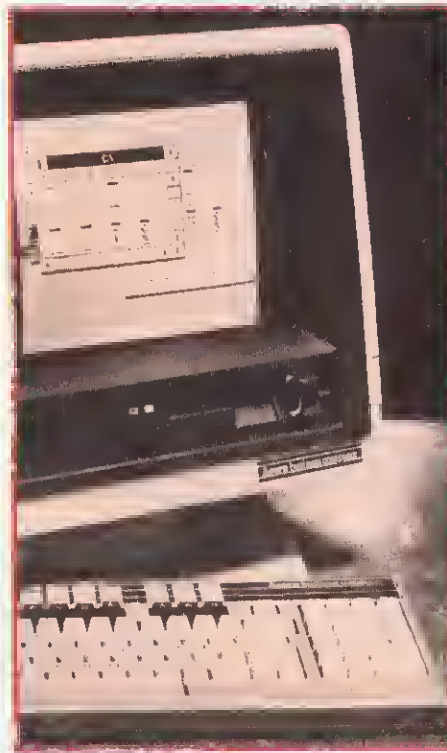
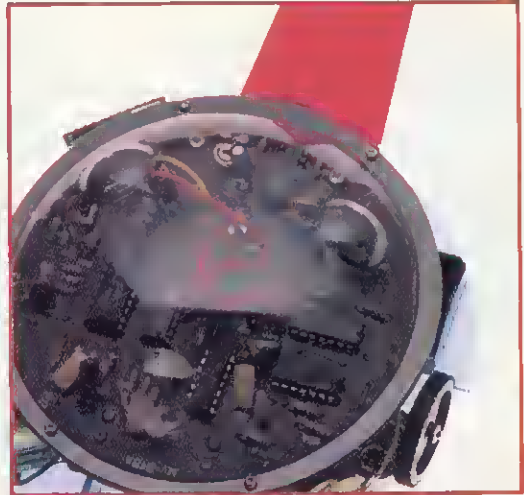

### Digitising duo 187

Two graphics tablets are taken to task and both come out well

### ABC marvel 30

Acorn's new 310 boasts the latest hardware and software the computer industry can offer. Turn to page 30 for a closer look and screen shots of the mouse-controlled icons

## NEW

### School quiz 127

The chance to win one of 10 BBC Radio software packs kicks off a new education news section that gives your school a hearing

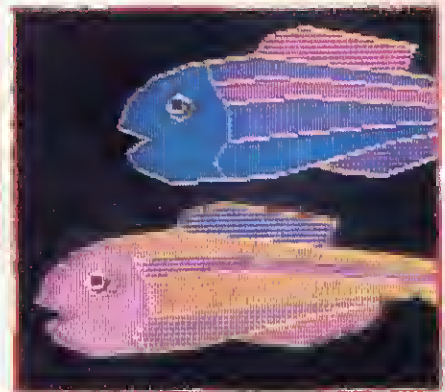

## NEXT MONTH...

### Database special

Find out how they work, type in your own, and read about six commercial versions

### Build an organ

An early Christmas present as Joe Telford takes you step-by-step through building a musical keyboard

### Printing screens

Dump those pretty games in colour or black-and-white

### Bar code listings

Find out about this foolproof method of inputting software

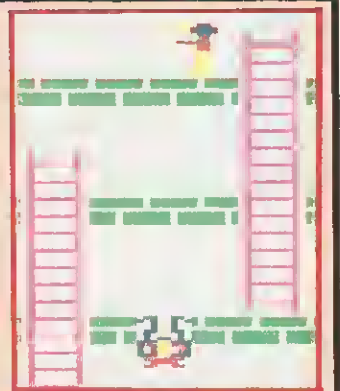

# Unicorn. Five new d Here's the full

**STOP PRESS**  
Now  
Multi-user  
UNIX on  
UNICORN

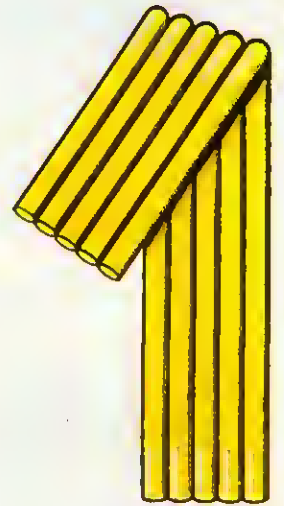

The new UNICORN range from TORCH Computers gives the enthusiast and professional user a choice of upgrades which takes the BBC Model B Micro to the ultimate height of performance.

The result of TORCH'S total commitment to the BBC Micro is the only complete range of high performance hardware available. Offering every BBC Micro owner five new upgrade channels, UNICORN will transform your BBC into a fully communicating workstation, a CP/M® compatible business machine or the ultimate in high powered 32-bit data processing.

At the top of the range, THE UNICORN, offers the power and sophistication of System III UNIX® whilst other channels make available the flexibility of languages such as FORTRAN, PASCAL, BCPL and COBOL. All models, with the exception of the HDP240, provide BBCBASIC(Z80) on the Z80 rather than the Model B's 6502.

Tune in to the Channel that most suits your requirements. Whichever level you choose you can be sure of a system with infinitely expandable potential for a confident future in the world of computing.

## The ZEP 100

- Z80 Extension Processor
- 4MHz Z80A
- 64K RAM
- 24K ROM

The object of any upgrade kit is to improve processing ability and to increase data storage capacity. The UNICORN ZEP100 is the first stage upgrade which opens channels into the world of serious computing.

The ZEP100 is the proven 8 bit second processor for the BBC Model B micro. A Z80 extension processor which enables the use of the well established CPN operating system, giving access to the vast range of applications programs and languages available for all CP/M® micros. When fitted to a BBC model B microcomputer with compatible high quality disc drives it provides a complete business or scientific computer which can run large applications programs or use advanced languages, with the ability to switch back to standard BBC programs at any time.

Any ZEP100 can be linked, via the Econet® option on the BBC, to a network of other TORCH computers to

provide a workstation running on TORCHNET. Full TORCHNET operating systems software is provided to allow access to information anywhere on the network, or to communicate with other computers.

The 64K ZEP100 is supplied with full software support including word processing, spreadsheet, database and utilities. **The ZEP100 - around \$299 (ex. VAT).**





# Channels for the BBC. programme.



## The ZDP 240

- 4MHz Z80A ● 64K RAM
- 24K ROM
- Twin, double sided 400K floppy discs
- Independent integral power supply



The UNICORN ZDP240 (Torch Z80 Disc Pack) is the proven upgrade for the BBC Model B micro-computer. Offering the use of more powerful and flexible languages such as Fortran, Pascal, BCPL and Cobol, it provides 800K of disc storage plus a Z80 second processor with 64K RAM running TORCH's own CP/M<sup>®</sup> compatible operating system based in ROM.

This advanced design means that almost all of the 64K RAM provided by the Z80 board is available for CP/M<sup>®</sup> programming use - an advantage no other BBC micro upgrade can offer.

If your BBC micro has the Econet<sup>®</sup> option, there is a further benefit the ZDP240 can offer. TORCHNET can link together up to 254 upgraded Model B's on a local area network, so for enthusiasts, Clubs and Schools it is a simple and low-cost way to achieve networking facilities.

The discs can be used for storage under the Acorn DFS system or for CP/M<sup>®</sup> programs and data.

A comprehensive software package is provided with the disc pack. It includes word and data processing and a spreadsheet program, along with utility programs and manuals.

The TORCH Z80 Disc pack is recommended by the CCTA for government use. **The ZDP 240 - around \$699 (ex. VAT).**



## The HDP 240

- 20Mbyte hard disc Winchester
- Double sided 400K floppy disc
- Integral power supply

For users who need much more storage capacity than is available on floppy discs and who require the large speed gains that a Winchester hard disc provides, the third new channel is now available.

The UNICORN HDP240 combines a 400K floppy disc drive with a 20Mb hard disc and its associated controller. The pack connects directly to the disc and 1MHz bus sockets on the BBC Model B.

In conjunction with a ZEP100, it provides a powerful business computer for running CP/M<sup>®</sup> programs with large amounts of data. The floppy disc can be used for storage with the Acorn DFS system, and both discs can be used by other TORCH systems on the TORCHNET local area network. **The HDP240 - around \$1995 (ex. VAT).**



## The HDP68K

- 8MHz MC68000 ● 6MHz Z80B
- 256K RAM (68000)
- 64K RAM (Z80)
- 20 Mbyte hard disc Winchester
- Double sided 400K floppy disc
- Integral power supply

The fourth channel in the UNICORN range is for users who need the extra processing power of a 68000 32 bit processor, as well as the Z80 running standard software. The UNICORN HDP68K provides the ultimate in performance, offering an extra 256K RAM and a 68000 processor running at 8 million cycles per second. It also contains a Z80 processor to allow the running of existing TORCH software.

**The HDP68K - around \$2495 (ex. VAT).**



## The Unicorn

Spec. as HDP68K PLUS UNIX<sup>®</sup> operating system. Single-user or Multi-user

UNIX<sup>®</sup> System III is the recognised operating system of the '80's. A very powerful and sophisticated multi-tasking system, it includes a vast library of utility programmes.

The fifth channel and top of the range, THE UNICORN, puts UNIX<sup>®</sup> within reach of the individual user, at a price unmatched by any other UNIX<sup>®</sup> systems, by combining the reliability of the BBC micro-with advanced technology from TORCH.

TORCH UNIX operates under the network operating system. Using UNICORN products, a low-cost network of BBC Micros can be configured to offer the most complete range of educational computing facilities available anywhere.

Other facilities available include UCSDp-System, LISP, FORTH, PILOT and PROLOG. **The UNICORN - from around \$2895 (ex. VAT).**

# UNICORN

Open channels for the BBC micro.

To: Torch Computers Ltd., Abberley House,  
Great Shelford, Cambridge CB2 5LQ.  
Telephone: Cambridge (0223) 841000.

Please send further information on the UNICORN range plus your FREE 1984 Software Catalogue.

Name \_\_\_\_\_

Address \_\_\_\_\_



AU11

**TORCH**  
COMPUTERS 

CP/M is a registered trademark of Digital Research, Inc.  
Econet is a registered trademark of Acorn Computers Ltd.  
Unix is a registered trademark of Bell Telephone Laboratories Inc.

UK version Model B necessary.  
Disc interfaces are necessary for use with the Unicorn range.

Text and Graphics provided by BBC Model B.  
Keyboard provided by BBC Model B.

# Don't play Blindman's Bluff.

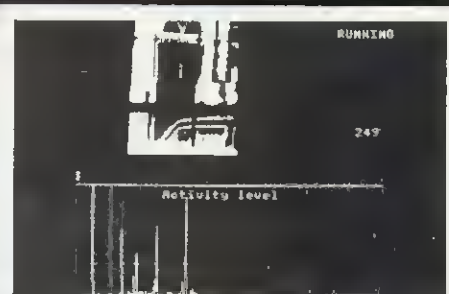
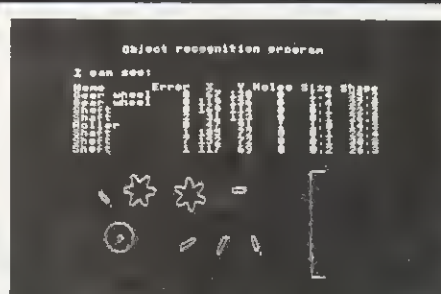

**Imaging** A program that takes pictures for printing, storage and transmission. A second version of the program can be used to record a short animation sequence.

**Object recognition** A powerful program for analysing a scene containing multiple non-overlapping parts. Area, perimeter, centre of gravity, are calculated in a split second.

**Movement detection** A program that analyses any movement in a scene which for example could be used to count the number of people moving down a street or ring an alarm if anything moves.

There's no need to keep your home computer in the dark a minute longer. The Micro-Robotics EV1 is a revolutionary new electronic camera that can be connected to your computer to give it the power of sight. It has applications in the fields of security, in industrial object recognition, graphic design, robotics and Artificial Intelligence. For the first time it is possible to capture black-and-white and grey scale pictures on a microcomputer without the use of an expensive external video camera. Full documentation and a comprehensive library of useful software are provided with each system, all for **only £129.95 (inc. VAT).**

**Dealer enquiries welcome.**

**Technical Specification**  
Resolution 246 x 128 Size 70 x 50 x 55 mm  
Capture Time 64mSec Interface Userport  
Weight 75 grms



Please send to:- Commotion, 241 Green Street, Enfield, EN3 7SJ. Tel: 804 1378.  
Please send me:-  Software on tape (BBC Model B)  Software on 80 track disc (BBC Model B)  
 Software on 40 track disc (BBC Model B)

Qty	Item	Ex VAT	Inc VAT	TOTAL
	EV1 Complete	£113.00	£129.95	
	Software on disc	£1.74	£2.00	
			Postage and Packaging	£1.25
			TOTAL	£

I enclose my cheque/P.O. for £ .....  
I prefer to pay by Barclaycard, Access Card (Please delete as necessary).  
Card No \_\_\_\_\_  
Signature \_\_\_\_\_  
Name \_\_\_\_\_ Address \_\_\_\_\_  
Address \_\_\_\_\_  
(Address above must be same as cardholder.)



## Acorn User part of India aid package

ACORN USER is part of a £1.2m gift to the Indian Government to introduce computing to schools. The funding comes from the Overseas Development Association as part of a British aid programme.

The scheme includes 900 BBC micros with Microvitec monitors, disc drives, printers and 50 different software packages. It came about as a result of the Queen's visit to India last year and her gift of 30 Beebes to the Indian Government with Econet networking systems.

### Queen's visit

Chris Bartel of the British Council, which is running the scheme for the ODA, explained: 'The impetus came from the Indians, mainly the Department of Electronics. The Queen's visit certainly helped.'

The first part of the ODA project was a visit earlier in the year by nine British teachers - *Acorn User* author Martin Phillips among them - to train Indian counterparts in the country's regional resource centres.

They had been preceded by 170 BBC systems, most of which survived the journey and the heat. 'Everything seemed to work splendidly,' said Bartel. 'The only problem was that some of the monitors were not packaged well enough.'

### Vital

The remaining micros and other hardware, with software - and several hundred *Acorn Users* - were due to have gone out last month. The make-up of the support package was fixed by a working party which decided that software and back-up through magazine subscriptions were vital.

An Indian delegation has been over to Britain to see the way micros are used here. As a result they decided to stress computer literacy rather than using the machines as an aid to teach other subjects.

Bartel said: 'The first machines have been sent to the resource centres, and there are none in schools yet.'

# ABC excites, but Acorn shares drop

ACORN's new range of business machines were barely a week out of their boxes last month before the company's shares slumped to an all-time low of 107p on the Unlisted Securities Market - well below last year's entry price of 120p.

The drop was nothing to do with the ABCs, which went down well at the PCW Show (see page 30), but with Acorn's profit results for the year. Although turnover more than doubled to £93m against £42m last year, profits rose by barely 20 per cent from £8.6m to £10.8m.

While Acorn Chairman Hermann Hauser was pleased with 'better than expected' sales and profits in the UK (£85m and £14m), losses caused by Acorn's entry into the US brought the figures down.

Acorn is rethinking its tactics, having sent former northern sales boss Joe Black over to sort things out. Also a new president has been appointed. However, Hauser was convinced the basic approach was right and that the company had merely been too optimistic about early sales.



Hauser: 'others talk, we do it'

'We've a sound foundation in the US and overseas,' said Hauser, 'and have established a name and reputation for quality and design.'

He was confident that this reputation and investment would pay off and result in 'a worthwhile share of the US market' within 'an acceptable timescale.'

The Acorn chairman was far more at home expounding Acorn's plans for the 'office machine for the future' expected to result from investment in a research house in Paulo Alto on the edge of California's Silicon Valley. This outpost is known as Acorn West and the concept is linked

to Acorn's venture with BSR to produce a small, inexpensive laser disc - essential for the office of the future, said Acorn's managing director Chris Curry.

Acorn is expecting another boom this Christmas to boost sales of the BBC, presently at 370,000, and the Electron which has sold 90,000, despite 'production delays' last year.

The Acorn board reckoned that 55-60 per cent of sales were achieved in the four months prior to Christmas, but expected the ABC machines and increased sales overseas to give a more balanced profile over the year.

Although sales director Peter O'Keefe pointed out that the ABC would not meet IBM 'head-on', Hauser was more bullish in dealing with Sinclair Research when talking about Acorn's VLSI chip design department. When it was pointed out that Sinclair had his own plans in that area, Hauser commented: 'May the best man win.'

He then went back to a comment made just a few minutes before about VLSI and added: 'You can infer from what I said earlier - others talk about it, we do it.'

## History in the making on page 97

HISTORY is being made this month with the publishing in *Acorn User* of barcode listings for the first time in a British computer magazine. It is part of a trial to establish the best way to present listings before the MEP-backed project starts in earnest.

Once equipped with a reader, users will be able to input program listings without having to laboriously type them in.

The advantages of this, especially for children and people new to computing, are immense. It offers a cheap way of distributing software without recourse to cassettes or

discs. And you will be able to print out your own programs and data as barcodes.

*Acorn User* has worked closely over the last year with the Microelectronics Education Programme (MEP) in developing the hardware and software to bring out a total package for under £50. Previously, the barcode reader alone has cost at least £80 from other manufacturers.

The package will be published by Addison-Wesley at the end of November complete with booklet, written by *Acorn User* author George Hill, and software. Next month we will explain how barcodes work

and how they could influence the way you use a computer.

Addison-Wesley will be exhibiting the readers at the Schools Computing Exhibition on November 6-7 in London's Bloomsbury Crest Hotel.

In the meantime, there's a little competition (one of three in this issue) for those who can decipher the Telepen format listing on page 97 and tell us which program in the yellow pages it represents. And, especially for those people who want to be the first with everything, the prize is - a barcode reader! And look out for next month's competition, too.

DURELLSOFTWARE'S

# Mineshaft

THE MAJOR MINER GAME

BBC & ELECTRON



Dare you dig it?

**£6.95**

from most  
retail stores  
or by post from

DURELLSOFTWARE Ltd

Castle Lodge,

Castle Green, Taunton,

Somerset TA1 4AB, England



## Touch tablet for software

**TOUCHMASTER** is a graphics tablet for the Beeb which can be used as a touch-pad input device (see picture). The A4-sized pressure-sensitive tablet offers a 256 by 256 resolution and drawing is done with a small stylus.

However, load in suitable software and slide a paper overlay on top, and the Touchmaster becomes a series of touch-pads – press one box for 'yes' and another for 'no', for example. The device costs £149.99, plus £4.99 for the Beeb interface.

Touchmaster is backed by a series of 'fun learning' pro-

grams. These are of the 'Simon Says' variety where young children press various boxes on the overlay in response to questions on the screen.

Other programs include: Draughts, Othello and Alien Break-In – all at £9.99. Included free with the tablet is **Multipaint**, a graphics package with routines for drawing circles and boxes.

The tablet is produced by a company set up in the factory formerly used by Dragon.

Contact Touchmaster at PO Box 3, Port Talbot, West Glamorgan, SA13 1WH.



## Wordprocessing update for Atom

THE latest version of the *Editor* wordprocessing ROM includes the ability to insert control characters anywhere in a text line (without upsetting justification) and a facility to spool consecutive text files from disc, using \* < filename > commands.

In addition, software is included to allow disc users access to direct-typesetting facilities. New embedded codes allow you to specify up to 200 different fonts and, having created and formatted your text using the *Editor*, the disc is then sent to the typesetters.

To use this facility you pay a premium of £15 (plus VAT), which gives you the enlarged manual and a licence registration. For non-Atom users interested in a cheap camera-ready medium, Bear Hardware has a limited number of complete Atom systems available.

Also from Bear Hardware, by arrangement with Acorn, you can now get the f.point and DOS ROMs.

Finally, from this busy company, comes news that it is working on a universal disc interface (which will work with the Atom), allowing single/double density on up to eight surfaces. The company hopes to have this available for Christmas and price is provisionally set at around the £100 mark.

Details from Bear Hardware, 68 Harmondsworth Lane, Harmondsworth, Middlesex UB7 0AA, tel: 01-897-3059.

# Torch develops Unix network for BBCs

by Geoff Nairn

TORCH Computers has developed a Multi-User Unix system to run on the BBC micro. Up to eight Beebs can be connected to a Torch Unicorn, allowing each user to run programs under the sophisticated Unix operating system.

At less than £15,000, Torch considers the system a bargain, as a similar set-up running on a minicomputer would cost at least £50,000.

At the heart of the system is the Unicorn, which contains a 20Mb hard disc and 68000 processor to run Unix (see September's issue). Each

Beeb has a Unix terminal ROM inside and the Beebs are connected to the Unicorn using the Econet local area network.

In addition to the Unix packages, the Torch system has an electronic mail facility which allows users to 'talk' to other Unix systems through modems over the phone lines.

'The beauty of our system,' said Torch's Colin Alton, 'lies in its total compatibility and transportability. We are using Unix System 3, which has all the latest enhancements and is supported by AT&T (who first developed Unix). Other manufacturers have gone

down the Xenix path, which doesn't enjoy AT&T's support.'

A smaller four-terminal network can be built for under £9000 and Torch is obviously looking to make a killing in a market which Colin Alton reckons is worth £100 million over the next year.

● Bleasdale Computers demonstrated BBC micros linked to minicomputer Unix systems at the recent Unix Systems 84 Exhibition in Cambridge.

More information from Francis House, Francis St, London SW1P 1DE.

## Home possibilities of Econet

ACORN's two founders, Chris Curry and Hermann Hauser, have bought a stake in Meridian, a company working on computer control of appliances around the home.

Meridian, which made a name for itself with 'state of the art' audio equipment, has developed a hi-fi system whose parts can be physically separate and 'intertaced' together with a simple digital link. This is made possible by the system's digital circuitry.

The company intends to use Acorn's Econet as the link medium. According to Merid-

ian's founder, Allen Boothroyd, the plans don't stop there: 'We have a research project working on the digital control of domestic appliances using Econet. It's a long way off but the possibilities are tremendous.'

It Allen Boothroyd's name seems familiar, he was responsible for the design of the BBC micro – his name is on the underside of each one. He left Acorn to found Meridian.

The two Acorn directors have each bought a 20 per cent private stake in Meridian and Acorn itself is not yet involved.

## Son of Imagine launches games

A NEW company called Voyager Software has risen from the ashes of Imagine with two games for the BBC micro. *Forbidden Fruit* and *Grabbit* cost £6.50 each on tape and are the first titles the company has produced for the Beeb.

Voyager Software was set up by Tim Best and Mark Butler, who left Imagine just before it went bankrupt.

Voyager is at Unit 31, Wirral Business Centre, Gorsey Lane, Dock Rd, Birkenhead, Wirral.

## Braille and voice system claims award

A BBC micro-based computer system for the blind has won a £500 award. Called the Work Station, the system uses a speech synthesiser and braille keyboard to offer word processing to the visually handicapped.

The David Scott Blackhall award is presented annually by the Radio 4 programme, *In Touch*, to the best invention to help the blind. This year David Young, Minister without Portfolio, handed over the cheque to Dr Tom Vincent, head of the Open University team responsible for developing the Work Station.

Dr Vincent described his system in the July 1983 issue of *AU*. It consists of a BBC micro; Perkins Braille—a typewriter which punches braille; printer; and a voice synthesiser. Using the equipment, a blind person can type in braille and hear the text read back by the synthesiser, either sentence-by-sentence or word-by-word.

At the presentation, the Work Station was seen in use by blind pupils from the Pen-y-Bont School in Bridgend, Glamorgan who have been testing the system.



David Young, Tom Vincent and blind schoolgirl Wendy Kerton

## India takes on Beeb assembly

by Geoff Nairn

A DEAL struck with the Indian Government could see BBC micros in 250,000 Indian schools by 1990. Moreover, the machines will be made in the Punjab by the state-owned company Semiconductor Complex Ltd.

Initially, model Bs will be assembled from Acorn kits, but full-scale manufacturing will follow. Even the 6502 processor chip, at the heart of every Beeb, will carry the 'Made in India' stamp: Semiconductor Complex will manufacture it under licence from the American Rockwell Corporation.

The only components which the Indians cannot supply are the custom-built ULA chips; they will continue to come from Acorn.

The commitment to have a BBC micro in 250,000 schools is part of the Indian Government's five year development plan and was influenced by the Queen's recent gift of 30 Beebs to Indian schools.

Acorn stands to do quite well out of the deal for, apart from producing the vital ULA chips, the company also gains a useful—and possibly cheaper—second source of 6502 chips.

A similar agreement has been reached in Mexico, where Harry Mazal—a large Mexican computer company—will produce BBC micros for the whole of South America.

The machine used will be the American version of the model B which has a different power supply and television picture standard. It will be further modified with a Spanish-language keyboard and operating system ROM. As with the Indian company, Harry Mazal will initially assemble the Beeb from a kit of parts, but a manufacturing facility will come later.

### Plans for China

Acorn's sights are now turned on China—a potentially huge market as a quarter of the world's population live there. Plans are afoot to produce the Beeb in Hong Kong exclusively for the Chinese market and in April of this year Acorn demonstrated the machine in Peking.

In both China and India, the consumer markets are comparatively small, but, as the Indian deal shows, the educational and industrial sectors are massive. And both countries are crying out for western technology.

## Double density discs from Opus

OPUS has released a double density disc interface for the BBC micro fitted with a 1.2 OS. The kit costs £129.95 and increases the storage capability of a normal 40 track disc from 100k to 180k.

Discs are formatted with 18 sectors per track with each sector capable of holding 256 bytes of data. Discs formatted with the standard 10 sectors per track may be used as usual with the DDOS.

By using the first track of the disc to store the file directories on the disc, eight directories (called volumes) of 31 files are possible. This increases the files per disc from the Acorn standard 31 to a maximum of 248 files.

The 16k DDOS EPROM includes a number of utilities: format and verify, tape to disc transfer, automatic 40/80 track selection and mass copying routines that allow automatic copying of files between 40 and 80 track discs.

## No-penalty DFS

MRM Software has grabbed back precious RAM for disc users with the introduction of its E00 DFS.

The DFS uses the standard 8271 disc controller chip and returns the 2.75k of RAM normally pinched by the DOS by resetting the value of PAGE back to &E00. This is done by providing 'on-board' assembly. The board is fitted in place of the standard DFS, with a link to another chip.

All commands are the same as the Acorn DFS except that only four files can be open at any one time (as opposed to the normal five), and the \*BUILD command is restricted to less than 100 characters per line.

The E00 DFS costs £24.95, with a £5 refund to anyone buying the E00 DFS and returning the old DFS EPROM. MRM can be contacted at 17 Cross Coates Road, Grimsby, South Humberside.

## Link to Crawler

AN INTERFACE enabling the Memocon Crawler (see Buggy review) to be programmed from the BBC micro is now available.

The price of the lead and cassette is £6.95 from Red Giant Software, 3a Oakcroft Close, Pinner, Middx.

## Buzby swoops to conquer

BRITISH Telecom has moved into software publishing with a range of games titles selling for just £2.50. Firebird is the name on the label and the first four BBC micro titles are: *Bird Strike*, *Gold Digger*, *Duck!* and *Acid Drops*—all arcade games.

As well as the low prices, the games will bear a screen shot on the cassette cover, rather than an artist's impression. Said BT's Richard Hooper: 'Firebird software is setting new standards in a market where complaints about prices and misrepresentation are frequent.'

These first programs will be followed by a series of 'premium range' titles which will be priced individually—presumably they will also cost more. The titles will be available from dealers.



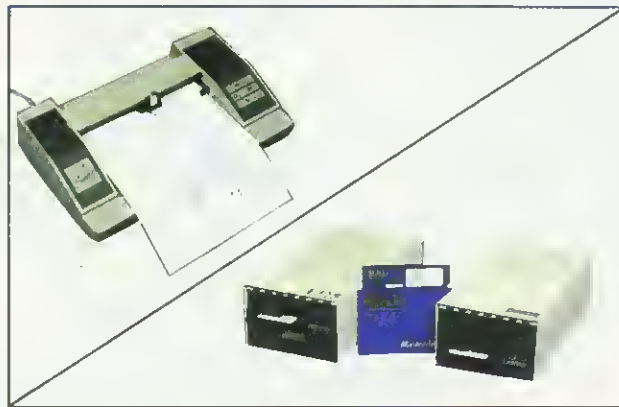

# A Free Training Course with Every Plotter or Disc Drive

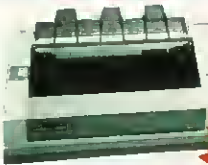

Our Sweet-P, high resolution graphics plotters come with free computer based demonstration and instruction programmes which not only show you what the plotter can do, but teaches you how it does it. Our high quality floppy disc drives are supplied with a utilities disc that includes not only the usual file handling and operating software, but a teaching programme for each utility as well. HAL makes it easy for you to upgrade and teaches you how to get the best from your system.

Plus a full line of BBC compatible products

100 CPS Matrix Printers HIGH QUALITY	Nashua Floppy Discs	Monitors-Monochrome
		
<b>£249</b>	Reference Description Price per 10	<b>£99</b>
<b>LOW LOW PRICE</b>	MD1 SSSD 21.30	
	MD1D SSDD 22.75	
	MD-2D DSDD 26.95	
	MD-1F SSDD <sup>96 TP1</sup> 30.05	
	MD-2F DSDD <sup>96 TP1</sup> 31.25	



HAL Computers Limited,  
Invincible Road, Farnborough,  
Hants. GU14 7QU  
Telephone: (0252) 517171

To HAL Computers, Invincible Road, Farnborough, Hants. GU14 7QU  
Please send me:

Quantity		Delivery & VAT	Total	
	Sweet-P Plotters plus support pack & software at	£575.00	£96.00	£671.00
	*200K double-sided disc drives at	£216.00	£42.20	£258.20
	KDCFT5001 Matrix printers at	£249.00	£47.15	£296.15
	TECO Monochrome monitors at	£99.00	£24.65	£123.65
	Nashua model ..... diskettes at £..... per box of 10 + 60p per box postage & VAT			

Free details on HAL's BBC Micro compatible products plus a commemorative Schneider Trophy winner's poster.  Please Tick <sup>\*Other capacities also available</sup>  
I enclose a cheque for £ \_\_\_\_\_ or debit my Access Account No: \_\_\_\_\_

Name \_\_\_\_\_ Address \_\_\_\_\_  
Tel. \_\_\_\_\_ Signature. \_\_\_\_\_

# PHLOOPY

## A 100k BBC-drive for £99 + VAT

We've done it! We've built a mass storage system for your BBC Micro with the power and convenience of a floppy disk drive, but at a fraction the price. Get to know PHLOOPY, the remarkable new 100k drive that costs only £99 plus VAT, and a further £26 plus VAT for the interface to your BBC, operating system and connecting cables.

### How PHLOOPY does it

PHLOOPY does not use disks to store data, but a 12-foot loop of professional-quality quarter-inch magnetic tape contained in a robust cartridge. The drive has only one moving part, the motor which drives the tape loop – hence the low price and high reliability. As the loop is driven round, each file of data it contains passes across the magnetic head which reads it or writes to it. Other people have produced tape loop micro-drives, but they've not been very reliable. They lacked PHLOOPY's special secret.

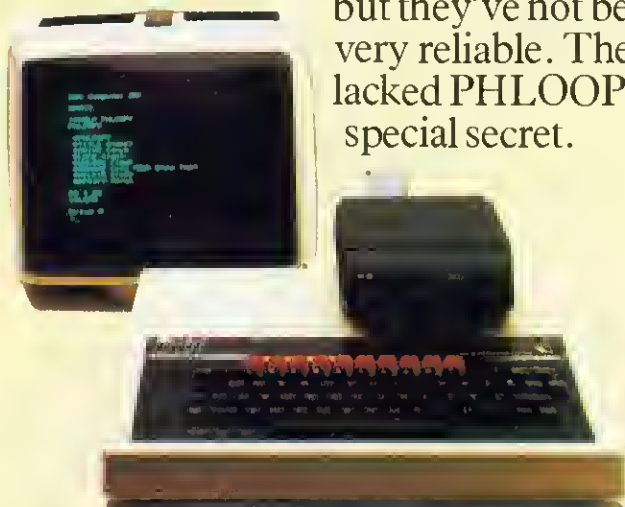

### PHLOOPY's special secret



The heart of the invention is a brilliantly designed "byte-wide" magnetic head, made by Phi Magnetronics who build multi-track heads for professional use. PHLOOPY's head records and reads nine tracks across the width of a quarter-inch tape. That means the tape loop can be much shorter, so the typical time to access a file is reduced to a mere 3 seconds. If you're used to waiting for a cassette tape to trundle programs into your BBC, you'll be amazed at PHLOOPY's performance.

### Getting it right every time

In addition, we've included a feature we know you will appreciate. PHLOOPY has full error detection and correction, so you can be certain you will get back what was originally written onto the tape.

### Talking to your PHLOOPY

PHLOOPY's own software, contained in ROM, responds to standard BBC filing system and Basic commands. Most programs written to run on disk or cassette should run on PHLOOPY without problem.

And because PHLOOPY contains its own intelligent microprocessor – a second computer which does most of the hard work – PHLOOPY puts very



# A

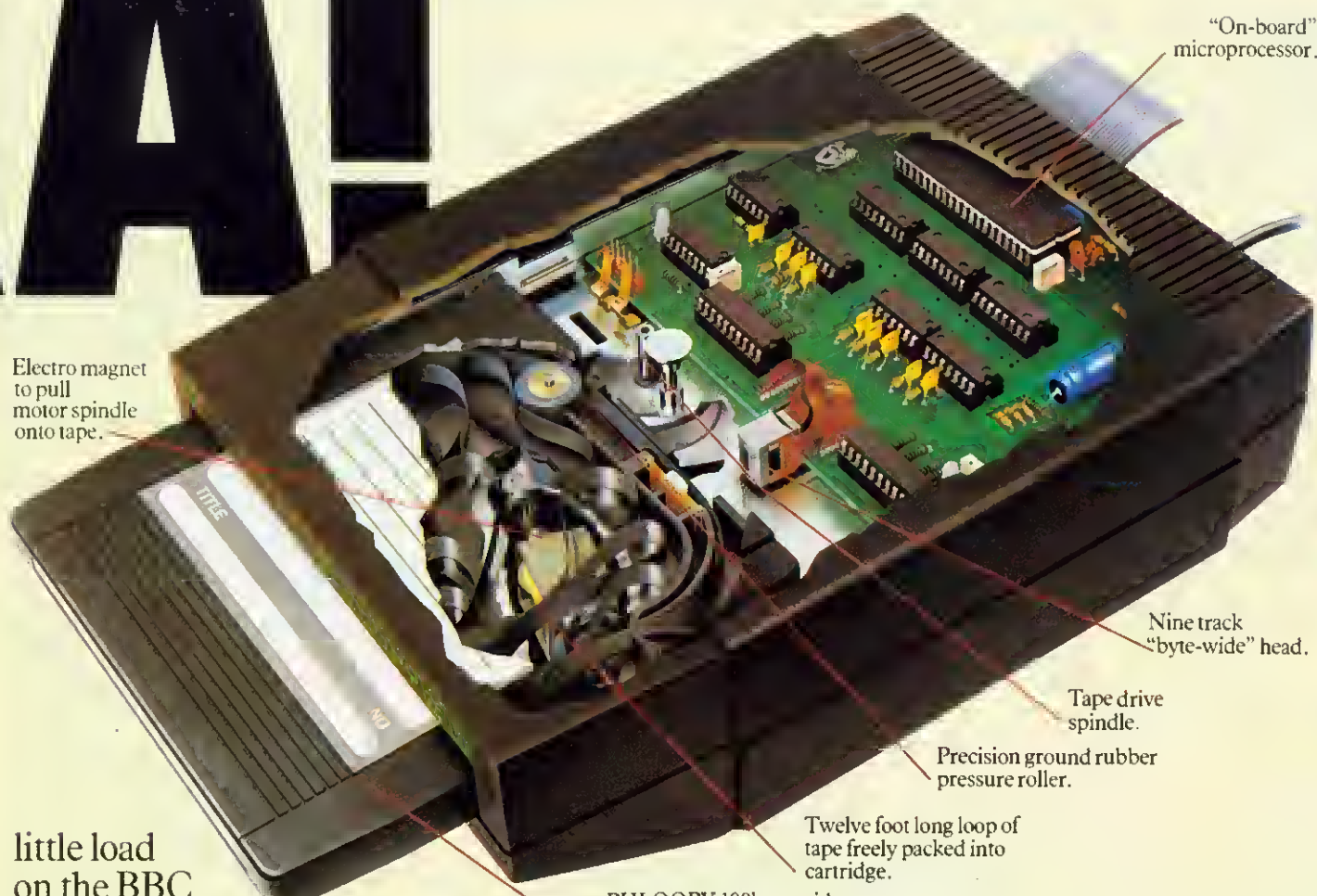

Electro magnet to pull motor spindle onto tape.

"On-board" microprocessor.

Nine track "byte-wide" head.

Tape drive spindle.

Precision ground rubber pressure roller.

Twelve foot long loop of tape freely packed into cartridge.

PHLOOPY 100k cartridge, shown not yet pushed fully home.

little load on the BBC and uses much less RAM than most disk systems.

## Installing PHLOOPY on your BBC

You'll be amazed how simple it is to install PHLOOPY. Just plug in the interface cut two resistors (clearly marked in the instructions) and the job is done. If you should have problems our engineers are waiting to help you.

## Making a PHLOOPY Library

PHLOOPY cartridges hold a full 100k of data or programs. Two of them come free with the drive and extra ones cost £3.75 each plus VAT. They are moulded of high impact polymers for protection and store easily on a bookshelf. Many programs will be available to purchase on PHLOOPY.



## Phi Mag Systems Ltd.

PO Box 21, Falmouth,  
Cornwall TR11 3TD.

Telephone: (0326) 76040.

### Order Form

- Please send me further details about the PHLOOPY 100k data storage system for the BBC Model B.
- Please send me \_\_\_\_\_ (qty) PHLOOPY starter pack(s) for my BBC Model B microcomputer, including PHLOOPY drive, BBC interface, leads, connections, operating system in firmware, manual, and two PHLOOPY 100k cartridges, at £147.75 each including VAT, postage and packing.  
Amount £ \_\_\_\_\_
- Please send me \_\_\_\_\_ (qty) packs of 5 PHLOOPY cartridges at £19.75 including VAT, postage and packing.  
Amount £ \_\_\_\_\_

I enclose a cheque/PO for £ \_\_\_\_\_ OR Please debit my Access card: Number: \_\_\_\_\_

Your order will be acknowledged within 10 days, giving a delivery date.

Name \_\_\_\_\_

Address \_\_\_\_\_

Town: \_\_\_\_\_ Post code \_\_\_\_\_

Send this coupon to:  
Phi Mag Systems Ltd, PO Box 21, Falmouth,  
Cornwall TR11 3TD. Telephone: Falmouth (0326) 76040.  
14 day money-back option.



MD 400  
£155.65  
+ VAT = £179

MD 800  
£312.17  
+ VAT = £359

MD 800P  
£373.04  
+ VAT = £425

## BBC Compatible Mitsubishi Slimline Disc Drives

These are high capacity, precision drives with dynamic clamping and very low power consumption. All drives are supplied with cables, a very comprehensive utility/format disc and a manual.

MD 400 — 400K (800K double density) 40/80 track switchable double sided single drive.

MD 800 — 800K (1600K double density) independently 40/80 track switchable double sided dual drive.

MD 800P — 800K (1600K double density) independently 40/80 track switchable double sided dual drive unit with built-in power supply and monitor stand.

Opening Hours: Mon-Fri 9am-6.30pm  
Sat 10am-5pm (ample parking)  
We accept telephone orders on Barclay  
and Access Cards.

Mail Order: Cheques or bankers draft  
payable to Akhter Instruments.  
Delivery free of charge (UK only)



AKHTER

COMPUTER GROUP

28/29 BURNT MILL, HARLOW, ESSEX CM20 2HU UK.  
TEL. HARLOW (0279) 443521 TELEX 818894 AKHTER G

Dealer Enquiries  
Welcome





## Book approval for AU authors

THE Book Marketing Council has stamped its seal of approval on three books written by *Acorn User* authors. The three titles form part of the 26 books and software chosen for the Council's 'Mastering the Micro' promotion—13 of them for the BBC or Electron.

Jim McGregor and Alan Watt wrote *Better Basic for the Electron* and *Graphics Programming on the BBC Micro*, both published by Corgi/Addison Wesley at £4.95. The other book chosen was Ian Birnbaum's *Assembly Language for the BBC Micro*, MacMillan, £8.95.

The campaign is aimed at bookshops who want a small but comprehensive range of books and, in the words of a Council spokeswoman, 'Each book was chosen as being outstanding in its field.'

## Teachers' show

EDUCOMP 84 will be held on October 26/27 at Dulwich College, South London. The exhibition concentrates on educational software and is being run by the Independent Schools Microelectronics Centre but it is open to all teachers.

Entry will be £1 per person on the door or £2 per school in advance. Applications with cheque to: Educomp 84, Dulwich College, London SE21.

## Who dares . . .

ANYONE buying Comsoft's latest game, *SAS Commander*, has a chance to win £50.

*SAS Commander* is an arcade-style game for the BBC micro and Electron in which you have to kill terrorists, storm buildings and rescue hostages. It costs £4.95 on tape from Comsoft, 7 Roman Drive, Leeds, West Yorkshire LS8 2DR.

**Printer error** *Taxan's KP810 centronics printer costs £299 and not £229 as stated in the October issue.*

# Cabinet role for 1984 game

TOP people read *Acorn User*. We received a telephone call from the Cabinet Office, who wanted to get hold of a copy of 1984. Incentive Software's game of government management. The program was reviewed in the September issue of the magazine by Geoff Nairn.

Fears that the Government intended to run the economy with a BBC micro and a £6

computer game were, however, unfounded. Keir Hopley, who works within the Cabinet Office's Training Division said: 'We run training courses for the whole Civil Service. Playing 1984 could become part of these courses, albeit light-hearted. The Division has just got a BBC micro but at the moment it's used mainly for statistics and the like.'

Incentive's latest game is

Millionaire, a simulation of running a software company. Versions are available for the BBC B and the Electron at £6.50. It includes screen pictures of your current residence, which increases in size as profits grow.

Cabinet ministers, civil servants or anyone else can contact Incentive Software at 54 London St, Reading RG1 4SQ, tel. (0734) 591678.

# Micros for doctors in trial by DHSS

by Bill Penfold

Acorn hopes to get a thorough medical examination—to discover whether its micros are just what the doctor ordered.

The Beeb looks set to be one of the machines tested by the Department of Health and Social Security in its search for a suitable computer system for your doctor's surgery.

And with its new £2,000 Doctors Package now ready, Acorn's hopes are clearly high that a departmental diagnosis will pass it A1 fit.

Invitations to around 40 computer suppliers throughout the country have gone out from the DHSS offering them a chance to take part.

The aim then is to whittle the choice down to 20 different systems and within a year come up with some down-to-earth comparisons.

For such a lucrative market of 25,000 GPs, there are already lots of competing systems on the market . . . and that's the problem. As Junior Health Minister John Patten explained when he announced the investigation, the DHSS wants to know 'which does the job best.'

The DHSS has dreamt up its own GP practice with some 10,000 surgeries on the register and intends to put each machine rigorously through its paces.

An outside firm of consultants has been hired to carry out the tests, and several doctors are taking part to think up the professional requirements that will really test the capabilities of the machines.

Mr Patten explained that the intention is not to come up with a 'best buy' for the family

A COMPUTER package of hardware and software has been designed to support your local doctor.

For £1999, Acorn is offering a BBC micro plus printer, monitor and disc drives with software to administer record keeping and repeat prescriptions.

The programs were written by two Bristol GPs and form the first part of a suite.

So next time you pop in for your pills, check whether it's repeat prescriptions they're running or Snap-per.



doctor or to endorse any particular system. Instead the idea is to give GPs objective information about the

systems currently available.

Meanwhile are the boys in Cambridge devising a bench test for bedside manners?

## Prestel link for GP system

PRESTEL's medical news and information can now be accessed by the Abies GP computer system, based on a BBC micro.

Pages are put on Prestel by Meditel, which is offering free communications software to doctors who buy a modem for their Abies system. This gives access to the Meditel pages

and other viewdata networks such as Micronet.

In addition, the software will work with non-viewdata databases, such as the specialist Medline on-line information service, or the Telecom Gold electronic mail network.

Meditel is at 309 High St, West Bromwich, West Midlands, B70 8ND.

A bright new feature page to fill you in on showbiz gossip and upcoming events

## Bird of Prey venture takes a dive

THE project to market a software game for the Beeb to complement the BBC TV serial *Bird of Prey 2* has been cancelled, with accusations of 'gross inefficiency' on the part of the BBC.

The Ipswich Computer Centre was commissioned by the BBC to write an adventure game that would use characters based on the TV programme's graphics sequences. Duncan Spencer of ICC says: 'The game was a full graphics adventure with multiple overlays. To be honest, it lends itself more to a Spectrum or Commodore 64 but the BBC obviously wanted it for the BBC micro.'

'After we'd worked on it for 4½ months they still hadn't signed the contract and we decided to pull out. I put it down to a lack of communication and gross inefficiency on their part.'

BBC Enterprises, which would have marketed the game, were not prepared to comment on the contractual problems but Bob Cosford, who designed the computer graphics for the series, says: 'It's just one of those things.'

## You and Who

AUNTIE Beeb has had better luck on the software front with a new *Doctor Who* adventure game. The doctor has forsaken his traditional enemies, the Daleks, to do battle with warlords and bandits. The tape, *Doctor Who and the Warlords*, is produced by BBC Publications for the Beeb and Electron and will be available in the new year for £7.95.

You play the doctor's com-

panion marooned on the planet Quantain in the distant future. Together you must defeat the evil warlords in this pure-text adventure. The program was written by AU contributor Peter Voke.

The original Dr Who software tape, which consisted of several poor arcade-type games programs, has been quietly dropped by BBC Publications.

## Digital romance

MOVING from the small to the big screen, *Electric Dreams* opens this month. The film explores the familiar theme of the eternal triangle, but with the unlikely twist that one of the protagonists is a computer. Miles buys himself a micro and sets it to work composing love songs for Madeleine—the girl musician next door. She thinks Miles is writing the songs and falls for him; meanwhile the computer gets jealous and...

With a soundtrack by Boy George and with Virgin Films producing the film, various commercial spin-offs are planned—though no computer game.

## BLUNDERBOX

IN the June issue on yellow page VII, line 140 of Paul Beverley's listing 2 should read:

```
140 IF (?M% AND T%) > 0 THEN VDU255 ELSE VDU32
```

IN the July issue on yellow page VI, lines 310 and 640 of Mark Clayden's program should read:

```
310 LDX #8
640 LDA #8
```

To save the object code type: \*SAVE INSPECT 8D0 9FF

IN the September issue the Sprite design program on yellow pages VIII and IX is too long to run as printed. The spaces after each line number should be deleted. The instructions for running the *Design* contain two mistakes: line 950 is printed twice and each time '1%' should, of course, read '1%'.

READERS who bought the October listings cassette should note that line 620 of Alan Crabb's program contains an error. The printed listing is correct.

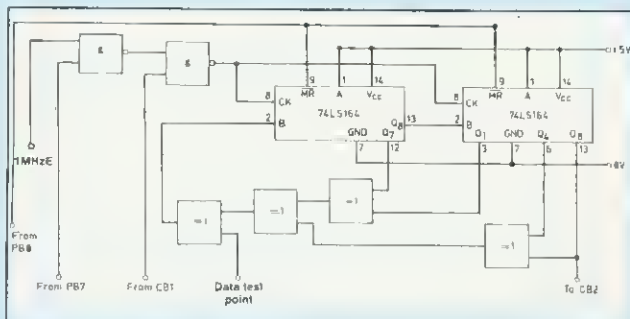

Paul Beverley's figure 1 last month contained a wiring error not unconnected with PB0. Here's the correct version.

## On television

*Micro Live*, BBC2, November 9, 6pm. Third programme in monthly series that features BBC micro heavily. Lesley Judd tries every which way to corrupt a disc, there's a lively discussion on telecoms and a live Bulletin Board session. Computer programs from the series are available as tele-software on Ceefax.

*First Class*, BBC Scotland, Wednesdays 5.25pm. Quiz game with teams drawn from schools. BBC micros used for setting questions, keeping score and captions. Winning school gets a Model B with disc drive.

## On radio

*Chip Shop*, BBC Radio 4, 4.15pm Saturdays (repeated on VHF at 11pm Tuesdays). Second series featuring hardware and software reviews, letters spot, news reports. Barry Norman presents.

*Radio 1 Chip Shop*, BBC Radio 1, 7.33am Saturdays. Software broadcast on Saturdays and Sundays at 5.55am. 'Pop' version of above with Top Ten



Lesley Judd goes down the Tube

software charts.

*Abacus*, BBC Radio Leeds, alternate Tuesdays 6.45pm.

*The Computer Programme*, Radio Sussex, 3.45pm Sundays.

*Action Station*, BBC Radio Kent, 11.05am Saturdays.

*Datarama*, Radio West, 6.15pm Thursdays. (Also 7pm Sundays on Wiltshire Radio and Devon Air.)

*Chips*, Pennine Radio, 7pm Mondays.

## Addresses and phone numbers

Acorn Customer Services 0223-210111

Retail Control Systems, Enterprise House, Central Way, North Feltham Trading Estate, Feltham, Middlesex, 01-844 1333

BBC Broadcast Support Services, 2 Cater Road, Bristol BS13 7TW. Technical Helpline, 01-993 0366.

Parfitt Electronics, 6 View Street, London N6, 01-348 1973 (See plotter review, September).

Wordsmith, 19 West End Street, Somerset, 0458-45359 (See news item, page 9, August).

Data Technologies Ltd, Century House, Market Street, Swavesey, Cambridge.

Unilab, Clarendon Road, Blackburn BB1 9TA. (See weather article box, page 31, August).

Notting Dale Information Technology Consultancy Unit, 189 Freston Road, London W10.

Rose-Morris, 32/34 Gordon House Road, London NW5 1NE (See news item, page 10, September).



Dr Who, text-only hero



# FOUR AFFORDABLE CHRISTMAS PRESENTS FROM DRG... AND WHERE TO GET THEM.

SEE US ON STAND 949 AT COMPEC

If you want a really outstanding deal on a graphics printer, get along to your local DRG dealer or contact us direct today.

Because right now our dealers can show you four Seikosha dot-matrix, centronics parallel printers whose speed, features, ruggedness and affordability are quite exceptional.

They include the amazing GP700A: the first full-colour matrix printer ever offered at under £350.

They're compatible with most makes of micro - including the BBC and the Spectrum.

And with 34 dealers nationwide, you shouldn't have to go too far to find them.

If you're not near a dealer you can order direct from us - just contact Pat Kelly on 0934 416392.

**SEIKOSHIA GP500A**  
Takes pin-fed paper up to 10" wide, 50 cps print speed. **£175.00**

#### SEIKOSHIA DEALERS:

##### ENGLAND

- BEDFORDSHIRE** Bedford: Bedford Computers. (0234) 215015.
- BUCKINGHAMSHIRE** High Wycombe: Kingsley Computers. (0494) 449749.
- CHESHIRE** Frodsham: Northern Computers. (025) 35110.
- CUMBRIA** Carlisle: The Computer Shop (Carlisle) Ltd. (0228) 27710.
- DEVON** Exeter: Devon Computers Ltd. (0392) 218401.
- DORSET** Poole: Densham Computers Ltd. (0202) 737493.

- DURHAM** Darlington: Darlington Computer Shop. (0325) 487475.
- ESSEX** Harlow: Akter Instruments. (0279) 443521.

- GLOUCESTERSHIRE** Cheltenham: The Screen Scene. (0242) 528979.
- HAMPSHIRE** Portsmouth: Advanced Digital Services. (0705) 823825.
- HERTFORDSHIRE** Watford: Computer Plus. (0923) 33927.

- HUMBERSIDE** Hull: The Computer Centre (Humberside) Ltd. (0482) 20297.
- LANCASHIRE** Bury: IMO Computer Centre. (0282) 574115/4299.
- Lancaster:** Castle Computers. (0524) 61133.

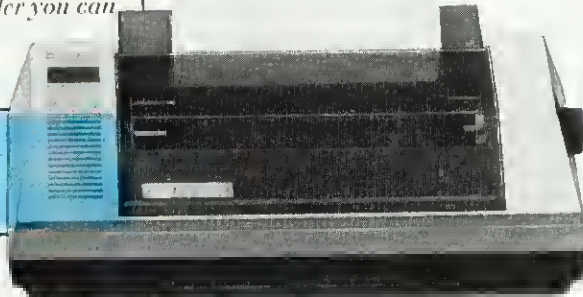

- LONDON W.1:** Specialist Computer Centre Ltd. 01-935 4150.
- Eltham: The Adventuril Technology Centre. 01-859 7696.

- LINCOLNSHIRE** Grantham: Oakleaf Computers. (0476) 76994.
- MANCHESTER** Saddle Electronics Services Ltd. 061-834 4233.

- MERSEYSIDE** Liverpool: Specialist Computer Centre Ltd. 051-236 3499.
- NORFOLK** Norwich: Saddle Bonclain. (0603) 617083.

- NOTTINGHAMSHIRE** Nottingham: Computer Market. (0602) 586454.
- SALOP** Telford: Computer Village. (0952) 506771.

- STAFFORDSHIRE** Stoke-on-Trent: Computer Cabin. (0782) 636911.
- SURREY** Croydon: Visionstore Ltd. 01-681 7539.

- Kingston-upon-Thames: Visionstore Ltd. 01-546 8974.

**SEIKOSHIA GP550A**  
Multi-mode printing (including correspondence-quality) at up to 50 cps. Takes pin-fed or friction-fed paper up to 10" wide. **£229.95**

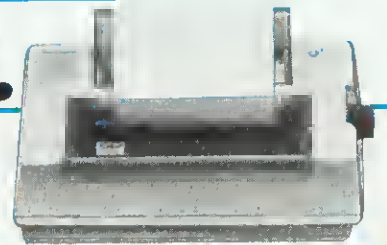

**SEIKOSHIA GP50A**  
Takes paper up to 5" wide, 40 cps print speed. A separate version, the GP50S is available for the Spectrum. **£99.95**

- SUSSEX** Worthing: Worthing Computer Centre. (0903) 210861.
- TYNE AND WEAR** Gateshead: H.C.C.S. Associates Ltd. (0632) 821924.

- WEST MIDLANDS** Birmingham: Specialist Computer Centre Ltd. 021-643 4743.
- Coventry: Coventry Merus. (0203) 58942.

- WEST YORKSHIRE** Bradford: Eltec Computers. (0274) 722512.
- Leeds: Microcell. (0532) 449722.
- WILTSHIRE** Trowbridge: Trowbridge Computer Shack. (02214) 57299.

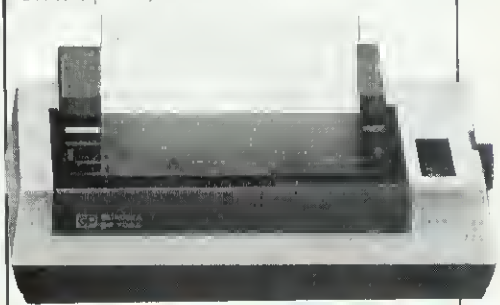

- SCOTLAND** Glasgow: Exchange Computers Ltd. 041-424 4242.

- WALES** Clwyd: Abergel: Abergel Computer Centre. (0745) 826234.



**SEIKOSHIA GP700A**  
Gives excellent colour printout in 7 colours and 30 shades in one pass, on pin or friction-fed paper up to 10" wide. Prints text at up to 50 cps. **£349.95**

Please send me more information and an order form for:  
GP50A  50S  500A  550A  700A   
Name \_\_\_\_\_  
Address \_\_\_\_\_

Postcode \_\_\_\_\_  

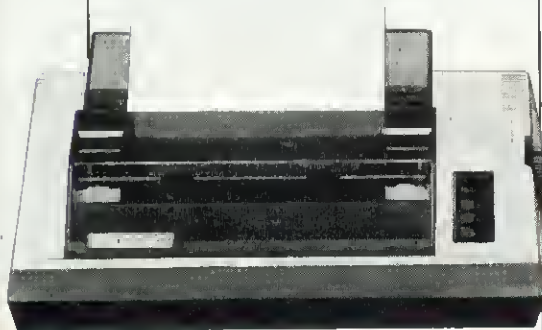



# SEIKOSHIA DRG

DRG Business Systems, Dealer Division, 13/14 Lynx Crescent, Winterstoke Rd, Weston-Super-Mare BS24 9DN. Tel: 0934 416392. Telex: 444761.

# ACORN·USER

**gives readers  
the chance to**

**join the**

**MICRO REPAIR CLUB**

**at a major discount**

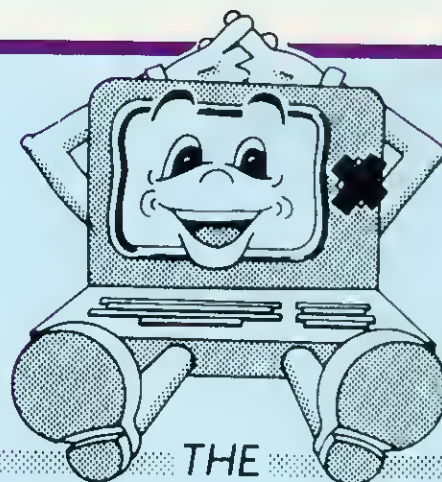

THE  
**M I C R O  
R E P A I R**  
CLUB

	<u>Normal price</u>	<u>AU price</u>
<b>1 year</b>	£24.95	<b>£19.95</b>
<b>2 years</b>	£35.95	<b>£27.95</b>
<b>3 years</b>	£46.95	<b>£39.95</b>
<b>4 years</b>	£57.95	<b>£49.95</b>

All these prices include VAT at 15%

Cut out the coupon below now and send it to:

**ACORN USER SPECIAL OFFER, Micro Repair Club Limited, Swan Court,  
Mansel Road, Wimbledon, London SW19 4AA**

THE Micro Repair Club has been set up to ensure that users of Acorn computers make the most of their investment. The Club's Initial masterplan is to offer a repair-guarantee package which users can subscribe to when the six-month warranty on a BBC micro or Electron runs out.

The package can run for as short as one year after the warranty expires or as long as four years. New purchasers of micros, of course, have the option to join the Club at the time of purchase. And for the membership fee, the Club guarantees that should anything break down in the computer it will be repaired at absolutely no cost to the user.

The Club has the backing of one of the world's leading Insurance companies and has also negotiated with Computeraid Services, part of the Thorn EMI information technology division, to do the repair work. This means users can go to a local Computeraid Services workshop and having it fixed locally.

The Micro Repair Club is keen to attract schools and will arrange discounts for education establishments.

## ACORN · USER

I would like to join the MICRO REPAIR CLUB for \_\_\_\_\_ years and look forward to receiving my full membership pack.

- I enclose a cheque for:
- £19.95  1 year's membership
  - £29.95  2 years
  - £39.95  3 years
  - £49.95  4 years

\*Please tick relevant box  
Made payable to Micro Repair Club Limited

Please debit my Visa/Access card no: \_\_\_\_\_

Name \_\_\_\_\_

Address \_\_\_\_\_

\_\_\_\_\_

\_\_\_\_\_

\_\_\_\_\_ Post code \_\_\_\_\_

I own a \_\_\_\_\_ home computer and it is in working order.



# TECHNOMATIC

BBC Computer & Econet Referral Centre  
01-208 1177

All prices exclude VAT & carriage. Please add VAT and carriage: (a) £8; (b) £2.50; (c) £1.50; (d) £1

NOVEMBER '85

## ACORN COMPUTER SYSTEMS

BBC Model B Special Offer.....	£320 (a)
BBC Model B + Starter Pack.....	£348 (a)
BBC Model B + DFS.....	£409 (a)
BBC Model B + Econet.....	£389 (a)
BBC Model B + Econet + DFS.....	£450 (a)
BBC Dust Cover .....	£4 (d)
Pair of Joysticks.....	£14.50 (d)

## UPGRADE KITS

A to B.....	£65 (d)	Installation.....	£20
ACORN DFS Kit.....	£95 (d)	Installation.....	£15
Econet Kit .....	£55 (d)	Installation.....	£25
Speech Kit.....	£47 (d)	Installation.....	£15

## ECONET ACCESSORIES

Terminator (Two reqd per installation).....	£31 (c)	File Server Level II.....	£216 (c)
Clock with psu.....	£35 (c)	10 Station Lead Set.....	£26 (c)
Printer Server Rom.....	£42 (c)	Extra Econet cable.....	£1.50/m (d)
File Server Level I.....	£86 (c)	Econet User Guide.....	£10 (d)

## ACORN BITSTICK

The Acorn adaptation of the renowned 'Bitstick' graphic CAD package — the "expensive joystick" that lets you exploit the powerful capability of the BBC micro to the full. The joystick is of a robust design which achieves remarkable precision without tiddliness. Total control is available from the joystick using the on-screen menu. It can draw freehand or follow lines of shapes chosen with high accuracy, and colours can be chosen from a palette displayed on the screen. Any part of a drawing can be magnified, by a virtually unlimited number of times, and upto 48 drawings can be saved on a single disc. The discs use a visual library system for easy identification. In spite of its powerful features, the Bitstick is extremely friendly and easy to use, due to menus being displayed on the edge of the screens. £328.00 (a) FX80 dump routine for the bitstick available.

## TORCH UNICORN PRODUCTS

The TORCH Unicorn system has been in the field for over two years and is now a proven Z80 system for the BBC. It gives you the potential to expand which no other system can currently offer. You can expand a single system with a 20Mb Hard Disc, have the processing power of a 32bit 68000 cpu with 256K ram and a UNIX operating system, or set up a network of upto 254 machines. All these capabilities are available NOW.

The TORCH UNICOMM Modem package is now available for the UNICORN range providing the benefits of the extensive TORCH communication packages. It offers three options: **Uniview** for viewdata services, **Uniterm** for terminal emulation, and **Unimail** which allows messages and files to be exchanged between Unimail/Torchmail/Torchmail-Plus users. Access to files can be controlled by heirarchical passwords which determine the extent of access.

<b>Z80 Card ZEP100 with PERFECT Software Packages + Z80 Basic.....</b>	<b>£299 (a)</b>
<b>Z80 Disc Pack ZDP240 with software as above.....</b>	<b>£699 (a)</b>
<b>20Mb Hard Disc + 1 x 400K Floppy Drive.....</b>	<b>£1,950 (a)</b>
<b>UNICOMM Communications Packaga + modem.....</b>	<b>£161 (a)</b>
<b>Unicorn 68000, Unix OS/Z80B/256K, 20MB Hard Disc, 400K Floppy.....</b>	<b>£2995 (a)</b>



A BBC Family System

## ACORN Z80 2nd Processor

This processor converts your BBC into a complete business micro with all the computing power a professional would need. The system is CP/M based and is supplied with a very extensive software package. The package includes three office productivity programs, (memoplan, fileplan and graphplan), Systems generator program, three programming languages plus the ACCOUNTANT business program. Software is accompanied by extensive manuals that not only get you started but also answers your whys and hows.

All for only £399 (a) (incl VAT)

## ACORN 6502 2nd Processor

This processor is designed for the serious computer user who wants to get even more out of his computer. This processor provides increased memory — allowing up to 44K for Basic programs and up to 60K for assembly language programs, regardless of screen mode in use. (ideal for VIEW). An increase in speed means that programs run up to 50% faster. The second processor/BBC combination offer computing power comparable to systems costing twice as much. £175 (a)

## TORCH GRADUATE SYSTEMS

This latest addition to the range of BBC upgrades will upgrade your BBC to a powerful 16bit business computer and make it disc & hardware compatible with the IBM PC. Its MS/DOS is customised to IBM compatibility allowing access to the massive range of IBM compatible software, programming aids, compilers and languages. It uses A8088 CPU at 5MHz, 128K or 256K ram, single or dual drive, software compatibility allows LOTUS 1-2-3, and other popular IBM PC business programs to run. Connection of the Graduate is simple, with just a connection to the 1Mhz Bus. The disc drives can be used in both BBC and IBM PC mode without needing an Acorn Disc Interface in the computer. The top-of-the-market GRADUATE Model G800/2 will come complete with the superb Xchange suite of programs, comprising a full feature word processor, a financial planner, a database, and a business graphics package. Although these programs are in modular form, they can be linked together to form an integrated software system that allows you to switch instantly between various tasks and to exchange the information between programs. G800/2 £945 (a) Full spec & prices on application.

# PRINTERS

ALL PRINTERS HAVE A 12 MONTH GUARANTEE

## DOT MATRIX

This month we are adding the new **KAGA** printers to our range of quality dot matrix printers. These printers, with their Epson compatible control codes are available in 80 col & extra wide 156 col versions. Features include NEAR LETTER QUALITY print using a 23 x 18 matrix, Dot addressable graphics in 8, 9 & 16 pin modes. Text modes include Normal, Italic, Enlarged, Condensed, Super & Sub script, Proportional spacing. Defined characters can be placed in ROM to give personalised print. An integral 3K buffer, both friction & adjustable tractor feeds with built in paper roll holder, etc. etc. makes these superb 'value for money' printers unique.

**KP810 (80 cols) £249 (a)** (with free BBC cable)

**KP910 (156 cols) £375 (a)** (with free BBC cable)

We continue to supply the ever popular, definitive **EPSON** range. This 'industry standard' range provide reliability and quality 'second to none'. The budget **RX80FT** Dot Matrix, has 100cps and all standard printing and graphic functions as well as friction and tractor feed. The deluxe **FX80** has all the above, as well as a 160cps, buffer, programmable characters etc. For wider paper use — up to 15" — the **RX/FX100** are ideal.

**RX80T £215 (a)**

**RX80FT £230 (a)**

**FX80 £318 (a)**

**RX100 £345 (a)**

**FX100 £450 (a)**

## DAISY WHEEL

The Brother HR15 daisy wheel offers features normally found in printers costing far more. Features include: 14 cps, 3K buffer, proportional spacing, underlining, bold and shadow printing, two colour printing, super & subscript and many other features. Centronics parallel interface is fitted as standard.

**BROTHER HR15 £349 (a)** (With free BBC Cable).

The **JUKI 6100** daisywheel with 20 cps, 2K buffer, and switchable 10, 12, 15 cpi + proportional printing. A linear motor ensures optimum reliability.

**JUKI 6100 £345 (a)**

## GRAPHICS PLOTTER/WORK STATION

Equally at home in the artists studio, hobbyists workshop, science lab or a classroom, this system has something to offer for everyone. The 3 colour graphics plotter provides both precision and versatility. The carriage can be moved with an accuracy of 0.025cm over an A4 area — the plotter being able to accept paper and far thicker materials at sizes of up to A3. The basic plotter carries 3 colour pens each of which is software selectable. Additional accessories greatly enhance the versatility of the unit without loosing the accuracy. The servo controlled drill/router, and scribe can be used on various materials. A unique Opto Sensor (using a Hewlett Packard device) turns the plotter into a high-res scanning digitiser to read & store whole diagrams and photographs.

**Workstation Complete £490 (a);**

**Basic Plotter £270 (a).**

**Software on Disc £3.00; Opto Sensor £72.**

**Power Supply: PS12V £42; PS24V £78.**

**Drill/Router Attachment £79; Scriber £7.**

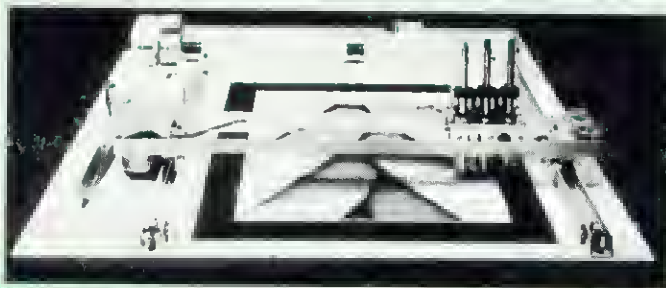

# TECHNOMATIC

All prices exclude VAT

## PRINTER ACCESSORIES

### EPSON

Paper Roll Holder £17 (d) FX80 Tractor Attachment £37 (c)

Interfaces: 8143 RS232 £28(c); 8148 RS232 + 2K £57(c);

8132 Apple II £60(c); 8165 IEEE + Cable £65(c).

Serial & Parallel Interfaces with larger buffers available.

Ribbons: RX/FX/MX80 £5.00(d); RX/FX/MX 100 £10(d).

FX80 Dustcover £4.50(d)

**KAGA TAXAN:** RS 232 Interface + 2K buffer £85(c); Ribbon KP810/910 £6(d)

**JUKI:** RS232 Interface £65(c); Spare Daisy Wheel £14(d). Ribbon £2.50(d)

Sheet Feeder £199(a); Tractor Feed Attachment £99(a)

**BROTHER HR15:** Sheet Feeder £199(a); Ribbons Carbon or Nylon £4.50(a)

**BBC Printer Lead:** Parallel (42") £7(d); Serial £7(d)

Printer Leads can be supplied to any other length.

**Plain Fanfold Paper with extra fine performance (Clean Edge):**

2000 9.5" x 11" £13(b) 2000 14.5" x 11" £18.50(b)

Labels: 2-3/4" x 1.7/16" In quantities of 1000

Single Row: £5.25/1000 (d); Triple Row: £5.00/1000 (d)

## PRINTER SHARER BUFFER

A unique deluxe printer buffer/sharer providing a simple way to upgrade your computer system by allowing greater utilisation of existing equipment by reducing the waiting time for printing documents. Data from three computers can be loaded into the buffer which will continue accepting data until its 64K storage is full. The buffer will automatically switch from one computer to the next as soon as that computer has dumped all its data. The computer is then available for other uses. This is a compact unit measuring 7cm x 17cm x 24cm. A LED bargraph indicates the memory usage, with LED indication showing from which computer the data is being fed from. There is simple push button control for PAUSE, RESET, and COPY facilities. The copy facility is ideal for continually printing copies of a document without 'tying up' the computer. Built in mains psu.  
**SP110 BUFFER/SHARER**  
incl one cable set £275(b)

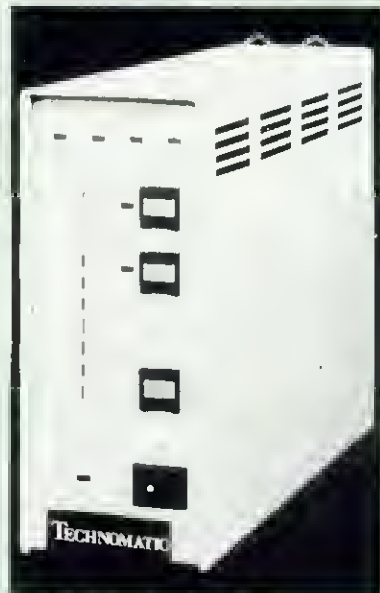

## PRINTER SHARER

Three Computers to one printer (parallel).....£65(b)

Six Computers to One Printer (parallel).....£129(b)

Cables for Three Way Sharer.....£25(c)

Cables for Six Way Sharer.....£38(c)

## COMPUTER SHARER

Two Printers to one Computer.....£19(c)

## GRAFPAD

A low cost graphic tablet offering the performance & durability required by industrial and educational users. It is compact, accurate & reliable; working area 240x192mm + menu area. Comes complete with a CAD package. £120 (b).

## VIEW PRINTER DRIVER FOR FX80/KP810

This driver allows the use of all FX80s fonts to be used in text written using the VIEW rom. If user defined characters are held in the printer buffer they can also be used within the text. Manual and Disc includes examples of document layout and user definable characters. Supplied on 40 or 80 Track disc.....£7(d)

Printer Drivers for NEC PC8023, Brother HR15 and Juki 6100...£7(d)



**01-208 1177**

Please add VAT and carriage: (a) £8; (b) £2.50; (c) £1.50; (d) £1.  
Carriage (a) sent by Datapost.

## MONITORS

A choice of high quality RGB and Monochrome monitors are available. The British made MICROVITEC Std/Med/Hi Resolution 14" monitors offer a consistent reliable performance. Their resolution ranges from 452 pixels horizontal on the std res monitor to 895 pixels on the Hi res monitor. Std and Med res monitors are also available with RGB/PAL/Audio inputs. Dual input versions also available.

1431 Std. Res. RGB £175 (a); 1431AP RGB/PAL/AUDIO £225 (a);  
1415 Med. Res. RGB £255(a);  
1451 AP Med. Res RGB/PAL/AUDIO £280(a);  
1441 Hi-res RGB £420(a); 2031 20" Std Res RGB £260(a).

The KAGA Vision III 12" RGB monitor offers a superb performance but in a smaller cabinet with a genuine etched anti-glare screen. £358(a).

The Japanese made SANYO and the KAGA monochrome monitors provide an ideal answer for an 80 character hi-clarity display. A futuristic swivel base plinth with integral clock is available for the Kaga monochrome monitors as an optional extra.



KX1201G with stand

SANYO DM 8112CX Hi Res Green Screen.....£99 (a)  
KAGA KX1201G 20MHz Hi Res Green with etched screen....£106(a)  
KATA KX1201A 20MHz Hi Res Amber with etched screen .....£114(a)  
Swivel Base for Kaga Green (fitted with digital clock).....£22.50 (c)  
Note: All monitors are supplied with free BBC leads.  
BBC Leads: Kaga RGB £5; Microvitec £3.50; Monochrome £3.50 (d)

## VIDEO DIGITISER

A high quality yet cost-effective unit offering uses for the scientific, educational and home user. Feeding in a video signal (this can be from a camera, VCR etc) will output to the BBC a high quality picture, with eight different grey levels. This picture can be stored on disc, manipulated or dumped to a printer. The friendly, yet sophisticated menu driven software comes complete with an Epson printer dump. £213(a).

## SANYO DR101 DATA RECORDER

A high quality tape recorder with circuitry specifically designed for recording. Having switch selectable normal/data positions, as well as cue/review and a tape counter, it makes this recorder an ideal choice for anyone wanting a reliable tape storage device. £30 (c). Including free lead. Extra leads £3.00 (d) Cassette £3.00 (d).

## RH LIGHTPEN

A superior quality lightpen, features including: adjustable sensitivity, LED output to show data transmission, microswitch tip. Full software backup. £39 (c). The 'Lightpen Colour Graphic Software' pack helps you to draw line drawings as well as more complex drawings. Colour fill, point plotting, line, square, triangle, circle XY rulers are all available with rubber banding facility. £7 cassette, £9 Disc. The 'Artfun' pack provides full interaction between pen and screen. Allows your initial design to be shrunk into a high res format, and these images can be stored for subsequent use. £7 cassette. The 'Word Master' encourages the use of correct grammar and is an excellent aid. £7 on cassette. The 'Ed Master' uses a quiz format, and up to 160 questions may be programmed by the teacher. £7 on cassette (d).

## RAINBOW LIGHTPEN

Allow your child's creativity to run wild in colour, and develop their artistic potential — allows colour displays to be instantly drawn. Superb software includes facilities of saving and loading screens as well as an Epson screendump. £10.35 (c).

## DISC DRIVES

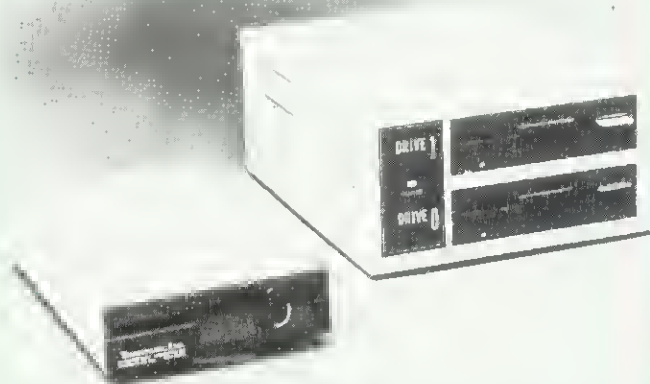

Technomatic Disc Drives offer the best value for money. They come fitted with high quality slimline Japanese mechanisms & represent the state of art in disc drive technology. They are built to highest standards in design and production, and are all tested to their full performance capability before packaging. All drives are available with or without integral power supply. Dual Drives with PSU are supplied with generously rated integral switched mode power supplies. All 80 track TEAC drives are fitted with 40/80 Track switching at no extra charge to the user. Attractively designed steel casings are painted in hard wearing BBC matching beige paint. All drives can operate in single or double density modes. Drives are supplied complete with necessary cables, manual and formatting disc and are ready to be connected to the computer.

### Single Drives

100K 40T SS:TEAC £100(a); TEC with psu £135(a)

200K 80T SS:40/80T TEAC £155(a) TEC with psu £165(a)

400K 80T DS:40/80T TEAC £185(a) Mitsubishi with psu £195(a)

3" 100K HITACHI Drive £115(a)

### Dual Drives

2 x 100K 40T SS with psu: TEAC £300(a) TEC without psu £225(a)

2 x 200K 80T SS with psu 40/80T TEAC £375(a) TEC without psu £275(a)

2 x 400K 80T DS with psu 40/80T TEAC £400(a)

Mitsubishi without psu £325(a)

2 x 400K 80T DS with psu Mitsubishi £400(a).

## SCOTCH 3M DISCS

Authorised Distributor  
Data Recording Products

3M

This month we are offering these high performance discs at a bumper bargain price — not to be repeated again. The current offer will be valid for orders received until 30th October only. These discs are manufactured with advanced manufacturing techniques that have enabled 3M to set the industry standard. Their quality is such that their error free performance is guaranteed for life.

Discs in pack of 10 (c): 40T SSDD £12.50(c); 40T DSDD £17(c); 80T SSDD £21(c); 80T DSDD £22(c)

## DISC ACCESSORIES

Single Disc Cable £6 (d) Dual Disc Cable £8.50 (d)

10 Disc Library Case £1.90 (d) 30 Disc Case £8.00 (c)

Lockable Storage Boxes: 30/40 Discs £14(c) 100 Discs £19 (c)

The FLOPPICLENE disc head cleaning kit is the ideal way to ensure the optimum performance of your drives. The use of disposable cleaning discs eliminate the risk of recontamination and abrasion of the sensitive disc heads and ensure continuously reliable data capture and transmission. Floppiclene with 20 disposable cleaning discs. £14.50 (b)



# COMMUNICATIONS

We offer the customer a choice of modems and suitable communication software, enabling the user to choose an ideal cost-effective system, perfectly suited to his individual needs. We stock modems for every requirement, whether it is for the business, or private user, whether you require access to a public database or a mainframe, whether for local or international use. We also carry suitable software — see our section on ROMS.

## MODEMS

**TORCH UNICOMM** See our section on Torch for further details.

**ACORN PRESTEL** The dedicated Prestel adaptor complete with integral, BT approved, auto-dial modem and software in ROM £99(a).

**BUZZ BOX** A full spec, BT approved, pocket size, direct connect modem with both originate & answer modes, full & half duplex, allowing access to many databases, bulletin-boards as well as intercomputer communications. It conforms to CCITT V21 300/300 Baud standard. Battery/mains powered. £65(c) BBC Lead £3.50 External PSU £8.

BT approved

**WS2000** A world standard direct connect modem switchable between 75,300/300,600,1200/75,75/1200 baud. It is compatible with Bell 103/113/108, 202 and CCITT V21 & 23 standards and allows you to communicate with virtually any computer system in the world. This is one of the new generation modems, that will probably cover any communications standards you would ever need. This is the modem that will cover Prestel, Micronet, Telecom Gold, Distel, Microweb, One-to-One, Bulletin Boards both in the UK and abroad, etc. etc. as well as user-to-user communication. It also has a rather useful facility of 'Reverse-Prestel' mode i.e. 75/1200 so that you can communicate with other users who only have a standard 1200/75 type modem. What possibly gives this modem its biggest advantage is its option of computer controlled switching between all modes of operation. In addition, separate auto-answer and auto-dial cards are available, giving this modem possibly the greatest potential of all. Mains powered. £129(c).

Please phone/write for details of optional extras.

**TELEMOD-2** A BT approved modem complying with CCITT V23 1200/75 Duplex & 1200/1200 Half-Duplex standard, that allows communication with Viewdata services e.g. Prestel, Micronet etc., as well as using 1200 Baud for communicating with other computer users. Mains powered. TELEMOD 2 £65(b) BBC Lead £3.50

**TERMI** This is a semi intelligent terminal emulator allowing the BBC to act as a dumb terminal, slave BBC graphics terminal, or VT52 terminal. The rates at which data is sent or received is easily set up with rates of up to 4800 Baud with 40/80 col. selectable. Allows files to be transmitted from disc, or a copy of incoming data to be sent to a file or to a printer. (Termi is not suitable for PRESTEL). £28(d).

**COMMUNICATOR** This is a full 80 col VT100 terminal emulation program on 16K eprom. It is a more advanced program than TERMI and features easy to follow screen menus. The rate at which data is sent or received is easily set up with rates up to 19200 Baud with 80 column text. Allows files to be transmitted from disc, or a copy of incoming data to be sent to a file or to a printer. (Communicator is not suitable for PRESTEL). £59(d).

**COMMSTAR** This intelligent communication facility is extremely easy to use yet very versatile. It features a terminal mode, a full VT100 emulation mode and a special PRESTEL mode. In Terminal mode, all input may be copied into a buffer in memory over which full control is provided. Controls of protocols is very simple and any type of file (not just ASCII) may be sent using XModem protocols. The Emulation mode may be used using a disc based emulation file to emulate virtually any terminal type including VT100, within the capabilities of the BBC. In PRESTEL mode all normal Prestel features are available, including downloading of software, saving and retrieving of pages etc. etc. £29(d).



# TECHNOMATIC

All prices exclude VAT

## EPROMER II

Our current version of the highly popular Eprom programmer is now being enhanced to provide more and better facilities for easy programming by the user. The software will maintain its superiority over all currently available similar programmers. The range of eproms handled has been widened to include the eproms with lower programming voltage and eproms which can be programmed using the fast algorithm. Control of all operations has been moved to the keyboard. The screen display has been improved to give more information. The screen editing facilities have also been modified to simplify the data entry.

### Preliminary Information

- \* The new Eprom Programmer will now program 2516, 2532, 2564, 2716, 2732, 2764, 27128 and 27256 + 5v eproms, and all but the 27256 in a single pass.
- \* The programmer will be supplied with integral power supply, and interfaces with the BBC via the 1MHz bus. It is fully buffered and complies with Acorn protocols. There is no power drain from the computer.
- \* No knobs or switches to fiddle with — total control from the keyboard.
- \* Fully software driven with easy to understand instructions displayed on the screen.
- \* Eprom type selectable from the keyboard.
- \* Selectable programming voltage 25/21/12.5V.
- \* Defaults to normal programming with high speed algorithmic programming selectable, for a device with suitable capability.
- \* Continuous screen display of eprom type, option and address range selected.
- \* Full screen editor with HEX or ASCII input. Constant display of logical eprom address.
- \* Can read, blank check, program and verify at any address/addresses on the eprom.
- \* Full Tape/Disc filing facility.
- \* Several basic programs can be entered on a single eprom and called up with individual name.

£102(b)

## ATPL SIDEWISE ROM EXPANSION BOARD

This is a well constructed expansion board that does not require soldering in its installation. It will give you an additional twelve sockets, with 16K of battery-backed RAM option. Several link-selectable options include the choice of type of Eprom, and a 'write protect' for the RAM option. All the busses are full buffered. £39(d).

EPROMS 8K 2764-25 £4.90(d); 16K 27128-30 £18.00(d).

RAM 8K standard power 6264-15 £26(d); 8K low power 6264LP 15 £31(d).

## SMARTMOUTH

The Original 'Infinite Speech' Synthesiser — Still the Best!

A ready-built totally self-contained speech synthesiser unit, attractively packaged with built in speaker, Aux. output socket etc. Optimum sound quality is achieved due to a tailored frequency response audio stage. It allows the creation of any English word with both ease and simplicity, while, at the same time, being very economical in memory usage. You can easily add speech to most existing programs. Due to its remarkable infinite vocabulary, its uses spread throughout the whole spectrum of computer applications — these include educational, industrial, scientific, recreational etc. — simply plugs into the User Port. No ROMs are needed. Smartmouth is supplied with demo and development programs on cassette (easily transferred to disc) and full instructions. £37(c).

## UV ERASERS

UV1T Eraser with built-in timer and mains indicator. Built-in safety interlock to avoid accidental exposure to the harmful UV rays. It can handle up to 5 eproms at a time with an average erasing time of about 20 mins. £59(b).

UV1 as above but without the timer. £47(b).

For Industrial Users, we offer UV140 & UV141 erasers with handling capacity of 14 eproms. UV141 has a built in timer. Both offer full built in safety features UV140 £61; UV141 £79(b).

## 'TIME-WARP' REAL-TIME CLOCK CALENDER

A low-cost compact unit that opens up the total range of Real-Time applications, and adds a new dimension to the personal computer. Though built to exacting professional standards, it is at a price previously unattainable, and brings it within reach of all BBC Computer owners. With its full integral battery backup, possibilities include an Electronic Diary, continuous display of 'on-screen' time and date information, automatic document dating, precise timing and control in scientific applications, recreational use in games etc. — its uses are endless and are simply limited by ones imagination. Simply plugs into the User Port — no ROMs needed. Extensive applications software supplied on cassette (easily transferred to disc) and full instruction manual. Please phone for details. £29(c).





# 01-208 1177

Please add VAT and carriage: (a) £8; (b) £2.50; (c) £1.50; (d) £1  
Carriage (a) sent by Datapost

## ACORN IEEE INTERFACE

This interface enables a BBC computer to control any scientific and technical equipment that conforms to the IEEE488 standard, at a lower price than other systems, but without sacrificing any aspect of the standard. The interface can link up to 14 separate IEEE compatible devices. Typical applications are in experimental work in academic and industrial laboratories, with the advantage of speed, accuracy and repeatability. The interface is mains powered and comes with cables, IEEEFS ROM, and user guide. £282(a)

## ACORN TELETXT INTERFACE

This interface enables a BBC Computer to receive and store teletext information transmitted by both BBC and ITV. In addition it allows the downloading of transmitted software. The unit comes with a ROM and user guide. £195(b)

## DATABASE MANAGEMENT SYSTEM

**GEMINI DATAGEM**

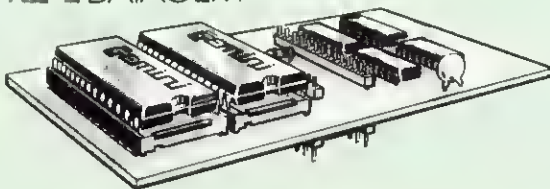

The Definitive Random Access, 24K ROM Based DATABASE MANAGEMENT SYSTEM.

Datagem is the first truly flexible database for the BBC Micro that can make your system really useful and efficient, saving you money in the long run. The system includes a carrier board containing two Eproms, demonstration applications disc in both 40/80T, professional documentation with quick reference card, and 'Trans' utility program. Features include: \*almost unlimited file size (max 10MByte) \*supports up to 4 drives \*Max of 5000 records per file \*max 6K record size \*max of 62 fields \*9 level hierarchical search system with facilities to store results of searches. Searches can be any one of the following: Search, Include, Exclude, Combine, Common or Difference \*user defined variables \*generates form letters from records. Please ask for leaflet. £112(c).

## ACORNSOFT/MIRLE Business software

A well designed, cost effective business system, having the advantage of being able to purchase packages individually, with the option of, possibly later, linking them with other packages. INVOICING, ORDER PROCESSING, ACCOUNTS RECEIVABLE, ACCOUNTS PAYABLE, STOCK CONTROL, PURCHASING, MAILING SYSTEM. £22(d) each.

## SPECIAL CLEARANCE OFFER

Hell Driver;	Swoop;	Galactic
Felix in the Factory;	Alien Swirl;	Commander;
Laser Command;	Demon Decorator;	Where?;
Martian Attack;	Android Attack;	Labyrinth of La
Cybertron Mission;	Danger UXB;	Coshe;
Alien Destroyers;	Footer;	Chemistry;
Chess;	Moon Raider;	Physics;
Escape from Moon	ZARM;	Constellation
Base Alpha;	Eldorado Gold;	Croaker.

Only £2.50(d) each

## BBC FIRMWARE

**VIEW Word Processor Rom on special offer at £48(c).**  
This is the new version V2.1. Advantages include being able to print straight from memory, as well as editing in any mode. Complete with comprehensive manuals to Acorns usual high standard.

**WORDWISE** One of the most popular word processors for general use £34(d). Wordwise SpellCheck Disc — A must for any serious word processor user. Normal price £16.50(d). If bought with Wordwise: No p&p and only £14.

**ULTRACALC** From BBC Publications: The only spreadsheet ROM for the BBC that offers features found in the most sophisticated spreadsheet programs, like the handling of labels as well as numbers as values, and allowing a search by a meaningful name instead of just a number etc. Efficient memory usage allows large spread sheets to be constructed. Facilities and commands include, variable width column, Sum, Replicate, Insert, Delete, & most mathematical functions. It helps to create and manipulate pricelists, balance sheets, payroll, c/flow forecasts, order entry, small databases, scientific calculations. £69(c).

**VIEWSHEET** Ask for details £52(c)

**BCPL** A full implementation of the BCPL compiler language from Acornsoft. It consists of the BCPL language ROM and a disc containing the BCPL Compiler, a Screen Editor, a 6502 Assembler, other utilities and program development aids, and some examples of BCPL code. A comprehensive 450 page user guide is included. It can be used to develop games programs and commercial packages, to develop system software, to write control systems, and to produce programs which otherwise would need to be written in assembler. £86(b).

**BCPL CALCULATIONS PACKAGE:** supplied on disc, it supports floating point, fixed point and fast integer calculations. It includes the BCPL calculation tiles, example files and a comprehensive user guide. £17.30(b).

## UTILITY ROMS

**DISC DOCTOR** This general purpose ROM adds 20 commands to the DFS system. It includes a formatter, sector editor, tape-disc & disc-tape routines, a powerful disassembler, commands for listing function key definitions for editing etc. This ROM will obviate the need to go for non standard DFS systems (with their inherent disadvantages) as it overcomes many of the Acorn DFS's shortcomings. £28(d).

**GREMLIN** Contains a full machine code monitor including features such as a disassembler, memory move and search routines. Also feature a full expression evaluator and an assembler. Can single step through ROM & RAM as well as any sideways ROM. Works in any mode with full status display. Up to 8 breakpoints can be used and it has a special mode for debugging graphic programs. £28(d).

**EXMON** This extended machine code editor provides 35 new commands. Features include machine code relocater, single stepping, memory search and full assembler & disassembler. £20(d).

**TOOLKIT** This ROM adds 27 new commands to the BBC BASIC. These include a full screen editor, merge, relocating data in memory, program compactor, listing of variables and memory search. £23(d).

**CARETAKER** This adds 17 new commands to the BASIC which include: renumber, squash, exchange insert, single key entry of BASIC keywords etc. £28(d).

**GRAPHICS ROM** This ROM includes over 28 new graphics related commands which can be used in BASIC programs. Features include: sprites, LOGO Turtle graphics, fill routines, shading, large characters, rotation, scaling and 3D plotting all using '\*' commands. £28(d).

**PRINTMASTER** This ROM features the most versatile screen dump for EPSON MX/RX/FX80 and Kaga 810 printers. It supports three types of dumps. The first allows any graphics on the screen to be dumped. Colours appear as shades of grey. Any part of the screen can be printed at any position on the paper in any one of four orientations. The screen dump may be magnified by any factor x2, x3, x4 etc. A special feature allows true MODE 7 screen dumps with TELETXT text & graphics. The second dump allows any text to be dumped whilst the third dump will print the contents of a file on disc whilst the computer is doing other things. This is not all. All printer functions can be called up using the \* command. \*DEFINE allows the user to define his own characters and store them. \*GPRINT allows printing of enlarged text in any position, orientation, size & shade. \*WINDOW allows windows to be defined in any size and position on the screen. In short this one ROM does it all. £28(d).



# SOFTWARE

## CP/M SOFTWARE FOR TORCH Z80 ACORN Z80 PROCESSOR

We can now supply almost any CP/M based software package in e format suitable for the Torch Z80 and Acorn Z80 second processors. The following are generally available from stock.

DBASE II £365 (a) WORDSTAR £295 (e) MAILMERGE £145 (a)  
WORDSTAR/MAILMERGE COMBINED £395 (e)  
DBASE II TUTORIAL (All Lessons on Disc) £32 (c)  
PROPASCAL £220 (a) CP/M TUTOR £55 (c)

Phone for your specific requirements.

Please specify the type of format (TORCH or ACORN) is required.

## MICROTEXT

This authoring system was developed by the National Physical Laboratories. It is a programming system designed to simplify the production of a wide range of man-computer dialogues. Using Microtext's simple commands, the user can draw up any number of 'frames', each containing text and/or graphics. A series of frames build up into a complete module. Each program can consist of more than one module. Using Microtext, an expert in any field can construct their own complete courses of computer-based instructional material. Applications include interviewing systems, teaching packages, training courses and interactive demonstrations and simulations. Available on Cassette and Disc. £52(a) Disc; £43(c) Cassette.

ACORN/Soft (d)	Disc	Cass	MISSILE BASE	Cass
S/PASCAL	£17.30	£14.65	PLANETIDS	£5.00
LISP	£17.30	£14.65	METEORS	£5.00
FORTH	£17.30	£8.65	CAROUSEL	£5.00
PICTURE MAKER	£10.00	—	MONSTERS	£5.00
TURTLE GRAPHICS	£17.30	—	FORECAST	£5.00
CREATIVE GRAPHICS	—	£8.65	CHESS	£5.00
HOPPER	£6.00	—	DRAUGHTS&REVERSI	£5.00
SNOOKER	£6.00	—	<b>BBC PUBLICATIONS</b>	
STARSHIP COMMAND	£6.00	—	VU TYPE	£11.65
JCB DIGGER	£6.00	£5.00	RECORD KEEPER	£14.00
AVIATOR	£15.65	£13.00		
CRAZY TRACER	£6.00	£5.00		
ELITE	£15.65	£13.00		

Elite Cassette & Disc versions available from stock. (Disc version for 40TSS or 80TDS).

Replica II 40 & 80 Track Versions available. £10.35(d)

Printer Drivers On disc 40 or 80 Track Disc  
RX/FX80/KAGA/NEC PC8023/JUKI 6100/BROTHER HR15 £7(d).

**Design** Design is a second processor which allows information to be displayed in a format suitable for demonstrations, slide projections, handouts or presentations. Graphs, Pie charts & Bar Charts are quickly produced; automatically drawn & scaled. Versatile labelling facility, 24 User defined, 4 large macro characters plus screen dump facilities included. £16.50(d) Disc (80 or 40 Track).

**Superplot** Superplot is ideal for screen representations of mathematical functions. It will plot on automatically scaled axes, in Cartesian, Polar or Parametric co-ordinate systems and will allow overlapping of graphs. £16.50(d) Disc (80 or 40 Track).

**Spellcheck** Menu driven spelling checker for WORDWISE or VIEW. Dictionary contains 6000 words and is expandable to 17000 on 100K disc. £16.50(d) Disc (80 or 40 Track) Specify the word processor.

**Masterfile** A general purpose data base that is extremely useful, allowing vast amounts of information to be stored. The disc version allows up to 17 fields per record, and the only limitation as to the number of records is the capacity of the disc. Typically, using 5 fields, about 2000 records may be stored on a 100K disc. £16.50(d) Disc.

**Teletext Pack** An editor enabling colourful mode 7 screens to be quickly created. Powerful facilities including a graphics character definer, speed up screen creation and design. Screens can be loaded or saved in the normal way or specially saved as a Basic routine for use in other programs. On screen teletext tutor included in the package. Ideal for setting up prestel type displays £16.50(d) Disc (80 or 40T).

When ordering software on disc please specify track format (40/80)

**VU-Type** This is a powerful and versatile typing tutor developed and published in association with Pitmans. It is designed to enable you to acquire or enhance typing and keyboard skills. £11.65(d).

**Record Keeper** A personalised program for storing and retrieving data for a variety of purposes. Report facility lets you choose how to generate the layout of your data and display and print it. The program also contains alternative versions for transfer to disc. £14.00(d).

## BOOKS

(No VAT p&p £1.50 per book)

Let your BBC Teach U To Program.....	£3.50	Disc Systems.....	£6.95
100 Programs for the BBC.....	£6.95	Discovering BBC M/Code.....	£6.95
30 Hour Basic.....	£6.95	Essential Maths BBC/Electron.....	£5.95
35 Educational Progs.....	£6.95	Forth.....	£7.50
6502 Applications.....	£10.95	Friendly Computer Book.....	£6.95
6502 Assembly Lang Programming.....	£13.95	Graphics on the BBC Micro.....	£6.95
6502 M/Code for Beginners.....	£5.95	Graphs & Charts.....	£7.50
6522 VIA Book.....	£4.50	H/Bk of progs/tuncts for BBC.....	£6.95
6809 Assembly Lang Programming.....	£13.95	Instant Arcade Games BBC.....	£2.95
Advanced Graphics with BBC.....	£9.95	Interfacing Projects BBC.....	£6.95
Advanced M/C for the BBC.....	£7.95	Interfacing the 6502.....	£10.95
Advanced Prog Tech for BBC.....	£8.95	Intro BBC Micro.....	£5.95
Advanced 6502.....	£11.75	Intro to Pascal.....	£12.95
Advanced User Guide.....	£12.50	LISP.....	£7.50
Assembly Lang Prog on the BBC.....	£8.95	Making Music on the BBC Computer.....	£5.95
Assembly Lang for the BBC.....	£8.95	Mastering CP/M.....	£7.95
Assembly Lang Prog for Electron.....	£26.00	Micro BBC Basic Sound Graphics.....	£7.95
Assembly Lang Programming		MOS Memory Data Book.....	£3.95
Birnbaum.....	£8.95	Prog. Micro with Pascal.....	£8.50
Basic Prog on the BBC Cryer.....	£5.95	Prog the BBC Micro.....	£6.95
Basic Rom User Guide.....	£7.95	Programming the 6502.....	£10.95
Basic II Rom User Guide.....	£4.00	Programming the 6809.....	£11.95
BBC Basic.....	£5.95	Programming the 8086/8088.....	£11.75
BBC Basic for Beginners.....	£6.95	Programming the BBC.....	£6.95
BBC Micro for Beginners.....	£6.95	Programming the Z80.....	£13.45
BBC Micro Disk Companion.....	£7.95	Start Prog with Electron.....	£5.00
BBC Micro Expert Guide.....	£6.95	Step by Step Programme Book 1.....	£5.95
BBC Micro Graphics & Sound.....	£7.95	Step by Step Prog Book 2.....	£5.95
BBC Micro in Education.....	£6.50	Structured Programming.....	£6.50
BBC Micro Revealed.....	£3.50	The Electron Book.....	£5.00
BCPL User Manual.....	£15.00	TORCH Z80 Disc Pack User Guide.....	£10.00
Beyond Basic.....	£7.25	TTL Data Book Vol. 1.....	£9.00
CP/M Handbook.....	£10.95	TTL Data Book Vol. 2.....	£9.20
Creating Adventure Progs.....	£6.95	BBC User Guide.....	£15.00
Creative Assembler for the BBC.....	£5.95	Using BBC Basic.....	£10.00
Creative Graphics.....	£7.50	Using Floppy Disks.....	£6.95
DIY Robotics & Sensors.....	£6.95	Using the 6502 Assembly Lang.....	£14.50
Disc Book.....	£3.50	Z80 Applications Book.....	£13.45
Disc Programming Techniques			
BBC.....	£6.95		

## EDUCATIONAL PROGRAMMES

A selected range of cassette based software for all the family to enjoy and at the same time arouse curiosity and create an interest in computers. Apart from providing hours of fun they will also help teach the young ones fundamentals of English and Maths without them realising it.

**Mr T's Alphabet Games** Watch how quickly the children learn to identify, name & match the letters and also write them correctly. Amusing sound effects and animated graphics make learning fun. £7(d).

**Number Gulper** A gripping fast moving game that helps develop arithmetic skills. 19 levels of skill to cater for all ability levels. Even parents might find upper levels embarrassing. £7(d).

**Words Words Words** A stimulating game to help young children with reading & spelling. Pictures are shown on the screen and the child has to type in the name of the object shown. If correct, the object takes its place in a scene. When all objects have been correctly identified the scene comes to life. £7(d).

**Tree of Knowledge** A interactive program that teaches categorisation. The computer is first educated about a group of objects — e.g. plants or birds. The database, or tree created in this way is then used in playing a guessing game. Two sample databases are supplied on the program. New databases are saved and loaded from within the programs. £7(d).

**Royal Quiz** Pit your knowledge of Royalty against Anthony Holden, the Royal Biographer. Do you know who told the queen that she didn't recognise her "without her crown on"? The quiz will tease, teach and entertain. £7(d).

**Science Fiction Quiz** A SF quiz in the widest sense, especially adapted from the Weidenfeld Quiz book that will provide hours of edification and amusement. £7(d).

## TECHNOMATIC LTD

MAIL ORDERS TO: 17 Burnley Road, London NW10 4ED  
(Tel: 01-208 1177 Telex 922800)

SHOPS AT: NW London: 15 Burnley Road, London NW10 4ED  
(Dollis Hill 2 mins walk, ample car parking space)

West End: 305 Edgware Road, London W2. Tel: 01-723 0233  
(Near Edgware Road)

01-208 1177

All prices exclude VAT. Please add 15% VAT and carriage  
(a) £8; (b) £2.50; (c) £1.50; (d) £1.00.

Carriage (a) by Datapost.

For fast delivery telephone your order quoting

VISA or Access card or official order number.

(Minimum telephone order £5)





Available at selected  
Spectrum (UK) and other  
leading computer outlets.



# MAKE THE BBC AN EXPERT AT COMMUNICATIONS.



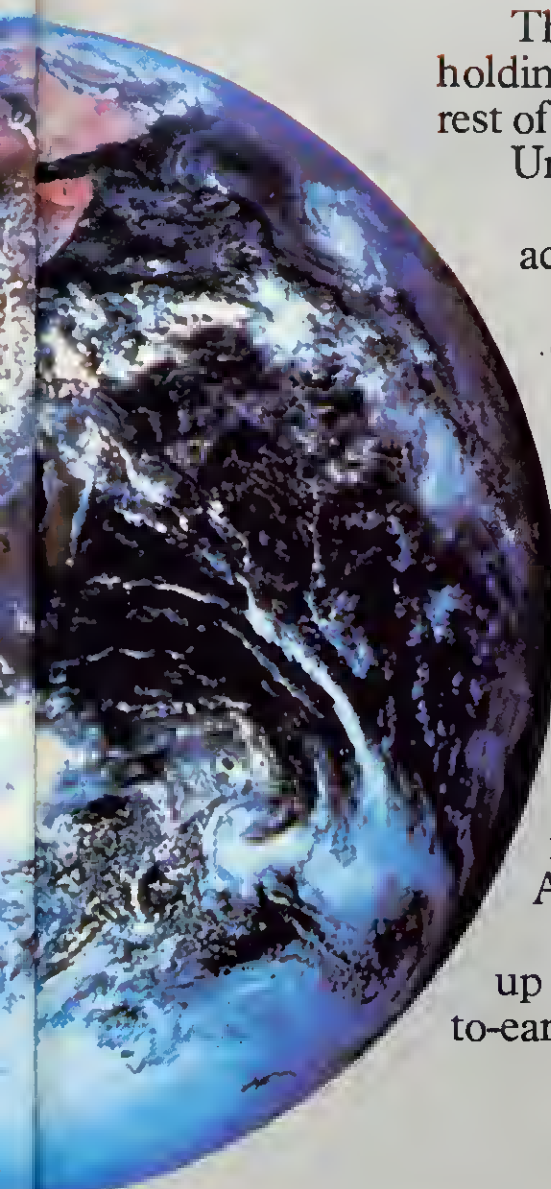

The BBC Micro is unbeatable when it comes to holding your attention. But when it comes to talking to the rest of the outside world it's virtually speechless.

Until, that is, you speak to us.

In which case you and your BBC could soon be accessing viewdata systems throughout the country.

By simply linking your BBC into our purpose-designed communications and viewdata system you dramatically increase the capability of your micro. Allowing you to keep in touch with your friends. And to get answers within minutes to electronically mailed letters. You can even try your hand at the latest adventure games on Micronet 800 (as well as looking at the news, reviews, prices and best-buy information).

In addition to all this, you will also be able to access Prestel. A vast database of news and information. Helping you to book tickets for your favourite concerts. Plan your road and rail trips. And even check the weather forecast before you go.

Our communications and viewdata systems open up the world to you and your micro. And at a down-to-earth price – with systems starting from under £90.

So, if you're keen to contact the outside world... simply contact us.

APPROVED for use with telecommunication systems run by British Telecommunications in accordance with the conditions in the instructions for use.

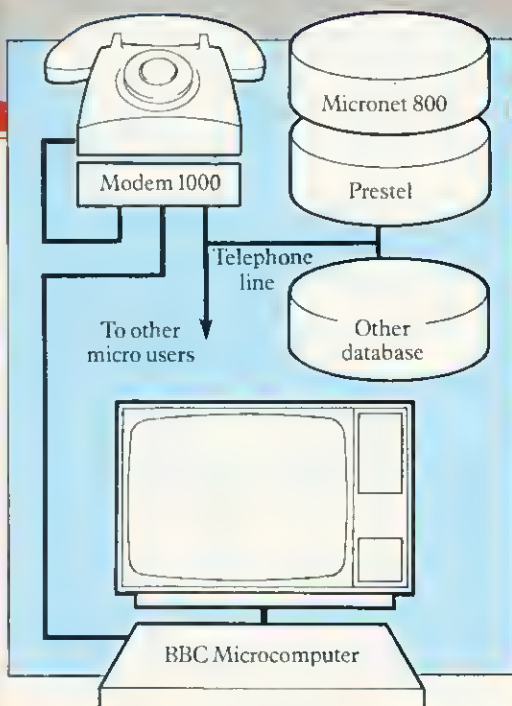

**Prism Microproducts Ltd.**  
Prism House, 18-29 Mora Street  
City Road, London EC1V 8BT  
Telephone: 01-253 2277



Please send me further details of the Prism viewdata communications system for the BBC Micro. Send to: Prism Microproducts Ltd., Prism House, 18-29 Mora Street, City Road, London EC1V 8BT.

Name \_\_\_\_\_

Address \_\_\_\_\_

\_\_\_\_\_

Tel: \_\_\_\_\_

AP6

AU 11

Prestel and the Prestel symbol are trademarks of British Telecommunications.

# ELECTRONIC

## Graffiti

BBC TV producer David Allen shares some of the behind-the-scenes traumas of making live micro programmes

28

*Put another password in,  
Bomb it out and try again,  
Try to get past logging in,  
We're hacking, hacking, hacking.*

*Try his first wife's maiden name.  
This is more than just a game.  
It's real fun, but just the same  
We're hacking, hacking, hacking.*

**T**HE Hacker's Song became instant news in the first *Micro Live* back in October as it flashed unheralded onto the screens of those watching BBC1 when John Coll and Ian McNaught-Davis attempted to demonstrate electronic mail live on television.

Someone had cracked our (two-letter) password and left a message that was triggered off as John logged on to British Telecom Gold. A hacker, in fact.

The term hacker comes from American university campus slang, where it originally meant simply someone who worked hard: 'Who are you hacking for?' - 'Oh, Doctor So-and-so'. But we now know it to mean someone who tries (as a hobby) to break into other people's computer systems.

In the gallery above the studio we were bemused - it was the first time we had been on the receiving end of a hacker, and although there had been rumours that something might happen, the production team were not involved in what actually took place. The whole incident was like someone bursting into the nine o'clock news and shouting out a political slogan.

I can't remember anything like it having happened on television before. What I can remember is furiously scanning the screen for obscenities (it was live, after all, and on a Sunday morning) and being relieved at the exquisite taste of the practical joke. Like all good practical jokes it was not malicious. It also was instructive. 'Try his first wife's maiden name' is after all, a sobering comment. At that time, the password on my electronic mailbox was indeed my



'Micro Live' presenter Ian McNaught-Davis meets Freff in New York. Using a BBC micro, Freff transmitted an illustrated message from the 'Big Apple' to London for the show.

wife's maiden name! I changed it afterwards to the name of my cat.

As the hacker (or hackers) was anonymous, it wasn't possible for us to acknowledge copyright in the work. However, I am happy now to be able to put that right. Our hacker's song was part of a longer epic quoted in *Newsweek* by an American hacker called 'Ozzy' (not to be confused with one half of Oz and Yug, whose express mail message appeared at the bottom of the screen alongside the hacker's song and whom we incorrectly assumed were responsible for it all). Ozzy says the proper credit should go to someone enigmatically called 'The Cheshire Catalyst'.

Another stanza goes:

*Syscall, let's try a syscall.  
Remember that great bug from  
Version 3  
Of R-S-X, it's here,  
whoopee!*

*Put another Syscall in,  
Run those pass words out, and then  
Dial back up, we're logging in  
We're hacking, hacking, hacking.*

(To be sung to the tune of *Put another Nickel in the Nickelodeon*.)

*Newsweek*, it seems, were as bemused as I am by much of this. Perhaps some friendly hacker can inform me of its meaning.

Electronic mail and hacking were the subject of another item on June 24 when we transmitted the second *Micro Live*, again on a Sunday morning.

This time we investigated the world of the computer hackers by filming one hacker, 'David', in silhouette, actually in the act of getting into a system, and another, 'Jeremy', a reformed hacker, who was prepared to reveal some of the secrets of the fraternity.

Another item involved a live transfer of software from New York to London by Freff (that's his full name, by the way), our reporter in the United States. And that demonstration, carefully supervised by Telecom Gold to prevent another intrusion, very nearly precipitated another 'hack' as a result of the very measures we were using to prevent history repeating itself. But more of that later.

Freff first appeared in our consciousness when we visited the Chicago Robotics Convention in 1983 for the series *Computers in Control*. He was behind the scenes of a stage show that



featured several Unimation robots and an actor. Freff was supervising the network of micros that triggered off the sequence of events in which the robots worked co-operatively to entertain the crowds.

Later, having just attended the launch of the BBC micro in America, I visited him in New York in the apartment where a good deal of work for the robotics show was put together. It became clear that his interests in the microcomputer covered so many fields that he would make a great transatlantic contribution to *Micro Live* and the new series we are working on for this autumn.

Last October Acorn (USA) promised to provide him with a BBC micro to review and, sure enough, it arrived in May just two hours before I arrived in New York to work out a film story with Freff for *Micro Live*.

We've been using electronic mail in the BBC Computer Project for over a year now, and very useful it is, too. British Telecom Gold had, forgivingly, provided me with a series of links so that while in the US I could enter the Dialcom system in the US to make contact with my mailbox in London. Usually I use a portable Tandy TRS80-100 when I go abroad, but Freff and I decided to use the BBC micro, fresh from its box.

Needless to say, when we pieced everything together the electronic mail system didn't function, even though the computer seemed to be working well. Knowing how infuriating this experience is to users, we made a virtue of it and I filmed Freff in a frustrated state, saying that he didn't know what was wrong, but something sure was, and that he hoped to get it all functioning before the live show.

Since we'd seen electronic mail working on the first live show we decided to try something different. We'd have Freff on the telephone talking to us and, using a second telephone line connected to the micro, he'd send us a piece of software that we'd then run in the studio.

An attractive and simple enough idea. However, over the weeks between his getting the machine (and replacing the faulty modem) and the live show itself we discovered that things weren't quite that simple.

First, the US version of the BBC micro has a different operating system and a slightly different Basic to suit the American market. American television monitors run at 60 cycles and have 525 lines instead of 625 as in the UK. This means that the screen formatting is different. And the Americans, of course, have differences in spelling—the COLOUR command, for example, becomes COLOR. And if you abbreviate a line of code to COL the machines

## BIRD OF PREY GAME OUT FOR A DUCK

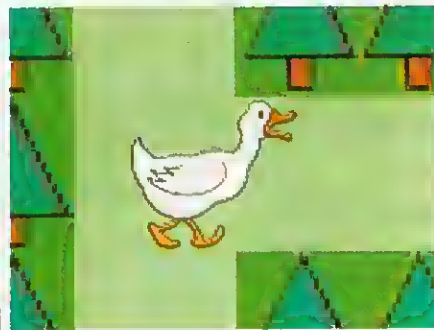

CAN this little duck really be the bird referred to in the title of BBC1's recent *Bird of Prey* series? We don't know, but it's a shame the computer game to accompany the programme never made it (see Bulletin Board, page 16). If you think the graphics in the credits were produced on a humble micro though, think again. The pictures were 'pixelated' to give the jagged-edge effect of low-resolution computer graphics on a Quantel Paintbox. And how much is one of those? A cool £80,000.

print out the whole thing as COLOR on one version and COLOUR on the other, when you list the program, even though both machines accept the abbreviation.

Second, the electronic mail system doesn't have error-checking, so everything depends on a good telephone circuit, and occasionally, especially if everything was going through the BBC switchboard, odd characters would disappear or get garbled.

Thirdly, you have to write the code so that there are reasonably short lines, otherwise the mail system splits them. If it happens to split them so that the new line begins with a number, the computer thinks this is a new line number and everything gets confused.

However, we eventually devised a piece of software that would run reasonably well on both machines—a representation of an apple, with a message. On pressing the space bar, three bite-shaped chunks appeared out of the apple, together with a crunching noise, with the message 'Some bytes from the Big Apple'. Core-ny? Well, we were only doing it for fun, though in principle this is a perfectly reasonable way of shipping a computer program around the world.

When it came to the day, we had devised a way of getting the mail sent quickly. Freff was to load the program up from disc as an ASCII file into the mail system and was poised to type the commands (which sends the mail)...

Meanwhile, partly spurred by the first *Micro Live*, Telecom Gold introduced procedures to prevent or at least discourage hacking. After three attempts at a password you are now thrown off the system, and repeated attempts to log on are monitored, so they tell us. And passwords now have to be at least six characters long.

Nonetheless, understandably anxious to avoid a repetition of last year's hacking, Telecom Gold said it would issue new mailboxes and new passwords only an hour or so before the show, and these were to be communicated to Freff by direct phone and to John Coll on the studio floor.

Sure enough, in the middle of the studio rehearsal on the day, a representative arrived and whispered the new password and mailbox to John as he spoke to Freff on the phone. Unknown to any of us, John Coll's personal microphone, clipped to his tie, was picking up every intimate detail and the studio sound was being relayed not only to the gallery, but also to the dressing rooms and, more significantly, to the conference room in which members of the invited audience were having coffee and twiddling their thumbs. One or two of them were, shall we say, not unconnected with hacking and had brought personal micros with them (largely I suspect because they don't like being separated too long from the computing drug).

I am told that a number of them jumped several feet in the air at being handed the information on a plate, and rushed for the telephone. Fortunately for Telecom Gold and for Freff's demonstration, they were foiled by BBC policy—which prevents outside lines being obtained from conference rooms! And rather than miss the show, they resisted the temptation to rush out from the Television Centre to find a call box.

If you were watching the programme, you'll know that Freff's demonstration worked well, with only one error, and one we expected—a syntax error resulting from the keyword COLOR, which John corrected. Unfortunately the sound of the crunching apple failed to materialise on air because someone had pulled the jack plug out of the back of the machine by mistake. So, for the record, here's the noise you missed:

```
1300 SOUND 0,-15,6,1
1310 SOUND 0,-15,4,1
1320 SOUND 0,-15,5,2
1330 SOUND 0,-15,4,1
1340 SOUND 0,0,4,4
1350 FOR times = 0 TO 15
1360 SOUND 0,-15+times,4,0
1370 SOUND 0,0,4,3
1380 NEXT
```

**A**T THE FIRST public airing of the ABC range during the PCW Show, a development manager from Apple is reputed to have challenged staff on the Acorn stand about who had written the icon-based desk-top manager software – because it was so similar to Apple's own version for the Macintosh and they might want to sue! Apocryphal or not, the story reflects the concern which the arrival of the ABC must have stirred up in the competitive business computer market.

Acorn has repackaged its existing BBC micro-based products in an attractive new enclosure, and at the same time launched a range of hardware and software extensions which will give even the biggest commercial computer suppliers a few second thoughts. The ABC will be available in eight different models (see table below) providing a structured upgrade path within one chunky monitor housing which should cater for a wide variety of business needs.

All of the range use a 6502 processor for input/output (to control the screen, keyboard and disc drives); the larger models also have second processors to allow them to run more sophisticated operating systems than Acorn's MOS. At the low end is the Personal Assistant, with View and View Sheet as standard. And there's the Terminal, providing emulation for the DEC VT100 terminal for use with modems or the Econet. Neither of these machines has second processors as they run MOS-based software.

The ABC100 and 110 are Z80-based machines running CP/M and were recognised as such at the PCW Show. Commented one visitor: 'If they had released the ABC100 on its own, no-one would have taken much notice –

# VERTICAL TACK OF THE ABC

by Tony Quinn and Alex van Someren

it's hardly revolutionary stuff.' But the top-end 310 has been noticed, and excited many potential buyers.

The 300 series uses the Intel 80286 processor and is an impressive machine to sit down at. It is compatible with the IBM PC but can provide more advanced processing power with its Concurrent OS and Desktop Manager. It is sure to give IBM's new PC-AT a run for its money (it uses the same processor), and Acorn's Hermann Hauser has been quick to point out that the product was developed in far less time than IBM who had early access to the

chip, while carefully integrating it into their range. The ABC310 offers icons, multi-tasking, windows, CP/M, MS-DOS, and PC-DOS 'The ABC', says Hauser, 'is the only machine to do this.'

However, Acorn is keeping a low profile on any IBM clash and letting the industry do the talking. The company's first brochure for the ABC range doesn't even mention IBM. The nearest it gets is 'PC-DOS'. Sales Director Peter O'Keefe put it succinctly: 'We are a little smarter than to take IBM head-on. We're going for vertical markets in research, communications and so on,

Table 1. The ABC range

Model:	PA	Terminal	100	110	200	210	300	310
Processor:	6502	6502	Z80	Z80	32016	32016	80286	80286
Floppy disc:	640K	—	2x720K	720K	2x720K	720K	2x720K	720K
Hard disc:	—	—	—	10Mb	—	10Mb	—	10Mb
Screen:	Green	Colour	Green	Colour	Green	Colour	Green	Colour
Software:	View Sheet	VT100	CP/M	CP/M	Various, Xenix		CP/M, MS-DOS, PC-DOS	

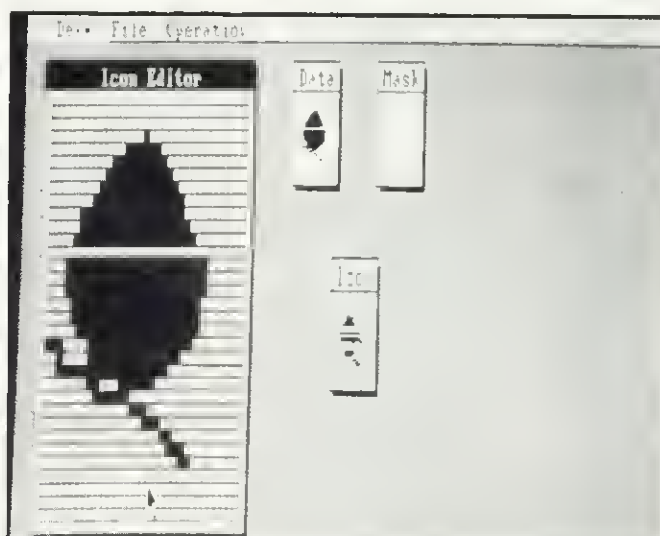
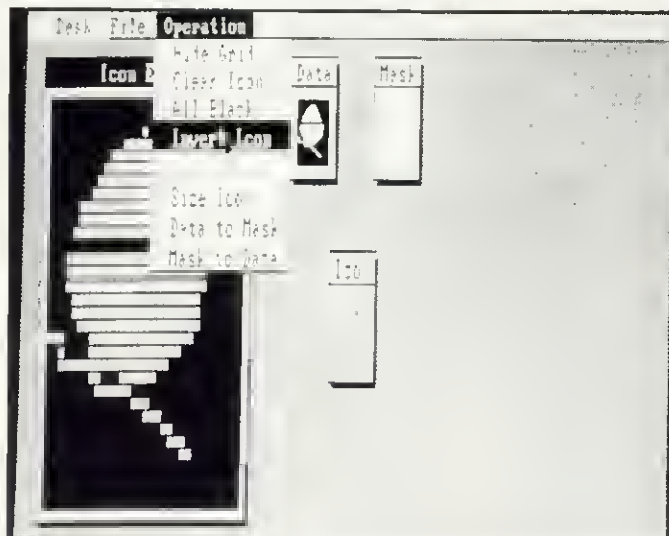

These screen shots show the desk-top manager from the ABC310 in action. The letters on the screen look different to the BBC because the text face has been redesigned. The first picture shows an Operation (note this is in black at the top of the screen) being per-

formed. The black arrow, controlled by the mouse, has pulled down the window menu for Operation. This gives six choices, the one selected being 'Invert Icon'. The result is shown in the second picture, with the acorn in black



where we are established.' He also pointed out at the recent company results meeting: 'IBM are good customers of ours.' At which Chris Curry chipped in: 'But we don't buy any of theirs.'

The Xenix operating system is promised on the ABC210, along with up to 1Mb of RAM. Virtually every language under the sun has been mentioned, from the latest, Modula-2 (see *Byte*, August issue) to Fortran 77 for the die-hards. The 32016-based ABC200 machines are being pushed as academic workstations, and, sure enough, were running Lisp, the artificial intelligence language, at the Show.

The flagship ABC310 certainly lives up to its promise, for it has been demonstrated running a sophisticated, mouse-controlled desk-top manager with icons, menus and windows. For those of you who are baffled by such jargon, it provides a software simulation of a desk complete with overlapping sheets of paper (windows), disc storage (shown as pictures that are known as icons) and possible things to do (presented in menus).

The success of the machine, as with any business computer, will depend to a large extent on the amount of applications software written for it. On this front Acorn has certainly hedged its bets with all the popular operating systems available, and response at PCW was good, said Howard Fisher who is responsible for the ABCs.

How will it find its place in the market, and especially when it comes up against the IBM PC-AT? Who knows, but on first showing its chances are good and pricing (so far guessed at £500-£3500), should be competitive. And, as Peter O'Keefe says: 'There's room for IBM as well as Acorn.'



**A marvel on marble: the ABC310 in all its glory. Beneath the monitor screen on the left is the Winchester hard disc, with the floppy drive beside it. Note the new symbols on the keyboard, re-arranged function keys, keypad and the mouse. There is no break key, but a reset is fitted on the rear of the keyboard. The monitor can be tilted and swivelled on its stand**

*Additional reporting by Geoff Nairn*

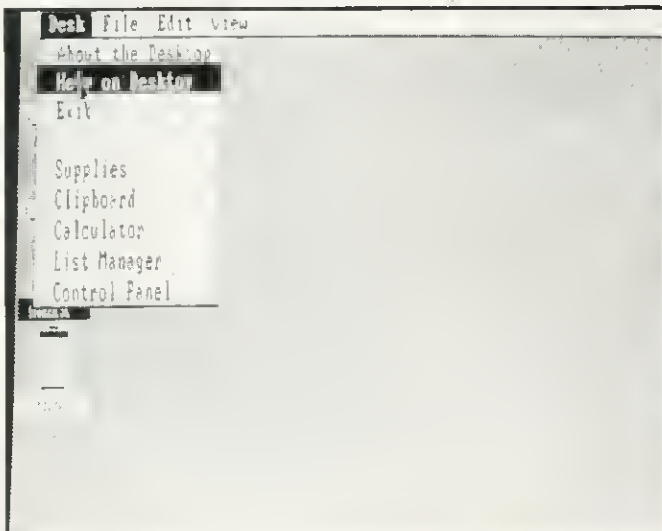

In this shot, the menu for 'Desk' has been accessed with the black arrow cursor pointing to 'Help'. Underneath this menu window are the standard icons to choose the floppy drive (sides A or B), hard disc or 'trash can' (very American!)

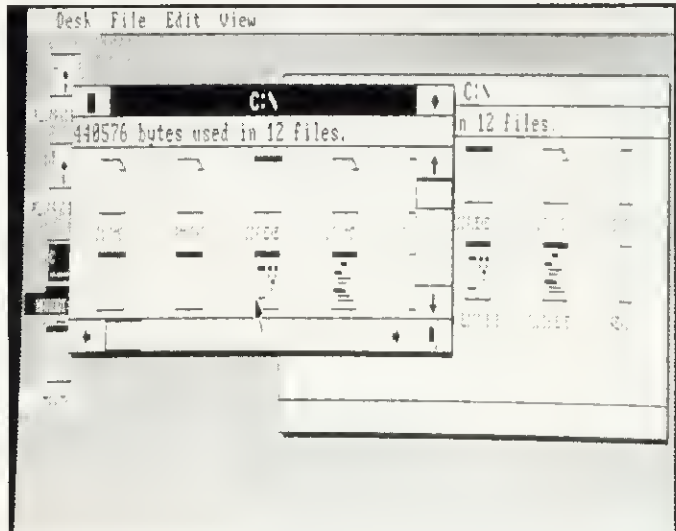

The hard disc has been accessed here (hence the Icon in black on the background) to display file C:\ which is 43.5k long. Two windows showing parts of the 12 files in C:\ are shown



# Watford Electronics



Dept. ACORN, 250, HIGH STREET, WATFORD, ENGLAND.

Tel: Watford (0923) 40588/37774 Telex: 8956095 WAELEC

ACCESS ORDERS Tel: (0923) 50234



**SPECIAL OFFER**

## BBC Micro (Model B) New Low Price Only: £315

6502 2nd PROCESSOR **£175**  
Z80 2nd PROCESSOR **£339**

TORCH Z80 DISC Pack **£695**  
TORCH Z80 2nd Processor **ONLY £295**

BBC Micro with ECONET **£375**  
ECONET Upgrade Kit **£55**  
File Server Level 1 **£85**  
File Server Level 2 **£215**  
Printer Server EPROM **£41**  
Clock Terminators (1 pair) **£95**  
10 Station Lead Set **£25**  
ECONET User Guide and Cable **£10**  
TELETEXT Adapter **£195**  
Acorn Bitstick **£328**

### Dust Cover for BBC Micro

Protects your expensive Micro from foreign bodies while not in use. **£3.50**

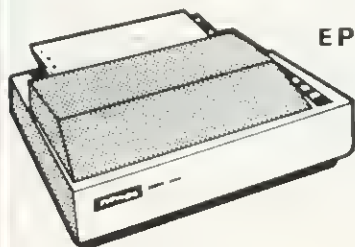

**EPSON**

- EPSON RX80 Printer **£229**
- EPSON RX80 F/T Printer **£245**
- EPSON FX80 Printer **£316**
- EPSON FX100 Printer **£435**
- SEIKOSHA GP100A **£122**
- Centronics PRINTER CABLE for all the above printers to interface with the BBC Micro **£7**  
(Securicor carriage charge on printers £7)

### RX & FX PRINTER INTERFACES

Epson interfaces fit inside the printer to allow connection using techniques other than Centronics

RS232 **£35** RS232 + 2K Buffer **£59**  
IEEE 488 **£65** 2K Parallel **£58**

### PRINTER INTERFACE BUFFER

This neatly packaged, self-contained unit is supplied complete with all leads, operating manual and power supply. Computer output to the printer is stored in the buffer so that the computer can continue with other tasks while the printer works from the stored contents in the buffer. 16K holds approximately 10 pages of A4, close to the full memory of Wordwise. The 48K model is very useful for extremely large documents that otherwise tie the computer up for hours while being printed

Price: 16K **£115**  
Price: 48K **£149**

Type	Ribbons	Dust Covers
MX80FT	<b>£4.75</b>	<b>£4.50</b>
MX100-FX100	<b>£10.00</b>	<b>£5.25</b>
FX80	<b>£4.75</b>	<b>£4.95</b>
RX80	<b>£4.75</b>	<b>£4.50</b>
GP80	<b>£4.50</b>	-
GP100	<b>£4.95</b>	<b>£3.95</b>
GP250	<b>£5.95</b>	<b>£3.95</b>
GP700	<b>£18.50</b>	-
KAGA KP810	<b>£5.95</b>	<b>£4.75</b>
CANON PW1080	<b>£5.95</b>	<b>£4.75</b>

### PRINTER SHARER

This handy UNIT is a solid state switch system designed to ease the problems of short printer leads, continual plugging and unplugging of leads, and costly extra printers by allowing up to three computers to be connected to one printer. It has four parallel Centronics connectors for easy interfacing of the BBC micro to any printer with a Centronics capability such as daisy wheel dot matrix or plotter type printers. PRINTSHARER is ideal for schools and colleges for sharing their printing resources

Price: **£65** (£2 Carr.)

### BROTHER HR-15 DAISY-WHEEL PRINTER

This is a high-quality daisy-wheel printer, for the price of a dot matrix. Daisy-wheel quality gives a professional look to your correspondence. Facilities include 1BCPS, bi-directional print, 3K Buffer with clear facility, carriage skip movement, text copy switch, proportional spacing, underlining, bold, shadow, super and sub-script, printing in two colours. Impact control allows use of carbon paper. Connects directly to the BBC micro with centronics parallel interface. RS232 interface is an optional extra. Other options are a single sheet feeder that automatically feeds up to 150 single A4 sheets and a keyboard to transform the printer into a sophisticated electronic typewriter.

### SPECIAL OFFER ONLY £339 (carr. £7)

Single Sheet Feeder **£195**  
Electronics KEYBOARD **£135**  
TRACTOR FEED Attachment **£90**

RIBBON CARTRIDGES:  
Fabric **£3**; Carbon **£3**; Multistrike **£6**  
DAISYWHEELS (various typefaces) **£18**

### LISTING PAPER (Plain)

1,000 Sheets 9 1/2" Fanfold Paper **£7**  
2,000 Sheets 9 1/2" Fanfold Paper **£13**  
1,000 Sheets 15" Fanfold Paper **£9**  
Teleprinter Roll (Econo paper) **£4**

### PRINTER LABELS

(On continuous fanfold backing sheet)

1,000 90 x 36mm **£5.50**  
1,000 90 x 49mm **£7.75**  
1,000 102 x 36mm **£6.25**

Carriage on Printer Paper or Labels **£1.50**

All prices exclude VAT

### NEW DPW1 120

### DAISY WHEEL PRINTER

At last a low cost, high quality daisy wheel printer that everyone can afford yet there are no compromise in facilities available. 20 CPS, bi directional, logic seeking, print 10, 12 & 15 pitch, proportional spacing, OUME Protocols, OUME Ribbon, OUME Oaisywheel 96 characters, maximum characters per line: 180 at 1/15" pitch, copy capacity: 4 copies Centronics Interface, Supports all Wordstar features, paper width 13" max., Optional extras: RS232-C Interface, tractor feed attachment, single sheet feeder.

Amazing Introductory Offer:

**£185** (£7 carr.)

### KAGA KP810

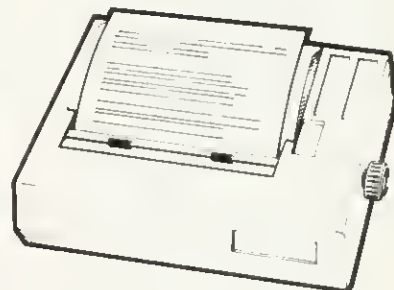

What do the press say:-

"At £269 this is an unbeatable product for what it has to offer." - Educational Computing.  
"Offers excellent value for money." - Electronics & Computing

This new Japanese printer has EPSON FX/RX compatible control codes and is functionally equivalent to an FX80 with the added advantage of its 'Near Letter Quality' mode. It is solidly built and features include: Normal, Italic, Enlarged, super/subscript, proportional spacing and user-defined character set. Extras over the FX80 included in the price are Near Letter Quality (NLO) print ideal for correspondence, properadjustible tractor feed, half speed quiet mode and 3K buffer. The printer is bi-directional and logic seeking to give a speed of 140CPS for high throughput in conjunction with the standard 3K buffer. 8K RAM may be added to give more user-defined character sets. Centronics parallel interface + Watford's 12 month NO QUIBBLE WARRANTY

Special Offer: **ONLY £246**

RS232 interface + 2K buffer to connect to other micros

**£89**

### KAGA KP910 PRINTER

Very similar to the KP810 but with 17" carriage for really wide print. Gives 156 columns of normal print or 256 columns in condensed mode. This printer is ideal for printing out spreadsheets and can also be used for correspondence in NLO mode.

**ONLY £349**

### PRINTER LEAD 36"

Centronics lead to connect BBC micro to EPSON, KAGA, SEIKOSHA, NEC, STAR, JUKI, BROTHER, SHINWA etc. printers.

STANDARD (3 foot long) **£7**  
EXTRA LONG (5 foot long) **£10**



## DOUBLE DENSITY DISC INTERFACE

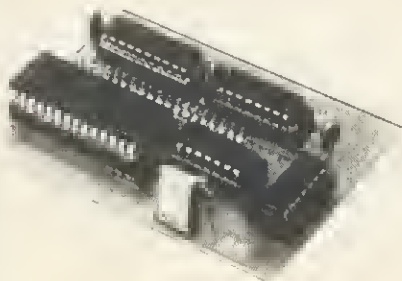

SIMPLE but SOPHISTICATED

We are proud to announce the launch of the Watford Electronics Double Density Board for the BBC micro. The DDFS supplied is a new version of the popular Watford Electronics DFS re-written to make full use of the capabilities of the new double density controller.

- Storage is increased by the maximum physically possible, 80%.
- Our system will use the whole of an 80 track drive. Inferior systems do not allow files longer than &3FFFF bytes, but with our system files can be as long as one disc side.
- Discs may be created in either single or double density format with the built in formatter and in single density mode are fully compatible with normal Acorn format discs.
- The density of the disc you put in is automatically sensed by the system and you are informed of the density in the catalogue display.
- The double density system is of course faster than single density.

Worried about compatibility with single density discs? Don't. The Watford Electronics DDFS implements an extremely comprehensive B271 emulator so that commands passed through OSWORD & 7F are correctly interpreted. Other manufacturers thought that read and write sector alone were sufficient - we decided to implement every command of the B271 that was physically possible. We have allowed the use of all the special registers including bad tracks, allowed access to deleted data etc., etc. The emulator itself takes up around 1K of compactly written machine code. We reckon it will run the vast majority of protected discs now available. Gain all the advantages of the WE DDFS together with much increased storage and compatibility with existing protected discs. The price is the same as for the standard single density system that we continue to sell so you can choose between the two options without financial worries.

Complete Unit incl. DDFS ROM **£85**  
DDFS Manual **£6.95** (no VAT)  
We will exchange your existing Single Density Interface for our DDFS Unit for **£55**

### \*SPECIAL OFFER\*

EPROMs for BBC Micro (Hitachi)  
2764-250nS **£4.95**  
27128-250nS **£16.00**  
RAMs for BBC Micro (Hitachi)  
6116L (2K) **£3.75**  
6264L (BK) **£24.00**

## NEW DESIGN PLASTIC LIBRARY CASES

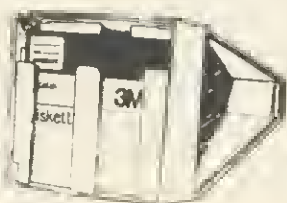

for Disc Storage 5 1/4" (holds 10) **£2**

# DISC DRIVE PRICES SLASHED!

(All Drives are NEW SLIM-LINE Type)  
**NEW LOW PRICES**

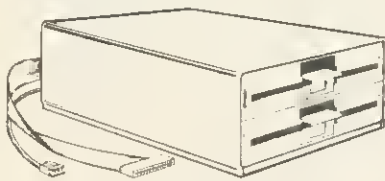

(DRIVES Cased with Cables; connects directly to your BBC Micro)

- **CLS 100** Single, TEC Single sided 40 track 100K, 5 1/4" Disc Drive **£99**
- **CLS200** Single Drive, Double sided 40 track, 200K, 5 1/4" **£129**
- **CLS400** Single, Mitsubishi Double sided 80 track 400K, 5 1/4" Disc Drive **£135**
- **CLS400S** Single, Mitsubishi Double sided 40/80 track Switchable, 400K, 5 1/4" Disc Drive **£159**
- **CLD200** TEC Single sided 40 track 200K, twin 5 1/4" Drives **£199**
- **CLD800** Mitsubishi Double sided 80 track 800K, 5 1/4" TWIN Drives **£269**
- **CLD800S** Mitsubishi Double sided 40/80 track switchable, 800K, Drives **£299**

## (CUMANA) DRIVES CASED WITH PSU & CABLES

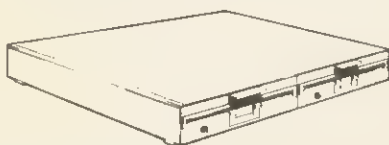

- **CS100** TEC Single sided 40 track 100K 5 1/4" Single Disc Drive **£125**
- **CS200** TEC Single sided 80 track 200K 5 1/4" Single Disc Drive **£149**
- **CS400** Mitsubishi Double sided 80 track 400K 5 1/4" Single Drive **£169**
- **CD200** TEC Single sided 40 track 200K 5 1/4" TWIN Disc Drives **£236**
- **CD400** EPSON Double sided 40 track 400K 5 1/4" TWIN Disc Drives **£299**
- **CD800** Mitsubishi Double sided 80 track 800K 5 1/4" TWIN Drives **£349**
- **CD800S** Mitsubishi Double sided 40/80 track Switchable 800K TWIN Drives **£425**
- SPARE DRIVE CABLES, SINGLE **£6**; DUAL **£8**
- DFS Manual (comprehensive) **£7.50** (No VAT)

### P.S.

You do not require a formatting disc nor the expensive 40/80 track switchable drives if you use Watford's sophisticated Disc Filing System which has all these facilities in the ROM.

## DUST COVERS

- (For our Disc Drives)
- Single (without PSU) **£3.20**
  - Twin (without PSU) **£3.85**
  - Single (with PSU) **£3.25**
  - Twin (with PSU) **£3.90**
  - Twin (side by side with PSU) **£3.95**

## 5 1/4" DISKETTES

Top quality 3M and XIDEX diskettes with a lifetime guarantee. These discs are quiet in operation and insert positively with their reinforced hub rings. Boxes of 10 supplied with disk labels and write protect tabs.

- 10 SCOTCH / 3M + labels S/S S/D **£15**
- 10 SCOTCH / 3M + labels S/S D/D **£17**
- 10 SCOTCH / 3M + labels D/S D/D **£24**
- 10 XIDEX + labels S/S O/D **£15**
- 10 XIDEX + labels D/S O/D **£24**

## DISC ALBUMS

Attractively finished in beige leather-look vinyl, these conveniently store up to 20 discs. Each disc can easily be seen through the clear view pockets.

**£4.25**

## LOCKABLE DISK STORAGE UNITS

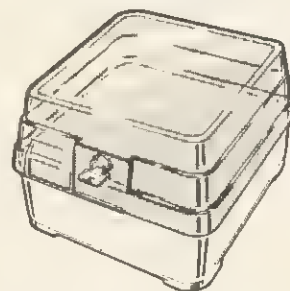

Strong plastic cases that afford real protection to your discs. The smoked top locks down. Dividers and adhesive title strips are supplied for efficient filing of discs.

M35 holds upto 40 discs **£13**

M85 holds upto 95 discs **£18**

## FLOPPY HEAD CLEANER KIT

The heads in a floppy disc drive are precision made and very sensitive to dirt. Drive manufacturers recommend that you clean the heads approximately once a week. Unless your home or office is dust free one of these kits is a very sensible precaution against losing valuable data. A dirty head can destroy many disks before you realise the trouble. Very simple to use.

Only **£14**

## BBC Micro WORD-PROCESSING PACKAGE

A complete word-processing package (which can be heavily modified to your requirements, maintaining the large discount). We supply everything you need to get a BBC micro running as a word-processor. Please call in for a demonstration.

### EXAMPLE PACKAGE

BBC Model B, Watford Electronics' DFS upgrade, WORDWISE ROM, Twin 200k Teac drives in beige, Zenith 12" Hi-resolution monitor (Green or Amber), Brother HR15 daisywheel printer, Gemini software: BEEBCALC spreadsheet, analysis and DATABASE software on disc, 10 x 3M discs, 500 sheets fan-fold paper, 4 way mains trailing socket, manuals, all leads and BBC carrying case.

ONLY **£1,189** (£15 carr.)

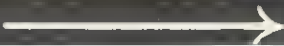

**ACCESS  
HOT LINE  
(0923 50234)  
24 Hours**

Continued 

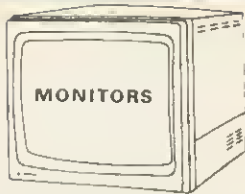

We stock a range of monitors to suit all needs. Choice of a monitor is a matter of personal taste so we recommend that whenever possible, you ask for a demonstration at our shop.

#### MICROVITEC

- 1431 - Medium resolution as used on the BBC television computer programme ... **£165**
- 1451 - High resolution, suitable for word processing in mode D ... **£255**
- 1441 - Super High res, exceeds the capabilities of the BBC micro ... **£385**
- Dust Cover for Microvitecs ... **£5.50**

All Microvitec monitors are 14" RGB in their distinctive right angled case. They come with the connecting lead to the BBC and a mains plug.

#### KAGA

- Standard resolution with RGB and composite video inputs ... **£195**
  - High resolution colour ... **£259**
- Kaga monitors are 12" RGB colour with antiglare screen and user access to screen controls.

#### ZENITH

12" Ultra high resolution monochrome monitor. Ideal for word processing as its green or amber screen is very restful to read. The high resolution makes it good for games too - you can really see the detail that has been put into the graphics. ... **ONLY £68**

#### PHILIP V2001

- 12" Green High resolution ... **£64**

#### LEADS

- BNC Lead for Zenith or Philips ... **£3**
- BNC for Zenith ... **£3**
- RGB lead for KAGA ... **£5**

N.B. Carriage on Monitors **£7** (securicor)

### Versatile **BEEB SPEECH SYNTHESISER** Unit



**SIMPLY the best!** - An unlimited speech synthesis system. Complete with easy-to-follow manual. Controlling software is in ROM so no Cassette Loading problems!

**PHONEMES** for word synthesis - That means unlimited vocabulary! No extra speech dictionary chips to buy!

**BUILT-IN** Library of approximately 500 words to get you started.

**ENGLISH** accent - Utilises inflexion techniques to produce highly comprehensible speech.

**EASY** to use system - Just plug the software ROM into a socket, the Speech unit into the User Port, and away you go! No specialised 'dealer upgrade' required!

**COMPACT** unit - The whole system is built into a small case - easily tucked behind the computer. Auxiliary output socket provided for direct connection to an external amplifier.

**HOURS** of fun! - Suitable for any application - Games, Educational Programs, Specialised Packages.

We know this all seems too good to be true but **DON'T BE LEFT SPEECHLESS!** Order your Versatile Speech Unit now!

**Only £44**

## Best cost less at WATFORD

### WATFORD'S LAUNCH OF THE YEAR APEX

The ultimate expansion system for the BBC microcomputer. It enables you to increase memory capacity to 2+ MEGA8BYTES including 8ATTERY BACKED-UP RAM.

The system consists of a mother board which fits inside the BBC and further daughter cards can be connected externally. The internal card has the following features:

- 15 ROM/RAM sockets, 11 of which can be configured as 2716, 2732, 2764, 27128 EPROMS or ROM equivalent devices or as 6264 RAMs. Any RAM is Automatically battery backed-up and it's contents preserved when the power is turned off.
- The battery is recharged every time the machine is turned on and lasts several months, depending on the number of RAMs fitted.
- There is very little extra current drain, even with a fully loaded board as only the presently active ROM is powered up. In fact the fully populated board uses only 300mA.

- The board reduces micro bus loading by up to three ROM loads, which improves reliability and performance.

- Installation is extremely simple. There is no soldering required. The board is rigidly held by two 40 pin sockets and five support posts. A ribbon cable can be brought outside the computer and up to 8 external cards added. This enables the user to plug-in up to 142 paged ROMs. The cards have following features:

- Each card can accommodate up to 16 devices each of which can be configured as 2716, 2732, 2764, 27128 ROMs or 6264 8K RAMs.

- Battery backup is provided from the internal card.

- Only the active ROM is powered up permitting many external ROMs to be added with very little current loading (100mA per card).

The system comes with controlling software in ROM. The utilities supplied are as follows:

- ★ APEX - replies with the device number currently being accessed.

- ★ APEX C - toggles between the colour and standard black and white messages.

- ★ AL - loads from any device, regardless of the data type.

- ★ AS - saves memory to any specified RAM device.

- ★ AD - prints a directory of the devices present in the system, i.e. ROMs present and files stored. This also reports on the amount of free storage space.

- ★ AF - asks for the free RAM devices.

- ★ LA - repeats the last command to paged ROMs.

**Continued**

- ★ AT - enters a memory testing routine. This will write a test pattern into the memory and read it back out again. If a fault is found, it is reported to the user. This test continues until Escape is pressed.

- RDISC - activates APEX as a filing system which then treats all free APEX RAM in the system as a continuous 'RAM-DISC'. All commands have similar format to the DFS and transfer is possible between the two systems.

The complete computer system bus is available to the user, so that other cards/devices could be added such as EPROM programmers, second processors, Winchester disc drives, clocks, etc. By racking the cards you eliminate the tangled mass of cables that usually accumulates around the micro.

A comprehensive operating manual is supplied with every APEX Board. Please write in for further details and prices.

## THE ULTIMATE DFS FOR BBC MICRO

by

**W@ Watford Electronics**

Highly acclaimed at The ACORN and BBC MICRO USER Shows. What do the independent press say?

Good value for money - *Beebug Aug. '83*  
A very worthwhile package - *The Micro User*  
You'll be buying a very powerful package - *Personal Computer News*

Superior DFS; Excellent disc sector editor - *Computer Answers*

Without a doubt, the most sophisticated DFS Software yet written for BBC Micro Computer. This powerful new DFS is fully compatible with ACORN DFS yet has much increased power due to additions, carefully designed to make life easier in normal use. It consists of over 14K of efficiently written machine code. It is entirely self contained and so does not require a utilities disc to function.

Please write in for full technical specification.

#### PRICES:

DFS (Disc Filing System) ROM **£25**

**Complete Disc Interface Kit including DFS ROM & Fitting instructions £99**

**Disc Filing System Manual.** Comprehensive and clearly written **£7.50 (no VAT)**

P.S. We will exchange your existing ACORN DFS or PACE (AMCOM) DFS for Watford's highly sophisticated 16K DFS ROM for **£19**

Watford's DFS is exclusively available from Watford Electronics. We do NOT retail through any dealers. Every ROM carries a label with our LOGO and a serial number.

#### Now available:

Acorn DFS Kit ... **£99**

### EPROMs & CMOS RAMs

#### NEW LOW PRICES

2764-250nS (BK ROM)	<b>£5.25</b>
27128-250nS (16K ROM)	<b>£19</b>
6116-150nS (2K RAM Low Power)	<b>£5.25</b>
6264-150nS (BK RAM Low Power)	<b>£28</b>



## BEEB PRINTER ROM



"Makes Printing Childs Play"

This utility ROM is designed to simplify using all the facilities of your printer. It has many facilities:

- ★ Selection of printer modes such as underline, font and size is by 'Single Key' operations.
- ★ From Wordwise, a single number following OC will select a mode rather than a long and incomprehensible string of control codes. This makes using your printer with Wordwise much more convenient.
- ★ When using Basic (or other languages) you can have control over the formatting of the output to the printer in the style of a wordprocessor. You can define page top, bottom and side margins etc. with intelligent page skip for binders an option. All supported printers will now respond to form-feed etc. commands.
- ★ User defined characters are printed as you see them on the screen so that non-standard characters are automatically printed out correctly.
- ★ Commands select the options for the following printers:  
GP1DD, STAR, NEC, MX/FX, KAGA, LP/VII/DMP1DD, DMP200.
- Operates with either parallel or serial interfaces.
- ★ Supplied with a 5D page manual that is very comprehensive and easy to follow. Please specify printer type when ordering so that we can send the correct function key strip.

Price: £24

## DUMPOUT 3

A highly sophisticated screen dump ROM. This has to be the most flexible and powerful screen dump ROM yet produced for the BBC micro. It will put on paper anything you see on the screen, including all Mode 7 facilities etc. We have to admit that there is one facility that we cannot replicate - if anyone can supply flashing ink we would like to know!

The ROM also provides window setting facilities and two new OSWDRD calls that allow mode 7 graphics pixels to be read and plotted using the standard graphic co-ordinate system. Two commands are used to operate the dump routines:

- \*GIMAGE - This provides a full graphics dump of any Mode (including Mode 8). There are various optional parameters but you need only specify the parameters you wish to change.
- V <scale>, H <scale> - These 2 byte numbers give fine control over the size of the dump from minute to enormous. Unlike other dump RDMs the scale does not change with mode.
- R <0-3> - Print dump rotated by D.9D, 18D, 270 degrees.
- I <indent> - Set gap from left edge of paper.
- X <min><max>, Y <min><max> - The whole of the screen graphics window area is dumped except when these parameters are given.
- P - Physical colour values are used for plotting, otherwise a negative scale is used (white darkest).
- T Two tone dump for maximum resolution.
- M <mask> - 8 bit colour mask.
- E - Contrast expansion to make mode 7 text and separated graphics stand out from the background.
- C - All mode 7 graphics are printed as contiguous to improve the shading in graphic areas.
- \*TIMAGE <indent> - Does a fast, text only, dump of the contents of the text window in any mode.
- \*GWINDOW and \*TWINDOW - These commands draw the graphics and text windows, respectively, on the screen and allow them to be changed with the cursor keys. N.B. GIMAG and GWINDOW work fully in mode 7.

Designed for use with the following printers: CP80, GP8D, GP100, GP25D, STAR, KAGA/TAXAN, NEC, SHINWA, GEMINI, EPSON MX/RX/FX, LPVII, DMP 1D0/120/20D/4DD, CANON.

Price including comprehensive manual

£22

APPROVED for use with telecommunication systems run by British Telecommunications in accordance with the conditions in the instructions for use.

# MODEM 84

## PRESTEL TERMINAL

For the BBC Microcomputer



The Watford Prestel package allows 8.T. approved connection to Prestel, Micronet and many other 1200/75 baud databases for about the cost of a good tape recorder. Prestel gives you access to an incomparable database covering almost every subject under the sun. There is Micronet with lots of free programs that you can download and run. Details of clubs and user groups, a diary of meetings and exhibitions, news and reviews, technical information etc. There is Homelink with online banking. And there is armchair shopping, travel information, entertainment, world news, sports news, weather information, electronic mail and lots more.

The basic Prestel subscription is only £5 per quarter and at off peak times there is no charge for access time. A local phone call facility means no long distance phone calls to Prestel (approx. phone cost is only 4Dp per hour).

The Watford Prestel package consists of the 8.T. approved Watford MODEM 84 (12DD/75 baud full duplex 12DD baud half duplex direct connect) and a very sophisticated Prestel Terminal ROM.

This totally machine code software:

- is fully compatible with not only the Modem 84 but also with the PRISM 1DD0 and most other modems that require a data link via an RS423/RS232 port making it a worthwhile purchase for those who already have Modems.
- supports full Prestel colour alpha and graphic characters including double height, flashing, conceal/reveal.
- called by simple \*PRESTEL (\*P.) command. Disc and tape configurations fully supported.
- includes a comprehensive telesoftware downloader for BBC and other programs with continuous on screen status report (an essential facility).
- has very powerful OFF LINE MAIL8DX editor allowing colour flashing graphic mailboxes to be prepared without having to be on line to Prestel.
- auto logon sequence can be burnt into RDM if desired.
- a vital 'TAG' facility allows tagging and recall of interesting pages, avoids that common and annoying 'NOW WHERE WAS THAT PAGE' problem.
- includes simple page and program loading and saving functions for both disc and tape, automatically assigning frame and program directories.
- not one but TWO PRINTER DUMP RDUTINES are provided within the software allowing either full graphics dump (mode 7 to EPSON compatible printers) or ASCII characters only.
- a user function built into the software allows interface with specialist routines, (yours as well as ours).

## EPSON DUMP ROM

This screen dump ROM is specifically designed for use with the Epson RX/FX printers and the Kaga KP81D. It is extremely simple to use as there is only one command to remember. It will accurately dump any screen mode using multiple tones as required. Mode 7 is fully supported giving teletext graphics, double height etc. For those who like to keep life simple this EPRDM is only £20.

## FORTH ROM for BBC

This RDM provides a complete implementation of the FIG-FORTH standard (including editor). Supplied with a large tutorial manual at only £33

TINY PASCAL for 88C Micro £59

- All the above facilities are accessed via function keys. An overlay is provided to give comprehensive guidance to key functions.
- A 34 page comprehensive instruction/operating manual is supplied.

## WATFORD'S 1200 BAUD FULLY AUTOMATIC USER TO USER SOFTWARE

Having purchased the WATFORD PRESTEL TERMINAL which includes the 12D0/75 baud MDDEM 84 the addition of the WATFORD user to user ROM based software enables you to discover a whole new world of data communication.

This software enables you to use the MODEM 84 very powerfully.

- Send and receive error checked programs and files (even WORDWISE files) to and from other users at 12DD baud.
- 8k file transfer in under 2.5 minutes (approx four times faster than with 3DD baud modems).
- The transfer of data is totally AUTOMATIC which means that the modem is automatically switched between transmit and receive under software control.
- A chat mode is provided which also has this automatic switching for receive and transmit. (This mode is essential just before and after data transfer when both hand sets are replaced to reduce noise).
- A copy facility is provided which allows transmission of all screen output.
- A continuous on screen modem status report is included.
- The software is totally function key driven enabling easy transmission, reception, saving and loading of programs and files (Basic, Machine code or Data).
- A help menu is available from within the software as an aid to use.
- Full instructions are supplied.

## PRICES

MODEM 84 (with Lead & Manual) .....	£68
MODEM 84 complete with PRESTEL SOFTWARE ROM, Lead and Manuals	£82
PRESTEL SOFTWARE ROM + Manual .....	£20
USER to USER SOFTWARE ROM .....	£15
(Carriage on Modem £2)	

## VIEW

### VIEW WORDPROCESSOR

We are supplying the new VIEW version 2.1 allowing printing of memory contents etc. ... £49

## FX80 PRINTER DRIVER

### Watford's own Sophisticated VIEW Printer Driver for FX80

To simplify using the full facilities of the Epson FX80 or Kaga KP81D use this printer driver. Full facilities are provided for selecting between fonts etc. The disc includes examples of use and instructions. Available on 4D or 8D track disc (please state which required). £6

## VIEW PRINTER DRIVER FOR SILVER REED

(Officially approved by Silver Reed)

A range of VIEW Printer drivers to complement the Silver Reed range of Printers and Typewriters. The View driver allows access to all of the features supported by the range of daisy wheel printers (EXP 770/400/5D0/550). These include underlining, bold, shadow, superscript, and subscript printing. Additionally, you can use proportional spacing on the EXP 770. Owners of one of the typewriters in the range EX 55/44/43, using it as a printer, can also access underlining with these drivers.

The features of each printer/typewriter are accessible from the two highlight codes, which can be redefined at any point within the text. The printer drivers also extend the facilities in View to allow the use of pad characters. The printer driver on disk with a user manual is at a special introductory price of £7.50. Please specify printer type when ordering.

## WATFORD

Continued



## TWO DATABASE MANAGEMENT SYSTEMS

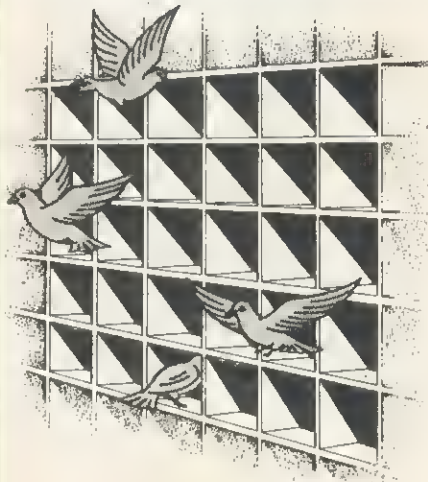

### DISCDATA

Discdata is an entirely disc based database handling system. It is extremely easy to use through its comprehensive menu system. The simplicity is such that we do not feel the need to provide explanation on use in the written guidance supplied with the program. The first-time database user will rapidly become familiar with this package designed throughout to be simple and obvious.

Despite the ease of use this system provides all the facilities needed for complex data handling problems. The length of database that can be handled is only limited by the total space on the disc. You can have up to 2D fields with page length records up to 254 bytes in length. Adding and deleting records, amend titles, field names and records. Sort on any field end search for any record or group of records in any field. The database may be re-formatted after creation, the system will re-write all your files for you automatically. You may add extra fields and extend the length of existing fields freely.

Output formatting is very powerful. You are allowed 4D, 80 or 132 column output modes going to printer or screen. Selected fields can be put in any order on the screen or printer, either across the paper or down. Output can start or stop anywhere in the file. Decimal fields are automatically totalled and records output are counted. Version 2, now on sale has improved input and amendments procedures giving full record edit as well as the 3 extra features . . . String searching, Calculations on numeric fields, and the ability to create sub files from your main files.

On disc at **Only £17**  
(Please specify 40 or 80 track when ordering)

### FILE-PLUS

The File-Plus package is even more powerful and flexible than Disc-Data. It is also largely menu driven but has its own command language for file searching. The 16K ROM contains all the normally required routines, with lesser used options supplied on the utilities disc. All input and output formatting is controlled through screen forms. A full screen editing system is used to define a form which allows tremendous flexibility in the format in which your data is displayed. It is very easy to change from form to form so that you can type in your data with one form, and examine it with others. You will typically design several forms before starting to access the database so that you can quickly and easily see the fields of each record that you want to appear in the layout you decide on. The form system is also used for output to your printer. File Plus has a unique file linking system that allows the entire on-line storage of your system to be used for one database. This can give around 1.5 Megabyte databases using dual drives and double density.

The built in FOL (File-Plus Query Language) can be used for searching the database. Presented in the form of a powerful command language with looping facilities etc. this allows the most flexible access to your data possible. Full arithmetic operations are provided to allow the system to be used for statistical analysis.

Cont.

Operations supported are -, +, \*, /, + - 999999 9999.9999 and compare facilities =, >, <, <=, >=, <, &..

Many keywords are supported by the language: assign, compare, display, end, goto, iff, if, print, read, search, spool and update. Supplied with a very detailed 70 page manual to explain all the facilities with many examples.

**Only £43**

(Please specify 4D or 80 tracks for the utilities disc)

### BUFFER & BACKUP ROM

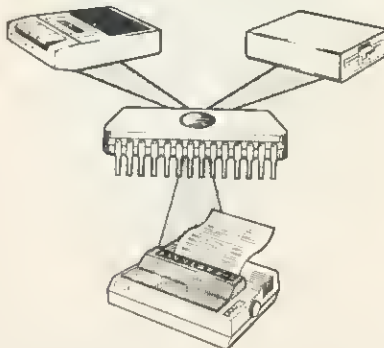

For those with sideways RAM fitted in their machines this utility ROM will make full use of this facility. By using the sideways RAM area for extra memory the following features are implemented:

- ★ 4K or 16K buffer for parallel printer.
- ★ Dumps selection of Disc files to Tape.
- ★ Makes backup copies of tapes on to tape and disc.
- ★ Displays contents of paged RDMs on screen.
- ★ Menu display of ROM filing system contents on Shift-Break.
- ★ Comprehensive manual.

**Only £22**

### DATAGEM

Gemini's 24K ROM based DATABASE Management System  
Special Introductory Offer: **£99**

### PEN PAL - VERSATILE LIGHT PEN SOFTWARE

Do you have a light pen that never gets used? Then this piece of software is for you. This package offers many useful facilities that make the light pen a useful device to own. Facilities included are:

- Pixel, Line and Character definition
- Free hand drawing
- All Colours
- Fill, Refill and stripes
- User defined "Brush strokes" plus character definer
- Grid, Scale and perspective aids 2 to 2DD points palletable in one design with Circles and "rubber banding"
- Move design/character to any screen position
- Save and Load screens, User defined characters and line drawings for video titles, own programmes etc.

This program has many uses in education and at home. It is supplied with a comprehensive instruction manual.

Works with Watford, RH, Acorn User, DIY and many other Light Pens.

Prices  
TAPE **£10**  
DISC (40 or 80) **£11**

### DISC EXECUTOR

Disc Executor is a sophisticated disc utility for the transfer of your cassette programs to disc. If you have difficulties transferring your cassette software to your disc system then this is the answer. It handles 'locked' files and full length adventures (up to &e blocks) and programs that load below &EO. It is very simple to operate with instructions supplied. It saves you time and money.

**Price £10**

(Please specify 40 or 80 track discs)

## ADE

Complete program development package in a 16K ROM. Full assembling and debugging facilities provided.

**SPECIAL OFFER ONLY £43**

### ROM MANAGER

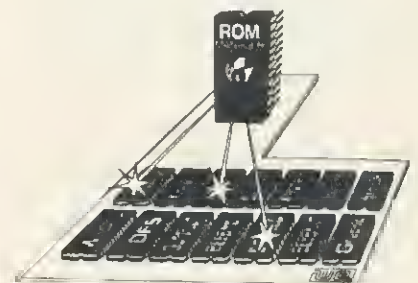

This ROM is unique in its capabilities. It allows you, the user, full control over the BBC Micro's sideways ROM paging system with simple to use commands. This ROM is essential for those with several ROMs. At a simple level ROM MANAGER can be used to remove the problem of clashing command names and allow full use of all the facilities of your ROMs. This is coupled with facilities to completely enable or disable various ROMs in the machine including ROM manager itself.

ROM MANAGER can also be used to develop sideways ROMs using the machine's standard memory. This is achieved by sending sideways ROM calls to your code in RAM, saving the expense of fitting sideways RAM for ROM development purposes. ROM status reports are also given by the ROM, including ROM lengths, checksums, entry points supported and current filing system title.

The ROM also provides facilities to examine ROMs, list function keys for editing, modify RAM (using a HEX/ASCII editor) and list ROM titles neatly and concisely.

The commands given in the ROM:

- **CHECKSUM** - Generates a CRC for a specified RDM (useful for testing suspected faulty ROMs).
  - **DIRECT** - Passes a command directly to a named ROM (overcomes command name clashes).
  - **EXAMINE** - Allows examination of a named RDM.
  - **EXPLAIN** - Gives detailed explanation of the first 22 \*FX codes.
  - **FILE** - Passes a command directly to the current filing system (which normally receives commands after all the ROMs).
  - **FUNCTION** - Lists the contents of the function keys in a form suitable for editing.
  - **INCLUDE** - Allows the main memory to be used for ROM development.
  - **MODIFY** - Memory editing in HEX/ASCII format.
  - **NAMES** - Lists the names and socket numbers of all resident ROMs.
  - **RAM** - Sends command directly to the RAM based ROM routine.
  - **REMOVE** - Removes RAM based ROM option.
  - **SPECIFY** - Selects the default ROM.
  - **DEFAULT** - Sends commands directly to the default ROM without having to give its name.
  - **STDP end \*START** - Disable and enable any named ROM to completely eliminate command word clashes.
  - **STATUS** - Information about all the ROMs fitted in the machine including socket number, name, length, whether it is enabled, whether it has service or language entries etc.
  - **VALUES** - Gives ROM MANAGER status information, such as its socket number, how many ROMs have higher priority, number of default ROM and the identity of the current filing system.
  - **VECTOR** - Same as \*DIRECT, just in case \*DIRECT clashes with another ROM.
- All selection between particular ROMs is by the name of the ROM and this may be abbreviated for convenience. ROM numbers can also be used if required. This RDM is very simple and obvious to use. All the facilities are explained in the clear and detailed manual.

**Price £22**



# BEEB MON

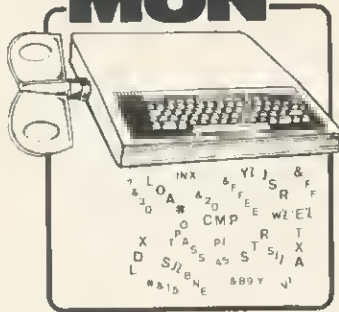

Watford's own Machine code Monitor ROM written by Andrew Bray (Cambridge), co-author of the BBC Micro Advance User Guide.

The most powerful and versatile machine code monitor ROM yet written for BBC Micro. It has all the normal memory editing, moving and relocating facilities, plus all editing is with a full screen editor allowing scrolling up and down memory, entering in Hex, ASCII or standard assembler mnemonics.

In use as a debugging tool, you run code under a total emulation system. Ever felt a desperate urge to set a break point in ROM? No problem - you can even have breakpoint on reading or writing locations in memory and on register contents. The system fully supports debugging of sideways ROMs e.g. BASIC can fully and easily be run from within Beebmon and from there DFS and other sideways ROMs can be used in total emulation mode. Beebmon can even run itself. In so doing you can nest Beebmon up to a level limited only by the memory size. Beebmon uses 256 bytes of workspace, located anywhere in memory, even on the 1MHz Bus. Beebmon effectively uses no zero page workspace, so your program (e.g. BASIC) can use any or all of the base page. How does it achieve this? By providing a 6502 interpreter all programs running under it exist in a virtual BBC, so special memory locations like the ROM latch are not actually accessed by your programs, instead they alter a location in Beebmon's workspace. Emulation also allows immediate return to Beebmon command level by ctrl-escape no matter what code is being executed at the time. All this exceptional power and flexibility is complemented by a clear and detailed manual included in a value for money price of:

£22



Discover the hidden secrets of BASIC and the OPERATING SYSTEM with this easy to use programmers tool. A ROM based machine code Disassembler for the BBC micro. It enables machine code programs to be listed in BASIC/DUMP format and thus is the perfect complement to the built in assembler. It allows Sideways ROMs, files on disk or tape to be listed, and also has a comprehensive editor, allowing mnemonics to be altered directly, as well as HEX, DECIMAL, ASCII and BINARY memory editing. There is also a full set of labelling facilities available (up to 3,200 labels), with the major locations and routines already labelled. Thus DIS-ASM enables any monitor program, such as BEEBMON to be used to much greater effect as it is not necessary to disassemble memory each time the display is altered.

ONLY £18



- COMPUTER CONCEPT'S ROMS**
- CARETAKER Basic Utility      £28
  - Graphics ROM                    £28
  - Disc Doctor ROM                £28



Without doubt a very sophisticated piece of software for the BBC Micro. It has all the features of a professional word processor yet is easy to use.

SPECIAL OFFER THIS MONTH:      £32

## BEEBFONT ROM

BEEBFONT is a remarkable and different concept in BBC software supplied on a 16K ROM. It allows you to display text on the screen in any of the following styles:

ABCDEF GHI JKLMNOP  
 abcdefghijklmnop  
 ABCDEF GHI JKLMNOP

ABCDEFGHIJKLMNPO  
 abcdefghijklmnop  
 ABCDEF GHI JKLMNOP

ABCDEFGHIJKLMNPO  
 abcdefghijklmnop  
 ABCDEF GHI JKLMNOP

ABCDEFGHIJKLMNPO  
 abcdefghijklmnop  
 ABCDEF GHI JKLMNOP

ABCDEFGHIJKLMNPO

It works in modes 0, 1, 2 and 4 using the full colour capabilities of each mode. Characters are printed in the same way as normal. Selection between the various fonts is very easily achieved with Ctrl-V - press this followed by a font number and the output will continue in the new font. Beebfont ROM is particularly useful in display work with the characters produced at twice the normal size.

You can create your own character fonts with the editor supplied. You can also print-out pre-formatted text files using the special characters with Epson FX, RX and NEC printers. The full range of character styles can be used, controlled from within the text. The editor and spooler program are supplied with the package, on cassette or disc. The spooler allows word processor (Wordwise & View) output to be printed in the new characters. A twenty page manual is supplied. Please state printer type and media for the editor & spooler when ordering (cassette, 40 or 80 track disc).

ONLY £39

NEW LAUNCH

## Watford fills the gap with a 32K RAM EXPANSION BOARD

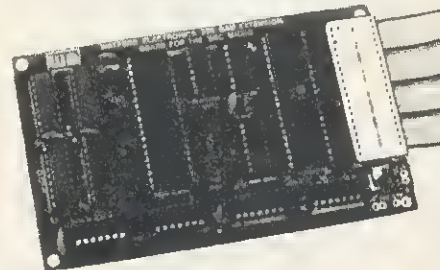

Now Watford Electronics brings you the latest state-of-the-art memory expansion board for your BBC microcomputer. This compact board which fits inside the computer does not just give you 16K or even 20K of extra RAM, but a massive 32K!!!

There are many useful facilities available with this board:

- The top 20K of the expansion RAM can be used as the screen display memory, leaving all the standard BBC RAM free for programs or data storage. This allows good graphics and long programs to be combined. For instance you could have MODE 0/1/2 GRAPHICS AND 28K OF PROGRAM SPACE. The extra memory can be used by virtually any language or utility such as BASIC, VIEW, WORDWISE, etc.
- The full 32K or the bottom 12K of the expansion RAM can be used as a buffer for the printer, sound channels, RS423, keyboard or speech synthesiser. This allows very long text files to be printed while you are using 27K of program and 20K of graphics!
- This board is the ideal complement to any word processing system. There is no need to wait for slow printers as you can type in long text in 80 column display mode while printing is going on - TWO JOBS DONE SIMULTANEOUSLY!!! (an equivalent printer buffer would cost you £115+).
- The board is compatible with a vast range of software and hardware available for the BBC microcomputer, including our ROM expansion board and double density DFS.
- The board is extremely easy to fit. It is supplied complete with a comprehensive manual and ROM based software with full \*HELP messages.

SPECIAL OFFER  
**Only: £69 (carr. £1)**

## GRAPH PAD

With this popular British Micro's Graph-pad, you can add new dimension to your computer enjoyment. It helps you to create your own application programs by the simple use of the Graphpad. Ideal for Educational use. Supplied complete with Cables, Manual and a two program cassette.

SPECIAL OFFER £105

All Prices Exclude VAT

WATFORD

Continued



## SURGE PROTECTOR Plug

Fitted in place of your normal mains plug, this device protects your equipment against mains surges. Nearby lightning strikes, thermostats switching and many other sources put high voltage transient spikes on to the mains. This can lead to data corruption in memory and on disc and can result in spuriously crashing machines. Suitable for computers, Hi-Fi, Fridge Freezers etc. Max. Surge current 2KAmp; max. Voltage 250. Essential for serious computer users.

Protection for only **£8.50**

NEW  
LAUNCH

## SIDEWAYS ZIF

External sideways  
ROM socket



At Watford we haven't forgotten those of you with small budgets, so we've produced a ROM board which takes only one ROM! But don't stop reading - this ROM can be changed in under five seconds without taking the case apart. The SIDEWAYS ZIF eliminates the possibility of damage to your ROMs as zero insertion or extraction force is required when changing ROMs.

Included in the SIDEWAYS ZIF package is a specially designed see through storage container for your ROMs which protects them from mechanical and static damage when not in use. Consider the features:

- Very simple to install, no soldering or modifications to the BBC Micro are required.
- Uses a professional ZERO INSERTION FORCE SOCKET (ZIF) so no force is required changing a ROM.
- No further expense, ROMs are used as supplied without expensive specialised cartridges. The storage box included stores up to 12 ROMs in perfect safety.
- Fits neatly into the existing cartridge slot on the lefthand side of the BBC Micro keyboard.
- The low profile design of the socket gives unrestricted access to the keyboard, unlike other cartridge systems.
- Allows easy installation and changing of Sideways ROMs, all without dismantling your BBC Micro. Once locked in position in the ZIF socket the ROM behaves as a normal sideways ROM.
- No more problems of running out of socket space, simply unplug the ROM and plug a different one in!

A REAL MUST FOR PROFESSIONALS  
AND HOBBYISTS ALIKE  
**ONLY £16**

## BOOKS (No VAT on Books)

30 Programs - BBC Micro .....	£3.25
30 Hour BASIC (BBC Micro) .....	£6.95
35 Education Programs for BBC .....	£6.95
36 Challenging Games for BBC .....	£5.95
40 Educational Programs for BBC .....	£5.95
100 Programs for BBC Micro .....	£6.95
Cassette version of above .....	£10.00
6502 Application Book .....	£11.95
6502 Assembly Language Program ..	£13.95
6502 Assembly Language Subroutines .....	£14.25
6502 Machine Code for Beginners .....	£5.95
6502 Software Design .....	£10.50
A young persons guide to BBC Basic ...	£4.50
Advanced Machine Code Technique for BBC .....	£7.95
<b>Advanced User Guide for BBC Micro</b> .....	£11.95
Advanced Graphics with BBC .....	£9.95
Advanced 6502 Interfacing .....	£10.95
Advanced 6502 Programming .....	£12.45
Assembly Language Programming on BBC Micro .....	£7.95
Advanced Programming Techniques for the BBC Micro .....	£7.95
BBC Basic .....	£7.95
Assembly Lang. Prog. on BBC .....	£7.40
BBC BASIC .....	£5.95
BBC Basic for Beginners .....	£6.95
BBC DIY Robotics & Sensors .....	£6.95
BBC Forth .....	£7.50
BBC Lisp .....	£7.50
BBC Micro An Expert Guide .....	£6.95
BBC Micro Book BASIC Sound & Graphics .....	£7.95
BBC Micro Graphics and Sound .....	£6.95
BBC Micro Programs in Basic .....	£5.95
BBC Micro <b>ROM PAGING</b> System Explained .....	£2.00
BBC Micro Revealed .....	£6.95
BBC Micro Assembly Lang. Prog. ....	£7.95
BBC Micro Disc Companion .....	£7.95
BBC Micro in Education .....	£6.50
Basic Programming on BBC Micro .....	£5.95
Best of PCW Software (BBC) .....	£5.95
CP/M Users Guide .....	£13.95
Creating Adventure Programs on BBC Micros .....	£6.95
Creative Graphics Cassette (Acornsoft). Has 36 graphics programs .....	£8.95
Creative graphics on BBC Micro .....	£7.50
Complete Programmer for BBC .....	£5.95
<b>DISC FILING SYSTEM (DFS)</b> <b>Operating Manual for BBC</b> .....	£6.95
Discover BBC Machine Code .....	£6.95
Discover FORTH .....	£13.95
OIY Robotics & Sensors with BBC .....	£6.95
Further Prog. for BBC Micro .....	£5.95
FORTH Programming .....	£14.40
Functional Forth for the BBC Micro .....	£5.95
Games on your BBC Micro .....	£2.95
Games BBC Computer Can Play .....	£6.95
Graphs & Charts on BBC Micro .....	£7.50
Graphic Art for BBC Computer .....	£5.95
Graphs and Charts (Cassette) .....	£7.50
Graphics on BBC Micro .....	£6.95
Hobbit (Book and Cassette) .....	£14.95
Introducing the BBC Micro .....	£5.95
Introduction to FORTH .....	£9.30
Intro to Micro Beginners Book (3 Ed.) .....	£9.90
Let your BBC teach u to program .....	£6.45
LISP .....	£9.25
Logo Programming .....	£8.95
Mastering VISICALC .....	£12.45
Mastering CP/M .....	£13.65
Micros in the Classroom .....	£4.90
Programming the 6502 .....	£11.95
Programming & Interfacing 6502 .....	£16.00
Programming the BBC Micro .....	£6.95
PASCAL .....	£9.25
Programming for Education on BBC ...	£5.95
Structured Prog. with BBC BASIC .....	£6.50
The Complete FORTH .....	£6.95
The BBC Micro Book, BASIC, SOUND & GRAPHICS .....	£7.40
Using Floppy Disks with BBC Micro .....	£5.95
Using BBC Basic .....	£6.95
Using 6502 Ass. Language .....	£14.50
Wordstar & CP/M made easy .....	£6.95

## PLINTHS FOR BBC MICRO AND PRINTERS

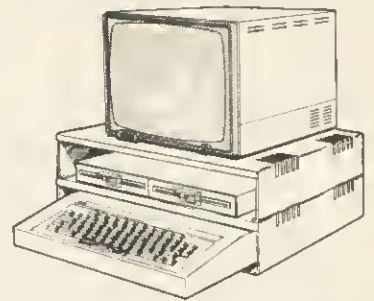

Protect your computer from the weight and heat of your monitor. BBC micro plinths have slots for maximum ventilation. Single height version is suitable for BBC and monitor. Double height version allows the disc drives to be used in the centre section or stationary, etc. The computer slides easily in to place, allowing easy access to remove the lid.

The printer plinth is equally sturdy but without the cooling slots. This allows the paper to be stacked under the plinth with the printer on top - a very convenient way to work as it does not require the usual very deep table.

SINGLE BBC PLINTH	£11 (carr. £1.50)
DOUBLE BBC PLINTH	£20 (carr. £2.00)
PRINTER PLINTH	10 (carr. £1.50)

## 4 WAY MAINS DISTRIBUTION SOCKET

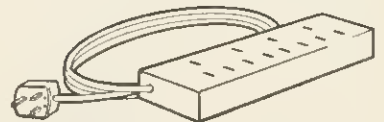

4 way top quality mains trailing sockets. Supplied wired up with mains plug ready for use. Can be screwed to floor or wall if required. Very useful for tidying up all the mains leads from your peripherals. Allows the whole system to be switched on from one plug.

**£9.50**

## ASSORTED CONNECTING LEADS

(All ready made and tested)

CASSETTE LEADS 7 pin DIN Plug to 5 pin DIN Plug + 1 Jack Plug	£2.00
to 3 pin DIN Plug + 1 Jack Plug	£2.00
to 7 pin DIN Plug	£2.50
to 3 Jack Plugs	£2.00
<b>6 pin DIN to 6 pin DIN Plug (RGB)</b>	<b>£2.50</b>

<b>MONITORLEADS</b>	
Microvitec RGB leads 6 pin DIN to 6 pin DIN for colourmonitors	£2.50
KAGA/SANYO Colour Monitor Leads	£5.00
Monochrome monitor leads BNC to Phono	£3.00

<b>DISC DRIVE POWER LEADS</b>	
Supply from BBC power supply to standard Disc Drive connector.	
Single	£3.00
Dual	£3.75

## MISCELLANEOUS CONNECTORS

	Plugs	Sockets
RGB (6 PIN DIN)	30p	45p
RS423 (5 pin Domino)	40p	50p
Cassette (7 pin DIN)	25p	65p
ECONET (5 pin DIN)	20p	30p
Paddles (15 pin 'D')	110p	215p
BBC Power Plug 6 way	80p	-
Disc Drive Plug 4 way	75p	-

## ATTACHE CARRYING CASE for BBC Micro

The Attache carrying case is attractively finished in mottled antique brown leatherette. The case is made of tough plywood, providing a very solid and safe way to carry your BBC micro. There is room provided to fit all the leads necessary behind the computer and manuals in the front. Locks supplied with two keys. Price **£12** (£2 carr.)



## EPROM PROGRAMMER

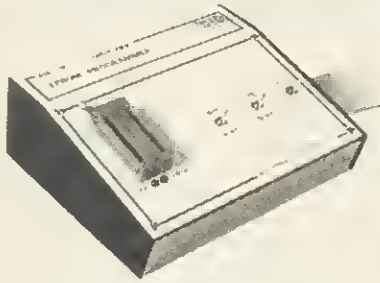

The Watford Electronics EPROM programmer for the BBC micro is a high quality self contained package. Programs all popular EPROMs from 2K to 16K: 2716, 2516, 2532, 2564, 2764 and 27128. All manufacturers' specifications have been followed to program EPROMs at the correct speed - wrong timings could destroy your EPROMs. The unit has its own power supply so does not put heavy loads on the BBC power supply as do some other units. Connects directly to the 1MHz bus following all Acorn recommendations on addressing and bus loadings.

### SOFTWARE PACKAGE

The software is supplied on an EPROM which plugs into the Micro and is instantly available with a single command (no time wasting as on Cassette/disc loading). It is a fully purpose designed and integrated package to simplify ROM development. The system is menu driven with many prompts to avoid any accidents.

### Software facilities include:

Load File - Save File - Down Load EPROM - Program EPROM - Verify - Blank Check - Editing of memory contents prior to programming.

Also included is an automatic system to allow Basic programs to be put in EPROM and accessed through the \*ROM filing system. More than one program may be put in an EPROM. All these facilities and more are explained in the comprehensive and clear 15 page manual.

ONLY £79 (£3 carr.)

## TEX EPROM ERASERS

EPROMs need careful treatment if they are to survive their expected lifetime. Over erasure of EPROMs very rapidly turns them into ROMs! The TEX erasers operate following the manufacturers specifications to give the maximum possible working life by not erasing too fast. We use these erasers for all our own erasing work.

- ERASER EB - Standard version erases up to 16 chips. £28
- ERASER GT - Deluxe version erases up to 28 chips. Has automatic safety cut-off to switch off the UV lamp when opened. £30
- Spare UV tubes. £9

## VOLTMACE DELTA 14 JOYSTICK SYSTEM

The Voltmace system provides full facilities for connecting the Delta 14 handset.

Delta 14 handset - On its own makes a high quality centre sprung analogue joystick with fire buttons. £12.50

Adaptor Module allows use of two joysticks and provides hardware to access all the keys on the keypad of the joystick. £12.55

Transfer program allows use of the keypad keys and joystick to simulate any key on the keyboard. This works by creating a machine code patch that stays in memory while another program is loaded in. Allows any game to be used with joysticks. Supplied on disc or tape.

Tape £5.10 Disc £7.95

## STANDARD JOYSTICKS

These are standard analogue type with a fire button on each joystick. Twin joysticks go to a single moulded plug, long leads provided.

Single Player version £7.00  
Two Players version £12.00

## MK 2 13 ROM SOCKET EXPANSION BOARD

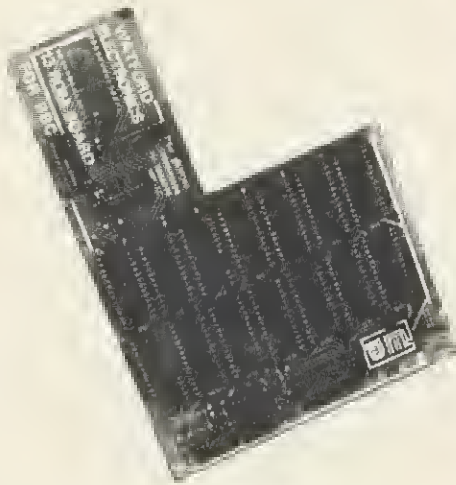

Now all lines fully buffered - On board battery back-up facility - will now accept EPROMS 2716, 2732, 2764 & 27128 and ROMs 6116 & 6264.

Simply plugs into one of the four ROM sockets currently available in BBC Micro. There are only 5 solder connections to be made. Full instructions are supplied. This board has been ergonomically designed to enable the user, easy further expansion inside the Micro, e.g. Double Density Board, Torch Board, etc. (At Watford, we think ahead.)

Our Mk2 13 ROM Socket Board enables the User to increase the sideways ROM capacity from the basic 4 sockets upto full 16 capable of being supported by current operating systems. In addition the board is designed with the facility to hold upto 16K RAM, which when switched into operation is automatically selected by any WRITE signal to the Sideways ROM area. This gives the User the ability to write a utility or language and upon pressing break have the utility or language up and running (new ROM software can be developed and tested in situ.)

The Board gives the User, plenty of freedom to explore the possibilities of the new paged ROMs due in the coming months and offers them the chance to develop their own.

All lines are fully buffered and the Board meets or exceeds all timings for operation in the BBC Microcomputer. When fully populated, the ROM Board consumes less than half the recommended maximum current limit.

Supplied ready-built and tested complete with fitting instructions.

ONLY £32.50 (carr. £1)

## THE INVESTIGATOR

A utility program provided on disc to make security backup copies of all your valuable discs. Makes full use of all B271 facilities to discover the precise format of your protected disc so that an exact copy can be produced. Supplied with detailed instructions. Please specify 4D or B0 track disc when ordering. Price £25

## LIGHT PEN



This Light Pen for the BBC micro is packaged in a neat pen shape with built in switch. Supplied complete with our sophisticated Pen-Pal software on cassette (see elsewhere in this ad).

Only £20

(For software on disc please add £2)

## DATA RECORDER AND ACCESSORIES

Top quality slimline portable cassette recorder designed specifically for use with home computers. Mains/Battery operated with tape counter.

£20

DATA CABLE to connect recorder to BBC

£2.50

DATA CASSETTES - Top grade tested C12 Data cassettes supplied in library cases 35p

## MISCELLANEOUS

28 pin DIL PLUG

Solder type £1.85

IDC Crimp type £2.90

28 pin ZIF SOCKET (Textool) £7.50

34 way Ribbon Cable £0.60/foot

B way DIP SWITCH £0.87

## ANTI GLARE MONITOR SAFETY SCREEN



HEADACHES? TIRED EYES? Don't take pills - Use a Watford Electronics anti-glare filter!

Considerable research into the possible health problems associated with monitor screens has shown that eye strain, blurred vision, watering, itching eyes and headaches can result after prolonged use. The problems are caused by extraneous reflections which force the eye to continuously re-focus to try to ignore them. The answer is our contrast enhancement, anti-glare filter which is similar to those which have been previously available on business systems, but at the low cost that you would expect for your personal computer. You will soon find the reduction in eye strain well worth your investment.

### Features:

- Simple fitting with sticky Velcro pads.
  - Easily removed for cleaning.
  - Tinting improves colour quality and contrast.
  - Works on monochrome or colour monitors.
  - Curved instead of usual flat screen reduces edge distortion.
  - Made in Britain by a long established glass maker.
- Available in 9", 12" and 14" versions - please specify when ordering.

Introductory offer price: £14.95 (carr. £1)

Prices subject to change without notice and available on request.

MAIL ORDER AND RETAIL SHOP. TRADE AND EXPORT INQUIRIES WELCOME. GOVERNMENT AND EDUCATIONAL ESTABLISHMENTS OFFICIAL ORDERS ACCEPTED. CARRIAGE: Unless stated otherwise, please add 75p to all cash orders.

VAT: UK customers please add 15% VAT to the total cost incl. Carriage.

SHOP HOURS: 9.00am to 6.00pm. Monday to Saturday. (Ample Free Car Parking Spaces)

ACCESS ORDERS: Simply phone: Watford (0923) 50234. (24 Hours)



# Watford Electronics

Dept. ACORN, 250, HIGH STREET, WATFORD, ENGLAND.  
Telephone: 0923 40588/37774. Telex: 8956095

**SEE THEM  
LIVE!  
SEE THEM IN  
ACTION!**

Explore Pace's  
state-of-the-art  
E-net Classroom

**NETWORKING**

All your questions  
answered by  
the experts

Link into  
Micronet and  
other giant databases

**COMMUNICATIONS**

Dial Knowledge Index  
in the USA - direct  
from the Show

**ELECTRON &**

**BBC MICRO**

**USER SHOW**

Communications and networking are the twin themes that are creating the greatest interest among users of microcomputers. In special presentations at the October Electron & BBC Micro User Show we unveil the mysteries and show how your computer at home can send and receive messages from all parts of the world.

Alexandra Palace, London N22

Thursday to Sunday,  
October 25 to 28

**This voucher is worth £1 per head**

**Reduced prices for  
School/College  
Groups**

Entry only £1 per student if  
bookings are made in  
advance. Send your cheque  
(made payable to Database  
Publications) and SAE to:

Electron & BBC Micro User Show  
68 Chester Road, Hazel Grove,  
Stockport SK7 5NY  
Tel: 061 456 8383

Valid for a minimum of 10 people

**SAVE MONEY with  
our Special Travel  
and Hotel Offer**

Visitors to the Show can obtain  
cut-price rail tickets from ANY  
station in the United Kingdom  
- plus special reduced prices  
at London hotels. Write to:

Travel Offer, P.O. Box 1, St  
Albans AL1 4ED with SAE or  
Telephone St Albans 34475  
quoting The Electron & BBC  
Micro User Show

**ELECTRON &  
BBC MICRO  
USER SHOW**

By handing in this voucher  
at the door you save £1 off  
the normal admission  
price of £3 (adults) and  
£2 (children).

(Valid for a maximum of 4 people)  
(Only 1 voucher per person)

10am-5pm, Thursday, 25 October  
10am-5pm, Friday, 26 October  
10am-5pm, Saturday, 27 October  
10am-4pm, Sunday, 28 October

**Alexandra Palace  
Wood Green, London N22.**

Number attending  1  2  3  4

AU11



# CO-ORDINATED MOVES

It's easy on the Beeb and Electron to draw shapes on-screen and then assemble them, says Tessie Revivis

Two aspects of the Electron and BBC micro set these machines apart from many of their contemporaries. These are the ability to produce graphics using simple and clear commands and the ability to allow sections of programs to be called by a name assigned to them and also allowing numeric values and strings to be passed into them. In First Byte this month we'll examine these features, and lay down the foundations for the construction of a simple but effective computer aided design (CAD) package.

Both Acorn micros have what are termed graphics screens - in fact they have a total of five graphics screens, which differ in that they use varying amounts of memory and that only a set number of colours are available in each one. Selecting a particular graphics screen is performed using the command:

```
MODE n
```

where n is the number of the mode. Table 1 details the colours and amount of memory used by each screen mode. We can see from it that the 16 colours implemented on the Electron and Beeb are available all at once only in mode 2.

To allow lines to be drawn on the screen two commands are provided: MOVE and DRAW. If we imagine that we have an imaginary graphics pen the MOVE command moves it to a specific point on the screen (as though poised over a piece of paper), while the DRAW command puts the graphics pen on the 'paper' and draws a line from its current position to another specified position. A particular point on the graphics screen is specified by using a co-ordinate system. The screen is divided off horizontally and vertically into lines, like a page of graph paper. The vertical lines, termed the Y axis, are numbered

from 0 to 1023. The horizontal lines are numbered 0 to 1279 from left to right, and termed the X axis. Thus any position on the screen can be specified or defined by its X, Y co-ordinates. The point 100, 100, for example, is found by moving 100 points along the X axis and then 100 points up the Y axis.

Figure 1 illustrates the co-ordinates for each corner of the screen. The bottom left-hand corner has the co-ordinates 0,0 and this is referred to as the origin, as every movement we make will be referenced from this point.

If we want to move the graphics pen to the co-ordinates 100,100 we use a line like this:

```
20 MOVE 100,100
```

However, before running a graphics program we must remember to select the desired graphics mode, so the preceding line 10 might read:

```
10 MODE 2
```

If we want to draw a line across the screen from this point the X,Y co-ordinates of the end of the desired line must be specified as part of the DRAW command, thus we could add the line:

```
30 DRAW 1000,100
```

Running the three-line program would cause a white line to be displayed on the lower portion of the screen.

By combining sequences of DRAW commands it is possible to construct shapes. A square or rectangle is simply four lines, each at a right angle to the previous one. A simple rectangle drawing program would be:

```
10 REM Square
20 MODE 2
30 MOVE 100,100
40 DRAW 1000,100
50 DRAW 1000,1000
60 DRAW 100,1000
70 DRAW 100,100
```

As you can see, we require only one initial MOVE statement to set up the starting position of our imaginary graphics pen. At the end of each DRAW command the pen will be correctly positioned. Figure 2 charts each DRAW movement. Note also how the last DRAW command in line 70 returns the graphics pen to its original position.

Often when writing a Basic program sections are repeated several times. If these are quite short, perhaps just a couple of lines, it is easy to type them in wherever they are needed. But if the repeated items are longer entering them several times is laborious and eats away the micro's memory.

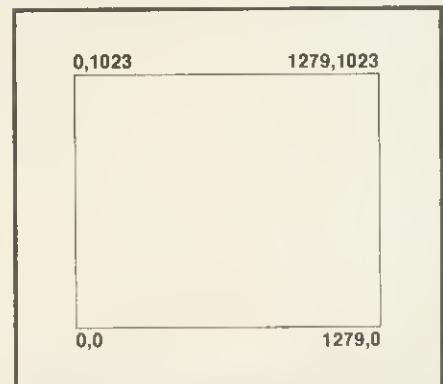

Figure 1. Co-ordinates of each screen corner

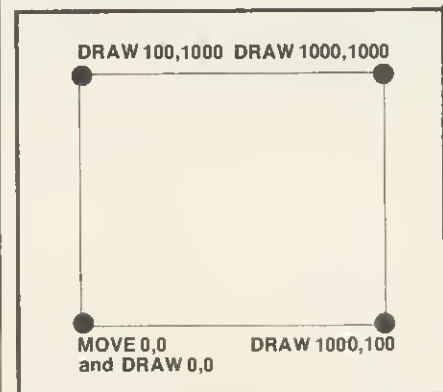

Figure 2. The DRAW stages

Consider the rectangle program. Suppose we wanted to draw this four times on the screen. We could enter the listing four times, but a much better programming technique would be to define the rectangle-drawing program as a named procedure and then call

Tessie Revivis' car-drawing program (listing 1) is presented on yellow page 100



## £11.49 OR LESS. HOW'S THAT FOR STARTERS?

Everything you need to organise yourself and to operate and maintain your computer – cassette storage, programming, cleaning – all together in one complete kit.

The Rexel Home Computer Starter Kit is put together by experts to help you get the very best out of your micro, especially if you are starting on the exciting business of creating your own programs.

Compatible with every cassette driven micro, it is available now at W.H.Smith, John Menzies and other leading suppliers. And at £11.49 or less, it's an absolute gift.

Also look out for the range of Rexel Computer Care and Maintenance products. Prices start from £3.50. You couldn't have a better start than that.

For more information on the Rexel Computer Care products, write to:

Rexel Ltd, Gatehouse Road, Aylesbury, Bucks. HP19 3DT

Cassette binder supplied without cassettes



**REXEL**  
COMPUTER SUPPLIES

**TAKE A CLOSER LOOK AT REXEL**



it four times. The name-defining sequence is performed using the two statements DEF PROCxxxx, where xxxx is the name (it could be of any length) we wish to give that procedure. DEF

## 'Producing routines in this way enables you to build up a procedures library'

PROC is short for DEFine PROCedure. To call the procedure 'rectangle', therefore, the listing would become:

```
1000 DEF PROCrectangle
1010 MOVE 100,100
1020 DRAW 1000,100
1030 DRAW 1000,1000
1040 DRAW 100,1000
1050 DRAW 100,100
1060 ENDPROC
```

To terminate the procedure the command ENDPROC is used (line 1060). You'll have noticed that I have now used higher line-numbers for the procedural definition. This is standard practice as procedures are normally placed towards the end of a program listing. To test the procedure it can be called simply by specifying the PROC and its name. Add the following lines:

```
10 REM PROC demo
20 MODE 2
30 PROCrectangle
40 END
```

The END command in line 40 is important as it stops the program running into the procedure definition and trying to re-execute it. Run the program to see the rectangle drawn on the screen.

To draw the rectangle four times the PROCrectangle statement can be put into the program four times, but there's a problem. The parameters (references) for the MOVE and DRAW commands within the procedure are fixed and cannot be changed, so the rectangle will be drawn in the same position each time. To avoid this we specify the parameters of each command as variables. Thus lines 1010 to 1050 become:

```
1010 MOVE X%,Y%
1020 DRAW X1%,Y1%
1030 DRAW X2%,Y2%
1040 DRAW X3%,Y3%
1050 DRAW X%,Y%
```

Looking at the above listing we see that we need a total of eight variables (the starting point is the same as the completion point). The next step is to specify each of these variables in the

DEF PROC line so that the computer knows that it must put values into them. Line 1000 therefore becomes:

```
1000 DEF PROCrectangle (X%,Y%,
X1%,Y1%,X2%,Y2%,X3%,Y3%)
```

The PROC calling line can be used in the same way by placing the values to be passed into each variable within brackets, thus:

```
30 PROCrectangle (100,100,1000,100,
1000,1000,100,1000)
```

Now when the program is run the eight numeric values above will be passed into the eight variables in line 1000.

This approach is still a bit untidy and can be cleaned up. To produce a rectangle all we really need to pass into the procedure is the MOVE coordinates and then the length of two adjacent sides. We can then let the procedure do the donkey work. So the final program to draw the four rectangles looks like this:

```
10 REM Four Rectangles
20 MODE 2
30 PROCrectangle (100,100,300,
300)
40 PROCrectangle (100,600,200,
300)
50 PROCrectangle (600,100,250,
350)
60 PROCrectangle (600,600,350,
350)
70 END
80 :
1000 DEF PROCrectangle (X%,Y%,
XS%,YS%)
1010 MOVE X%,Y%
1020 DRAW X% + XS%,Y%
1030 DRAW X% + XS%,Y% + YS%
1040 DRAW X%,Y% + YS%
1050 DRAW X%,Y%
1060 ENDPROC
```

One of the useful aspects of producing routines in this way is that it enables you to build up a procedures library. Just save each PROC to tape as you design it and then load it in as and when required.

Mode	Memory required	No of colours available
0	20k	2
1	20k	4
2	20k	16
4	10k	2
5	10k	4

Table 1. Colour and memory details

Listing 1 provides a variety of procedures that will perform the following:

- PROCrectangle - draw a rectangle
- PROCTriangle - draw a triangle
- PROCcircle - draw a circle
- PROCfillrec - draw and fill in a rectangle
- PROCfilltri - draw and fill in a triangle
- PROCfillcir - fill in an already drawn circle

The controlling program uses these calls to draw a car in multi colours like

## 'We can then let the procedure do the donkey work'

the one in figure 3. These procedures will be explained in full next month, but for the time being see if you can use them to draw your own designs.

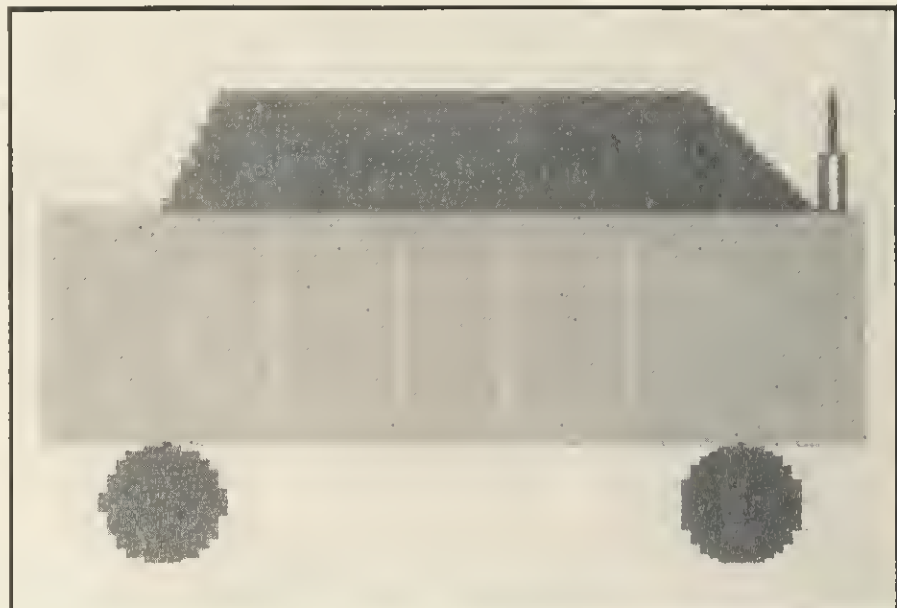

Figure 3. CALL me a car! - assembled from simple rectangle, triangle and circle routines

**If you're involved with education,  
then you're involved  
with hi-technology and computers.**

**THE  
HI-TECHNOLOGY  
AND  
COMPUTERS  
IN  
EDUCATION**

**Exhibition**

**23-26 January, 1985**

**BARBICAN CENTRE, LONDON EC2**

**The face of education is  
changing, monitors are replacing  
blackboards, light pens are  
replacing chalk.**

As an educationalist take an opportunity to get right up to date with everything that's new in high technology and computers in education. The new techniques aren't only for the science labs or computer classes, they cover all aspects of the schools curriculum, from geography to physical training.

This exhibition, the first of its kind, is a definitive showcase for both manufacturers and users alike. You can see the best the



world has to offer, compare specifications and collect literature away from the bustle of day to day activities.

Entrance is free to anyone working in education and over 18 years of age. Just clip the coupon below. (To be completely up-to-date, book into the series of half-day seminar/workshops organised alongside the exhibition in co-operation with the Microelectronics Education Programme. For details of these and a booking form, tick the box on the coupon below.)

Timothy Collins,  
Computer Marketplace (Exhibitions) Ltd.,  
20 Orange Street,  
London WC2H 7ED

To: Timothy Collins, Computer Marketplace (Exhibitions) Ltd 20 Orange Street, London WC2H 7ED.

Please send me details of the seminar/workshops

Please send me my free ticket(s) to the Hi-Technology and Computers In Education Exhibition,

Quantity \_\_\_\_\_ Name \_\_\_\_\_

Establishment \_\_\_\_\_

Address \_\_\_\_\_

Postcode \_\_\_\_\_

Telephone \_\_\_\_\_

For details  
of discount rail  
travel. P.O. Box 1  
St. Albans AL1 4ED  
Telephone (0727)  
37799





## Can I convert my TV into a monitor?

CAN a colour TV be modified to act as a monitor, asks Mr Wilson of Bordon. 'As the current price of colour monitors is so high,' he writes, 'and as I already have a second-hand colour television, I was wondering whether it is possible to modify it to improve the picture quality. With a video monitor there is no tuner, sound and vision detection, or sound amplification circuitry. If I understand correctly, using a TV with a micro means that the micro output is first modulated, and then demodulated. Is this why the image begins to lack stability?

'I have noticed recently a variety of combined monitor/TV sets in several stores. Is this combination achieved by switching off the unwanted circuitry, and if so could the same thing be achieved simply at home, or is there something more complex involved?'

A simple answer is that a television could be modified to work as a monitor, and there would be some improvement in picture quality for the reason Mr Wilson has suggested. But – and it is a big but – it is not a simple task, and the gains in picture quality are not great, for several reasons.

First the picture tube in a TV is not the same as that in a monitor which generally has a better resolution screen and with an anti-glare coating, so even if a television is modified the picture quality is still not as good.

Second, new colour TVs (within the last two to four years) have isolating transformers fitted, as do monitors. Older televisions have a chassis, which could become live under certain fault conditions. Should this occur while the computer was plugged into an unprotected monitor socket the computer could be badly damaged. So you'd have to fit an isolating transformer or circuitry onto the monitor socket.

Thirdly, earlier colour TVs (10 or

## Martin Phillips advises on TV modification, polishing programs, joystick commands, 3D printing, cassette care – and draws a house

more years old) have picture tubes which emit undesirably high levels of radiation. These are not to be recommended for close viewing with a computer.

Lastly, the internal circuitry of televisions and monitors has improved considerably in the last few years, and this too has contributed to a better picture. Older TVs often need realigning to restore their original picture quality, and this in itself is not a job for the unskilled.

In short, unless television circuits are something with which you are familiar, don't try to alter an old set. (There are some high voltages in a colour TV which can be dangerous.) It is a false economy as colour monitors that should give years of trouble-free use are coming down in price all the time and their cost compares well with a new colour TV. As an alternative, the monitor/TV sets now in the shops seem to be a good buy, although I would like to take my computer into the shop and try it out on one before buying it!

## Special effects

ROBIN SASSON from Slough has sent in a series of VDU23 commands (figure 1). As far as I can see they have no practical use (sorry Robin!), but they are fun. Most will only work on the BBC in mode 7.

## Perfecting

## your programs

SETTING a time limit using the INKEY statement in a tables testing program for his son caused problems for Mr Tate of Henley-on-Thames. His program is given in listing 1. I have sorted out his query, and then polished it stage by

```
VDU23; 1; 0; 0; 0;
VDU23; 2; 0; 0; 0;
VDU23; 4; 0; 0; 0;
VDU23; 7; 0; 0; 0;
VDU23; 8; 0; 0; 0;
VDU23; 9; 0; 0; 0;
VDU23; 100; 0; 0; 0;
VDU23; 106; 0; 0; 0;
VDU23; 996; 0; 0; 0;
VDU23; 998; 0; 0; 0;
VDU23; 999; 0; 0; 0;
VDU23; 1000; 0; 0; 0;
VDU23; 9000; 0; 0; 0;
VDU23; 16013; 0; 0; 0;
VDU23; 19014; 0; 0; 0;
```

Figure 1. VDU commands from Robin Sasson. Try the effects

stage from the working program.

I know many users wish they could perfect a program, and when you first start this takes a long time, but it is surprising how you speed up with practice. Eventually you realise a perfect program is unattainable as there is always something more to be added or improved. What makes the task harder is the variety of solutions to a problem, and the 'best' way is often a matter of personal choice. page 47 ▶

Listings 1-4 (multiplication table tests) are presented on yellow page 101 and 102

IF YOU have a technical hitch or a programming problem let Martin Phillips give his diagnosis. We'll pay £5 if you raise a really interesting point. Please give full details of the system you're using and include a listing where appropriate, making your question as specific as possible. WRITE TO: Hints & Tips, Acorn User, Redwood Publishing, 68 Long Acre, London WC2E 9JH.





Listing 2 shows the first changes made to the program. Line 260 has been shortened as the latter part of the line did not accomplish much, since the program would still wait for an input at line 270. Then three procedures were introduced: PROCright, PROCwrong, and PROCtimeout. This made the program easier to read, and the responses for a correct or incorrect answer could be improved with ease within each procedure.

Next I changed the position of the time test to after the right or wrong response. This way the child would know whether the answer was right or wrong even if he or she was out of time. Here I made a mental note to include an out-of-time result with the score. Also the instruction lines were altered to cater for the changes in the input routine.

It was interesting to note that the introduction of the three procedures meant that two repetitions of A=INKEY(200):GOTO 190 were redundant. They also avoided the need for long multi-statement lines, which would quickly have become cumbersome if extra effects were to be included.

Listing 3 shows the next round of alterations. First a REPEAT...UNTIL loop was put in instead of a GOTO, making the program easier to follow. Then the results phase of the program was put into a procedure. (Some would tut-tut at having more than one ENDPROC in a procedure; the way round this is to use GOTO 560 and just retain one ENDPROC.) Now it was possible to take account of the excess time taken and print it out if necessary. One second extra was allowed for each answer before printing an out-of-time message to avoid having silly responses such as '...but took 0.02 seconds too long'.

Next the RND routines that filter out the number 1 were simplified, and I changed the maximum multiplier from 12 to 10. The need to learn up to the 12 times table disappeared in the early seventies when decimal money was introduced and schools started teaching measurement only in centimetres and metres instead of feet and inches. When writing an educational program it is necessary to look carefully at such aspects of the work being covered. However, it is surprising the number of teachers who still insist on teaching up to the twelve times table.

Listing 4 shows the final stage. The line of the program that displayed the question was printed in double-height, as was the answer. At this stage the program might seem perfect, but alas the changes introduced have made yet more problems. It is possible, for instance, to have '...but took 1 seconds too long', so there needs to be

a line to check if the excess time is just 1 second and print an appropriate message. Perhaps the easiest way is to ignore a time excess of less than two seconds on the total. Then there are the sound effects to add....

## Mystery chip

A MISSING ROM socket was the problem of Simon Matterface from London, who writes, 'In all the books and magazines I've read, they say that the BBC micro should have three paged ROM sockets, but alas I have only two! I purchased a *Wordwise* wordprocessor ROM, and on taking off the cover and keyboard I found I had only two spare sockets. Not knowing what this extra chip was I tried to take it out, but I could not as it was soldered in place! The chip is totally blank. Can you suggest what I should do?'

No standard BBC has, to the best of my knowledge, ever had a chip soldered in place of any ROM sockets, so I would guess that Simon bought his micro second-hand. So what is the chip and why should it need to be soldered into the socket? Even if it becomes damaged, it is better to fit a new socket.

The only explanation I can think of was suggested by something I read last year (*Acorn User*, October 1983, News in Brief), about an EPROM that was plugged into one of the ROM sockets which disabled the computer until a five-digit security code was entered. It also caused the owner's name and address to appear when switched on. This was a good idea, but all too easy to unplug, so they were probably soldered in place. The only snag here is that as an EPROM can be erased in ultraviolet light, the chip could be wiped clean and the computer would work perfectly well without it. In other words, leave it on a windowsill in strong sunlight for a few hours and all security is lost. The result: one blank EPROM soldered into the circuit board doing nothing.

## Joystick tester

THE ADVAL commands that control the left and right joysticks have been requested by Robin Sasson. This was covered in this column last February but for the benefit of Robin and the many new Electron users who have just bought the Plus-1 interface and wish to

use joysticks, and any new BBC owners, here is a tester for joysticks to check if they are wired correctly. It also shows how they are read using the ADVAL statement. The BBC and Electron (with Plus-1) use the same commands and, as far as joysticks are concerned, the analogue port wiring is the same.

The Acorn joysticks do not operate quite as expected. Moving the joystick to the left in the horizontal axis increases the voltage to the analogue socket, rather than reducing it as one would expect. Figure 2 shows the

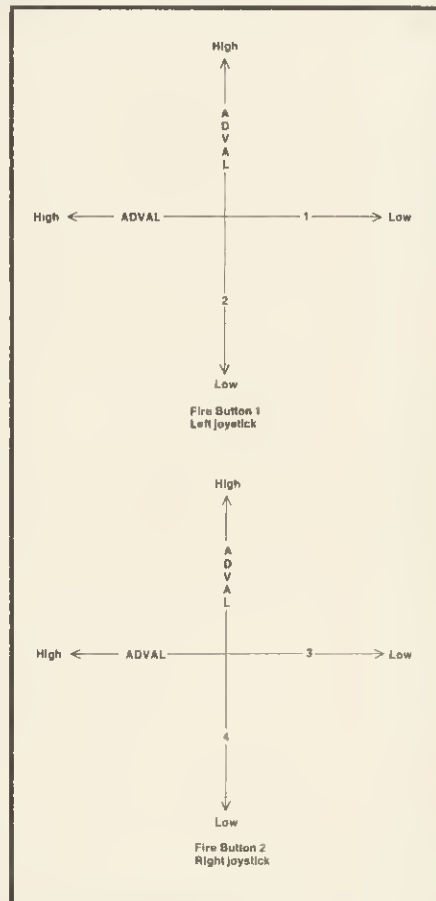

Figure 2. The correct connections for Acorn joysticks

correct connections for Acorn joysticks.

Listing 5 gives a short program to display the ADVAL readings for either joystick, and can help to distinguish left and right joysticks (why are they often not labelled?). It can also be used to check for non-standard joysticks, or simply to see that the joystick works correctly.

Do not worry if yours will not reach the maximum or minimum values (65536 and 0); they seldom do! Any value within 100 of these is usually satisfactory. On my Electron with Plus-1, the values were in the range 65280 and 0 with my pair of joysticks; 65280 is the maximum value the analogue port will

# BBC Computer 52K

*Solve your problems in 5 minutes with the...*

# RAVEN-20

## **Features include...**

- PROVIDES 20K OF USABLE RAM
- COMPLETELY TRANSPARENT TO BBC OPERATING SYSTEM
- ALLOWS THE RUNNING OF PROGRAMS UP TO 28K LONG IN ANY SCREEN MODE
- NO SOLDERING OR CUTTING OF TRACKS
- RAVEN 20 IS COMPATIBLE WITH ALL CORRECTLY WRITTEN SOFTWARE
- USES ONLY DOCUMENTED MOS CALLS
- SIMPLE PLUG IN AND GO DESIGN
- LOW POWER DYNAMIC RAM DESIGN
- SELF TEST FACILITY
- SPECIAL COMMANDS FOR SOFTWARE WRITERS
- COMPLETE WITH ROM BASED SOFTWARE
- CAN BE FITTED TO BBC MODEL B FITTED WITH OS 1.2

**THE ULTIMATE IN  
DESIGN & PRICE**

**ONLY  
£69.95  
INC VAT**

**RAVEN MICRO PRODUCTS**

**1 SAVILLE ROAD · WESTWOOD · PETERBOROUGH PE3 7PR · TEL 0733 260930**



give on the Electron, the maximum on the BBC being 65536. The BBC analogue port has a resolution 16 times better than the Electron with Plus-1. This means that it reads in steps of 16, whereas the Electron reads in steps of 256. However, the accuracy of the BBC's analogue port is a little suspect, and it is better to read the resolution in steps of 32 or 64 in the following way:

```
X = ADVAL(1) DIV 32
or X = ADVAL(1) DIV 64
```

Programming the Electron's analogue port is the same as programming the BBC's, although it is slower in operation.

If you have non-standard joysticks they can be altered, provided the cases can be opened. It is usually the horizontal movement potentiometer that is wired incorrectly. Check which potentiometer moves when the joystick is pulled horizontally (or vertically if that one is wrong). There are three solder tags on the potentiometer with wires on each. Leave the wire on the middle of the three tags and unsolder the wires on each end solder tag, swap them round and resolder. The potentiometers are not particularly heat-sensitive and this task is not very difficult. Unplug the joysticks from the computer before opening the case to avoid damaging the analogue-to-digital converter chip.

## Three-dimensional

### printing

HERE IS a procedure to give the effect of three-dimensional printing (listing 6). It works only in the BBC or Electron's graphics modes (modes 0, 1, 2, 4 and 5), by joining the text and graphics cursors using the VDU 5 command. Once the two cursors have been joined, printing can be positioned on the screen at any point determined by the last MOVE, DRAW or PLOT statement. In this case the print is placed on the screen twice, the second just overlapping the first. The 3D effect is achieved by printing in different colours. The procedure parameters define the screen position, the string to be printed and the first and second colour numbers.

## Reinstating the

### cursor

IN AUGUST'S column I mentioned that the cursor could be switched off using

```
VDU23;8202;0;0;0;
```

```
10 REM listing 5
20 REM Joystick tester
30 @%=15
40 INPUT"LEFT(0) OR RIGHT(1) "J%
50 IF J%<0 OR J%>1 THEN GOTO 30
>0 REPEAT
70 X=0:Y=0
80 FOR N=1 TO 100
90 X=X+ADVAL(1+2*J%)
100 Y=Y+ADVAL(2+2*J%)
110 NEXT N
120 IF J%=0 THEN PRINT"LEFT JOYSTICK: ";
130 IF J%=1 THEN PRINT"RIGHT JOYSTICK: ";
140 PRINT "X=";INT(X/100),"Y=";INT(Y/100)
150 UNTIL 0
```

Listing 5. Displays the ADVAL readings for left and right joystick

```
10 REM Listing 6
20 MODE 2
30 VDU19,0,4,0,0,0
40 PROC3d(352,900,"3D TITLES",3,1)
50 END
60 :
100 DEFPROC3d(X,Y,A$,col1,col2)
110 REM X values in range 0-1279
120 REM Y values in range 0-1023
130 VDU5
140 MOVE X-4,Y-4
150 GCOL0,col1:PRINT A$
160 MOVE X,Y
170 GCOL0,col2:PRINT A$
180 VDU4
190 ENDPROC
```

Listing 6. Gives the effect of three-dimensional printing on Beeb or Electron

Several readers have pointed out that it can be reinstated using the following command

```
VDU23;29194;0;0;0;
```

This works in mode 7 on the BBC, but not in any of the other graphics modes. The only reliable way I know of switching the cursor on again after issuing the above command is to change mode.

## Damaged cassettes

I RECENTLY came across two cassettes that would not work at all. One had a blown internal mains fuse, the other had no internal fuse and the damage was more severe. Many people are careful to switch off the computer and the TV or monitor when they have finished, but do not realise that there is no mains switch in most cassette recorders. If they are connected to the mains then they are on and live. If left on for long periods (48

hours is usually enough) they will over-heat and the internal fuse will blow, or worse damage will be sustained by the electronics inside the cassette.

Be warned, remember to unplug your cassette after use.

## Quicker on

### the draw

ONE of the things that often puts me off typing in listings is long lines of programming or, even worse, long lines of DATA statements. I never manage to type them in correctly, and it is difficult to find where the mistakes occur. The READ...DATA statements are very useful and can save the programmer much time. If they are included in the listing with a little thought, they are easy to read and follow what is going on.

Listing 7 shows a simple routine to

read some data and use it to draw a simple picture of a house on the screen (figure 3). This is much easier than a long sequence of MOVE and DRAW statements, as the PLOT statement has been used instead. PLOT 4,X,Y is the same as MOVE, and PLOT 5,X,Y is the same as DRAW. PLOT 85,X,Y will fill in a triangle.

There are two ways to stop the routine trying to fetch another set of numbers when the picture is complete. One is to tell the computer how many sets of data it will have to read in the first place. This will be stored as a number at the start of the program, eg:

```
N% = 15
*
*
FORT = 1 TO N%
*
*
*
NEXT T
```

The method used below has a special control code at the end of the data to indicate where the end is. (In this case K with a value of 100, which is outside the normal PLOT range.) This has advantages because more data can be added in the middle without having to worry about changing the N%.

By using REM statements, leaving a line between sections, and by not putting a long series of data on each line, the program is easy to follow, and hence is easy to correct or adapt. For instance, try adding windows, or a chimney to see how extra data can easily be included.

## Coupler sealed

A USEFUL tip for computer owners with acoustic couplers has been sent in by J Crossland of Banbury. It is designed to reduce the risk of their picking up external sounds, which cause errors. He recommends putting window draught sealing tape around the telephone receiver where it snaps into the coupler.

## Line-spacing

## on Wordwise

HERE is a tip from C J Gaudion of Guernsey for readers who use *Wordwise*. It is not easy with *Wordwise* to space out a document correctly, but by redefining the space to a small dot in the middle of the line (to avoid confusion with a full stop), it is easier to insert the correct number of spaces required. This tip will only work when

Listing 7. Routine to read data and use it to draw house shown below

```
10 REM Listing 7
20 MODE 4
30 VDU19,0,4,0,0,0
40 REPEAT
50 READ K,X,Y
60 PLOT K,X,Y
70 UNTIL K=100
80 :
90 REM *** WALLS ***
100 DATA 4,200,600, 5,200,200
110 DATA 5,1000,200, 5,1000,600
120 :
130 REM *** ROOF ***
140 DATA 4,1100,600, 5,100,600
150 DATA 5,300,800, 5,900,800
160 DATA 5,1100,600, 5,1000,600
170 :
180 REM *** DOOR ***
190 DATA 4,550,200, 5,550,400
200 DATA 85,650,400, 5,650,200
210 DATA 85,550,200
220 :
230 REM *** PUT THIS LAST ***
240 DATA 100,0,0
```

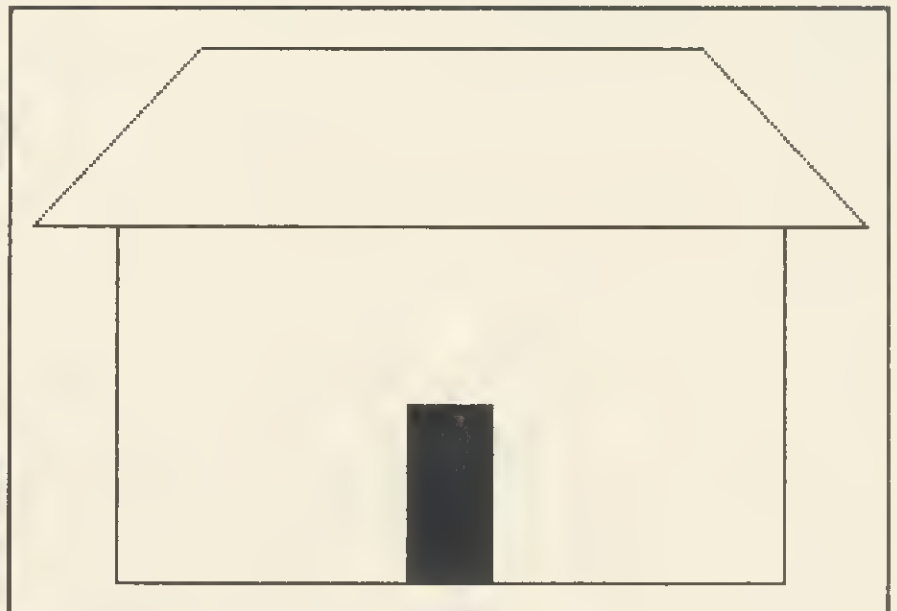

Figure 3. The house that READ...DATA built

the document is viewed in mode 0, and does not affect the mode 7 display or the final printed version.

The space is redefined by typing the following line:

```
VDU23,32,0,0,0,24,24,0,0,0
```

This can be typed in before entering *Wordwise*, or at any time by typing \*Basic first, and then returning to *Wordwise*. The line could be included in a key definition, or for disc users in a !BOOT file.



The best software store in the country  
(now boasting over 2,500 good titles in stock)  
with accessories, joysticks and books. We have  
somehow made room for hardware stocks.  
Home computers, disc drives, printers, monitors,  
and now a very special offer

## SONY® R.G.B. MONITOR \*

Ideal for BBC/Electron and many others.

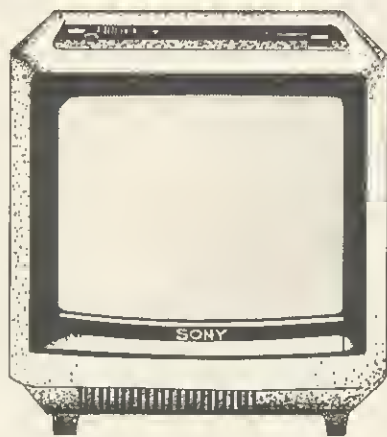

- \* 14" colour monitors
- \* Resolution equivalent to 480 x 400 pixels
- \* Full 12 month guarantee

\* These monitors using Trinitron tubes have been converted to RGB

Our unbeatable price

# £149.50

 inc. VAT.

Or mail order £159.50 including VAT, p&p & BBC leads

Postal and telephone orders welcomed.

All major credit cards accepted.  
(Offer subject to availability)

Easy Road Access  
Free Parking and  
Open Mon. — Sat.  
9.00–5.30  
Sun. 9.30 - 12.30

Soft Shop Ltd.  
55 St Peter's Court  
Chalfont St Peter  
Bucks. SL9 9QQ

Tel: (0753) 889010







# Computer Concepts

## Why stop at 4 ROMS.?

Fit an ATPL ROM EXTENSION BOARD  
and have up to 16 Sideways ROMS.

- Fully compatible with all sideways ROMs.
- Fully buffered against data loss
- Easy to fit (no soldering)
- Option for 16K sideways RAM

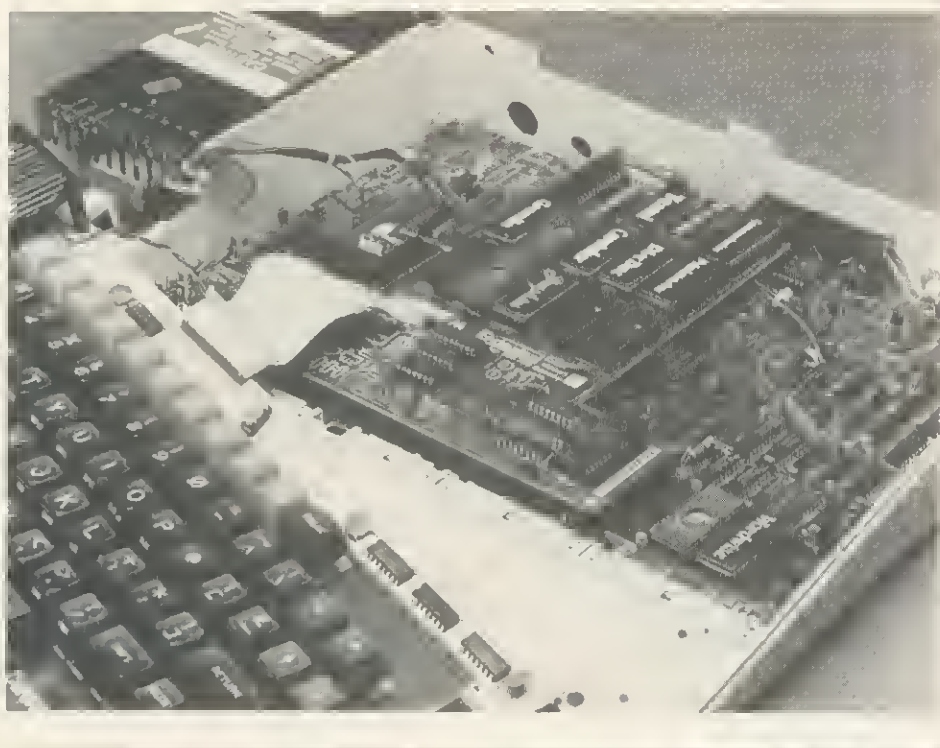

### Available from:

Computer Concepts  
by mail order or by  
telephoning with your  
credit card number,  
or  
from most good BBC  
micro dealers.

*(Dealer enquiries welcome)*

Price

**£43.70** incl.

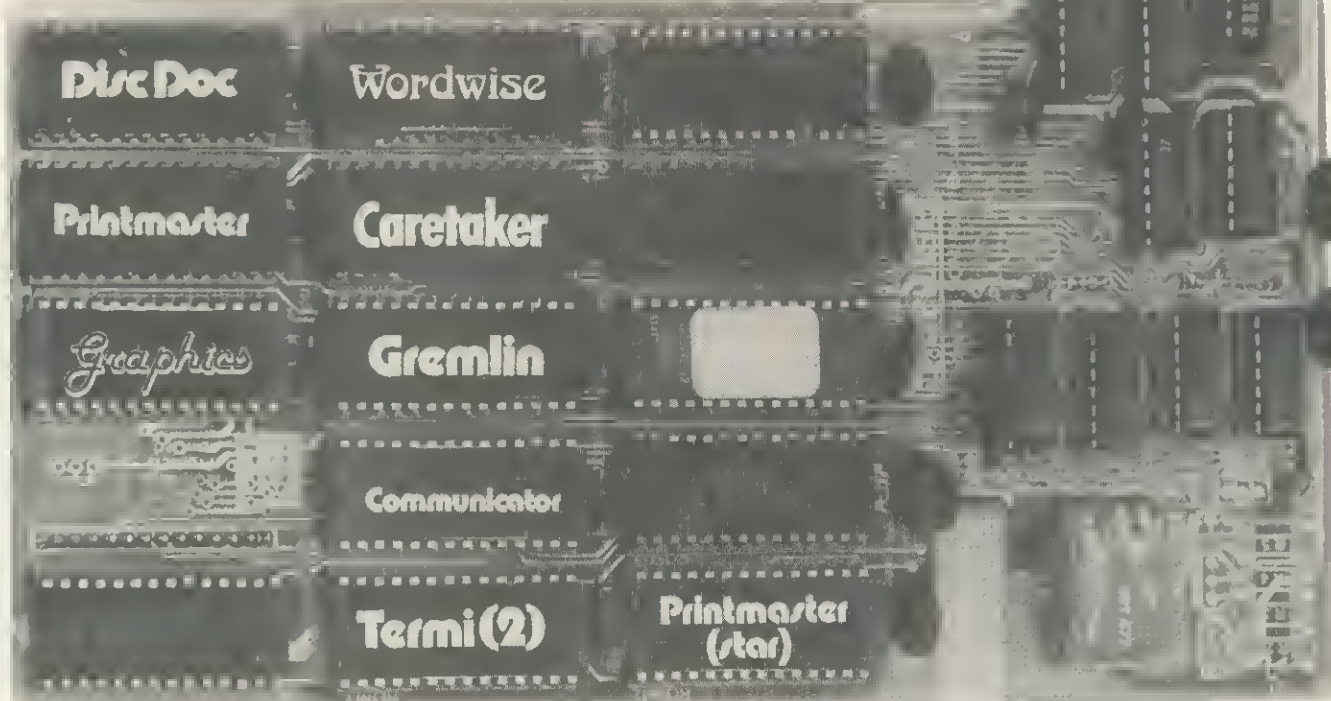
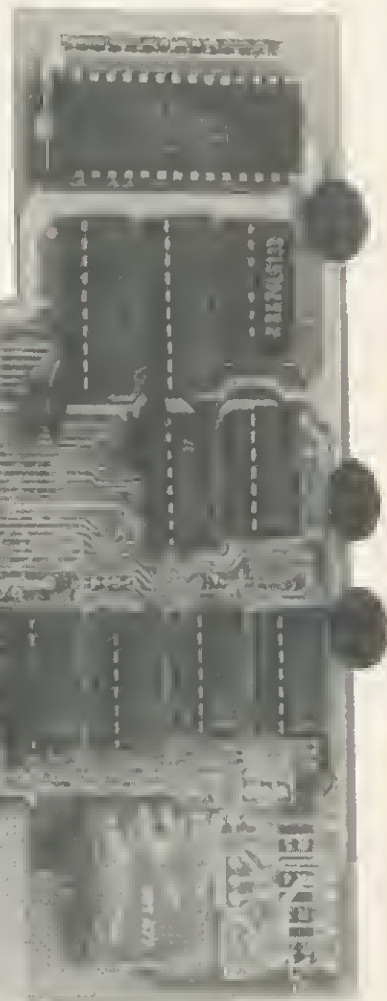

Computer Concepts, Gaddesden Place, Hemel Hempstead, Herts HP2 6EX  
Telephone: (0442) 63933 (4 lines)

VISA

We accept: Barclaycard, Access, Educational Orders, and Official Company orders.



# SOFTWARE, FIRMWARE AND HARDWARE FOR YOUR BBC

Buy direct through Prestel (Page \*2582020) using your Access card

Most programs available on Micronet

105	MAILING	Holds 21B addresses. Alpha & Post code sorts, searches, any label format, delete, add and amend	£11.95	B
201	GAMES 1	5 Card, Minefield, Oaris, Pontoon & Mr midon	£5.95	B/E
202	STOCKMARKET	Exciting world of Stocks and shares. 14 players	£5.95	B/E
301	HANGMAN	Word game in English, French, German, Italian, Spanish	£7.95	B
302	DISTANCES	Three graphic maps of U.K., EUROPE & the WORLD. Calculate the distance between any 2 places	£4.95	B/E
303	FLAGS 98	Full colour, flags of the world with questions	£4.95	B/E
304	STATPACK	Statistics package giving over 30 results	£9.95	B
305	GRAPH	Produce varied graphs & charts of functions	£7.95	B
306	FRENCH	A New audio visual computer way to learn a language	£7.95	B
307	SPELL-CHECK	Add to WORDWISE		
		15000 words in 12 dictionaries ideal in education	£17.95	B
504	PROCAID	includes SEARCHBAS to search a BASIC program and alter it. PROCVAR to list variables in a BASIC program & PROCFLUSH to clear resident integers in F M	£3.45	A/B
505	UTILITY-A	Our best selling tape includes PROCAID, DEFCHER to design & display graphic characters, SORTM/C a very fast machine code numeric sort, SORTBAS the undisputed fastest BASIC sort routine	£5.95	A/B
520	BANNER	Print giant text and graphics on paper for displays	£3.95	A/B
521	BIGLETR	Print as above on screen/paper with screen dump	£5.95	A/B
600	FORTH	'79 FORTH second language ROM	£34.74	B
601	LOGO-FORTH	Advanced Turtle Graphics Language ROM with FORTH	£57.50	B
602	PASCAL-T	Structured language ROM with compiler - interpreter	£57.60	R
603	XCAL	Computer Assisted Learning ROM for presentations	£65.00	B
605	WORDWISE	Super fast & easy to use wordprocessor in ROM	£33.96	B
606	CDUMP	Screen dump, 8 colours, suitable for GP700A	£12.95	B
607	GDUMP	Screen dump ROM 8 shades, 8 sizes and windows	£17.95	B
608	GRAPHICS	NEW ROM for Sprites, LOGO, circles, etc	£27.50	B
700	BOOKS	Various titles for the BBC Micro from	£6.95	
801	CASSETTES	C15 Computer quality tapes packed in 10's	£4.60	
810	5 25" DISCS	MEMOREX SS/SD 40/80T £19.95 SS/OD 40/80T	£20.96	
901	EPSON RX-80T/F	Superb 100cps with Tractor & Friction feed	£275.00	
902	EPSON FX-80	Magnificent 180cps, 6 fonts graphics F/T Roll	£365.00	
910	DISC DRIVES	Slimline 3" or 5 1/4" 100K-800K Japanese Format disc, cable and excellent manual Plus £50 of FREE Software	£189.00	
915	DISC UPGRADE	Double or Single Density available in one system	£89.00	
920	VDU STAND	Stainless Support protects your micro	£18.96	
930	GREEN VDU	12" Green Monitor, cream sloping front case	£79.95	
931	COLOUR VDU	JVC 14" Colour Monitor 370 x 470 pixels	£179.96	

ADD VAT TO ALL PRICES EXCEPT BOOKS

Add £1.75 for programs on 40 or 80 Track Disc. No post charge in UK. Send for our free brochure for more information before parting with your money

## memo-calc

107 MEMO-CALC £12.95 B C/D  
"IT MUST BE AMONG THE LEAST EXPENSIVE PIECES OF USEFUL SOFTWARE YOU WILL EVER BUY" Revue by Practical Computing July 1983

Database/calcsheet program which allows up to 255 columns. The number of rows is automatically set from 5 to over 1000 depending on the columns declared. Both numeric and alphanumeric data can be stored in any cell and can be of any length up to 255 characters.

There are a multitude of uses for this program from accounts to diaries, club or personnel records etc. and is probably the one program that we all need. MODE7

107a Manual for MEMO-CALC included free otherwise £2.00 (0% VAT)

## PAYROLL

Part 1 is a BASIC program running in MODE7 which accepts new data on employees, allows editions, deletions and alterations, listing of P35 & automatic alterations to the codes as required by tax notice P7X. Fully 'user friendly' with colour and graphics to make life simple for the operator.

Part 2 (WEEKLY) or Part 3 (MONTHLY) is designed to handle the calculations of wages and N.I. It allows for standard pay, two overtime rates, optional pension funds (monthly only) other pay, holiday pay, bonuses, post-tax adjustments and no pay.

106b COIN ANALYSIS £4.95 B C/D  
106c PENSION £4.95 B C/D EXTRA  
106d PAYSPLIT FORMS £20.34 par 1000 EXTRA

Buy direct or Prestel No. 25821534.

PRESTEL MODERN £78.00  
PRINTER + VAT £120.00  
IDEAL FOR FARM-LINK

Most Programs Now Available For MSX BASIC Dealer Enquiries Welcome

# MICRO

## ORGANISATION AT YOUR FINGERTIPS!

We are pleased to offer you a wide range of products primarily for the BBC microcomputer software, firmware and hardware for your computer system.

## SEIKOSHA PRINTERS From £99-£349

A new range of printers (Spectrum Compatible) replacing existing models.

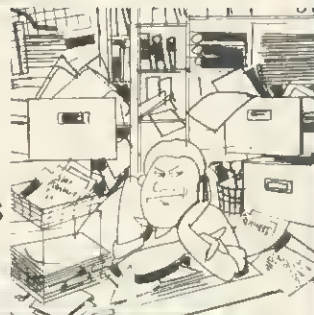

## CASHBOOK

102 CASHBOOK £11.95 B C/D  
FIRST CHOICE This is a double entry cashbook program showing cash and bank credits and debits i.e. 4 columns. Any number of individual accounts can be used and analysed or totalled individually or cumulatively by associated group. A friendly but very practical, and reliable program which despite its low cost is used by many people in a range of situations from domestic and clubs to schools and businesses  
MODE7  
102d CASHBOOKd £19.95 B D  
SECOND CHOICE This version of the above program uses random access disc files and can hold up to 1250 entries on 100K discs and up to 2500 on 200K discs. There is sophisticated protection against unauthorised use built in. MODE7

102f ACCOUNT £29.95 B D  
THIRD CHOICE This version of the above program uses random access disc files and can hold up to 1100 entries on 100K discs, and up to 2250 on 200K discs. Included is a choice of CASH/BANK or VAT/BANK headings. Over 830000 possible accounts combinations. Ledger sheets and summaries can be printed as well as full accounts. The latest balance is available at any time. This program is only available on disc  
MODE7

## Programs of the Month

### BUDGET £9.95 + VAT

BUDGET can be used by anybody in a domestic environment to help them with their own budget, by clubs charities wishing to prepare applications for grants and for submission to committees, by educationalists in classrooms to show students where money comes from and how easily it disappears. Available on cassette for the ELECTRON and cassette or disc for the BBC Micro using any operating system.

### CRIBBAGE £7.95 + VAT

Cribbage is played with a full pack of 52 cards. An ace always counts as '1', a Jack, Queen or King counts as '10' when its value is added to others but ranks in normal sequence when scoring runs. There are usually two players, and the most common forms of the game are the five-card and six-card. The winner of the game is the first to score 61 or 121 respectively.

## Stop Press

RANDOM MAILING up to 1850

addresses, names, phone numbers & codes one disc. Selective printing any number of labels, repeat, stationery or ten fold. Automatic WORDWISE & letters produced repeatedly with personalised names many other features such as automatic sorting by company or personal names. By far the best and most comprehensive program of its type for the BBC Micro Price £29.95 + VAT

# Micro-Aid

25 Fore St. Praze, Camborne Cornwall. TR14 0JX tel: 0209 831274



# CHRISTMAS GIFTS

The  
Electron



Phone your  
nearest dealer  
for the most  
competitive  
prices

The Electron — A thoroughbred from the manufacturers of the BBC, who have incorporated all their experience and knowledge to conceive another winning computer. Many BBC programs are compatible. This full colour 32K ROM and RAM computer with text and graphics includes a cassette input, and a multi-way connector for the addition of expansion units containing interfaces to additional hardware. It has a 56 key full travel QWERTY keyboard, 10 user-definable and 29 pre-defined keys enabling BASIC keywords to be entered in a single keystroke. The Electron comes with free introductory cassette containing 19 programs including a number of exciting games.

Up to £1000 instant credit  
write for details

- Europe's No. 1 Group of Retail Outlets
- Check our multi-national network for your nearest dealer
- Backed by an after-sales service second to none

# CHRISTMAS



**SINCLAIR ZX SPECTRUM**  
£129.95  
48K



**SINCLAIR ZX SPECTRUM** —  
48K basic, colour and text graphics — £129.00

**TV/RGB MONITOR**  
£259.00



A wide range of computing best-sellers.

**BOOKS**



**SOFTWARE**

**SOFTWARE ALL LEADING CHART SOFTWARE AVAILABLE**

**TATUNG TV/RGB COLOUR MONITOR**  
only £259.00  
Many other monitors available.

The NEW advanced home computer designed with first time users in mind. Full size professional keyboard, four cursor keys, powerful 16K RAM, easy to use and program. 2 joystick ports, 121 colours, excellent sound and graphics. Price includes Commodore Cassette Recorder!

**COMMODORE 16 STARTER PACK**  
£139.00

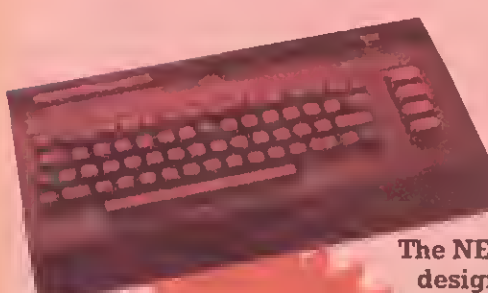

**Beds**  
The Book Castle  
12 Church Street  
Dunstable  
Tel: 0882 608670

**Bucks**  
Citybench  
2/4 Eaton Place  
Marlow  
Tel: 06284 75244

**Cornwall**  
Computavision  
4 Market Street  
St. Austell  
Tel: 0726 5297

**Derby**  
First Byte Computers  
10 Castlefields  
London Road  
Derby  
Tel: 0332 366280

**Devon**  
Computer Systems (Torbay)  
35 Hyde Road  
Paignton  
Tel: 0803 524284

**Roy Hart**  
Computer Services  
10 Fore Street  
Tiverton  
Tel: 0884 253468

**Dorset**  
Solent Micro Systems Ltd  
23 Bargates  
Christchurch  
Tel: 0202 470468

**Essex**  
Focus Computer Systems  
140A Hathaway Road  
Crays  
Tel: 0375 79717

**County Computer Stores**  
5a West Square  
Harlow  
Tel: 0279 414692

**The Home Computer Centre**  
261 Victoria Avenue  
Southend-on-Sea  
Tel: 0702 43568

**Gloucs**  
The Model Shop  
22 High Street  
Stroud  
Tel: 04536 6920

**Sabre Consultants Ltd**  
103 High Street  
Tewksbury  
Tel: 0684 298666

**Herts**  
County Computer Stores  
95a South Street  
Bishops Stortford  
Tel: 0279 808801/2

**Hobbyte**  
183 Grove Road  
Harpenden  
Tel: 05827 3342

**N. Humberside**  
Beverly Computer Centre  
1 Windmill Passage  
55 Laigate  
Beverly  
Tel: 0482 881911

**S. Humberside**  
Ashby Computer Centre  
247 Ashby High Street  
Scunthorpe  
Tel: 0724 871766

**Kent**  
Tollgate Computers  
249 Beaver Road  
Ashford  
Tel: 0233 37187

**Data Store**  
6 Chatterton Road  
Bromley  
Tel: 01 460 8991

**The Village House**  
of Computers  
87 Beckenham Lane  
Shortlands  
Bromley  
Tel: 01-460 7122

**Canterbury Software Centre**  
9 The Friars  
Canterbury  
Tel: 0227 53531

**North Kent**  
Computer Centre  
32/34 Bellgrove Road  
Welling  
Bexley  
Tel: 01-301 2677

**Lancs**  
Format Computing  
67 Friars Gate  
Preston  
Tel: 0772 881952

**London**  
Henry's Computer Shop  
404 Edgware Road  
London  
Tel: 01-402 6822

**Miracle Computers**  
245A Coldharbour Lane  
London  
Tel: 01-274 7700



# GIFTS



**PRINTERS  
FROM  
£150.00**



**QUENDATA DOT  
MATRIX** £150.00  
**QUENDATA DAISY  
WHEEL** £299.00  
**EPSON FX80** £503.70  
**RX80** £286.35  
**ASTRON JP80** £199.00

**COMMODORE  
64  
£199.00**



**COMMODORE 64**  
—£199.00 Colour  
sophisticated ROM/RAM  
user, UHF/Composite video,  
high resolution graphics.

**JOYSTICK  
& CASSETTE  
PLAYERS**



**JOYSTICK & CASSETTE  
PLAYERS —**  
Many joysticks and  
cassette players  
available from  
stock.



**COMMODORE 1541  
coming soon-model  
1542**

**COMMODORE  
DISK DRIVE  
£229.00**

**BBC  
MODEL B  
£399.00**



**BBC MODEL B —**  
£399.00 Full colour 32K  
ROM Computer with text  
and graphics, 80 column  
text screen, extended  
Microsoft Basic, built in  
assembler,  
1MHz and tube  
interface,  
sideways ROM,  
RS 423, A/D  
converter.

**Greater Manchester**  
Control Technology  
184 Market Street  
Hyde  
Tel: 061 366 8223

**W. Midlands**  
Impulse Computer World  
60 Hartford Street  
Coventry  
Tel: 0203 27711

**Somerset**  
Sinewave Computer  
Services  
Corporation Street  
Taunton  
Tel: 0823 37526

**Suffolk**  
Micro Management  
32 Princess Street  
Ipswich  
Tel: 0473 89181

**W. Sussex**  
Orchard Business  
Systems Ltd  
34 East Street  
Horsham  
Tel: 0403 68461

**Wales**  
Automation Services  
42 Dunraven Place  
Bridgend  
Mid Glamorgan  
Tel: 0656 3550

**Belgium**  
Micro Management  
Belgium  
Ballaerstraat 75  
2018 Antwerp  
Belgium  
03-238 9284

**Middlesex**  
Enfield Communications Ltd  
139 High Street  
Ponders End  
Enfield  
Tel: 01-806 7772/7434

**Wolverhampton Computers  
Centre**  
17/19 Lichfield Street  
Wolverhampton  
Tel: 0902 29907

**Staffs**  
Eric Reynolds Ltd  
86 High Street  
Burton-on-Trent  
Tel: 0283 65086/65869

**Surrey**  
Concise Computer  
Consultants Ltd.  
1 Carlton Road  
S. Croydon  
Tel: 01-681 8842

**W. Yorkshire**  
Software Sales  
60 North Street  
Leeds  
Tel: 0352 456192

**Scotland**  
Micro Store  
38 The Arcade  
King Street  
Stirling  
Central Region  
Tel: 0788 64571

**Holland**  
Micro Management  
Nederlands  
Raad Huisstraat 86 2406  
Ah Alphen aan-den-Rijn  
01720-72580

**Twilstar Computers**  
17 Regina Road  
Southall  
Tel: 01-574 5271

**Norfolk**  
Abacus  
12a Pottersgate  
Norwich  
Tel: 0603 81441

**E. Sussex**  
Camer  
24 Cloucestor Road  
Brighton  
Tel: 0273 698424

**N. Ireland**  
Everyman Computers  
80 Charlotte Street  
Ballymoney  
Co. Antrim  
Tel: 02636 62116/62658

For your nearest European  
Dealer telephone Belgium  
or Holland

**J.K.L. Computers**  
7 Windsor Street  
Uxbridge  
Tel: 0896 51815

**Viking Computers**  
Ardney Rise  
Caton Grove Road  
Norwich  
Tel: 0603 45209

**The Big International Dealer Network**

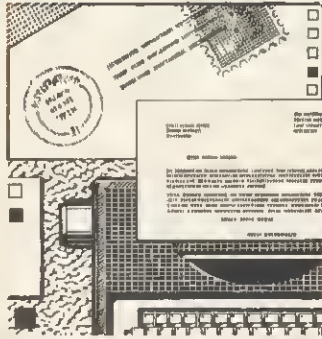

## Help and hints

### for Beeb users

### from RTTY group

Sir, I have read *Acorn User* since it was first published and I would like to say a few words about the article 'Unscrambling the airwaves' on RTTY by Robin Mudge in September's issue.

There is one organisation which specialises in keyboard communications including RTTY, AMTOR (AMateur Telex Over Radio), Packet Radio, etc: the British Amateur Radio Teleprinter Group. The current chairman is Stuart Dodson, G3PPD, 63 Malvern Avenue, South Harrow, Middlesex HA2 9EV (the membership secretary John Beedie, G6MOK is in the process of moving house).

A quarterly magazine published by BARTG, *Datacom*, deals with many aspects and levels of radio communications.

BARTG supplies PCBs, circuits and, in some cases, kits of parts for what we call 'terminal units' and which would be called in the computer world 'modems'. In particular, the ST5C is specifically for use with computers and is literally plug-in compatible with the BBC B. It is superior to many popular commercial units.

On another point, the inside of the BBC case can be sprayed with zinc to radically cut down the interference radiated from the computer itself, the other side of the coin being that RF interference from transmitters is less likely to upset the computer.

As a council member of the Radio Society of Great Britain, I think I should point out that the information given under the heading 'Useful books' on

page 31 is not accurate. The Radio Society of Great Britain does not 'administer and govern all the amateur radio clubs', although about half of the radio amateurs in this country are members, and most clubs are affiliated.

Packet Radio is the most exciting thing on the horizon for computer-directed radio amateur communications. Radio amateurs throughout the world are still discussing suitable standards, although it looks as if the AX25 standard could well receive worldwide support.

I hope these remarks will be of use to readers.

**Ingemar Lundegard**  
President, BARTG, G3GJW

Sir, In September's issue you gave us an interesting article on 'Unscrambling the airwaves'; thank you. You also gave the suppliers of the goodies a gift of an advertisement. To the unknowledgeable reader it all looks fine, but to a licenced amateur (call sign: G4PLW) I know your list of equipment is not necessarily the best available and certainly not the cheapest.

May I draw attention to the program written by Peter Harris (G3WHO) and the interface produced by Johnny Melvin (G3LIV). I have both items: they work, cost little and do everything I could wish for software-wise.

**Peter Walker**  
Middx

## Hitting out at

### high prices

Sir, I would like to voice criticism over the cost of purchasing peripheral equipment for the BBC micro. Without a doubt the model B is one of the best eight-bit home micros, and with its excellent operating system and Basic it is a real pleasure to use. However, I believe that the price of buying extra hardware is suffocating the machine's potential.

I would be pleased if equipment manufacturers could explain why it is necessary to charge between £199/£299 for a second processor, or £115

for a 20K video RAM board, or £55 for a speech chip, or £225 for a Prestel adaptor.

It is common knowledge that a great deal of computer market price setting is calculated on the 'what the market will stomach' basis. Compare similar pieces of equipment between the Sinclair, Commodore and BBC markets, and you can almost guarantee that the BBC item is the most expensive.

For the manufacturers this marketing policy holds three dangers. First, this country is beginning to see the introduction of very cheap all-in-one packages (eg Einstein, Amstrad, etc), which offer the buyer processor/disc drive and monitor in one low price. Against these BBC equipment appears grossly over-priced.

Second, the advent of 16-bit home micros looms. Micro enthusiasts are just one sector of the magpie-like consumer group that rushes out to buy the latest, brightest, fastest new product. If it costs too much to upgrade your existing micro, people will simply dump it and buy a new all-singing all-dancing 16-bit machine. The sheer power of 16-bit machines (ie QL, Advance, Apricot cheapie) is daunting. The basic coinage of micros is RAM. With more RAM, the greater the options, more can be done. Against these even the model B looks puny.

Third, the 'fashions' that run through the BBC hardware market could well evaporate. Last year it was disc drives, this year it's modems. Next year second processors? At £199 a throw I can't see them queuing at the door!

**I Hayes**  
Surrey

## 6502 expensive

Sir, I would be interested to know why the 6502 second processor is so expensive. At £199 it is the same price as the Electron, which has a keyboard, interfaces and other chips. However the second processor just seems to be a processor with memory and the Tube interface, so why the high price?

**Atan Bradtley**  
Belfast

## Second processor

### patch for Level 9

Sir, I write to you on two issues. The first concerns Mr Howard, who wrote in the September issue asking about the addresses of the floating point routines in Basic; the July 1982 issue of *Personal Computer World* carried the information.

Second, people who play Level 9 adventures on the 6502 second processor will have discovered by now that this produces at best garbage.

There is a simple reason for this and I have worked out a short Basic patch which should be loaded in and run after the body of the adventure has been loaded (into the second processor of course). Then save the amended version onto disc before using. The patch is program 1 below. Note there must be six NOPs at the end; if they are missed out the patch won't work properly.

In case you want to know why the program crashed in the normal Beeb the carry flag in the 6502 CPU is normally clear on returning from OSWRCH (this may not always be true but it is in this case). In the 6502 second processor, the carry flag is set on return from OSWRCH and in the Level 9 A-code interpreter it calls OSWRCH then has several RTS and executes the following code:

```
PLA:STA&60:LDA&60:
ADC#1:STA&60...
```

Note that the code relies (unwisely) on the carry flag being clear at the start of the addition causing ADC#1 to add two rather than one when the carry flag is set. As 60/61 contains the internal number of the piece of text to be printed out next, this causes great confusion when combined with their method of packing text.

**Roger Hill**  
Guernsey

**Level 9 has asked us to point out that this patch will only work on early versions of the adventures. Disc versions are now available at £11.95 which will run on the 6502 second processor.**

```
10 A%=&74A7 :REM for Snowball And Time this number must be &74AC
20 P%=A%-2
30 LOPT3:INC&60:BNFP%+3:INC&61:NOP:NOP:NOP:NOP:NOP:NOP:]
```

**Program 1. Second processor fix for early Level 9 adventures**



Also, the company will upgrade to disc for just £2.50 (includes post) plus the cassette. The latest adventure, Return to Eden, will run on the 2P.

## Bonus idea for function keys

Sir, In November 1983 *Acorn User* published an interesting program written by J Taylor under the heading 'Multi function keys' in Beeb Forum. It deserves a further airing for the benefit of readers who may have missed it. Indeed, it was only while browsing through some old copies that I realised its potential.

Type listing 2 in as shown for use with disk and run it (save it if you wish). If you now examine the catalogue you

will see that program 'K' has been saved (line 340).

When starting up again from cold, just type \*K (Return). Conditions are then such that you can load other programs, operate Escape and Break, while still retaining definitions of up to 40 user-defined keys. Operation of f0 cycles through four sets and displays the current set on screen.

At any time you can redefine a key (1-10) in the usual way, eg by typing \*KEY5LIST (return). If you wish to retain this new definition, f8 in set 4 should be used. Just type Y in answer to the question and program 'K' will be adjusted, without disturbing another program being developed.

Lines 210 and 320 are useful variations to re-arrange the Break key so that time is saved when program writing.

David Polak  
Leeds  
page 61 ▶

```

10 REM:.....MULTIKEY:.....
20 REM::cf ACORNUSER NOV 1983 p55::
30 :
40 C%=&8D0:REM MACHINE CODE ADDRESS
50 REM:BUFFERS 1-4, BASE ADDRESSES
60 B1=&B00:B2=&A00
70 B3=&900:B4=&C00
80 :
90 P%=C%[:OPT3:LDY #1
100 .L:LDX B1,Y :LDA B2,Y
110 STA B1,Y :LDA B3,Y
120 STA B2,Y :LDA B4,Y
130 STA B3,Y :TXA:STA B4,Y
140 INY : BNE L : RTS :]
150 :
160 DIM X% 30: Y%=X% DIV 256
170 PROCO(1)
180 *KEY1LISTO7 |M
190 *KEY2LISTO0 |M
200 *KEY3LIST |M
210 *KEY10OLD |MLISTO7 |ML. |M
220 PROCO(2)
230 REM SECOND KEY SET *KEY1 - *KEY10
240 *KEY4:.....HELLO TWO::
250 PROCO(3)
260 REM THIRD KEY SET *KEY1 - *KEY10
270 *KEY4:.....HELLO THREE ***
280 PROCO(4)
290 REM FOURTH KEY SET *KEY1 - *KEY10
300 *KEY 1 MO.6 |M VDU19;4;0;28,0,24,39
,0,23;12;0;0;0;|M
310 *KEY8P. "" SAVE *K Y/N ":A$=INKE
Y$(1000):IFA$="Y"THEN*SAVE"K" 8D0+400 |M
320 *KEY10OLD |MLISTO0 |ML. |M
330 :
340 *SAVE"K" 8D0+400
350 END
360 :
370 DEFPROCO(N%) : CALL C% : *FX18
380 $X%="*KEY 0 CA.&"+STR$`C%+" |M P. ""
Keys "+STR$(N%)+"" |M"
390 CALL &FFF7 :ENDPROC

```

Listing 2. A better way to make use of the definable function keys: for £ read #

## Kitty strolls down memory lane for two puzzled readers



**Q** I've typed in several listings from various magazines and I often get a 'Bad Mode' error. I know this means the computer has run out of memory, but the program must have worked before it was put in the magazine. Or must it?

Bernard Walker  
London

**A** The reason a 'Bad Mode' error is generated when a program is run is normally because there is not enough memory for both the program and the screen mode that the program selects to exist at once. There are several screen modes on the Beeb and Elk and these all require specific amounts of user memory to operate in. For example, mode 2 requires 20k - more than two-thirds of the user memory. If mode 2 is selected only a small amount of memory is left for you, the programmer, to use.

When you run a program that incorporates a mode-changing command your computer's operating system checks to see if there is enough memory left above the program to implement the required mode. If there is not then the Bad Mode error is printed.

How do you get around this? Well, the obvious solution is to shorten the program, but this will not always be possible and quite often there's another cause. If you have a disc interface fitted this will gobble up precious user memory. This memory can be claimed back by first typing \*TAPE and then resetting the value of the variable PAGE which determines where usable memory starts. The sequence is therefore:

```
*TAPE
PAGE=&E00
NEW
```

Remember to press the return key after each command. Now enter your program, save it to

tape in case of possible corruption, and try running it. Nine times out of ten this will solve the Bad Mode problem.

A further problem now exists. You cannot readily use discs because as soon as you try to save the program to disc the disc filing system will reclaim its memory and corrupt your program. The only way to counteract this is to enter the program at the normal PAGE value, save it to disc and then write a downloading program that will move the program down-memory automatically - Martin Phillips described the technique in the June issue (page 96).

If this does not work or you don't have a disc interface fitted, the only other alternative is to use a screen mode that requires less memory. For example, modes 4 and 5 need only half the memory required by mode 2. So try experimenting with different modes.

**Q** I'd always thought that the Beeb grew out of the Atom, but recently a friend told me that the Beeb came from the Proton. I've never heard of the Proton - what is or was it?

Adrian Frost  
Fife

**A** In the beginning... the Proton was the name given to the machine that finally became the BBC micro. As you may have noticed while glancing through *Acorn User*, there is a lot in common between the Atom and Beeb Basics and indeed the BBC micro owes a lot to the Atom. The Proton, as originally envisaged, would have been without many of the features we all now know and love on the Beeb. The contract between the BBC and Acorn meant that the machine had, for instance, to be able to provide teletext type - thus, Acorn had to go away with its Proton and design mode 7 onto a chip.

# THE DISK DRIVE YOUR MICRO WOULD CHOOSE FOR ITSELF

## THE TEAC 5¼" DISK DRIVE FOR THE BBC 'B' MICRO

Any self-respecting BBC 'B' Micro seeking a disk drive of high reliability and performance would immediately identify the TEAC 5¼" as the complete solution. A quality product, it is extensively industry-proven in major systems applications all over the world.

Now available for the home, educational or office user by mail order from Computamate, the TEAC 5¼" Disk Drive guarantees trouble-free high speed data access every time; and what more could a micro ask?

- Single and dual models available with capacities up to 800K. (All 80 track models are switchable 40/80).
- Supplied with leads, utility disk, instructions: ready for use with your BBC 'B' Micro DFS Disk Interface.
- Oatmeal moulded box to match your micro.
- Fully stackable, plus extending tilt-action "legs" to ease disk insertion.
- 12 months parts and labour warranty.
- Computamate is supported by the resources of a major multi-national public company.



Twin Drive In non tilt-position

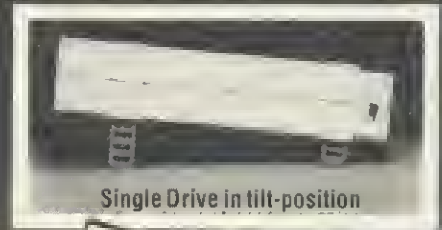

Single Drive in tilt-position

### How to order:

By post – complete the coupon with your requirements and return to: Dept. AU 11, Computamate Data Products, Scotia Road, Burslem, Stoke on Trent, ST6 4DX. Enclose your cheque/P.O. (made payable to Computamate) or use your Access/Barclaycard number.

By telephone – ring 0782-811711 to purchase by phone (credit card holders only).

SATISFACTION GUARANTEED OR WE WILL REFUND YOUR MONEY.

**computamate**

(Computamate Data Products is a division of Thomas French and Sons PLC)

### INTRODUCTORY PRICES ONLY

SINGLE DRIVES	CDST (Incl. VAT)	QUANTITY	TOTAL (£)
FD-55A SS 40TK 100K	£108 10		
FD-55B DS 40TK 200K	£129 95		
FD-55E* SS80TK 200K	£135 70		
FD-55F* DS 80TK 400K	£164 45		
TWIN DRIVES			
FD-55A SS 40TK 100K	£212 75		
FD-55B DS 40TK 200K	£253 00		
FD-55E* SS80TK 200K	£253 00		
FD-55F* DS 80TK 400K	£309 35		
DUAL DRIVES (with integral power supply, available only in metal non-tilting box at present)			
FD-55A SS 40TK 100K	£301 30		
FD-55B DS 40TK 200K	£342 70		
FD-55E* SS80TK 200K	£343 85		
FD-55F* DS 80TK 400K	£399 05		
Post and Packing (First Unit)	£5 75		
Post and Packing (each additional unit)	£2 50		
*Price includes 40/80 switch			
MEDIA			
Box of 10 Diskettes 40TK SS	£18 50		
Box of 10 Diskettes 80TK SS	£21 25		
Box of 10 Diskettes 80TK DS	£27 00		
Postage & Packing per box of Diskettes	£1 00		

TOTAL £

Post to: Dept. AU11,  
Computamate Data Products, Scotia Road,  
Burslem, Stoke on Trent, ST6 4DX

Name \_\_\_\_\_

Address \_\_\_\_\_

Post Code \_\_\_\_\_ Telephone \_\_\_\_\_

\* I enclose cheque/P.O. for £ \_\_\_\_\_

\* Please debit my Access/Barclaycard Number \_\_\_\_\_

Signature \_\_\_\_\_  
(Credit Card orders must be signed by the card holder. Address above must be the same as card holder)

\* (Please delete as appropriate)

For further information on these products, or for details of other exciting products, including TEAC 3½" and 3" Disk Drives, telephone 0782 811711.

Enquiries from Dealers and Educational Authorities welcome



## Problems with handling files

Sir, I am sending with this letter two programs, BPUT and BGET, which I am trying to make run. However, when I want to read the file, I get an error message. Could you please solve my problem?

Abdulla Shams  
Dubai, UAE

### Joe Telford replies:

Thank you for your letter, but unfortunately you do not explain why you are writing these programs, which would have helped me work out the best answers.

Your program 3 is logically correct, but I wonder if it does what you want, because all it does is place a single byte in the file. For example, if you entered:

```
shoes,12,13
socks,10,11
hats,9,100
carpets,2,144
99,0
```

the file would only contain:

```
&01,&02,&03,&04
```

because only line 40 sends anything to the file. You can see that line 40 only sends the bytes for the variable I.

I would prefer program 3b which is almost the same as yours, with a couple of additions. First, instead of GOTO, I use a REPEAT...UNTIL loop. Second, instead of M\$,L,R, I use long names which are more meaningful. Finally, line 110 saves each set of infor-

mation (each record) to the file.

Notice that I don't use BPUT, because for files of information with strings and numbers, PRINT# is more useful.

Now for your second listing (program 4). Unfortunately, it does not operate correctly. Looking at line 50 and 60 shows that you seem to be expecting all the information saved in program 3 to be brought back into the computer for use with lines 50 and 60. Line 40 cannot do this because program 3 does not save the information you wish to use (M\$,L,R). Also, the information that it does save, the item number as a byte, is not being used in program 4.

Line 20 can be removed altogether and line 40 can be altered to say just:

```
40 I = BGET#B
```

but it still will not work properly.

Program 4b is one solution. This does the calculations with the data filed in program 3b. Again I have altered the program so that the short variables have been lengthened, eg 'M\$' becomes 'itemname\$'.

I have removed the GOTOs and replaced them with

```
ITEM1 ACORN USERS 243x1= 243
ITEM2 EPROMS 339x8= 2712
ITEM3 MONITORS 24x98= 2352
ITEM4 RESISTORS 1420x3E-2= 42.6
ITEM5 TRANSISTORS 543x0.12= 65.16
ITEM6 LOUDSPEAKERS 12x0.72= 8.64
```

Figure 1.

REPEAT...UNTIL loops. When I used the two programs to make a short file, the final result looked like figure 1, although it could be put into columns using the TAB command several times in line 70.

## Long search for school software

Sir, I have owned a BBC B for over a year and have recently upgraded to OS1.2 and Wordwise (such a useful tool). There is, however, one thing that really puzzles me. For a machine almost perfectly suited to educational use, why is there such a shortage of good educational software?

I have seen quite a few programs in magazines which purport to be educational, but on further investigation most are poor indeed. I have two sons aged eight and 10 and we have gathered a collection of programs that are based directly on work they are doing at school.

Could you tell me why the programs made available to schools by MEP, CET and MUSE, etc, are not readily available for sale, so that

interested parents could purchase them?

I ask myself though, could it have something to do with profit margins? By that I mean programs that education authorities are being charged a lot of money for would simply not sell for such prices on the open market. I find myself wondering if Sir Clive Sinclair's latest idea of releasing them to the marketplace is going to catch on. I for one certainly hope so.

R Hughes  
Essex

## Adventure query

Sir, Much has been written on the subject of misleading cassette packaging and advertisements, as the game is often nothing like the fancy pictures and exciting description.

There does seem to be a perfectly logical answer: print a screen shot of the game on the pack, and also in any adverts, as many companies already do. But what about text adventures?

When you consider that an adventure can easily have 2,000 different 'screens', it would be quite a daunting task to try and represent them on a wall, let alone a tiny cassette inlay. Therefore, what other methods are there of displaying just how marvellous this piece of software is?

Frankly, I don't know the answer, but it would be interesting to hear from readers.

Simon Clarke  
International Adventure Club  
10 Ennis Close,  
Harpenden, Herts AL5 1SS  
Prestel Mailbox: 582768663

```
10 A=OPENOUT"CIC":I=0
20 INPUT"ENTER NAME OF GOODS,QUANTITY,PRICE";M$,L,R
30 IF M$="99" THEN 60
40 I=I+1:BPUT#A,I
50 GOTO20
60 CLOSE#A
```

Program 3. BPUT from Abdulla Shams

```
10 A=OPENOUT"CIC"
20 number=0
30 REPEAT
40 number=number+1
50 PRINT "ITEM:"number
60 INPUT"ENTER NAME OF GOODS ":"itemname$"
70 IF itemname$="99" CLOSE#A:CLS:END
80 INPUT"ENTER QUANTITY ":"quantity"
90 INPUT"ENTER PRICE ":"price"
100 PRINT
110 PRINT#A,itemname$,quantity,price
120 UNTIL FALSE
```

Program 3b. Joe Telford's version

```
10 B=OPENIN"CIC"
20 I=0
30 IF EOF#B=-1 THEN 80
40 I=I+1:I=BGET#B
50 LET H=L*R
60 PRINT M$;" ";L;"x";R;"=" "H
70 GOTO40
80 CLOSE#B
```

Program 4. BGET from Abdulla Shams

```
10 B=OPENIN"CIC"
20 itemno=0
30 REPEAT
40 itemno=itemno+1
50 INPUT#B,itemname$,quantity,price
60 LET total=quantity*price
70 PRINT"ITEM";itemno;" "itemname$;"
";quantity;"x";price;"=" "total"
80 UNTIL EOF#B
90 CLOSE#B
```

Program 4b. By Joe Telford



12 York Place  
Brighton  
SUSSEX BN1 4GU

# Microworld

## Computer and Video Centre Ltd.



10 The Boulevard  
Crawley  
SUSSEX RH10 1XX

★ COMPUTERS ★ SOFTWARE ★ PRINTERS ★ PERIPHERALS ★ MISCELLANEOUS ★



**\*FREE JOYSTICK  
WITH BBC OR  
ELECTRON**



Model B .....£398  
Model B × Disc I/F.....£469  
Double Density I/F.....£115  
Teletext Receiver.....£225  
Z80 2nd Processor.....£395  
6502 2nd Processor.....£299  
Video Digitiser.....£255

Acorn Electron ..... £196  
Plus 1 Interface ..... £ 59  
Dual Joysticks..... £ 19  
Single Joystick..... £ 8.50  
(Joystick compatible  
with BBC)

### COMPUTERS

### TEAC DRIVES

55A S/S 40 Track  
100K Single...£139  
200K Dual....£279

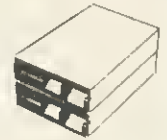

55E S/S 80 Track  
200K Single...£189  
400K Quat....£379

55F D/S 80 Track  
400K Single...£219  
800K Dual....£439

Optional PSU..£29  
40/80 Switch..£ 8

3" Disc Drive (200K).....£113  
Cable & Formatting Disc.....£ 22

### DRIVES



Epson

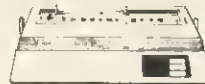
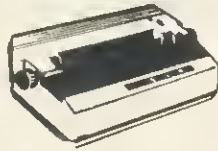

JUKI 6100

Epson RX80 F/T.....£254  
Epson FX80.....£365  
Epson FX100.....£498  
Epson RX100 F/T.....£398  
Quendata DMP81.....£174

Taxan Kaga KP810.....£275  
Taxan Kaga KP910.....£392  
Canon PW1080A.....£289  
Canon PW1156A.....£398  
Shinwa CP80.....£189  
Mannesman Tally  
MT 80.....£189

Juki 6100.....£379  
Brother HR15.....£395  
Keyboard.....£160  
Tractor.....£109  
Sheed Feeder.....£259  
Quendata.....£259  
Daisystem.....£259

★ VALUE ★ PRINTERS ★ PERFORMANCE ★

View WDPRO .....£59  
Wordwise .....£38  
Edword .....£45  
Forecast .....£12  
Desk Diary.....£10  
1.2 OS.....£11  
Basic 2.....£32

LARGE RANGE OF  
BUSINESS & HOME  
SOFTWARE IN STOCK

### SOFTWARE

Microvitec Std.....£199  
Microvitec Med.....£299  
Microvitec Hi Res.....£399

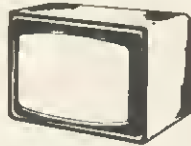

Nordmende 14"  
TV/MON.....£249  
Superb Akai 14"  
TV/MON (RGB)  
I/R Control.....£279



Taxan K12RIX (Std Res).....£219  
Taxan K12R2 (Med Res).....£269  
Taxan K12R3 (Hi Res).....£385

Novex 14" Monitor.....£215  
Taxan 12" Green Mon (P31).....£105  
Taxan 12" Green (P39).....£115

Sony 14" Monitor scoop  
with RG8 input at  
fantastic price.....£172  
(Cables included)

Philips V7001 Green.....£74

★ BETTER PICTURE ★ MONITORS ★ RELIABILITY ★



SSSD 40 Tracks.....£17  
SSDD 80 Tracks.....£19  
DSDD 80 Track.....£27

Storage Boxes (40).....£15  
Storage Boxes (90).....£19

Ribbons, Supplies, Stationery also in  
stock.

### MEDIA

Raven-20 20K Ram Exp.....£66  
Clock Box (inc PSU).....£45  
Terminator Box.....£35  
Printer Server ROM.....£49  
File Server LVL1.....£99  
File Server LVL2.....£249

Econet I/F.....£70  
Acorn 8bit Stick  
Graphics System.....£375  
S-Pascal.....£17  
Micro Text.....£49  
6502 Dev System.....£50  
8CPL ROM.....£99

### BBC ACCESSORIES

To: Microworld Computer & Video Centre Ltd  
12 York Place  
Brighton  
SUSSEX BN1 4GU

OR  
10 The Boulevard  
Crawley  
SUSSEX RH10 1XX

Please Supply:.....

I enclose CHQ/PO or debit my Access/Visa card

No:..... Amount.....£  
Including £1 p&p or £8 for larger items (Printers)

Name:..... Sig:.....

Address:.....

EXPORT orders welcome.  
Goods in stock will be dispatched within 24 hrs.

### MAIL ORDER

Phone Orders: Simply phone to place your orders at Brighton (0273) 671863/698241 or Crawley (0293) 545730 or at Farnham (0252) 726379. Showrooms at Brighton & Crawley. Orders from Schools, Colleges, Universities & Govt. Depts. welcome.

PRICES SUBJECT TO CHANGE WITHOUT NOTICE



**Spanish accents****with Wordwise**

Sir, We have been using the *Wordwise* text editor and have found ways to print correctly every oddity of the Spanish alphabet, without recourse to external software.

*Wordwise* permits the passing of control codes to the printer, and the most tricky point was to add accents without disturbing justification as they have to be placed on top of a vowel. Therefore, a backspace control code has to be sent to the printer after each accent. *Wordwise* ignores, at the time of calculating the justification, any control codes meant for the printer. So one space is deducted by the printer to every justified line per each backspace instruction.

A simple but not so obvious solution is to send to the printer, as a first parameter of the 'OC' (output control code) together with the back space, something that compensates it: the ASCII code for the accent itself! So both the accent and back space are ignored by the justification routine, but recognised and printed correctly by the printer. The ASCII code of the accent prints the symbol and advances one space which is compensated by the backspace. Therefore, lines with accents remain correctly justified.

We could provide anyone interested with different sets of programs for the user defined keys. Spanish characters can be called on my Epson MX80 F/T III by typing <OC27,82,7> at the beginning of the script.

We are now starting to use *View*, which we find more convenient for certain jobs, but do not know how to send instructions to the printer. Can anyone tell us how to write correct Spanish with *View* and the mentioned Epson printer? Thanks in advance.

**IBeng**

BBC Micro Club,  
PO Box 1297,  
Santa Cruz de Tenerife,  
Spain

**Suicide theory**

Sir, Why doesn't Acornsoft do something really useful instead of producing even

more silly games (like *JCB Digger*)?

How about Basic 3, which has all the bugs fixed (as in Hi-Basic for the 6502 second processor).

And a new DFS that allowed more than the ridiculous 31 files, could copy a file onto the same disc (by giving it a new name), and rename 'fred' to 'FRED' would be really useful. It would be even more useful if it could save a file as a number of separate linked blocks across a disc, instead of as one continuous block. The current system must be the cause of 20 per cent of all suicides in this country. When you try and extend a 250-byte file by 10 bytes and the DFS produces a 'Can't extend' message with 190000 bytes free on a disc, you wonder why we don't all give up and return to the trees. (Even the good old fashioned Pet 2040 disc drives could do these things).

And how about \*VIEW to enter *View* (instead of, or as well as \*WORD)? A way to stop a blank line being printed before and after every page, and a way to count lines, or find where a page ends would be useful. It would also be nice if *View* informed the printer driver whether SHEETS or PRINT was being used (so it could turn off the paper end detector or even select printers), and a command to extract the name and address from a file and print it on its own (for the envelope) would probably save a few hundred man years' work across the country.

The list goes on and on, and while much of the Acornsoft software is good there are omissions which wouldn't be too difficult to include.

**Paul Skirrow**  
Derby

**Chess solution**

Sir, With reference to Duncan Miles's letter (September 1984), in which he recommends Computer Concepts' Chess 2.32, your readers may be interested to know that Computer Concepts have dropped their cassette programs to concentrate on ROMs.

However, a slightly improved version (Chess 2.32/1 Version H/E-1) is now available, for the BBC and Electron, from Superior Software for £7.95.

**David Thompson**  
(author of Chess 2.32)  
London

**Torch journal**

Sir, You were kind enough to publish my letter in the February issue of *Acorn User*, which informed your readers of the setting up of the Torch User Group.

I am pleased to say that as a consequence of the large number of replies, we have just published the first issue of the group's journal. The result of this one letter has been a response from several countries round the world. I am still receiving enquiries which refer to that letter of six months ago!

For the benefit of new readers, may I repeat that enquiries about the one and only Torch group should be addressed to me at: 69 The Avenue, Wembley, Middlesex HA9 9PH. An SAE will result in heartfelt thanks and a speedy response.

**Grahame Perchick**  
Torch User Group

**Basic addresses**

Sir, I should like to reply to a letter from Neil Howard of Herts, published in September's *Acorn User*. Neil asks for addresses in the BBC Basic ROM.

Cambridge Microcomputer Centre has published a book entitled *The Advanced Basic ROM User Guide* which meets this requirement exactly. If Neil cares to ring (0223) 355404, I am sure they will be happy to supply.

**C Pharo**  
Cheshire

The book costs £7.95 (plus £1 post) from CMC at 153 East Rd, Cambridge.

**Fox logic**

Sir, G Swain, in your September Letters column, described how his computer is acting as a 'program generator', listing all possible combinations, in order to establish copyright on all programs not yet written (presumably simultaneously rewriting the complete works of Shakespeare, in both ASCII and teleprinter codes, in several different languages).

I feel I should warn Mr

**ASK a silly question, pass a fair comment, stage an angry protest—we don't mind what you write to us about (or about us!). Keep 'em short, keep 'em sweet, but keep 'em coming! The address is: Letters, Acorn User, Redwood Publishing, 68 Long Acre, London WC2E 9JH.**

Swain, however, that he may be heading for legal difficulties. Some of his listings will undoubtedly begin with the string 'REM (C) Martyn Fox'. If he attempts to give away permission to copy those programs, I shall sue.

**Martyn Fox**  
Windsor

**Handicap****database**

Sir, We are establishing a database of software for the handicapped—Bardsoft. Briefly, each entry will contain a description of the programs, the handicaps they are suitable for, the type of computer system required, name and address of supplier/developer and price, etc. This information will be made available through printouts in answer to specific enquiries.

The aim of Bardsoft will be to facilitate the exchange of information on software relevant to any aspect of the lives of handicapped people. One major addition will be the concerted effort to promote the database, and therefore the software, abroad.

As we are currently collecting and processing information, we would be pleased to hear from any of your readership who may wish to contribute to Bardsoft. For further information please contact me at Handicapped Persons Research Unit, Newcastle-upon-Tyne Polytechnic, 1 Coach Lane, Coach Lane Campus, NE7 7TW. Tel: (0632) 664061.

**Peter Curran**

**Software search**

Sir, Schools in NSW Australia have in the last year begun to use the BBC micro. As we are only in the early stages of BBC use we are suffering from a lack of public domain (ie free) software. We would appreciate any help from readers who could advise us as to where we could obtain this software. Our address is: Trinity Grammar Preparatory School, 125 The Boulevard, Strathfield, Australia 2135.

**Richard Walker**

# AUTUMN CLEAR-OUT

Making space for the new crop of programs—Kansas is offering  
**Any two cassettes at HALF PRICE**  
Yes—buy any two (or more) programs and you can have them at HALF PRICE!

## WORD PROCESSOR #

A full feature word processor using the professional Embedded Control Characters plus the capability to alter the printer output to suit any printer, including the new generation NLO printers. Program contains disk conversion program. Full details in the September Acorn User. Usually £22.50. But buy with any other program—£11.25.

## SWORDS AND SORCERY

The only Quest for the BBC. Think of an Adventure then think of very much more, for no longer are you alone, but have helpers, and others you can recruit or abandon to gain more fighting ability, magical prowess, etc., etc.. Full details in the August issue of Acorn User. Usually £10.35. But buy with any other program—£5.15.

## PINBALL ARCADE #

The one where you create, play and save your own Pinball boards. Five 5 star reviews to its credit. Another unique Kansas winner. Usually £10.35. But buy with any other program—£5.15.

## FIVE SPHERES OF GOLIATH

A packed Adventure—with sound. Like all Kansas Adventures this is completely logical, has a split screen, full game saving facility, colour and our telephone 'help' service. Usually £10.35. With any other—£5.15.

## MICROTYPE #

Now accepted as the standard in typing tutors. Used by over 150 schools and colleges as well as the training schools of many major industries. It is essential to be able to touch type if full use of the BBC computer is required. Usually £12.50. But buy with any other program—£6.25.

## DATA FILE #

The one which YOU define the number of fields, their length and title. All the normal facilities plus the ability to search both at the beginning and anywhere within a field. Easy editing and sorting of files and includes a two-way printer dump. Usually £12.50. But buy with any other program—£6.25.

## MAGIC ADVENTURE

The children's Adventure with over 20 colourful pictures, operated very easily by the function keys. wonderful magical journey for children between four and eight. Now in use in 108 primary schools throughout the country, and played and loved by children everywhere. Usually £8.50. Buy with any other program—£4.25.

## ADVENTURES #

The three traditional Adventures are Dracula Island, Ring of Time and Revenge of Zor. All completely logical with the expected split screen, colour and game saving facility. The first two are available on the Electron. Normally £9.50 each. But buy any one with another program—£4.75.

## ARCADE GAMES #

Arcade games include Galactic Firebird, Bomber Scramble, Cosmic Fighter and Fighter Pilot. All fast-action games with colour and sound. Fighter Pilot is available for the Electron. Normally £9.50. Buy with any other program—£4.75.

*All programs available for the BBC model B # denotes available for the Electron*

**All the cassette based programs shown in our catalogue are included in this offer Ring 0246 850357 any time if you want a copy quickly**

**OFFER CLOSSES WEDNESDAY 31st OCTOBER**

**KANSAS** the longest established software publisher in the business. Now in our seventh year, backed by 28 years media publishing from the same address!

The Service is the best in the country. Every order, whether cheque or credit card, is cleared the very same day it is received, and despatched by our private Post Office collection at 4.30 every working day. All first class and by the faster metered mail.

The Guarantee. Should any program fail, no matter how caused, it will be replaced absolutely free of charge, this year, next year or in ten years...yes, it's guaranteed for life!

Backup. Unlike the chain stores, there is always someone on hand should you be in difficulty. If you want delivery tomorrow—simply ring before 4pm using Access, Diners or Barclaycard.

# Kansas

Kansas City Systems, Unit 3, Sutton Springs Wood, Chesterfield, S44 5XF. Tel 0246 850357



# MIRROR AND CLONE



In the concluding part of his sprite generator series, Harry Sinclair shows some fancy tricks

**M**E and my big mouth. I said that adding extra facilities to the *Design* program (September issue) would be fairly simple. So it proved to be. The difficult bit was getting it all to run without the machine complaining there was no room. I spent ages writing quite a complicated bit in Basic and had to write it all again in assembler to cram it in. Then I ran out of room for any more machine code. My kingdom for a second processor.

However, it didn't work in a card-canning factory for nothing - I got all the cardline I could wear. I've managed to concentrate it enough, although the screen messages are a bit cryptic in parts, and all notions of 'meaningful' variables and procedure names have taken some cosh. Nonetheless - and that's the sort of word that a man who's had to write in a language consisting of 'ig', 'og', and 'ug' for some time is prone to use - the program now offers all the promised facilities. You can edit previously designed sprites, clone (i.e. create a copy of a design shifted one pixel to the right), generate mirror images, or design new sprites. The program is now menu-driven, as am I, so you can hop from one course to another and then go back if you want.

To create the space for the new procedure, PROCASSEMBLE has been removed. This, with additions, is run separately once to generate the object code and is then of no further use.

I've tried to keep the number of other changes to a minimum, but naturally one or two things have had to be moved about. Essentially, I've changed the start of the program, removed the assembler part and tacked on the new procedures at the end.

The workings of the new parts are fairly simple. Let's start with mirror images. In this program the image

reversal is round the Y axis, so if you have a sprite man facing right, the mirror image would show him facing left. This means that you have to deal with the data in rows across the screen. The rightmost byte will become the leftmost and vice-versa. In addition, the pixels within the bytes will have to be reversed - if the rightmost byte was red/green, the new leftmost byte will become green/red.

Once you have designed a sprite, this sort of manipulation is quite easy. Say you have a sprite that is eight pixels wide (four bytes)



In mode 2). If you remember my descriptions of screen layout in parts 1 and 2 (September/October), you will know that the four bytes forming the top row of the sprite are offset from the start position by 0, 8, 16 and 24 bytes respectively. What you have to do is reverse the colour information within each byte and then move the data in byte 0 to byte 24, the data in byte 8 to byte 16, and vice-versa.

Writing a loop to access all the bytes in a sprite can make you walk with a bit of a limp, but the colour reversal is achieved quite

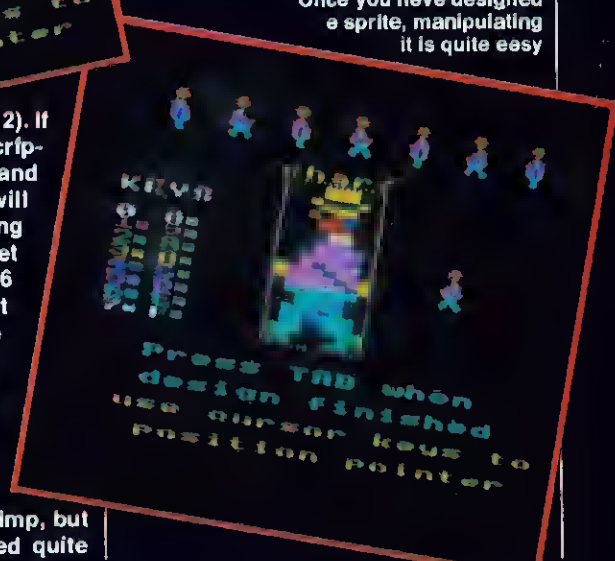

easily by employing another of those very useful logical operators, AND. All this does is a straight comparison, bit by bit, of two numbers. For example, if you have the numbers 182 and 93 (decimal), they are 10110110 and 01011101 in binary. The operator AND compares them digit by digit and if both digits in each pair are set to 1, the corresponding digit in the result is set to 1, otherwise it is set to 0. So, in this case the comparison would look like this:

```
182 = 10110110
AND
93  = 01011101
-----
RESULT = 00010100 = 20
```

The results aren't really meaningful as quantities. ANDing is used to mask out specific bits in a byte. The colour information in a mode 2 byte is arranged in a particular way. The odd bits, starting at bit 7 and going down to bit 1, give the colour number of the left-hand pixel; and the even number bits 6 to 0 give the right-hand colour number. Bit 7 is the leftmost bit when the number is written down. So if you AND a byte with &AA - 10101010 in binary - you will mask out all the right-hand colour information. ANDing with &55 - 01010101 in binary - will delete the left-hand colour information. Pretty useful, eh?

Once you've masked out the bits you're not interested in you can shift the remaining ones over one position to provide the new colour information for the other pixel. Shifting is easy in assembler (it's about all that is), where you have the instructions ROL and ASL which both shift left, and ROR and LSR which both shift right. Since shifting right one binary place is the same as dividing by two, and shifting left is the same as multiplying by two, it's easy to show in Basic how to perform colour swaps.

If you type in the small demo (listing

Once you have designed a sprite, manipulating it is quite easy



BBC MODEL B 1.2 OS

# TEETRAAL



# ULTIMATE PLAY THE GAME

Available from W.H.Smith, John Menzies, Boots, Woolworths,  
and all good software retailers.  
Also available from Ultimate Play The Game,  
The Green, Ashby-de-la-Zouch, Leicestershire LE6 5JU

£7.95



```

10 MODE2
20 C%=&4C80:      REM arbitrary screen location
30 ?C%=&57:       REM flashing b/w and red
40 A%=?C% AND &AA: REM mask out r/hand colour
50 A%=A%/2:       REM shift right
60 B%=?C% AND &55: REM mask out l/hand colour
70 B%=B%*2:       REM shift left
80 newbyte=A%+B%: REM put them both together
90 C%?16=newbyte: REM write the new combination to the screen
    
```

**Listing 1. Running this demo program displays two bytes on the screen**

1) and run it you will see two bytes displayed on the screen. The first one is flashing black/white and red, and the second one has the colours reversed.

If you want to know how the colour numbers are arrived at in the first place, see my article in the September issue – it's easy.

The mirroring process is carried out on the first four sprites in memory, sprites 0 to 3, and the results are put into the data areas for sprites 4 to 7. If you design the cartoon frames for a sprite moving left to right, for instance, selecting the mirror option will produce exact copies but with the sprite moving right to left.

Cloning is similar to mirroring except



that the intention is to make a copy of a sprite but with the pixels moved one position to the right. The idea is that you can then alternate the two designs and make your character move across the screen very smoothly, since it will be moving in steps of one pixel rather than two. It also moves at half the speed, of course, all other things being equal.

The difference with cloning is that instead of just changing colour positions within a byte, the right-hand pixel data in one byte has to be moved into the left-hand pixel position of the next byte horizontally. Again, the operator AND comes to the rescue and the pro-

cess itself is not difficult, although writing the loop controlling it caused a dull throbbing in my ankles. This intensified when the 'no room' message turned up. Rewriting it in assembler was actually a pleasure – the logic is so much simpler and clearer.

The clone procedure operates on one sprite at a time, putting the clone data into the next sprite position. This imposes limitations, since the program works out where the next sprite data position is by using the address table. The way things are set up, sprite 2 has the same address as sprite 0, and sprites 4 and 6 are similarly afflicted. The result is that an attempt to clone sprite 1 will bung the new data into the area used by sprites 2 and 0. However, since it's unlikely that you will be wanting to use multi-frame animation and pixel-by-pixel movement at the same time, this should not prove problematic.

The cloning procedure also carries out an important check. For the sprite to be moved over there must be enough room on the right-hand side of his 'data box'. If you want to make clones, ensure that the original design has at least one pixel free (ie, black) all the way down the right side. The world won't end if you don't – you will just get a message telling you it can't be done. In fact, it could be done but you don't want crucial bits falling off the right side of your sprites.

Using the final program is just a matter of picking a number from the menu, as in a Chinese takeaway. You are offered five options. The first three are concerned with existing designs – EDIT, CLONE, MIRROR. You will be asked if the designs are already in memory and, if not, what the sprite file is called. Inserting the correct disc or tape and pressing Return will then load the data and carry out the appropriate procedure. In the case of EDIT and

CLONE you will be asked for the number of the sprite first. Of these first three options, only EDIT causes you to enter the editor – the other two just do their thing and tell you when they've finished. If you want to have a look at their handiwork, use EDIT afterwards.

Option 4 allows you to design new sprites. It differs from EDIT in that it clears the data and address areas and asks you how wide you want the sprites to be. You can use the editor to design new sprites but their width is fixed at that of the sprites already in memory. Selecting 4 is rather drastic since it destroys whatever designs you may have had in memory at the time.

Finally, option 5 allows you to save your designs. It checks through memory to see how many designs you have made, where they are, and then displays the information. You are asked if you want to save the sprite data, and if so, what you want to call it. Saving, like loading, is automatic.

Instructions for modifying the original *Design* program and creating the machine code, together with the listing for the new bits are on yellow pages 103 to 107.



**The final version of Design is listed, together with full instructions, on yellow pages 103-107**

# Ain't She Sweet



**AND WITH A  
VERY TRIM LITTLE  
FIGURE £159.00** (inc. VAT, Postage  
and Packing)

The Bevan Nymph 3-inch Compact Floppy Disk Drive is tailored for use with your BBC Micro and is compatible with all disk interfaces and comes complete with cables, comprehensive manual and utilities disk.

The Nymph has been developed by Hitachi and its rotation speed, data transfer rate, recording capacity per track and other specifications are designed to be the same as those of the conventional 5.25-inch drives and is therefore, fully compatible.

The Nymph is available either as a flipable unit with a storage capacity of 100K each side or as a double sided unit allowing access to either side of the disk without removal. It can be purchased either as a single or double drive unit with or without power supply thus enabling you to choose between using the BBC's power supply or utilising its own.

Prices quoted are inclusive of VAT, postage and packing.

## RANGES AVAILABLE

- ★ ST1 Single Flipable £159.00
- ★ ST2 Single Non-Flipable £199.00
- ★ ST3 Single Flipable with PSU £179.00
- ★ DT1 Dual Flipable £269.00
- ★ DT2 Dual Non-Flipable £359.00
- ★ DT3 Dual Flipable with PSU £319.00

## DISKS

Double Sided (100K × 2) at £4.75 each  
OR pack of five £22.00  
**DEALER ENQUIRIES  
WELCOME**

## FEATURES

1. Compact and lightweight: Almost half the volume and weight of the "Mini Floppy Disk Drive."
2. One-touch disk load/unload.
3. Hardened plastic center hub for improved reliability.
4. Rigid compact floppy-disk case with automatic head-window shutters for media protection.
5. Low power consumption: Almost half that of the "Mini Floppy Disk Drive".
6. Brushless direct drive motor: Highly reliable, brushless direct drive motor offers longlife operation.
7. High-performance head-access mechanism using step motor and steel band.
8. Narrow write and wide read heads with a tunnel erase head using Mn-Zn ferrite.
9. 12 month warranty.

**BEVAN TECHNOLOGY - A NAME TO LOOK OUT FOR**

To: Bevan Technology Ltd., Gresham Chambers, 14 Lichfield Street, Wolverhampton,  
West Midlands WV1 1DG. Tel: 0902 23546

Please supply: \_\_\_\_\_

Name \_\_\_\_\_ Serial No. \_\_\_\_\_

Address \_\_\_\_\_ Disks \_\_\_\_\_

I enclose my payment of £ \_\_\_\_\_

Post Code \_\_\_\_\_

Tel. No. \_\_\_\_\_

Date \_\_\_\_\_

A member of D. F. Bevan (Holdings) PLC



# HEARD ABOUT THE COMPUTER MEGA-MAG?

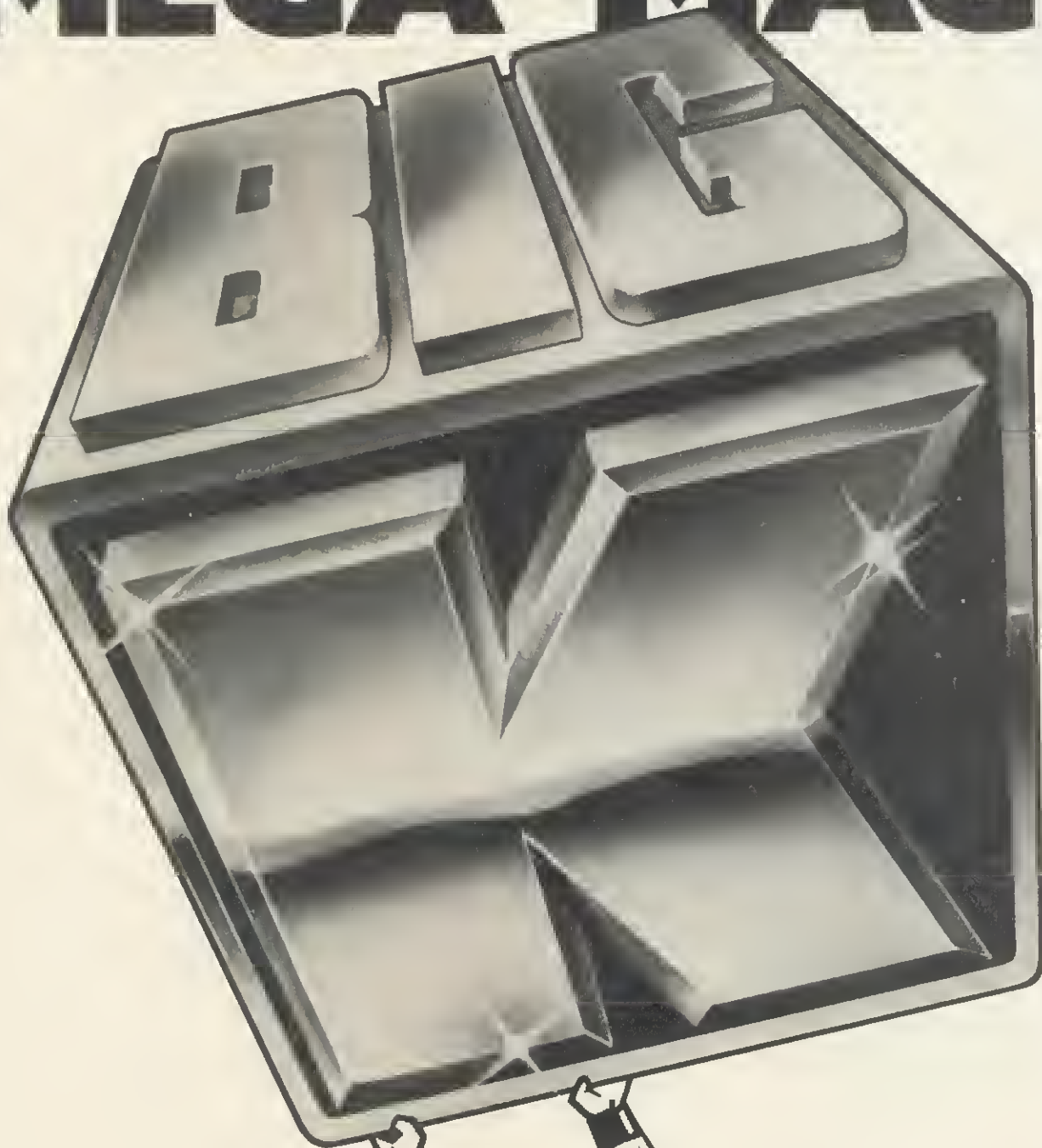

There's only one Big K.  
A computer mega-mag that gives  
it to you straight. No frills. No waffle.  
No blurb. No unnecessary rubbish. Just  
the facts, straight, humorous, critical.  
Take this month for example.  
Bursting with news, reviews,  
features and programs.

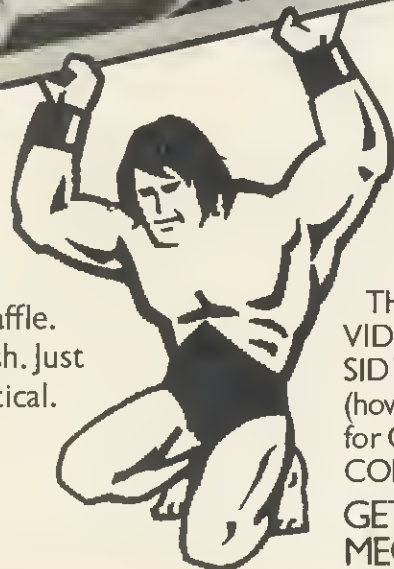

It's out now. The November issue of  
Big K including: STRONTIUM DOG and  
THE FALL GUY (exciting new games),  
VIDEO DISEASES (how to cure them),  
SID THE COMMODORE SOUNDCHIP  
(how he does it), PLUS a host of games programs  
for ORIC, ELECTRON, SPECTRUM,  
COMMODORE 64, and BBC.  
GET YOUR MITT ON THE COMPUTER  
MEGA-MAG FOR JUST 85 PENCE.

# OUR DOUBLE-SIDED 3" DISC DRIVE. A TRIUPLE OFFER.

Opus have a triple offer of 3" disc drives for those who wish to improve their micros.

The disc drive is compatible with the BBC Micro, has a direct drive mechanism, is double-sided and comes with a comprehensive manual.

And with every purchase, a 3" utilities cartridge will come free.

Our offer also includes VAT, all necessary leads

and carriage along with a two year guarantee—which is a year more than any other company can offer.

You can order by posting off the coupon below or calling at Opus Supplies Ltd.,

158, Camberwell Road, London SE5 0EE.

01-701 8668 or 01-703 6155.

We are open 9–5.30 Monday to Friday and 9.00–1.00 p.m., Saturdays.

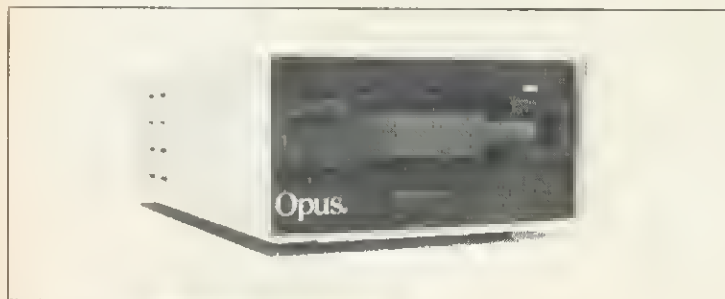

## 3" DISC DRIVE

You can buy this 500K (Unformatted) double sided disc drive for the same price that other companies sell single drives for. The drive heads read and write to and from both sides of the disc cartridge, giving you twice the on-line capacity of single 3" drives.

Normally ~~£229.95~~

Now £199.95

**SAVE £30**

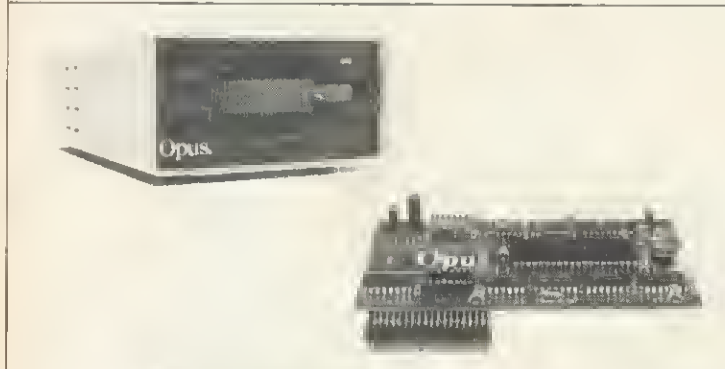

## 3" DISC DRIVE AND DOUBLE DENSITY INTERFACE

If you currently run your program on a cassette recorder, you'll need to upgrade your micro in order to use a disc drive. This offer not only gives you an interface, but it effectively doubles the capabilities of the drive—giving you 350K of usable capacity instead of the 200K normally achievable.

Normally ~~£359.95~~

Now £299.95

**SAVE £60**

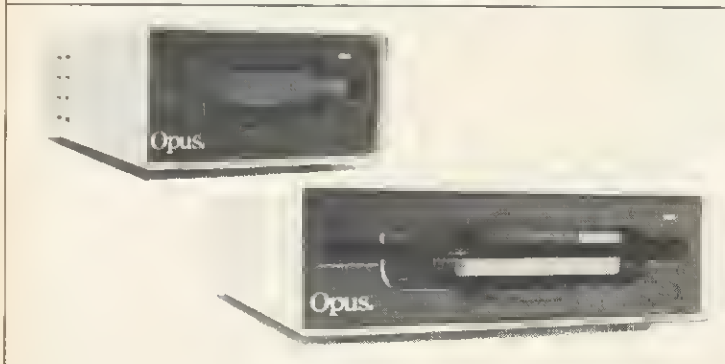

## 3" DISC DRIVE AND 5 1/4" DISC DRIVE

Both drives come 'daisy chained' (or linked) together. They're completely compatible and will allow you to down load all those programs you made on 5 1/4" floppy discs onto a robust 3" cartridge.

Normally ~~£379.95~~

Now £329.90

**SAVE £50**

Quantity	Description	Price

I enclose a cheque for £\_\_\_\_\_ TOTAL

or please debit my credit card account with the amount of £\_\_\_\_\_

My Access Barclaycard (please delete)

No. is \_\_\_\_\_

To: Opus Supplies Ltd., 158 Camberwell Road, London SE5 0EE. Please rush me the following: (ALL PRICES INCLUDE VAT & CARRIAGE.)

Name \_\_\_\_\_

Address \_\_\_\_\_

\_\_\_\_\_

Telephone \_\_\_\_\_

**Opus.**  
Opus Supplies Ltd.

AC33



# mixed moods

## two amazing new games

### from Software Invasion...

## 3D Grand Prix

Software Invasion games are available from WH SMITH, HMV, all SPECTRUM SHOPS and over 1,000 retail outlets.



This is the game you've been waiting for! A 3D high speed formula 1 car race round 8 different international circuits.

Just look at these amazing features:-

- \* Bends arranged to simulate 8 actual Grand Prix circuits.
- \* Working cockpit - Rev. counter, Speedometer, Temperature Gauge, gears, moving steering wheel.
- \* Other cars which alter in perspective and size as they overtake.
- \* Signposts.
- \* Realistic sound effects such as engine noise, skids and crunching shunts.
- \* Keyboard or Joystick control.
- \* Volume control.

Runs on O.S. 1.0 or greater. More than a year of man hours have gone into creating this superb game.

BBC MICRO MODEL B

£9.95 CASSETTE

£11.95 DISK

Authors: Mick O'Neill and Dave Mendes

Blitzkrieg is a 3D Tank Battle from the same author as our Best Seller "3D Bomb Alley".

This program is probably unique in the fact that all the graphics were created with the help of models, a video camera, a video digitiser and some very special Light Pen software.

This has resulted in extremely fine detail and realism, with fast moving real time graphics - you don't have to wait for the screen to be updated between each move.

Features include:-

- \* Detailed scrolling landscape.
- \* Rotating tanks.
- \* Detailed explosions.
- \* 3D shell movement.
- \* Recoiling barrel.
- \* 3D sound.
- \* Keyboard/Joystick option.
- \* Freeze game facility.
- \* Optional sound.
- \* Demo' mode.
- \* High score & ranking system.

BBC MICRO MODEL B

£7.95 CASSETTE

£9.95 DISK

Author: Simon Vout.

## Blitzkrieg

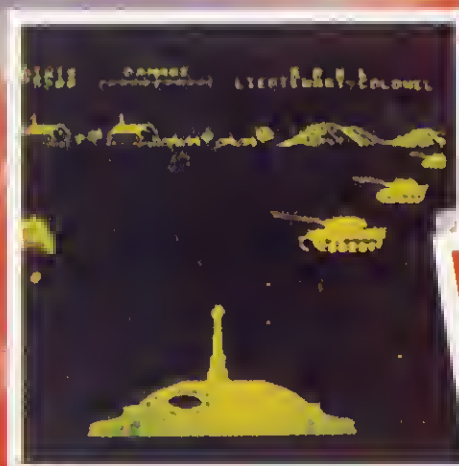

NOW WITH COLOUR GRAPHICS!  
(BBC VERSION ONLY)



## SOFTWARE INVASION



50 Elborough Street, Southfields, London SW18 5DN

### HOW TO ORDER

You may purchase any of the games above direct. All you have to do is write your name and address on a piece of paper, item(s) required, enclosing your cheque/P.O. made payable to SOFTWARE INVASION.

Please allow 7 to 14 days for delivery (orders are normally dispatched within 48 hours!)

OVERSEAS ORDERS. Please add £1.00 per game

DISTRIBUTORS, MULTIPLE STORES, RETAILER GROUP AND EXPORT INQUIRIES INVITED.

Do you write your own programs? If you have an unusual program which can meet our standards you could be earning a substantial sum every week! Why not take advantage of our sought after reputation. Write now!

other SOFTWARE INVASION GAMES... send for full list now!



# Roll over B

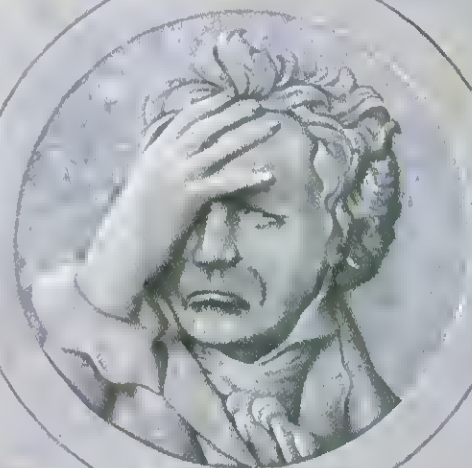

R.I.P.

LUDWIG VAN  
BEETHOVEN

1770 - 1827

AVAILABLE ON



&





# Beethoven.

If you can play the comb and paper this is the music program for you.

The new Music System from Island Logic. That's what it's called. And what it actually does, in musical terms, basically, in a word, is everything.

You don't need any musical ability. The program is designed for the man in the street (the one carrying the BBC B micro).

And you don't need to be able to read music.

In fact all you need is one fully operative finger, one eye and one ear (two or more may be an advantage but are not essential).

You can create noises with the program (sounds of your own creation).

Or you can recreate the sounds of conventional instruments. Wind, strings, percussion and so on.

Or you can take tunes from the Song & Sound Library on the program and murder them in the name of art.

Then with these sounds you can build tunes before your very eyes - or ears.

Adding, taking away, juggling, jiggling, twisting the sounds, wowing the next door neighbours.

The program will even print out your compositions in proper music-manuscript form. And you don't need any knowledge of music to do it.

To Ludwig the prospect of music composition by the masses must make him turn in his grave.

But to us the prospect is heartening. Mr Beethoven, as you decompose, we compose.

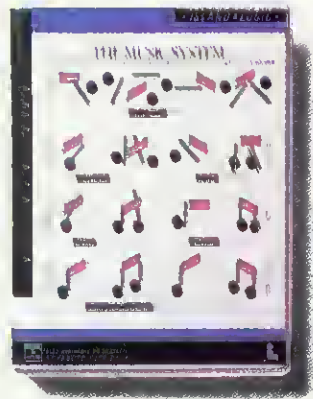

DISK PACK £24.95 INC VAT CASSETTE 1 (SYNTHESISER, KEYBOARD, SONG AND SOUND LIBRARY) £12.95 INC VAT CASSETTE 2 (EDITOR, PRINT-OUT, SONG AND SOUND LIBRARY) £12.95 INC VAT PLEASE ADD £1.25 P & P PER ORDER AND SEND A CHEQUE/PO. ACCESS OR VISA CARD NO WITH ORDER TO: SYSTEM, 12 COLLEGIATE CRESCENT, SHEFFIELD S10 2BA. (CREDIT CARD HOTLINE 0742 682321).

THIS PROGRAM IS RECORDED ON THE HIGHEST POSSIBLE QUALITY DISKS, AS SUPPLIED BY MEMOREX



In recent months letters have been flowing into the *Acorn User* office asking for articles covering the more esoteric details of assembler such as floating point variables and trigonometric functions such as cosines, sines and drawing of machine code circles. We hope to provide the answers to most of your points in a series of articles, starting in this issue with an examination of how floating point numbers are stored within the Beeb. Program examples demonstrate the use of some ROM-based routines.

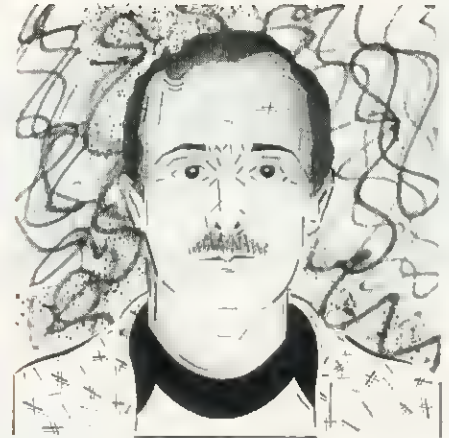

Representing an integer value in both binary and decimal format is straightforward. Consider the value 128.125. In binary the entire value would be represented by:

10000000.0010

The binary value to the left of the binary point – or 10000000, is 128, where only bit 7 is set and this has a weight of  $2^2 \cdot 2^2 \cdot 2^2 \cdot 2^2$ , or 128. The weight of values to the right of a binary point are progressively halved, thus the weights of the first four fractions would be:

0.5 0.25 0.125 0.0625

All we need do is to make up the value of the decimal 'fraction' of the number by setting and clearing the correct sequence of bits. As an example, to represent 0.125 we need only to set one bit, in this case .001. Consider the decimal value 15.625. The 15 converts to 1111 binary and the 0.625 part can be defined as .5 plus .125, thus the binary 'fraction' is .101 (figure 1). Thus 15.625 produces a binary value of 1111.101.

74

# FOLLOW THE **THE** **FLOATING** **POINT**

Bruce Smith introduces a new series designed to help you learn assembly language without tears

**T**HE term 'floating point' is applied to a numeric value that may acquire a fractional part, expressed in decimal terms with figures to the right of a decimal point—for example, 123.456. The Beeb's Basic interpreter assumes that any variable it encounters is a floating point value unless a % or \$ sign appears immediately after the variable name. The % denotes an integer or whole number value, while the \$ denotes an ASCII string variable. It is important to remember that a floating point variable may still hold a whole or integer value, thus the two assignments

```
FIRST = 123.456
SECOND = 123
```

both assign values to floating point variables even though the latter is an integer.

In BBC Basic floating point variables have what is known as 10-digit precision, displayed with nine digits and an 'exponent' in the range +37 to -38. The exponent of a number is simply a scientific notational form of representing numbers. For example, the number

123.456 could be expressed notationally as:

0.123456E+3

The E denotes an exponential value and the +3 the fact that the decimal point has moved three places to the left. Converting an exponentially represented value back to its normal form simply requires moving the decimal point the number of places to the right specified by the exponent. The value:

0.567345E+5

reverts to:

56734.5

Another, more common way of expressing an exponential value is to use a 10 and add a superscript to this to provide the exponent. Our first example could be expressed as:

0.123456\*10<sup>3</sup>.

Similarly, the decimal value 0.000123 can be written as 0.123E-3 or  $0.123 \cdot 10^{-3}$ , the -3 indicating that the decimal point must be moved three places right in a negative direction to restore its original representation.

$$.625 = .5 + .125$$

	.5	.25	.125
.	1	0	1

Figure 1. Calculating the 'binary' fraction of a number

As with decimal values, binary numbers can be manipulated to make them easier to handle and less memory-hungry by converting them to two components, in this instance the binary exponent and the binary mantissa (the mantissa is the number portion of a value). Figure 2 shows how these sections could be arranged in memory using six bytes per number. The sixth byte here is required to hold the sign (positive or negative) of the number—in fact, only a single bit need be used (bit 7), as 0 and 1 can denote a positive and negative mantissa respectively. The binary exponent occupies just a single byte and this is used to represent both positive and negative values by adding the value to

page 77 ►



# Take Advantage of us!

50 s/s d/d disks + box – £50 plus VAT + p&p

50 d/s d/d disks + box – £75 plus VAT + p&p

Discotek sells disks and accessories, we'll sell them to practically anyone, anywhere. So when we got a telephone order for a lot of storage boxes and disks we didn't waste any time and stocked up. Then the order was cancelled. So we're having to let them go at cost, in fact, less than cost.

For just £50 we can supply a rigid, high impact plastic storage box, with four dividers packed with 50 single-sided, double-density disks. The same storage box filled with 50 double-sided, double density disks will cost just £75. And all carrying our five year guarantee – if a disk is faulty send it back for two free replacements.

To order just clip the coupon below.



To Disco-Technology Ltd,  
20 Orange Street,  
London WC2H 7ED

Please rush me \_\_\_\_\_ qty storage boxes filled with 50 single-sided

50 double-sided  disks at £59.50 or £87.25 respectively.

(£2 already added for p&p and insurance) I enclose a cheque for £ \_\_\_\_\_

or debit my Access card No. \_\_\_\_\_

Name \_\_\_\_\_ Signature \_\_\_\_\_

Address \_\_\_\_\_

Postcode \_\_\_\_\_ Telephone \_\_\_\_\_

To Disco-Technology Ltd,  
20 Orange Street,  
London WC2H 7ED

**DISCO-TEK**  
COMPUTER PRODUCTS

© Certain Advertising Ltd

# SLOGGER ADVANCED SYSTEMS



**ROMBOX** is a sideways ROM extension unit which enables many existing BBC ROM based programs to be run on the BBC or the Electron. Fully compatible with either computer, it is strongly constructed and will also support the Plus 1 on the Electron. ROMBOX is supplied with comprehensive instructions and an inter-connecting cable for the BBC.

**BBC** £49.95 (including cable)  
**Electron** £39.50

**STARMON** is the only machine code monitor for the Electron and provides a powerful and easy to use command repertoire for advanced debugging and machine code programming. A ROM extension unit is required when used with the Electron. STARMON is also available for the BBC and both versions are supplied with a comprehensive and easy to follow User Manual.

**BBC** £27.50  
**Electron** £22.50

All prices include V.A.T.  
and postage and packing  
within the U.K.



Dealer enquiries are welcomed. Available from good computer shops or from:  
Slogger Limited, 215 Beacon Road,  
Chatham, Kent. ME5 7BU.  
Telephone: Medway (0634) 811634.

## University Software

### UNISTAT

#### STATISTICAL PACKAGE

**MULTIVARIATE REGRESSION:** Main output consists of estimated coefficients, t-stats, standard errors,  $R^2$ , corrected  $R^2$ , standard error of regression, F stat, and Durbin-Watson stat. Further output options: multiple correlation matrix, var-covar matrix, ANOVA of regression, residuals, plot of residuals, interpolation. Data options: Log/ln option for each variable, no-constant regression, choice of dependent variable, selection of independent variables, auto-remission of linearly dependent variables.

**ANALYSIS OF VARIANCE, SCATTER DIAGRAMS AND TIME SERIES PLOTS:** One-way and two-way (without interaction) ANOVA tables, scatter diagrams of paired data and time series plots with auto-scaling.

**STATISTICAL TESTS, CORRELATION COEFFICIENTS AND PROBABILITY DISTRIBUTIONS:** Basic stats on each column of data (size, sum, mean, variance, std. dev.). Chi-square (contingency table), t (one sample, two sample, paired), F, Mann-Whitney U, and Wilcoxon signed rank tests, Pearson's, Spearman's rank and Kendall's rank correlations. Chi-square, t, F, binomial, Poisson and normal (std., non-std.) distributions. Results of tests and correlations are displayed with significance levels.

**DESCRIPTIVE STATISTICS, FREQUENCY DISTRIBUTIONS AND HISTOGRAMS:** Analysis of raw data or data with frequency counts. Raw data sorted and grouped. Choice of lower bounds and class intervals. Absolute, cumulative and relative frequencies. Histograms with up to 200 classes. Output displays sum, mean, mean deviation, median, variance, std. dev., 3rd and 4th moments, skewness, kurtosis, range, etc.

All programs are datafile compatible with Matrix Operations program in UNIMAX package. Data matrix capacity examples (columns by rows): **CBM-64:** 2x1250, 5x700, 10x380, **BBC-B:** 2x750, 5x400, 10x200, **48K Spectrum:** 2x1800, 5x900, 10x500, **CBM-64 (disk/cass):** £85, **BBC-B (disk/cass):** £85, **48K Spectrum (mdvcart/cass):** £60

### UNIMAX

#### LINEAR PROGRAMMING PACKAGE

**LINEAR PROGRAMMING:** A powerful and instructive optimisation program capable of handling all sorts of linear programming problems (min/max, any combination of  $\leq$ ,  $=$ ,  $\geq$  constraints and  $x_i \geq 0$ ,  $x_i \leq 0$ ,  $-\alpha < x_i < \alpha$  sign constraints). Primal, canonical, dual and their solutions are displayed in standard mathematical form. Unbounded problem and no feasible solution prompts. Edit option for all inputs. Capacity examples (variables by constraints): **CBM-64:** 10x35, 25x30, 40x25, **BBC-B:** 10x25, 20x20, **48K Spectrum:** 10x45, 25x35, 50x25.

**MATRIX OPERATIONS:** Inversion, transposition, determinant, pre- and post-multiplication, scalar multiplication, addition and subtraction of matrices and vectors. *Matrix operations can be used as the input of matrix operations without rekeying.* Matrices can be saved or loaded at any stage. Datafile compatible with UNISTAT package. Capacities: **CBM-64:** 35x35, **BBC-B:** 25x25, **48K Spectrum:** 45x45.

**CBM-64 (disk/cass):** £60, **BBC-B (disk/cass):** £60, **48K Spectrum (mdvcart/cass):** £45.

ALSO AVAILABLE FOR 48K SPECTRUM  
INTRODUCTION TO ECONOMICS SET: £25  
ECONOMIC GEOGRAPHY: £9.95 • BIBLIOFILE: £9.95  
POLYNOMIALS: £6.95 • INTEGRATION: £6.95

To: **UNISOFT LIMITED**  
(Dept. D) 29 ST PETER'S STREET, LONDON N1 8JP.  
TEL: 01-359 0978

Prices include VAT and delivery within the UK. For orders from Europe add £1.50, outside Europe £3.00 per item for airmail post. Dealers enquiries welcome.



### COMMODORE 64, BBC-B, 48K SPECTRUM

\* Comprehensive user manual \* Full data handling facilities (display, print, change, save, load)  
\* All results can be printed out \*





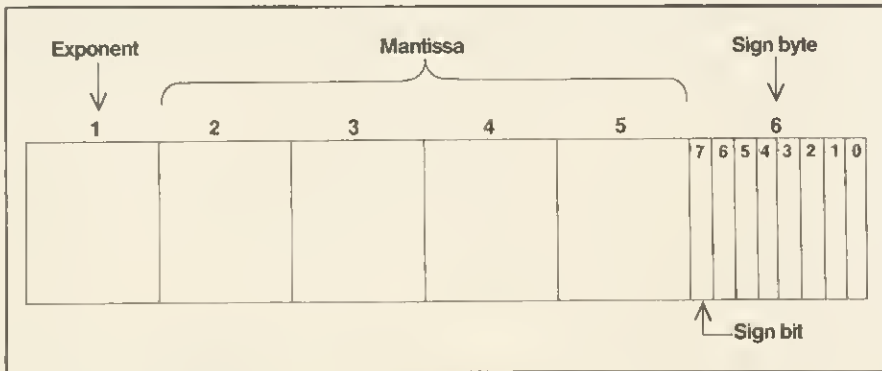

Figure 2. How the binary exponent and mantissa and sign bit are arranged in memory

◀ page 74

or subtracting it from 128. For example, an exponent value of +15 is represented by:

$$+15 = 128 + 15 = 143$$

whereas a negative exponent of -15 is expressed as:

$$-15 = 128 - 15 = 113$$

To save memory and improve handling of the floating point values the Basic interpreter 'normalises' them. This process involves shifting the bits along until a 1 is encountered at the most significant bit's position.

Consider the hexadecimal value &345. Converting this to its two-byte binary representation gives:

$$\&345 = 00000011 \ 01000101$$

Because we are now working to a base or radix of two the exponent itself becomes two, so transformed exactly as it stands the above binary value could be read as:

$$00000011 \ 01000101 * 2^0$$

Now to normalise this value we need to 'float' the binary point along to the left until it sits directly in front of the leftmost 1. Figure 3 illustrates the movement of the point through the binary number. To calculate the final exponential value we first need to count the number of characters the point has floated along to the left - in this case 10. Thus:

$$\&345 = 0.11010001 \ 01000000 * 2^{10}$$

The final byte has been padded out with noughts to keep the two bytes distinguishable. As the number has a positive value 128 must be added to it to obtain the final exponential form:

$$10 + 128 = 138 = \&8A$$

Now we need to manipulate the mantissa. This uses four bytes, two of which we already have, the remaining two bytes being padded out with zeroes to give:

$$11010001 \ 01000000 \ 00000000 \ 00000000$$

To complete the normalisation we must indicate a positive value by placing a zero into bit 7 of the sign byte. The complete representation of &345 in floating point is therefore:

Sign	0xxx xxxx
Exponent	1000 1010 &8A
Mantissa	1101 0001 &D1
	0100 0000 &40
	0000 0000 &00
	0000 0000 &00

The x's in the sign bit may have any value.

The above example uses a whole number, with no decimal 'fraction', but the technique to normalise a truly decimal value is the same. For example, the decimal value 241.75 can be expressed in binary as:

$$1111 0001.11$$

Normalising this would give:

$$.11110001 \ 11000000 \ 00000000$$

with an exponential value of  $128 + 8 = 136$ , or &88.

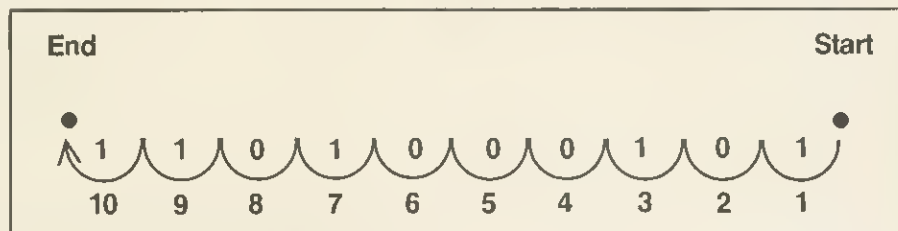

Figure 3. The movement of the binary point

```
L 1C00J1C1F
1C00 : 0D 00 0A 0E 66 6C 6F 61 ....flea
1C08 : 74 3D 26 33 34 35 0D FF t=&345..
1C10 : 00 00 6C 6F 61 74 00 2A ..leat..
1C18 : 51 40 00 00 00 00 00 00 00.....
```

Figure 4. Dump showing how the floating point variable is stored

**Bruce Smith's five floating point demonstration programs are listed on yellow pages 108 and 109**

The above method of using a single byte of which just one bit holds the sign of a number is obviously wasteful of memory. Floating point numbers stored in memory use just five bytes - 40 bits for storage, which includes the sign bit. How is this done? You will remember that the Basic interpreter normalises a floating point value by moving the binary point along to the left until it reaches the leftmost 1. So it is a known fact that the first bit in the mantissa will *always* be a 1. As the Basic interpreter also knows this it can forget it and use the bit to represent the sign of the floating point value. When Basic needs to read the value of the number it can extract this sign bit, reset it to 1 and evaluate the number proper. Simple but very neat! In memory, then, the normalised representation of &345 is compacted into just five bytes of memory, stored thus:

Exponent	1000 1010 &8A
Mantissa	0101 0001 &51
	(bit 7=0 - therefore positive)
	0100 0000 &40
	0000 0000 &00
	0000 0000 &00

Figure 4 shows a dump of the area of memory storing the one-liner:

$$10 \text{ float} = \&345$$

After running this program the variable contents are stored above the program, as illustrated from &1C17.

We have seen that floating point numbers can be stored in a compact five-byte form or a loose six-byte form. Both methods are used by the Beeb and Electron. Because memory is at a premium the five-byte packed form is used throughout by the Basic interpreter to store variable values above

FUNCTION	ADDRESS	
	FAC1	FAC2
sign	&2E	&3B
overflow	&2F	&3C
exponent	&30	&3D
mantissa hi.byte	&31	&3E
mantissa	&32	&3F
mantissa	&33	&40
mantissa lo.byte	&34	&41
Rounding	&35	&42

Figure 5. The eight bytes of the floating point accumulators

LABEL	BASIC I	BASIC II
MEMFAC1	&A3A6	&A3BE
FAC1MEM	&A37E	&A38D
FPADD	&A50E	&A50C
FPSUB	&A50B	&A4FD
FFMULT	&A661	&A656
FFDIV	&A68B	&A6AD

Table 1. Basic 1 and 2 addresses for entry into subroutines

0	:	00	00	00	00	00
1	:	81	00	00	00	00
2	:	82	00	00	00	00
3	:	82	40	00	00	00
4	:	83	00	00	00	00
5	:	83	20	00	00	00
6	:	83	40	00	00	00
7	:	83	60	00	00	00
8	:	84	00	00	00	00
9	:	84	10	00	00	00
10	:	84	20	00	00	00

Table 2. Five-byte floating point format of the numbers 1 to 10

programs. However, the loose format is used in zero page by the interpreter as it makes the handling routines much simpler to code.

There are two areas in zero page associated with floating point manipulation. These are the floating point accumulators FAC1 and FAC2. Figure 5 shows that each FAC comprises eight bytes, with FAC1 addressed at &2E to &35 and FAC2 at &3B to &42. The extra three bytes are:

- a. Sign byte: the most significant byte of the mantissa is copied here to give the sign byte, which is held in bit 7.
- b. Overflow byte: used rather like the carry flag to hold any overflow from an addition or other operation so that errors of inaccuracy can be detected.
- c. Rounding byte: adds extra precision to arithmetical manipulations. In FAC1 format the representation of value &345 would be as follows:

```

Sign      01010001 &51
Overflow  00000000 &00
Exponent  10001010 &8A
Mantissa  01010001 &51
           01000000 &40
           00000000 &00
           00000000 &00
Rounding  00000000 &00
    
```

To be able to manipulate floating point numbers using built-in subroutines in the Basic ROM, the value must be placed into the FAC1 before calling a particular routine. We therefore need an algorithm to transform the five-byte format from memory (assuming we will

be manipulating variables passed through running a Basic program) into an eight-byte form. Luckily there is such a routine in the Basic ROM to do just this, at &A3B2 in Basic 2 (&A3A3 in Basic 1). Program 1 provides a demonstration of its use.

To use the program the address of floating point value in five-byte format must be placed in the floating point vector (FLPTV) at &4B. The Basic program seeds this address, &4000, via the locations &70 and &71. The subroutine call in line 120 to MEMFAC1 can then be performed (note that Basic 1 users will need to alter the JSR address). The loop in lines 130 to 180 then transfers the FAC1 contents to a series of safer locations in zero page, from which they can be printed. The demo seeds &345 into these locations and the final loose FAC1 configuration is printed out.

The process of seeding addresses of five-byte format, memory-based values is fundamental to the remaining programs presented here. Make sure you understand the process before proceeding!

The coding involved in performing addition, subtraction, multiplication and division on floating point values can become complex, so rather than dazzle you with page after page of assembler, details of ROM-based subroutines to perform these processes are provided. However, the practice cannot really be considered good programming and it would be a shame if the Beeb and Electron were beset by the peekery pokery that has

evolved around other micros.

Table 1 lists the four Basic 2 and Basic 1 addresses for entry into each of the subroutines mentioned above. Programs 2, 3, 4 and 5 demonstrate uses of each subroutine. Each program is essentially similar. The assembler begins by performing MEMFAC1 as described above to transfer fp1 into FAC1. Before the arithmetical subroutine call is made FLPTV needs to be seeded with the address of the second floating point variable at fp2. Once the Basic ROM call has been performed the result will remain in FAC1. A final ROM-based call can then be performed to implement FAC1MEM. This takes the eight FAC1 bytes and condenses them into five-byte format, placing them at the address held in FLPTV.

Setting up the floating point variables is undertaken in the Basic part of the program. To make these demonstrations clearer table 2 contains the five-byte floating point format of the numbers 0 to 10. You'll notice from this table that the value 0 does not conform to the representation described earlier. Zero is simply 0 but takes five bytes. If you need some further hints on the function of each program, here's what each is doing:

- Program 2: floating point addition of 1+9.
- Program 3: floating point subtraction of 7-5.
- Program 4: floating point multiplication of 3\*3.
- Program 5: floating point division of 3/2.



# THE DRIVE FOR QUALITY



In the rapidly expanding world of computer peripherals there is one company which continually leads the field — Cumana. Whether it is the best Japanese components used in our top quality designs, the rigorous training which all staff receive, or the superb technical service we offer, everything must be of the highest standard.

Cumana disk drives have an independent power supply, 12 months warranty, and are fully assembled and tested before packaging; and they are now available for the BBC and Dragon Micros — at unbeatable value for money prices — from selected branches of W. H. Smith and Spectrum UK in addition to Cumana's nationwide dealer network.

For further information on these and other Cumana products — including dual slimline disk drives for the BBC Microcomputer — contact:

Cumana Limited, Pines Trading Estate,  
Broad Street, Guildford, Surrey, GU3 3BH.  
Tel: (0483) 503121 Telex: 859380



Dragon is the registered trademark of Dragon Data Ltd.

For further information about Cumana disk drives, please complete and return this coupon.

I am interested in Cumana disk drives for the BBC/Dragon\* Microcomputer. \*delete as necessary

Interests:  
Home Use   
Education   
Dealer   
Business

Name .....

Address .....

.....AU:1/84

Tel. No.....

*Note: If dealer, please attach this form to your letterheading*

# PRINTERS

## DOT MATRIX

All printers have centronic parallel interface unless otherwise stated. All printers have hi res dot addressable graphic mode. Please send SAE for full details.

### EPSON

FX80 160CPS 10" wide friction & pin feed	£324 + VAT	£373
FX100 160 CPS 15" wide friction & tractor feed	£499 + VAT	£574
RX80 F/T 100 CPS 10" wide friction & tractor feed	£239 + VAT	£275
RX80 100 CPS 10" wide tractor feed	£199 + VAT	£229
RX100 F/T 100 CPS friction & tractor feed	£385 + VAT	£443
8143 RS 23 Interface for FX and RX printers	£39 + VAT	£45
8148 RS 232 Interface with 2K buffer x on x off	£60 + VAT	£69
Ribbon Cartridge for RX80 FX80 & MX80	£5 + VAT	£6
Ribbon Cartridge for FX100 & MX100	£7 + VAT	£8

### STAR

Gemini 10X120 CPS 10" wide friction & tractor feed	£200 + VAT	£229
Gemini 15X120 CPS 15" wide friction & tractor feed	£295 + VAT	£339
Gemini Ribbon	£3 + VAT	£3

### SEIKOSHA

BP 420 designed for the business world, 420CPS in draft mode, 110CPS in NLQ mode. £1095 + VAT £1259



### SMITH CORONA

Fastext 80: 80 col, 80CPS. Friction feed standard £149 + VAT £171

### ENSIGN

1650 Standard, Correspondance and Graphics Modes; friction and tractor feed; 165 CPS, bi-directional logic seeking £269 + VAT £309

### TAXAN KAGA

160CPS 10" wide 27CPS NLQ 24 x 16 matrix £259 + VAT £298  
160CPS 15" wide 27CPS NLQ 24 x 16 matrix £349 + VAT £401

### COLOUR PRINTERS

Seikosha GP700A 7 colour 50CPS printer £347 + VAT £399  
Canon PJ1080A 7 colour 40CPS ink jet printer £391 + VAT £449

All our printers have 1 year warranty

## DAISYWHEEL

### JUKI 6100/I PRINT

20 CPS Bi-Directional Logic seeking 10 12 15 CP1 + PS spacing 2K buffer best selling Daisywheel £299 + VAT £344  
Singer sheet feeder unit £217 + VAT £249  
Tractor Unit £95 + VAT £109  
RS 232 Interface £52 + VAT £59  
Spare Daisywheel £14 + VAT £16



### BROTHER HR-15

13 CPS Bi-directional 10, 12, 15 CP1 + PS £344 + VAT £395  
Keyboard Unit £139 + VAT £159  
Single Sheet Feeder Unit £217 + VAT £249  
Tractor Unit £95 + VAT £109

### QUENDATA

20 CPS Unidirectional £217 + VAT £250  
10 12 15 CP1

# ACORN F

BBC MICROCOMPUTER SYSTEM

**WE ARE AN OFFICIAL BBC COMPUTER DISTRIBUTOR**

DEALER ENQUIRIES ARE WELCOMED

**Acorn Electron £199** INC VAT

Free Cassette Recorder with every Electron

BBC is the best microcomputer currently on the market 32K RAM 32K ROM 8 modes of operation full colour full-size keyboard internal expansions such as disc interface speech synthesizer Econet interface — in short it is a personal computer capable of expanding into a small business system.

APPROVED ECONET SERVICE CENTRE

WE STOCK A LARGE RANGE OF SOFTWARE FOR BBC MICRO INCLUDING ACORNSOFT, BBC SOFTWARE, LONGMANS SOFTWARE, PLEASE SEND LARGE STAMPED ADDRESSED ENVELOPE FOR FULL DETAILS.



**COMPUTER GROUP**

28/29 BURNT MILL HARLOW, ESSEX CM20 2HU U.K.  
Tel. HARLOW (0279) 443521 Telex: 818894 AKHTER G

# DISC

100% BBC COMPATIBLE MITSUBISHI AND TEAC SLIMLINE DISK DRIVES

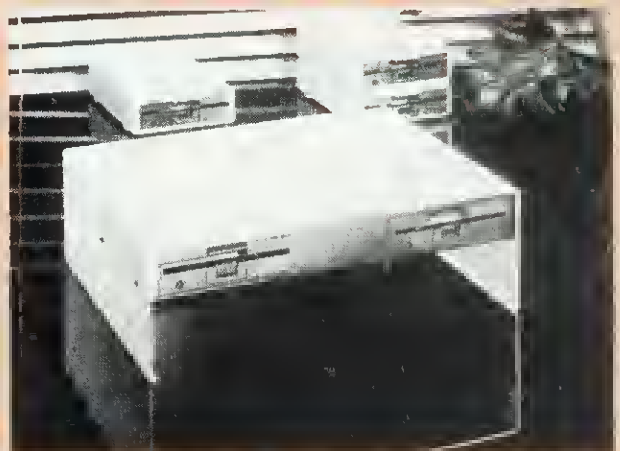

These drives are supplied ready cased with all the necessary cables formatting program and User Guide There are some very useful utilities included on formatting disc e.g.

- \* DISASSEMBLER: This is 6502 machine code disassembler
- \* DUP: To copy and rename a file on disc
- \* FORMAT: Formatting program for 40 & 80 tracks



# PRODUCTS

88C Microcomputer Model B	£348	+ VAT	£399
88C Mod 8 - disk interface	£409	+ VAT	£469
88C Mod 8 - Econet interface	£389	+ VAT	£447
88C Mod B - disk and Econet interfaces	£450	+ VAT	£517
88C Compatible 100K disk drive	£86	+ VAT	£99
88C Compatible dual 800K disk drive	£312	+ VAT	£359
Acorn Z80	£347	+ VAT	£399
Acorn 6502 Second Processor	£173	+ VAT	£199
Acorn Bit stick	£327	+ VAT	£375
Acorn IEE Interface	£282	+ VAT	£325
Acorn Electron plus 1 interface	£52	+ VAT	£60
88C Prestel Adaptor	£115	+ VAT	£132
BBC Telex receiver (Aug)	£196	+ VAT	£225
BBC cassette recorder and lead	£30	+ VAT	£35
Disk interface kit (free fitting)	£84	+ VAT	£96
Mod A to Mod 8 upgrade kit	£70	+ VAT	£80
Fitting charge for A to B upgrade kit	£20	+ VAT	£23
16K memory upgrade kit	£30	+ VAT	£34
Games paddles	£16	+ VAT	£19
User Guide	£10		
Advanced User Guide	£12.95		
Econet Guide	£7.50		
Econet interface (free fitting)	£60	+ VAT	£69
Speech interface (free fitting)	£47	+ VAT	£54
BBC disk manual - formatting disk	£30	+ VAT	£34
Parallel printer cable	£10	+ VAT	£11
88C word processor (view)	£52	+ VAT	£59
BBC Fourth language cassette	£15	+ VAT	£17
88C Lisp language cassette	£15	+ VAT	£17

## YOUR CONTACT AT AKHTER Tel: 0279 443521 (12 lines)

DEALER/BULK ENQUIRIES	HAMAYUN MUGHAL	EXT 202
TELEPHONE ORDERS	CARON ANDREWS	210
DEALER ORDERS	JULIA ALLUM	209
EXPORT ENQUIRIES	MOHAMAD EDIB	201
TECHNICAL SUPPORT	ALAN LAFFOLEY	207
ACCOUNTS	JULIE AMBLER	211
LITERATURE REQUEST	JOHN MAULE	201

### ORDERING INFORMATION

We accept official orders from UK Government and Education establishments. Carriage is £2.50 + VAT (UK only) for normal delivery. If express delivery is required please add £8.00 + VAT per parcel. We accept telephone orders on Barclay and Access card please ring (0279) 443521 (10 lines), all cheques made payable to "AKHTER INSTRUMENTS".

N.B. All prices are subject to change without notice and are rounded up to the nearest pound

OPENING HOURS: MON-FRI 9am-6.30pm, SAT 10am-5pm.  
We welcome callers, no parking problems.

# DRIVES

- \* FREE: This utility provides a disk usage analysis
- \* MDUMP: Enables you to display and modify any part of BBC memory
- \* MERGE: Merge a number of text files into one file
- \* RELOCATE: Downloads a basic program to &E00
- \* SDUMP: Screen dump for EPSON in all graphic modes
- \* VERIFY: Verifies every sector on a disk
- \* MENU: A flexible menu program

Single drive 100K 40 trks single sided	£86	+ VAT	£99
Dual drive 200K 40 trks single sided	£164	+ VAT	£189
Single drive 200K 40 trks double sided	£138	+ VAT	£159
Dual drive 400K 40 trks double sided	£260	+ VAT	£299
Single drive 400K 80 trks double sided	£152	+ VAT	£175
Single drive 400K 40 80 trks switchable DS	£155	+ VAT	£179
Dual drive 800K 80 trks double sided	£303	+ VAT	£349
Dual drive 800K 40 80 trks switchable DS	£312	+ VAT	£359
Dual Drive 800K 40 80 trks + PSU + built in monitor stand	£373	+ VAT	£429

All above drives are low power slimline (0.3 A typ at + 12v and 0.4 at + 5v per drive) Normally extra power supply is not required. The BBC Computer power supply is designed to drive to low power drive (IT IS NOT DESIGNED TO DRIVE INTERNAL ROM BOARD)

40 Track SS DD diskettes (10 Box)	£18	+ VAT	£20
40 Track DS DD diskettes (10 Box)	£23	+ VAT	£26
80 Track SS DD diskettes (10 Box)	£28	+ VAT	£32
80 Track DS DD diskettes (10 Box)	£30	+ VAT	£34

ALL ABOVE DISKETTES ARE CERTIFIED 3M

# BUSINESS SYSTEMS

## COMPLETE BUSINESS PACKAGE

This system is based on 16 Bit 8088 Processor 128K RAM, 2X730K Floppy Disc Drives, High Res Monitor, fast (160cps) Dot Matrix Printer, Wordstar Wordprocessor, Calcstar Spreadsheet Program, complete integrated Accounts package consisting of Sales Ledger, Purchase Ledger, Nominal Ledger, Invoicing, Stock Control, Payroll and Pro mail. Complete turnkey system at an unbelievable price. Delivered Only

£1495 + VAT £1719  
£1595 + VAT £1834

### APRICOT PC

"Portable Executive Computer" 16 Bit Micro, 256K RAM up to 1.44 megabytes floppy disk storage. 3 1/2" Sony disks. Portable brief case styling. Modem with auto dialler (optional) hard disk optional. Vast software library (compatible with Sirius 1).  
Apricot with Double Drive, Monitor and Free Printer £1790 + VAT £2059

### APRICOT XI

As above but with 10MB Winchester Drive and Single 315K Drive plus Superwriter, Supercaic and FREE JUKI 6100 Printer  
£2995 + VAT £3444



## SANYO PROFESSIONAL COMPUTER

### SANYO 550

16 Bit Micro 128K RAM expandable to 256K. Single or Double Disk drive built in full colour graphics (640 x 200 pixels in 8 colours) IBM compatible. Free software. Sanyo MBC 550 128K RAM single drive and free software including Wordstar and Calcstar  
£749 + VAT £862

### SANYO 555

Sanyo MBC555 128K double drive and free software including Wordstar, Calcstar, Inforstar, Datastar etc.  
£999 + VAT £1149

### SANYO 555-360

As 555 but with 2 x 360K Drives  
£1249 + VAT £1436

### SANYO 555-730

As 555 but with 2 x 730K Drives  
£1299 + VAT £1494

### SANYO 550-2

As 550 but with Dual Drive 2 x 160K  
£849 + VAT £976

### SANYO 550-360

As 550 but with 2 x 360K Drives  
£999 + VAT £1149

### SANYO 550-730

As 550 but with 2 x 730K Drives  
£1049 + VAT £1206

SANYO SYSTEMS INCLUDE  
FREE HIGH RES GREEN  
MONITOR

# WORD PROCESSING

## COMPLETE SYSTEMS FROM £650 + VAT

**BBC 1:** BBC Micro Model B, View (or Wordwise) Wordprocessor, Quendata 20 CPS Daisywheel Printer, High Res Green Monitor, Cassette Recorder plus 10 cassettes and all the necessary cables £650 + VAT = £747.50

**BBC 2:** BBC Micro Model B + Disk Interface, View (or Wordwise) Wordprocessor, 100K Disk Drive, High Res Green Monitor, Quendata 20 CPS Daisywheel Printer, 1 Box of Disks and all the necessary cables £799 + VAT = £803.35

**BBC 3:** Same as System BBC2 but with 400K Drive £875 + VAT = £1006.25

**BBC 4:** Same as System BBC 2 but with 400K Drive and JUKI 6100 Daisywheel Printer £975 + VAT = £1121.25.

**BBC 5:** BBC Model B + Disk Interface, View (or Wordwise) Wordprocessor, 800K Dual Disk Drive (Mitsubishi), High Res Green Monitor, JUKI 6100 Daisywheel Printer, 1 Box (10) of 80 Track DS discs and all necessary cables £1145 + VAT = £1316.75.

**SAN 1:** Sanyo MBC 550 Series 16 Bit Microcomputer, 128K Ram, Dual 160K drives (2 x 160K), High Res Graphics (600 x 200 pixels in 8 colours), JUKI 6100 Daisywheel Printer, High Res Green Monitor, 1 Box of 10 discs, Wordstar Wordprocessor, Calcstar spreadsheet and all the necessary cables £1175 + VAT = £1351.25

**SAN 2:** Same as SAN 1 but with Dual 360K Drives (2 x 360K) £1345 + VAT = £1546.75

**SAN 3:** Same as SAN 1 but with Dual 720K Drives £1395 + VAT = £1604.25

**SAN 4:** Sanyo MBC 555 Series 16 Bit Microcomputer, 128K Ram, Dual 160K Drives (2 x 160K), High Res Graphics (600 x 200 pixels in 8 colours) JUKI 6100 Daisywheel Printer, High Res Green Monitor, 1 Box of 10 discs, Wordstar, Wordprocessor, Calcstar spreadsheet, Mailmerge, Spellstar (dictionary), Datastar (database), Reportstar plus all the necessary cables £1295 + VAT = £1489.25.

**SAN 5:** Same as SAN 4 but with Dual 360K Drives £1475 + VAT = £1696.25

**SAN 6:** Same as SAN 4 but with Dual 730K Drives £1525 + VAT = £1753.75

If you require High Res Colour Monitor instead of High Res Green Monitor in Sanyo Systems please add £320 + VAT = £368 to the above prices.

\*128K RAM Upgrade for all above Sanyo systems (makes a total of 256K RAM) £150 + VAT = £172.50 including fitting

# MONITORS

### PHILIPS

7001 High Res Green Screen and sound input £65 + VAT £75

### GM1211

GM1211 18 MHZ High Res Monochrome Monitor with tilt and swivel stand available in green or amber etched antiglare screen (please specify colour). £86 + VAT £99

### SAMWOO

24MHZ High Res Monochrome etched antiglare green screen IBM/BBC Compatible £86 + VAT £99

### SANYO

DM8112 12" Green screen 18MHZ Hi-Res £86 + VAT £99  
DM2112 12" Green screen 15MHZ £66 + VAT £75

### MICROVITEC CUB

1431 MS 14" RGB Normal Res Colour £173 + VAT £199

1451 MS 14" RGB Medium Res Colour £289 + VAT £332

1441 MS 14" RGB High Res Colour £417 + VAT £479

### MICROVITEC FOR OL

1451 14" Medium Res Colour.

Specially designed for Sinclair QL

£239 + VAT £275



82

**I**N THIS issue we look at some of the goodies that have arrived on the doorstep of Telford Towers over the past months.

When the postperson left 'The Towers' he seemed to walk some two feet taller, for as well as a much-needed printer he had left three smaller parcels. These interested me greatly, especially when I deciphered two postmarks as Watford. One was badly smudged, but the package was small enough to be exciting. I opened it first.

## Toad in the hole

The parcel was from Toad Educational Computing. I was surprised to find inside it a 28-pin DIL socket header, from which a twin ribbon cable travelled about 16 inches to a small printed circuit board (PCB). On the circuit board was a 28-pin DIL socket, and extra to the package was a 28-pin zero insertion force (ZIF) socket.

What could this be? A completely soft EPROM blowing package? The documentation revealed all. This intricate piece of socketry was actually a ROM extension socket, the idea being to extend one of the four sideways ROM sockets to the surface of the BBC micro. Once the addition has been made, ROM chips can be switched without opening the micro's casing.

The idea seemed good and in a temporary breadboard the system worked well, the only small problem being to make sure that ROMs were plugged in correctly. The documentation explained this point adequately, but it is really common sense. My problem was that I needed a hole on the external casing of the BBC micro for the socket to locate into. Toad suggested the 'ash-tray'. This is shown in figure 1 and is the hacker's name for the keyboard hole for the voice synthesis extension unit. Unfortunately, my ashtray is filled with voice synthesis add-ons.

I spent a month with the Toad socket hanging limply out of the rear air vents, before deciding that I needed to use it so frequently that it would have to be mounted permanently. The logical places were:

Joe Telford tries Toad in the hole, talking chips, ROMs for a variety of types – and warns on things that stick in the Tube

# SIDE DISHES

Front of keyboard below Delete and Copy.

Rear of machine on the back panel.

RHS casing above the memory chips.

LHS casing in front of PSU.

Top surface of casing.

Every place had a drawback, and all the choices meant cutting the BBC micro casing. I eventually decided on the left-hand side of the casing. This was the only spot that would be inconspicuous and yet allow machine expansion. Using the right-hand side would prevent easy use of second processors; the rear might be upgraded to Econet eventually; the top casing often had documents on it; and the front keyboard necessitated a complicated cutting and wiring job.

There's a well in front of the PSU inside the micro into which the Toad socket almost fits. To ensure the fit, I cut the PCB board along its length and width until it fitted the space with the keyboard in place. Next a cutout for the

**Toad ROM extension socket:** £19.95 from Toad Educational Computing, 8 Westbourne Grove, Sale, Cheshire.

**Speech Synthesiser:** £44 from Watford Electronics, 33-35 Cardiff Road, Watford, Herts.

**Beebfont:** £39 from Watford Electronics, as above.

28pin socket was made. This needed a fine hacksaw and resulted in a deep cutout in the BBC micro's lower casing and a small cutout in the lid (figure 2). Using the adhesive pads supplied by Toad, I then fastened the PCB to the inside casing with just the DIL socket visible. Once this was fastened securely I plugged in the ZIF. This was larger than the cutout, so ragged edges didn't show. The ribbon cable was lead to a sideways ROM socket along the underside of the keyboard.

The Toad socket has now been in use for nearly four months and has proved very reliable. I use it to supplement a full ATPL sideways board. Most of my ROM reviews are performed using it, and ROMs only move onto the main board if they are regularly in the Toad socket.

Although I use the socket regularly and am happy to customise my BBC micro, I would remind users that cutting the casing can void your warranty on the computer and reduce its resale value.

## Talking chips

One of the other parcels that arrived at the Towers was from Watford Electronics. First out of the parcel and first examined for your edification was the WE Speech Synthesiser. This is a combined package based around a hardware synthesiser, with a driving ROM plus documentation.

The documentation is a detailed 20-page instruction booklet. It explains

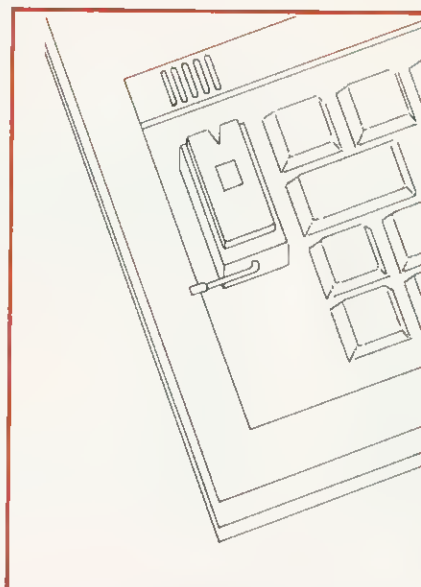

**Figure 1.** Toad Educational Computing suggests fitting the Toad socket in the Beeb's 'ashtray' aperture



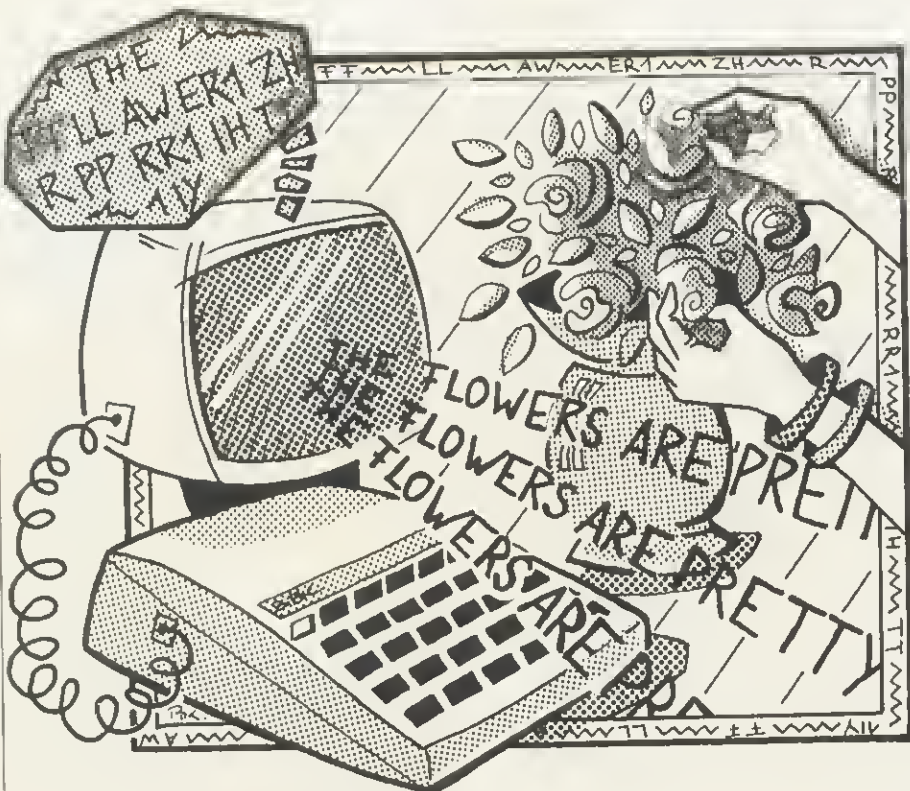

that the WESS is allophone-based. This means that words are made up from components parts, for example we would say *COMPUTER* by transmitting the phrase parts:

KK3 AA MM PP YY1 UW2 TT1 ER1

This would pronounce the word correctly.

The benefit of using the WESS is that the method of sending these allophones to the device is simplified by the supporting software.

With the BBC micro switched off, insert the 'TALK' ROM into a sideways ROM socket. Plug the WESS into the user port and switch on the BBC micro. The WESS has a volume control and a reset button, as well as an 'Audio Out' jack socket. The WESS is set up by typing \*HELP. This indicates that the ROM is correctly installed by producing a printed message:

Watford Electronics Speech Software

and a spoken message: 'Watford Electronics Speech Synthesiser'.

The unit can occasionally become confused, especially if any other interrupt driven software is in operation. This may result in abnormal silences or in hanging allophones (as in AARRGH!!!!). The Reset button will reset the unit, but the software has to be reset by typing \*HELP.

The software for the WESS is quite sophisticated, as it enables users to say words using the \*TALK command. For example:

100 \*TALK I M A COMPUTER

is an acceptable sentence because the words I M A and COMPUTER are all provided in a large ROM vocabulary. Many games-type phrases are included:

\*TALK THIRD WAVE FIGHTER ATTACK

and

\*TALK BOMB THE SPACE INVADER

Less aggressive phrases must be constructed from mixed words and allophones, for example:

\*TALK THE FF LL AW ER1 ZH R PP RR1 IH TT1 Y

tells us that the flowers are pretty.

Information is also given on using the OSBYTE call associated to the WESS (\*FX25) and OSWORD 25, which allow access to machine code. The SOUND command on the BBC micro reacts to:

SOUND 8192, X, Y, 0

and behaves like the \*FX25 command, except that the problem of variables in \*FX commands is removed. The short routine below shows my own way round the problem using the OSCLI command, available to users of Basic 2:

```
10 REPEAT
20 INPUT "phrase: " phrase$
30 OSCLI ("TALK " + phrase$)
40 UNTIL 0
```

Information is also given as to how to extend the library of words, so that users could blow ROM libraries for their particular needs.

In comparison with the Acorn Voice Synthesiser, the voice quality of the WESS is poor. If, however, we compare the device with other similar synthesisers, it compares well.

What I liked about WESS was:

- The ease of use. From \*TALK to SOUND 8192 the unit was easy to handle.
- The large library of preselected words (more than 500).
- The fact that it is interrupt driven, and this means that 'parallel' programming can take place.
- The useful volume from the amplifier.
- The interesting and useful documentation.
- The use of three levels of inflection.

What I didn't like was:

- The time taken to get used to understanding the words. Very careful programming was needed to make the words sound correct.
- The poor quality of hard consonants like B, P, D, K and G.
- The squeaky W sound.
- The strange pronunciation of words like THIS and THIRD which are sounded as DHIS and DHIRD respectively.
- Occasionally very long phrases lose synchronisation, but this can be recti-

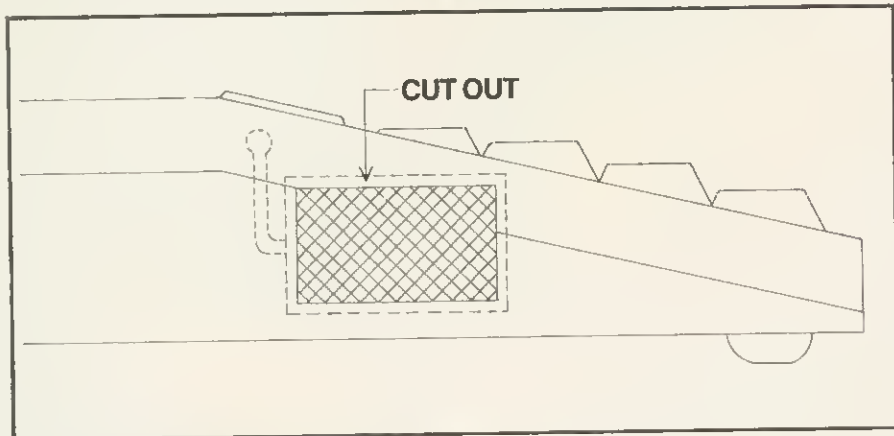

Figure 2. Joe's suggestion is to house the socket in a cutaway hole on the left-hand side (but you invalidate your warranty)

fied by splitting them into two or more lines of Basic.

Although the unit costs £44 it must be remembered that much of this is made up from the cost of the ROM chip, so the package represents reasonable value for money. Add to this the ease of programming and the wide vocabulary and the system has potential.

## ROMs for changing faces

The third parcel opened contained a much smaller package, consisting only of a disc, manual and ROM. The manual showed eight ways of displaying the word *Beebfont*.

*Beebfont* is a utility ROM that allows users to access a number of different typefaces, including the BBC standard. Facilities available include:

- One ROMmed small typeface that can be altered as follows: emphasised; double height; double width; and double width and height.
- Five ROMmed large typefaces.
- One RAM-based small typeface that is user-definable.
- One RAM-based large typeface that is user-definable.

A typeface editor is also supplied with *Beebfont*. To complete the package a spooling program is included so that documents created by, say, spooling text can be printed out in large characters on a printer.

The typefaces must be accessed from modes 0, 1, 2, 4, or 5, as the other modes will provide gaps within large characters caused by the BBC computer's line-spacing.

Any typeface facility can be called by typing \*FONT followed by CTRL-V then a number from 1 to 8. These refer to the ROM typefaces 1 to 6 and to the small and large RAM typefaces 7 and 8.

The typeface facility is turned off with \*NOFONT. This can be done from within a program using lines like:

```
10 *FONT
20 VDU22,ASC("2")
30 PRINT "1 Typeface"
40 VDU22,ASC("4")
50 PRINT "And Another"
60 *NOFONT
```

The controllable typeface (FONT 1) can be selected by typing:

```
VDU22,ASC("1")
```

and any of the options – wide, tall, emphasised, normal – can be selected by issuing appropriate lines:

```
High      VDU22,ASC("H")
Wide      VDU22,ASC("W")
Emphasised VDU22,ASC("E")
Normal    VDU22,ASC("N")
```

The various 'Beebfonts' are easily used for noticeboard messages, for

OHP transparencies, or even for a change in programs.

The RAM-based typefaces can be altered with a utility program provided, called *Editor*. Although my version of the manual said I should:

```
CHAIN "B.EDITOR"
```

the program operated only on typing:

```
*EDITOR
```

The result is one of the best character editors I have seen. If graphics shapes are required it can even produce a 'character set of space invaders', all of which can then be saved to disc and brought back into the computer for use with *Beebfont*.

The editor is window driven, and three main areas appear: a large window containing the character sets in use; a half-size window that serves as the editing window for each character; and a command window that controls the movement of characters, loading, saving, switching between fonts, etc. This editor is a very impressive piece of work.

An additional facility allows text files like *Wordwise* documents to be printed out in any of the typefaces. Although the documentation indicates that a number of makes of printers can be used, the program on my disc was only for the Epson range.

The *Beebfont* ROM is very impressive. In fact I found it more impressive than useful. However, combined with a good wordprocessor and a spooling program to match a particular printer, it could be the basis of an introductory, low-cost electronic typesetting course for schools and colleges.

The cost: ah well, I suppose another 'world shortage of silicon' has produced the figure of £39.

## Stuck in the Tube

It is becoming apparent that some ROMs don't work with second processors. What is less well known is that some ROMs partly work. Here is an introductory list of ROMs and their sticking points in the 6502 Tube.

**DNFS chip** Although useful in activating the Tube, the DNFS chip is less than helpful with some games programs. *Killer Gorilla* hangs up completely, and *Defender* crashes whenever a 'mutant' is created. *Snapper* and *Monsters* seem to run all right.

**WESS** The Watford Electronic Speech Synthesis system does not seem to work at all across the Tube to the 6502 processor. \*TALK commands are accepted but no sounds are made.

**Beebfont** With the 6502 Tube in operation, this ROM can be enabled by \*FONT. The result is that the computer hangs up, until a CTRL-BREAK is

issued. \*NOFONT also hangs up the computer, but often with accompanying noises. I presume the complex use that both WESS and *Beebfont* make of interrupts is the root of the trouble.

**Wordwise and Wordwise B20** Neither of these ROMs works with the 6502 second processor. The B20 version of *Wordwise* will, however, work with the Aries board.

On calling *Wordwise* from the 6502 processor the first menu page appears correctly but the results of keypresses are unpredictable. The end result is a crash.

**Beebcalc** Amazement! The *Beebcalc* ROM from Computer Concepts can be called from the 6502 second processor and it works! Load/Save/Amend/ and all the worksheet commands I tried, including Printing, apparently operate correctly.

**Caretaker** Some of Computer Concepts' *Caretaker* commands work on the other end of the 6502 Tube. Generally the screen and keyboard I/O commands function well, though disc accesses are somewhat hazardous:

*Working commands*

```
*CURSOR ON
*CURSOR OFF
*NORMALKEY
*NOTAB
*SINGLEKEY
*TABSTOPS
*EXCHANGE
```

*Non-working commands*

```
*EXCHANGE
*INSERT
*KEYLOAD
*KEYSAVE
*LVAR
*MOVE
*MERGE
*PARTSAVE
*RENUMBER
*RETRIEVE
*SOUASH
*STATUS
```

These commands either behave erratically because of confusion over the memory map in which they are executing, or cause the system to hang up.

## Over to you

If you have any ROMs working (or not) with a second processor, why not describe which facilities work and which don't. Send the information in on a postcard with a few lines saying:

```
Which ROM
Which processor
What works
What doesn't
```

Address your postcard to: Joe's Jottings, *Acorn User*, Redwood Publishing, 68 Long Acre, London WC2E 9JH. Don't forget to include your name and address.



**Statacom Distribution Ltd offer a complete range of 3" and 5 1/4" disk drives, interfaces and diskettes. We are the sole UK distributor for the Hitachi 3" disk drives assembled by **datafax** Systems Ltd.**

The HITACHI 3" disk drive unit is now firmly established and is fast displacing the old 5 1/4" as the standard for home computers. The drives are more compact and slimline as well as lighter and more portable than the 5 1/4". They are faster (average track to track access time: 3ms.) and use the latest LSI technology, for a lower chip count and improved reliability. The floppy diskettes are enclosed in a rigid case which makes them dust proof, much more reliable and easy to handle. The diskettes are also flippable, ie can be used on both sides! Don't settle for anything less than the legendary HITACHI reliability.

All drives supplied cased in a sleek metal casing, and complete with leads, cables and a utility disk. Each drive is tested and is covered by a full one year warranty.

PRICES INCLUDE VAT.

ONE SINGLE SIDED 100K	£167
ONE DOUBLE SIDED 200K	£199
DUAL SINGLE SIDED 200K	£334
DUAL DOUBLE SIDED 400K	£437

NB: Optional internal power supply unit available for £35 extra

GENEROUS DEALER DISCOUNTS:

For full price list please contact:

**STATACOM  
DISTRIBUTION LTD.**

18 GROVE ROAD  
SUTTON, SURREY  
Telephone 01-661 2266

Name .....

Address .....

Tel. ....

(For dealer enquiries information please attach letterhead)

- Please tick requirements:
- Full Brochure Pack
  - Dealer Information
  - 3" Tech Details
  - Interface Details

# ULTRACALC

## Upgraded version now available!

Ultracalc, the successful spreadsheet program from BBC Publications, has now been upgraded to increase its power and flexibility. New features include:

- Operation in any screen mode
- Greater printer flexibility including control codes and £ sign definition
- Runs as 'HICALC' on a 6502 second processor to allow 44k of workspace in any screen mode
- Spooling of ASCII text files for subsequent use with any word processor
- Several additional layout options
- Supplementary manual containing a wealth of information on how to use Ultracalc.

£79.50 (inc. VAT)

If you already have a copy of the original Ultracalc, you can exchange it for the new version for just £6.25 inclusive of VAT, postage and packing. Contact your local dealer or write to Software Editor, BBC Publications, 35 Marylebone High Street, London W1M 4AA, enclosing a stamped addressed envelope.



## Authorised Dealer & Service Centre IN MID-SUSSEX



**BBC**  
MICRO COMPUTER



- **HARDWARE**  
BBC B's, Electron & wide range of Monitors, Printers, Disc Drives & Watford Kits
- **SERVICING/UPGRADING**  
On site Engineering
- **SOFTWARE** Variety of Educational/ Games/Business Packages
- **COURSES** Beginners & upwards on BBC Micro from £20. Day/Evening. Children/Adults

PHONE  
BURGESS HILL  
(04446)

**45636**

Over 400 items on our price list



**michael**  
Business Systems Ltd

195 LONDON ROAD BURGESS HILL SUSSEX

# 1st London

## BARGAINS GALORE

# MICROMARKET

### WEMBLEY CONFERENCE CENTRE NOV. 10TH & 11TH

Here's your chance to sweep up all your Microcomputer needs before Christmas, at London's first ever Micro Market.

- ★ Thousands of Hardware & Software Bargains!
- ★ Competitions and Prizes
- ★ Win a Personal Computer!
- ★ Bring & Buy Swap Shop!
- ★ Free Computer advice at our Computer Surgery

All leading makes of Micro including:

- ★ BBC
- ★ Commodore
- ★ Apple
- ★ Spectrum
- ★ QL
- ★ Oric
- ★ Printers
- ★ Peripherals
- ★ Joy Sticks
- ★ DIY Robots
- ★ Modems

OPEN 10am-6pm Sat. November 10th  
10am-4pm Sun. November 11th

Adults £1.50 Under 14's 75p.  
Including FREE  
SHOW GUIDE

**MICROCOMPUTER BARGAINS  
GALORE, LOWEST PRICES  
IN TOWN, DON'T  
MISS IT!!!**





We've got five computer trollies to give away this month. Simon Dally presents a straightforward problem of adding up the add-ons

# THE SUM OF ITS PARTS



Home computer trolley by Gallini

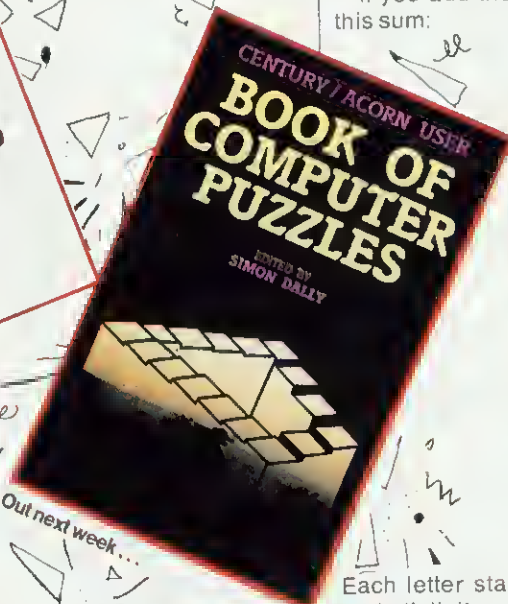

THIS month's problem was submitted for entry in the *Century/Acorn User Book of Computer Puzzles* (to be published on October 25 at £4.95) by Dave Stanford of Kinross, Tayside. Unfortunately Dave was unable to supply the solution on anything other than an Atom – and the rules did specify BBC Basic.

At the heart of a computer system is a CPU, assorted ROM and RAM chips and various ICs on the PCB. All computers need a power supply (PSU), a SCREEN and a KEYBOARD. A PRINTER and DISC UNIT are often attached by means of DIN plugs.

To do anything useful you need SOFTWARE to run it, an operating system like MSDOS and a high-level language like BASIC. It is also useful to have a database (DB), a MODEM UNIT and a MOUSE.

If you add them all together you get this sum:

- CPU
- ROM
- RAM
- IC
- PCB
- DIN
- PSU
- SCREEN
- KEYBOARD
- PRINTER
- DISC UNIT
- MSDOS
- BASIC
- DB
- MODEM UNIT
- MOUSE

COMPUTER

Each letter stands for a different digit and all digits are used. If you know that  $\text{MOUSE} + \text{MOUSE} = \text{BASIC}$  and that no carrying is involved, what does the sum look like?

Answers on a postcard please to arrive not later than December 7, 1984 to November Competition, *Acorn User*, 68 Long Acre, London WC2E 9JH.

Five computer desks worth £66 each, generously donated by Paul Gallini Enterprises await the first five correct entries out of the bag.

## JUNE WINNERS

IT was obviously one of the easier ones, the June competition. About 600 of you entered it and nearly all of you got the answer right – SCS sold 277,199 and CC sold 637,559 machines. The winners were picked from a very large hat.

Ms B Wilson of London took the first prize, a Sidewise ROM board plus four ROMs (all from Computer Concepts); the two second prizes of three ROMs went to P Illingworth of Middlesbrough and Mrs S Mayne of Bromsgrove; and five third prizes of a ROM were won by Mr Finch of Brussels, Miss A J Kempster of Warwick, James Burt of Huntingdon, Zia Khadaroo of London, and Alan Shilling of Norwich.

All winners have been informed of their good fortune.

# How to become a before committing y

.....\*

The Owl and the Puppy-dog  
Ment to see  
A beautiful sky-blue bote.  
The took some money,  
Which looked really funny  
Wrapped in a £10 note.

—

\*\*\*\*\*

tra  
a v  
pr  
RO  
M  
yo  
(Y  
BA  
su  
Br  
So  
ke  
pa  
tex  
alt  
yo  
lit  
wi  
wi  
ad  
yo



# ...a great writer ...yourself to paper.

It takes only two minutes and £59.80 to transform your BBC Micro into the heart of a word processor with VIEW from Acornsoft.

The VIEW word processing system is programmed into a single chip, a 16K plug-in ROM. Once it's installed into your BBC Micro - a simple job for your local dealer - you just switch on and VIEW is operating. (You can switch to other programs, like BASIC, with a single command.)

VIEW is a professional system, yet it's surprisingly straightforward to use.

And it's so outstanding it's won the 1984 British Microcomputing Award for Home Software.

All you do is type out your text on the keyboard, and view it on the screen.

VIEW can search, change and replace particular words whenever they occur in your text. It can swap paragraphs. Automatically alter page numbers. Even count words.

The possibilities are endless, because you can check, edit and change as much or as little as you like until you're satisfied. Then, with a single command, your final version will appear on the screen.

If you want to go even further, the simple addition of ViewIndex, just £14.95, means you can select and index words, complete with page or section numbers.

And of course, when you're ready, any printer that will operate with your BBC Micro will operate with VIEW. But if you want to use the printer's special facilities, such as bold printing or underlining, Acornsoft's Printer Driver Generator (£9.95 on cassette, £11.50 on disc) enables you to do so.

For the more specialised user who wants to take advantage of the extra power offered by the 6502 Second Processor, Hi-VIEW (£59.80) provides 47K of text space in any of the BBC Micro's screen modes.

So whether you're composing a 300 page business document, a letter to the gas board, or a bit of Victorian nonsense, you can polish it to your heart's content, wasting precious little time. And even less paper.

You can get VIEW products from your Acorn dealer. Just phone 01-200 0200 for your local stockist.

Alternatively, you can send off for the View Family brochure and order through the post by contacting Acornsoft, c/o Vector Marketing, Denington Industrial Estate, Wellingborough, Northants NN8 2RL. Tel: 0933 79300.

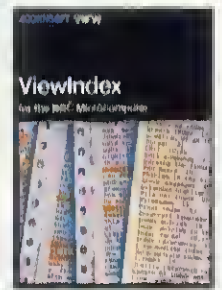
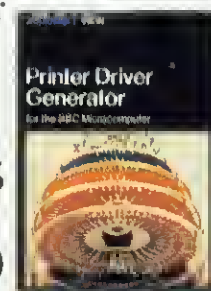

## ACORNSOFT

The text on the screen is in Mode 6.







# MICROMAN Computers

ACORN SPECIALIST COMPUTER CENTRE

ACORN/BBC COMPUTERS:	
Acorn Electron	199.00
BBC Model B	390.00
BBC Model B + DFS	469.00
Acorn Teletext Receiver	225.00
Acorn 6502 2nd Processor	199.00
Acorn Z80 2nd Processor	399.00
Acorn IEEE Interface	325.00
Bitlink	375.00

BBC UPGRADES:	
A-B Upgrade (Fitted)	95.00
DFS Interface (Fitted)	POA
Speech Synthesizer (Fitted)	55.00
Opus D:D DFS (supports second processors)	129.95

PRINTERS:	
Epson RX80FT	295.00
Epson FX100	574.95
Siar Gemini 10X	268.00
Siar Delta 10	385.00
Canon PW-1180A	530.00
Shinwa CP80	220.00
Juki Daisywheel Printer	390.00

TORCH COMPUTERS:	
Z80 Disc Pack	799.00
Z80 2nd Processor Card	330.00

BBC FIRMWARE:	
View ROM	50.00
Wordwise ROM	44.85
Viewsheet ROM	59.80
B-Base Database Disc	25.00
Ultracalc Spreadsheet ROM	POA
Computer Concepts Rom	33.35
Toolstar ROM	34.00
Commstar EPROM	34.00
BCPL ROM	99.65
Sidewise ROM	44.70
Solidisr 32K Sideways RAM	57.95
Solidisr 96K Extension	92.00
Solidisr 128K Sideways RAM	149.95
Aries B-20 Board	79.95
System ADE ROM	60.00

MODEMS:	
Nightingale	159.85
Telemod	POA

MONITORS:	
Deira RGB Standard	228.85
Microviter Cub Standard	228.85
Zenith Green	109.25
Hera TV/Monitor	265.00

DISC DRIVES:	
Full range available	POA

DEALERS FOR THE NEW GEMINI INTEGRATED BUSINESS SOFTWARE - DATAGEN/DATABASE ROM

ACORN APPROVED SERVICE CENTRE  
Our workshop offers a comprehensive service including Repairs and Upgrades by our own engineers

EDUCATIONAL ENQUIRIES WELCOME



All prices include VAT, Post & Packing £9 (Large items) £1 (Small items ROM's etc)

RAINFORD INDUSTRIAL ESTATE, MILL LANE,  
RAINFORD, ST. HELENS, MERSEYSIDE

PHONE 074488 5242



# picOTEL

AT LAST!! . . .

## A TRUE MULTI-USER PRIVATE VIEWDATA SYSTEM!!

- ★ A single BBC micro with floppy disc (or Apple II or IIe) acts as a file store containing a library of Teletext pages of information.
- ★ Up to 10 students can use BBC model B's to access the library.
- ★ Students can create and edit pages of information.
- ★ Ideal for Clubs, Schools, Colleges, Magazines and Message Systems.
- ★ System also acts as network allowing each station to catalogue the disc, LOAD and SAVE BASIC and Machine code programs.
- ★ Comes complete with manual, sideways ROM, linking cable and function key legend.
- ★ LOW . . . LOW Price— £49.95 for library file store and £34.95 per station.

(post & packing £3.00)

decode logic

Camant Software Services  
8 Craigstewart Cres., Alloway,  
Ayr KA7 4DB

Tel. 0292 43492 — 0294 69204

**SUPERB  
REVIEW!**

# AID at last!

Assembler Interactive Debug for the  
BBC Micro with DUALSCREEN

**STOP PRESS . . . AID receives  
superb review . . . see below**

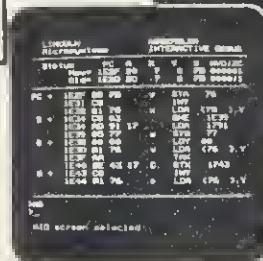
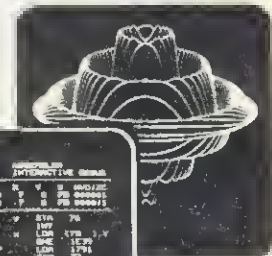

AID has now established itself as the finest machine code monitor ROM for the BEEB. With its unique DUALSCREEN operation so far in advance of the competition, AID puts unprecedented debugging power into your hands. No other monitor can begin to tackle machine code graphics - something AID takes effortlessly in its stride! Beginner or expert, you cannot afford to be without DUALSCREEN AID.

Read what "The Micro User" thinks . . .

“My immediate impression of AID was that it was a very professional product . . . AID offers additional features far in advance of other monitors . . . I found it easy to use, particularly as the user guide is very thorough and accurate . . . I wish I had something like this when I first started dabbling in machine code . . . The last facet I explored was the DUALSCREEN facility, which is perhaps the pearl of the system . . . In conclusion, AID seems a must for the serious machine code programmer and a very useful learning aid for the novice. It is a highly professional product in every way and could prove to be the standard by which others are compared.” *“The Micro User” January 1984*

The most advanced machine code AID for the BBC Micro

**LINCOLN  
Microsystems**

P.O. Box 74  
Bradford,  
W.Yorks. BD6 3RN



ROM  
plus manual  
(OS 1.2 required)

**£28**

p&p add  
UK £1.50  
Europe £3.00  
Outside Europe  
£4.50

# CHASE DATA

## PRICES SENSATION

Canon 110: Case/Cables all INCL £99

Canon 220: 400K (40/80 switching)

Case/Cables all INCL £169

N.B. These are state of the Art Disc Drives; Direct Drive  
40 track 6mms Access/80 track 3ms Access.

DFS Kits available  
ex stock  
all inclusive price £109

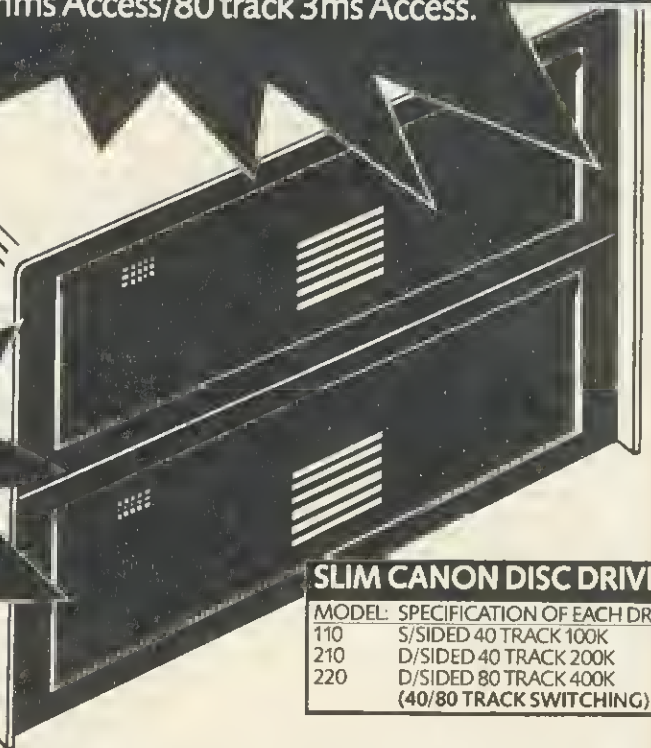

### SLIM CANON DISC DRIVES:

MODEL:	SPECIFICATION OF EACH DRIVE
110	S/SIDED 40 TRACK 100K
210	D/SIDED 40 TRACK 200K
220	D/SIDED 80 TRACK 400K (40/80 TRACK SWITCHING)

■ All **CANON** 40/80 switchable disc drives feature an on-board dual-colour LED on the front panel to show track mode selected. This is coupled with our own unique two-stage illumination, to give a clear operating status, as follows:

40 TRACK MODE: \_\_\_\_\_ LED GREEN

80 TRACK MODE: \_\_\_\_\_ LED RED

POWER ON: \_\_\_\_\_ HALF-ILLUMINATION (GREEN OR RED)

DRIVE SELECTED \_\_\_\_\_ FULL-ILLUMINATION (GREEN OR RED)

■ Super-slim **CANON** drives, models 211 and 221 and the **SANYO** model 596D are available with their own custom-built secondary switching power supply. This is safe, low in heat generation and excellent value for money.

■ The **SANYO** disc drive is our latest acquisition in quality Japanese products. This is a "half-height" unit of standard dimensions.



# ALTD DISC DRIVES

**FOR THE  
BBC  
MICRO**

**SLIM SANYO DISC DRIVES:**  
MODEL: SPECIFICATION OF EACH DRIVE  
596D D/SIDED 40/80 TRACK 400K

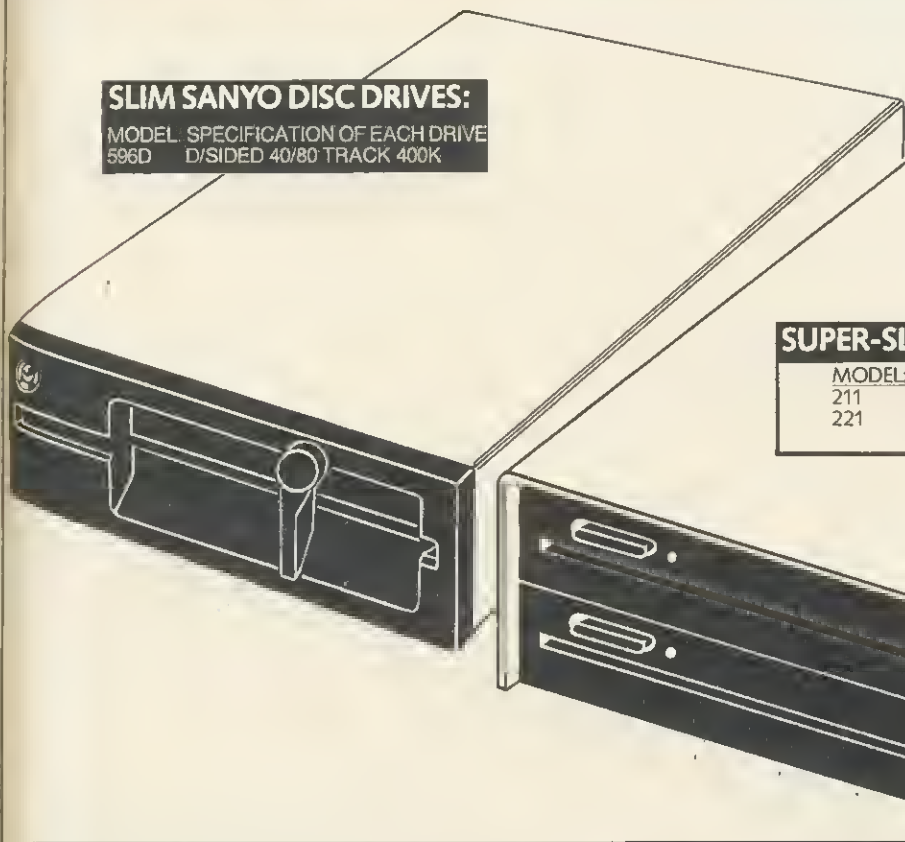

**SUPER-SLIM CANON DISC DRIVES:**  
MODEL: SPECIFICATION OF EACH DRIVE  
211 D/SIDED 40 TRACK 200K  
221 D/SIDED 80 TRACK 400K  
(40/80 TRACK SWITCHING)

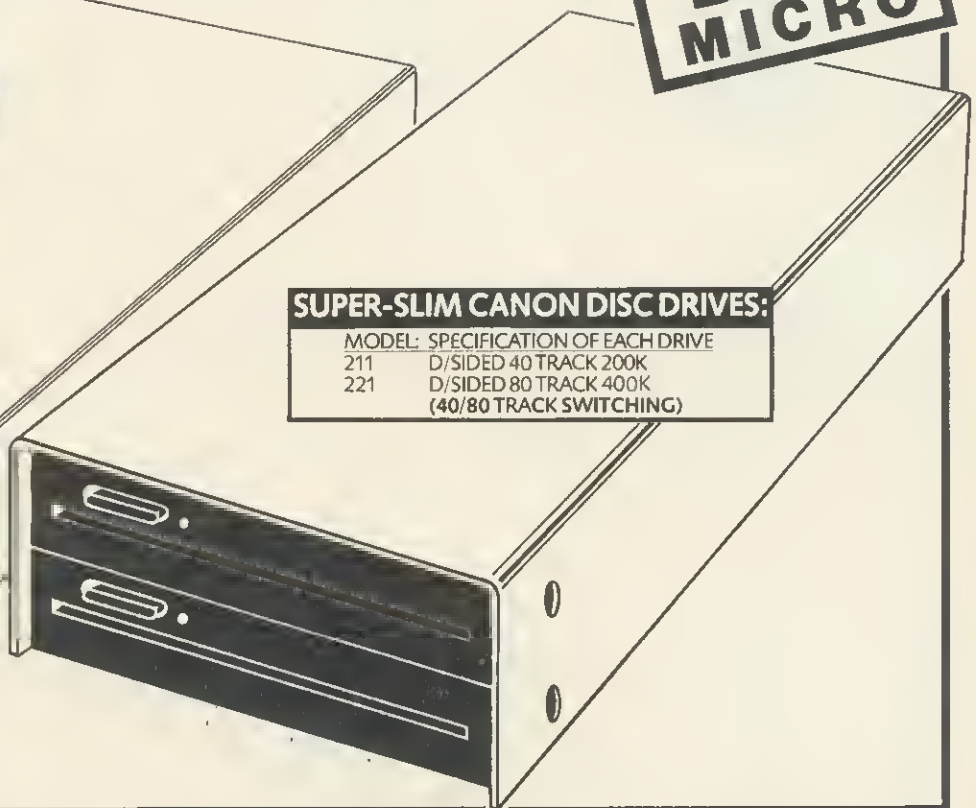

## All inclusive price list:

This means: disc drive + case + all power & data cables + U.K. carriage + utilities disc & manual + V.A.T.

	CANON					SANYO
MODEL:	110	210	220	211	221	596D
Formatted Capacity per drive on BBC Micro:	100k	200k	400k	200k	400k	400K
Single Drive & Case:	£99	£139	£169	£179	£236	£182
Single Drive & Case/P. Supply:	£124	£164	£194	£209	£266	£212
Dual Drive & Case:	£204	£274	£314	£329	£437	£368
Dual Drive & Case/P. Supply:	£229	£299	£339	£359	£467	£398

## Support:

**Warranty:** All disc drives sold by Chase Data Ltd. come with a full one-year warranty on parts & labour.

**Non-warranty service:** As THE experts in our field we can offer service on most makes of floppy disc drive.

**Recalibration & Alignment ...** £25 per unit inc. VAT. (parts extra). Phone for details: (Tel: 0784 38487)

## Payment



By Post: Send your remittance (cheques only please) with your order to:

**CHASE DATA LTD**

P.O. Box 6, Woking, Surrey, GU21 4PB.

By Phone:  (Tel: 0784 38487).

# BACK ISSUES £1.25

**6. January 1983** MEP school launch. 'FX' commands for sound. Second BBC TV series. Machine code 3 - two pass assembly. Disc drives for the Beeb. Programming forum. Program protection. Micros in schools - new series. Commodore Pet printer used with Beeb. BBC programs written on an Atom. Extra Atom memory.

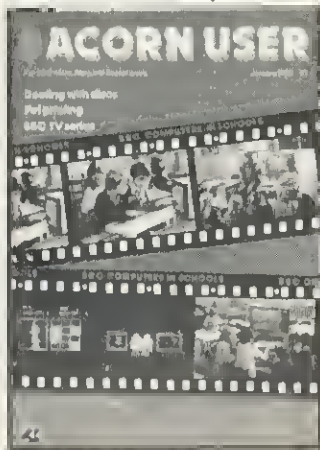

**7. February** 1 MHz bus examined (4). 3D Atom graphics (3). Atom BBC Board reviewed (3). Machine code 4 - memory (5). BBC Computer Literacy update (1). Atom error handling (2). Micros in schools 2 - getting organised (6). Hints & Tips (4). Beeb Forum (3). Reviews of *Wordwise* (2) and the Amber printer (1). \*\*\*

**8. March** Chess on the BBC micro (3). Sound on the Beeb (4). Printers for beginners (4). Atom analogue converter (2). Schools 3 - micros and maths (6). Machine code 5 - indirect addressing (3). DIY lightpen (5). MEP's *Microprimer* review (2). Atom Ross toolkit review (1). Beeb Forum (2). Assembly language and Pascal book reviews (2). \*\*\*

**9. April** *Hexangle* game listing (4). Bach on the Beeb (4). Hints & Tips on disc drives (4). Machine code 8 - the CALL statement (4). Interfacing the 1 MHz bus (3). Schools 4 - young children and micros (6). Graphics listings (2). Printers for beginners 2 (4). Reviews of BCPL, educational software and Atom software (3). \*\*\*

**10. May** Review of Basic II. Graphics listings. New 'FX' calls in OS1.2. Colour mixing on the Beeb. Jazz, blues and talk on the BBC. Schools 5 - language development. DIY Beeb interface box. Atom sound board. A to Z of printing: how to get going. Hints end Tips: PROCs, discs and FNs. Printer, software and book reviews.

**11. June** Techniques series - sorting. Hints end Tips: 50p network. Drawing techniques end CAD. Machine code: interrupts. Schools 6 - information technology. Atom Forum. Beeb Forum. Printers - write your own graphics dumps. Competitive review of *View* and *Wordwise*. Three graphics packages reviewed. Test of *Acorn User's* Interface box.

**12. July** Techniques - hash tables. Hints end Tips: logic made easy. Recursion and graphics. Handling strings. Two ideas for passing variables. Beeb aids the blind. DIY second keyboard. Beeb Forum. Sounds on the Atom. Hardware, firmware, software and book reviews. Atom Forum.

**13. August** Printer graphics and dumps. Techniques - Tree structures and sorting. All the fun of the fair. 40/80

disc copier. Colour painting. Basic II: random access tiles. Screen dumps for Olivetti, Centronics and Selksha. Atom strings. Reviews of Tandy CGP115 printer, five educational packs, A to D converter.

**14. September** Techniques - Ink-blots and mazes. Painting by lightpen. DFS space explored. Beeb Forum. *Mega Monsters* game listing. Machine code graphics dumps. Atom Forum. Atom cassette recorder check. Reviews of Atom RAM boards, Cumana disc manual, *Logo* for schools, Hobbit floppy tape and books.

**15. October** Women end computing. Techniques - random numbers. Review of Computer Concepts' *Beebcalc*. Fractal graphics. 57 tiles on 40 & 80 track discs. *Vampire* game listing. Beeb Forum. Assembly code controls tab key. Ofile merging. Atom future. Atom verify routine. Reviews of *Vu-Type*, Procyon Atom book, Epson FX80, Teletext adapter, disc drive, software.

**16. November** Techniques - impossible problems. Contour graphics. Connecting two Beebs together. XREF: sorts & lists variable, function and procedure names. Assembler Utilities In Basic II. OS, VDU, 'FX', OSBYTE calls - pull-out poster. Disc overlays. Adding extra Atom commands. Reviews of 7 educational pecks, Atom ROM, books, games.

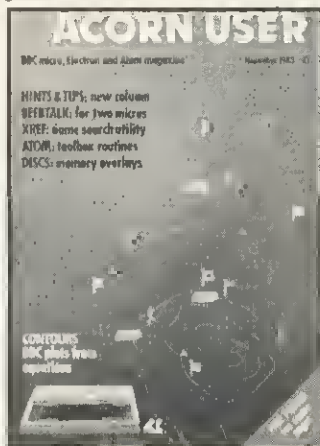

**17. December** Random graphics. Animated graphics in colour. Techniques - graphs. Hints & Tips. Universal printer dump. 6522 connected to the Electron. Saving machine code. Beeb Forum. Graphics pull-out poster. Index: July 82-July 83. Forum Extra: EOUS. BBC helps the disabled. Schools - data processing. Transfer-

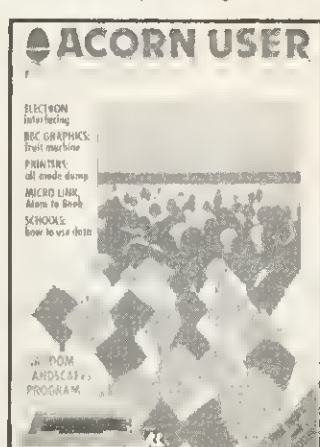

ring data between Beebs, Atoms... or Pets. Atom block demolition utility. Atom disassembler program. Reviews of software, books, educational programs from Chalksoft.

**18. January 1984: Games special issue** Techniques - graphs part 2. Stacks and queues, Basic and languages. Hints & Tips. Voice chip revealed. How to write games. Electron interfacing. Beeb Forum. Life graphics routines. *Defencecom* game listing. *The Train* game listing. Machine code graphics. Where to put machine code. Schools - handling data. Juki daisywheel printer examined. Atom Forum and adventure. Reviews of utilities, software, *Beeline* wordprocessor, educational packages, two chess programs.

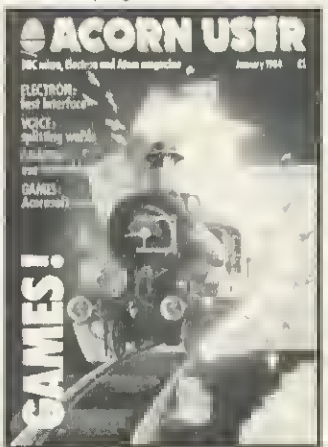

**19. February: Adventures special issue** Techniques - efficient sorts. PROC for a numeric keypad on the Beeb keyboard. 12 graphics listings. Random access tiling on disc. Locking files. MCP40 printer/plotter looked at. Hints & Tips. Beeb Forum. Make discs readable on 40 and 80 track drives. Screen memory organisation. Hints on adventure design. Adventure action. Adventure Ideas in computer language. Text compression. Word-crunching. VTA chip on Electron to drive a parallel printer. Atom Forum. Schools - simulation packages. Reviews: *Disc Doctor*, Leesallink's DFS upgrade, Hitachi's microdrive system, Solidisk's sideways RAM board, software.

**20. March** Utility: timing routine. Fractals. Teletext and mode 7 dump. ROMs reviewed. Hints & Tips. Beeb Forum. Add sounds to your games. Learn Lisp 1. Cube graphics. Printer driver for View. Basic II from Basic I. Beeb's ADC chip. Atom Forum. Listing formatter for

the Atom. Atom 'bytes tree' routine. Schools - test of *Facfile*. Keyboard skills. Amcom DFS v Acorn DFS. Reviews: *Beebpen* wordprocessor, Atom expansion system, software, books

**21. April** Beeb graphics on TV. 6845 chip explored. Advanced tiling systems. Lisp 2. Hints & Tips. Beeb Forum. Choose disc tracks to copy. Function key editing. Teletext dumps. CES scrutinised. Passing variables. Computer Concepts' graphics ROM. Schools - simulations. Calculating Easter dates. Better programming. Atom Forum. Atom ROM routines. Converting BBC to Atom Basic. Three printers compared. Reviews: software, Aries B20 RAM board, *Toolkit*, Monitors.

**22. May** Bitstik graphics system. Hints & Tips. 6502 second processor examined. Lisp 3. Beeb Forum. Disc utility to keep track of available space. Statistics. Pattern graphics. OSWORD explained. 4 colour graphics listings. Second-hand disc drives. Education - do girls get a fair deal? Atom Forum. BBC to Atom Basic 2. Reviews: British Micro's Grapad, *Edward* wordprocessor, 4 sprite generators, Opus microdrive, *Beasty*, software.

**23. June** Acorn Z80 second processor. Forth. Graphics to brighten up your games. Soft Pottery graphics. Go faster and save memory space. Rapid search and load routine for tapes. How the Beeb and Electron work 1. Business: reviews end how to gently enter office computerisation. Education - adult literacy. Dumping Atom programs on the BBC. Atom Forum. Software copyright laws. Hints & Tips. Techniques - B-Trees. Beeb Forum. Reviews of monitors, printers, books, software, adventures, EPROM programmer.

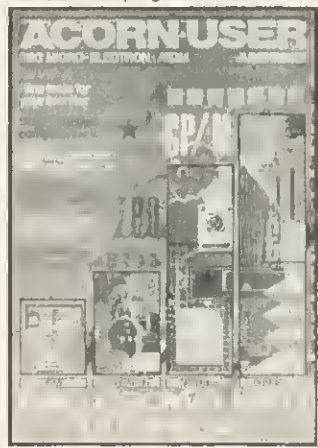

**\*\*\* Sold-out copies**

Four issues of Acorn User are not available - July 1982, February, March and April 1983. Photocopies of articles are available at 18p a page (minimum charge 50p, inclusive of postage). Orders should be addressed to AU Photocopies, Redwood Publishing, 68 Long Acre, London WC2E 9JH. Figure in brackets indicate the number of pages for each article.

**HOW TO ORDER**

Fill in the order form opposite and send with your cheque or postal order for £1.25 per issue (made payable to Redwood Publishing) to Acorn User Services, PHS Mailing Ltd, PO Box 14, Horley, Surrey.



# ACORN USER

# SUBSCRIPTIONS

Please start my subscription to Acorn User from the next available issue as indicated:

**Beat any price rise!**

	12 months	24 months
01: UK	£15 <input type="checkbox"/>	£30 <input type="checkbox"/>
02: Europe	£25 <input type="checkbox"/>	£50 <input type="checkbox"/>
03: Middle East	£30 <input type="checkbox"/>	£60 <input type="checkbox"/>
04: The Americas and Africa	£30 <input type="checkbox"/>	£60 <input type="checkbox"/>
05: All other countries	£35 <input type="checkbox"/>	£70 <input type="checkbox"/>

Name

Address

Please answer these questions to help us improve your magazine.

- Do you use your micro for?:  
 school    business    hobby
  - Do you have, or intend to buy, any of the following?:  
 monitor    disc drive    second processor  
 printer    modem
  - How many software packages do you think you will buy in the next 12 months?:  
 0-5    6 to 10    10 or more
- I enclose my cheque/postal order/sterling bank draft payable to Redwood Publishing for £.....
- Please debit my Access/American Express/Barclaycard  
 Account no.

Signed..... Date.....  
 Send this form, with your remittance, in an envelope, to Acorn User Subscriptions, Redwood Publishing, 68 Long Acre, London WC2E 9JH.

EXPRESS ORDER FORM

# ACORN USER

# SERVICES

## BACK DATED ISSUES @ £1.25 per copy

	MONTH	YEAR	
<input type="text"/> AU <input type="text"/>	issue	.....	£.....
<input type="text"/> AU <input type="text"/>	issue	.....	£.....
<input type="text"/> AU <input type="text"/>	issue	.....	£.....
			Total £.....



**NEW**

## BINDERS

In red with silver logo on the spine. Holds 12 issues of over 200 pages. ONLY £4.75 inc. p&p.

Binders @ £4.75 £.....

Please add £1.00 each for overseas items. Please allow 28 days for delivery.

Name.....

Address.....

I enclose my cheque/PO payable to Redwood Publishing for £.....

Please debit my Access/Barclaycard  
 Account no.

Signed..... Date.....

Send this form, with your remittance, in an envelope, to Acorn User Services, PHS Mailing Ltd, PO Box 14, Horley, Surrey. All the above prices include postage and packing.

EXPRESS ORDER FORM

# ACORN USER

# SOFTWARE

## DISC EXCHANGE SERVICE

Send in your copy of Trek or Sword Master with a cheque for £3.50 and we will exchange it for a disc. (Which runs on 40 or 80 tracks).

**NEW**

..... Tape(s) in exchange for disc @£3.50 each      £.....

Please send me:

	Tape	Disc	
..... Copies of Sword Master for BBC (32k series 1.0 OS) for Electron	£7.95	£10.95	£.....
..... Copies of Trek for BBC (32k series 1.0 OS) for Electron	£7.95	£10.95	£.....
.....	£7.95		£.....

## MONTHLY PROGRAM LISTING CASSETTES

Please send me a cassette of all major BBC Micro and Electron program listings (November issue) as advertised on page 96

**NEW**

@ £3.75 £.....

Total £.....

Name.....

Address.....

I enclose my cheque/PO payable to Redwood Publishing for £.....

Please debit my Access/Barclaycard

Account no.

Signed..... Date.....

Send this form, with your remittance, in an envelope, to Acorn User Software, PHS Mailing Ltd, PO Box 14, Horley, Surrey. All the above prices include postage and packing.

**24 HOUR PHONE SERVICE (02934) 72208**

Please add £1.00 each for overseas items. Please allow 28 days for delivery.

EXPRESS ORDER FORM

# ACORN USER SOFTWARE

FOR THE BBC MICRO AND ELECTRON  
ON DISC AND CASSETTE

Two quality, full colour games to test your skill, nerve and cunning.

Each £7.95 per cassette or £10.95 per disc (40/80 track).

Price includes VAT and postage.

Both games need OS1.0, or later, and 32k.

Developed, produced and tested by Micrograf.



**SWORD MASTER** is one of the few two-player games around, and is designed for joystick or keyboard.

Sword Master by Ken Worrall is based on the fencing rules written in 1190 by Herman von Salza for the Deutscher Ritter Order of Teutonic Knights. It features full-colour machine code animation of a sword duel between two knights.

*'A quality game with high class graphics ... one of the most enjoyable games I have played'* - Home Computer Weekly  
*'An immensely entertaining game with excellent graphics and animation'* - Personal Computer Games  
*'Sword Master is a unique game'* - Personal Computer News  
*'Sticky animated and suitably medieval'* - Popular Computing Weekly



**TREK** was the first game to take advantage of voice synthesis on the BBC micro - and uses joystick or keyboard.

Trek puts you in charge of a Starship with the task of wiping out an alien fleet. It's an excellent adaptation of the classic game with 7 screen displays, 3 on-board computers and 2 weapon systems.

Versions have been written for BBC micro and Electron to use both machines to their full. The BBC tape uses voice synthesis (if the chips are fitted).

The game has been extensively developed from Tim Heaton's famous Trek III. It barely fits into 32K.

## DISC UPGRADE SERVICE

Return your cassette of Trek or Swordmaster, and we will exchange it for a disc (which will run on 40 or 80-track drives) for just £3.50. Please specify Amcom, Watford or Acorn DFS.

# PLUS

## ARTICLE LISTINGS ON CASSETTE

Yes, at last, the tape you've been crying out for! Save the wear on your fingers by sending for one of our cassettes giving all the major listings in this issue.

Each cassette costs £3.75 (inclusive) for the Electron and BBC micro. This includes a menu and disc transfer routine to help you find your way around - and use on your own programs.

The tapes come with BBC programs on one side and Electron programs as the other, so it shouldn't be possible to mix the two. Order form on page 95.



Save yourself the time and bother of typing in Acorn User listings

ORDER FORM ON PAGE 95



Acorn User is, we believe, the first UK magazine to print a listing in barcode (this one uses Telepen format). It has been made possible by a project developed by the MEP and Addison-Wesley Publishers, whose barcode reader will be released at the end of this month (see News). The first person to identify which listing in this issue is represented by this barcode dump will win an Addison-Wesley barcode reader package worth £50.

1  
2  
3  
4  
5  
6  
7  
8  
9  
10  
11  
12  
13  
14  
15  
16  
17  
18  
19  
20  
21  
22  
23  
24  
25  
26  
27  
28  
29  
30  
31  
32  
33  
34







# SAVED...JUST IN TIME!

IT'S happened to all of us of course. Several long hours into the night and the latest programming masterpiece nears completion. Then—*slap, bang, wallop*—it happens. The computer throws a wobbly and all your hard work disappears from the memory banks, and we never made those regular programming saves to safeguard ourselves, did we?

Not to worry. James Clarke of Marlborough College has come up with the answer. An interrupt-driven program saver that automatically saves a copy of the current program in memory, between PAGE and TOP, to disc every four minutes or so.

The routine works by enabling the 'timer crossing zero event' and setting the interval timer to about four minutes or so away from 'crossing zero'. When the event occurs, control is passed to a save routine, no matter what the computer is doing at the time—even during a program run—and saves it. Once saved, control is passed back to the task in hand.

Using the program is simple. Type in the listing as shown and save the program under a suitable name. Now run the program to assemble the machine code and save the machine code as follows:

```
*SAVE ISAVE 8D0 900 8D0
```

To use the program run the machine code with:

```
*ISAVE lifename
```

where lifename is the name of the file you wish to assign to your file.

If you have a useful program that you feel might make it to the top of our list then why not send in? Address it to Top of the Lists, *Acorn User*, Redwood Publishing, 68 Long Acre, London WC2E 9JH. Published contributions will earn their authors £25.

99

```

10 REM Interrupt Program Saver
20 REM J.E.CLARKE
30 REM Acorn User Novemeber 1984
40 REM BBC Micro with DFS
50 :
60 oswrch=%FFEE:osfile=%FFDD
70 osfind=%FFCE:osnl=%FFE7
80 osbyte=%FFF4:osword=%FFF1
90 space%=%8D0:pblock=%9B5
100 filename=%9D0:page=PAGE
110 timebase=%70
120 FOR T%=0 TO 2 STEP 2
130 P%=space%
140 LDPTT%
150 .start
160 LDA %706
170 CMP# %20
180 BNE syntax
190 LDX# 0
200 .loop
210 LDA %707,X
220 STA filename,X
230 INX
240 CMP# %0D
250 BNE loop
260 LDA#40
270 LDX #filename MOD 256
280 LDY #filename DIV 256
290 JSR osfind
300 LDA#0:LDY#0:JSR osfind
310 LDA #%FF:STA timebase
320 LDA #%AF:STA timebase+1
330 LDA #%FF:STA timebase+2
340 LDA #%FF:STA timebase+3
350 LDA #%FF:STA timebase+4
360 LDA #save MOD 256:STA %220
370 LDA #save DIV 256:STA %221
380 LDA #14:LDX #5:JSR osbyte
390 .timeset
400 LDA #4
410 LDX #timebase MOD 256
420 LDY #timebase DIV 256
430 JSR osword
440 RTS
450 :
460 .syntax
470 JMP syntax1
480 :
490 .save
500 PHP:PHA:TXA:PHA:TYA:PHA
510 LDA #7:JSR oswrch
520 LDA #13:LDX #5:JSR osbyte
530 LDA #filename MOD256:STA pblock
540 LDA #filename DIV256:STA pblock+1
550 LDA #page MOD256:STA pblock+2
560 LDA #page DIV256:STA pblock+3
570 LDA %%8023 MOD256:STA pblock+6
580 LDA %%8023 DIV256:STA pblock+7
590 LDA #page MOD256:STA pblock+10
600 LDA #page DIV256:STA pblock+11
610 LDY %12:INY:TYA:STA pblock+14
620 LDA %13:STA pblock+15
630 LDA# 0:LDX# pblock MOD256:LDY# pblock DIV256
640 JSR osfile
650 LDA #14:LDX #5:JSR osbyte
660 JSR timeset
670 PLA:TAY:PLA:TAX:PLA:PLP
680 RTS
690 :
700 .syntax1
710 JSR osnl
720 LDX #0
730 .loop2
740 LDA syn,X
750 JSR oswrch
760 INX
770 CMP %%0D
780 BNE loop2
790 JSR osnl
800 RTS
910 I
820 syn=P%+1
830 #syn="Syntax: ISAVE <afsp>"+CHR#13
840 NEXT

```

See 'Co-ordinated Moves', page 41

Listing 1. This program incorporates a variety of procedures to draw and fill in with colour the shapes that make up the 'car' pictured below

100

```

10 REM MOTOR CAR
20 REM Tessie Revivis
30 REM for BBC and Electron
40 REM (c) Acorn User October 84
50 :
60 MODE2
70 PROCfillrec (300,300,700,200,2)
80 PROCfilltri (400,500,450,500,450,6
00,1)
90 PROCfillrec (460,500,400,100,4)
100 PROCfilltri (860,500,960,500,860,6
00,1)
110 PROCcircle (400,250,50,1)
120 PROCfillcir (400,250,50,1)
130 PROCcircle (900,250,50,1)
140 PROCfillcir (900,250,50,1)
150 PROCrectangle (500,325,100,150,3)
160 PROCrectangle (700,325,100,150,3)
170 PROCtriangle (970,500,20,100,1)
180 END
190 :
200 DEF PROCrectangle (X%,Y%,SX%,SY%,C
%)
210 GCOLOR,C%
220 MOVE X%,Y%
230 DRAW X%+SX%,Y%
240 DRAW X%+SX%,Y%+SY%
250 DRAW X%,Y%+SY%
260 DRAW X%,Y%
270 ENDPROC
280 :
290 DEF PROCtriangle (X%,Y%,SX%,SY%,C%
)
300 GCOLOR,C%
310 MOVE X%,Y%
320 DRAW X%+SX%,Y%
330 DRAW X%+(SX%/2),Y%+SY%
340 DRAW X%,Y%
350 ENDPROC
360 :
370 DEF PROCcircle (X%,Y%,R%,C%)
380 GCOLOR 0,C%
390 VDU 29,X%;Y%;
400 c=COS(PI/30):s=SIN(PI/30)
410 DC=1 : DS=0
420 MOVE R%*DC,R%*DS
430 FOR A%=1 TO 60
440 NC=DC*c-DS*s
450 NS=DS*c+DC*s
460 DRAW R%*NC,R%*NS
470 DC=NC : DS=NS
480 NEXT
490 VDU29,0;0;
500 ENDPROC
510 :
520 DEF PROCfilltri (X%,Y%,X2%,Y2%,XA%
,YA%,C%)
530 GCOLOR 0,C%
540 MOVE X%,Y%
550 MOVE X2%,Y2%
560 PLOT 85,XA%,YA%
570 ENDPROC
580 :
590 DEF PROCfillrec (X%,Y%,XS%,YS%,C%)
600 GCOLOR 0,C%
610 MOVE X%,Y%
620 MOVE X%+XS%,Y%
630 PLOT 85,X%+XS%,Y%+YS%
640 MOVE X%,Y%+YS%
650 PLOT 85,X%,Y%
660 ENDPROC
670 :
680 DEF PROCfillcir (X%,Y%,R%,C%)
690 GCOLOR 0,C%
700 VDU 29,X%;Y%;
710 FOR loop=-R% TO R%
720 PLOT77,0,loop
730 NEXT
740 VDU29,0;0;
750 ENDPROC

```





Listing 1. Multiplications table testing program with time limit set using the INKEY statement, from Jonathan Tate

```

10 REM Listing 1
20 MODE 7
30 VDU23,1,0;0;0;0;
40 PRINTCHR$(141);CHR$(131);CHR$(157)
;CHR$(132)"          TABLES TEST"
50 PRINTCHR$(141);CHR$(131);CHR$(157)
;CHR$(132)"          TABLES TEST"
60 A=INKEY(300)
70 VDU2B,0,15,39,5
80 VDU23,1,1,0;0;0;
90 PRINTTAB(0,6)"This program will te
st your knowledge of the tables."
100 INPUT"How many questions would you
like in the test?.."N
110 INPUT"How many seconds do you need
to answer each question?.."S
120 VDU23,1,0;0;0;0;
130 CLS:PRINTTAB(0,6)"Press RETURN as
soon as the question is displayed,"
140 PRINT"followed by your answer,"
150 PRINT"then press RETURN again."
160 PRINT:PRINT"Press RETURN when read
y": A#=GET$
170 right =0
180 Z=0
190 Z=Z+1:IF Z>N GOTO340

200 P=RND(12)
210 IF P=1 GOTO200
220 Q=RND(12)
230 IF Q=1 GOTO220
240 CLS
250 PRINTTAB(4,6)P;" TIMES ";Q
260 finishtime=TIME+S*100:REPEAT UNTIL
TIME>finishtime OR A#=GET$
270 INPUT X
280 IF TIME>finishtime PRINTCHR$(132)"
TOO SLOW!":A=INKEY(200):GOTO 190
290 IF X=P*Q PRINT CHR$(131)"CORRECT":
right=right+1:A=INKEY(200):GOTO190
300 IF X<>P*Q PRINTCHR$(129)"WRONG!"
310 A=INKEY(200)
320 PRINT"THE ANSWER IS ";P*Q
330 A=INKEY(200):GOTO190
340 CLS:PRINTTAB(5,6)"You got ";right;
" correct out of ";N
350 A=INKEY(100)
360 IF right/N=1 PRINTTAB(9,10)CHR$141
;CHR$129;CHR$157;CHR$133;CHR$136"BRILLIA
NT "CHR$156
370 IF right/N=1 PRINTTAB(9,10)CHR$141
;CHR$129;CHR$157;CHR$133;CHR$136"BRILLIA
NT "CHR$156
380 END

```

101

Listing 2. Modification of listing 1, incorporating three new procedures, making it easier to read

```

10 REM Listing 2
20 MODE 7
30 VDU23,1,0;0;0;0;
40 PRINTCHR$(141);CHR$(131);CHR$(157)
;CHR$(132)"          TABLES TEST"
50 PRINTCHR$(141);CHR$(131);CHR$(157)
;CHR$(132)"          TABLES TEST"
60 A=INKEY(300)
70 VDU2B,0,15,39,5
80 VDU23,1,1,0;0;0;
90 PRINTTAB(0,6)"This program will te
st your knowledge of the tables."
100 INPUT"How many questions would you
like in the test?.."N
110 INPUT"How many seconds do you need
to answer each question?.."S
120 VDU23,1,0;0;0;0;
130 CLS:PRINTTAB(0,6)"As soon as the q
uestion is displayed,"
140 PRINT"type in your answer,"
150 PRINT"then press RETURN."
160 PRINT:PRINT"Press RETURN when read
y": A#=GET$
170 right =0
180 Z=0
190 Z=Z+1:IF Z>N GOTO 320
200 P=RND(12)
210 IF P=1 GOTO200
220 Q=RND(12)
230 IF Q=1 GOTO220
240 CLS
250 PRINTTAB(4,6)P;" TIMES ";Q
260 finishtime=TIME+S*100
270 INPUT X
280 IF X=P*Q PROCright
290 IF X<>P*Q PROCwrong
300 IF TIME>finishtime PROctimeout
310 A=INKEY(200):GOTO190
320 CLS:PRINTTAB(5,6)"You got ";right;
" correct out of ";N
330 A=INKEY(100)
340 IF right/N=1 PRINTTAB(9,10)CHR$141
;CHR$129;CHR$157;CHR$133;CHR$136"BRILLIA
NT "CHR$156
350 IF right/N=1 PRINTTAB(9,10)CHR$141
;CHR$129;CHR$157;CHR$133;CHR$136"BRILLIA
NT "CHR$156
360 END
370 :
380 DEFPROCright
390 PRINT CHR$(131)"CORRECT"
400 right=right+1
410 ENDPROC
420 :
430 DEFPROCwrong
440 PRINTCHR$(129)"WRONG!"
450 PRINT"THE ANSWER IS ";P*Q
460 ENDPROC
470 :
480 DEFPROctimeout
490 PRINTCHR$(132)"TOO SLOW!"
500 ENDPROC

```

See page 45

Listing 3. Next round of changes . . .

```

10 REM Listing 3
20 MODE 7
30 VDU23,1,0;0;0;0;
40 PRINTCHR$(141);CHR$(131);CHR$(157)
;CHR$(132)"          TABLES TEST"
50 PRINTCHR$(141);CHR$(131);CHR$(157)
;CHR$(132)"          TABLES TEST"
60 A=INKEY(300)
70 VDU28,0,15,39,5
80 VDU23,1,1,0;0;0;
90 PRINTTAB(0,6)"This program will te
st your knowledge of the tables."
100 INPUT"How many questions would you
like in the test?.."N
110 INPUT"How many seconds do you need
to answer each question?.."S
120 VDU23,1,0;0;0;0;
130 CLS:PRINTTAB(0,6)"As soon as the q
uestion is displayed,"
140 PRINT"type in your answer,"
150 PRINT"then press RETURN."
160 PRINT:PRINT"Press RETURN when read
y":A$=GET$
170 right=0;Z=0;timeout=0
180 REPEAT;Z=Z+1
190 P=1+RND(9)
200 Q=1+RND(9)
210 CLS
220 PRINTTAB(4,6)P;" TIMES ";Q
230 finishtime=TIME+S*100
240 INPUT X
250 IF X=P*Q PROCright
260 IF X<>P*Q PROCwrong
270 IF TIME>finishtime+100 PROCtimeout
280 A=INKEY(200)
290 UNTIL Z=N
300 PROCresults
310 END
320 :
330 DEFPROCright
340 PRINT CHR$(131)"CORRECT"
350 right=right+1
360 ENDPROC
370 :
380 DEFPROCwrong
390 PRINTCHR$(129)"WRONG!"
400 PRINT"THE ANSWER IS ";P*Q
410 ENDPROC
420 :
430 DEFPROCtimeout
440 PRINTCHR$(132)"TOO SLOW!"
450 timeout=timeout+TIME-finishtime
460 ENDPROC
470 :
480 DEFPROCresults
490 CLS
500 PRINTTAB(0,6)"You got ";right;" co
rrect out of ";N
510 IF timeout>100 THEN PRINT"but took
";timeout DIV 100;" seconds too long":E
NDPROC
520 IF right<N THEN ENDPROC
530 PRINTTAB(9,9)CHR#141;CHR#129;CHR#1
57;CHR#133;CHR#136"BRILLIANT" "CHR#156
540 PRINTTAB(9,10)CHR#141;CHR#129;CHR#
157;CHR#133;CHR#136"BRILLIANT" "CHR#15
6
550 A=BET
560 ENDPROC

```

102

Listing 4. The final stage, with question and answer printed on-screen in double-height

```

10 REM Listing 4
20 MODE 7
30 VDU23,1,0;0;0;0;0;
40 PRINTCHR$(141);CHR$(131);CHR$(157)
;CHR$(132)"          TABLES TEST"
50 PRINTCHR$(141);CHR$(131);CHR$(157)
;CHR$(132)"          TABLES TEST"
60 A=INKEY(300)
70 VDU28,0,15,39,5
80 VDU23,1,1,0;0;0;0;
90 PRINTTAB(0,6)"This program will te
st your knowledge of the tables."
100 INPUT"How many questions would you
like in the test?.."N
110 INPUT"How many seconds do you need
to answer each question?.."S
120 VDU23,1,0;0;0;0;
130 CLS:PRINTTAB(0,6)"As soon as the q
uestion is displayed,"
140 PRINT"type in your answer,"
150 PRINT"then press RETURN."
160 PRINT"Press RETURN when ready":A$
=BET$
170 right=0;Z=0;timeout=0
180 REPEAT;Z=Z+1
190 P=1+RND(9)
200 Q=1+RND(9)
210 CLS
220 answer$=""
230 finishtime=TIME+S*100
240 REPEAT
250 PRINTTAB(4,6)CHR#141 P;" TIMES ";Q
;" = "answer$
260 PRINTTAB(4,7)CHR#141 P;" TIMES ";Q
;" = "answer$
270 A$=GET$:answer$=answer$+A$
280 UNTIL A$=CHR$(13)
290 X=VAL(answer$)
300 IF X=P*Q PROCright
310 IF X<>P*Q PROCwrong
320 IF TIME>finishtime+100 PROCtimeout
330 A=INKEY(200)
340 UNTIL Z=N
350 PROCresults
360 END
370 :
380 DEFPROCright
390 PRINT CHR$(131)"CORRECT"
400 right=right+1
410 ENDPROC
420 :
430 DEFPROCwrong
440 PRINTCHR$(129)"WRONG!"
450 PRINT"THE ANSWER IS ";P*Q
460 ENDPROC
470 :
480 DEFPROCtimeout
490 PRINTCHR$(132)"TOO SLOW!"
500 timeout=timeout+TIME-finishtime
510 ENDPROC
520 :
530 DEFPROCresults
540 CLS
550 PRINTTAB(0,6)"You got ";right;" co
rrect out of ";N
560 IF timeout>100 THEN PRINT"but took
";timeout DIV 100;" seconds too long":E
NDPROC
570 IF right<N THEN ENDPROC
580 PRINTTAB(9,9)CHR#141;CHR#129;CHR#1
57;CHR#133;CHR#136"BRILLIANT" "CHR#156
590 PRINTTAB(9,10)CHR#141;CHR#129;CHR#
157;CHR#133;CHR#136"BRILLIANT" "CHR#156
600 A=BET
610 ENDPROC

```



See 'Mirror and Clone', page 65



## HOW TO ENTER DESIGN AND ASSEMBLER

SOME of you will already have the original version from September's Issue of Acorn User, without the new procedures. Others will be entering the entire thing from scratch. We'll deal with this latter group first. The programs must be entered and RUN with PAGE set to &1900. Just type

```
PAGE = &1900 <RETURN> NEW <RETURN>
```

It's best to enter the assembler program first. Type

```
AUTO 940 <RETURN>
```

and enter the listing. AUTO provides you with a new line number each time you press return. The odd-numbered lines containing REMs, 965, 1315, 1605, and 2705 should be left out - they're for information only. You can put them in later if you want. When you've entered all of the assembler press Escape and re-enter line 950 as:-

```
950 FOR J% = 0 TO 3 STEP 3
```

It's a good idea at this point to save the program in the normal way. Now type PROCassemble <RETURN>. If you have made any syntax errors in the listing they will be reported. Sort them out and when no errors are being reported, change line 950 back to:

```
950 FOR J% = 0 TO 2 STEP 2
```

To check that no other errors have been made you can make a number of tests. First of all, type PROCassemble, then type PRINT P%. This should produce the response 4830. If you don't get this answer you have a typing error. To find out where it is, type PRINT PIXAD. This should give the answer 4471. If it doesn't, you have made a mistake in the first quarter of the program, up to line 1690. When that's sorted, type PROCassemble again, followed by PRINT LOOP2. The answer here should be 4611. If not, your mistake is between lines 1690 and 2510. To check the third quarter type PROCassemble again and then PRINT zero. The correct answer is 4719, otherwise you have a mistake between lines 2510 and 3620. The last quarter is tested now by typing PROCassemble and then PRINT P%. The answer should be 4830.

The final test is to add the following lines to the program

```
1 PROCassemble
2 Z% = 0
3 FORN% = &1100 TO &12DD
4 Z% = Z% + ?N%
5 NEXT
6 PRINT "CHECKSUM IS :";Z%
7 END
```

RUN the program and you should get the answer 55856. If not you will have to recheck the whole listing. Look out for things like TYA being TAY or missing symbols like #.

Now that you've got it all OK you can delete lines 1 to 7, save the listing, type PROCassemble, and then save the machine code that it has generated by typing

```
*SAVE EDCODE 1100 12DE
```

Now, if you're still in good form, type NEW followed by AUTO and enter the 'Design' program starting at line 10. Ignore any lines before line 10. They will make the program too long. Type everything in exactly as it is printed and be careful not to put in any extra spaces. There are 4 lines with odd numbers - 245, 315, 345 and 795.

It's easier to leave them out the first time through and enter them afterwards. You must remember to put them in though. When you've finished, press Escape to stop

the AUTO line numbers being generated, and then type PRINT TOP.

This should give the answer 11908, or something very close. If it doesn't, have you remembered to put in the four odd-numbered lines? Save the program.

Line 30 loads the machine code generated by PROCassemble so if you are using tape you should ensure that a copy of EDCODE comes immediately after the 'Design' program on your tape. You can do this by re-loading PROCassemble, winding your tape on to the end of 'Design', typing PROCassemble, and typing:

```
*SAVE EDCODE 1100 12DE
```

Now you're ready to go. Just CHAIN "DESIGN" in the normal way. It will load the machine code automatically and you can get on with designing things from other galaxies or special symbols or whatever.

## MODIFYING THE ORIGINAL DESIGN

THOSE of you who already have the original program can add the new facilities without too much trouble.

First load the program (with PAGE set to &1900 of course) and type DELETE0,935. Then type AUTO 2900 and enter the new lines of assembler, starting at 2900 in the listing. All lines before that are unchanged. Follow the instructions given above for debugging the assembler and \*SAVE the code as EDCODE. Save PROCassemble as well so that you have a copy of the source code.

Load 'Design' again and type DELETE0,190. Type DELETE940,2920. Now type AUTO and enter lines 10 to 190. When you've finished, press Escape to get out of AUTO then type AUTO940 and enter the lines from that point in this month's 'Design' listing. Press Escape when you've finished. If you included the 'separator' lines 575, 625, 725, 775 and 935 in the original program, delete them now. They use five bytes each and memory's very tight. Now, delete lines 330, 560 and 730 to 770 inclusive.

New lines to be added from this month's listing are 245, 315, 345 and 795. Lines to be changed are 240, 490, 500, 510, 550, 570, 670, 710, 790, 800, 850, 860, 870, 880, 890 and 920. That looks a lot, but the changes are quite small. When you've done all this, type PRINT TOP. The answer should be about 11896. If it's much more than this you may get the awful 'no room' message when you run the program. Check that you've removed all the lines listed above, and that you haven't added any spaces. Typing WIDTH40 and listing the program should give you exactly what you see in the yellow pages.

## NEW PROCEDURES

(For other procedures see the September issue of Acorn User.)

### 140 to 490 PROCed

This is the procedure that handles screen output when you are editing or designing new sprites. It tests for key-presses and takes appropriate action. It was originally the main control loop of the program. See September issue for a fuller description.

page 104 ▶

◀ page 103

- **510 to 570 PROCen**  
Tells you how many sprites you have designed, where the data is in memory, and asks you whether you want to save the data. PROCsave does this automatically if you do.
- **940 to 1080 PROCshow**  
Sets up the mode 2 screen if you are editing, ensuring that the 'design box' is the right size and central, and displaying the sprite you want to edit.
- **1090 to 1260 PROCmenu**  
Prints up the options and takes appropriate action depending on your choice (returned in G%). If you want to carry out some operation on an existing design, PROCfl is called (see below). If you choose cloning or mirroring, the relevant procedure is called.
- **1270 to 1310 PROCll**  
Asks if the sprite data is already in memory, and if not it sets A% = &FF, which causes the now misleadingly titled PROCsave to load the data. All PROCsave does is to set up a parameter block at &3000 and call OSFILE at &FFDD. If A% = 0 this routine will save a file; if A% = &FF, it will load it.
- **1320 to 1590 PROCml**  
A series of loops to reverse sprites 0 to 3 and put these mirror images into the data areas of sprites 4 to 7. It sends the data from each of the 24 rows of a sprite to zero page locations starting at &80, and then calls the machine code routine 'reverse' at &1258 (line 1470). This swaps the pixels in each byte and the loop at 1480 to 1510 puts the changed bytes into their new locations.
- **1600 to 1730 PROCct**  
Finds out which sprite you want to clone and works out where to put the cloned image. Lines 1630 to 1700 check to see if the right-hand column of the design is clear so the design can be shifted to the right without anything falling off the end. If all is well the clone routine at &1274 is called.

- **1740 to 1850 PROCln**  
If you choose to design new sprites this procedure is called to clear work areas and initialise the control variables. It finds out what width you want for your sprites, sets up the address table starting at &12F0 accordingly, and sets  $W = 8 * \text{sprite width}$  - ie the block size.
- **1860 to 1970 PROCno**  
When you elect to quit, this procedure looks through memory to see how many sprites you have designed and where they are. It is called by PROCen, which needs this information before it can call PROCsave.

## HINT FOR OWNERS OF TAPE OR ECONET MACHINES

IT'S easy to forget that these programs have to be run with PAGE set at &1900. A simple way to overcome this is to have a short loader program which will handle it for you:

```
10*KEY10PA. = &1900:MNEW:MCH."DES:GN":M
20*FX138,0,138
```

For Econet machines line 10 should read:

```
10*KEY10?&224 = &A6:MPA. = &1900:MNEW:MCH.
"DESIGN":M
```

Be careful not to put any spaces after the final M in line 10.

If you save this little program as "DES", immediately before "DESIGN" on your tape, you can forget all about setting PAGE. Just CHAIN "DES" and it will load the other program at the right location.

The completed version of the 'Design' program, incorporating new procedures (see above for instructions)

```
10*KEY10?&224=&A6:MPA.=&1900:MOULD:M
20*TV255
30*LO.EDCODE
40REPEAT
50CLS
60PROCmenu
70IFG%=4 MODE7:PROCln
80IFG%=1 ORG%=4 MODE2:PROCed
90MODE 7
100UNTILG%=5
110MODE7:A%=0:PROCen
120*FX4
130PRINT:END
140DEFPROCed
150W%=?&12EF/8
160table%=&12F0:end%=FALSE
170*FX4,1
180VDU23,1,0;0;0;0;
190VDU23,240,0,0,&F0,&F0,&F0,&F0,0,0,2
3,241,0,0,&40,&E0,&40,0,0,0
200key#="0123456789ABCDEF"
210REPEAT
220I%=cha%*2:base%=I%?&12F0+I%?&12F1*2
56+8
230space%=(80-?&12EF DIV8*7)DIV8
240CLG:IF cha%>0:?&71=space%:FORI%=0T
0 cha%-1:?&70-I%:?&72=16:CALL&1193:?&71=
?&71+?&12EF/8+space%:NEXT
245VDU26,5:5%=(?&12EF DIV8-4)*16+40B:M
OVES%:820:GCLO,3:PRINT"char":cha%
250VDU28,0,22,7,9,4
260VDU30:COLOUR7:PRINT"KEYS"
270e%=0:PRINTTAB(0,2)"0";TAB(2);"8";:C
OLOUR3:PRINTCHR#240:FORI%=1T07:COLOURI%:
PRINTI%:CHR#240;~I%+8;:COLOURI%+8:PRINTC
HR#240:COLOURI%-1:NEXT
280VDU28,0,31,19,21
290COLOUR6:PRINTTAB(2,0)"Press TAB whe
n";TAB(2)"design finished":COLOUR3
300PRINTTAB(1)"use cursor keys to"
position pointer"
310W%=?&12EF/4:VDU29,440-8*(W%-8)-8;40
0;:MOVE0,0
315GCLO,7
320PLOT21,0,12*32+6:PLOT29,W%*32+8,12*
32+6:PLOT21,W%*32+8,0:PLOT29,0,0
340X%=8:Y%=24
345IFG%=1 PROCshow
350PROCpnter (X%,Y%)
360REPEAT
370K%=INSTR(key#,GET#)
380IF K%>0 col%=K%-1:PROCdraw(col%,X%
,Y%):PROCpnter (X%,Y%)
390IF INKEY (-58) ANDY%<384 PROCpnter (X%,Y
%):Y%=Y%+16:PROCpnter (X%,Y%)
400IF INKEY (-42) ANDY%>24 PROCpnter (X%,Y%
):Y%=Y%-16:PROCpnter (X%,Y%)
410IF INKEY (-26) ANDX%>8 PROCpnter (X%,Y%
):X%=X%-32:PROCpnter (X%,Y%)
420IF INKEY (-12) ANDX%<32*(W%-1) PROCpn
ter (X%,Y%):X%=X%+32:PROCpnter (X%,Y%)
430UNTIL INKEY (-97)
440cha%=cha%+1:IFcha%=2 cha%=3 ELSE IF
cha%=6 cha%=7
450VDU4,12,23,1,0;0;0;0;
460IF cha%=8 PRINTTAB(2,0)"8 chars. de
fined. ";TAB(4,2)"No more room. ";TAB(2,7)
;:COLOUR3:PRINT"SPACE to continue":end%
```



```

TRUE:ELSE PRINTTAB(7,2)"press";TAB(1,4);
:COLOUR3:PRINT" SPACE to continue";TAB(2
,6);:COLOUR6:PRINT" CTRL Z to exit "
470REPEAT6=GET:UNTIL6=&20 OR6=&1A:IF6=
&1A end%=TRUE
480UNTIL end%
490ENDPROC
500DEFPROCen
510PROCno
520PRINTTAB(0,2)" Data goes from"CHR#1
34"&1300"CHR#135"to"CHR#134;"&";~base%+3
*?&12EF:PRINT";CHR#131;cha%;CHR#135;"ch
aracters defined"CHR#131;"(0 to ";cha%-1
;")."
530PRINT"" Table of addresses is @";C
HR#130;"&12F0";CHR#135;"to";CHR#130;"&";
~&12F0+cha%*2-1
540PRINT"" Do you want to save the da
ta and the "" address table (Y/N)?":RE
PEAT6=GET OR&20:UNTIL6=&79 OR6=&6E
550IF6=&79 A%=0:PROCSave
570ENDPROC
580DEFPROCpntr(X%,Y%)
590VDU5
600MOVEX%,Y%
610GCOL3,7
620PRINTCHR#241
630ENDPROC
640DEFPROCdraw(col%,X%,Y%)
650VDU5
660MOVEX%,Y%
670?&88=(X%-6)DIV32:??&89=23-((Y%-24)DI
V16):??&87=col%:??&1137=base%MOD256:??&1138
=base%DIV256:??&1168=base%MOD256:??&1169=b
ase%DIV256
680?&70=&4F78+(?&12EF*2)
690GCOLOR,col%
700PRINTCHR#240
710CALL&1100
720ENDPROC
780DEFPROCsave
790IFAX%=0 PRINT"" What do you want to
call the file?"CHR#136;"(max. 7 letter
s - no quotes needed)".
795IFAX%=&FF PRINT""TAB(2)"What is the
name of the sprite file?"
800REPEAT:PRINTTAB(14)SPC(20):INPUTTAB
(14)"data#:UNTILLENDdata#<=7
810FORIX=&3000 TO&3030:?IX=0:NEXT
820DX=&3000
830?(DX+&20)=data#:?DX=&20:DX?1=&30
840DX?2=&EE:DX?3=&12
850IF AX%=&FF DX?6=1
860DX?%A=&EE:DX?%B=&12
870IF AX%=0 DX?%E=(base%+(3*?&12EF)+1)M
OD256:DX?%F=(base%+(3*?&12EF)+1)DIV256
880X%=0:Y%=&30
890PRINTTAB(4)"Press RETURN when you'r
e ready."
900REPEATUNTILGET=13
910CALL&FFDD
920IFAX%=0 PRINT"" Data saved as "data#
ELSE CLS
930ENDPROC
940DEFPROCshow
950Z%=0
960REPEAT
970VDU5,29,444-8*(WX-8)-8+Z%;400;:MOVE
0,0
980FORIX=0TO(3*?&12EF)-1:X3%=(IXMOD?&1
2EF)DIV8:Y3%=-((IXMOD8)+8*(IXDIV?&12EF))
+23
990X3%=(X3%*2)*32+6:Y3%=Y3%*16+24
1000?&B0=IX?base%:??&B1=0:IFZ%=0 CALU&12
30 ELSECALL&124A

```

```

1010GCOLOR,?&81
1020MOVEX3%,Y3%:PRINTCHR#240
1030NEXT
1040Z%=Z%+32
1050UNTILZ%=64
1060VDU29,440-8*(WX-8)-8;400;:MOVE0,0
1070?&70=cha%:??&71=47+(?&12EF/4):??&72=9
6:CALL&1193
1080ENDPROC
1090DEFPROCmenu
1100VDU26:@%=0
1110PRINTTAB(16,3)"MENU"
1120FORJ%=6 TO 14 STEP2:PRINTTAB(0,J%)"
":NEXT
1130PRINTTAB(4,6)"1. Edit already defin
ed sprites."
1140PRINTTAB(4,8)"2. Clone existing des
ign."
1150PRINTTAB(4,10)"3. Produce mirror im
ages of sprites."
1160PRINTTAB(4,12)"4. Design new sprite
s."
1170PRINTTAB(4,14)"5. Quit."
1180PRINTTAB(4,16)"Please select a numb
er...";
1190REPEAT PRINTTAB(31,16)CHR#127+CHR#1
27;:INPUTTAB(28,16)"G%:UNTIL G%>0 AND
G%<6
1200VDU28,0,24,39,16,12
1210IFG%<4 PROCfi ELSE IF G%>5 FORV%=0
TO5FF STEP4:V%!'&12EE=0:NEXT
1220IFG%=1 REPEAT:PRINTTAB(0,3)"Which c
har - 0 to 7 ";INPUTcha%:UNTILcha%>=0 A
NDcha%<8
1230IF G%=2 PROCcI
1240IF G%=3 CLS:PRINTTAB(4)"Please wait
a moment.":PROCmi
1250CLS
1260ENDPROC
1270DEFPROCfi
1280PRINTTAB(4)"Is the data already in
memory?";
1290REPEAT:G=GET OR&20:UNTILG=&79 ORG=&
6E
1300IFG=&6E AX%=&FF:PROCSave:ELSEIF(?&12
EF<32 OR?&12EF>80)G%=7
1310ENDPROC
1320DEFPROCmi
1330?&8D=?&12EF DIV8-1
1340CH%=0
1350REPEAT
1360ADD%=CH%?&12F0+CH%?&12F1*256+8
1370V%=CH%?&12F8+CH%?&12F9*256+8
1380C%=0
1390REPEAT
1400FORIX=0TO7
1410L%=&B0
1420FORJ%=0TO7&12EF-8 STEP8
1430K%=IX+J%
1440?L%=K%?ADD%
1450?L%=L%+1
1460NEXT
1470CALL&1258
1480FORM%=-L%-1 TO&B0 STEP-1
1490N%=-K%-(M%&80)*8
1500N%?V%=?M%
1510NEXT
1520NEXT

```



Continued ►

```

1530ADD%=ADD%+?&12EF:V%=V%+?&12EF:C%=C%
+1
1540UNTILC%=3
1550CH%=CH%+2
1560IFCH%=4 CH%=6
1570UNTILCH%=8
1580PRINT"OK. chars 4 to 7 are now mir
ror images of chars 0 to 3" TAB(7)"Pre
ss SPACE to continue..":REPEATUNTILGET=3
2
1590ENDPROC
1600DEFFPROCc1
1610REPEAT PRINT TAB(3,1)"Which charact
er do you want to clone (0 to 6) "
(CHR#127+CHR#127+CHR#127;:INPUTK#:UNTILA
SC(K#)>=48 AND ASC(K#)<=55:CR%=EVAL(K#)
1620CR%=CR%*2: ?&94=(CR%?&12F0)+8: ?&95=C
R%?&12F1: ?&96=(CR%?&12F2)+8: ?&97=CR%?&12
F3: F%=0: E%=0: CA%=CR%?&12F0+CR%?&12F1*256
+8
1630REPEAT
1640B%=?&12EF-8
1650REPEAT
1660IF (B%?CA% AND &55)<>0 F%=1
1670B%=B%+1
1680UNTIL B%=?&12EF OR F%=1
1690CA%=CA%+?&12EF: E%=E%+1
1700UNTILF%=1 ORE%=3
1710IFF%=1 PRINTTAB(3,4)"No space on ri
ght of sprite."ELSE CALL&1274:PRINTTAB(1
9)"OK"
1720PRINTTAB(8,7)"Press SPACE to contin
ue":REPEATUNTIL GET=32
1730ENDPROC
1740DEFFPROCin
1750FORJ%=0TO1: PRINTTAB(7,3+J%) CHR#129+
CHR#157+CHR#141+CHR#135"SPRITE DESIGN"+C
HR#9+CHR#9+CHR#9+CHR#156:NEXT
1760PRINTTAB(0,7)" You may design sprit
es between 8 and 20 pixels wide - only e
ven nos. allowed"" Please enter width
:"
1770REPEATPRINTTAB(21,10)SPC(25);:INPUT
TAB(21,10)" "W%:UNTILW%>7ANDW%<21 AND NO
TW%MOD2
1780W%=W%/2:IFW%=4 RESTORE1810 ELSEIFW%
=5 RESTORE1820 ELSE RESTORE1830
1790FORI%=%12F0 TO&12FF STEP 2:READA%: !
I%=EVAL ("%"+A%):NEXT
1800?&12EF=W%*8
1810DATA1300,1360,1300,1400,1460,1500,1
460,1560
1820DATA1300,1378,1300,1400,1478,1500,1
478,1570
1830DATA1300,1400,1300,1500,1600,1700,1
600,1800
1840cha%=0
1850ENDPROC
1860DEFFPROCc0
1870F%=0
1880REPEAT: E%=0
1890BA%=F%?&12F0+F%?&12F1*256+8
1900J%=0: REPEAT: IFJ%!BA%<>0 E%=1
1910J%=J%+4: UNTILJ%>=3*?&12EF ORE%=1
1920IFE%=1 F%=F%+2: IFF%=4 DRFX=12 F%=F%
+2
1930UNTILF%=16 ORE%=0
1940IFF%=6 DRFX=14 F%=F%-4: H%=1 ELSEH%=
0
1950cha%=F%/2: IF (cha%=1 ORcha%=5) ANDH%=
1 cha%=cha%+2
1955IFH%=0 F%=F%-2
1960base%=F%?&12F0+F%?&12F1*256+8
1970ENDPROC
    
```

The assembler section of 'Design'

```

940DEFFPROCAssemble
950FORJ%=0TO2 STEP2
960P%=&1100
965REM Square bracket
printed as left
arrow in Mode7
970OPT1%
980.byte_number
990LDA&B9
1000AND#7
1010STA&BF
1020LDA&B9
1030AND#&FB
1040LSRA:LSRA:LSRA
1050TAY
1060LDX#0
1070DEY
1080BMI no_add
1090LDA&12EF
1100INX
1110DEY
1120BMI no_add
1130INX
1140CLC
1150ADC&12EF
1160.no_add
1170CLC
1180ADC&BF
1190STA&BF
1200LDA&B8
1210AND#FE
1220ASLA
1230ASLA
1240CLC
1250ADC&BF
1260STA&BF
1270STA&BD
1280JSR pixad
1290.byte_value
1300LDX&BF
1310.address
1315\dummy address
1320LDA &B000,X
1330STA&B6
1340LDA#0
1350STA&B5
1360LDY#4
1370CLC
1380LDA&B8
1390LSRA
1400BCD even
1410CLC
1420.odd
1430ROR&B6
1440ROR&B7
1450ROR&B5
1460ROR&B6
1470ROR&B5
1480DEY
1490BNE odd
1500JMP store
1510.even
1520ROR&B6
1530ROR&B5
1540ROR&B6
1550ROR&B7
1560ROR&B5
1570DEY
1580BNE even
1590.store
1600LDA&B5
1605\dummy address
1610STA &B000,X
1620LDA#0
1630STA&B6
1640STA&B7
1650LDY&BD
1660LDA&B5
1670STA(&70),Y
1680RTS
1690.pixad
1700DEX
1710BMI end
1720LDA&70
1730CLC
1740ADC#&B0
1750STA&70
1760LDA&71
1770ADC#2
1780STA&71
1790LDA&BD
1800SEC
1810SBC&12EF
1820STA&BD
1830JMP pi ad
1840.end
1850RTS
1860.display
1870LDA#0
1880STA&B1
1890LDA#&30
    
```



1900STA&B3  
1910LDA&71  
1920ASLA  
1930RDL&B1  
1940ASLA  
1950RDL&B1  
1960ASLA  
1970RDL&B1  
1980STA&B2  
1990LDA&B1  
2000CLC  
2010ADC&B3  
2020STA&B3  
2030LDA&72  
2040AND#7  
2050FOR&72  
2060LSRA  
2070STA&B1  
2080LSRA  
2090LSRA  
2100ADC&B1  
2110LSRA  
2120STA&B1  
2130LDA#0  
2140RORA  
2150CLC  
2160ADC&B2  
2170STA&B0  
2180LDA&B1  
2190AND#B4  
2200STA&B1  
2210LDA&B0  
2220CLC  
2230ADC&B0  
2240STA&B2  
2250LDA#2  
2260ADC&B1  
2270STA&B3  
2280LDA&B0  
2290CLC  
2300ADC&B2  
2310STA&B4  
2320LDA#2  
2330ADC&B3  
2340STA&B5  
2350LDA&B0  
2360CLC  
2370ADC&B4  
2380STA&B5  
2390LDA#1  
2400ADC&B5  
2410STA&B7  
2420LDA&70  
2430PLA  
2440TAY  
2450LDA&120  
2460CLC  
2470ADC#6  
2480LDY#0  
2490STA&B0,X  
2500CLC  
2510.loop1  
2520ADC&12EF  
2530INX  
2540INX  
2550CPX#B  
2560BCS over  
2570STA&B8,X  
2580BCC loop2  
2590.over  
2600CLC  
2610JNY  
2620LDA&12F0,Y  
2630LDY#0  
2640.loop3

2650STA&B9,X  
2660INX  
2670INX  
2680CPX#B  
2690BCC loop3  
2700LDY&12EF  
2705\ draws character  
2710.mainloop  
2720TYA  
2730BEQ out  
2740DEY  
2750LDA(&B8),Y  
2760BEQ block2  
2770STA(&B0),Y  
2780.block2  
2790LDA(&B8),Y  
2800BEQ block3  
2810STA(&B2),Y  
2820.block3  
2830LDA(&B0),Y  
2840BEQ loopand  
2850STA(&B4),Y  
2860.loopand  
2870JMP mainloop  
2880.out  
2890RTS  
2900.lhand  
2910LDA&B0  
2920AND#&AA  
2930LDX#3  
2940.loop4  
2950ROLA  
2960RDL&B1  
2970ROLA  
2980DEX  
2990BPL loop4  
3000RTS  
3010.Rhand  
3020LDA&B0  
3030AND#&B5  
3040LDX#3  
3050.loop5  
3060ROLA  
3070ROLA  
3080RDL&B1  
3090DEX  
3100BPL loop5  
3110RTS  
3120.mirror  
3130LDX&B0  
3140.loop6  
3150LDA&B0,X  
3160BEQ zero  
3170AND#&AA  
3180CLC  
3190RORA  
3200STA temp  
3210LDA&B0,X  
3220AND#&B5  
3230ROLA  
3240ADC temp  
3250STA&B0,X  
3260.zero  
3270DEX  
3280BPL loop6  
3290RTS  
3300 temp  
3310NOP  
3320.clone  
3330LDA&94  
3340STA&90  
3350LDA&95  
3360STA&91  
3370LDA&96  
3380STA&92

3390LDA&97  
3400STA&93  
3410JSR shiftR  
3420LDX#2  
3430.loop7  
3440LDA&94  
3450CLC  
3460ADC&12EF  
3470STA&94  
3480STA&90  
3490LDA&96  
3500CLC  
3510ADC&12EF  
3520STA&96  
3530STA&92  
3540JSR shiftR  
3550DEX  
3560BNE loop7  
3570RTS  
3580.shiftR  
3590LDA#8  
3600STA&7F  
3610.newblock  
3620LDA&12EF  
3630SEC  
3640SBC#B  
3650TAY  
3660.samerow  
3670LDA(&90),Y  
3680AND#&AA  
3690LSRA  
3700STA(&92),Y  
3710TYA  
3720SEC  
3730SBC#B  
3740TAY  
3750BMI nextrow  
3760LDA(&90),Y  
3770AND#&B5  
3780ASLA  
3790PHA  
3800TYA  
3810CLC  
3820ADC#B  
3830TAY  
3840PLA  
3850CLC  
3860ADC(&92),Y  
3870STA(&92),Y  
3880TYA  
3890SEC  
3900SBC#B  
3910TAY  
3920BPL.samerow  
3930.nextrow  
3940INC&90  
3950INC&92  
3960DEC&7F  
3970BNE.newblock  
3980RTS  
3990J  
4000NEXT  
4010ENDPROC



See 'Follow the Floating Point', page 74

● Program 1. Copies the contents of FAC1 into memory, allowing them to be examined

```

10 REM Memory to FAC1 Demo
20 REM Bruce Smith
30 REM For the BBC Micro
40 REM (c) Acorn User November 1984
50 :
60 FOR pass=0 TO 2 STEP 2
70 fac1=%2E
80 base=%70
90 P%=%C00
100 IOPT pass
110 .memfac1
120 LDA %70 \ get lo.byte fp addr
130 STA %4B \ save in fp vector
140 LDA %71 \ get hi.byte fp addr
150 STA %4C \ save in fp vector
160 JSR %A3B5 \ expand fp into FAC1
170 LDX %7 \ set up loop count
180 .loop
190 LDA fac1,X \ get byte from FAC1
200 STA base,X \ save in zero page
210 DEX \ decrement loop count
220 BPL loop \ repeat until minus
230 RTS
240 ]
250 NEXT
260 :
270 !%70=%4000
280 REM *** FP %345 ***
290 ?%4000=%8A: ?%4001=%D1
300 ?%4002=%40: !%4003=0
310 :
320 CALL memfac1
330 FOR loop=0 TO 7
340 READ byte#
350 PRINT byte#; ~base?loop
360 NEXT
370 :
380 DATA "SIGN :","OVERFLOW :","
EXPONENT : "
390 DATA "MANTISSA1 :","MANTISSA2 :","
MANTISSA3 : "
400 DATA "MANTISSA4 :","ROUNDING : "
    
```

```

>RUN
SIGN :D1
OVERFLOW :0
EXPONENT :8A
MANTISSA1 :D1
MANTISSA2 :40
MANTISSA3 :0
MANTISSA4 :0
ROUNDING :0
    
```

● Result of running program 1, showing storage of %345 within FAC1

```

>RUN
4020 84
4021 10
4022 0
4023 0
4024 0
    
```

● Result of running program 2. Referring to table 2, you can see that the result of addition is 9.00

```

>RUN
4020 83
4021 20
4022 0
4023 0
4024 0
    
```

● Result of running program 3. Referring to table 2, you can see the result of subtraction is 5.00

● Program 2. Illustrates how floating point addition can be used, using Basic ROM calls, here adding 1.00 to 8.00

```

10 REM Floating Point Addition
20 REM Bruce Smith
30 REM For the BBC Micro
40 REM (C) Acorn User November 1984
50 :
60 P%=%C00
70 IOPT 2
80 .floatadd
90 LDA %70 \ get lo.addr fp1
100 STA %4B \ save in fp vector
110 LDA %71 \ get hi.addr fp1
120 STA %4C \ save in fp vector
130 JSR %A3B5 \ transfer to FAC1
140 LDA %72 \ get lo.addr fp2
150 STA %4B \ save in fp vector
160 LDA %73 \ get hi.addr fp2
170 STA %4C \ save in fp vector
180 JSR %A500 \ fp addition routine
190 LDA %74 \ get lo.addr fp result
200 STA %4B \ save in fp vector
210 LDA %75 \ get hi addr fp result
220 STA %4C \ save in fp vector
230 JMP %A3BD \ move FAC1 into fp res
ult
240 ]
250 :
260 !%70=%4000
270 !%72=%4010
280 !%74=%4020
290 :
300 REM ** SET UP FP 1.00 **
310 ?%4000=%8B1: !%4001=0
320 REM ** SET UP FP 8.00 **
330 ?%4010=%8B4: !%4011=0
340 REM ** CLEAR RESULT AREA **
350 ?%4020=0: !%4021=0
360 :
370 CALL floatadd
380 FOR N=%4020 TO %4024
390 PRINT~N; " "; ~?N
400 NEXT
    
```

● Program 3. Illustrates how floating point subtraction can be used, using Basic RDM calls, here subtracting 2.00 from 7.00

```

10 REM Floating Point Subtraction
20 REM Bruce Smith
30 REM For the BBC Micro
40 REM (C) Acorn User November 1984
50 :
60 P%=%C00
70 IOPT 2
80 .floatsub
90 LDA %70 \ get lo.addr fp1
100 STA %4B \ save in fp vector
110 LDA %71 \ get hi.addr fp1
120 STA %4C \ save in fp vector
130 JSR %A3B5 \ transfer to FAC1
140 LDA %72 \ get lo.addr fp2
150 STA %4B \ save in fp vector
160 LDA %73 \ get hi.addr fp2
170 STA %4C \ save in fp vector
180 JSR %A4FD \ fp subtraction
190 LDA %74 \ get lo.addr fp result
200 STA %4B \ save in fp vector
    
```

Continued ▶



◀Continued

```

210 LDA &75      \ get hi addr fp result
220 STA &4C      \ save in fp vector
230 JMP &A3BD   \ move FAC1 into fp res
ult
240 J
250 :
260 !&70=&4000
270 !&72=&4010
280 !&74=&4020
290 :
300 REM ** SET UP FP 2.00 **
310 ?&4000=&B2: !&4001=0
320 REM ** SET UP FP 7.00 **
330 ?&4010=&B3: ?&4011=&60: !&4012=0
340 REM ** CLEAR RESULT AREA **
350 ?&4020=0: !&4021=0
360 :
370 CALL floatsub
380 FOR N=&4020 TO &4024
390 PRINT~N; " "; ~?N
400 NEXT
    
```

Program 4. How floating point multiplication can be used, using Basic ROM calls, here multiplying 3.00 by 2.00

```

>
10 REM Floating Point Multiplication
20 REM Bruce Smith
30 REM For the BBC Micro
40 REM (C) Acorn User November 1984
50 :
60 P%=&C00
70 [OPT 2
80 .floatmult
90 LDA &70      \ get lo.addr fp1
100 STA &4B     \ save in fp vector
110 LDA &71     \ get hi.addr fp1
120 STA &4C     \ save in fp vector
130 JSR &A3B5   \ transfer to FAC1
140 LDA &72     \ get lo.addr fp2
150 STA &4B     \ save in fp vector
160 LDA &73     \ get hi.addr fp2
170 STA &4C     \ save in fp vector
180 JSR &A656   \ fp multiplication
190 LDA &74     \ get lo.addr fp result
200 STA &4B     \ save in fp vector
210 LDA &75     \ get hi addr fp result
220 STA &4C     \ save in fp vector
230 JMP &A3BD   \ move FAC1 into fp res
ult
240 J
250 :
260 !&70=&4000
270 !&72=&4010
280 !&74=&4020
290 :
300 REM ** SET UP FP 2.00 **
310 ?&4000=&B2: !&4001=0
320 REM ** SET UP FP 3.00 **
330 ?&4010=&B2: ?&4011=&40: !&4012=0
340 REM ** CLEAR RESULT AREA **
350 ?&4020=0: !&4021=0
360 :
370 CALL floatmult
380 FOR N=&4020 TO &4024
390 PRINT~N; " "; ~?N
400 NEXT
    
```

Program 5. How floating point division can be used, using Basic ROM calls, here dividing 3.00 by 2.00

```

>
10 REM Floating Point Division
20 REM Bruce Smith
30 REM For the BBC Micro
40 REM (c) Acorn User November 1984
50 P%=&C00
60 [OPT 2
70 .floatdiv
80 LDA &70      \ get lo.addr fp1
90 STA &4B     \ save in fp vector
100 LDA &71     \ get hi.addr fp1
110 STA &4C     \ save in fp vector
120 JSR &A3B5   \ transfer to FAC1
130 LDA &72     \ get lo.addr fp2
140 STA &4B     \ save in fp vector
150 LDA &73     \ get hi.addr fp2
160 STA &4C     \ save in fp vector
170 JSR &A6AD   \ fp division
180 LDA &74     \ get lo.addr fp result
190 STA &4B     \ save in fp vector
200 LDA &75     \ get hi..addr fp resul
t
210 STA &4C     \ save in fp vector
220 JMP &A3BD   \ move FAC1 to fp resul
t
230 J
240 :
250 !&70=&4000
260 !&72=&4010
270 !&74=&4020
280 :
290 REM ** SET UP FP 2.00 **
300 ?&4000=&B2: !&4001=0
310 REM ** SET UP FP 3.00 **
320 ?&4010=&B2: ?&4011=40: !&4012=0
330 REM ** CLEAR RESULT AREA **
340 ?&4020=0: !&4021=0
350 :
360 CALL floatdiv
370 FOR N=&4020 TO &4024
380 PRINT~N; " "; ~?N
390 NEXT
    
```

109

```

>RUN
      4020  B1
      4021  2B
      4022  0
      4023  0
      4024  0
    
```

Result of running program 5. Here the answer is 1.5—we leave you to transform the representation back into binary

```

>RUN
      4020  B3
      4021  40
      4022  0
      4023  0
      4024  0
    
```

Result of running program 4. Table 2 indicates that the result is 6.00

See page 113

110

```

10 REM ** SET MARGIN DN EPSDN/STAR
20 DSWRCH=&FFEE
30 WRCHV=&20E
40 vector=256*?(WRCHV+1)+?WRCHV
50 margin=7 : WIDTH(79-margin)
60 FOR PASS=0 TO 3 STEP 3
70 P%=&70
80 LDPT PASS
90 .START
100 LDA #test MOD 256
110 STA WRCHV
120 LDA #test DIV 256
130 STA WRCHV+1
140 RTS
150 .test
160 CMP #13
170 BNE exit
180 JSR exit
190 LDA #&20
200 LDX #margin-1
210 .times
220 JSR DSWRCH
230 DEX
240 BNE times
250 .exit
260 JMP vector
270 J
280 NEXT PASS
290 CALL START
    
```

Listing 1. David Prideaux's routine for indented listings

```

10 FOR A%=0 TO 2 STEP 2
20 P%=&900
30 LDPT A%
40 BCC over
50 LDA #138 : LDX #0
60 .LDDP
70 LDY data.X : CPX #&FF : BED over
80 INX : STX &70 : LDX #0
90 JSR &FFF4 : LDX &70
100 BNE LDDP
110 .over
120 RTS
130 .data
140 EDUS "OLD"+CHR#13
150 EDUS "RUN"+CHR#13
160 EDUS &FF
170 J: NEXT A%
180 !&287=&9004C
    
```

Listing 2. Routine by S Danesh to program the Break key permanently as a function key (OS 1.2)

```

10 REM"8.ALTREPL" Program to replace
dual
20 REM"catalogue utility for discs
30 REM"Acorn User Dc83:47. amendments
D83:157
40 REM"COPYR1GHT 1983 N. Pendleton
50 REM"Syntax: *ALT <drv> Mod by MF
P 14Je84
60 :
70 DIM X% 10
80 inst=&0C0D
90 dv = &10CB
100 buf1=&09
110 buf2=&0E
120 osargs=&FFDA
130 osword=&FFF1
140 REPEAT
150 REPEAT
160 INPUT??? "Which drive? "drv
170 UNTIL drv<4 AND drv>-1
180 $X%="DRIVE"+STR$(drv)
190 Y%=X% DIV 256
200 CALL &FFF7 : REM oscli
210 *CAT
220 REPEAT
230 INPUT? "Proceed? "y$
240 UNTIL y$="Y" OR y$="N"
250 IF y$="N" THEN 150
260 ?inst=drv
270 FOR pass=0 TO 2 STEP 2
280 P%=&0C00
290 PRDCalt
300 NEXT pass
310 *ACCESS ALT
320 *SA. ALT 0C00 0CFF
330 *ACCESS ALT L
340 UNTIL FALSE
350 END
360 :
370 DEF PRDCalt
380 LDPT pass
390 LDA dv: \ Preserve current drive n
o.
400 PHA
410 LDA #1: \ Collect drive number fro
m typed command
420 LDX #&70: LDY #0: JSR osargs
430 .loop
440 LDA (&70),Y: \ Check for end of co
mmand
450 CMP #&D: BED params
460 CMP #&34: BPL inc: \ Check for num
eral 0 to 3
470 CMP #&30: BM1 inc
480 AND #3: STA inst
490 .inc
500 INY: BNE loop
510 .params
520 LDA #0
530 STA inst+1: STA inst+2
540 STA inst+3: STA inst+4
550 LDA #3: STA inst+5
560 LDA #&22: STA inst+9
570 LDA #buf1: STA inst+2
580 LDA #0: STA inst+7
590 STA inst+8
600 LDA #&53: STA inst+6
610 LDA #&7F: LDX #inst MOD 256
620 LDY #inst DIV 256: JSR osword
630 LDA #buf2: STA inst+2
640 LDA #2: STA inst+8
650 LDA #&7F: LDX #inst MOD 256
660 LDY #inst DIV 256: JSR osword
670 LDA #buf1: STA inst+2
680 LDA #&48: STA inst+6
690 LDA #&7F: LDX #inst MOD 256
700 LDY #inst DIV 256: JSR osword
710 LDA #buf2: STA inst+2
720 LDA #0: STA inst+8
730 LDA #&7F: LDX #inst MOD 256
740 LDY #inst DIV 256: JSR osword
750 PLA: STA dv: \ Recover original dr
ive
760 RTS: J
770 ENDPRDC
    
```

Listing 3. M F Park's modification to Nigel Pendleton's dual catalogue program, allowing you to specify which drive you want the \*ALT command to affect



See 'ROM-con Trick', page 119



David Blakey's 'ROM-con' program allows you to select and access any ROM, even when you've got a full load of ROMs on-board

```

10 REM*****
20 REM* Sideways ROM selector *
30 REM* for BBC micro *
40 REM* (c) Acorn User Nov 84 *
50 REM* by D Blakey *
60 REM*****
100 MODE 7
110 PROCinit
120 PROCheader
130 PROCassemble
140 PROCfind_basic
150 PRINT
160 PROCget_data
170 PROCread_rom_table
180 REPEAT
190 PROCwrite_screen
200 PRINT TAB(4);"Toggle state of ROM
No. ";STRING$(80," ");CHR#11;CHR#11;:INP
UT reply#
210 PROCedit
220 UNTIL reply#="E" OR reply#="e"
230 PROCupdate_rom_table
240 PRINT TAB(4);CHR#11;"Press B' for
protect, else any key "
250 A#=GET#
260 IF A#="B" OR A#="b" THEN PROCset_u
p_break
270 END
1000 :
1010 DEF PROCassemble
1020 FOR PASS=0 TO 2 STEP 2
1030 P%=code
1040 [OPT PASS
1050, start
1060 STA rom address
1070 LDA #&80
1080 STA &71
1090 LDA #0
1100 STA &70
1110 LDY #7
1120 LDA (&70),Y
1130 STA &70
1140 LDY #2
1150 LDA (&70),Y
1160 LDY #8
1170 CMP #ASC"C"
1180 BNE no_rom
1190, loop
1200 INY
1210 LDA rom,Y
1220 BEQ found_end_word
1230 STA string,Y
1240 JMP loop
1250, found_end_word
1260 LDA #&0D
1270 STA string,Y
1280 LDA rom+6
1290, end
1300 STX rom_address
1310 RTS
1320, no_rom
1330 INY
1340 LDA #&0D
1350 STA string,Y
1360 LDA #0
1370 JMP end
1380 I
1390 P%=&A00 :REM P%=&D00 FOR TAPE
1400 [OPT PASS
1410, break_handler
1420 LDY #16
1430, more_data
1440 DEY
1450 LDA data,Y
1460 STA &2A1,Y
1470 TYA
1480 BNE more_data
1490 RTS
1500, data
1510 J
1520 NEXT
1530 ENDPROC
1540 :
1550 DEF PROCfind_basic
1560 A%=252: X%=0: Y%=&FF
1570 X%=(USR(osbyte) AND &FF00)DIV 256
1580 ENDPROC
1590 :
1600 DEF PROCinit
1610 DIM title$(16),select$(16)
1620 DIM type%(16),control%(16)
1630 DIM code 255

```

111

Continued ►

See 'ROM-con Trick', page 119

112

◀ Continued

```

1640 rom_numbers=4:REM TOTAL no. ROMs
1650 rom_address=&FE30
1660 rom=&8000
1670 string=&0900
1680 osbyte=&FFF4
1690 *FX 247
1700 ENDPROC
1710 :
1720 DEF PROCget_data
1730 FOR AX=(16-rom_numbers) TO 15
1740 type%(AX)=(USR(start) AND &FF)
1750 title%(AX)=$(string+9)
1760 NEXT
1770 ENDPROC
1780 :
1790 DEF PROCwrite_screen
1800 PRINT TAB(0,4);CHR#131;CHR#157;CHR
#129;
1810 PRINT TAB(3);"No. ";TAB(8);"Title";
TAB(23);"State";TAB(33);"Type"
1820 FOR IX=0 TO 15
1830 PRINT TAB(3);IX;TAB(8);title%(IX);
TAB(23);select%(IX);TAB(33);~type%(IX)
1840 NEXT
1850 PRINT CHR#131;CHR#157;CHR#129;
1860 ENDPROC
1870 :
1880 DEF PROCread_rom_table
1890 FOR IX=0 TO 15
1900 control%(IX)=IX?&2A1
1910 IF control%(IX)=type%(IX) AND type
%(IX)<>0 THEN select%(IX)="ON " ELSE sel
ect%(IX)="OFF"
1920 NEXT
1930 ENDPROC
1940 :
1950 DEF PROCheader
1960 FOR IX=0 TO 3
1970 PRINT TAB(0,IX);CHR#129;CHR#157;CH
R#131
1980 NEXT
1990 PRINT TAB(9,0);CHR#141;"SIDEWAYS R
OM CONTROL"
2000 PRINT TAB(9,1);CHR#141;"SIDEWAYS R
OM CONTROL"
2010 PRINT TAB(11,2)"(c) Acorn User 198
4 - by David Blakey
2020 PRINT TAB(3,3)"Enter 'E' to exit"
2030 ENDPROC
2040 :
2050 DEF PROCedit
2060 W%=VAL(reply#)
2070 IF W%>16 THEN ENDPROC
2080 IF (W%=0 AND ASC(reply#)<>48) OR t
itle%(W%)="" THEN ENDPROC
2090 IF control%(W%)=0 THEN control%(W
)=type%(W%):select%(W%)="ON " ELSE contr
ol%(W%)=0:select%(W%)="OFF"
2100 ENDPROC
2110 :
2120 DEF PROCupdate_rom_table
2130 FOR IX=0 TO 15
2140 IX?&2A1=control%(IX)
2150 IX?data=control%(IX)
2160 NEXT
2170 ENDPROC
2180 :
2190 DEF PROCset_up_break
2200 AX=249:Y%=0:X%=break_handler DIV 2
56:CALL osbyte
2210 *FX248,0
2220 *FX247,76
2230 ENDPROC

```







Bruce Smith presents a bundle of useful tips: a sprite definer look-up table, a word processing aid and other bright Beeb ideas

## Colour chart

for the

## sprite designer

A PORTRAIT of Bill Shakespeare is winging its way to B Gabel of Lewes for his useful multicolour chart (table 1). Mr Gabel writes. . .

Having read and typed in Mr Sinclair's excellent sprite definer (September issue) I drew up the following pixel colour chart. It has been indispensable to me ever since and should be for other programmers.

The colours referred to are the logical colours in mode 2. To see what number to send to the screen byte, look up the colour of the left-hand pixel on the grid's 'Left Pixel' section and the colour of the right-hand pixel on the grid's 'Right Pixel' section. Follow the row and column across and down until they meet. The number in the square is the number you want (in hexadecimal).

For example: for a byte coloured yellow on the left and flashing blue/yellow on the right, the number is &5A. Try it: type

?&5000 = &5A

... Suitable remuneration awaits any would-be statisticians who supply useful charts such as this!

## Auto-numbering

in View

USEFUL advice on how to write programs without line numbers using *View* or *Wordwise* comes from J C Clarke of Nettleton. Mr Clarke explains that you simply type in your program without line numbers and when you have finished inset a line at the beginning of the file that contains AUTO. Now save the file to disc. To get the program into its proper form simply \*EXEC the file into Basic memory. When AUTO, the first line on the file, is executed it will add a line number to each line that is loaded in from disc.

Thanks to Mr Clarke for pointing this out.

I often use a similar method for converting machine code back into assembler form. First I set up a \*SPOOL file and then disassemble the section of code to be converted - this is spooled to disc. Once the file has been closed, by using \*SPOOL again, it can be loaded into *Wordwise* or *View*, where AUTO can be added to the top of the file which can be re-saved. Now simply \*EXEC the file to obtain your assembler program, ready for editing!

Mr Clarke also points out that the function keys can be programmed as

normal in *View* by first executing \*FX228,1. Key definitions are entered as normal and then accessed using the Shift/CTRL key combination.

## Indenting

the printout

HERE's a useful printer utility for the Epson/Star range. It comes from David Prideaux of Plymouth, who writes. . .

An irritating failing of the Epson MX range of printers is the lack of a facility to define the left margin. It is possible

		RIGHT PIXEL															
COLOUR		Black	Red	Green	Yellow	Blue	Magenta	Cyan	White	Black/White	Red/Cyan	Green/Magenta	Yellow/Blue	Blue/Yellow	Magenta/Green	Cyan/Red	White/Black
LEFT PIXEL	Black	00	01	04	05	10	11	14	15	40	41	44	45	50	51	54	54
	Red	02	03	06	07	12	13	16	17	42	43	46	47	52	53	56	57
	Green	08	09	0C	0D	18	19	1C	1D	48	49	4C	4D	58	59	5C	5D
	Yellow	0A	0B	0E	0F	1A	1B	1E	1F	4A	4B	4E	4F	5A	5B	5E	5F
	Blue	20	21	24	25	30	31	34	35	60	61	64	65	70	71	74	75
	Magenta	22	23	26	27	32	33	36	37	62	63	66	67	72	73	76	77
	Cyan	28	29	2C	2D	38	39	3C	3D	68	69	6C	6D	78	79	7C	7D
	White	2A	2B	2E	2F	3A	3B	3E	3F	6A	6B	6E	6F	7A	7B	7E	7F
	Black/White	80	81	84	85	90	91	94	95	C0	C1	C4	C5	D0	D1	D4	D5
	Red/Cyan	82	83	86	87	92	93	96	97	C2	C3	C6	C7	D2	D3	D6	D7
Green/Magenta	88	89	8C	8D	98	99	9C	9D	C8	C9	CC	CD	D8	D9	DC	DD	
Yellow/Blue	8A	8B	8E	8F	9A	9B	9E	9F	CA	CB	CE	CF	DA	DB	DE	DF	
Blue/Yellow	A0	A1	A4	A5	B0	B1	B4	B5	E0	E1	E4	E5	F0	F1	F4	F5	
Magenta/Green	A2	A3	A6	A7	B2	B3	B6	B7	E2	E3	E6	E7	F2	F3	F6	F7	
Cyan/Red	A8	A9	AC	AD	B8	B9	BC	BD	E8	E9	EC	ED	F8	F9	FC	FD	
White/Black	AA	AB	AE	AF	BA	BB	BE	BF	EA	EB	EE	EF	FA	FB	FE	FF	

Table 1. Mode 2 pixel/byte colour chart for the Electron and BBC micro

Beeb Forum is a platform for ideas, tips and applications relating to the BBC micro and the Electron, intended for experienced programmers to share their thoughts. For every reader's tip published we pay £5 - or more for something special. Contributions should be typed or printed, with substantial listings on cassette. WRITE TO Beeb Forum, Acorn User, Redwood Publishing, London WC2E 9JH.

# CommuniTel

announces its complete local and wide area Viewdata communications system for the BBC micro.

The first system to unlock the full power of the BBC micro, it turns the BBC into THE Viewdata/communications machine.

Become your own 'micro-PRETEL'.

Log on to any other Viewdata system.

Create your own Viewdata bases & telesoftware. Let others access them over the phone.

Explore the new world of electronic publishing & information services.

- \* By far the most comprehensive and easy to use Viewdata system for the BBC micro.
- \* Track tested since Nov. 83 in the national ITeC program.
- \* Subset to be bundled by Acorn with their new Winchester file server.
- \* Adapts itself to Disc or Econet Level II.
- \* Up to 195 frames on a disc.
- \* Multiple databases can be used simultaneously on a network.
- \* Special Education licence (Single school, multi-machine, multi-site licence).

The complete package includes SOFTWARE, MANUALS, LEADS and MODEM.

Nothing further required beyond the BBC micro and the new 600 series B.T. phone socket.

## THE SOFTWARE

- \* **SYSTEM MENU** simple cursor driven selection used throughout, with powerful configuration facilities. Auto-booting.
- \* **OFFLINE EDITOR** one of the best viewdata editors available for ANY machine, combining exceptional facilities with ease of use, enabling complete Viewdata bases to be created on disk or network
- \* **SEARCH** this enables a Viewdata base to be searched locally in exactly the same way as when on-line to PRETEL.
- \* **CAROUSEL** for exhibition and public display, frames can be left automatically displaying in a cycle.
- \* **FRAME PRINTER** hard copy of frames, supporting parallel, serial or network printers, with graphics supported on Integrex colour inkjet, Epson FX80 & MX100 type III, Microline 80/82, Silver Reed EX43, and text on any other ASCII printer.
- \* **TERMINAL** can log onto any other Viewdata system, single key auto-dialling, download frames to a local database, telesoftware downloading, full on-line editing, frame-load and send.
- \* **HOST** enables a locally created Viewdata base to be accessed by any standard Viewdata over the phone. Also provides an on-line editor so that callers can enter messages or complete frames, saved in a private "in-tray".
- \* **TELESOFTWARE FORMATTER** any file, text or data, as well as programs, can be turned into C.E.T. telesoftware frames and made available to callers via the HOST, providing machine independent secure file transfer through the C.E.T. standard.

## REQUIREMENTS

BBC micro B. OS 1.0+, DFS 0.9+ &/or Econet level 2 / NFS 3,34+. Also B.T. 600 series phone socket.

## PRICES

FULL SYSTEM as outlined above.  
£325.00 + VAT + pp

LOCAL MODE OFF-LINE SYSTEM (No communications).  
Software: MENU, EDITOR, SEARCH, CAROUSEL, FRAME PRINTER, + full documentation, all as outlined above, working on disk or Econet level 2  
£45.00 + VAT + pp.

## HARDWARE

INTELLIGENT AUTO-ANSWER / AUTO-DIAL MODEM the first of the new generation of intelligent modems, it is far in advance of anything else in the field.

- \* No buttons or knobs to set — it sets itself — and no understanding of bits and bauds needed.
- \* Auto-dial software driven — needs no telephone handset, making phone costs controllable.
- \* Auto-answer — handles incoming calls unattended.
- \* **When calling another CommuniTel system in HOST mode, unique speed switching enables frames to be sent at high speed, creating a fast electronic mail system with dramatic phone cost savings.**
- \* Robust, steel cased.
- \* BAPT approved (No. S/1397/3/E/450348) — legal to use on public B.T. phone lines.
- \* All leads provided — just plug in and it's ready to go.

## DOCUMENTATION

- \* **TUTORIAL MANUAL** an excellent self-teach tutorial manual is provided. This is properly type-set in large type and heavily illustrated with colour photographs. Further copies of this are available separately. This covers every part of the system.
- \* **REFERENCE MANUAL** a comprehensive reference manual covers the remaining aspects of the system.

## SCHOOLS

Hatfield Advisory Unit for Computer Based Education have negotiated a special 'schools deal' and are selling the Local mode off-line system + the TERMINAL software + a book on Educational uses of Viewdata + sample database disk, under the extended schools licence for the same price: £45.00 + VAT. Enquiries to Hatfield AUCBE.

## FURTHER INFORMATION

For further information and order form write to:  
CommuniTel Ltd.  
189 Freston Road,  
London W10 6TH.



when running under program control to format the output as desired, and obviously a wordprocessor program normally includes such a feature, but what I am referring to is the ability simply to produce a listing of a program, for example, indented by an amount so that when inserted in a binder the print may still be read.

The short routine attached (listing 1) is my answer to the problem. It works by intercepting the OSWRCH vector to scan the output stream looking for the <RETURN> character - which occurs at the end of every line or when the WIDTH limit is reached. After the <RETURN> the routine inserts a number of spaces up to the specified margin width and then carries on printing until the next <RETURN>, when it repeats the process.

As written, the routine should work on any OS since, although the return address (vector) depends on the OS version, it is read from WRCHV, which is common to all versions. The code has to be located out of the way of the Basic program: I have found no problems with it in zero page at &0070, which is provided as user workspace.

## £5 Save memory space on disc

EVEN with a dual catalogue utility the number of files that can be stored on a disc can be limiting, especially on a games disc where many small files are sometimes used purely to CHAIN another larger file. S Danesh of Southampton has found an efficient way around this problem. I'll let him explain...

One of the main disadvantages of the Acorn DFS is the limitation of allowing only a maximum of 31 files per disc. This can mean large amounts of disc memory being wasted simply because the disc catalogue has become full.

This problem is magnified when programs are in several parts. One method of relieving this problem is to merge parts of a program together. To do this, the reason why several parts are needed has to be understood.

Machine code programs transferred from tape are usually in three parts. The first simply sets 'PAGE' to a high value and then CHAINS the second part. This then \*LOADs the main machine code program and downloads it to its correct position in memory.

At first sight, the first program may seem unnecessary since all it does is to change the value of PAGE. But this is essential since PAGE determines where the next program will be loaded in memory. If this value is too low then

the third program will simply overwrite the second one and the program will not work.

If there was a way to achieve this end without the need for an extra file, more programs could be stored on a disc.

This is achieved by CHAINING the downloader (ie, the second program) at the default PAGE setting (ie &1900). Now, if the program were to \*LOAD the machine code program, it would be overwritten. So the first thing the routine does is to copy itself higher up in the memory and then to proceed normally. This is done by adding lines 10 to 40 of the following program to the downloader:

```
10 FOR A% = PAGE TO TOP STEP 4
20 A%!&4000 = !A%
30 NEXT A%
40 PAGE = PAGE + &4000 : GOTO 50
50 *LOAD XXXX
60 PROCdownload
```

Lines 10 to 30 create a copy of the program &4000 bytes higher up in memory and line 40 transfers program execution to the new location.

Line 50 loads the machine code program called XXXX and line 60 calls the procedure, which downloads the program in the normal way.

## £5 Programming the Break key

MR DANESH also provides a useful routine that allows the Break key to be programmed permanently as a function key by writing to the Break intercept vector. Again, Mr Danesh can best explain...

One of the most common uses of the Break function key is to program it to OLD and then to RUN by treating it as function key 10 (page 143, *User Guide*):

```
*KEY 10 OLD | M RUN | M
```

The drawback with this method is that it is by-passed if the CTRL key is pressed simultaneously with the Break key, since this causes a hard reset.

However, users with the 1.2 MOS can treat the Break as a function key even after a hard break by typing in the program in listing 2.

When Break is pressed, the OS checks memory location &287 to see if it contains the value &4C. If it does, then it jumps to the address held in memory locations &288 and &289. Thus a routine can be written that puts the necessary characters into the keyboard buffer.

Line 40 is necessary because the OS

calls this routine twice, once with carry clear and once with carry set. But we want the routine to be executed once only, so if carry is clear the routine is not carried out.

Line 50 initialises the accumulator and the x register for a sequence of OSBYTE calls to insert the necessary characters into the keyboard buffer.

The data lines contain the characters to be inserted. These can be anything the user wants, as long as it ends with the end of data marker '&FF'.

Note that the commands 'EQUUS' and 'EOUB' are available only in Basic 2. The equivalent Basic 1 method would be to delete the data lines, and add:

```
180$data = "OLD" + CHR$13
+ "RUN" + CHR$13 + CHR$&FF
```

## £5 Dual catalogue modification

JUDGING by the number of people who brought dual catalogue discs to the Acorn User Clinic at Olympia in August, Nigel Pendleton's dual catalogue utility published in the October 83 *Acorn User* was a hit with disc users. This modification, supplied by M F Park of Hastings, New Zealand, allows you to specify which drive you wish to affect. Mr Park says...

Suppose you are using drive 0 and want to see what is on the alternative catalogue of drive 2. This modification (listing 3) lets you type \*ALT 2, then type \*.2 to see what's there. Typing \*ALT swaps catalogues on the current drive.

The modification works by saving the current drive number (held at address &10CB) on the 6502 stack and calling QSARGS to see whether there's a numeral following the command \*ALT. If not, the preset drive number in the code is used to select the drive on which ALT is to work. This is called a default option.

If there is a numeral from 0 to 3 following the \*ALT command (note that the command must be followed by a space) this is substituted for the default setting in the code to select the drive.

After ALT has done its work, the original drive number is removed from the stack and restored to its original location. I find it useful to assign a function key thus:

```
*KEY 7 *ALT <space>
```

Program n, will allow you to revise your present copy of \*ALT.

See yellow page 110 for programs 1-3

# BEEBUG SOFT



*The Name to watch for  
your serious B.B.C.  
and Electron  
Software*

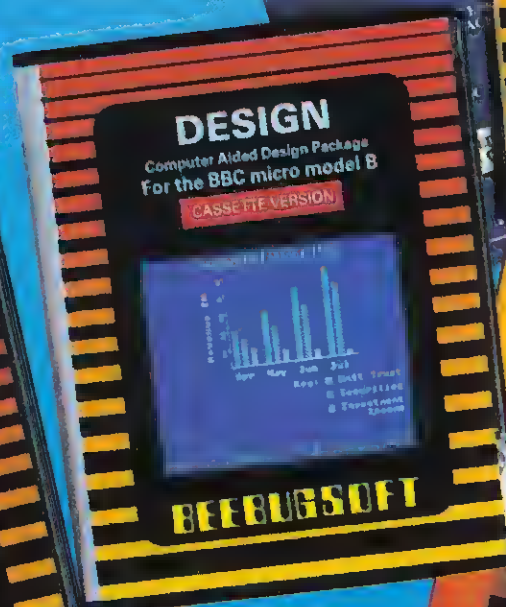

Available from your local dealer and selected branches of W.H. SMITH'S. Telephone us for a full brochure . . .  
St. Albans (0727) 60263.  
BEEBUGSOFT, P.O. Box 50, St. Albans, Herts.





# SERIOUS SOFTWARE

FOR THE B.B.C. MICRO AND ELECTRON

# From BEEBUGSOFT

## MASTERFILE

MASTERFILE is a general purpose data base, written especially for the BBC Micro. It is extremely useful, allowing vast amounts of information to be quickly stored.

Once set up, the information may be retrieved or sorted at any time, in a number of different ways, using any of the fields as keys.

Records may be instantly displayed or printed, using any printer suitable for the BBC Micro, also a label printing facility is included.

Separate versions of the program are available for cassette and disc based systems. The disc version uses random access files to maximise record storage.

One extra feature of the disc version is that it provides limited spreadsheet facilities.



## SPELLCHECK

SPELLCHECK is menu driven, and is the ideal companion for WORDWISE or VIEW. It provides an automatic spelling check for letters or documents.

It is supplied with a dictionary disc already containing 6000 words, which may be increased to a maximum of about

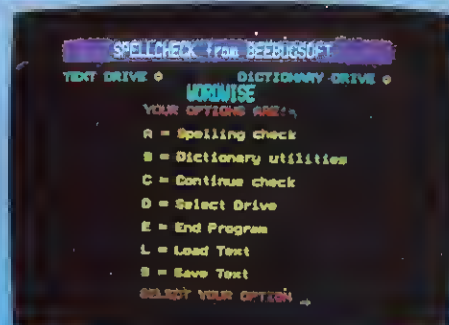

17,000 words on a 100K disc.

Random access files ensure very fast word retrieval from the dictionary disc.

SPELLCHECK is menu driven, and is very simple to use, allowing unknown words to be added to the dictionary, ignored or re-spelt.

Incorrectly spelt words may be instantly respelt and a correct version of the document filed away, ready for printing or later use.

Dictionary discs for foreign languages may easily be created to help check letters sent abroad.

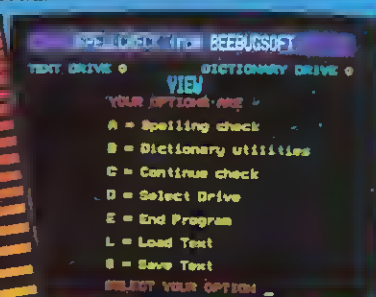
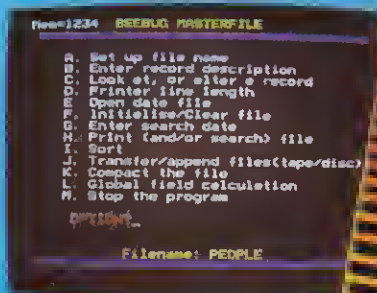

"... Works well and offers an efficient data base..."

PCN NOVEMBER 1984

"... i found the program to be invaluable... fast and reliable... a worthwhile investment."

PCN FEBRUARY 1984

# BEEBUG SOFT

MASTERFILE £19 (DISC) £10 (CASSETTE)

SPELLCHECK £19 (DISC)

AVAILABLE FROM YOUR LOCAL DEALER & SELECTED BRANCHES OF W.H. SMITH Prices include VAT



ACCESS ORDERS & ENQUIRIES: TEL ST. ALBANS (0727) 60263

MAIL ORDER (POST FREE) TO: BEEBUGSOFT, Mailing Dept 13 P.O. Box 109 High Wycombe Bucks



# ROM-CON TRICK

David Blakey's  
program lets  
you juggle 16  
ROMs without  
dropping any



ONE of the most powerful features of the BBC micro is the ability to have software present in ROM chips and be able to juggle up to 16 of them in just one 16k block of memory, from location &8000 to &BFFF. This enables languages, utilities and other software to be available at all times without the need for a storage medium.

The ROMs are called up via the operating system using commands such as \*BCPL, \*BASIC and \*WORDWISE. But as these ROMs can come from different software houses, the commands to call them up can often clash; \*MOVE and \*EDIT, for example, are utilities common to several ROMs. As the OS offers these commands in turn to each ROM until one of them accepts it, a utility in a low-priority ROM position may never be accessed.

The advent of ROM boards enabling up to 16 ROMs to be resident in the machine only makes matters worse. Thus a program that enables these ROMs to be switched off via software offers the user full access to all his or her software. My *ROM-con* utility enables ROMs to be switched off even after a Break or a Control Break.

Location &FE30 of the BBC micro is the control register for ROM selection. Careless writing to this register from Basic will generally result in a crash, as the Basic ROM itself may be deselected. Basic cannot therefore access the paged ROMs by itself; it normally passes commands to the OS to perform this task. Thus in the *ROM-con* program a machine code routine interfaces Basic with the other ROMs.

To enter the routine at 'start', two parameters are passed to it, A% containing the ROM that is to be interrogated and X% the socket number containing Basic. The routine first checks to see if there is a ROM in the socket chosen. It does this by checking for part of the copyright symbol, (C). If this is not present it exits back to Basic returning null data, but if a ROM is present it passes back to Basic the title of the ROM and its ROM type-number.

The OS holds a table of type-numbers for each of the 16 ROM sockets in locations &2A1 to &2B0. A zero indicates that there is no ROM present in that particular socket. What *ROM-con* does is set up its own table in which the value of any socket can be set to zero, thus turning off that particular ROM.

You can now input the ROMs that you require to be deselected. Entering 'E' will exit the program and give you the option of break-protection, which updates the OS ROM table with your edited version whenever Break or Control Break is pressed. If this option is not used, all ROMs will be turned on again when Break is pressed.

The break-protection system uses the \*FX247,76 command to set up a JMP opcode at location &287. Commands \*FX 248 and \*FX 249 pass further data to locations &288 and &289. The opcode at &287 will now read 'JMP break-handler'. Now when the Break key is pressed the OS tests location &287 for a JMP command; if present it executes the opcode, and passes through the user provided routine at &A00. The OS

will pass through this routine twice – the first time the carry bit will be clear, the second time it will be set. The routine at &A00 ignores the carry bit.

The effect of this is to call the routine before and after the OS reads the ROMs. So when a ROM is deselected it is not allowed to reserve memory space for its own use. This is best shown by deselecting your DFS (if you are lucky enough to own one) and pressing Break. PAGE will now be set to &E00 rather than &1900. This is equivalent to taking a screwdriver to your computer and removing the ROM from its socket. To switch any of the ROMs back on, either re-run the utility and reselect the ROM or issue a \*FX247 command and press Break. This removes the break-handler routine and allows the OS to create a new ROM table list.

Basic has a special relationship with the operating system, which explains why the ROM cannot be 'seen' by using the \*HELP command. But it is possible to switch off Basic by editing the ROM out of the system, using the break-protection system and then pressing Control Break. Basic will now be turned off and the next language ROM selected. If no further language ROMs are found the OS responds with the message 'Language?'. Pressing Break will release the situation. Armed with this utility, it is possible to have Basic 1 and Basic 2 as well as several DFSs resident in the machine at the same time.

A word of caution. If any software is allowed to overwrite the break-handler routine at &A00, the machine will probably lock up when Break is pressed. The cure is to move the routine to a new location (ie change line 1390) or issue a \*FX247 command before running the offending software.

The program has been tested in a micro fitted with a 12-ROM socket expansion board, giving 16 ROMs in all, so it should work with any of the current ROM expansion boards. Line 1640 of the program should be altered according to the number of ROM sockets in your system. Immediately after typing in the program save a copy, as any mistakes in entry could cause a system crash. Pay particular attention to the assembly language routines. For test purposes do not use the break-protection system until you have proved that each of the ROMs can be turned off. After running the program, \*HELP will show if you have been successful.

See yellow pages 111-112 for the listing of David Blakey's 'ROM-con' utility

# Draw with the BBC micro and show the true potential of your machine

Fill shapes in one of 23 colours (Mode I)  
 Draw points, lines, rectangles ellipses and circles  
 Smooth curves  
 Wire frame diagrams  
 Hidden line removal  
 Draw in perspective  
 Measure scaled distances  
 Ekta sketch lines, Half tone facility  
 Mirror images  
 Repeat images, SS, enlarged, reduced, stretched  
 Actual colour displayed  
 Store up to 10 ellipses or circles in memory  
 Redraw any one of these at cursor position  
 Change any actual colour for one of 8 others  
 Clear screen, load screen, save screen  
 Print characters or numbers at any pixel point  
 Error messages for incorrect input  
 Fully comprehensive manual

35¢ 496 • □ •••

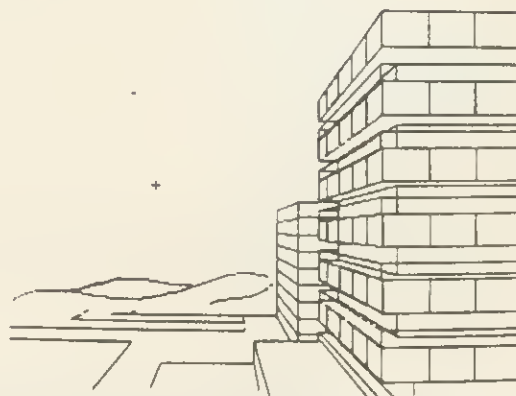

This programme has been purpose designed by professional Graphic Designers for simplicity and ease of use, and is undoubtedly the most versatile drawing programme on the market at this time. There is no need to input any numerical data, as all judgements are made visually. The BBC Micro is the finest drawing machine in its price range. Find out what it can do.

The A. B. Designs drawing programme costs only £36 for over 70 functions (model B). New AB2 Program, available on disc (price £61) and cassette (price £51). When ordering send Cheque/PO and VAT at 15%. Please include phone no. with all correspondence. For further information send SAE and phone no. to A. B. Designs, 81 Sutton Common Road, Sutton, Surrey. 01.644 6643 (closed all day Thursday).

## 3D COMPUTERS

THE HOME COMPUTER  
SPECIALISTS

*Easy parking at all  
branches*

WITH MORE BRANCHES THAN  
ANY OTHER ACORN DEALER  
WE OFFER

### ONE-STOP SHOPPING

FOR YOUR  
**BBC MICRO**  
AND  
**ELECTRON**

SPECIAL ELECTRON PACKAGE INCLUDES  
ELECTRON WITH PLUS 1  
FOR **£229**

#### SOFTWARE

PROGRAM POWER  
BUG-BYTE  
SUPERIOR SOFTWARE  
A & F  
SIMON HESSEL  
MOLIMEX  
ALLIGATA  
ACORNSOFT

#### PERIPHERALS

DISCS SINGLE/DUAL  
TORCH Z80 DISCS  
MIDWICH DISCS  
PRINTERS  
JOYSTICKS  
MONITORS  
B & W/COLOUR  
LIGHT PENS  
BBC BUGGY

*large range of books,  
diskettes, cassettes &  
printer paper always  
in stock*

#### TOLWORTH

230 Tolworth Rise South,  
Tolworth, Surbiton,  
Surrey KT5 9NB.  
Tel: 01-337 4317

#### SUTTON

30 Station Road,  
Belmont, Sutton,  
Surrey SM2 6BS.  
Tel: 01-642 2534

#### EALING

114 Gunnersbury Avenue,  
Ealing, London W5 4HB.  
Tel: 01-992 5855

#### NEWBURY

26, Stanley Road,  
Newbury  
Berks RG14 7PB.  
Tel: (0635) 30047

#### RICKMANSWORTH

Grey Stone Works,  
The Green, Croxley Green,  
Rickmansworth,  
Herts WO3 3AJ.  
Tel: 0923 779250

#### LUTON

1 Manor Road,  
Caddington, Luton,  
Beds LU1 4EE  
Tel: (0582) 458575



## Dashing away with a soldering iron this month as Barry Pickles introduces readers' hardware mods, starting with model trains

### £10 Points, signals and buffers

N J TUBB of Crawley is a hobbyist who combines two enthusiasms neatly. He knew nothing about computing before he bought an Atom kit in 1981, but since then he has 'expanded it to 120k, increased the number of ports, partly rewritten the Atom ROM, expanded the Basic etc to 48k, added a battery back-up power unit...'

He uses the system to run a model railway, and he wanted more ports for the Atom to control the points and signals.

This is how he went about the task...

By using a couple of 74138s, half of a 7402, and all the 8255s I could afford (15), I can control up to 360.

Connect a wire to pin 12 of the 74138. IC23 is the only internal modification

needed - all other connections can be taken from the normal buses. Note that, as shown in figure 1, pin 15 of the top 74138 should not be used, as this address is used by the keyboard. Also, as I wanted only output ports, all the 8255's pins 5 are taken to 5V+, and all pins 36 taken to ground.

If you require general usage of the ports, connect pins 5 and 36 of the 8255s to NRDS and NWDS respectively (through buffers, of course). Also, you will need to cut the connection between pin 4 of IC49 and pin 6 of IC25 and reconnect pin 6 of IC25 to pin 15 of the top 74138 below...

Mr Tubb thought it was about time he threw in his 'two penn'orth'. We can do better than that - here's a tenner, Mr Tubb.

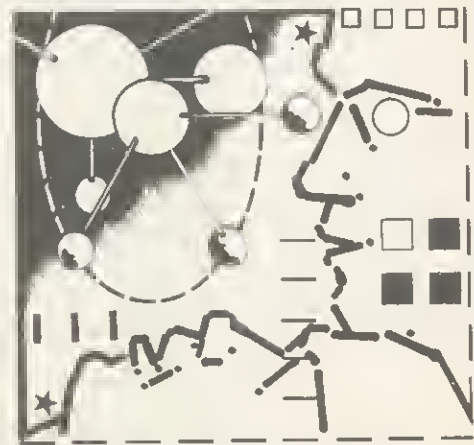

Invented a routine or discovered a hardware modification for the Atom? Here's a chance to show your originality and win some cash. Send your Idea to: Atom Forum, Acorn User, Redwood Publishing, 68 Long Acre, London WC2 9JH.

121

### £5 Auto-reset on power-up

ANOTHER hardware mod this month. It comes from John Alan Ferguson of Chelmsford, who wins £5, and it provides auto-reset on power-up. John writes...

Like many Atom owners I've always been puzzled as to why the machine does not have reset on power up. My machine and others I have seen display only random characters when power is applied and the Break key has to be pressed to obtain the words ACORN ATOM and the prompt.

Looking at the circuit diagram I noticed that there is a capacitor No C11 value 100n between 0 volts and the other side of the Break key. It seems to me that a larger capacitor substituted for this would, due to the delay in charging, pull down the voltage of the CPU reset pin for long enough to reset the machine automatically. After trial and error I found that soldering an electrolytic capacitor valued at 4.7µf in lieu of capacitor C11 gave auto-reset.

To find C11 turn the machine upside-down with the keyboard nearest you and take off the bottom of the machine by unscrewing the two fixing screws. Capacitor C11 is to the left of the break key which is now on the left of the machine. Make sure that the + and - terminals coincide with those marked on the printed circuit board.

It is puzzling that Acorn doesn't seem to have made this minor alteration (I do not accept any responsibility for the alteration as it has not been approved by Acorn). My machine is using about 3 amps. For those machines requiring more or less current different values may be required.

page 123▶

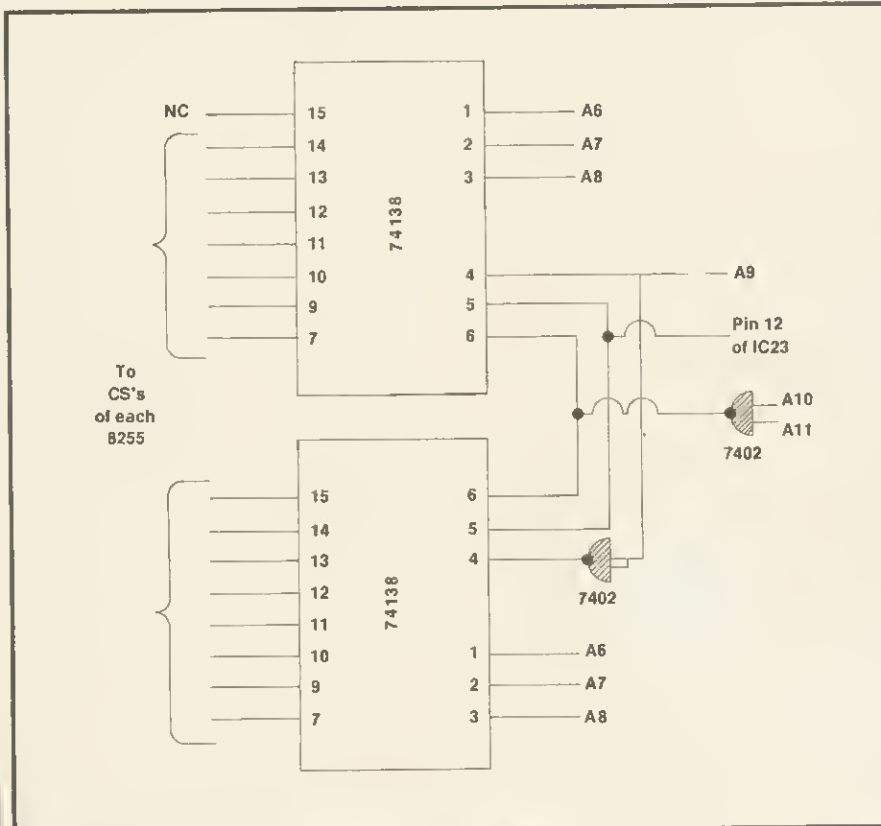
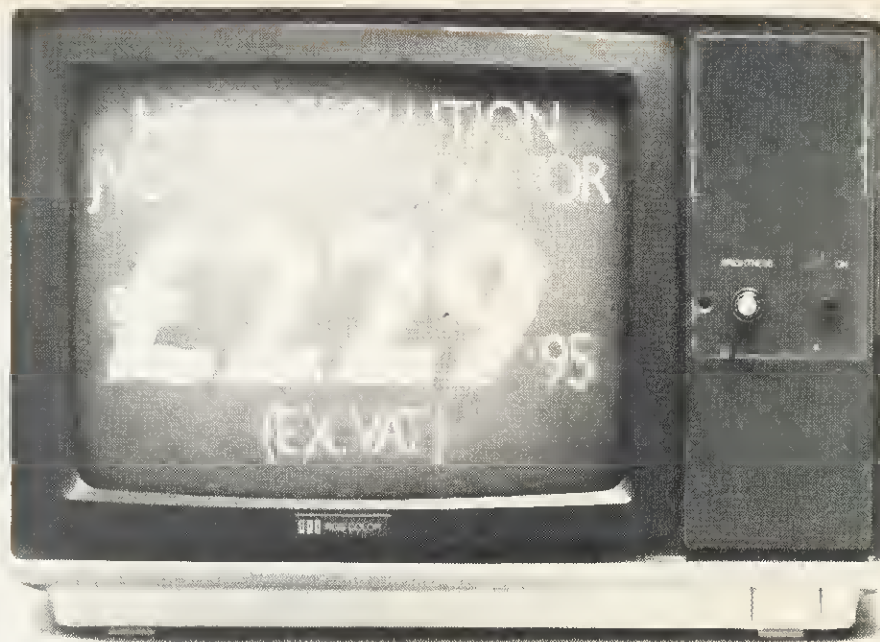

Figure 1. N J Tubb's wiring modifications to increase the number of ports for controlling a model railway system



# HIGH RESOLUTION THAT COMES HIGHLY RECOMMENDED.

**"There is no doubt that the JVC range of ECM colour monitors is excellent value for money . . . there is no loss in quality of picture after long periods . . . and remember, as more and more resolution is available with new micros, the need for a better display will be that much greater."**

High recommendation indeed from Personal Computer News. Meanwhile Acorn User said:

**"It seems that all 'normal' and 'medium' resolution monitors, including the Sanyo, are simply inadequate to deal with the Beeb's graphics and text output . . . The JVC was excellent, giving clear, legible results . . . Was the JVC better than the Microvitec?\* Would I buy one? Yes to both questions."**

Our RGB high resolution colour monitor (580 × 470 pixels) sells for £229.95 (excluding VAT) – that's a saving of over £100 compared with other leading monitors of similar specifications.

The unit has a 14" screen and is suitable for the BBC Micro, Electron, Sinclair QL, Lynx, Oric, Apple, IBM and most other leading micros.

MODEL REFERENCE	1302 21High Resolution
RESOLUTION	580 × 470 pixels
CRT	14"
SUPPLY	220-240V 50-60Hz
E.D.T.	Minimum 19.5kv Maximum 22.5kv
VIDEO BANDWIDTH	10MHz
DISPLAY	80 characters by 25 lines
SLOT PITCH	0.1mm
INPUT VIDEO	R.G.B. Analogue TTL Input
SYNC	Separate Sync on R.G.B. Positive or Negative
EXTERNAL CONTROLS	On/off switch and brightness control

And naturally there's a year's full guarantee. If you order your monitor by post, you'll receive it within ten days by courier service.

Simply post the coupon below to: Opus Supplies Ltd, 158 Camberwell Road, London SE5 0EE. Or telephone 01-701 8668 quoting your credit card number. Or, of course, you can buy at our showroom between 9.00–5.30pm, Monday–Friday, 9.00–1.00pm, Saturday.

\*Microvitec Club 14" monitor

To: Opus Supplies Ltd., 158 Camberwell Road, London SE5 0EE.  
Please send me:

- \_\_\_\_\_ High Resolution Colour Monitor(s) at £229.95 each (ex. VAT).  
 \_\_\_\_\_ Medium Resolution Colour Monitor(s) at £179.95 each (ex. VAT).  
 \_\_\_\_\_ Connection lead(s) at £6.00 each.

I understand carriage per monitor will cost an extra £7.00. (N.B. A High Resolution Monitor including VAT, lead, and carriage costs £279.95. A Medium Resolution Monitor including VAT, lead and carriage costs £221.89).

I enclose a cheque for £\_\_\_\_\_ Or please debit my credit card account with the amount of £\_\_\_\_\_. My Access Barclaycard (please tick) no. is \_\_\_\_\_

Please state the make of your computer \_\_\_\_\_

Name \_\_\_\_\_

Address \_\_\_\_\_

Telephone \_\_\_\_\_

AC 32  
**Opus.**  
Opus Supplies Ltd







M I C R O P O W E R M I C R O P O W E R M

M I C R O P O W E R M I C R O P O W E R M

M I C R O P O W E R M I C R O P O W E R M

M I C R O P O W E R M I C R O P O W E R M

M I C R O P O W E R M I C R O P O W E R M

M I C R O P O W E R M I C R O P O W E R M

M I C R O P O W E R M I C R O P O W E R M

M I C R O P O W E R M I C R O P O W E R M

M I C R O P O W E R M I C R O P O W E R M

M I C R O P O W E R M I C R O P O W E R M

M I C R O P O W E R M I C R O P O W E R M

M I C R O P O W E R M I C R O P O W E R M

M I C R O P O W E R M I C R O P O W E R M

M I C R O P O W E R M I C R O P O W E R M

M I C R O P O W E R M I C R O P O W E R M

M I C R O P O W E R M I C R O P O W E R M

M I C R O P O W E R M I C R O P O W E R M

M I C R O P O W E R M I C R O P O W E R M

M I C R O P O W E R M I C R O P O W E R M

M I C R O P O W E R M I C R O P O W E R M

M I C R O P O W E R M I C R O P O W E R M

M I C R O P O W E R M I C R O P O W E R M

M I C R O P O W E R M I C R O P O W E R M

M I C R O P O W E R M I C R O P O W E R M

M I C R O P O W E R M I C R O P O W E R M

M I C R O P O W E R M I C R O P O W E R M

M I C R O P O W E R M I C R O P O W E R M

M I C R O P O W E R M I C R O P O W E R M

M I C R O P O W E R M I C R O P O W E R M

M I C R O P O W E R M I C R O P O W E R M

M I C R O P O W E R M I C R O P O W E R M

M I C R O P O W E R M I C R O P O W E R M

M I C R O P O W E R M I C R O P O W E R M

FROM THE AUTHOR OF THE TOP SELLING FELIX IN THE FACTORY

# \$wag

B.B.C. MICRO electron

A two player game of dexterity set in Hazord County. Beat your opponent to the jewels and gold with the help of your band of cronies. Includes police cars and one player practise option. (BBC version: joystick & keyboard control).  
 Cossette: £6.95.  
 Disk: £9.95.

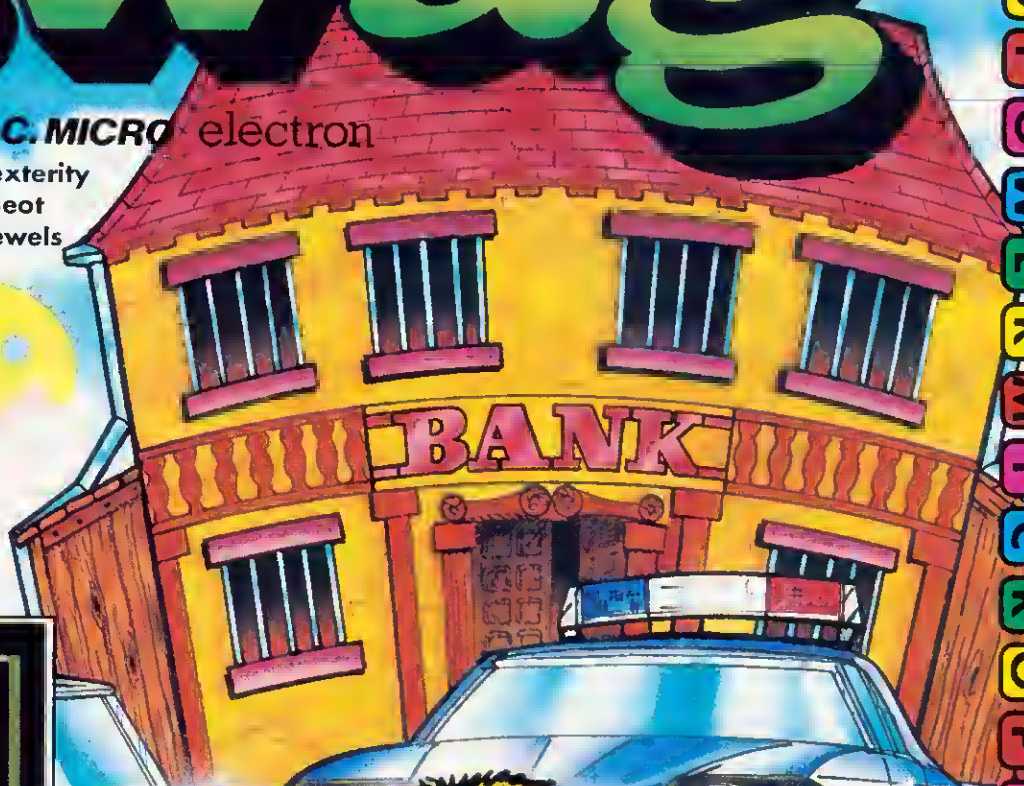

"WATCH OUT FOR THE FANTASTIC NEW PACKAGING!!"



MICRO POWER LTD.,  
 NORTHWOOD HOUSE, NORTH STREET,  
 LEEDS LS7 2AA TEL: (0532) 458800  
 MICRO POWER SOFTWARE IS AVAILABLE FROM  
 SELECTED BRANCHES OF WH SMITH, BOOTS, JOHN  
 MENZIES, CO-OP, WOOLWORTHS AND ALL GOOD  
 DEALERS  
 AUTHORS! WE PAY 20% ROYALTIES!

MICRO  
 POWER



# MISSING LINK

A finishing touch for A to B conversion, by Bruce Smith

THE three-part series by Barry Pickles on how to convert a Beeb program to AtomBasic (May, June and July issues) showed that with a little thought and application many of the more sophisticated commands available with BBC Basic may be implemented on the Atom. The one command missing from Barry's list, however, was AUTO, which provides automatic line numbering, thus taking the tedium out of program entry. This kind of utility is an invaluable aid, allowing you to get on with the job in hand - typing the program in!

The program presented here will provide such a utility. It is written in

assembler. The mnemonic text is a little under 1k in length and once assembled into a convenient area of memory, such as the floating point variable space at #2800, occupies just 193 bytes plus four bytes in zero page for address vectors. Enter and run the program, then the object code can be saved with:

```
*SAVE "AUTO" 2800 28C2 2800
```

Using *Auto* is simple. Type LINK #2800 (LL0 in source). Line numbers will then be displayed in increments of 5 (ie, 5, 10, 15 etc). If you prefer other multiples change the constants in lines 90 and 300 to the desired values. As each line

number is issued enter program text in the usual manner. As each line is terminated with a Return the next line number is displayed.

To exit from *Auto* press Return (displaying the next line number) and then Shift @ (displayed as an inverted @ on the VDU), followed by another Return. Editing and line insertions can now be performed as required. It is vital, however, that the value of TOP is reset by typing END in direct mode before running or listing the program.

To re-enter *Auto* at the point you left it to continue use LINK #289E (LL14 in source). The next line-number in the series will then be displayed.

```

10 REM *****
20 REM ***** atomic *****
30 REM *****
40 PRINT #21
50 DIM XX15
60 FOR N=0 TO 15 : XXN=-1 : NEXT
70 FOR N=1 TO 2 : P=#2800
80 I:XX0
90 LDX @5 LINE ND. INCREMENT
100 STX #90:STX #16 STDRE FIRST LINE NO.
110 JSR XX15 INITIALISE REGISTERS
120 STX#25:STX#81 AND MEMORY
125 STX#82
130 LDA#12:STA#83 GET TEXT SPACE
140 LDA@13:JSR XX7 STDRE CR
150 :XX1
155 LDA #81 STORE HI BYTE
158 JSR XX7 LINE NO.
160 LDA #80 STORE LO BYTE
161 JSR XX7 LINE NO.
170 STY#84 SAVE Y REGISTER
180 JSR #C599 PRINT LINE NOT
190 LDA@32 SPACE PRDPT. READ
191 JSR#CD0F KEYBOARD TO BUFFER
200 LDY #84 RESTDRE Y REGISTER
210 LDX@0 INITIALISE X REGISTER
220 :XX2
221 LDA #100.X READ CHR FROM BUFFER
230 CFX@0:BEQ XX10 IF 1ST CHR. BRANCH
240 :XX3
241 CMP@96 IF '@' (inverted) @
242 BEQ XX11 THEN BRANCH
250 CMP@13 IF CR BUFFER END
251 BEQ XX5
260 :XX4
261 JSR XX7 STORE CR
270 INX:JMP XX2 GET NEXT CHR
280 :XX5
281 JSR XX7 STORE CR
290 LDX #80 LO BYTE LINE NO.
300 CLC:ADC@5 INCREMENT BY 5
310 STA #16:STA#90 STORE BACK
320 BCC XX6 IF CARRY SET
321 INC#81 INCREMENT HI BYTE
330 :XX6
331 LDA#81:STA#25 HI BYTE LINE ND.
340 CMP@#7F TEST FOR MAX
341 BNE XX1 LINE NUMBER
350 JMP XX12
360 :XX7
361 STA(#82).Y STDRE I/P BUFFER
370 INY:TYA TEST Y REGISTER IF
380 BEQ XX9:RTS PAGE NEEDS INC
390 :XX9
391 INC#83:RTS INC PAGE ND.
400 :XX10
401 CMP@13:BNE XX3 IF I/P ERASE
410 DEY:DEY:DEY CURRENT LINE NO.
420 JMP XX3
430 :XX1
431 DEY:DEY END DF PROGRAM
440 LDA@255 INFUT. ERASE
441 JSR XX7 TDF CODE
442 RTS SET TOP
450 :XX12
451 LDA#80 GET LO BYTE LINE NO.
452 CMP@255 TEST FOR LIMIT
460 BEQ XX13:JMP XX1
470 :XX13
471 JSR XX11 END DF I/P
472 JSR #F7D1 LIMIT. INFORM USER
480 J
490 $P="OUT OF NUMBERS "
500 P=P+LENP
510 I NDF:JSR #FD1A BLEEP
520 :XX14
521 LDA#80:STA#16 PRINT NEXT LINE
530 LDA#81:STA#25 NUMBER
540 JSR XX15 SET REGISTERS
550 LDA 13 GET LD BYTE &
551 STA#82:DEC#82 SET TOP-1
560 LDA 14 GET HI BYTE &
561 STA #83 SET TOP
570 JMP XX1
580 :XX15
581 LDX@0:LDY@0 INITIALISE REG.
590 STX#34:STX#43 INITIALISE MEM.
600 STX#321 INITIALISE @%
610 RTS:J
620 NEXT N
630 PRINT #6
640 END

```

# If you're studying... Study our Software

We've been producing educational software for the BBC micro ever since it was launched, and our programs are in use in schools and colleges all over the country. Now, some of these programs have been specially adapted for you to use at home.

With our **Understanding Science** programs you can get to grips with subjects in Biology, Physics or Chemistry that you didn't understand, or supplement your practical work by doing simulated experiments on the computer. These programs are suitable for age 13+ and are ideal if you are studying for those all-important exams. The emphasis is on **understanding** the subject and the programs come with a detailed explanatory booklet. The first programs are ready now —

with many more to follow.

**Chemistry** — Symbols, Formulae and Valency

**Chemistry** — Chemical Equations

**Chemistry** — Inorganic Analysis and Identification of Gases

**Physics** — The Oscilloscope and Waveform Analysis

**The Human Body** — Heart and Kidney

Each package costs £12.95 (cassette) or £13.50 (disc).

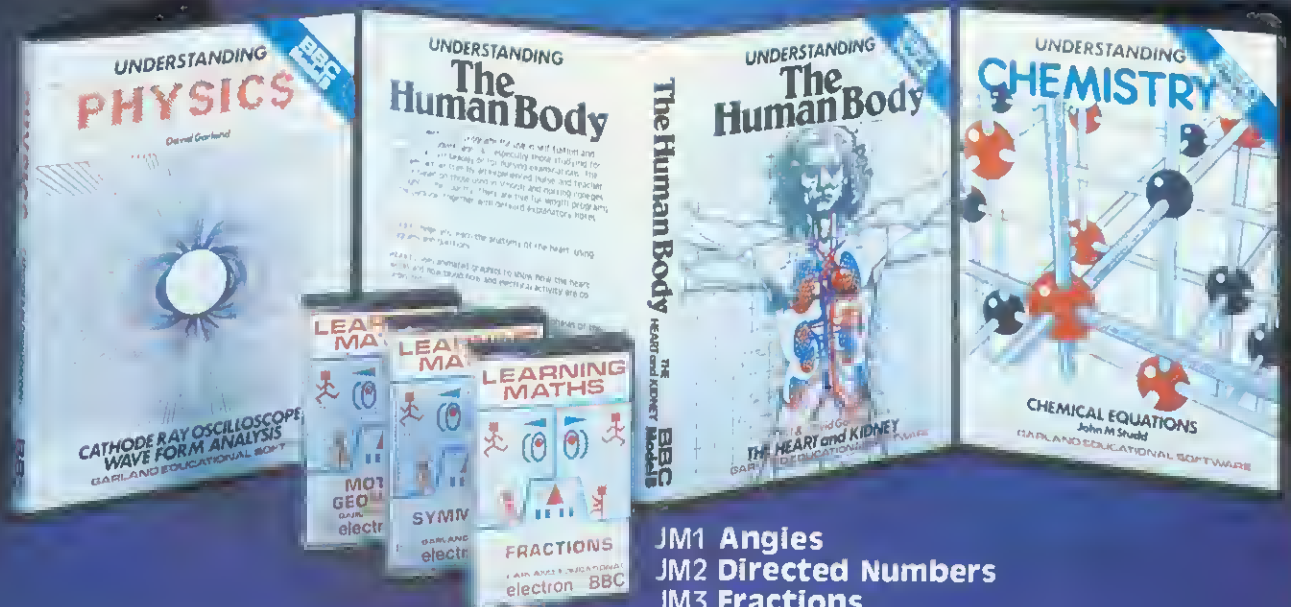

For younger pupils age 9+, our **Learning Maths** programs use simple games and animations to illustrate important principles of elementary Maths. There are nine titles — each containing three or more programs covering a particular concept. The programs are great fun to use — as well as providing real educational value.

Nine cassettes are available\*

- JM1 Angles
- JM2 Directed Numbers
- JM3 Fractions
- JM4 Co-ordinates and Lines
- JM5 Symmetry
- JM6 Motion Geometry
- JM7 Sets
- JM8 Elementary Statistics
- JM9 Ratio

Each cassette costs £7.00. Disc collections also available (JM1-6, £30.00; JM7-9 £18.00)

\*Electron versions of programs JM1-9 and Dragon versions of JM1-6 also available.

Available by direct mail order, or from selected software dealers.  
Prices include VAT and P&P (in UK).

**Please send for our full catalogue of over Fifty Educational Programs**

Garland Computing 25 Broom Hill, Hymersley, Huddersfield, West Yorkshire

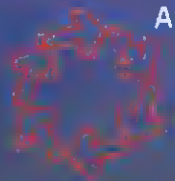



THIS new feature section, edited by Nick Evans, is a forum for all those involved in education: teachers, lecturers, researchers, software and hardware suppliers – and, of course, students and pupils. It offers you the chance to tell us about classroom projects, what software you'd like others to know about, what hardware you feel you need and what problems you're having with, say, networking.

**CHILDREN'S QUIZ**

**WIN A £20 DISC SUITE FOR YOUR CLASS**

*Escape downriver! Climb Everest! Fly to Buenos Aires! Survive in the Sahel!*

These are the challenges of a testing suite of programs produced to accompany the Radio 4 programmes *Introducing Geography* – see news story below.

We're giving away 10 sets to the schools of the 10 winning pupils in our Geo Quiz competition.

All you have to do is answer correctly the 10 questions listed here. The winning entries will be the first 10 correct solutions to be picked out of a hat.

Answers on a postcard, please, to

Geo Quiz, *Acorn User*, Redwood Publishing, 68 Long Acre, London WC2E 9JH, giving your name, age, class, school and school address. Entries should arrive on or before November 23, 1984. Winners will be announced in the January issue of *Acorn User*.

- 1 In what year did Sir Edmund Hillary and Sherpa Tensing conquer Everest?
- 2 What is the highest mountain in the United Kingdom? How high is it in metres?
- 3 Who first flew the Atlantic?
- 4 How far in kilometres is it from London to Johannesburg?
- 5 Is a nomadic tribe: warlike, jungle-dwelling or wandering?
- 6 Do hyenas hunt alone, in packs or in family groups?
- 7 What word describes a river that flows into a larger one?
- 8 Is a monsoon: a swamp, a rainy season or a type of boat?
- 9 Name two deserts in Africa.
- 10 What is the continent surrounding the South Pole called?



Detail of a screen shot shows the high quality of the Summit simulation's graphics

# Radio 4's survival challenge

ACTION-packed geography lessons? That's what is promised by a suite of simulation packages put together by BBC Radio. Produced in conjunction with the Radio 4 school series *Introducing Geography*, the 'Exploring the Environment' programs consist of four dynamic simulations that will challenge the wit, skill and resourcefulness of any 10 to 12-year-old.

Each simulation puts the 'player' into a perilous predicament and the process of winning through turns learning into an exciting adventure.

The four programs – called *River*, *Flight*, *Nomad* and *Summit* – come on a set of three discs, costing £20 (inc. VAT).

In *River* the pupil crash-lands his plane in a remote mountain region and has to face realistic problems of survival, seeking out a river and, in an attempt to find civilisation, following its course to the sea – all within a time limit. This program has three levels of difficulty.

*Flight* also casts the player in the role of a pilot (or his

navigator). The challenge is to fly safely across mountains and oceans to a far-off city, recognising the changing features of the terrain below (shown in colour graphics on the screen). Before take-off, pilot and navigator have to do some thorough atlas research, so more than aeronautical skills are involved.

With *Nomad* the problems are not technological but those of survival in the African Savanna. The children 'live' the life of the Faluni, a nomadic tribe who seasonally move

their herds north and south in search of good grazing. The player takes the role of a Faluni in charge of 20 head of zebu cattle over a 20-year period and is encouraged to make graphs and charts to report progress.

Surviving the treacherous weather conditions on Mount Everest is the challenge of *Summit*. The climb has to be planned in stages so that camps get vital supplies and the ascent has to be made before storms make climbing impossible. Some high-quality

graphics contribute to the realism of this simulation.

The suite of programs aims to familiarise children with map-reading techniques and geographical and meteorological terms, and encourage them to make informed decisions. The programs are mostly self-contained and need little introduction from the teacher – liberal use of help pages enables the pupils to use the simulations on their own while the teacher works with the rest of the class.

A series of Friday morning broadcasts next summer (June 7–28, 1985) will set the scene for these simulations, provide background information and vocabulary in the form of documentary and dramatised stories. But teachers and parents will be able to set children to work on the programs before then, for the 'Geosoftware: Exploring the Environment' set becomes available later this month.

It can be ordered from BBC Publications, School Orders Section, 144 Bermondsey Street, London SE1 3TH, quoting order no. ISBN 326522.

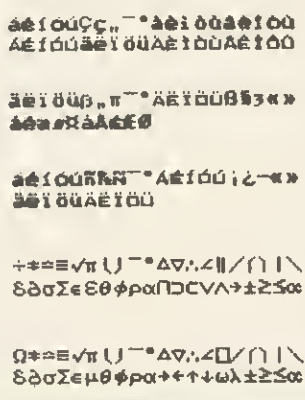

Teachers of modern languages, maths and technical subjects may be interested in a wordprocessing package that enables a variety of character sets to be used. *BBtype* gives, for example, French and German teachers a full set of accented characters, and Scandinavian, Spanish and a fair sprinkling of Greek characters are present. The full set of new characters is illustrated here, and *BBtype* is reviewed on page 181.





# Schools and the Act

THE implications of the new Data Protection Act may not be immediately evident to people in education. The act requires that anyone who processes data relating to people, unless specifically exempt, must register with the Data Protection Registrar.

School databases must be covered by the act and local authorities are already planning how they will cope. Records being produced now are going to become the subject of the law's requirements in 18 months' time when registration must be completed.

The broad features that

affect education are:

- Data must not be kept any longer than necessary.
- People whose data is on record have the right to know they are on file, and to see the file. If it is incorrect they have the right to change it.
- The information must be accurate and kept up to date.
- Data intended for one purpose cannot be used for another.
- All files must be secure to prevent tampering.

Few databases used by schools are secure, as passwords or codes to open up

editing facilities are rarely available on packages. The data itself is certainly not of an innocent nature as important decisions about a child's future are based on it.

Inaccuracies can be cumulative and catastrophic and it is for this reason that the Bill aims to make the information about individuals available to them. Schools and colleges will have to react by tightening up their procedures for storage and retrieval as well as deciding whether the information is relevant or even necessary.

It seems unlikely that indi-



Report in the May issue

vidual schools will have to register since they are a part of the corporate local education authority which will register as a whole. Guidelines will soon be filtering down the system.

## Teachers in front line

YOU may have read in September's issue that one pearl from the thoughts of Acorn boss Chris Curry in his evidence to a House of Lords select committee was that 'Computer classes are a den of thieves'.

Computer magazines are full of stories on piracy and protection and we in education are at the forefront in the debate since we have the most contact with software and the greatest viewing audience. The excuse that software is poor and therefore should be pirated holds water only if we don't expect further programs to be produced, good or bad. If we expect good software to come then we must suffer the



Curry: 'Classes are a den of thieves'

birth pangs of the less worthy material.

And teachers and pupils have a role to play. How often have you informed a producer what you thought of a program; how often have you been constructively critical? Remem-

ber - most suppliers are not teachers and can produce only what they think is needed. The exceptions are groups such as Longman and Heinemann who have long been in the education market and have schools and educationalists on their research teams. The difference in quality of software usually shows through - although not always!

Unfortunately, even the most reasonable arguments will not stop the unscrupulous in our midst and publishers are now taking steps (other than interminable software protection, thank goodness) to see that wrongdoers are brought to court. That however, is another story.

## Ebury on the distaff side

'THERE is not a lot that people can do on a computer that is practical. The software does not exist . . . In reality the machine is only for playing games.' Thus says Ebury Software - a division of the National Magazine Company, which publishes *Good Housekeeping* and *Cosmopolitan*.

The company is obviously aiming to bridge the gap between computers and the female population. As a start, a set of programs to be issued in the spring will contain material that will enable them to learn with computers for applications in their jobs and for the education of their children.

Whether the software is going to fill the gap and convince women that the computer is a necessary adjunct to their own and their children's education remains to be seen. How many women are going to be converted by programs for gardening, knitting, cookery and home layout?

This seems to be the sort of role-stereotype reinforcement schools have been fighting against in their curricula for the past decade. And if, as Ebury's comments suggest, the computer is only a plaything, why are so many people buying machines for education, wordprocessing and even the labour-saving of home-accounts packages?

Think again Ebury.

## Danger: VDUs

A REUTER report recently in many newspapers said that pregnant women using computer terminals in Denmark had suffered miscarriages. A figure of eight out of 10 was quoted and an investigation is underway at the Aarhus Clinic for Occupational Medicine.

In schools, children are being exposed daily to radiation from monitors with little or nothing known about the long term effects. Watching a distant television is not quite the same, especially as monitors often are mounted directly above keyboards.

## Chance to view

REGIONAL viewing centres give teachers access to software before they buy - an advantage when you consider that until recently most took pot-luck or relied on the wisdom of a reviewer.

Consequently these centres are now approaching software producers with requests for material and give the schools a good selection, and the manufacturers a shop-window. Different authorities, however, are approaching the task from different angles.

Strathclyde Regional Coun-

cil, for example, suggests that '... you will consider depositing copies of software. . . whereas Humberside asks if '... you will be willing to either provide or offer a discount off the price of single items of software. . .'. MEP East Midlands offers '... the free publicity and marketing which MEP information provision and in-service training implies.'

Software houses are being inundated with such requests and it is to be hoped that suppliers are able to respond.

# For little Acorns Mighty SHARDS Grow

# SHARDS

software

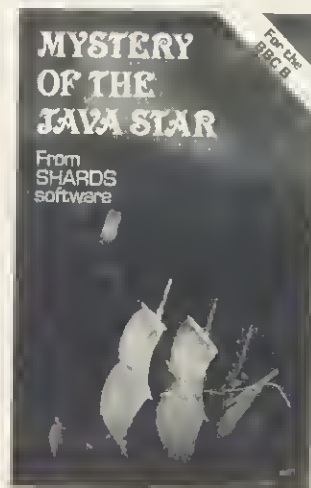
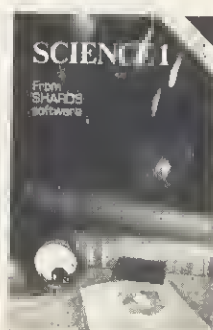
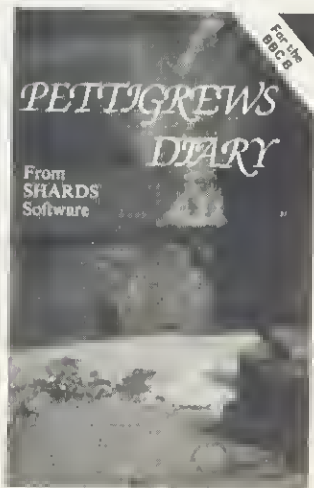

If you want well written and presented software for your Acorn computer then take a look at Shards. Shards can offer you entertainment and educational software that really is a cut above the rest.

Take a look at Shards.

### Adventure and Strategy Games

**Pettigrews Diary** - A massive 90K graphic/text adventure with a difference. Can you solve it? (BBC & Electron)

"Complete original and highly intriguing ... (it will give your grey matter a thorough workout)". *Your Computer* £7.95

**Empire** - A superb graphic strategy game against the computer. 8 levels of difficulty. Played on a world map. Win at level 7 or 8 and you deserve a pat on the back!

"I thoroughly enjoyed this game ... graphics are excellent (100% rating)". *Home Computing Weekly* £6.95

**Mystery of the Java Star** - A graphic adventure for all the family. Utilises 100K of memory. Gripping stuff!

"Exceptional value for money ... well done Shards (100% rating)". *Home Computing Weekly* (BBC & Electron) £7.95

### Educational

**Fun to Learn**, the definitive educational series - written by teachers and used in schools nationwide. All programs are menu based and make superb use of graphics. 100% user friendly and error trapped.

"This is how educational software should be written..."

**Fun to Learn** - A comprehensive program for 6-12 year olds.

"This is how educational software should be written". *Home Computing Weekly*

**Monster Maths** - Helps develop basic maths and logical skills for 6-14 year olds.

"A sound program that will maintain children's attention, for £6.95 it's a cheap treat". *Educational Computing*

**Laser Letters** - Educational word games for 6 year olds to teenagers. Three separate 500 word vocabularies. (BBC) £6.95

"You get a lot for your money ...". *Educational Computing* £6.95

**Frac Attack** - Fun with fractions for 8-14 year olds.

"A real winner ... lots of colourful screen action". *Popular Computing Weekly*

**Science 1** - Science education for 11-16 year olds. Covers the use of lenses, meters, thermometers and balances.

Super graphics. (BBC & Electron) £6.95

"For fundamentals of balances, meters or lenses, this program is a must". *Popular Computing Weekly*

Selected titles available at larger branches of Bunt's and W. H. Smith and all good stockists or by sending a cheque/P.O. direct to us at: Suite G, Roycraft House, Linton Road, Barking, Essex. Tel: 01-591 7666 (4 lines)

Please send me a copy of:- (please tick)

- |                      |                          |               |                          |
|----------------------|--------------------------|---------------|--------------------------|
| Pettigrews Diary     | <input type="checkbox"/> | Fun to Learn  | <input type="checkbox"/> |
| Empire               | <input type="checkbox"/> | Monster Maths | <input type="checkbox"/> |
| Mystery of Java Star | <input type="checkbox"/> | Laser Letters | <input type="checkbox"/> |
| Science 1            | <input type="checkbox"/> | Frac Attack   | <input type="checkbox"/> |

Please indicate which version required:-

- BBC B  Acorn Electron

To (Name) .....

(Address) .....

Please debit my Access/Visa account.

A/C No. ....

I enclose a cheque/P.O. remittance for £ .....

(Signed) .....

All cheques/P.O. to be made payable to  
**Shards Software**

\* All orders despatched within 24 hours of receipt.



# EDWORD HITS THE HEADLINES

**T**EACHERS are always looking for good ideas to help encourage children to write effectively. My opportunity came with an educational journey, on which I decided to base a classroom project. The project pre-



sented just the right occasion to introduce my pupils to wordprocessing, using the *Edword* system.

The use of the computer was only a small part of our project, however, which took the form of an integrated studies programme based on a journey to Weston-super-Mare. This included visits to Cheddar Gorge and Caves, Weston Museum, Bristol Zoo, *SS Great Britain*, Slimbridge Wildfowl Trust, Wokey Hole and Wells Cathedral.

On returning to school after our six-day trip the children set to work on an extensive programme of follow-up work, detailed as follows:

1. The children carried out research work on the visits that were made and could include any related topics of their choice. Thus the children did some ground work together as an introduction but thereafter could follow their own interests. This involved many visits to the school library, finding their way around reference books and other sources to find out information.
2. The research work was put into a project book. This book was made by

the children and they were taught the skills of bookbinding.

3. A display of the children's work was mounted to decorate the school hall. This included models, pictures, letters, poetry, writing of different styles and general art work showing the use of different mediums.

4. An evening was set aside for the parents to see the children's work and to hear a verbal account of some of the events of the week.

5. The wordprocessor was used to produce a 'newspaper'. The purpose of this was to entertain and inform readers about the children's opinions as well as their thoughts and feelings about the school journey.

## PRICES

'*Edword*' is contained in a 16k ROM which can be used on both models A and B of the BBC micro. It is marketed in several packs, the basic User Pack (£38.95) consisting of the ROM, user manual, self-instruction slip booklet and keyboard insert; for primary school applications the teacher will need the User Pack plus the Primary Guide, which costs £10 (cassette) or £12 (disc). The Starter Pack (£56.95 for cassette version, £59.95 for disc) is suitable for secondary schools. A Teacher Pack with cassette (£21.95) or disc (£24.95) includes a teaching guide, OHP and wall charts, information sheets on wordprocessing and instructions on setting up the printer.

Further details: Clwyd Technics, Unit 4, Antelope Industrial Estate, Clwyd CH7 5JH. Tel: (035 283) 751.

'*Edword*' was reviewed in the May issue of *Acorn User*, page 135 (but note updated prices as above).

Ron Gandolfo explains how he used a classroom newspaper project to introduce pupils to wordprocessing

131

Naturally after a school journey of the type described it stimulated the children's interest and they wished to communicate it. A newspaper could, of course, be produced without the use of a wordprocessor, but it had a number of advantages.

It gave our newspaper a professional look in its completed state. *Edword* offers wide and bold print which helped titles and subtitles to stand out. The children were able to indent their work and draw pictures around the text they had created, after it had been printed.

There was a natural progression from using a typewriter to operating a word-processor.

To produce a newspaper of the length and quality that we did would no doubt have needed the school secretary to have given up a lot of time to help us get a final draft typed and stencils cut. Using *Edword* meant that the children themselves were able to create, edit and print, thereby gaining



experience of all the different processes.

To say that *Edword* is a useful addition to the primary classroom would be an understatement. A wordprocessing system on a ROM chip for the BBC micro, *Edword* was designed by teachers for use by children, and at Courtwood Primary School, Croydon (where we use cassette tapes), it has

Remove your weary fingers from the fire buttons and climb aboard your magic carpet to enjoy this delightful and original game.

**£7.95**

**BBCB**  
PROGRAMMED BY  
DENNIS ABBOTSON

- Hi-Score Table
- Surprise reward
- Infuriatingly addictive
- Fantastic sound effects
- Amazing 3D sequences
- A time test of skill and agility
- Refreshingly original family game

VGA 2014

## FREE INTERFACE

WITH EVERY 'brother' TYPEWRITER  
MODELS CE51,60,70,EM80,100,200  
PURCHASED

AVAILABLE TO BBC,B USERS ONLY

THIS UNIQUE INTERFACE, INCORPORATING ITS OWN VIEW DRIVER, WILL ENABLE YOU TO USE THE BROTHER TYPEWRITERS AS LETTER QUALITY PRINTERS. ITS EASY TO INSTALL AND COMES COMPLETE WITH FULL DOCUMENTATION.

COMPARE THIS PRICE FOR A  
LETTER QUALITY PRINTER

CE51 **£299** + VAT.  
OR

PURCHASE THE INTERFACE ONLY FOR £75 INCL. VAT  
BARCLAY - ACCESS AND CREDIT FACILITIES AVAILABLE

SEND SAE FOR FURTHER DETAILS

ABACUS BUSINESS MACHINES LTD,  
961 CHRISTCHURCH ROAD, BOURNEMOUTH,  
DORSET. BH7 6AZ. TEL (0202) 423204

TRADE ENQUIRIES WELCOME

## Stake your survival on Spaceman Sid.

Another great challenge from English Software

Survival on Earth depends on 'Spaceman Sid'.

And that means YOU! Get behind the controls of your laser-armed combat rover - and start the battle.

The Martians have taken over our dilithium mines on the planet Tribos and re-capturing those essential mines is your tough challenge.

But watch those Martians - they're loaded with dirty tricks. And watch out for the other hazards of space travel... you won't have to wait long, we can guarantee!

There are 3 progressive levels of difficulty of play. That applies to both Acorn Electron and BBC Model B users.

'Spaceman Sid' is available on cassette for just £7.95, so beam yourself into



your local dealer today.

Tomorrow itself could be at stake!



**THE POWER OF EXCITEMENT**  
The English Software Company,  
Box 43, Manchester M60 3AD  
Trade Enquiries Tel: 061-835 1358

## BASIC COMPILER

Turns your basic programs into really fast machine code. The compiler is very easy to use, and comes complete with full instructions.

For the BBC model B, or Model A with 32k.

**Cassette**      **£17.95**

**Disk**            **£19.95**

(40 OR 80 TRACK)

Cheque/P.O. or SAE for details to

**ACK Data**

21 Salcombe Drive, Redhill,  
Nottingham, NG5 8JF  
Tel. (0602) 262498



## CLASSIFIED

### ADVERTISEMENTS

#### WOOKEY HOLE

Man needed to make more stalagmites and stalactites to replace originals (If possible not paper mache').

Contact: 612-4567

Ask for M. White or N. Jones.  
Courtwood Newspapers,  
19 Fleet Street, London W12 8QT.

#### WESTON-SUPER-MARE

Man wanted to clear mud from Weston beaches.

All cranes prohibited shovels and spades ONLY.

Please ring: 657-0907 or 66-42676. Ask for M. White or N. Jones.

#### JONES & WHITE BOOKSELLERS LTD.

Buy our new exciting books.

Here are a few examples:

Haunted House by Hugo First.  
Happy Christmas by Miss L. Toe.  
The Best Thing in the World by Sue Perb.

Get Rid of the Stains by B. Leach.

A Day at the Zoo by C. Lion.

#### Strong Man WANTED

To widen Cheddar Gorge.

Natural muscles ONLY.

NO fakes.

Get in touch with Cheddar wardens.

BE PREPARED.

#### SCIENTIST WANTED

To carry out experiments on Cheddar stone to see if it can be made into cheese.

CONTACT: Cheddar (No. in directory).

#### SLIMBRIDGE

Man wanted to dress up as a rare species of drake to entice a female species of this duck out of isolation. Dwarfs only to apply.

Adverts compiled by

NICHOLAS JONES & MICHAEL WHITE.

#### A DAY IN THE LIFE OF CHEDDAR MAN.

A STORY FOR OUR YOUNGER READERS.



One day I decided to go out hunting because we were running out of food. I lived with Lango my great companion. We lived in the outer edge of the cave. I picked up my spear and set off. I pulled my furs around me for it was cold. Then I spotted a Reindeer, I crept behind a tree and mounted my spear. I threw it, and BULLSEYE. I got her, and she fell to the floor with a thud. I sprang up and dragged her off to the cave. Lango was there waiting for me, he was in fact fast asleep because he had been out in the forest all night. I rubbed two sticks together to light the fire and skinned the animal.

While the reindeer was cooking I went down to the river to wash the fur. It was a difficult and very messy job but after a while I got it finished. I filled the bowl I had with water and walked back to the cave. I was just time, because the food was cooked. I sprinkled herbs and spices on it and then woke up Lango. He yawned and sat up. He licked his lips and tore off a piece of meat and ate it up hungrily. Lango never said much but you can tell he understands. When he does speak it's full of common sense.

After our meal we ran down to the river and bathed. Then we went back to the cave, and Lango went for his nightly walk. I set fire to the tip of a stick and hung it on the wall so that it lit up the cave. Then I started to make some clothes with the reindeer skin, a thin piece of wood and some thread. Then after that I painted a few animals on the wall of the cave with special chalks, which I really enjoyed. It was a picture story about my hunt for the reindeer. Then I snuggled down under some furs and fell asleep.

Story and photograph by  
REBECCA FITZGERALD.

Left and above: two examples from the children's work produced for their newspaper. *Edword* enabled them to produce 'clean', corrected text in multiple copies, with indenting to allow them to 'drop in' their own pictures and bold and wide print to allow headings to stand out.

proved an extremely powerful tool. It is easy to introduce into the classroom and is an enhancement to most areas of the curriculum.

Faced with two thick manuals, I thought learning *Edword* would demand much detailed reading and practice. Far from it: although I gave myself a weekend to work through the manuals, the children were able to start using *Edword* knowing very few commands. Once taught how to get into *Edword*, where the cursor keys are and the position of the delete button, pupils can create something worthwhile, especially if they are familiar with the typewriter.

Having mastered the basic skills, one can progress to learn the detail as needed. I have used *Edword* with 11-year-olds, but I'm sure it could be introduced to quite young children with just a little keyboard experience.

By the time children have written some experimental documents they are ready to take on the skills of editing and restructuring text, especially when they show eagerness to improve their document. The children soon start asking questions such as 'How do I swap a word for a different one?' or

'What does this justify key do?' or even 'Is there a quicker way of doing this?' They quickly discover that with *Edword* you can be almost certain there is a quick method and they want to know more about the word processing system itself. In this way they are introduced to a few commands at a time.

Every child was involved in writing articles for the newspaper. The children worked in twos or threes discussing their thoughts and ideas, then they took it in turns to type their ideas on to the wordprocessor. Through discussion and some help from me they were able to edit their own work. One child was made general editor, although all were taught basic *Edword* editing skills.

Different styles of writing were included - formal and informal, fiction and fact, light-hearted and serious. The wordprocessor enabled us to consider what was presented in a real newspaper and create our own version in our own style. We included sensational headlines, general news, sports items, leisure activities, a fun page, adventure stories, a reviews and opinion page, a history section, adverts, ornithologist's section, exclusive interviews and a

# Game for a song... VIRGIN GAMES at £2.99

The **LAUGHING SHARK** told us that it won't be long till **CHRISTMAS** and it was time we did something about it so, until the end of **NOVEMBER**, we will be selling most of our **BEST GAMES** at the **SPECIALLY REDUCED** price of **£2.99** instead of the usual prices of **£5.95** and **£7.95** - that's a **SAVING** of between nearly **£3.00** and **£5.00** per game!

These titles **ONLY £2.99** each -

	NORMAL PRICE	SAVING		£7.95	£4.96
<b>ELECTRON</b>			Noc A Bloc	£7.95	£4.96
Bugs	£7.95	£4.96	Chieftain	£7.95	£4.96
Jungle Jive	£7.95	£4.96	Plankwalk	£7.95	£4.96
			Microbe	£7.95	£4.96
			Trench	£7.95	£4.96
<b>BBC B</b>			Bug Bomb	£7.95	£4.96
Brainstorm	£7.95	£4.96	Landfall	£7.95	£4.96
Sea Adventure	£7.95	£4.96	Space Adventure	£7.95	£4.96
Check Out	£7.95	£4.96	Jungle Jive	£7.95	£4.96

**Brainstorm** - TWO PLAYERS'... on a parallel with chess if not more complicated... great for a game which needs thought' *Home Computing Weekly* **Checkout** - RECENT RELEASE 'Superb graphics and sound and originality combine to make a wonderful game' *Home Computing Weekly* **Noc-a-bloc** - '... good game with clear, smooth graphics and plenty of colour' *Personal Computer Games* **Plankwalk** - 'Highly recommended' *Personal Computer Games* **Microbe** - 'The game is a great example of what can be done on the BBC. I'm addicted' *Personal Computer News* **Trench** - '... an excellent game which will certainly keep your fingers dancing on the keys of your Beeb' *TV Gamer* **Bug Bomb** - 'This game is wonderful and is a great example of what can be done on the BBC. I'm addicted' *Personal Computer News* **Landfall** - 'Virgins Landfall is a sophisticated flight simulator' *Your Computer* **Space Adventure** - 'The only problem I had with Space Adventure was prising my friends away from it' *Home Computing Weekly* **Jungle Jive** - RECENT RELEASE 'If you enjoy wholesale slaughter then you'll probably have a good time' *Personal Computer Games*

If your local **RETAILER** does not stock these **GAMES** at the **SPECIAL LOW** prices, simply send a cheque or PO for **£2.99** for **EACH GAME** you want plus 50p postage and packing (however many **GAMES** you **ORDER**) to the **'GRAB IT WHILE YOU CAN'** Department, Virgin Games, 2-4 Vernon Yard, Portobello Road, London W11 2DX.

Offer subject to availability



# PAWS



Each disk holds 1000+ hours of s/w engineering developed from our artwork systems. These programs fully exploit a disk-based BBC to stimulate long-term interest through exploration and experiment.

Prices inclusive. State 40tr or 80tr. £3 off total for 2 programs; £6 off for 3. Add £5 if backup required. Special terms for Schools/Colleges needing 3+ copies.

\* **JIGSAW PICTURE & WORD PUZZLES (2 programs):** £14.50

JSPP takes any mode-2 picture, 3 pictures supplied JSWP has fun-to-use word-puzzle creator/editor Random jumbles on 12 levels; toddler to top puzzler Four sliding & teleporting cursor options Helps: Tidy/Re-jumble keys, Save/Reload

\* **TEX and PAM (2 programs):** £14.50

TEX creates/modifies/animations mode-7 pictures Output options: spool, \*save, \*save 5-pic sequence PAM runs TEX o/p as film/slideshow/newsreel Timed frames, inner loops, 13 TV-type smart wipes Shop/exhib users: please ask about Advert Mgr Sys for displaying your goods with up-to-date prices

\* **MUSIC MAESTRO (synth for non-musicians):** £12.50

Design pleasant/weird sound envelopes MM displays pitch and amplitude waveforms Play: 4oct, 8std + ownenvs, chords, arpeggios, loops Record/edit/replay. Add rhythm after melody



Cheques/PO with order to:  
**Promotional ArtWork Systems**  
9 Mayo Cl, Leeds 8 LS8 2PX



## IS PAPER WORK GETTING ON TOP OF YOU ?

# ABACUS

BUSINESS SYSTEMS

## CAN BE YOUR STEPPING STONE

TO EFFECTIVE FINANCIAL AND ADMINISTRATIVE CONTROL

- |   |                       |        |
|---|-----------------------|--------|
| 1 | PAYROLL               | £29.95 |
| 2 | PURCHASE/SALES LEDGER | £29.95 |
| 3 | STOCK CONTROL         | £17.95 |
| 4 | NON VAT ACCOUNTS      | £17.95 |
| 5 | CASH PLANNER          | £12.95 |
| 6 | MAILING LIST          | £17.95 |

ALL PROGRAMS AVAILABLE AS A BUSINESS STARTER PACK FOR THE SPECIAL PRICE OF £99.50

THE PRICES ABOVE ARE FOR THE CASSETTE VERSION OF THESE PROGRAMS, DISC VERSIONS USING RANDOM ACCESS FILES ARE AVAILABLE FROM OCTOBER 1ST 1984.

ALL SOFTWARE PROVIDED BY ABACUS, IS FULLY SUPPORTED BY THE COMPANY.

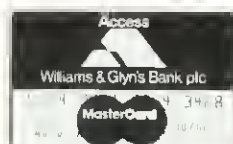

21 UNION STREET  
RAMSBOTTOM, LANCS  
PHONE: 0204 52726



AVAILABLE FROM ALL GOOD COMPUTER SHOPS  
BBC MODEL B, SHARP MZ700  
COMMODORE 64  
AND DRAGON 32 AND 64



## Educational benefits of wordprocessing

Like most wordprocessing systems *Edword* allows children to refine their own work. It has many easy-to-use features to this end. Refining can be improved with constructive criticism from the teacher and/or fellow pupils. Children need to be encouraged to read over their work with a critical eye and have the opportunity to discuss it with their friends—they learn an enormous amount from each other. So often children are expected to work in isolation and the results are disappointing. Pupils who are given the opportunity to discuss their work with each other far more often produce something of a higher standard. I have always encouraged them to work in pairs on the wordprocessor when they are editing and restructuring a document. We all learn by our mistakes and it is excellent practice for the children



to talk about what they are doing and try something out.

To write for a real purpose and for a wide audience is most important to children. So often work is completed in isolation in an exercise book that will be read only by the teacher and then forgotten. With the newspaper the children were able to write articles and documents knowing that what they were producing would be printed and distributed, and therefore read by their parents, other adults and their friends. The children soon recognised the need to produce something worthwhile.

The presentation of a child's work was important to the child. The 'hard copy' from the printer gave every child the chance to have something to be proud of. Children whose presentation and handwriting are poor might have been inhibited in producing enthusiastic contributions, but with a wordprocessor the poorest of calligraphers are on a par with the best. All feelings of failure in this respect were now obliterated.

In turn teachers must display work carefully and pleasingly.

The computer seems to have exceptional powers of motivation for children, and this holds true for the wordprocessor.

Many of the skills that the wordprocessor helps us to develop in children have been ignored in the past. Traditionally teachers have not expected children to correct every mistake in a piece of writing, but with a wordprocessor refining and correction can be introduced sooner to children, who are often amused by their most glaring mistakes. It is only fair that they get the opportunity to correct them. With a wordprocessor, teachers also find they can correct more mistakes in a child's work, for it is so easy for the child to recall a document that has been saved, and then refine it. Perhaps this is the crux of the matter, as the child no longer has to waste time rewriting the complete piece of work.

High standards appropriate to a child's ability can be set. Children can benefit by learning to edit, restructure, improve and expand text, skills otherwise not usually practised.

The children soon became proficient two-finger touch typists and it was not necessary to give typing lessons. If they had been first-class typists their train of thought would not have kept pace and more errors would have occurred. Speed on the keyboard was related to speed of thought.

It was quite noticeable from the beginning that because the wordprocessor gave the children a clear screen with their work neatly printed they were going to take more care with punctuation and spelling. I frequently found a dictionary on the computer table and even a thesaurus. This was most encouraging and even more so to hear children talking about the best word to use or the correct use of punctuation.

page 137 ▶



page for younger readers.

When the children had completed editing their work, four copies were printed off. One copy was used for display, one for the child's project book, one for the newspaper duplication and the fourth for the child to take home. By traditional methods it is a lot to ask a child to write an extra copy for display purposes, but copying it out four times would have been unthinkable!

Producing multiple copies is very easy with *Edword* as there's a simple procedure of pressing the print key f8 and answering the question 'Is your printer ready (y/n)?'. This process is rapid. It prints a page of 66 lines in just over a minute.

The printer caused great interest at first, with the whole class crowding around it, but within a short time the children accepted it like any other piece of electrical equipment in the classroom and continued doing their work and awaited their turn. At first the noise of the printer, an Epson RX80, was quite off-putting, but interestingly it put me off more than the class—children adapt amazingly to new things in the classroom.

*Edword* can be used with a wide range of printers. A printer file needs to be made to suit the printer in use, and this can be achieved with a package called 'Printer File Generator', available from the same source as *Edword* (see prices panel).

Once we had all the articles for the newspaper printed off it was a simple matter for me to make use of a photocopying machine at the local teachers' centre. We decided to produce 100 copies. This was the only activity the children did not take part in. When the originals had been photocopied the children got on with sorting and compiling the pages and stapling them together. The front cover had been photocopied on yellow paper to make it look attractive.

# THE OLYMPIA RANGE OF DAISYWHEEL PRINTERS

A RANGE OF DAISYWHEEL PRINTERS DESIGNED BY OFFICE EQUIPMENT LEADERS

## OLYMPIA INTERNATIONAL

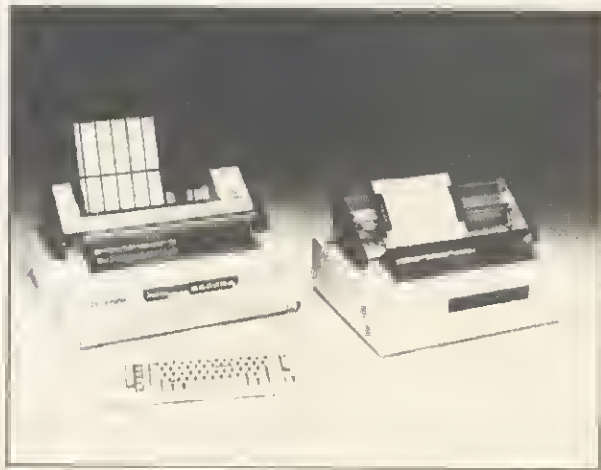

### OLYMPIA 3000 SERIES

**Method of printing:** Daisywheel interchangeable 100 characters.

**Print speed:** 50 cps maximum. (40 cps Shannon)

**Form width:** 17" **Width of printline:** 15".

**Tabulation:** Variable, 60 positions/inch (optional 120) bi-directional, horizontal tabulation direct to column address, halfspace forward.

**Pitch:** 10, 12, 15 characters per inch and proportional spacing.  
**Line length:** 150 characters with 10 pitch, 180 characters with 12 pitch, 225 characters with 15 pitch.

**Method of printing:** Automatic bi-directional printing with shortest path seeking logic. Automatically skips over blank fields.

**Paper feed:** Variable, 96 positions/inch, bi-directional.

**Buffer:** 4 K Buffer. Keyboard option. Qume/Diablo. Code option.

**Function control led:** ON/OFF-Line. Paper out. Ribbon out.

Cover open. Error.

**Printing mode:** Bold printing (1/120"). Expanded printing. Double strike.

**Interface:** RS232 IEEE, Centronics.

### OLYMPIA 103 SERIES

**Method of printing:** Dypewheel, exchangeable, 96 characters

**Print speed:** 17 characters per second, Bidirectional.

**Form width:** 17" (431.8mm)

**Width of printline:** 14.2"

(360.6mm)

**Tabulation:** Variable, 60 positions/inch, Bidirectional

**Pitch:** 10, 12, 15 characters/inch proportional spacing

**Line length:**

141 characters with 10 pitch

169 characters with 12 pitch

212 characters with 15 pitch

**Paper feed:** Variable, 96 positions/inch, Bidirectional, indexing one half space up/down.

**Printing:** Automatic bold, (1/120"), expand and double print. Automatic bidirectional printing with shortest path seeking. Automatically skips over blank fields.

**Buffer:** 4 k byte.

Keyboard option. Onme control code. Option for Wordstar.

**Function controls led:**

102 ON/OFF-Line. Error.

103 ON/OFF-Line. Error.

Bold print.

Expand print. Double print.

**Interfaces:** RS232.

Centronics IEEE.

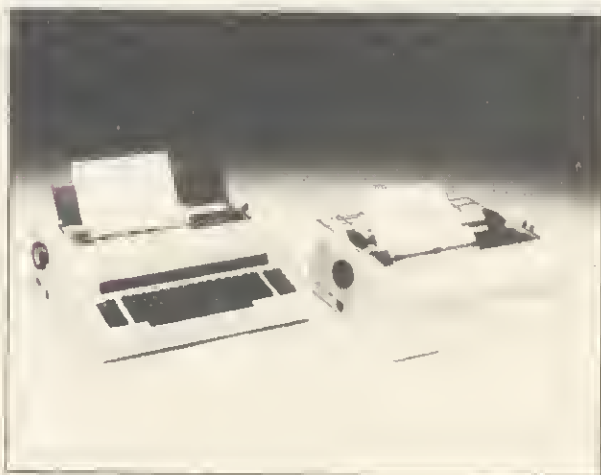
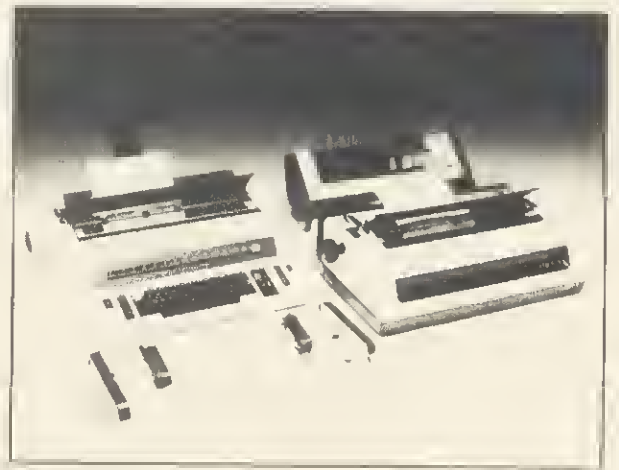

### OLYMPIA COMPACT SERIES

**Method of Printing:** Daisywheel 100 characters. Interchangeable.

**Print Speed:** 14 cps

**Form Width:** 14.3" **Width of Printing:** 11.5"

**Pitch:** 10, 12, 15 characters per inch.

**Line length:** 10 pitch - 115 char. 12 pitch - 138 char. 15 pitch - 172 char.

**Instruction code:** Diablo compatible (compact R0)

Built in Tractorfeed - Compact R0

Built in Keyboard - Compact 2.

RS232 or Centronics Interface (Compact 2)

Both interfaces as standard (Compact R0)

### ACCESSORIES

Olympia Single Bin Sheet Feed £398. Double Bin Sheetfeed £598.

Olympia Tractor Feed £150. (All Prices exclude VAT)

A full range of Daisywheels and ribbon types are available.

**Distributor:** Intelligent 43B Wood Street, Stratford upon Avon, Warwickshire CV37.  
**Interfaces Tel.** 0789 296879 London 01-311 7981 TL. 312242.



## Problems with Edword

While creating our newspaper we stumbled across a few problems with *Edword*. Most importantly, children irretrievably lost entire documents by accidentally pressing the Break key after spending considerable time at the keyboard. This is easily done because the f9 command key is next to the Break key.

The command key is frequently used and it would be a great advantage to have the Break key disabled.

A facility that we would have found most useful would be to add a document, previously saved on tape, to a part document already on the screen. For instance, if a group of children were creating a page of work for a magazine but two documents had been saved on separate tapes, then the only way of making them one document would be to type one into the other. The ability to merge two documents would have been advantageous.

It was essential that the children were encouraged to label their cassette tapes with care, otherwise problems occurred. The system that worked best was to give each group a cassette tape of their own which they marked with the following information: child's and/or children's names; a phrase to describe the topic; and the

document name in inverted commas.

Unfortunately you are given only one chance to save a document. If you use a faulty cassette tape the document is lost. So another useful feature when saving documents would be the opportunity to save a second copy as a safety precaution.



To save a document all you do is press Escape and answer the question 'Return to main menu y/n?'. If you answer yes the next instruction is 'Record and Return'. This is misleading and my pupils made the mistake of not pressing play as well. The instruction 'Press Play and Record then Return' would be better.

Using the cassette tape system is slow and in fact loading in the documents is the most time-consuming part. Fortunately *Edword* offers the use of a disc file system, though I have yet to use it.

## Conclusion

Having used *Edword* with children I believe it has a lot to offer education and the advantages far outweigh the disadvantages (see *Good Features* box). A particularly reluctant writer asked if he could come to school at 8.30am to use *Edword*. No lunch hour passed without a request to use it. In the words of the children: '*Edword* is a very interesting and useful program' and 'It will always be a popular work piece'. It is a superb and powerful tool to enhance the work going on in any primary classroom.

*The author is deputy head of Courtwood Primary School, Croydon*

137

## GOOD FEATURES OF EDWORD

**Easy to use** – The keyboard is used in a similar way to a typewriter. The keys are the child's pen and the screen his paper. Single-key depressions are most frequently used. Special key depressions such as Shift and Control characters are not needed. Text can be easily corrected, inserted, deleted and edited.

**Mnemonic commands** *Edword* makes excellent use of the BBC micro's function keys. When children are being taught editing skills, and are introduced to the function keys they are easy to use and to remember. To go to the top of the document, for example, you press Command and T for top.

**Display width** – There is a choice of 40 or 80-column text with the BBC B. The 40-column screen is useful for younger children, as the text is large and clear. The 80-column measure closely matches normal textbook width when the document is printed.

**Screen-based** – It is useful to know that what you see on the screen will appear as hard copy. Not all wordprocessing systems have this feature.

**User-friendly** – A useful 'error help' system has been incorporated. This involves a beep sound if an error occurs. If f4 is pressed a simple error message appears at the bottom of the screen. This message disappears on the next keystroke.

**Screen information** – The top of the screen gives you continuous information, including document name, mode, page, line and column that the cursor has reached, left and right margins, tabs and indents. Other indicators include print, underscore and overtyping.

The bottom of the screen gives error help messages. 'Safety' prompts are sometimes given – for example confirmation before losing a document from the screen.

**Wordwrap** – An excellent feature of *Edword* is the automatic wordwrap. This means you can type in a document at high speed without worrying about the ends of lines. Words that will not fit on the end of a line are automatically taken to the next line. Thus no unsightly lines with part-words occur.

**Justifying text** – The neatness and presentation of a document is naturally important. To achieve this *Edword* supplies four features. Text can easily be 'justified' so that text aligns down the right hand margin as well as the left. This gives a professional look to the children's work as this is how it appears in their text books as well as newspapers. *Edword* also offers the facilities of underscoring (underlining) and wide and bold text.

**Indenting** – This is a particularly useful feature especially if children produce a picture to go with their writing. Indenting enables the user to leave a space for a picture to be inserted into a piece of writing. The length of the lines can be altered and script can be set around the perimeter of the picture.

**Format** – Neat pages of text can be created by setting the format mode. Top and bottom margins can be set as well as left and right ones. Within the format mode up to six tabs can be set, the page length can be altered and line spacing can be single or double.

# THE PRINTED WORD

## LOW PRICES

## TOP SERVICE

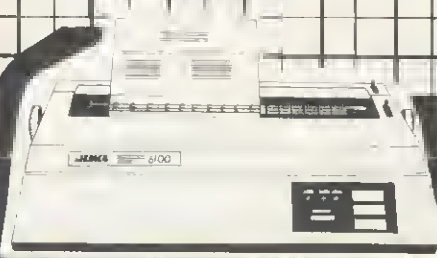

### JUKI 6100

One Year Warranty  
 20 CPS : BiDirectional & Logic Seeking  
 10, 12, 15 & Proportional Spacing  
 Wordstar Compatible  
 2K Buffer : 13 Inch Platen  
 Underline : Backspace + Lots more  
 Centronics Interface Standard  
 RS 232 Interface £54.00 + VAT Extra  
 Tractor Feed £99.00 + VAT Extra  
 Single Sheet Feeder £238.00 + VAT Extra

**JUKI 6100 £330.43 + VAT = £380.00**

**BBC/ORIC or DRAGON Package**  
**JUKI 6100 + C.J.E. PRINTER PACKAGE**  
**£400.00 inc. VAT**

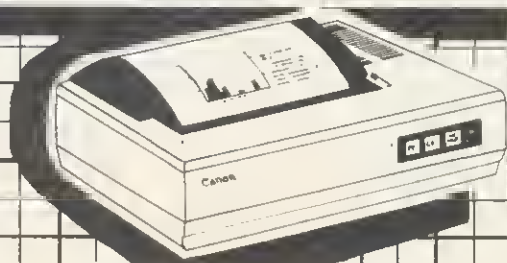

### CANON PW-1080A

**Near letter Quality Printer**  
 NLO Mode 23 x 18 Matrix: 27 cps  
 Draft Mode 11 x 9 Matrix: 160 cps  
 Full range of Epson FX 80 Print Codes  
 Friction & Tractor Feed  
 Centronics Interface Standard  
 CANON PW-1156A (Accepts 15" Paper) Available

**CANON PW-1080A £278.26 + VAT = £320.00**  
**CANON PW-1156A £360.00 + VAT = £414.00**

**PACKAGE PRICE for BBC MICRO/DRAGON/ORIC**  
**CANON PW-1080A C.J.E. PRINTER PACKAGE £345.00 inc. VAT**  
**CANON PW-1156A C.J.E. PRINTER PACKAGE £439.00 inc. VAT**

**Special RS 232 Printer Bargain**  
**STAR DP8408 (8" Printing) £187.00 inc. VAT**  
 Ideal for BBC/Newbrain/HX20 & Spectrum Int. 1  
 Phone for full specification

**C.J.E. Micro's BBC Printer Packs**  
 For Star, Canon & Juki Printers include:

1. The Printer
  2. Delivery by Securicor
  3. Cable to the BBC 1.3 Metres
  4. Screen Dump Program (M/C Source)
  5. Text Dump Program
  6. Function Key set up Program. For use with WORDWISE
  7. Function Key Label Printing Program. For use with above.
  8. VIEW Printer Driver
  9. 100 Sheets of Paper
  10. Mains Plug with 3 Amp Fuse
  11. Booklet giving details of using the printer with a BBC.
  12. Character Defining Program for Downloadable-character-set
- C.J.E. Printer Packs for other micro's include:-  
 Printer, Cable, Paper, Mains Plug & Delivery

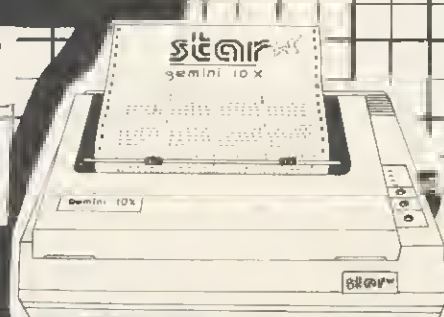

### STAR GEMINI 10X

One Year Warranty  
 True Descenders 9 x 9 Matrix  
 120 CPS Bidirectional & Logic Seeking  
 40, 48, 68, 80, 96, 136 cpl  
 Italics, Emphasized, Double strike,  
 Super & Sub Scripts  
 Downloadable Character Set  
 Hi-Resolution & Block Graphics  
 Friction or Tractor Feed  
 10 X 10" Carriage, 15 X 15" Carriage  
 Centronics Interface Standard  
 RS232 Int. £52.00 + VAT Extra

**Gemini 10X £235.00 Inc VAT**  
 Package for BBC/DRAGON/ORIC  
**GEMINI 10X + CJE Printer Pack £255 inc. VAT**  
 Star Gemini 15X £380 inc. VAT

**STAR DELTA 10**  
**SPEC. AS FOR 10X PLUS:-**  
**100CPS: 8K BUFFER**  
**CENTRONICS + RS232 INT'S STD**  
**£311.30 + VAT = £358.00**

### BBC MICRO MODEL B £399.00

#### Electron £199.00

**BBC Micro Model B with Disc Int. £469.00**

Large Range of Accessories including Disc  
 Drives, Printers, Monitors always in stock

#### Printer Cables

BBC to 36 Way Centronics Type Connector £15.00  
 Dragon to 36 Way Centronics Type Connector £15.00  
 Orc to 36 Way Centronics Type Connector £15.00  
 Torch to 36 Way Centronics Type Connector £20.00

#### Serial Printer Cables

BBC to 25 way D type £9.50  
 EPSON HX20 to 25 way D type £9.50  
 NEWBRAIN to 25 Way D Type £12.00  
 25 way D type to 25 way D type £11.00

Blank C15/C30 Cassettes Ten for £4.50 ANY MIX  
 Send SAE for Full Price List

**VAT INCLUDED WHERE APPLICABLE**  
**PHONE/CREDIT CARD ORDERS WELCOME**

Postage 50p per order or as stated  
 24 Hr Securicor Delivery  
 for Printers/Disk Drives £8.00  
 (SHOP/WORKSHOP CLOSED MONDAYS)

### C.J.E. Microcomputers

DEPT (AU), 78 Brighton Road, Worthing  
 W. Sussex BN11 2EN (0903) 213900

**EXPORT ORDERS WELCOME**

**RING FOR SAMPLE PRINTOUT, FULL SPECIFICATIONS & LATEST PRICES**  
**BEST PRICES & BACKUP ON THE STAR JUKI & CANON PRINTERS**



# NOW GRAPHS AND CHARTS ARE EASY!

## WITH **BEL GRAPH** FROM **BEL TECH** FOR **BBC, ELECTRON** AND **SPECTRUM**

POWERFUL, SOPHISTICATED YET MENU DRIVEN AND EASY TO USE and INCREDIBLE VALUE FOR MONEY!!!

- \*\* AUTOMATIC SCALING and DRAWING OF AXES \*\*
- \*\* \*\*
- \* DATA ENTRY FROM KEYBOARD OR FILE (4 FIELDS X, Y, Z, T)
- \* SELECT DISC DRIVE (where applicable)
- \* SORT on 'T' or  $\Theta$  FIELD
- \* ACCEPT/REJECT RECORDS and FIELDS on DATA ENTRY
- \* EDIT
- \* SAVE FILE
- \* SCREEN DUMP FACILITY (or combine your own)
- \* RENAME FIELDS
- \* DEFAULT VALUES for WEEKS/MONTHS
- \* LINE GRAPHS
- \* BAR CHARTS/HISTOGRAMS
- \* PIE CHARTS
- \* VERTICAL BAR CHART
- \* COMBINED BAR/PIE CHART
- \* ENTER EQUATIONS IN X, Y or PARAMETRICS X, Y,  $\Theta$
- \* ANGLES IN RADIANS or DEGREES
- \* PLOT X $\Theta$ , Y $\Theta$ , YX, Z $\Theta$ , XZ, YZ etc.

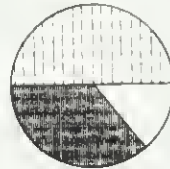
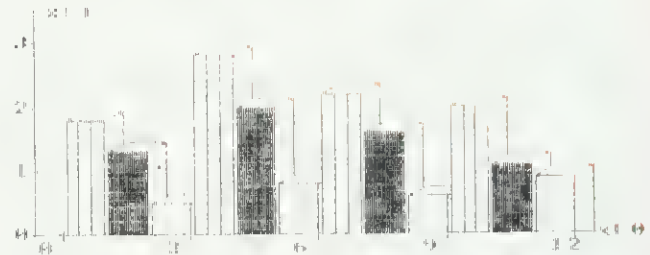

TOTAL <54.0%>  
 ADULT <34.1%>  
 CHILD <15.9%>



**BEL TECH**  
Software



COMPATIBLE WITH BEL BASE and MAILSHOT (Disc) and capable of READING DATA from ANY FILE in stated FORMAT.

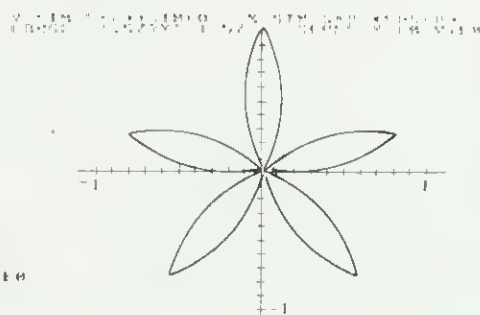
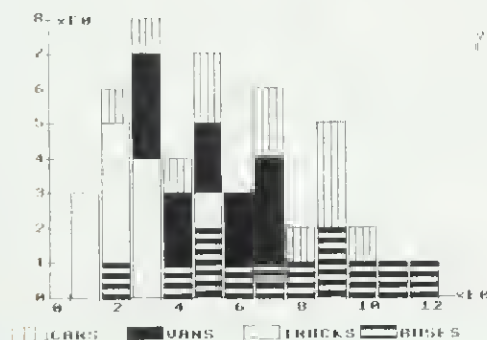

Order Form	TAPE		DISC		TOTAL
	QTY		QTY		
BEL BASE	16.00		18.00		
BEL GRAPH	15.00		17.00		
BEL CHEM Chemistry 1	9.50		11.50		
Chemistry 2	9.50		11.50		
BEL GEN Genealogy	15.00		17.00		
MAIL SHOT	9.50		11.50		
BEL PLOT	9.50		11.50		
BEL SUBS	10.50		12.50		

**TOTAL inc. P. & P. £**

NAME \_\_\_\_\_

ADDRESS \_\_\_\_\_

COMPUTER TYPE \_\_\_\_\_ MODEL \_\_\_\_\_

DISC (if applic.) \_\_\_\_\_

CREDIT CARD NO. PAYMENT BY CHEQUE PO VISA ACCESS

Please Complete & Return to:-

BEL TECH Limited, Stanmore Industrial Estate, Bndgnorth, Shropshire WV15 5HP or

Telephone: 07462 5420 (24 Hrs.)

**BEL BASE, MAILSHOT and BEL GRAPH**  
form a superb integrated package for Business, Reports, Clubs, Accounts, Education etc.

NOW ON ROM £49 (Start Tape/Disc Data Files)  
YOU CAN UPGRADE CHEAPLY LATER!!!

Simple, reliable, and still the most popular  
word processor for the BBC Micro.

Price **£46**  
inc.

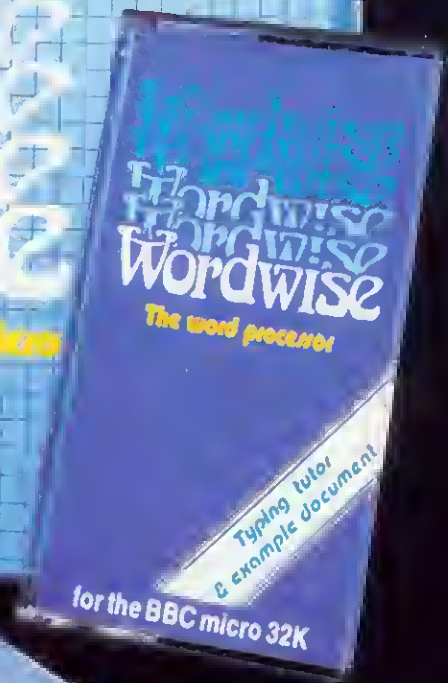
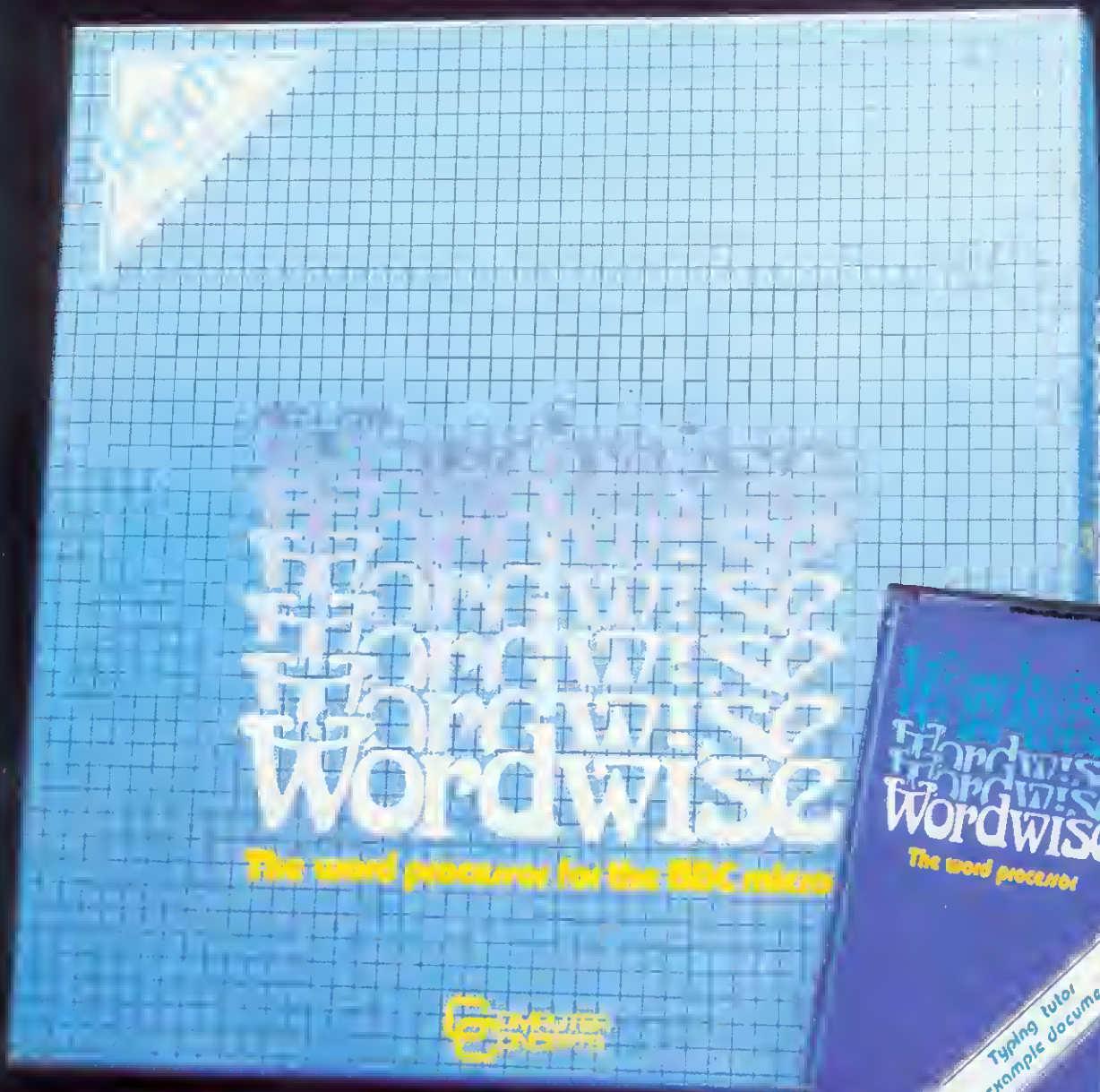

**COMPUTER  
CONCEPTS**

Available from all good BBC Computer Dealers.  
Available by Mail Order from Computer Concepts, Gaddesden Place, Hemel Hempstead,  
Herts HP2 6EX.  
Or by phoning with your credit card number on (0442) 63933.

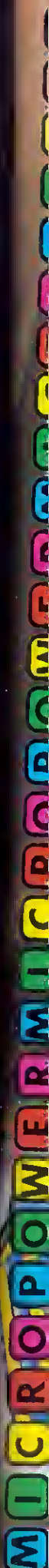
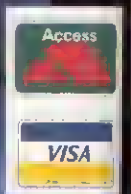



M I C R O P O W E R M I C R O P O W E R M

FROM THE AUTHOR OF THE TOP SELLING FELIX IN THE FACTORY

# PLUTONIUM PLUNDER

Clear a path through the vault and shove the Radioactive Plutonium cannisters behind the safety barrier before all hell breaks loose and the Megapods and oscillating Nuclids appear. Cassette: £6.95. Disk: £9.95.



FOR THE  
B.B.C. MICRO



M I C R O  
P O W E R

MICRO POWER LTD.,  
NORTHWOOD HOUSE, NORTH STREET,  
LEEDS LS7 2AA TEL: (0532) 458800  
MICRO POWER SOFTWARE IS AVAILABLE FROM  
SELECTED BRANCHES OF WH. SMITH, BOOTS, JOHN  
MENZIES, CO-OP, WOOLWORTHS AND ALL GOOD  
DEALERS  
AUTHORS! WE PAY 20% ROYALTIES!

"WATCH OUT  
FOR THE FANTASTIC  
NEW PACKAGING!!"



M I C R O P O W E R M I C R O P O W E R M



# QUALITY NEVER LOOKED SO GOOD—

Now everyone with a BBC or IBM PC will want to get their paws on CUB's sleek new D series plastic cabinet — a triumph of ergonomics and up to the minute design. Within it is the CUB 653 MEDIUM RESOLUTION colour monitor — the perfect mate for computer users who wish to combine the advantages of brilliant, low cost colour graphics with 80 column processing software.

CUB 653's remarkable depth of colour is enhanced by minimal screen glare, thanks to a super high contrast CRT. Even in well lit environments the 653 (H) x 585 (V) resolution and 0.43mm dot pitch produces 80 column text which is pin-sharp and easy to read. Owners of SHARP, RML 480Z, APPLE Series, WANG and other leading computers needn't feel left out, because CUB 653's compatibility extends to these models and many more.



**PICK ONE UP FOR JUST £299 inc. VAT**

**NEW LOW PRICE, NEW PLASTIC CABINET — THERE'S NEVER BEEN A BETTER TIME TO BUY.**

Standard Resolution version also available in new cabinet. Both Standard and Medium resolution models produced in metal cabinets if required.



**VITEC 653 CUB COLOUR DISPLAYS**

Microvitec PLC, Futures Way, Bolling Road, Bradford, BD4 7TU, West Yorkshire  
Tel: (0274) 390011 Telex: 517717

Available from High Street Computer Retailers and selected branches of W. H. Smith, Harrods, John Lewis Partnership, John Menzies with selected models available from larger branches of Boots.



# BANISH KEYBOARD HEADACHES FOR EVER



with  
**QUINKEY**  
- for just **£49.95**

## LEARN TO USE QUINKEY WITH NO OBLIGATION!

Send for Quinkey now, and you should be touch-typing in less than an hour. Before you know it, you'll be typing much faster than you write.

So confident are we of our claim that we'll give you a no fuss money back guarantee. If you're not happy - FOR ANY REASON - you can simply send it back within 14 days for a full and prompt refund.

### KEYBOARD DATA

Quinkey has five main keys which are pressed in combinations. Signals are sent on release of keys. With the addition of the control key Quinkey takes over all inputs except "break" from the BBC keyboard or can be used in conjunction.

Quinkey casing is made from sturdy FR ABS. Professional quality keys and gold cross point microswitches will give heavy-duty performance.

### SOFTWARE DATA

When invoked using CHAIN "WP" or CHAIN "PROG", loads at the current PAGE value and moves PAGE up by 768 bytes. No zero-page locations required. Interrupt service vector 1RQ2V, correctly chained. PROG may be incorporated into users' programs without difficulty.

### INTERFACE DATA

Quinkey's interface to the analogue port of the BBC is a four-channel connector which allows up to four Quinkeys to be used simultaneously with one micro. (For further information about the Educational Pack of four Quinkeys and schools software, tick the appropriate box in coupon)

### TESTED COMPATIBILITY

BBC model "B" OS 1.2 BASIC I or BASIC II (unless using INKEY with negative argument), DFS 0.90. View A1.4, Wordwise 1-17, Edword.

FOR COMPREHENSIVE REVIEW OF QUINKEY SEE ACORN USER, SEPT '84

Send the coupon now to take advantage of our special money-back guarantee!

Microwriter Ltd, 31 Southampton Row  
London WC1B 5HJ Tel: 01-831 6801

## THE REMEDY FOR "MICRO FATIGUE" - THE ONLY ALTERNATIVE FOR SERIOUS BBC USERS.

Having to face keying a lengthy piece of data is pretty daunting, but that's nothing compared to how you feel when you're only about a quarter the way in.

It's about then that eyestrain and headache combine to make you feel like the many-headed hydra, and the ache in your back makes you envy a packhorse.

And it's all because you're forced to "hunt and peck" amongst 74 keys on a keyboard that's over a hundred years old. Eyes torn between document and keyboard, up to the screen and back to the document - it's no wonder you're losing your place and errors and bugs start creeping in.

## QUINKEY PUTS THE PLEASURE BACK INTO USING YOUR COMPUTER

- Quinkey is a keyboard which you simply plug into the analogue port of your BBC computer.
- You can be touch-typing in less than ONE hour. Quinkey uses the technique of Microwriting - practised by thousands of professionals in their working lives.
- Quinkey is operated with only one hand and comes with a long lead, so you can sit back and relax.
- Because you don't need to look at the keyboard - "hunt and peck" - your eyes are free to read data, either from screen or document - accuracy and speed become simple.
- With Quinkey there's no need to lose your place either - your other hand is free to follow data.
- Whether your work is with words or programs, Quinkey is a must. It can even double as a fast and accurate keypad for mass numeric data.

## YOU'LL BE AMAZED AT WHAT YOU GET FOR £49.95

Quinkey is sold as a complete package ready to be used right away with your computer. Each pack for the BBC contains:

- Quinkey keyboard
- Interface and lead to analogue port of BBC
- Easy to follow self-teach guide
- "PROG" software (a utility program which interprets Quinkey signals to the BBC and gives you a comprehensive alternative/additional keyboard - all inputs except "Break". It merges easily with your application programs)
- "WP" enables you to fully use software such as "Wordwise", "View" and "Edword" for fast and accurate word-processing.

**microwriter**  
**QUINKEY** To: Microwriter Ltd., 31 Southampton Row,  
London WC1B 5HJ

I would like to take advantage of your special money-back guarantee and realise that I can return the pack(s) undamaged within two weeks of delivery if I am not fully satisfied for a complete refund.

Please send: .....Quinkey pack(s) @ £49.95 (plus £2.50 p&p) £.....  
.....More information about the educational pack of 4 Quinkeys and software for schools.

I enclose a cheque made payable to: "Vector Marketing/Microwriter Ltd." for £..... or debit my Visa/Access credit card No.....

Signed.....

Name.....

Address.....

.....AU.11.84

Please allow up to 28 days for delivery. Reg. no. 137 4069

# Salamander

## SOFTWARE

### BBC and ELECTRON Software

#### SIMULATIONS

##### 737 Flight Simulator £9.95

Written by a professional 737 pilot, this bestselling simulator emulates a high performance jet airliner. Full instrumentation and hi-res graphics. Please specify Tape, Disk, or Electron version.

*"Certainly the best flight simulator I have flown. Full marks to Salamander." — Acorn User*

#### ADVENTURES

##### Franklin's Tomb £9.95

Can you, as Dan Diamond P.I., solve the riddle of the crypt, or will you fall prey to its mysteries as many others before you have done. Fully illustrated Case File. BBC only.

*"Worth every penny. This will become a classic — Popular Computing Weekly.*

*Program of the Month — Computer Choice.*

##### Lost in Space £9.95

The sequel to Franklin's Tomb. Can you escape from the derelict space ship, or will you be trapped forever with bored security robots and chatty doors. Fully illustrated Case File. BBC only.

#### SPECIAL OFFERS (BBC only)

**Eagle** £4.95  
Original Arcade Game

**Dragon Rider** £3.95  
Arcade Game

**Tanks!** £3.95  
Armoured Warfare for two

**Games Compendium B1** £3.95  
Simon, Fireman, Hangman, Alphabet Soup

**Games Compendium B3** £3.95  
Mole, Boot Hill, Bomber

#### EDUCATIONAL

##### French Tutor £9.95

Up to and beyond 'O' level standard. Tests vocabulary, speech idioms, and irregular verbs. Create your own files; progress assessment and revision lists available at any time. BBC only.

##### Graphs £9.95

A suite of five programs for use by students studying CCE at 'O' and 'A' level or equivalent syllabus. Includes versatile curve sketching, parametric curve sketching, an interactive multiple choice and multiple choice tests for recognition of straight line equations and trigonometric, quadratic and cubic curves. BBC/ELECTRON.

##### Vectors £14.95

A suite of fourteen programs carefully designed to teach the user the skills and techniques associated with the main vector algebra requirements of a syllabus such as CCE examinations in Additional Mathematics and 'A' Level Mathematics as well as many other courses requiring a knowledge of vector algebra. BBC/ELECTRON.

#### UTILITIES

##### EDG Graphics Package £19.95

A sophisticated drawing system allowing the user to build up simple drawings or complex designs. BBC only.

##### EDG Graphics Package (disk) £24.95

The disk version of the graphics package contains all the features of the tape version. Also includes an EPSON Printer Dump and Teletext Screen Editor. BBC only. Requires Acorn DFS.

##### Electron Graphics System £9.95

A version of the EDC Graphics System rewritten specifically for the ELECTRON.

##### Utilities Package £9.95

Four essential aids: Sound Shaper, EPSON Printer Dump, Teletext Screen Editor, and Disassembler. BBC only.

### SAVE £1

If you return this voucher with your order you will be entitled to a £1 discount on the order. Only one discount per order.

You will also become a member of the Salamander Software Discount Club. This entitles you to further discounts on future orders, as well as free posters, stickers and T-shirts (subject to availability). This offer applies only to products ordered by direct mail from **Salamander Software, 17 Norfolk Road, Brighton BN1 3AA.**

Please make cheques and postal orders payable to Salamander Software.

Please rush me the following:

Title ..... Price

.....

.....

.....

Less Discount ..... £1.00

Total .....

Name .....

Address .....

.....

Post Code .....



# BBC Microcomputer in the NORTH

CTECH Computers Telephone: 061-366-8223/7794

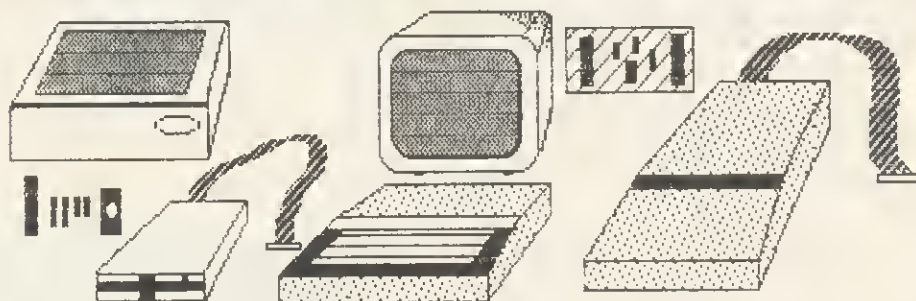

Computers	£ p
88C Model 8	346.95
88C Model 8 with DFS	407.82
88C Model 8 with DFS & Econet	439.00
88C Model 8 with DFS & Wordwise	433.92

Acorn Equipment	£ p
6502 2nd Processor	173.04
Z80A 2nd Processor	346.95
Teletext Adaptor	199.00
Electron Computer	173.04
Electron + 1	51.30

All computers come with Free Cassette Lead and Software Package. Most add-ons include free fitting and installation.

Monitors	£ p
Philips Hi Res	68.69
Microvitec Normal Res	199.00
Ferguson TX-90 RG8/TV	199.00
Kaga Normal Res	179.00
Kaga Medium Res	285.00

## DISKETTES



Boxes of 10 diskettes  
 BASF s/s d/d diskettes £13.00  
 BASF d/s d/d diskettes 96 TPI  
 £20.78  
 XIDEX diskettes £15.22  
 Control Data d/s d/d 96 TPI  
 £19.91  
 Control Data s/s d/d 96 TPI  
 £14.74

Masterclass Video Tape. Dur  
 price £8.95

Addons	£ p
HCR Electronics RDM/RAM board	36.52
HCR Electronics Eprom programmer	49.00
Light Pen	21.69
DEL 200 Prestel Terminal	87.39
Acorn Speech Synth	47.83
Chip Chat Speech Synth	26.04
Pace Grapevine	POA

Light Pens and Joysticks	£ p
Add on Light Pen	21.70
JMB Full Analogue Joystick	13.00
Joystick Pairs	17.35
Hi-Fi Extension Cable	5.17
Atari-type joystick to 88C interface	13.00

Components and Cables	£ p
We stock everything e.g.:	
2764 Eprom	6.52
27128 Eproms Low	
B271 Eproms	POA
Printer Cables	12.99
Disk Power Cables	8.65

ROM Software	£ p
Wordwise	34.74
Graphics RDM	28.65
Print Master	28.65
View 2.1	52.09
Ultra-Calc	56.48
1.2 O.S.	10.00
Disk Doctor	28.65
BCPL	86.09
Termi	28.65
Commstar	30.39
Viewsheet	52.09
Beebugsoft Toolkit	23.48
Spellcheck	17.35

**TEC CHINON**  
**DISKDRIVES FROM £95.00 + VAT**  
 Bare CHINDN F051D, Slimline, 40 Track, Single Sided. 100K (200K Double Density). As above but complete with Cables, Utility Disk, Cables, Case and Manual. **£109.00 + VAT**  
 Bare TEAC55F, Slimline, 40/80 Track, Double Sided 400K (800K at Double Density). **£169.00 + VAT**  
 As above but complete with Cables, Utility Disk, Cables, Case and Manual. **£199.00 + VAT**  
 TEC Disc Drives from **£109.00 + VAT**

**TEC CHINON**  
**DUAL DRIVES FROM £199 + VAT**  
 Dual CHINON F051D, Slimline, 40 Track, Single Sided 2 x 100K (2 x 200K Double Density). Complete with Cables, Utility Disk, Cables, Case and Manual. **£369 + VAT**  
 Dual TEAC 55F, Slimline, 40/80 Track, Double Sided. 2 x 400K (2 x 800K with Double Density). Complete with Cables, Utility Disk, Cables, Case and Manual. (With your drive you may need an interface). **£389.00 + VAT**

**ACORN**  
**DISK INTERFACES FROM £69.00 + VAT**  
 The Fabulous LVL Single and Double Density Interface. This will allow you to read and write to Acorn Disks see below. But also you can create your own Single OR Double Density Diskettes for extra online storage. Maximum capacity is 1.6 MB with 8 logical drives and 248 files. The standard Acorn Interface is available from us this uses the B271 disk controller which gives very fast access to disk files. Acorn DFS is the standard for the BBC Micro it allows 31 files per disk and a maximum of 800K on 4 logical drives. Phone for latest prices.

**CANON NEC QUEN**  
**PRINTERS**  
 CANON PW 10B0A. This is the latest state of the art in printer technology. This machine out performs the EPSON FX80. It will do everything the FX80 does and more besides and using the same control codes! What makes the PW10B0A so special is not only its superb value for money but the near LETTER QUALITY mode. We include a free screen dump and our BBC Micro Instructions as well as the excellent manual. **£259 + VAT**  
 DUEN 5100 Daisywheel. This British assembled printer has all the features that you would expect like Auto Bold, Auto Underline Sheet Feeder option. Take Oume daisywheels and Ribbons. 20Cps Bi Directional. **£299 + VAT**  
 NEC PC-8023N Dot Matrix Printer  
 8i-directional (120 cps), tractor and friction bed. **£199.00 + VAT**  
 DUEN DATA Dot Matrix Printer (Epson Compatible). British assembled. **£173.04 + VAT**

**PRICES . . .**  
 All our prices are constantly moving, so please ring us to check the latest price.  
*All prices plus VAT*

**FREE DELIVERY TODAY**  
**(Orders over £90)**  
**ASK ABOUT OUR INSTALLATION SERVICE**  
 If you are in Greater Manchester, Cheshire, Lancashire, Midlands, Merseyside, West Yorkshire or South Yorkshire, if you ring us now we can send one of our highly trained staff to install your computer equipment today.  
*(Now for business software too!)*



**C ★ TECH**  
**COMPUTERS**  
**184 Market Street,**  
**Hyde, Cheshire**  
**SK14 1EX**  
**061-366 7794**  
**061-366 8223**

# HAVE YOU ALREADY GOT DISK DRIVE(S) FOR YOUR BBC COMPUTER?

## SOLIDISK HAS SOMETHING TO OFFER.

— FOR THOSE OF YOU WHO DO HAVE ALREADY, A DUAL FDC DISK FILING SYSTEM (DFDC, using the old 8271 and adding the new WD1770 FDC), ADDS DOUBLE DENSITY AND KEEPS TOTAL COMPATIBILITY (See opposite page).

— FOR THOSE WHO HAVEN'T, A DUAL DENSITY DISK FILING SYSTEM (using the new WD 1770) WILL PROVE MUCH FASTER AND CHEAPER THAN THE 8271.

### THE DISK DRIVE:

The disk drive (see pictures) comes from the new series VLSI ultra quiet, auto spin-up, 5.25" half height, solenoid head load, 40/80 track, single and double density MIT-SUBISHI M4853. It is fast, quiet and consumes far less power than any previous models. 2 new 64 pin surface mounted microcontrollers (from Motorola and Mitsubishi), largely reduce the area occupied by the drive electronics (see pictures), leaving so much more room for the diskette, with very low noise level and reduced friction of the media and the jacket.

### SOLIDISK DUAL DENSITY DISK FILING SYSTEM.

Basic characteristics include very high operating speed, Acom compatibility, automatic 40/80 track switching, auto-density, resident disk formatter and 100% compatibility with Solidisk Sideways RAM.

It is also the simplest ever Disk Upgrade for the BBC computer: with only 4 components: 1 ROM, 2 buffers and the FDC. (See picture 3).

Solidisk software engineers have built in to the 8192 bytes of the 1.40 ROM more facilities than any other DDFS manufacturer has managed before.

The result is a substantial cost reduction, which is passed on to you.

Solidisk engineers won't stop there.

But let's first answer some more immediate questions.

### 1 — SINGLE OR DOUBLE DENSITY?

You get 60% more storage in double density mode than in single density mode at no extra cost.

In single density — the usual Acom disk format — you get 10 sectors or 2.5 k bytes of storage per track. That is what the Acom DFS and many others can do.

In other words, you get 100k with a 40 track single sided disk drive (such as the TEAC 55A), 400k with a double sided 80 tracks disk drive (such as the one in this offer).

In double density, you get 16 sectors or 4k bytes per tracks, an increase of 60%.

With the same TEAC 55A disk drive, you get 160k instead of 100k or with the disk drive in this offer, you get 640k bytes instead of 400k.

The majority of software tested also runs FASTER in double density mode than in single density mode, especially Wordwise, View, Masterfile and Scribe and 95% + of games are also compatible with double density.

### 2 — INSTALLATION:

As the STL DFS consists of only 4 ICs, to be plugged into existing sockets on the BBC computer board, installation is quite simple and should not take more than a few minutes even if you are a novice. Simply instal the 4 ICs into their sockets and connect the disk drive (see picture 4).

### 3 — BASIC DISK SYSTEM COMMANDS AND UTILITIES:

- \*ACCESS <afsp> (optional L)
- \*BACKUP [source drive] <dest. drive>
- \*COMPACT (optional <drive>)
- \*COPY <source drive> <dest. drive> <afsp>
- \*DELETE <fsp>
- \*DIR <dir>
- \*DRIVE (optional <drive>)
- \*ENABLE
- \*F40 (optional <drive>)
- \*F80 (optional <drive>)
- \*INFO <afsp>
- \*LIB (optional <dir>)
- \*LOAD <fsp> (optional <load address>)
- \*RENAME <old name> <new name>
- \*SAVE <fsp> <start> <end> <exec>
- \*TITLE <title>
- \*VERIFY (<optional <drive>)
- \*WIPE <afsp>
- \*BUILD <fsp>
- \*DISC
- \*DUMP <fsp>
- \*LIST <fsp>
- \*TYPE <fsp>
- \*DDFS

### THE SPECIAL PACKAGE DEAL:

A COMPLETE 640K DISK OUTFIT AT ONLY £209.95 INCLUSIVE:

- ONE 80 TRACK DOUBLE SIDED DISK DRIVE.
- ONE DOUBLE DENSITY DISK INTERFACE.
- ALL LEADS AND MANUAL.
- WORD PROCESSOR.
- ELECTRONIC SPREADSHEET.
- SPELLING CHECKER.
- DATABASE.
- STOCK CONTROL.
- MACRO BASIC.
- FULL ONE YEAR NO QUIBBLE WARRANTY.

Optional extra:

- DFDC instead of DDFS: £10.00.

Other OS commands include LOAD, SAVE, BPUT, BGET, OSFILE, BLOCK GET, BLOCK PUT, OSARGS, OSFIND, PTR, OSWORD 7F, 7D, 7E etc.

Care is taken in the disk directory presentation, showing the disk size and other useful information. Whenever a diskette is being spun, its number of tracks and density are identified. This information helps the DFS to skip alternate tracks if a 40 track disk is in use in an 80 track drive and also switch the FDC to single or double density.

The net result is exceptional response and user-friendliness.

Outstanding speed too.

As shown in the benchmark test on the opposite page.

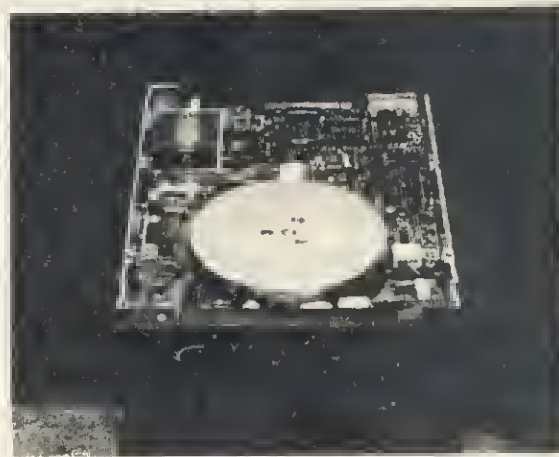



# CUT THE COST OF RUNNING YOUR MACHINE

Solidisk DDFS comes with free bundled software: (see picture 5).

- Solidisk Database — a fast, efficient and flexible disk based random access database. Ideal for prescription records, club membership etc.
- Solidisk wordprocessor.
- Solicalc electronic spreadsheet.
- Stock Control — very useful for small commerce. Features include menu driven, easy to follow operating instructions, stock items can be grouped by categories, by suppliers, by frequency of movements etc. Stock valuation report (inventory), sale price list, reorder forms can be printed automatically as requested.
- Silexicon — the most successful spelling checker with English, French and German dictionary. Self dictionary generating capability.
- Macro Basic — a BASIC program generator capable of using bits of old programs to create new programs. Simply ingenious!
- Benchmark for disk drive and disk utilities.

## 4 — OUTSTANDING PERFORMANCE:

The table below shows the benchmark timing for STL DDFS 1.4. The benchmark consists of disk operations such as save and load a 16k program, open and close files, BPUT, BGET strings and numbers, lormal and verify a disk etc., and is available upon request, otherwise listed in Solidisk DDFS User Manual.

The benchmark tests B1 to B9 are the same as used by many reviewers. The time is expressed in seconds and parts of 100th of a second. The disk drives are twin 40/80 track double sided MITSUBISHI M4853, the diskettes are Verbatim Datafile MD 557 series, 96 TPI, double density, double sided, pre-verified to ensure that the media is free of all error and mechanical defects and containing solely the benchmark program. The test is loaded into memory, the drive motors are allowed to stop completely 2 seconds between tests, 10 timing samples are taken and the mean time is calculated automatically.

For example

100 DEFFN1:REM Save a 16k program.

110 T% = TIME

120 \*SAVE A 8000 + 4000

130 - TIME - T%

Full listings are included in the User Manual.

This FN is called 10 times with 3 sec. interval, the mean result is printed as 'B1'

BENCHMARK DESCRIPTION	S/D TIME	D/D TIME	
B1 Save 16k	2.62	1.43	
B2 Load 16k	2.45	1.23	
B3 Openin and close 100 times	20.70	20.16	*See note 1
B4 Openout and print 1000 numbers (255)	5.84	4.66	
B5 Openin and input 1000 numbers (255)	4.72	4.14	
B6 Openout and print 100 80 bytes strings	6.18	4.91	
B7 Openin and input 100 80 bytes strings	4.90	4.31	
B8 BPUT 100 bytes (255)	3.01	2.06	
B9 BGET 1000 bytes (255)	1.88	1.52	

Note 1: Whenever a file is to be opened, STL DDFS automatically refreshes the disk directory, thus preventing erroneous disk change. Many other DFS's do not take the same care, although yielding a much shorter time, and this could accidentally stop the program.

With Wordwise:

Load 2000 words (17811 bytes) 16.80 sec. (41.40 sec. with AC.

With Scribe:

Count 2000 words (17811 bytes) 4.20 sec. (9.80 sec. with AC.90 DFS)

With Beebug's Masterfile:

Sort records 1 to 20 in PEOPLE sample database, the database is presorted on field 2 then the

program is asked to sort on field 1, the time is then taken: 56.23 sec. (127.86 sec. with AC.90 DFS).

These timings are improved even further in double density mode.

The figures speak for themselves.

STL DDFS dramatically increases the operating speed of your software, including wordprocessors like Wordwise, View, Scribe, databases like Masterfile, Starbase etc.

Solidisk engineers won't stop there.

## ONE ROM TO RULE THEM ALL

Already a super mini floppy (2.4 MB) and controller for under £400, a 10MB integrated Winchester hard disk for under £600 AND AN EVEN MORE POWERFUL 16K ROM (2.0 UPGRADE) with outlined specifications below are planned for Christmas.

- Unlimited number of entries into the disk directory.
- File size and disk size can be as big as 16MB.
- Immediate recovery of accidental file deletion.
- Built in wordprocessor in place of the classical \*BUILD.
- Disk sector editor, disk search and replace, tape to disk, disk to memory below PAGE, disk duplication.
- Instant data encryption and decryption using 256 byte single key (expandable).
- Quadruple FDC drivers (8271, 8272, WD 1770, WD 2793).
- RAM Disk facilities for Solidisk Sideways RAM.

## 6 — SOLIDISK DFDC:

THE ONLY SYSTEM TO ADD DOUBLE DENSITY AND KEEP COMPATIBILITY.

If your BBC is already fitted with Acorn Single Density DFS, you can ADD double density to your system and KEEP the existing DFS with Solidisk DUAL FDC Filing System (DFDC).

Solidisk DFDC system overcomes the problems caused by around 5% of the games 'specially those produced by Acornsoft newest releases such as Elite). These programs (directly) controls the 8271 thus requiring its presence.

Solidisk DFDC ROM controls BOTH FDC at a flick of a switch, you can choose the new FDC for speed or the old 8271 for Acornsoft game disks.

OPERATIONS	S/D TIME	D/D TIME
FORMAT 40 TRACKS:	17.74	17.74
FORMAT 80 TRACKS:	33.22	33.22
VERIFY 40 TRACKS:	9.30	9.30
VERIFY 80 TRACKS:	17.84	17.84
BACKUP 01 80 TRACKS:	37.69	37.69
BACKUP 02 80 TRACKS:	39.46	39.46
COMPACT 100K-10 FILES	22.42	18.82

## 7 — PRICES (including P and P and VAT)

STL DDFS (disk chip upgrade for BBC B)	£39.95
STL DFDC for those who have Acorn DFS	£49.95
640k DISK OUTFIT (complete package)	£209.95
1.3MB DISK OUTFIT (with twin drives)	£359.95
2.0 ROM Upgrade (available soon)	£10.00

To order, you can use the coupon, Access and Barclaycard holders can ring direct:

## HOW TO ORDER?

You can order any item using the coupon. Prices are inclusive of VAT, post and packing. Access and Barclay card holders can place their order by phone. Educational authorities, Acorn dealers and OEMs can obtain quantity discounts.

Name: .....

Address: .....

Credit Card Account:

Callers are requested to ring first for appointment.

Total:

**SOLIDISK TECHNOLOGY LIMITED**  
**17 SWEYNE AVE**  
**SOUTHEND-ON-SEA**  
**ESSEX SS2 6JQ**

**SOLIDISK'S NEW TELEPHONE NUMBER: SOUTHEND (0702) 354674 (10 lines)**

# SOLIDISK SIDEWAYS RAM: 25,000 UNITS SOLD

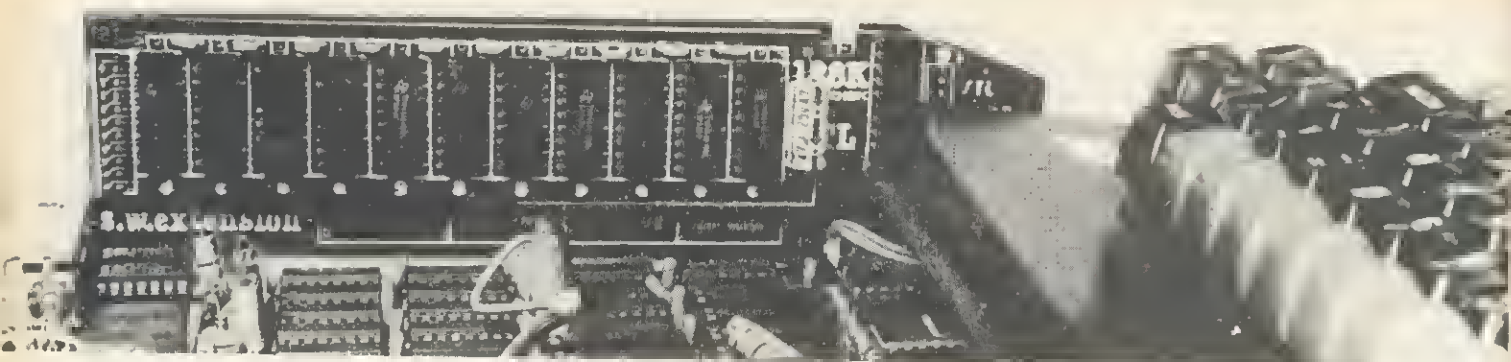

"Exciting" (ACORN USER JAN 84), "Power to your Beeb" (PCN 61, MAY 84), "Break the RAM Barrier" (A&B)

## HAS YOUR BBC COMPUTER GOT ITS SIDEWAYS RAM BOARD YET?

Not surprisingly many BBC computers have got their sideways RAM boards. Solidisk Sideways RAM can be completely integrated into the BBC computer system: with 6502 and Z80 second processors, Torch disk pack, teletext, Econet and Solidisk 8— sideways ROM expansion board.

Adding Sideways RAM to the BBC computer is simple. And it will multiply the machine's power.

Here is how.

### 1 — HOW DOES IT WORK?

Occupying the same place as sideways ROMs (such as BASIC, DFS etc) it is treated like other sideways ROMs and therefore can replace them.

Sideways RAM can run any language, and filing system, wordprocessors, databases etc.

### 2 — WHAT SORT OF SOFTWARE DOES IT RUN?

Better than sideways ROM, sideways RAM can be written into. This property makes it not only possible to run the same programs as their ROM counterparts but sideways RAM can be used as Virtual Memory, RAM disc, printer buffer, Basic program store, 65-C-02 assembler, zero RAM, take DFS etc, etc . . .

### 3 — WHAT OTHER SERVICES DO YOU GET WITH ALL SIDEWAYS RAMS?

Solidisk sideways RAM comes with lots and lots of free software (see list on opposite page). As a sideways RAM user, you will be able to get updated disks\*, free local expert advice and free bi-monthly newsletters to keep you informed. Solidisk spend more than 1,000 man hours every month to produce free software for all sideways RAM users. More and more free software will be available every month.

### 4 — WHO USES SIDEWAYS RAM?

Solidisk sideways RAM is widely used in schools for ECONET, by programmers to develop new software, in small business systems for wordprocessing and database\*\* and now at home, even for games. New applications are being found every day, such as moving screen memory to Sideways RAM (essential for increasing memory for VIEW and VIEWSHEET), Colour Imaging System, Teletext page logger and generator, computer typesetting etc.

Sideways RAM is such a versatile and flexible instrument that it will renew your interest continually.

### 5 — WHICH SIDEWAYS RAM DO YOU NEED?

Solidisk sideways RAM is available in multiples of 16k, each replacing a sideways ROM. Units are in 16k, 32k, 128k and 256k.

The first step is to evaluate your needs.

Then consult the chart opposite.

You can buy a small unit to start with, and exchange it later for a larger one. Extra costs involved with upgrading are minimal. The SWR16, 16k sideways RAM is adequate for most simple tasks (running common programs or for Econet slave stations), including fast disk copying with a single disk drive.

**For wordprocessor:** using VIEW or WORDWISE, a SWR32 will do. Large documents (20 page plus) will require something like SCRIBE and the 128k or 256k Solidisk\*\*.

**For database,** unless very high speed is required, a SWR32 will suffice for most popular databases such as Beebase, Fileplus, Starbase, Datagem. Otherwise use the 128k or 256k Solidisk\*\*.

**Remember** — the more memory you instal inside the BBC computer, the more power you will get out of the machine.

All sideways RAM units come complete with 60+ page Sideways RAM User Manual, 1 utility diskette and 1 year warranty.

\*\*Solidisk recommends SCRIBE and STARBASE because they exploit perfectly the inherent speed of RAM disc. Quite often, some users try to solve a software problem (such as increasing the size of Wordwise) by a hardware solution (buying the 128k Solidisk). The better way is to buy Merlin's Scribe (or wait until we offer you one similar for free) and then increase its speed with the Solidisk. The situation regarding databases is much simpler as Solidisk works well with most of them (from 6 times speed increase with Beebug's Masterfile to 2 times with Starbase).



UVIPAC EPROM ERASER

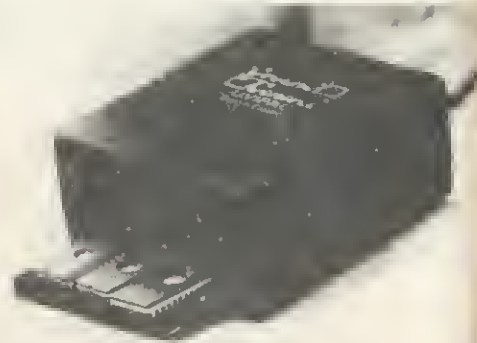

TEAC DISC DRIVES FD55 Series

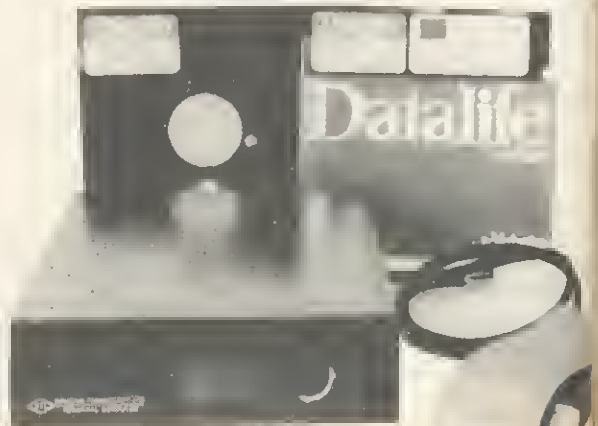



## 6 - SENDING FOR FREE SOFTWARE:

Our free software is divided into volumes and is available in single density, either 40 or 80 track 5.25" diskettes. 40 track diskettes contain only 1 volume, 80 track diskettes contain 2 consecutive volumes, (1+2, 3+4, 5+6, etc.)

All sideways RAM is supplied with 1 diskette, containing either VOL. 1 (40 tracks) or VOL. 1+2 (80 tracks) as requested. Extra volumes are charged for media and postage cost.

The following volumes are available at the present time:

- VOL. 1: General Utilities: Menu, STLDISC, STLOEOO, STLRFS, Printer Buffer, STLRFS, Quickly, Fastbackup, Keyboard, Word64, help.
- VOL. 2: English Spelling Checker: Suilexicon and English dictionary (15000 words).
- VOL. 3: BASIC program generator: Macro Basic. Never Bad Mode again: Virtual Memory.
- VOL. 4: Database: Solidisk Datafile.
- VOL. 5: Foreign Language Dictionary Generator: Silexigen, Silexicon source code for programmers.
- VOL. 6: French spelling checker (15,000 words).
- VOL. 7: German spelling checker (13,000 words).
- VOL. 8: Machine code tools: Solimon, the finest machine code monitor with Disassembler, debugger, single step etc. for both 6502 and 65-C-02 (for second processor 65 C 02 assembler (for second processor), UVIPROM control software, SPRITES and SPRITE generator (providing 60 sprites per 16k sideways RAM).
- VOL. 9: to be released in October: Solidisk Toolkit, Rubber band, and Z80 drive C (RAM disc facilities for Acorn Z80 second processor).
- VOL. 10 to 19: Source code for use with the Technical Manual.

## 7 - TECHNICAL MANUAL:

THE TECHNICAL MANUAL contains extensive program listings and notes by their authors. It also covers the MACRO language programming (part of Macro Basic), MOS conventions for sideways software. Solidisk conventions for sideways RAM software, STL DFS entry points, the 65C02 programming facilities and schematic diagram.

The Technical Manual package consists of the Technical Manual and 3- 80 track diskettes containing VOL. 10 to 15 and costs £10.00.

## 8 - LOCAL EXPERT HELP:

A list of Solidisk experts is printed in the Sideways RAM User Manual. For the cost of a local call, they can certainly help you with installation of software advice. Potential experts are warmly invited to contact us.

## UVIPROM EPROM PROGRAMMER AND UVIPAC EPROM ERASER

The UVIPROM EProm programmer, which plugs into the user port, allows the user to program 2764 and 27128 EPROMs, either from disc or master ROM. The unit is self-contained, complete with built-in Vpp generator and system software. Commands available are:-

- \*TEST - blank test for new (or erased) EPROMs.
- \*BLOW<aspf> - programs EPROMs from disc.
- \*COMP<aspf> - compares programmed EPROMs with source on disc.
- \*VIEW - displays hex and ASCII dump.
- \*READ<aspf> - reads contents of EPROM to disc.

### UVIPAC-EPROM ERASER:

Mains powered EPROM eraser, can erase up to 3 EPROMs of any size in only 15 minutes. Housed in a custom moulded plastic case, with optical fibre indicator.

## SOLIDISK ANNOUNCE THE MOST EXCLUSIVE SUPPORT FOR THE 65-C-02!

Have you heard about the 65-C-02?

This is the CPU that Acorn has retained for their second processor. The 65C02 has an extended instruction set, with 43 brand new OPCODEs for you to play with. Things as PHY, PLY, STA (&A6), STZ, BRA, TRB etc can save 20% of memory and increase speed by 20-25%.

**SOLIDISK GIVE YOU FREE\* SPECIALLY DEVELOPED SOFTWARE FOR THE 65C02!**

(\*except media)

**65C02 PATCH:**

Using DEFFN such as DEFFN ("PLY"), extra instructions are added to the present BASIC assembler.

**65C02 BASIC2 OVERLAY:**

Providing you have a sideways RAM unit, this program will turn your BASIC2 instantly into 65C02 assembler. You do not have to type in 'OPT FN("PLY")' but simply 'PLY' instead, making the conversion job a piece of cake.

**SOLIMON, THE ONLY 65C02 MACHINE CODE MONITOR:**

This program can be softloaded into Sideways RAM or obtainable in ROM form. It has everything the popular EXMON has such as Disassembler, Find bytes/string, set ROM socket, spool, move, hard copy etc and also some 'impossible' features such as defining zero page location that will be used, single stepping sideways RAM, screen modes. More importantly, it works with the 65C02 and can even disassemble the second processor ROM!

IN VIEW OF THE LARGE DEMAND FOR THIS CHIP, SOLIDISK OFFERS IT AT ONLY £11.00 + £1.00 FOR POST AND PACKING

THE ABOVE SOFTWARE IS AVAILABLE FROM US AT ONLY £2.50 TO COVER THE MEDIA COST OF THE DISKETTE. NO EXTRA POSTAGE WILL BE CHARGED IF ORDERED AT THE SAME TIME AS THE 65C02 CPU.

(It is understood that enquiries about the 65C02 CPU should be sent directly to us rather than to RCS, the Rockwell distributor.)



Connect the control wires

### PRICE LISTS AND ORDERING (including P&P and VAT)

SIDEWAYS RAM	
SWR16	£43.65
SWR32	£59.95
128K SOLIDISK	£150.95
256K SOLIDISK	£257.95

The following are upgrade prices for existing Sideways Ram Users	
16 - 32 (return complete item)	£19.00
16 - SOLIDISK (return item)	£110.00
16 - SOLIDISK 256 (return item)	POA
32 - SOLIDISK	£95.00
32 - SOLIDISK 256 (return item)	POA
128 - 256 (return item)	£125.00

DFS AND DISK DRIVES	
STL DDFS DISK UPGRADE	£39.95
DFDC Twin FDC version	£49.95

MITSUBISHI 2x80 (incl leads+manual)	£163.00
MITSUBISHI TWIN (incl leads+manual)	£323.00
65C02	£12.00
65C02 software	£2.00

COMPLETE SYSTEMS (i.e. DRIVES + DDFS)	£202.95
MITSUBISHI 2x80 640K bytes	£353.00
MITSUBISHI TWIN 1.3 MB.	

DISKETTES (DataLife Verbatim boxes of 10)	
SS/DD 40	£17.00
DS/DD 40	£23.00
SS/DD 80	£24.00
DS/DD 80	£29.00

EPROM PROGRAMMER (use with Swr or Solidisk)	£20.95
UVIPAC EPROM ERASER	£20.95
2764 PACK OF 5	£36.00
27128 PACK OF 3	£39.95

### HOW TO ORDER?

You can order any item using the coupon. Prices are inclusive of VAT, post and packing. Access and Barclay card holders can place their order by phone.

Educational authorities, Acorn dealers and OEMs can obtain quantity discounts.

Name: .....

Address: .....

Credit Card Account: .....

Callers are requested to ring first for appointment.

Total: !

**SOLIDISK TECHNOLOGY LIMITED**  
**17 SWEYNE AVE**  
**SOUTHEND-ON-SEA**  
**ESSEX SS2 6JQ**

**SOLIDISK'S NEW TELEPHONE NUMBER:**  
**SOUTHEND-ON-SEA (0702) 354674**  
 (10 lines with automatic exchange)

# DEBUG<sup>®</sup>

New



**MACHINE CODE  
EDITOR/DE-BUGGER  
FOR THE BBC  
MICRO**

**£39.95**  
inc VAT  
(plus 55p p&p)

DEBUG is the most sophisticated machine code monitor yet produced for the BBC Microcomputer. This ROM based Language/Utility is fully compatible with Acorn Tubes (requires 1.2 OS).

To order, please send cheque/P.O. for £40.50 enclosing your full name and address, or telephone and quote your ACCESS/VISA number.

## Micro choice

159 Havant Road, Drayton, Portsmouth, Hants. (0705) 327591  
Dealer enquiries welcome.

# The SOURCE

THAT'S WHERE TO GET IT!

## SERIOUS SOFTWARE SOURCE CATALOGUE

Software to do a job - not to play with! Our new catalogue not only lists but gives a description of each program. Business, Education, Scientific, Engineering, Radio Computing, Statistics and many other subjects.

FREE

## BOOK SOURCE CATALOGUE

From Artificial Intelligence to Xenix! If you need to know more about almost any subject to do with Computing then this is for you. Perhaps the most comprehensive specialist book catalogue ever compiled.

FREE

## C/PM & MS-DOS SOURCE CATALOGUE

A range of professional software from some of the worlds most experienced software houses, for the new operating systems now available on the BBC B.

A description is given of each program.

FREE

## GIFT VOUCHER SERVICE

Do you know exactly what to buy as a gift? Why not give one of our Gift Vouchers? - Vouchers start at just £10 - then they can choose their own gift from any of our comprehensive catalogues!

Send your name, address and requirement, plus £1 (to cover postage) - For your free catalogue.

## The Computer Mail Order People

David Winrow Marketing, Unit , PO BOX 9,  
Northwich, Cheshire CW9 7TP.

# CARE ELECTRONICS

UNIT 14, PEERGLow INDUSTRIAL ESTATE, OLD'S APPROACH, TOLPITS LANE, RICKMANSWORTH, HERTS.

☎ TELEPHONE: 0923 777155 ☎ 01 950 0195

## \*\*\*\* ROM MODULE SYSTEM \*\*\*\*

\*\*\*\* HERE IT IS JUST RELEASED \*\*\*\*  
THE CARE ELECTRONICS LOW PROFILE  
ROM MODULE SYSTEM

- \* Superb styling.
- \* Low Profile.
- \* Avoids damage to BBC from changing Roms constantly.
- \* Easy to use and install.
- \* Prices lower than any other Rom System.

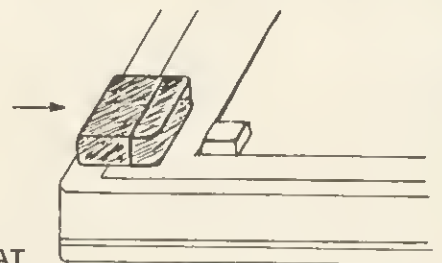

CARE

TEL: 0923 777155  
01 950 0195

ELECTRONICS

Complete Kit  
Spare Cartridge  
5 Cartridges  
10 Cartridges

@ 17.25c Inc VAT  
@ 4.37c Inc VAT  
@ 20.70c Inc VAT  
@ 39.10c Inc VAT

For larger quantities consult our factory at the above telephone no.  
\*Please note our cartridges are totally compatible with the Viglen Rom System.

### HOW TO ORDER:

By Post. Enclose your Cheque/P.O. made payable to: CARE Electronics.  
Or use your ACCESS. Allow 7 days for delivery. Please add carriage.





# CARE ELECTRONICS

UNIT 14, PEERGLOW INDUSTRIAL ESTATE, OLD'S APPROACH, TOLPITS LANE, RICKMANSWORTH, HERTS.  
 TELEPHONE: 0923 777155 01 950 0195

**TEAC & TEC SLIMLINE DRIVES**  
**SINGLE DRIVES CASED:**  
 40/80 Track 200K Switchable TEAC 55 @ 164.91a  
 40/80 Track 400K Switchable TEC @ 178.94a  
**DUAL DRIVES CASED:**  
 40/80 Track 400K Switchable TEAC 55 @ 329.82a  
 40/80 Track 800K Switchable TEC @ 357.88a  
**INTEGRAL POWER SUPPLY:**  
 Fitted to any of the above drives @ 26.45b  
**POWER SUPPLY UNIT:**  
 @ 32.20b  
 ★ Colour finished to match BBC.  
 ★ 6 pin BBC Outlet or Dual Power lead for disk drive. (Please specify when ordering)  
**FLOPPY DISCS: (Boxes of ten)**  
 3M'S D/Sided D/Density 5.25" @ 27.37c  
 3M'S S/Sided D/Density 5.25" @ 15.18c  
**PRINTER STAND:**  
 @ 13.11c  
**Full Twelve Months Guarantee.**

**PHILIPS 14" COLOUR TV/MONITOR:**  
 @ 234.60a Inc VAT.  
**PHILIPS 14" COLOUR TV:**  
 @ 184.00a Inc VAT.  
**RGB CONVERSION KIT:**  
 (Please telephone for details)  
 @ 38.64c Inc VAT.

**LEADS "READY-MADE"**  
 6 pin DIN to 6 pin DIN plug (RGB) 1.5mt @ 2.99c ea  
 6 pin DIN to 6 pin DIN plug (RGB) 2mt @ 3.45c ea  
 6 pin DIN to 6 pin DIN plug (RGB) coiled cable @ 6.90c ea  
 6 pin DIN plug to 6 pin DIN skt (RGB) extension @ 2.99c ea  
 BBC Power 6 way to Disc Drive 4 way 1.5mt @ 3.45c ea  
 BBC Power 6 way to Disc Drive 4 way 2mt @ 4.14c ea  
 BBC Power 6 way to 2 Disc Drive 4 way 1.5mt @ 4.60c ea  
 Monitor lead BNC to PHONO 1.2mt @ 3.45c ea  
 Monitor lead T.V. to PHONO 1.2mt @ 2.99c ea  
**RIBBON LEADS:**  
 Disc Drive single 1.2mt @ 6.67c ea  
 Disc Drive dual 1.2mt @ 10.12c ea  
 Printer 1mt @ 7.82c ea  
 Printer 1.5mt @ 11.27c ea  
 Parallel 26-26 pin @ 7.59c ea  
 Parallel 26-26 pin @ 8.74c ea  
 Parallel 26-26 pin @ 9.43c ea  
 Serial 25 pin D type plug each end 2mt @ 12.88c ea  
 Serial 25 pin D type plug each end 5mt @ 15.18c ea  
**CONNECTORS:**  
 BBC Power 6 way housing Plugs: @ 0.35c  
 BBC Crimp Terminals @ 0.08c  
 Disc Drive 4 way housing @ 0.29c  
 Disc Drive Crimp Terminals @ 0.10c  
 Various Din Connectors @ 0.40c  
**DISC INTERFACE PARTS:**  
 E'Prom HITACHI HN482764G Inc VAT @ 9.20c ea  
 Low power Schottky 74LS10 @ 0.48c ea  
 Low power Schottky 74LS38 @ 0.48c ea  
 Low power Schottky 74LS123 @ 1.21c ea  
 Low power Schottky 74LS393 @ 1.43c ea  
 C'Mos 4013BCP @ 0.70c ea  
 C'Mos 4020BCP @ 1.00c ea  
 We also stock a wide range of electrical Components, i.e. I.C's/Caps/Connectors etc.

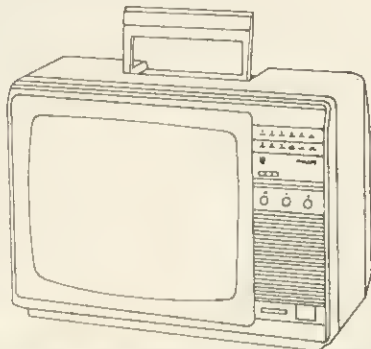

**DON'T BUY A COLOUR MONITOR!!**  
**HAVE YOUR 14" & 16" PHILIPS or PYE**  
**COLOUR TV CONVERTED TO A TV/MONITOR**  
**"ONLY" £49.91a inc VAT.**

- ★ Image clarity comparable to leading monitors.
- ★ Includes RGB lead for connecting with BBC.
- ★ Conversions carried out at our workshops within 2/3 days.
- ★ Please telephone for other makes.

## CARE ELECTRONICS presents: CPX2 "X" SWITCHER

- Changing leads becomes a thing of the past!!!*
- ★ 26 pin (As BBC) 2 Micros driving 2 Printers at the same time
  - ★ Can be used as a "T" Switcher.
  - ★ All outputs BUFFERED enabling longer leads between units, in excess of 20 metres.
  - ★ No strain on your BBC power supply, as the "CPX2" comes complete with its own internal power supply.
  - ★ Easy to install and operate.
  - ★ Colour Finished to match BBC.
  - ★ Supplied with moulded mains plug.
  - ★ 12 Months Guarantee.

**"ONLY" 85.10b Inc VAT.**

**PRINTER SELECTOR:** @ 65.09c Inc VAT.  
 ★ 26 Pin as BBC ★ 1 Micro to 3 Printers.

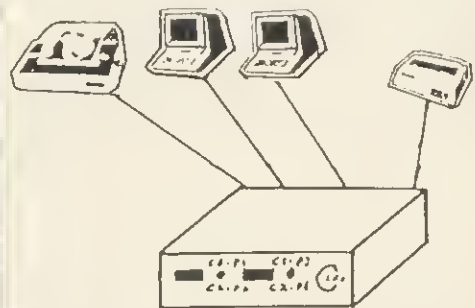

RS232 "T" SWITCHER: @ 55.20c Inc VAT.  
 RS232 "X" SWITCHER: @ 65.09c Inc VAT.

**MAINS FILTER 5 amp:** @ 45.08b Inc VAT  
 ★ Noise and Transient Filter.  
 ★ 4 Socket outlets.  
 ★ Moulded mains plug.

TEL: 0923 777155

### HOW TO ORDER:

By Post. Enclose your Cheque/P.O. made payable to: **CARE Electronics.**  
 Or use your ACCESS. Allow 7 days for delivery. Please add carriage.

- a) @ 8.00
- b) @ 5.00
- c) @ 2.00



# Synergy Software

## PROFESSIONAL SOFTWARE FOR THE BBC MICRO

### EASILOT

EASILOT is a sophisticated AND user friendly graph package for the BBC Micro, placed 14th in the top 20 Educational packages by the leading Educational Computing Magazine. EASILOT has also come to be regarded as an 'outstanding business package' and 'excellent value for money'.

Note:- EASILOT 3 comes complete with the number charting program DATA PLOTTER with graph magnification, colour and moving average facilities. SUPERB VALUE AT £22.95.

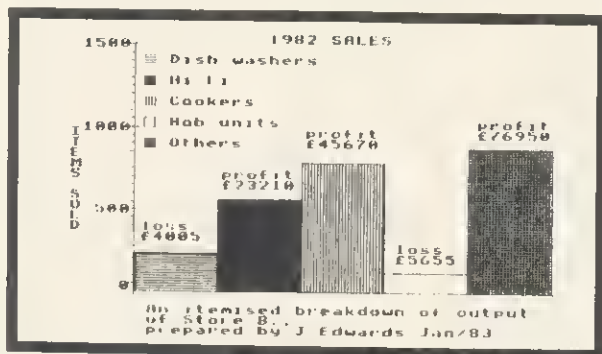

#### EASILOT FACILITES

#### DISK CASSETTE

Line, Bar and Pie Charts	YES	YES
Auto & Manual Scaling	YES	YES
Grid & Scatter Options	YES	YES
No of simultaneous graphs	5	3
Overwrite memory	YES	NO
Screensave facility	YES	YES
Screendump facility	YES	YES
Fixed description per graph (char's)	up to 200	100
Full plot and axis editing	YES	YES
Save, Load & *CAT facilities	YES	YES
Single file selection	YES	NO
Operating Manual (pages)	52	52

All our programs will produce hard copy on the following printers:- EPSON (entire range), Shinwa CP80, Star DP 510, Seiksha (GP80A & GP100A). Share Analyser will produce reports on any BBC compatible printer.

PLEASE NOTE:- Our programs CANNOT BE OBTAINED FROM YOUR LOCAL DEALER so send for details NOW.

PROGRAM	PRICE
Data Plotter (cassette) .. Model B & Electron	£7.00
Data Plotter (disk) .. Model B	£8.00
Easiplot 1 (cassette) .. Model B & Electron	£15.95
Easiplot 2 (disk only) .. Model B	£19.95
Easiplot 3 (including Data Plotter-disk only)	£22.95
Share Analyser (cassette) .. Model B & Electron	£14.95
Share Analyser (disk only) .. Model B	£19.95

Disk orders .. please state 40 or 80 track (add £1 for 80 track and £1.50 for overseas orders). We will upgrade Easiplot 1 to Easiplot 2 for £7 (£10 to Easiplot 3).

Write for full details of all our programs or leave your name and address with our Answerphone service (Luton 33858). All programs are normally despatched within 24 hours.

Send cheque/P.O. etc to

Synergy Software, 7 St Andrews Close, Slip End, Luton, LU1 4DE.

### SHARE ANALYSER

SHARE ANALYSER is a sophisticated portfolio reporting and share analysis package designed for the small investor. The disk version has a capacity of 20,000 SHARE PRICES and up to 320 buy/sell deals covering 20 share names. Share Analyser has facilities for profit flexing and multiple merging of graphs and a variety of selectable indicators. **SHARE ANALYSER IS A MUST FOR THE INVESTOR AT A BARGAIN PRICE.**

#### PROFIT STATEMENT

NAME BRITISH PETROLEUM		
DEALINGS		
Bought	Av Price	Cost
600	338	2028
Sold	Av Price	Income
300	426	1278
Held	Curr Price	Mkt Valn
300	438	1314
	Gross Profit	564
	Income	257
	Expenses	101
	Net Profit	720
		% Gain = 36

#### SHARE ANALYSER FACILITIES

#### DISK CASSETTE

No of prices stored	20,000	Appx 1700
Max no' of Holdings	20	20
Transactions per holding	16	16
Range adjuster	YES	NO
File Manager	YES	NO
Printer Manager	YES	NO

#### REPORTS PRODUCED:-

Portfolio Valuation	YES	YES
Portfolio Profit Analysis	YES	YES
Share Profit Analysis	YES	YES
Share Movement Analysis	YES	YES
Transaction Record Report	YES	NO
File Status Report	YES	NO

#### GRAPHICS FACILITIES:-

Magnification option	YES	YES
Grid	YES	YES
Autoscale	YES	YES
Screenwrite	YES	YES
Screendump	YES	YES

#### SELECTABLE GRAPHICAL INDICATORS:-

Lagged Moving Average	YES	YES
Centred Moving Average	YES	YES
Rise and fall indicator	YES	YES
Weekly/Daily Low indicator	YES	YES
Superimpose Facility	YES	YES



# THREE NEW PROGRAMS FROM MICROTEST

## DAIRYFILE FOR DAIRY FARMERS

Keep on that economic line between over and under feeding!

Save time recording milk yield and calculating feed amounts!

Quickly decide feeding policy with the 'Monthly Calving Group' Performance Graph!

Print out a recording sheet with cows in numerical order. Print out graphs or tables of individual cows or Monthly Groups showing serving and pregnancy details, illness record, Calving Index, weekly and running total Margin over Concentrate. See at a glance cows due for serving, pregnancy diagnosis and drying off. Keep track of weekly total feed cost and milk sale price.

All this and more with DAIRYFILE.

Predict cow or Monthly Group total lactation yield. Compare with Standard Lactation Curves. All old data preserved—compare Monthly Groups over the years. Which is the most profitable month?

Find out with DAIRYFILE - for up to 200 lactating cows

£69.00 inc. VAT (disc only) + p&p 50p

2 x 40 Track Drives Required or 1 or more 80 Track Drives. Please state which when ordering.

## SATAN'S CHALLENGE or (Nevil Rides Out)



### A Black Magic Adventure

Dare you take up the challenge laid down by the most evil and sinister of all beings - the devil himself. If you do you will find yourself alone and at the mercy of the twisted fancies and whims of a cold and calculating mind.

Occult forces are threatening the lives of those near and dear to you. Their only salvation rests in your hands but in accepting the challenge your own existence is put in severe peril.

In taking up the challenge you have to find The TALISMAN and locate a pentagram which then has to be prepared for the final rite. In the meantime dark forces will be opposing you making a difficult task almost impossible.

Do not allow yourself to be lulled into a sense of security for it will be short lived. Many have gone before only to swell the ranks of the damned.

This is the latest adventure from the stables of Microtest and has been written with the acclaimed features of other adventures in mind eg save facility, quick response, simple but extensive commands, a mixture of logical and fiendish problems to solve.

**Be warned this is an easy adventure to get into but devilishly difficult to end.**

Cassette £7.95 inc. VAT Disc £9.45 inc. VAT + p&p 50p Disc 40 or 80 Track

## MICROTEST FONT ROM

This exciting new ROM from Microtest will enable you to get all sorts of new characters and fonts from your BBC Computer. Once you have produced your masterpiece on the screen, all you have to do is use the inbuilt screendump utility to produce a hard copy on to paper.

Typing \*HELP FONTS gives you a list of available fonts and the blocks of characters which they replace.

Available fonts are:

- \*Accents Accents and miscellaneous.
- \*Block Small capitals.
- \*Data Like the bottoms of cheques.
- \*Greek It's all Greek to me too!
- \*Joined Standard capitals with joined up lower case.
- \*Maths A mix of until now unobtainable Mathematical symbols.
- \*Miscellaneous A few oddities which often are very necessary.
- \*Thick Thick text (for MODEs 0&3) to enhance 80 column mode.
- \*Thin Thin text (for MODEs 2&5) which makes modes 2 & 5 much more readable or perhaps "READABLE"
- \*Vertical For labelling graphs in a vertical plane.
- \*Mode 8 10 column multi colour, memory miserly mode.
- \*S Dump A Dump facility which will produce a screen dump of any mode from 0 to 8 (including a text only dump in mode 7) on an Epson, Star, CP80, MT80 or JP80 etc etc. ...

The dump utility will produce negative or positive product, can magnify, and will also rotate the picture through 90 degrees as well as being able to position the picture anywhere laterally across the paper.

The ROM uses absolutely no user memory and can be used with word processors etc, as well as with normal word programs.

£17.50 inc. VAT  
+ p&p 50p

## Microtest Starstick ROM & Joystick Package

Now available the Starstick ROM and Joystick. This comes in three forms:

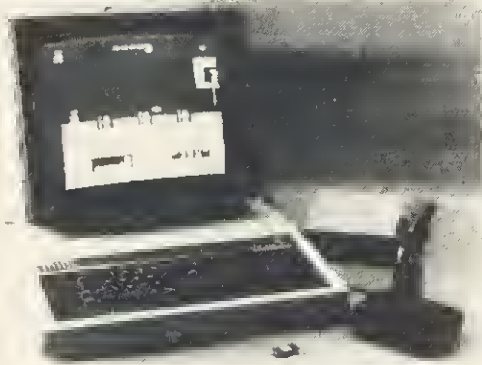

Enables you to use our joysticks even on programs that do not offer joystick capability.

- (A) The Starstick ROM and Quickshot I Joystick  
Price 17.95 + VAT = 19.84
- (B) The Starstick ROM and Quickshot II Joystick  
Price 19.25 + VAT = 22.14
- (C) The Starstick ROM and patch lead, choose your own Spectrum/Atari style joystick  
Price 15.25 + VAT = 17.54

Post and Packing £1.00 inc. VAT per item

This enables you to plug the Rapid action self centring joysticks until now only available for the Spectrum/Atari/CBM machines into the user port of the BBC. Model A users please note NO ANALOGUE INTERFACE REQUIRED.

Disc Users Note - pressing BREAK, SHIFT-BREAK or CONTROL BREAK does not modify or destroy the STARSTICK software so Disc Users please feel free to Boot!

The software patch provided in the ROM is interrupt driven and adds the following commands to your computer.

- \* STICK turn on the STARSTICK ROM
- \* NSTICK turn off the STARSTICK ROM
- \* SETSTICK set up joystick to users spec
- \* SAVE "NAME" 140 160 saves your user-key protocols
- \* ADVAL emulate standard analogue joysticks
- \* PAUSE define key to freeze game
- \* NPAUSE turn off ability to freeze game
- \* "NAME" predefined key protocols set up for software houses programs
- \* HELP KEYS displays currently selected key protocols
- \* REPEAT enables auto-repeat fire
- \* NREPEAT disables auto-repeat fire

DEALER ENQUIRIES  
and  
EXPORT ORDERS  
WELCOME

available from

**MICROTEST LTD**

**18 Normandy Way, Bodmin, Cornwall PL31 1EX**

**Telephone: 0208 3812**

OR ANY GOOD DEALER

Large picture shows BBC Computer System and a Quickshot II Joystick. Small inset just a few of the joysticks that will work with the patch lead. Screenshot by kind permission of SUPERIOR SOFTWARE  
All microtest ROMs are fully TUBE<sup>®</sup> compatible. (TUBE<sup>®</sup> is a reg trademark of Acorn Computers.)

VISA



# Twillstar reliability for HOME

## COMPUTERS

Commodore 64	£175.00
Oric Atmos 48K	£166.00
Sinclair ZX Spectrum 48K	£115.00
Sanyo MBC 55 128K 2 x 160K	
Drives	£914.25
Acorn Electron	£199.00
BBC Model B	£399.00
BBC Model B + Disc Interface	£469.00
BBC Model B + Econet	
Interface	£447.00
BBC Model B + Disc & Econet	
Interface	£517.00
Z80 Second Processor	£399.00
6502 Second Processor	£199.00
Acorn Bitstick	£375.00
Acorn IEE Interface	£325.00
Acorn Electron + One Interface	£59.00
BBC Prestel Adaptor	£132.00
BBC Telex Receiver	£225.00
Amstrad + Green Monitor	£235.00
Amstrad + Colour Monitor	£335.00
Einstein	£499.00

## DOT MATRIX PRINTERS

Anadex DP-6500 500CPS	£2321.00
Anadex WP-6000	£2079.00
Brother EP44	£228.00
Brother HR5	£148.00
Canon PW1080A 160 CPS (NLO)	£289.00
Canon PW1156A 160 CPS (NLO)	£389.00
Texan Kaga KP810	£279.00
Texan Kaga KP910	£389.00
Ensign 1650 165 CPS	£305.00
Epson RX80T 100 CPS	£224.00
Epson RX80F/T 100 CPS	£253.00

Epson RX100F/T 100 CPS	£439.00
Epson FX80 160 CPS	£370.00
Epson FX100F/T 160 CPS	£494.00
Epson LO1500 200 CPS (NLO)	£1029.00
Mannesmann MT80 80 CPS	£199.00
Mannesman MT180 160 CPS (NLO)	£678.00
Newbury DRE8850 300 LPM	£2409.00
Newbury DRE8925 240 CPS	£1592.00
OKI 82A 120 CPS	£293.00
OKI 84A 200 CPS	£724.00
OKI 92P 160 CPS	£379.00
OKI 2410P 350 CPS	£1765.00
Seikosha GP100A	£165.00
Seikosha BP420 420 CPS (110 CPS NLO)	£1255.00
Shinwa CP80 Model 11Ft	£199.00
Star Oelta 10 160 CPS	£378.00
Star Delta 15 160 CPS	£511.00
Riteman Compact 120 CPS, 80 Col, F/T	£228.00
Star Gemini 10X 120 CPS	£228.00
Star Gemini 15X 120 CPS	£334.00
Star Radix 10 200 CPS (NLO)	£516.00
Star Radix 15 200 CPS (NLO)	£631.00
Tec 1550 120 CPS	£534.00
Toshiba TH2100H 192 CPS	£1466.00
Trend 930 200 CPS (NLO, 80 CPS)	£1552.00
Epson 8143RS232 Interface for FX & RX	£43.00
Epson 8148RS232 Interface with 2K Buffer X On/Off	£65.00

## DAISYWHEEL PRINTERS

Brother HR1	£511.00
Brother HR15	£378.00
Brother HR15 Keyboard	£155.00
Brother HR15 Sheet Feeder	£212.00
Brother HR15 Tractor Feed	£71.00

Brother HR25	£631.00
Canon AP400 KSR	£874.00
Daisy Step 2000 20 CPS	£228.00
Oiablo 630 API	£1512.00
Oiablo Sheet Feeder	£563.00
Fujitsu SP830 RO(S) 80 CPS	£1374.00
Juki 6100 18 CPS	£340.00
Juki 6300 40 CPS	£850.00
NEC 2010 Serial 20 CPS	£741.00
NEC 2030 Parallel 20 CPS	£741.00
NEC 3510 Serial 35 CPS	£1321.00
NEC 3530 Parallel 35 CPS	£1321.00
NEC 7710 Serial 55 CPS	£1723.00
NEC 7730 Parallel 55 CPS	£1723.00
Olympia ESW 103	£948.00
Ouendata 20 CPS	
Unidirectional	£228.00
Oume 11/40 RO	£1362.00
Oume 11/55 RO	£1575.00
Oume 9/45 RO	£1782.00
Ricoh RP 1300S	£1029.00
Ricoh RP 1600S	£1368.00
Ricoh RP 1600S Flow Writer 8K	£1436.00
Ricoh RP 1600S Flow Writer 8K IBM PC	£1493.00
Ricoh RP 1600S Sheet Feeder	£527.00
Ricoh RP 1600S Tractor	£158.00
Silver Feed EXP 550 (P) 16 CPS	£655.00
Smith Corona TIP 12 CPS	£224.00
TEC Star Writer F1040 40 CPS	£1029.00
TEC Star Writer F1055 55 CPS	£1420.00
TEC Sheet Feeder	£527.00
TEC Tractor	£158.00
Uchida DWX-305 (S or P) 18 CPS	£264.00
Juki Single Sheet Feeder	£245.00
Juki Tractor Unit	£108.00
Juki RS232 Interface	£55.00
Juki Spare Daisywheel	£16.00

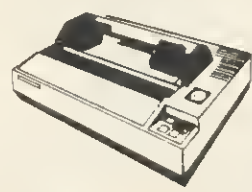

# Twillstar Computers Limited

17 Regina Road, Southall, MIDDLESEX, UB2 5PL. TEL: (01) 574 5271





# ME computer users...and

now

## COLOUR PRINTERS

Canon PJ1080A 7 Colour 40 CPS Ink Jet	£399.00
Seikosha GP700A 7 Colour 50 CPS	£399.00

## PLOTTERS

Mannesman P1XY Plotter	£569.00
------------------------	---------

## MONITORS

Texan Kaga RGB Vision 111 12"	£369.00
Texan Kaga 12"	
HR Green/Amber	£118.00
Microvitec CUB 1431 Stand RES	£199.00
Microvitec CUB 1451 Medium RES	£299.00
Microvitec CUB 1441 High RES	£399.00
Sanyo SCM 14" VHR	£425.00
Fidelity 12MHZ, RGB, Composite	£195.00
Phillips V7001 HR Green Screen with Sound Input	£75.00
Microvitec FOR QL1451 14" Medium Res	£270.00
Novex 14" Colour Monitor	£215.00
Nordmede TV/Monitor 14"	£249.00

## PERIPHERALS

### DISK DRIVES

BBC Single 100K Drive	£99.00
BBC Dual 200K	£189.00
BBC Single 200K 40 Track Double Sided	£159.00
BBC Dual 400K 40 Track Double Sided	£299.00
BBC Single 400K 80 Track Double Sided	£175.00
BBC Dual 800K 80 Track Double Sided	£349.00
BBC Single Power Supply	£20.00
BBC Dual Power Supply	£29.00
Disk Drive for Amstrad	£199.00
Commodore 1541 Disk Drive	£179.00

Oric Disk Drives	£263.00
Sinclair 249K Disk Drives	£229.00

### ADD ONS FOR THE BBC

Spell Check	£19.00
Tool Kit	£27.00
Star Base	£69.00
Disk Doctor	£32.00
Graphics ROM	£32.00
Microtec Cassette	£49.80
Microtec On Disk	£59.85
Grafpad	£132.00
BBC Cassette Recorder	£35.00
Disk Interface (Free Fitting)	£120.00
Games Paddles	£9.95
Econet Interface	£69.00
Speech Interface	£54.00
View Word Processor	£59.00
Word Wise Word Processor	£37.00
Light Pen for BBC	£45.00
Edward User Pack	£44.79
Edward Teacher Pack	£34.44
Edward Commercial Pack	£59.74

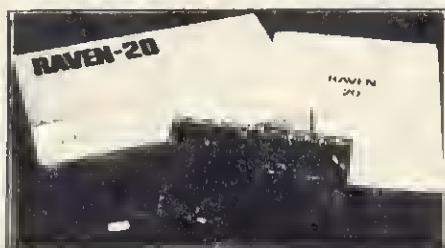

## EXPANSION BOARDS

### RAVEN-20 BOARD

The RAVEN-20 is a 20K RAM EXPANTION for the BBC Micro, Model B, fitted with O. S. 1. 2.

This specially designed product plugs in to the CPU socket of your micro (centre socket of the 3 available) with the minimum of effort. The pins are specially custom made, thus avoiding any possible damage to the circuitry.

The RAVEN board provide the user with an extra 20K of usable RAM in screen modes 0 to 3. This together with the aid of software makes the system completely transparent to both the user and the computer.

The RAVEN-20 software ROM gives

much more than just the standard commands, it has been programmed to give more and better commands! Priced at £69.95 inclusive of VAT. Please add £1.50 for post and packing.

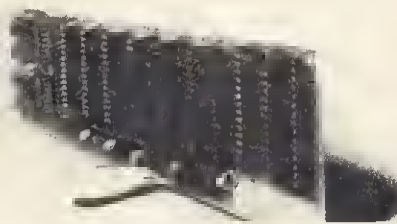

### RAM-ROM BOARD

The RAM-ROM extension board gives an extra 6 sockets for extra ROM's and 2 slots of RAM. This RAM is not an extension of BASIC. It is intended that the RAM be used to develop your own ROM based software. There are in fact seven sockets on the board, the 7th replaces the socket on the main board that would otherwise be taken by the ROM board. (The RAM-ROM board can accommodate both 2764 type EPROMS as well as 27128 EPROMS and ROM.)

The RAMAMP board will not cause overheating. it comes with fully fitting instructions, tested and heat tested before depatch.

Prices: Without RAM fitted £33.50. 1 x 6K RAM fitted £47.00. 2 x 16 RAM fitted £59.00

All prices inclusive of VAT. Please add £1.50 for P&P.

### HOW TO ORDER

You may purchase any of the items listed by cheque made payable to: Twillstar Computers Ltd. Barclaycard or Access. All you have to do is fill in your requirements on a separate sheet of paper, post to us and we will despatch with 24 hours, subject to availability. All prices inclusive of 15% VAT. ADD £2.50 P&P for orders below £150. Over add £8 P&P. Credit card holders may order by telephone. Give card number, name, address and items required. Please note VAT is not charged on export orders. Export customers please ring for details of P&P.

...ask for our Full range!



Open  
6 days a week  
9am to 7pm  
Monday to Saturday



TELEPHONE ORDERS  
(01) 574 5271

# UNBEATABLE VALUE

**£229**  
inc. VAT

## ibico LETTER QUALITY PRINTER

A compact (12" x 2 1/2" x 8"), letter quality printer from Classic Computers with a host of outstanding features at the unbelievable price of £229.00 inc. VAT.

Plugs straight into most computers, with optional adaptors available for Commodore 64 and Sinclair Spectrum. Compatible with BBC A or B and any computer with parallel interface.

- Prints 12 characters per second • Elite type (12 characters per inch) • Bi-directional printing • Logic-seeking • Plain paper — uses your letterheading • Up to A4 size paper • Instant change ink roller • 96 characters, full UK ASCII code • 80 columns • Separate power switch • On/off pilot lamp

FULL 12 MONTHS PARTS & LABOUR GUARANTEE. FULL 21-DAY MONEY BACK GUARANTEE FOR MAIL ORDER CUSTOMERS. CALLERS WELCOME.

### CLASSIC COMPUTERS

A Division of Classic Typewriters Ltd.,

Established over 30 years

5/6 LANSDOWNE HOUSE, CHRISTCHURCH ROAD, BOURNEMOUTH. BH1 3JP. Tel: (0202) 23456

To: Classic Computers, 5/6 Lansdowne House, Christchurch Road, Bournemouth BH1 3JP.

Please supply:

- .... Ibico LTR-1 letter quality printer £229.00
- .... Printer cable for BBC A or B £17.95
- .... Adaptor for Commodore 64 £29.95
- .... Adaptor for Sinclair Spectrum £39.95

I enclose a cheque/P.O. for £.....  
(Plus £3.50 for postage and packing)

Please debit my Access/Barclaycard Card: Expiry

No:           date.....

or telephone your credit card order

Name: .....

Address: .....

Post Code .....

Tel. No.: .....

FOR THE

## AMSTRAD

CPC 464

## ELECTRON BBC

## SUPER VALUE

## SUPER GAMES

ONLY

£4.95

Including VAT & Postage

Versions:  
ELECTRON  
AMSTRAD-BBC

FAST - FUNNY  
& ADDICTIVE

## ER\*BERT

ITS ER\*BERTS CUBIC DOMAIN — AVOID HIS UNWELCOME GUESTS! GRAB THE BANANA — DOUBLE YOUR SCORES — BUT WATCH OUT — BORIS THE APE WILL SOON WANT IT BACK! DROP IT AND RUN — UNLESS YOU'RE VERY BRAVE! AVOID CASCADING BALLS THE MOVING HOLE — AND COILY THE ANACONDA, HE'S GOT A CUDDLE YOU'LL NEVER FORGET! ESCAPE WHEN IT'S REALLY TOUGH BY TRANSPORTER DISC OR ROTA HAT — IF YOU'VE EARNED ONE — MULTIPLE SCREENS — ADDITIONAL CHANGE CUBE COLOUR TASKS. IT'S FUN AT LEVEL ONE — BUT WATCH OUT AT LEVEL TEN! PACKED WITH FUN AND EXCITEMENT — TRY IT YOURSELF. (ALL MACHINE CODE).

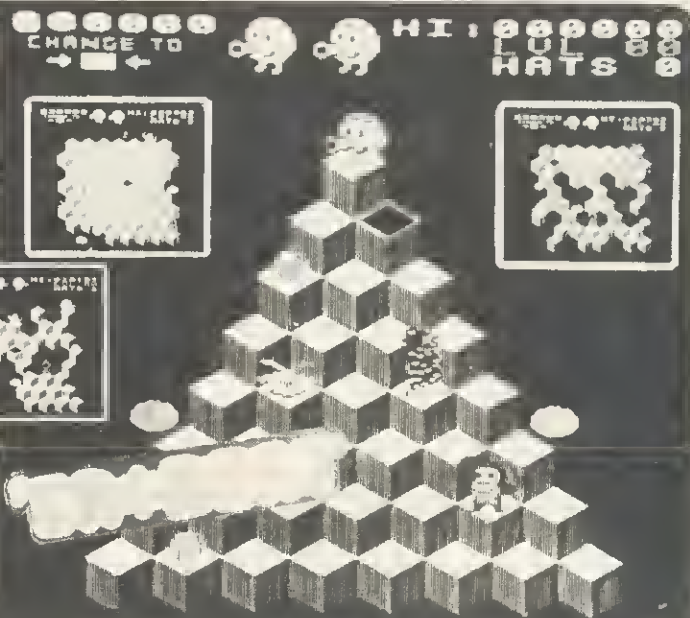

### 3D SPACE RANGER — BBC only

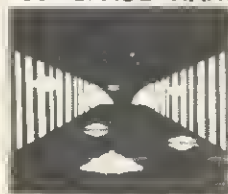

#### STAR TRENCH

EXCELLENT 3D GRAPHICS  
MULTIPLE SCENE SPACE TREK  
BATTLE TO THE DEATH  
START TRENCH DESTROY  
THE DEATH STAR — FIGHT  
YOUR WAY BACK. MACHINE  
CODE GAMES IREQUIRES O.S.  
1.0/1.21

Star Surface

### PINBALL

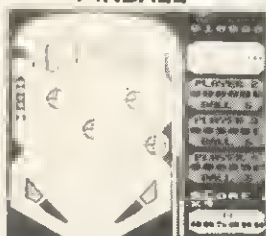

THE CLASSIC ARCADE GAME UP TO FOUR PLAYERS — HI SCORES, BONUS FEATURES. ELECTRON/BBC — MACHINE CODE

### REVERSI

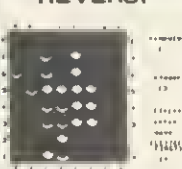

A TRADITIONAL GAME OF STRATEGY AND SKILL — 2 LEVELS ELECTRON/BBC

DISTRIBUTORS — DEALERS — CALL 06373 6886 FOR TRADE ENQUIRIES

ILLUSTRATED LEAFLETS AVAILABLE — SEND S.A.E

GAMES AVAILABLE AT MANY OUTLETS OR DIRECT FROM:

ACCESS CARD WELCOME 24 HR HOT LINE: 06373 6886



MICROBYTE SOFTWARE (YC10)  
18 HILGROVE ROAD, NEWQUAY, CORNWALL, TR7 2DZ.





# ...Twillstar reliability for BUSINESS computer users!

Telephone  
Orders  
574 5271

*all prices  
inclusive of vat!*

**and there is more...**

## BUSINESS SYSTEMS

### SANYO 550

16Bit Micro 128K RAM expandable to 256K. Single or Double Disk drive built in full colour graphics (640 x 200 pixels in 8 colours) IBM compatible. Free software. Sanyo MBC 550 128K RAM single drive and tree software including Wordstar and Calcstar

£862

### SANYO 550-2

As 550 but with Dual Drive 2 x 160K

£976

### SANYO 550-360

As 550 but with 2 x 360K Drives

£1149

### SANYO 550-73

As 550 but with 2 x 730K Drives

£1206

### SANYO 555

Sanyo MBC555 128K double drive and tree software including Wordstar, Calcstar, Inforstar, Datastar etc.

£1149

### SANYO 555-360

As 555 but with 2 x 360K Drives

£1436

### SANYO 555-730

As 555 but with 2 x 730K Drives

£1494

## WORD PROCESSING

### BBC 1:

BBC Micro Model B, View (or Word-wise) Wordprocessor, Quendata 20 CPS Daisywheel Printer, High Res Green Monitor, Cassette Recorder plus 10 cassettes and all the necessary cables.

£747.50

### BBC 2:

BBC Micro Model B + Disk Interface, View (or Wordwise) Wordprocessor, 100K Disk Drive, High Res Green Monitor, Duendata 20 CPS Daisywheel Printer, 1 Box of Disks and all the necessary cables.

£803.35

### BBC 3:

Same as System BBC 2 but with 400K Drive

£1006.25

### BBC 4:

BBC Model B + Disk Interface, View (or Wordwise) Wordprocessor, 800K Dual Disk Drive (Mitsubishi), High Res Green Monitor, JUKI 6100 Daisywheel Printer, 1 Box (10) of 80 Track Disks and all necessary cables

£1316.75

### SAN 1:

Sanyo MBC 550 Series 16 Bit Microcomputer, 128K RAM, Dual 160K Drives (2 x 160K), High Res Graphics (600 x 200 pixels in 8 colours), JUKI 6100 Daisywheel Printer, High Res Green Monitor, 1 Box of 10 Disks, Wordstar Wordprocessor, Calcstar spreadsheet and all the necessary cables

£1351.25

### SAN 2:

Same as SAN 1 but with Dual 360K Drives (2 x 360K)

£1546.75

### SAN 3:

Same as SAN 1 but with Dual 720K Drives

£1604.25

### SAN 4:

Sanyo MBC 555 Series 16 Bit Microcomputer, 128K RAM, Dual 150K Drives (2 x 160K), High Res Graphics (600 x 200 pixels in 8 colours) JUKI 6100 Daisywheel Printer, High Res Green Monitor, 1 Box of 10 Disks, Wordstar Wordprocessor, Calcstar spreadsheet, Mailmerge, Spellstar (dictionary), Datastar (database), Reportstar plus all the necessary cables

£1489.25

### SAN 5:

Same as SAN 4 but with Dual 360K Drives

£1696.25

### SAN 6:

Same as SAN 4 but with Dual 730K Drives

£1753.75

## BUSINESS SOFTWARE

	£	£
	Tape	Disk
Cash Book		
Accounts	59.80	63.25
Final Accounts	59.80	63.25
Invoices & Statements	19.84	23.28
Commercial Accounts	19.84	23.28
Mailing List	19.84	23.28
Data Base	19.84	23.28
Stock Control	19.84	23.28
Home Accounts	19.84	23.28
Beebcalc Spreadsheet		
Analysis	19.84	23.82
Payroll	44.85	48.30

### ADD ON'S FOR BBC

Complete programme development package on 16K RDM, an absolute necessity for all assembly language programmers

£56.35

### MODEMS

#### WS200D

A world standard direct connect modem switchable between 75,300/300, 600, 1200/75, 75/1200 baud, awaiting BT approval. It is compatible with Bell 103/113/108, 202 and CCITT V21 & 23 standards and allows you to communicate with

virtually any computer system in the world. This is one of the new generation modems, that will probably cover any communications standards you would ever need. This is the modem that will cover Prestel, Micronet, Telecom Gold, Distel, Microweb, Dne-to-Dne, Bulletin Boards both in the UK and abroad, ect. etc. as well as user-to-user communication. It also has a rather useful facility of 'Reverse-Prestel' mode i.e. 75/1200 so that you can communicate with other users who only have a standard 1200/75 type modem. What possibly gives this modem its biggest advantage is its option of computer controlled switching between all modes of operation. In addition, separate auto-answer and auto-dial cards are available, giving this modem possibly the greatest potential of all. Mains powered £129(c) Please phone/write for details of optional extras

### TELEMOD-2

A BT approved modem complying with CCITT V23 1200/75 Duplex & 1200/1200 Half-Duplex standard, that allows communication with Viewdata services e.g. Prestel, Micronet etc., as well as using 1200 Baud for communicating with other computer users. Mains powered. TELEMOD 2

£65(b) BBC Lead £3.50

## HOW TO ORDER

You may purchase any of the items listed by cheque made payable to: Twillstar Computers Ltd. Barclaycard or Access. All you have to do is fill in your requirements on a separate sheet of paper, post to us and we will despatch within 24 hours, subject to availability. All prices inclusive of 15% VAT. ADD £2.50 P&P for orders below £150. Over add £8 P&P. Credit card holders may order by telephone. Give card number, name, address and items required. Please note VAT is not charged on export orders. Export customers please ring for details of P&P.

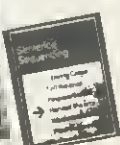
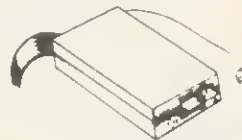

ask for our Full range!  
**TELEPHONE ORDERS**  
**(01) 574 5271**

Open  
6 days a week  
9am to 7pm  
Monday to Saturday

# Twillstar Computers Limited

17 Regina Road, Southall, MIDDLESEX, UB2 5PL. TEL: (01) 574 5271

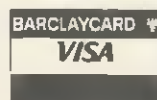

# GSL Computers

## More Hard Disk Developments for BBC Micro

Giving even lower cost systems for education



### Hard Disk Drives

Range from 5 – 232 MBytes  
5 MBytes removable cartridge drives

### Tape Streamer

Efficient backup of Winchester units (standard tape backup of 45 MBytes in 9 mins.).

### WFS

Comprehensive Winchester filing system Rom – stand alone use.

### Networking

Amcom's E-Net provides a simple to use, yet flexible system for linking up to 255 BBC micros to a Winchester file server.

\* Large Capacity Winchester Drives

\* Removable Cartridge

\* Tape Streamer Backup



GSL Hard Disk Systems have been well proven in educational, factory and office environments, for stand alone or networking applications.

Other GSL products include:-

Printer Buffer  
LCD Display  
Floppy Disk Drives  
Monitors  
Printers

(We are also an Acorn dealer).

For further information on any of our products contact:-  
Lea Wyatt at  
GSLC



### Geophysical Systems Computers Limited

West Portway, Andover,  
Hampshire SP10 3SG.  
Tel: (0264) 59633  
Telex: 47166 GSLG.

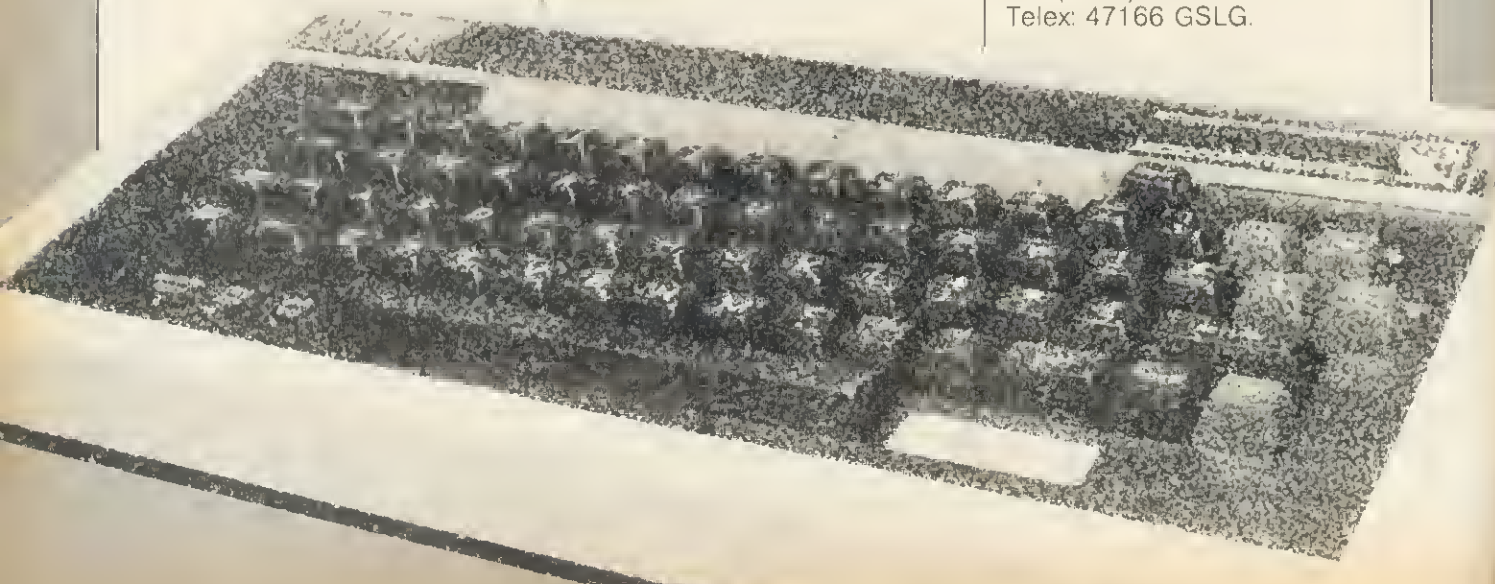



## BBC/ELECTRON PROFESSIONAL SOFTWARE

Our educational software is used in thousands of schools and homes throughout Great Britain.

**EDUCATIONAL 1** *BBC/ELECTRON* *Tape £8.00 Disc £10.00*  
Hours of fun and learning for children aged five to nine years. Animated graphics will encourage children to enjoy counting, maths, spelling and telling the time. The tape includes six programs: MATH 1, MATH 2, CUBECOUNT, SHAPES, SPELL and CLOCK.  
... 'An excellent mixture of games' ... *Personal Software - Autumn 1983.*

**EDUCATIONAL 2** *BBC/ELECTRON* *Tape £8.00 Disc £10.00*  
Although similar to Educational 1 this tape is more advanced and aimed at seven to twelve year olds. The tape includes MATH 1, MATH 2, AREA, MEMORY, CUBECOUNT and SPELL.

**FUN WITH NUMBERS** *BBC/ELECTRON* *Tape £8.00 Disc £10.00*  
These programs will teach and test basic counting, addition and subtraction skills for four to seven year olds. The tape includes COUNTING, ADDING, SUBTRACTION and an arcade type game called ROCKET MATHS which will exercise addition and subtraction. With sound and visual effects.

**FUN WITH WORDS** *BBC/ELECTRON* *Tape £8.00 Disc £10.00*  
Start your fun with alphabet puzzle, continue your play with VOWELS, learn the difference between THERE and THEIR, have games with SUFFIXES and reward yourself with a game of HANGMAN.  
... 'Very good indeed' ... *A&B Computing - Jan/Feb 1984*

**JIGSAW AND SLIDING PUZZLES** by P. Werner *BBC/ELECTRON* *Tape £7.95 Disc £9.95*  
There are two jigsaw and four sliding puzzles on a 3 x 3 and 4 x 4 grid. Each program starts off at an easy level to ensure initial success but gradually becomes harder. It helps children to develop spatial imagination and in solving problems. The tape includes: DBLONG, JIGSAW, HOUSE, NUMBERS, CLOWN and LETTERS.

**KON-TIKI** by J. Amos *BBC* *Tape £10.95 Disc £12.95*  
Simulation program based on Thor Heyerdahl's KON-TIKI expedition. Enjoy a journey on the KON-TIKI recording on a map the raft's position and entering notes in the logbook on creatures found, unusual events etc. Inclusive of booklet, background information, maps and fully supportive illustrated data sheets.

★SPECIAL OFFER★  
Buy three titles and deduct £4.00  
Add 50p p&p per order. Please state BBC or ELECTRON or  
40 or 80 track for discs.

Golem Ltd, Dept A, 77 Qualitas, Bracknell, Berks RG12 4QG. Tel: 0344 50720

# a true bargain... DAISY STEP

## Daisy Wheel Printer at £228

INCLUSIVE OF VAT  
(Please add £8 for post and packing)



\*FREE CABLE  
\*FREE PAPER

... At the special price of £288 inclusive of VAT and Post, Packing and Insurance, this is indeed a unique opportunity to own an amazing flexible Daisy Wheel Printer!

Just look at the features!

- |                                |                                 |
|--------------------------------|---------------------------------|
| 1. 18 CPS                      | 8. Bold and shadow printing     |
| 2. Bidirectional               | 9. Sub & superscripts           |
| 3. Logic seeking               | 10. QUME compatible ribbons     |
| 4. Proportional tracing        | 11. QUME compatible daisywheels |
| 5. Wordstar compatible         | 12. 4 level impression control  |
| 6. 13" pleten - 12" print line | 13. Prints original + 4 copies  |
| 7. Auto underscore             | 14. Low noise                   |

This extremely attractive printer comes complete with free printer cable and 500 sheets of test run paper - just to make sure you get everything running smoothly!

### HOW TO ORDER

To purchase the KP810 or the KP910 printer simply write your name and address on a piece of paper, and post to the address below, enclosing your cheque/P.O. made payable to Twillster Computers Ltd.  
If you are a Credit Card Holder, simply use the telephone to place your order.



17 REGINA ROAD, SOUTHALL, MIDDLESEX UB2 5PL. TEL: (01) 574 5271

... ask for our Full range!

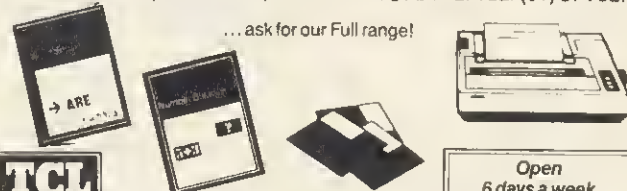

**TCL**  
**Twillster Computers Limited**

17 REGINA ROAD, SOUTHALL, MIDDLESEX UB2 5PL. TEL: (01) 574 5271

Open  
6 days a week  
9am to 7pm  
Monday to Saturday

**TELEPHONE ORDERS**  
**(01) 574 5271**



# 1st IN BROMLEY

**BROMLEY'S FIRST  
SPECIALIST COMPUTER STORE**

We are official Acorn Dealers with high standards to maintain and take pride in friendly and efficient advice and service.

See our extensive range of printers, monitors, disc drives, software and books.

## Data Store

6 Chatterton Road, Bromley, Kent. 460 8991





# Something new from CMC...



## ... books ...

Our highly successful Advanced User Guide for the BBC has now been joined by the Advanced Basic ROM User Guide, which delves deep into the BBC micro BASIC 1 and 8 BASIC 2 ROMs. At **£7.95**, it's essential for the serious user. We have also introduced hard-back ring-binders for the Acorn User Guide and our Advanced User Guide: available at **£4.50** each.

## ... type 'n' talk ...

Simply connected to any micro, this is a powerful speech computer with sophisticated software: it will convert any text into speech faster than it can be spoken. This is our own product, developed and manufactured in Cambridge. **Delivery £5.00.**

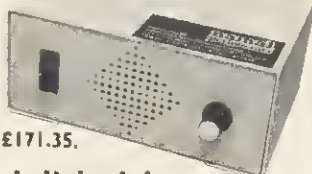

£171.35.

## and disk drives ...

The new generation of TEAC 5 1/4" slim-line disk drives offer high performance at incredibly low prices.

Single drives: 100K **£120**; 200K **£140**; 400K **£180**.

Dual drives: 2x100K **£295**; 2x200K **£325**; 2x400K **£450**.

Disk with power supply extra **£30**.

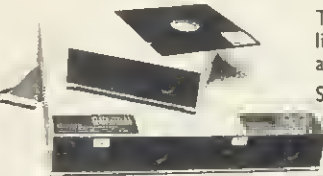

All drives are fully cased and complete with cables and format disk—ready to use. **Delivery £6.00** per item.

We offer a number of complete packages for word-processing, from **£65B** to **£1860**. Pictured here is our Package No. 2: BBC '8' + DFS, Philips green monitor, 100K disk drive, Wordwise, dot matrix printer, leads—ready to use, at **£875** including VAT.



Our other packages are:

**PACKAGE ONE:** 88C 'B' Computer • Wordwise software • Sanyo DR101 tape recorder • Dot matrix printer • 88C cassette lead • 88C printer cable **£65B.00**

**PACKAGE THREE:** 88C Computer + Acorn DFS • Philips 12" green hi-res monitor • 200k disc drive • Wordwise software • Kai 100 EX printer • Printer cable **£940.00**

**PACKAGE FOUR:** 88C Computer + Acorn DFS • GM1211 12" green hi-res monitor • Wordwise software • Juki 6100 daisywheel printer • 400k disc drive • Printer cable **£1170.00**

**PACKAGE FIVE:** 88C Computer + Acorn DFS • GM1211 12" green hi-res monitor • View software • Juki 6100 daisywheel printer • Dual 800k disc drive • BBC printer lead **£1385.00**

**PACKAGE SIX:** BBC Computer + Acorn DFS • Medium resolution colour monitor (Cub/Microvitec) • View software • Juki 6100 daisywheel printer • Z80 second processor including software • Dual 800k disc drive • BBC printer cable **£1860.00**

We stock a vast range of micros, printers, monitors, joysticks... phone or write for our complete price list. All prices listed **include VAT**. Credit terms available for orders of **£500** or over—ask for details. See our full stock on Prestel 377550875/76A—updated weekly. All credit cards accepted.

## Cambridge Microcomputer Centre

The Peripheral Centre of East Anglia

153-4 East Road, Cambridge CB1 1DD, U.K.  
Telephone (0223) 355404 Telex 817445.

# Offers...like this

## Philips V7001 12" Tube High Resolution Computer Monitor...

\*Free Cable!  
\*Free Paper!

# For ONLY £75

INCLUSIVE OF VAT  
(Please add £8 for post and packing)



Telephone  
Orders  
574 5271

Size:

345mm width x 300mm depth x 302mm height!

This special V7001 Phillips monochrome computer monitor comes direct to you from Twillstar Computers Ltd at the exceptional price of **£75** inclusive of VAT. Twillstar Computers Ltd have negotiated with Phillips to bring you this 12" Tube high resolution monitor which has been specially designed to display alphanumeric and graphic information, generated by home and personal computers. It offers compatibility with various types of computers, it accepts composite video signals (CVBS) as well as RGB, synchronisation and sound signals! The monitor provides a clearly legible display with a maximum of 80 characters per line and 25 lines per display. The display format is full screen 250 x 200mm. To reduce eye fatigue the picture tube has undergone a special anti-glare treatment. The monitor also features a two position, adjustable stand.

**Just look at the features!**

1. 12" high resolution picture tube.
2. Two position adjustable stand.
3. Anti-glare treated screen.
4. P31 green phosphor.
5. CVBS input connections.
6. RGB and synchronisation and sound input connection.
7. Sound input 0.3 watts.
8. 16MHz Bandwidth.
9. 2000 character display control.
10. Compatible with home and personal computers.
11. Precision deflection unit for low geometric distortion.

And of course, exterior controls allow you to switch on/off volume, brightness, contrast, vertical size, vertical hold and horizontal size. This unique specially designed monitor measures 345mm width x 300mm depth x 302mm high. **Order now while stocks last!**

### HOW TO ORDER

All you have to do is fill in your requirements on a piece of paper with your name and address enclosing your cheque/P.O. made payable to TWILLSTAR COMPUTERS LTD. If you are a Barclaycard or Access card holder, please use coupon and post to address below.  
Please allow 14 to 28 days for delivery.

17 REGINA ROAD, SOUTHALL, MIDDLESEX UB2 5PL TEL: (01) 574 5271

...ask for our Full range!



**Twillstar Computers Limited**

17 REGINA ROAD, SOUTHALL, MIDDLESEX UB2 5PL TEL: (01) 574 5271

Open  
6 days a week  
9am to 7pm  
Monday to Saturday



TELEPHONE ORDERS  
(01) 574 5271

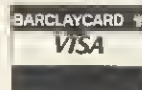





# ACQUIRE THE RAVEN BOARD POWER

... at Twillstar or your local Acorn dealer

- \*20K USABLE MEMORY
- \*CUSTOMED MADE

The RAVEN-20 is a 20K RAM EXPANTION for the BBC MICRO, MODEL B, fitted with O.S. 1.2.

This specially designed product plugs in to the C.P.U. socket of your micro (centre socket of the 3 available) with the minimum of effort – the pins are specially custom made, thus avoiding any possible damage to the circuitry!

The RAVEN BOARD provides the user with an extra 20K of usable RAM in screen modes 0 to 3. This together with the aid of software makes the system completely transparent to both the user and the computer.

The RAVEN-20 software ROM gives much more than just the standard commands, it has been programmed to give commands like: "STAR S. SAVE", LOAD for saving and loading the screen, "R. TEST" for testing the board; "STAT" for checking whether Board ON or OFF... and many more unique features – not available in any other product.

The RAVEN-20 comes complete with;

1. RAVEN-20 Board.
2. RAVEN-20 software.
3. Fitting and operating instructions (see picture).

Don't Forget SOFTWARE UPDATE! – return your guarantee/Registration slip and you will automatically be entered onto our files for registration and notification of new software updates!

Purchase with complete confidence on the "TWILLSTAR RELIABILITY".

**TCL**



TELEPHONE ORDERS  
(01) 574 5271



#### HOW TO ORDER

- To purchase the 'RAVEN BOARD', simply write your name and address on a piece of paper, and post to the address below, enclosing your cheque/P.O. made payable to: TWILLSTAR COMPUTERS LTD.
- if you are a credit card holder, simply use the telephone to order.



**£69.95**

INCLUSIVE  
VAT  
ADD £150 P&P

#### DEALER ENQUIRIES INVITED

- \*Service contracts to educational authorities at discount.
- \*Official orders from dealers, government departments, colleges and schools welcomed.
- \*Price inclusive of VAT.



Specification may change without notice

**TCL**

# Twillstar Computers Limited

7 REGINA ROAD, SOUTHALL, MIDDLESEX UB2 5PL. TEL: (01) 574 5271



# FLOOR SHOW

164

Computer-controlled buggies are fun as well as being instructive.

Geoff Nairn MOT-tests six models

IS YOUR BBC micro looking tired and listless? Bored with killing aliens and interrupting vectors? It can't be much fun being confined to the same old table-top day in and day out, so why not buy it some 'wheels'? For considerably less than a Mini Metro your Beeb can become mobile and explore the outside world – well, your room at least.

The six 'buggies' examined all move along the floor under direct control of the BBC micro. Some can draw lines, flash lights and make noises as they move. Others can even respond to the environment around them: searching out a light source with a photocell, or changing direction when they hit a wall. They all, however, provide a low-cost introduction to the world of robotics.

Where they differ considerably is in ease of use. Two of the buggies are 'turtles', a species that is easier to control and therefore likely to suit younger children. To make a turtle move forward, for example, you simply type FORWARD; to do the same with one of the cheaper buggies you need to address the user port directly – ?65120=6 for example. While the turtles are aimed at young children, buggies are more for experimenters who can program. This difference is reflected in the price – more than £170 for a turtle, £35 for the cheapest buggy.

The turtle has been around since the early seventies, when Seymour Papert proposed it as a suitable 'object-to-think-with' for young children using his Logo language. With the large-scale introduction of microcomputers into schools in the eighties, the first commercially available turtles were produced by Jessop Microelectronics. The original Seri version cost more than £350, though it could be used with a range of micros; the new Para,

reviewed here, is half that price and currently only available for the BBC micro.

The Jessop Turtle – also called the Edinburgh Turtle – is elegantly simple: two motors to drive the wheels, another to lift a pen up and down, a small loud-speaker and a circuit board. A perspex dome lets you see how little there is inside and a long cable connects it to your Beeb. At the end of the cable is a small interface box that plugs into the user port. Power comes from the Beeb's auxiliary power socket – a 'splitter' cable means you can still power your disc drive.

To drive a turtle you need some software and to use it as Papert intended you really need Logo. At the time of

writing there is no full implementation of Logo available for the BBC micro – so-called 'turtle graphics' programs are purely screen-based and can't control floor turtles. Jessop supplies a simulation of Logo called 'OKLogo', which is all right as an introduction to using the turtle but lacks many of the features found in full Logo. So to assess the Jessop Turtle more thoroughly I used Dart. Dart is also a Basic simulation of Logo, still rather rudimentary, but it will work with both the Jessop and Valliant Turtles.

The other turtle, the Valiant Turtle, was launched in July this year – in the House of Commons, of all places! Although it costs about the same as the Jessop Turtle, it is a very different beast. To start with, it actually looks like a turtle, having flippers, a head with two eyes and a shell. It also has its power supply on board, in the form of ten nickel cadmium rechargeable batteries. When the turtle's eyes stop glowing then it's time to recharge the batteries, using the recharger supplied – one charge should give about four hours of continuous use.

Perhaps the most revolutionary feature of the Valiant Turtle is the absence of any cable connecting it to the computer. Instead, communication is by means of an infra-red link. The transmitter is a small box that plugs into the Beeb's RS432 socket and which is pointed in the general direction of the turtle. The turtle picks up the infra-red signal using phototransistors mounted inside its 'shell' and decodes it into appropriate movements.

Using an infra-red link means that the Valiant Turtle can roam freely up to

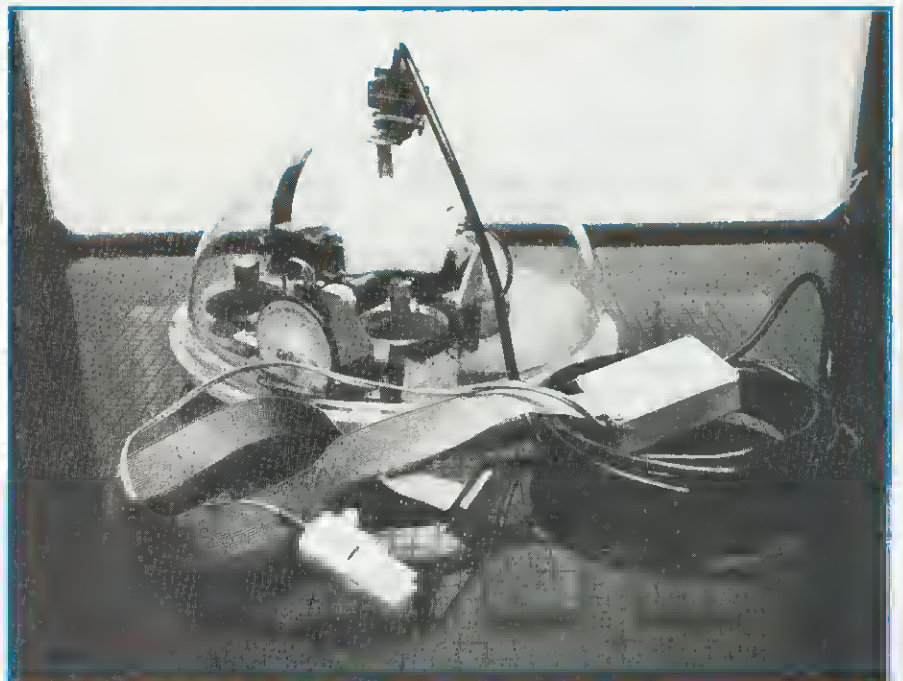

The Jessop Turtle. All the works can be seen beneath its perspex dome



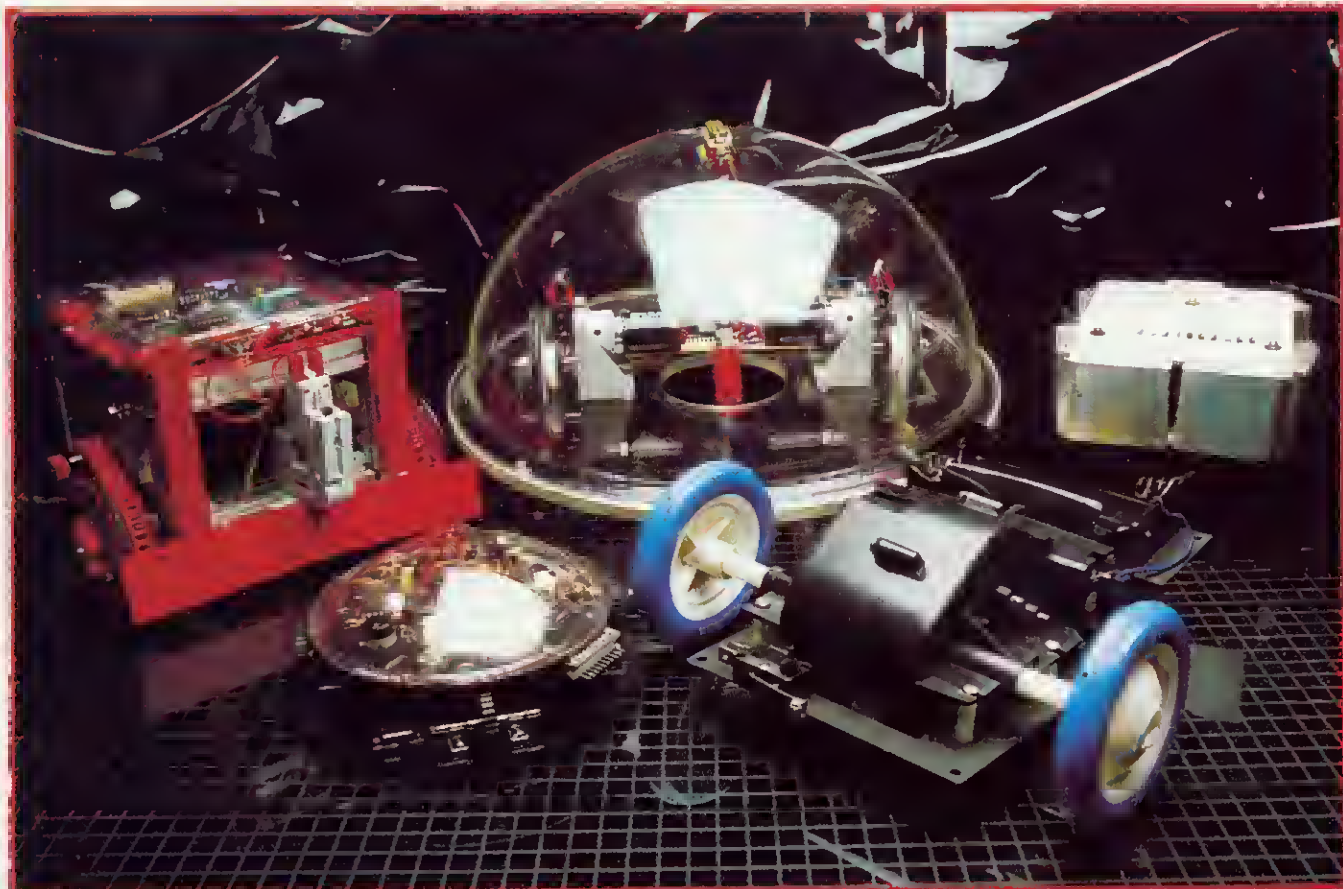

ON THE GRID (left to right): Economatics' BBC Buggy; the Memocon Crawler, designed to be connected to a small keypad; the Jessop Turtle; Northern Computers' Micro Pulse Buggy; and the Zeaker, with its pair of touch-sensitive bumpers

a range of about six metres; with the Jessop Turtle the cable often gets twisted or obstructs the turtle's path. One disadvantage to using infra-red is that in bright sunlight the signal gets swamped and the Valliant Turtle won't move; the same thing happens near an electric fire. Also communication is strictly one-way: the computer has no idea whether the turtle has responded properly – to use a piece of engineer-

signal to the computer via the cable that it's ready for the next instruction. If the turtle hits an object the wheels will not have turned their full amount; the computer has to wait until the object is removed and the robot can complete its move. This is the same principle as used in 'intelligent' robotic devices.

The feedback means that Jessop can get away with using DC motors, as any errors are corrected. The Valiant Turtle is fitted with expensive stepper motors, which are accurate enough not to need feedback. Unfortunately they consume quite a lot of power, hence the large number of rechargeable batteries.

On the subject of accuracy, both turtles can be fine-tuned to compensate for mechanical tolerances. This is done by programming the turtle to draw a square; if the finish point does not coincide with the start then the wheel track can be adjusted with a small spanner. With both the Valiant and Jessop turtles supplied this was not necessary.

One intriguing difference is in the distance each turtle moved when told to 'FORWARD 10'. The Jessop moved 3.7cm, whereas the Valiant moved 4.7cm. When used as an educational tool, the absolute distances don't really matter, just as long as 10 Logo units are twice as big as five units, and both models performed well in this respect. The Valiant was the slower, but not significantly so.

Other differences? Well, the Valiant Turtle does not have a loudspeaker, so it cannot 'HOOT' – a Logo command. Also it will work only on a smooth surface, not carpets. Provided with the Valiant is the Dart software mentioned above, as well as Valiant's own demonstration program. This is just as well, for the latter won't let you define your own procedures – one of the most important features of the Logo language.

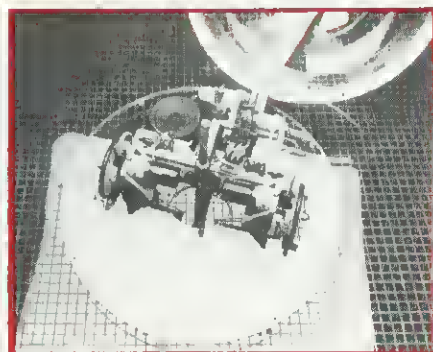

Inside the Jessop turtle

ing jargon, there is no 'feedback'. If someone stands directly in the path of the infra-red beam or if the turtle hits an obstruction, the computer will quite happily go on sending out new instructions as if nothing had happened.

In contrast, the Jessop Turtle has optical sensors on the wheels that monitor whether they have turned the right amount; if they have, the turtle sends a

### JESSOP TURTLE

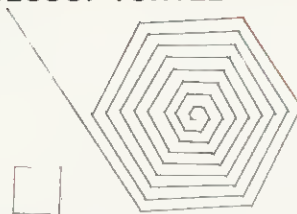

### VALIANT TURTLE

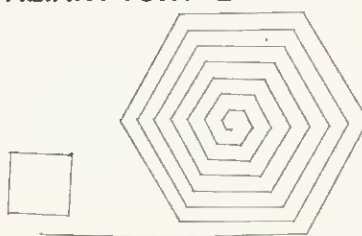

How two turtles coped when programmed to draw the same recursive spiral shape using Logo commands. Note how on the Valiant turtle the steps are larger.

# star ATTRACTIONS



**GEMINI-10X**

**£189.95**

+ VAT = £218.44

120 cps ● 8i-Directional Logic Seeking ● Friction Tractor and Roll Holder Standard ● Downloadable Characters ● Ultra High Resolution ● 80 cols ● IBM PC version now available.



12 MHz Video Bandwidth  
RGB and Composite Video  
Medium Res

**£169.95** + VAT = £195.44

Also available in TV/monitor version at £195.95 (+VAT) = £225.34

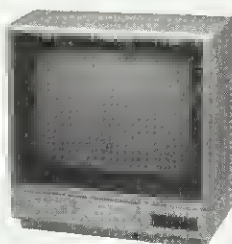

14 INCH COLOUR MONITOR

## LOOK! NEW LOWER PRICES ON EPSON STAR & BROTHER

### DAISYWHEEL PRINTERS

BROTHER HR 15 CALL FOR BEST PRICES  
JUKI 6100 £325 + VAT = £373.75  
DAISYSTEP 2000 £225 + VAT = £258.75  
EPSON DX 100 £369.95 + VAT = £425.44

### DOT MATRIX PRINTERS

COSMOS JP80 £169.95 + VAT = £195.44  
EPSON RX 80 £198.95 + VAT = £228.79  
EPSON RX 80 F/T £228.95 + VAT = £263.29  
EPSON RX 100 £384.95 + VAT = £442.69  
EPSON FX 80 £319.95 + VAT = £367.94  
EPSON FX 100 £498.95 + VAT = £573.79  
STAR GEMINI-10X £189.95 + VAT = £218.44  
STAR DELTA 10 £319.95 + VAT = £367.94  
STAR RADIX 10 £498.95 + VAT = £573.79

### THERMAL MATRIX PRINTERS

STAR STX 80 £129.95 + VAT = £149.44  
BROTHER HR5 CALL FOR BEST PRICES  
BROTHER EP 44 CALL FOR BEST PRICES

Cables - Paper - Ribbons - Sheet Feeders  
Tractor Feeds - Interfaces - Call for Best Prices



**CREDIT CARD  
HOT LINE  
01-482 1711**



PLEASE ADD £10 + VAT FOR DELIVERY  
POST YOUR CHEQUES/P.O.'s TO:

**DATASTAR SYSTEMS UK**  
UNICOM HOUSE, 182 ROYAL COLLEGE STREET  
LONDON NW1 9NN

Telex 295931 UNICOM G

TAX-FREE EXPORT & DEALER ENQUIRIES WELCOME

Personal callers welcome. We are situated at the junction of Camden Road, near the railway bridge.

Opening hours Mon-Fri 9 a.m. to 6 p.m.  
Sat & Sun 10 a.m. to 1 p.m.

# ChipChat Modem

ChipChat modems are the most versatile and up to date available at the price. With autoanswer as standard and intelligent autodial with speed conversion as an option, ChipChats may be used to access computers and databases such as Prestel, Micronet, Homelink and BT Gold.

ChipChats support the CCITT V21 protocol: 300/300 baud and the V23 protocol: 1200/75, 75/1200 and 1200/1200 (half duplex). Where local regulations permit, Bell standard operation may be used for dialling US databases.

ChipChats use the latest technology and provide valuable extra features such as auto-disconnect to save your telephone bills, and speed conversion for operation with IBM PCs. A full complement of LED5 monitor data flow and the status of handshake lines on the Cannon D-type connector.

ChipChat modems have been designed with our experience of manufacturing BT approved intelligent terminals, they provide the facilities and data rates you need at the touch of a button or they can be left unattended under computer control.

ChipChats are supported by a large range of communications software packages and terminal emulations for the IBM, Sirius, Apricot, Apple and BBC micros.

Ring for details and special package deal prices.

ChipChat CC2123A Autoanswer £130.35  
£149.90 inc VAT

ChipChat CC2123AD Autodial £165.13  
£189.90 inc VAT  
P&P £2.70 + VAT BABT Approval Applied For



**Digitolve**  
Micro elite from design - installation

Digitolve Limited  
Aire and Calder Works  
Cinder Lane, Castleford, West Yorks WF10 1LU  
Tel: 0977 513141/4 Telex 557661 AGRAM G



Which one to buy? Assuming both versions will work with the full Logos due this year, both are invaluable in teaching programming without tears. The Valiant Turtle has the great attraction of actually looking like a turtle and not having a restrictive umbilical cord. It's probably the better bet for use with young children. The Jessop comes from the minimalist school of turtle design, and I have a sneaking admiration for something so simple yet so powerful. As well as its conventional use as a floor turtle, the Jessop Turtle is a lovely demonstration of the engineering principle of feedback. Also its inner workings are easier to understand – and modify. Both these factors mean that the Jessop Turtle might find its way into a lot of secondary schools, as well as the traditional primary school market.

Moving on from turtles we come to the BBC Buggy, made by Economatics. This costs about the same as a turtle but is very different both to look at and use. Originally it was developed to demonstrate computer control in secondary schools. The major difference is that it can respond to the environment around it using a variety of sensors. As such it exhibits simple artificial intelligence – or rather the controlling program on the BBC micro does, for there is no 'on-board' intelligence.

The BBC Buggy comes as a kit and is built around a chassis, much like the way they used to make motor-cars. On the Buggy this is cube-shaped and everything else is 'bolted' onto it. In fact no bolts are needed: the Buggy is made up from Fishertechnik construction parts that just slot together. Construction is relatively simple once you've



The Valiant Turtle actually looks like a turtle, and there's no cable!

identified the various components, which tend to have names like 'angle block isosceles' and 'crawler track link'. The circuit boards come ready-made, and the various leads just need plugging in – you don't even need a soldering iron. The Buggy can be built in a couple of evenings, and no mechanical

Vehicle	Logo	Hoot	Lights	Bumpers	Pen-arm	Power supply	Link	Special features	Optional extras
Jessop Turtle	Yes	Yes	No	No	Yes	BBC	4m cable		
Valiant Turtle	Yes	No	No	No	Yes	Battery	Infra-red		
BBC Buggy	No	No	No	2	No	BBC	5m cable	Barcode reader, photocell	Pen arm, grab arm
Zeaker	No	Two-tone	Yes	6	Yes	Interface	2m cable		
Micro Pulse Buggy	No	No	No	1	No	Battery	2m cable	Other experiments	
Memocon Crawler	No	Yes	Yes	No	No	Battery	pre-programmed		Interface and software (late 1984)

Table 1. Facilities of the turtles and buggies

modifications are necessary – apart from maybe adjusting the wheel track by adding a washer to the axle.

The Buggy connects to your Beeb via a long ribbon cable and an interface board. It uses both the user port and analogue port, and takes its power from the auxiliary power socket.

The software supplied consists of a dozen or so programs demonstrating some of the Buggy's capabilities. They are all written in Basic and can be modified. The first one simply tests the Buggy to see if everything is working correctly and also familiarises you with how it works. Control is by means of the cursor keys: pressing the up arrow makes the buggy go forward, and so on. When turning, one stepper motor goes forwards and the other backwards. This means that the BBC Buggy can accurately turn on the spot. Routes can be stored in the computer's memory and so can be repeated, and you can reverse the Buggy's movements to retrace a route. Other programs let you plan your journey on the screen and then get the Buggy to follow it on the floor, with suitable scaling of movements.

The other programs use the onboard sensors: two bumpers, a photocell and a bar-code reader. One of the programs uses the bumpers to find an object on the floor. You tell the Buggy how large the area to search is and it then goes off to find the object. It does this by moving up and down until one of the bumpers hits something. This closes a microswitch and the Buggy backs off, moves along a bit and tries again. This process is repeated until the Buggy has found all four sides of the object, which it then joins up on the screen and announces that it has found its prey. Often it gets the shape completely wrong – for example, if one of

the wheels slips then it loses all sense of direction. Even so, this is a vivid demonstration of simple artificial intelligence.

A photocell can be mounted on the front of the Buggy and used to search out a source of light, such as a torch. Another program uses the photocell to make the Buggy follow a white line drawn on the floor. When the Buggy strays off it and onto the much darker floor, the photocell detects less light and this information goes back to the computer. The program then changes the Buggy's direction to try and find the line again. This is a typical 'feedback' control system.

A bar-code reader can similarly be attached to the front and then used for inputting bar codes into the Beeb. As the Buggy moves, it crosses large playing-card versions of those bar codes found on soup tins and the like. One program uses this information to play musical tunes – each card is coded to represent a different note.

The Buggy I tested had a grab arm fitted to the front as an optional extra, turning the Buggy into a potentially very useful robot. The arm consists of a horizontal beam onto which is fixed a simple open-and-close jaw. The beam is mounted just above the bumpers and can be raised or lowered by means of two motors; another motor opens or closes the jaws. An extra circuit board is needed to control the grab arm and this fixes vertically onto the back of the Buggy. Some adjustment is necessary to get the jaw and beam moving properly, but once working it is capable of lifting small, light objects.

To operate the arm the function keys are used – up, down, open and close. Some of the original programs for the Buggy, which were developed before the grab arm came along, switch it on

Vehicle	Price	Motor accuracy	Software	Ease of use	Ease of construction	Documentation	Comments
<b>Jessop Turtle</b>	£182	8	7	7	ready assembled	7	Simple, elegant design. Cable can get twisted.
<b>Valiant Turtle</b>	£228 (£171 to schools)	8	8	7	ready assembled	9	Looks like a turtle. Infra-red link allows free movement over wider area. Will not work in strong sunlight or on carpet.
<b>BBC Buggy</b>	£189 kit	8	8	6	7	7	Bumpers and photocell enable it to sense environment around.
<b>Zeaker</b>	£70 kit (£100 ready built)	5	3	4	4	4	Less sophisticated version of above. A good choice for experimenters.
<b>Micro Pulse Buggy</b>	£132 for buggy and interface	3	5	4	ready assembled	6	Buggy cannot be used alone – uses Youngtrainer interface. Several other experiments included.
<b>Memocon Crawler</b>	£35 kit	3	0	2	4	3	No interface. Needs modifying, so only for technically competent.

Table 2. Price and ratings table (out of 10) for the turtles and buggies under review

when they shouldn't. This bug is attributed to a prototype arm and software and will apparently be ironed out before the grab arm goes on sale. A pen arm, which allows the Buggy to draw out the route followed, is also available.

All in all, the Buggy is a very versatile machine. For those who know little about programming and interfacing, the software supplied lets them explore some of the concepts of robotics and computer control. But both the Buggy and its software are sufficiently accessible to allow the more experienced plenty of scope for experimentation.

Zeaker is a small, low-cost buggy that started life as a construction project in an electronics magazine. As a kit it costs £70, though you can buy it now ready-made for £100.

From the outside there is not much to see, just a white plastic box with two small tyres and four wraparound aluminium bumpers at each corner. A ribbon cable plugs into a socket in the top and this connects to the 'Zeaker Control Station'. This contains the interface circuitry and nickel-cadmium batteries which supply power to Zeaker through the ribbon cable. The control station then plugs into the parallel printer port and user port.

Zeaker, like the BBC Buggy, is both an input and output device – hence the two port connections. It contains two DC motors which can be driven forwards or backwards independently. It also has two LEDs on top which I suppose are meant to be 'navigation lights', as one is red and one is green. A speaker inside can sound two different

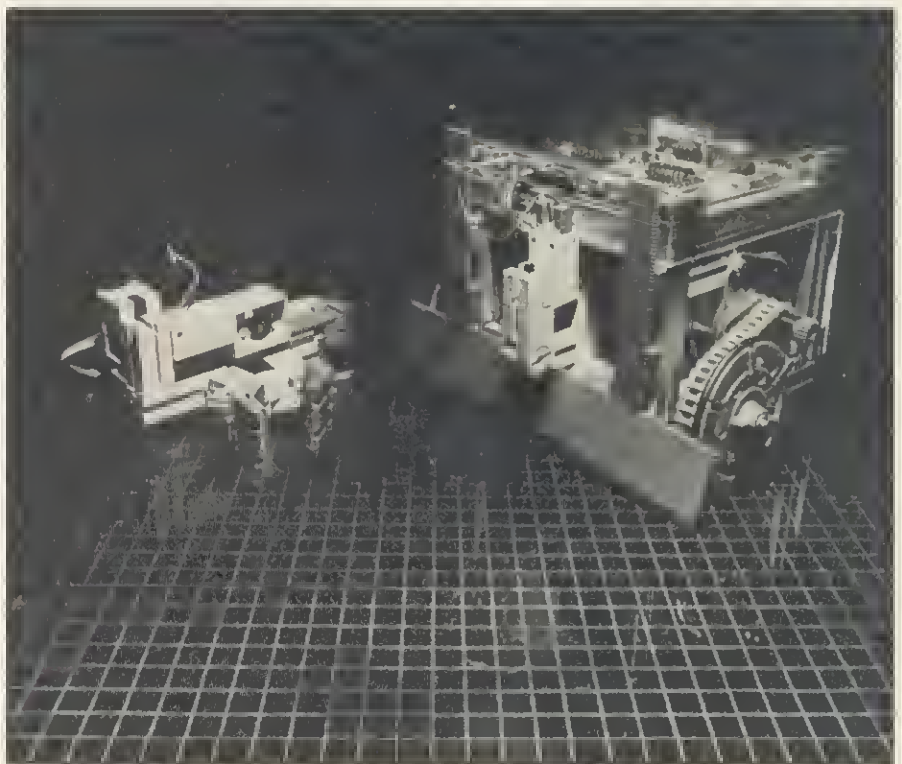

The kit-built BBC Buggy features on-board sensors. The grab arm (left) is an optional extra

tones and a pen can be raised or lowered through a hole in the underside. All these functions are turned on or off using the Beeb's printer port.

Input comes from the bumpers and is routed via the user port. Hitting a bumper pushes it back onto a bolt-head behind and completes an electrical circuit – simple but effective. Each front bumper simulates two switches: if Zeaker hits something head-on one

switch closes, from the side the other closes, and on the corner both close. The two back bumpers operate one switch each. Add that up and you get six switches, so there is still room for another two inputs – or two outputs if you reconfigure the user port.

Two simple demonstration programs are supplied. The first just reads the user port and so displays the state of the bumpers as a single number – for



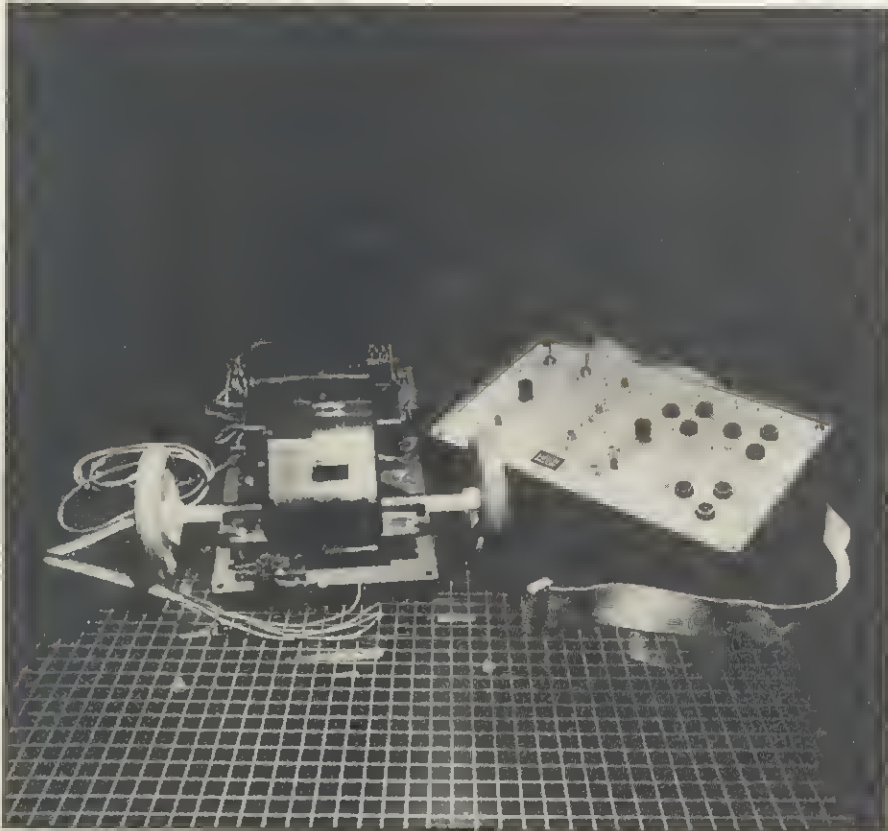

The Micro Pulse Buggy is one of several units that can be linked to the Youngtrainer Interface box

example, 255 means no switch is closed. The other program lets you control Zeaker with simple commands ('F' for forwards, etc) and distances or angles. Both are really meant to give you an idea of how Zeaker is used in programs so that you can write your own.

Zeaker isn't the most accurate of buggies: the one I had experienced difficulty going in a straight line and the pen sometimes wouldn't come down when it was meant to. Nevertheless it's cheaper than the BBC Buggy and offers the same capabilities. You need to be able to write your own control programs to get the most from it, though.

More basic than Zeaker is the Micro Pulse Buggy from Northern Computers. This is not the most attractive of buggies—it looks like a large toy car which has had the top removed. Not surprisingly, it uses the same driving mechanism; two cheap electric motors magnetically coupled together to try to keep the buggy running in a straight line. On the front is a single micro-switch bumper and perched on the back is the power supply—four batteries.

The buggy cannot be used on its own—you also need the Micro Pulse Youngtrainer. This is an interface box that plugs into the Beeb's user port and allows you to interface your Beeb to a variety of external inputs and outputs—not just the Micro Pulse buggy. A ribbon cable connects the buggy to the Youngtrainer and power for the latter can

come from the BBC micro or an external power supply.

The Micro Pulse buggy is very basic; the program supplied just allowed it to go forwards or backwards, though if it hit an obstacle it stopped and reversed a small distance. The large blue tyres slipped occasionally and the Buggy could not travel in a straight line for any distance.

The complete package of buggy, Youngtrainer and leads will set you back more than £130. This may seem expensive but the Youngtrainer comes with about a dozen other interface projects. Plastic overlays can be placed over the Youngtrainer's front panel to simulate various different control situations: a traffic light, a washing machine, etc. Software is supplied for each simulation, and a teaching manual is also included, as the Youngtrainer is again aimed at the education market. The buggy is really a small part of the whole system, though it can be bought separately (£23) if you fancy supplying your own interface and software.

Our last buggy is not designed to be connected to a computer at all. Prism's Memocon Crawler is a self-contained electronic toy which runs around the floor, but with some modification you can connect it up to your Beeb.

It comes as a kit of parts and the only assembly problem is in understanding the pidgin English used in the instructions. When complete it resembles a flying saucer with wheels, but the most

noticeable feature is an edge connector protruding from the Memocon. Into this is plugged a small hand-held keypad, and using the five keys you can program up to 256 steps into the Memocon's massive 1/4k of internal memory. At each step it can move forward, left or right, sound a 'beep' or flash a light. Pull the plug out and the Memocon goes away and runs through the program—over and over again, until you switch it off.

By chopping off the keyboard you can expose the data lines for the Crawler and *hey-presto!* you have a £35 buggy to plug into your computer. I ran it through the Youngtrainer mentioned above and downloaded the program steps from the BBC. You can even plug it directly into the user port but you need to know what you're doing (a circuit diagram comes with the Crawler). Also you have to write your own driver program. There are plans to market a ready-made interface and software, but that spoils all the fun.

About the only thing all these buggies have in common is two wheels. The turtles just move across a piece of paper drawing lines, yet are perhaps the most revolutionary tool in computer education. The BBC Buggy is a sophisticated—and expensive—demonstration of digital control. Zeaker is a do it yourself version of the Buggy and the Micro Pulse Buggy is a real 'no frills' runaround. The Memocon Crawler is guaranteed to frighten the dog. Take your pick.

169

## SUPPLIERS

### Jessop Turtle

Jessop Microelectronics, Unit 5, 7 Long St, London E2 8HN.

### Valiant Turtle

Valiant Designs, Park House, 140 Battersea Park Rd, London SW11 4NB.

### BBC Buggy

Economats, 4 Orgreave Cres, Dore House Industrial Estate, Sheffield S13 9NQ.

### Zeaker

Kit: Innervonics, 147 Upland Rd, London SE22 0DF.

Ready-built: Inter Galactic Robots, Highbury Workshops, Unit 208, 22 Highbury Grove, London N5 2EE.

### Micro Pulse Buggy

Northern Computers, Churchfield Rd, Frodsham, Cheshire WA6 6RD.

### Memocon Crawler

Prism Consumer Products, Prism House, 18-29 Mora St, London EC1V 8BT.

# SIX OF ONE OR HALF A DOZEN OF THE OTHERS?

## 1 SCRIBE

THE PROFESSIONAL WORD PROCESSOR designed for the serious user ■ All operations fully prompted ■ No special knowledge of the computer system necessary ■ Document size NOT limited by computer memory ■ Automatic disc buffering ensures text is moved between disc and computer memory without user intervention ■ Up to 255 pages in a single document ■ 80 column display ■ on screen underline and right justify ■ See it as it will be printed. SCRIBE comes in a chip with 5 minute fitting instructions, utilities disc and manual. DISC MACHINES ONLY. **£59.95 + 60p p&p**



## 2 DATABASE

A superb information management system with an incredible operating speed. 96 fields per record ■ One record 2 Kb max ■ One field 900 characters max ■ 4000 records per database ■ 16 level conditional search ■ Find any record in 2 secs ■ Wild card search ■ Record match ■ 8 automatic sub indexes ■ Total flexibility of output via report writer with auto write back to any field ■ Maths pack ■ Semi programming language.

Integrates with Scribe to give conditional search with MAIL MERGE and high powered report formatting.

Database is in a chip. DISC MACHINES ONLY. Scribe & Database in one chip **£49.00 + 60p p&p.** Scribe & Database in one chip **£95.00 + 60p p&p.**

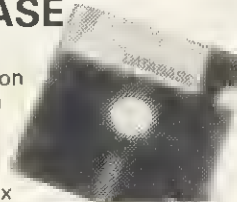

## 3 TYPEWRITER PRINTER

Based on the imperial 8008 this beautiful daisywheel typewriter features MERLIN'S own parallel interface tailored for your BBC computer.

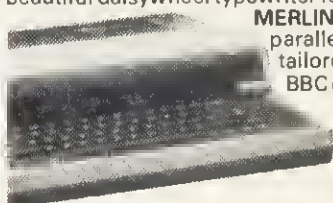

Included are ■ keyboard buffer ■ auto repeat ■ electronic tab set and clear ■ decimal tab ■ 20 character auto correction memory ■ auto underline compatible with SCRIBE.

Comes with carrying case, instruction manual and ribbon connection to your 88C computer.

**£299.00 + VAT**  
Next day Securicor delivery £5.00

Additions to your computer system depend upon each other for best performance. How often have you asked if this or that program is compatible with some piece of hardware?

MERLIN products for the BBC computer are designed to complement each other and so get the best from your system. Rest assured when you buy MERLIN, each addition is compatible with the last and is made to be the best available in its field. Combined with one another they are unsurpassed in performance or value.

Purchasers of MERLIN software are provided with a free update service and an unmatched level of technical support.



MERLIN COMPUTER PRODUCTS

Please supply the following products/information (Delete as applicable).

OTY  \_\_\_\_\_  
OTY  \_\_\_\_\_  
OTY  \_\_\_\_\_

I enclose £ \_\_\_\_\_ Inc P&P  
My Credit Card No. is \_\_\_\_\_

Visa  Access  Tick which

Name \_\_\_\_\_

Address \_\_\_\_\_

To: MERLIN COMPUTER PRODUCTS

33/36 Singleton Street  
Swansea SA1 3QN  
Tel: (0792) 467980



## 4 DOUBLE-DOS

Double density disc interface for the 88C computer.

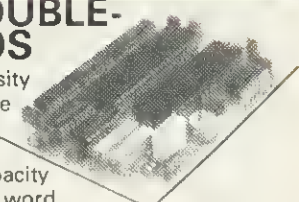

A high capacity database or word processor is enhanced even further with this state of the art disc interface.

The many features include ■ almost 800 Kb of CONTINUOUS file space on a standard 80 track disc drive ■ Automatically read standard Acorn files ■ Compensate for discs formatted in single density ■ Provide up to 156 files IN ONE DIRECTORY ■ Automatically read, write and format double sided drives to appear as one disc surface ■ Allow maximum use of MERLIN Scribe and Database.

Fitting to your computer is made exceptionally safe and reliable by providing connection via a flexible ribbon cable. Full instructions provided.

**£109.25 + 90p p&p**

## 5 DISC DRIVES



All of our disc drives are double density spec. and therefore if used in conjunction with DOUBLE-DOS give twice the standard Acorn disc capacity and feature head load light. Single drives are supplied in a double case to allow easy addition of a second drive.

D100 Single drive 5 1/4/D **£135.00**

D200 Dual drive 5 1/4/D **£267.00**

D400 single drive 5 1/4 double side D/D **£219.00**

D800 Dual drive 5 1/4 double side D/D **£349.00**

For switchable 40/80. Add £26.00

ONE YEARS GUARANTEE

Next day Securicor delivery £5.00

## 6 MERLIN HYPERDRIVE

FOR RELEASE NOV 84

A 2 Megabyte 5 1/4 ins floppy disc drive which will also automatically detect and read standard 40 and 80 track discs.

Size the same as a standard half height drive optional 400 Kb backup drive also available.

Ideal to maintain a large database or document file with high speed access. Requires Merlin Double Dos.

**£575.00**



# HOTHOUSE BEEBS

Danny Green explains how BBC micros are being used at Reading University to monitor plantlife

**D**EEP in the Berkshire countryside, BBC micros are looking after weeds and chocolate plants.

The poor weeds are sweating it out on a hotplate while cocoa bushes get the kid-glove treatment in a computer-controlled glasshouse.

At the University of Reading's Department of Agriculture and Horticulture, Andrew Murdoch is turning the heat on the nasties of the garden. But he's not interested in torturing weeds — he wants to find out how temperature wakes up dormant seeds, and how their growth varies with how hot they are.



Andrew Murdoch checks the progress of his weeds

Andrew is using a BBC micro to monitor the temperature of growing plants. It's not an easy job. The weeds are sitting on a square copper plate. The plate is heated on one side and cooled on the opposite side. The whole outfit is linked to a programmable clock. Every now and then, the heating and cooling arrangement is turned through right angles and after a while turned back again. The overall result is called a two-dimensional temperature gradient, and it is the Beeb's job to follow and record the complicated changes of temperature at 169 points on the plate.



Dr Mike Smith programs his Modec monitor and control unit

The system has been running 24 hours a day for more than six months — with just a three-week break for Christmas.

The BBC micro is interfaced to the weed experiment using a box of electronic tricks built by Dr Mike Smith at Reading. Called a Modec, this is a programmable monitoring and control unit that can work with a variety of micros.

In the cocoa experiment, a couple of miles down the road, the BBC micro controls operations as well as monitoring them. It is taking over from an ancient Commodore Pet, and the scientists are taking the opportunity to improve the whole rig.

A combined monitoring and control system to control a greenhouse might work like this. Anemometers and platinum resistance thermometers measure wind speed and temperature. If the wind is too strong, the computer won't open any vents in the top of the greenhouse, and the vents stay shut if it's pouring with rain too.

Then the computer checks the temperature signals coming from the Modec. If it's between, say, 21°C and 22°C, all well and good. If it's too hot, a vent is opened for one second. The air in the greenhouse is given 10 seconds to calm down before the temperature is

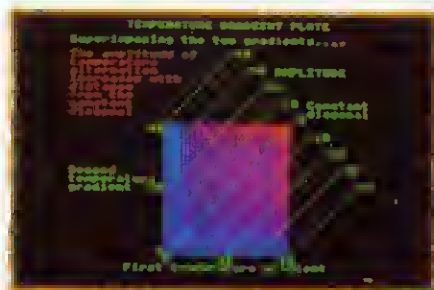

Hi-res graphics follow changes in temperature

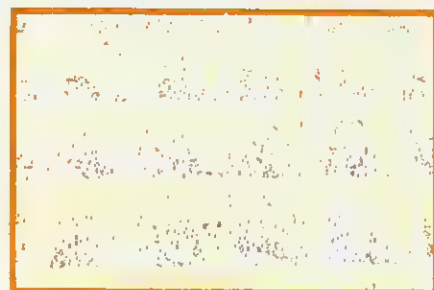

Turning the heat on weed seedlings

checked again. If it's still too hot, the process is repeated. It doesn't drop below 21°C very often, and if it does it's a matter of closing the vents tightly and waiting.

Both the weed-measuring and cocoa-controlling experiments use a BBC B with a single half-height floppy disc drive and a dot matrix printer. For the technically minded, a typical Modec is based on the 6809 microprocessor with a timer and 8k of RAM. It can have 64 inputs and outputs. Communications are via an RS232 link but, because the Modec is built to take a range of standard-sized modules, it is almost infinitely flexible.

Other experiments using the Modec at Reading University include monitoring the behaviour of badgers in their setts, counting the eggs laid by chickens, and simulating the climate of the Syrian desert in an almost ordinary greenhouse.

The big differences that using the BBC micro makes are cost and flexibility, says Andrew Murdoch. 'It's cheaper than other micro systems and more flexible than a multipoint chart recorder.'

**'Other experiments at the university include monitoring the behaviour of badgers in their setts and counting the eggs laid by chickens'**

# A STAR IS BORN



## PRESTEL, MICRONET, BBC to BBC file transfer, Terminal Emulation.

Commstar is unique and complete, a total solution. Imagine a single Eprom based package of sophisticated communications software that caters for all your requirements.

### Imagine Commstar

Take for example British Telecom's Prestel service offering access to a multitude of up-to-the-minute information pages, world news or weather and much more. Instant access to Micronet 800 with many free programs that can be downloaded in seconds. Free advice and news. Expand your horizons and find out just how versatile our computer can really be!

How many times have you wanted to get a copy of a program to a friend or a business colleague quickly? With Commstar you can transfer a file of ANY type between two BBC's (which may be thousands of miles apart) in the space of a phone call.

It really is that simple! Commstar is 'intelligent'. It offers many advanced features to ensure simple and effective communication with the remote system.

Consider the following features:

### Prestel Mode

Prestel mode features full colour Prestel graphics including double height and flashing characters. Full Tele software capability is offered allowing the many free programs offered by Micronet 800 to be downloaded into your computer. Pages of particular interest may be marked for later retrieval and display. Page images may be copied and saved to a file on the current filing system.

### Terminal Mode

In terminal mode all input may be copied into a buffer in memory or spooled directly on to disc. Full control over buffered data is provided allowing it to be listed to screen or printer, sent to the RS423, saved to or loaded from the current filing system (including TAPE).

Commstar allows full configuration and easy control over the protocols used. Send and receive baud rates, word length, parity and number of stop bits are selected from a simple table of options.

When in chat mode (80 or 40 column), characters transmitted by the host will be displayed on the BBC screen and characters typed on the BBC will be sent to the host. Commstar allows ANY type of file (not just ASCII) to be transferred safely using XMODEM protocols. In fact, four individual methods of transmission are provided for within Commstar giving great flexibility.

Using a disk based emulation file, Commstar can be configured to emulate virtually any terminal type including VT100, within the capabilities of the BBC. In addition to the above, most MOS commands can be executed from within Commstar, errors are trapped by Commstar's own error handling routines and an optional elapsed time clock may be displayed. Data filter, Local Echo, Arits-line-feed, printer on/off and XON, XOFF protocols may be toggled in or out by a single key press, extensive use being made of the function keys. Finally, Commstar may be fitted into any of the sideways ROM sockets and is provided with a comprehensive manual.

£34 inc. VAT & Carriage.

## A revolutionary new approach to program development aids.

Toolstar is a powerful new utility Rom that will open up a whole new world for BBC micro users. Toolstar adopts a revolutionary new approach to program development aids. It has been designed specifically to assist both Basic and Machine code programmers by providing an integrated set of powerful building blocks which rapidly become an indispensable complement to the built-in facilities of your BBC micro.

This package contains the Toolstar firmware in Eprom and a very comprehensive manual (over 150 pages), containing many examples and illustrations to help you make the best use of

### Toolstar's exciting capabilities

#### Toolstar sheds new light on your BBC micro

Toolstar, being Eprom based will be permanently resident in your computer allowing all of its commands to be immediately available. It is transparent to both the user and the operating system, once a command has been executed, control is returned to Basic or whichever ROM had control prior to the command.

Full error handling has been incorporated and for new users there are full help menus describing each command and its syntax.

#### Powerful building blocks for Basic programmers?

Within Toolstar there are 22 commands, 8 of which operate between PAGE and TOP (i.e. on the current Basic program or Basic programming environment). These commands obey standard Basic command syntax rules.

#### Reveal the deepest secrets of your discs

Toolstar allows the operations of Formatting, Verifying, reading or writing a disc sector to be carried out very simply from Basic, i.e. all the necessary building blocks required to develop a comprehensive set of disc utilities, simply and effectively.

#### Lost your memory? - No more amnesia with Toolstar!

In addition to the commands described above there are 9 commands which operate on the whole of the BBC's memory and are designed to complement the BBC's built-in assembler. These include a full lea/re disassembler and memory dump, each with forward and reverse scrolling.

#### If this is not enough Toolstar can be Extended!

There are three help menus on Toolstar which may be obtained by typing HELP TOOLS, HELP MCODE or HELP EXTEND. The third option menu will initially display the following:

HELP EXTEND

EXTEND RAM add

(i.e. typing 'EXTEND' address) will allow the user to extend the facilities of Toolstar with routines which are supplied by himself. The manual describes fully how this operation is carried out and illustrates it with several examples.

In the future such utilities will be made available on disc and cassette from Pace, thus allowing a comprehensive library of utility programs to be built up.

£34.00 inc. VAT & Carriage.

**Access and Barclaycard  
Dealer Enquiries welcome  
Send for more information to:**



**92, New Cross Street,  
Bradford BD5 8BS.  
Telephone: 0274 729306  
Telex: 51564**



# CONTROL SOFTWARE

# THE CUBE SOLUTION

# UNIVERSAL HARDWARE

BBC BASIC

Multi-tasking  
FORTH

Assembler  
(6502 & 6809)

PL/9

PASCAL

'C'

Take our hardware

Choose the software environment

Develop your application

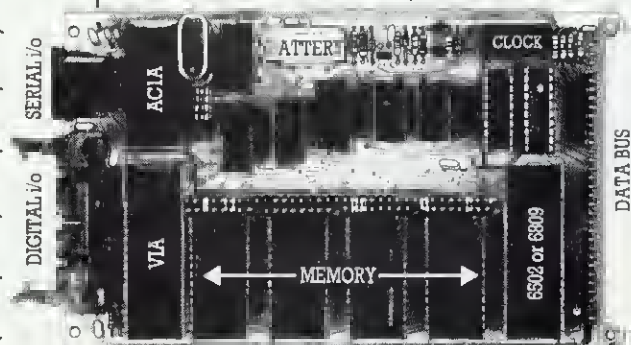

EuroCUBE single board computer

**Control Universal Limited**

**CUBE Industrial Microcomputers**

Andersons Court, Newnham Road,  
Cambridge CB3 9EZ. Tel. (0223) 358757



## THE MIDDLESEX CENTRE FOR BBC

Everything for the Acorn/BBC Owner under one roof.

ACORN ELECTRON — £199    BBC + ACORN DFS £469

BBC MODEL 'B' — £399

Disk Drives by: TEAC, BBC, MITSUBISHI, AMS, CUMANA, KORMANDI, TORCH and others from £149.00

Monitors by: NOVEX, PHILIPS, MICROVITEC, FIDELITY from £79.95

Printers from EPSON, STAR, BIT, SHINWAY, BROTHER, JUKI, UCHIDA, CANAN, TAXAN etc. etc

Accessories: Lightpens, Dust Covers, Joysticks, Monitor Stands, Cases, Leads, Floppy Discs and much much more

SOFTWARE: GAMES, BUSINESS & EDUCATIONAL plus PROGRAMMING AIDS on Cassette, Disk or Rom.

SECOND PROCESSORS, Z80's PACKS, UPGRADES, ROM FITTING, REPAIRS, TESTING etc. etc

# PLUS!

Special Word Processing, Business and Programming starter Kits offered to meet your requirements at good savings.

WE WILL BETTER ANY GENUINE OFFER IF THE PRICE IS LOWER THAN OURS

## SCREENS MICROCOMPUTERS

(A Division of Mayfair Computer Services Limited)

6 MAIN AVENUE, MOOR PARK, NORTHWOOD, MIDDLESEX, ENGLAND.

Tel: NORTHWOOD (09274) 20664  
Telex 923574 ALACOL G.

- ★ Open 6 days per week. Easy Parking.
  - ★ Worldwide fast, reliable mail order.
  - ★ Official Orders/Enquiries welcome.
- Visa . Access . Amex . Diners Club . Instant Credit



# PROGRAMMER'S REVENGE

The Programmer used to play the adventure games found on mainframe computers. He thought he could do better. He tried. His friends urged him to publish.

Not for thugs whose idea of intellectual recreation is to go around beating up hapless trolls, *Revenge* is a puzzle adventure game set in a strange but beautiful landscape closer to home than you think. Some problems require hard lateral thinking, some are merely whimsical: all are deeply satisfying to solve.

Data compression is used to fit a novelette-length game into your micro. The program understands commands of up to four words, with a large vocabulary. Over 300 locations, save and restore facility. Characters you will meet on your travels include the Programmer himself.

*A superior quality adult adventure game. Spend your winter evenings exploring!*

Order form:

**COLISOFT, PO Box 195, 53 Carlton Road, Oxford OX2 7SQ**

Enclose cheque/PO for £8 incl., made payable to COLISOFT, plus your name and address.

**FOR THE BBC 32K ONLY - CASSETTE**

(Further enquiries to C. Jack, 53 Carlton Road, Oxford OX2 7SB)

# Warning: these gam



ci  
a  
an  
la

yo  
ob  
wh  
Se  
ab  
to

yo  
yo  
pr  
An  
pu

kil  
you  
ow

min  
you  
bas  
sne  
hin

a pa  
rect  
to d  
by p  
run

siler  
Heli  
slope  
the s  
orsh



# Games show no mercy.

Acornsoft have now unleashed eight more merciless games onto unsuspecting BBC micro owners.

Ranging from 'Gateway to Karos', where putting a foot wrong could mean instant death. To the relentless antics of Droгна which could have you dying with laughter.

## Gateway to Karos.

An adventure game in which you'll need all your patience and ingenuity just to stay alive. Your objective is to find the Talisman of Khoronz but, whichever path you choose, you'll be beset by treachery. Serpents lie in wait and magical phenomena are in abundance. Should you find the Talisman, you've still to find your way back.

## Kingdom of Hamil.

As the rightful heir to the Kingdom of Hamil, you are in the unusual position of having to prove your claim to the throne. Evil people are trying to prevent you accomplishing your task by any means. An adventure game fraught with many dangers, puzzles and problems.

## Tetrapod.

You're in an arena littered with dormant lizards, killer bees and other hostile creatures with whom you'll have to do battle to survive. But beware of your own laser bullets, as they bounce off the arena walls.

## Droгна.

A game for two people - preferably with devious minds. There are two vaults containing diamonds and your job is to collect and transfer them to your home base. While your opponent is out collecting you could sneak in and steal his loot... but keep an eye out for him doing the same to you.

## Crazy Tracer.

An arcade style game where you're in charge of a paint roller. Guide your roller around a maze of rectangles while evading monsters who are committed to destroying it. Gain extra rollers and bonus points by painting different objects. But you'll have to avoid running out of paint.

## Volcano.

Mount Crona has erupted after 150 years of silence. And your mission as an Emergency Rescue Helicopter Pilot is to save sightseers stranded on the slopes. Time is of the essence as the lava approaches the sightseers. But you'll have to take time to evade - or shoot - the boulders being hurled from the volcano.

## Carousel.

A re-creation of the fairground shooting gallery - with a difference. Shoot down all the ducks, owls and rabbits before you run out of ammunition. Watch out for the low-flying ducks. If you fail to shoot these, they'll steal your bullets and reduce your chances of success.

## Meteor Mission.

On an alien planet are six stranded astronauts. Launch your capsule from the Mothership and by avoiding - or shooting - meteors and alien craft, pick up the astronauts one at a time and return them to the Mothership.

All games - with the exception of Gateway to Karos which is currently only available on cassette - can be bought direct in either cassette or disc form. You will find all these programs at your local Acorn stockist. To find out where they are simply call 01-200 0200. Credit card holders, phone 01-200 0200, anytime. Or 0933 79300, during office hours.

Alternatively, you can order the games by sending off the coupon below to: Acornsoft, c/o Vector Marketing, Denington Estate, Wellingborough, Northants NN8 2RL. Please allow 28 days for delivery.

To: Acornsoft, c/o Vector Marketing, Denington Estate, Wellingborough, Northants NN8 2RL.

Please send me the following software games:

PROGRAM	QUANTITY	DISC/CASSETTE
Gateway to Karos		
Kingdom of Hamil		
Tetrapod		
Droгна		
Crazy Tracer		
Volcano		
Carousel		
Meteor Mission		
	TOTAL	

Price: Cassette: £9.95; Disc: £11.50

I enclose PO/Cheque payable to Acornsoft Ltd. Or charge my credit card.

Card Number: \_\_\_\_\_

Barcode/Access (Delete)

Name \_\_\_\_\_

Address \_\_\_\_\_

Postcode \_\_\_\_\_

Signature \_\_\_\_\_

Registered No. 1521763

VAT No. 215 8123 85

# ACORNSOFT

# THE IMAGE *Plotter*

BY R.T.C.  
BEAUFORT WORKS, BEAUFORT RD,  
RICHMOND RD, EAST TWICKENHAM,  
MIDDX.

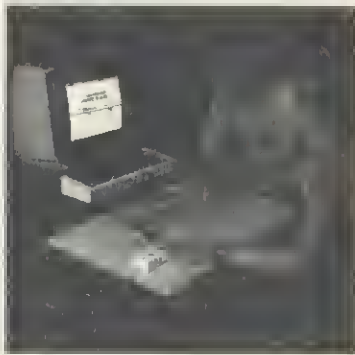

**THE IMAGE PLOTTER** offers your micro a greater flexibility by allowing the reproduction of diagrams, graphs, maps, etc. with exact precision. Even the most irregular and complex shapes can be enlarged or reduced, and shown in Vivid Colour. Using a printer these diagrams can be kept for use in project work, Lectures, Conferences etc. OR stored on disc or cassette for future reference.

**THE IMAGE PLOTTER** comes ready assembled, with calibration sheet and a detailed handbook. At only £49.45 (inc VAT) it's within the budget of schools and home micro users.

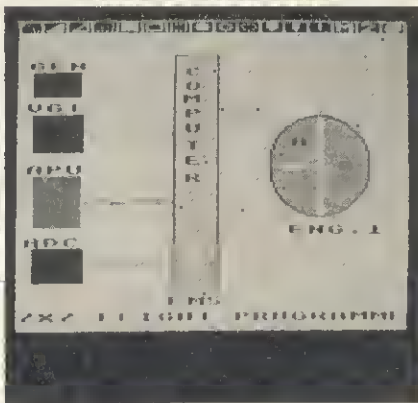
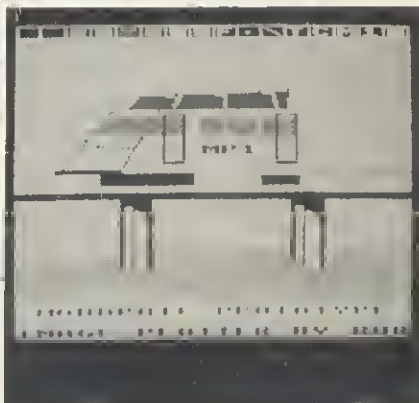

Post to: Reekie Technology Co,  
Beaufort Rd, off Richmond Rd, East  
Twickenham, Middlesex TW1 2PQ

DESCRIPTION	PRICE	QTY	TOTAL
IMAGE PLOTTER	£43.00 + £6.45 (VAT)		£49.45
DISC.			P&P
CLASS			Total
			£2.50
			£

I enclose my cheque/PO for £..... p

Access No. ....  
NAME .....  
ADDRESS .....

# HIGH QUALITY

## Slimline 5 1/4" 100k Disc Drives

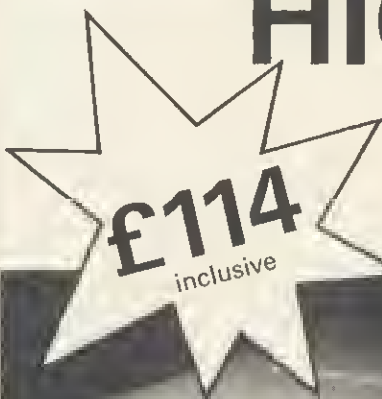

- Precision mechanism – very quiet operation
- Low power consumption. 2.5 watts – fast data access 6 ms step rate
- Automatic centering – Automatic eject
- Professionally cased in metal sleeve finished in BBC cream
- Complete with data and power cables
- Includes formatting disc and manual

Post to: Legend, 50 St Mary's Street, Ely, Cambs. CB7 4EY  
Please send me \_\_\_\_\_ (Qty) Disc Drive(s) @ £114.00 each inclusive of VAT and carriage  
I enclose cheque/P.O. made payable to Legend for value of £

NAME .....  
ADDRESS .....

# LEGEND



# SOFTWARE CHART

TITLE	PUBLISHER	PRICE	MICRO	REVIEWED
1 (1) Frak!	Aardvark	£7.50	B	September '84
2 (2) Fortress	Amcom	£8.95	B	September '84
3 (7) Micro Olympics	Database	£6.95	B	
4 (5) Football Manager	Addictive	£7.95	B	
5 (3) Bagger	Alligata	£7.95	B/E	October '84
6 (11) Overdrive	Superior	£7.95	B	September '84
7 (—) Guardian	Alligata	£7.95	E	
8 (16) Ghouls	Micro Power	£7.95	B/E	June '84
9 (8) Aviator	Acornsoft	£14.95 (£17.95)	B	May '84
10 (6) Chukkie Egg	A&F	£7.95	B/E	September '84
11 (—) Dune Rider	Micro Power	£7.95	B	
12 (—) Hulk	Adventure Int.	£7.95	B/E	
13 (re) White Knight 11	BBCSoft	£11.50, £9.95	B/E	January '84
14 (—) Quick Thinking	Mirrorsoft	£6.95	B/E	
15 (—) Jet-power Jack	Micro Power	£7.95, £6.95	B/E	July '84
16 (—) Colossal Adventure	Level 9	£9.90	B	February '84
17 (—) Zalaga	Aardvark	£7.50		
18 (17) Hunchback	Superior	£7.95 (£11.95)	B	September '84
19 (9) Hobbit	Melbourne House	£14.95	B	
20 (—) Blockbuster	Micro Power	£7.95, £6.95	B/E	

B = BBC. E = Electron. re = re-entry Prices in brackets are for disc version. Where two prices appear, the second is for the Electron version.

## BUBBLING UNDER

Drum Kit (Quicksilva)  
Free Fall (Acornsoft)

Compiled by RAM/Computer

Renegade (Robots Senator)  
Star Striker (Superior)

World Geography (Superior)  
System 15000 (Craig)

'WE was robbed,' said a Database spokesman on hearing that *Micro Olympics* had been held off the number one spot by the dynamic duo *Frak!* and *Fortress*. *Micro Olympics* entered the charts at number 7 last month. *Frak!*, straight in at number one two months ago, looks unshakable and *Fortress* seems to be repelling all attacks on the number two spot.

Straight in from nowhere, Alligata's *Guardian* is the month's highest new entry with yet another variation on *Defender*. Among the deadlies which

have to be zapped are the usual menagerie of baiters, swarms, mutants, bombers, pods and landers. The highest official score is put at 350,000, though unconfirmed reports (read as cheats) clock in at over half a million.

The sudden nose-dive of Bug-Byte's *Twin-Kingdom Valley* out of the charts completely confirms our suspicions about adventurers: a tickle lot who, when no-one's looking, will drop their Tolkien, pick up the nearest pair of joysticks and proceed to zap mutant aliens like the best of us.

Go on then, prove us wrong: we expect

to see Level 9's *Colossal Adventure* at least in the top 10 next month. Talking of Tolkien, Melbourne House's *Hobbit* has slipped from 9 to 19!

*Aviator* continues to circle round the middle reaches of the chart but could well be overtaken by Micro Power's *Dune Rider*, which entered the charts this month - our tip for the top three.

*Elite* is a disappointment to the editor; it's still stranded in hyperspace collecting nubian slaves and has yet to enter your High Street shop, let alone the Top 20. Maybe next month?

# NEW FRONTIERS IN CREATIVE MICROCOMPUTING!

## TWO FANTASTIC, FUN-FILLED GUIDES FROM THE PENGUIN ACORN COMPUTER LIBRARY

### HOW TO WRITE ADVENTURE GAMES For the BBC Microcomputer Model B and Acorn Electron Peter Killworth

An original and easy-to-follow guide containing a multi-purpose BBC BASIC program and database for writing your own adventure fantasies. Watch out JACKSON AND LIVINGSTONE!  
£5.95

### CREATIVE ASSEMBLER: HOW TO WRITE ARCADE GAMES For the BBC Microcomputer Model B and Acorn Electron Jonathan Griffiths

Creator of such top-selling games as *Snapper* and *JCB Digging*, Jonathan Griffiths steers you to a practical understanding of the powerful ASSEMBLER facility to produce an action-packed arcade game.

CREATIVE ASSEMBLER  
How To Write Arcade Games  
for the BBC Microcomputer Model B  
and Acorn Electron  
Jonathan Griffiths

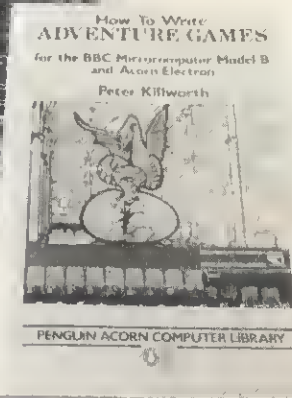

## GRIFFIN COMPUTERS

### SOFTWARE

Acornsoft (C)	£7.95
Micro power (C)	£6.95
Micro power (D)	Please ring.
Wordwise (R)	£36.00
Graphics (R)	£27.50
Disc doctor (R)	£27.50
Caretaker (R)	£27.50
Printmaster (R)	£27.50

### HARDWARE

BBC B	Please ring for latest offers.
Acorn electron	£195.00
Disk drives 100K	£99.00

A full range of peripherals is available, prices on application. Printers—£172.00. Monitors—£199.00. Discs from only £12.00.

All the above prices include V.A.T. (@ 15%  
(C)—Cassette (D)—Disk (R)—ROM

GRIFFIN COMPUTERS  
8, RAINSFORD ROAD, STANSTEAD  
ESSEX CM24 8DU  
Tel. 0279 812295

## Tandy Graphics Printers For Quality and Efficiency!

### Ultra-Compact Colour Graphics Printer

£149<sup>95</sup> Inc. VAT

- Prints in Four Vivid Colours
- Uses Easily Replaceable Ink Cartridges
- Includes Serial and Parallel Interfaces



26-1192

### Colour Ink-Jet Printer

£499 Inc. VAT

- High-Resolution Ink Jet Printer
- Prints in Seven Colours

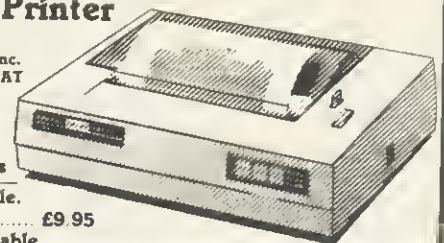

Model 100 Interface Cable.  
26-1409 ..... £9.95  
BBC Model B Interface Cable.  
26-7203 ..... £39.95

26-1268

Take A Look At Tandy, Today!  
See Our Extensive Range of Microcomputer Accessories  
At Any One of the 350 Tandy Stores Nationwide!

Prior to this advertisement, all quoted regular prices have been charged during the last six months at the Tandy Store, Tameway Tower, Bridge Street, Walsall, West Midlands WS1 1LA

Known As Radio Shack in The U.S.A.  
Prices may vary at Dealers  
Offers Subject to availability



## CANNONS IN

## THE CANYON

'Eagle's Wing', Software Invasion, BBC B, £7.95 (£11.95 disc)

THERE you are, doing some daring low flying down the canyon, guns blazing, defence batteries blasting away at you, enemy planes attacking from all angles, but on you go, pausing only occasionally to dock with your sister ship (a bit unsavoury that, I thought) to refuel, re-arm and repair damage. Sounds familiar? If you were a resident of Teesdale when the NATO exercises are on it would. All except that bit about defence batteries.

Still, I have been promised a pen-knife for my next birthday. Watch out, Brylcreme boys!

If you like blatting anything that moves, this is your game. The screen scrolls sideways at a speed controlled by you (if, unlike me, you have mastery of the digits) and you have to steer a course between the canyon walls, while assorted pillboxes, ships, planes and missile launchers are being less than hospitable.

You have three kinds of blatter: air-to-air cannon, air-to-ground cannon, and air-to-ground missile. You have a limited supply of each, of course, and your fuel has a nasty tendency to run



In 'Eagle's Wing' you have to fly between the canyon walls while pillboxes, ships, planes and missile launchers fire at you. The screen scrolls sideways under keyboard control

out. The object of your mission is to destroy the enemy missile silos and associated command centres (and to cause the inhabitants to write ferocious letters to the local *Bugle*).

This is a really well-packaged game. It has tickertape-type instructions scrolling across the screen, and appropriately martial music—two tunes—playing while the main game is loading. The graphics are excellent: satisfying crump-type explosions, black at the centre, fringed with red and yellow. My son, Ghengis, plays it for hours at a time, as would I if only I could get my fingers under control.

There's a hall of fame and a demo facility to let you see what you're in for. Very good.

Harry Sinclair

## PUMPING ALIENS

'Digger', Visions (Software Factory), BBC B (OS 1.2, £7.95)

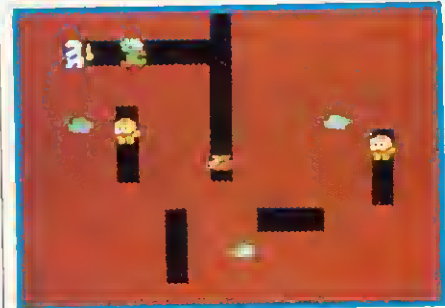

NOW let me see. Red Goggle Aliens are called Footas. Green Dragons are called Pubars. Pumping is only done horizontally and each pump is neutralised by each 'pip'. Just as well I suppose. Right.

This game has got nothing to do with corks on your hat. You are an allotment-owner plagued by the aforementioned Footas and Pubars. They lurk underground but can't pass through the earth unless they turn into ghosts. You, on the other hand, are a bit of a whizz at tunnelling, and your pumping is of Olympic standard. Pubars can breathe fire and gamma rays which do you a power of no good.

To destroy these bounders you can either pump them up and cause them to explode, or you can get more points by digging earth from under rocks and hoping that they fall and squash your foes. Success, as ever, only leads to greater torment. More and faster thingies harass you until it all becomes too much. This happened fairly early on.

I and my team of expert testers found the game rather uninspiring and initially difficult to fathom. I didn't know what was going on. Finding out didn't help much. It's OK, but not outstanding. I might even recommend it if, like the others, it wasn't so expensive.

Harry Sinclair

## JAIL BAIT

'Spooks and Spiders', Software Invasion, BBC B, £7.95

SCENARIO: a prison block with several galleries. Locked cells, one of them containing a beautiful damsel. The key to the cells and the maiden's heart is there, but to get to it you have to avoid the ghosts of long-dead prisoners and awful-looking spiders. You can jump on the spiders though, acquiring points and dirty shoes in the process, but you have to make sure that neither they nor the ghosts jump on you or you will lose one of your three lives. Later on, some of the ghosts turn into fast-moving skulls which are very difficult indeed to avoid.

Having cunningly worked your way through to the key and grabbed it, you have to go to each cell door in a random sequence and unlock it. When you open the last cell, there is the grateful damsel. She's so grateful, in fact, that you have to do it all over again but this time there are even more spooks and spiders after you. All the time the bonus score is heading towards zero, as are



your chances of survival.

The graphics are quite good and if you don't mind the fact that the storyline is probably fictional you could like this game. It will appeal to those who like Acornsoft's *Monsters*.

The package is nicely put together but, unlike *Eagle's Wing*, from the same stable or eyrie (please tick), it doesn't have the interrupt-driven music and graphics to entertain or irritate you while it is loading.

Harry Sinclair

# Increase your fire power!

## More than just a joystick - a system

- ▲ Nylon encased — Steel shafted joystick with ball and socket joint.
- ▲ Fast sprung return to centre.
- ▲ Graphite wiper linear potentiometers.
- ▲ 12 Months Guarantee.
- ▲ 7 day Money back Guarantee (on Hardware).

**DELTA 14b HANDSET £14.95**  
**DELTA 14b/1 A/D/USER PORT INTERFACE £14.85**  
**DELTA DRIVER CASSETTE £5.95 or DISC £9.95**  
 Prices include VAT and P&P. SAE for more detailed information.

**VOLTMACE LTD**  
**PARK DRIVE**  
**BALDOCK**  
**HERTS**  
**SG7 6EZ**  
 Tel: (0462) 894410

Numerous stockists nationwide or direct from us.



Callers welcome at the factory — Monday to Friday.

## Complete control at your fingertips

A superb joystick and a keypad for the price of either one. Plus the software to integrate it into the computer's system.

One handset will work on it's own in the A/D port as a joystick and two fire buttons. Joystick is immediately compatible with ACORN/SOFT and similar software. The interface joins together the analogue and the user ports to use the full keypads giving a total of 24 user definable keys. The interface can also be used as a splitter for the A/D port to take two items at the same time, e.g. joystick and lightpen.

DELTA DRIVER on cassette or disc: Two programs on each cassette or disc. One converts machine code programs from the keyboard to the joystick or keypad, with adjustable sensitivity on the joystick and will run on any O.S. The second program (needs O.S. 1.0 or later and an interface) duplicates any keyboard keys on the keypads, in the operating system, so that it can become a numeric keypad or will take on the function keys.

# Voltmacedelta 14b

See our programs on MICRONET 800

Proxima

**PERSONAL COMPUTER SOFTWARE**

*Beeb-Text Features*

**Width**

**Height**

**Italic**

**BIG Print**

(c) Proxima Software

Very tall text

**Fonts**

ONE FIVE

SIX SEVEN

THREE FOUR

BRIGHT

Spacing

Spacing

Spacing

**Thickness**

**THINK BIG** \*

A highly effective machine-code program for displaying any dimension text. Can be incorporated into other programs.

Cassette £5.95  
Disc £8.95

**PIXEL PACKAGE** \*

Two programs are supplied for designing single colour and multi-colour characters and designs can be mirrored, inverted and duplicated. The programs even store the resulting data in program lines ready to be used.

Cassette £7.95  
Disc £10.95

**DISC TOOLS** the complete utility disc for twin 80 track drive users and includes a 40/80 or 80/40 backing up facility.

Disc £10.95

**ROBRAIN** Arcade Fun. Disable the robot's positronic self defence.

Cassette £7.95  
Disc £10.95

**TWO PLAYER GAMES** \*

Two 2-player games including 4Line and Frustration, joystick compatible.

Cassette £6.95  
Disc £9.95

▲ Prices are fully inclusive, no extra to pay.

▲ P&P on all orders is FREE!

▲ Please make cheques/P.O.'s payable to PROXIMA SOFTWARE.

Proxima Personal Computer Software, 1G10 1BT, Newlands, 30 Sparelease Hill, Loughton, Essex, Tel. 01-502-0230

Please specify 40 or 80 track or 3" types when ordering discs.

Our FREE program special offer continues. Contact us for details!



# WP

Chris Drage in the international set

# WITH AN ACCENT

'BBtype', Furey Enterprise Products, Hildenborough, Kent TN11 9EY, BBC B (OS 1.0 or later), £23 inc VAT and p&p, cassette or disc

**B**BTYP from Furey Enterprise Products is a multiple character-set WP written (in its current form) for the Epson MX, RX and FX ranges of printers, covering French, Italian, Spanish, German/Scandinavian, technical symbols and mathematical symbols.

It is designed for teachers, students, foreign correspondents and anyone who wants mainly to produce several copies of single sheets – for example, business letters or exam papers.

The package arrives in a flimsy box and appeared to be printed upside-down! Inverting the box and opening it revealed a C40 cassette, a BBkey with character set definitions and an instruction booklet (figure 1).

The cassette contains the source code, which must be copied onto a disc (or working cassette). The process is entirely automatic for disc users and it takes about 20 minutes to create a working disc. Cassette users must swap the two cassettes in the recorder and it can take up to 45 minutes.

Installation is not complete, however, until the Epson DIP switches are set to the following defaults: slashed zero; 11in page-length; forced line-feed with carriage return; computer control of printer; and English or USA character set. The instruction booklet is very helpful and guides you through step by step.

Once the working disc is 'booted' a menu appears with the character set options available. For the technical and mathematical options an additional option of ungapped print is given. This prints lines with no vertical spaces between them, enabling you to print large unbroken symbols for matrices (see keyboard printout, figure 2), determinants and integrals. It also improves the appearance of subscripts and superscripts. For ordinary text the normal option should be used.

Next, the printer must be switched on and put on line before the text screen appears. This is important as *BBtype* is not really designed to work without a printer.

The text screen comprises a blank 20-line 'window' of a page of text 66

lines long, each line holding 80 characters – bad news for owners of television sets as no 40-column alternative is available. A status line at the top of the screen gives information about current line, character set in use, in-file and out-file. Line 22 provides a reminder of the commands necessary to print, load, save and restart (figure 3).

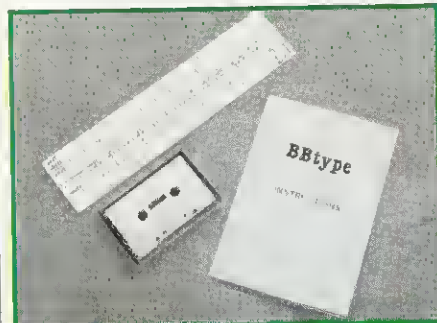

Figure 1. The BBtype package, with BBkey

As all special characters are available only through the function keys, the inclusion of the BBkey template booklet is welcome. It is clear, well-printed and easily managed. As with all BBkey function templates, it slips under the clear plastic strip above the Beeb's function keys and provides all the special characters and commands necessary to run *BBtype*.

Entering text is simple. Through a combination of the normal keys and function keys a page of text is quickly assembled. Each special character is displayed as it will appear in print. You move over the screen using the cursor keys, inserting text where you like. If you try to go 'off the bottom' or 'off the top' of the screen the window will move 10 lines up or down as appropriate, and you carry on. It's impossible to write beyond the bounds of the 66 × 80

'page', nor can the information at the top and bottom of the screen be overwritten.

Movements to the boundaries of the document are achieved by use of the CTRL plus cursor keys. Deletions are achieved through the use of the Delete key or by simply overtyping the text. Lines and characters may be deleted and inserted by use of Shift plus cursor keys. Care must be taken when inserting lines as any text pushed beyond the 66 line/80 character limit is irrevocably lost. Lines may be repeated by use of the Shift + CTRL + cursor down key.

Tab stops are limited to just three, which is not really adequate. Each may be defined by the user. The BBC's Tab key moves the cursor to the required stop. We have come to expect facilities such as justification, search/replace, paging and continuous processing to be available on all word processors. In *BBtype* they are simply not present, presumably due to lack of memory.

Printing is also simple. Press the Copy key. If there is text in the memory to print, it will appear exactly as you see it on the screen (figure 4). There are two minor exceptions, however: the number '7' prints barred for foreign character sets, and gaps between lines always appear on screen even though you opt to suppress them on printing. You must retrieve all text in order to print it. All printing takes place from memory. By using continuous stationery multiple copies are possible. If you require ten copies press the Copy key ten times.

Shift + Copy loads text, CTRL + Copy saves it. All filenames have a logical, common format. The directory letter is always the first letter of the character set in use – 'S' for Spanish, 'M' for

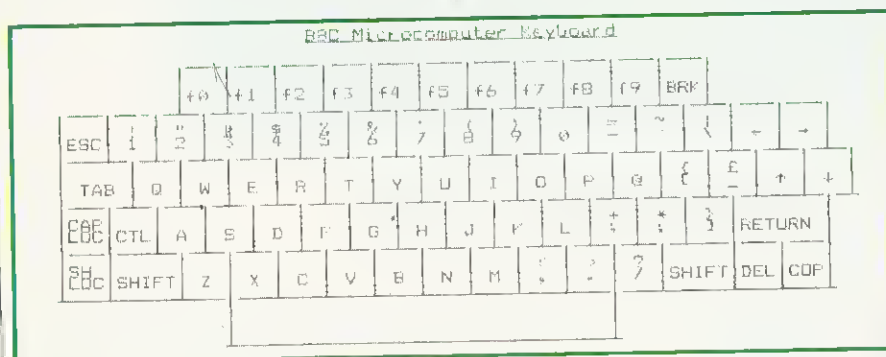
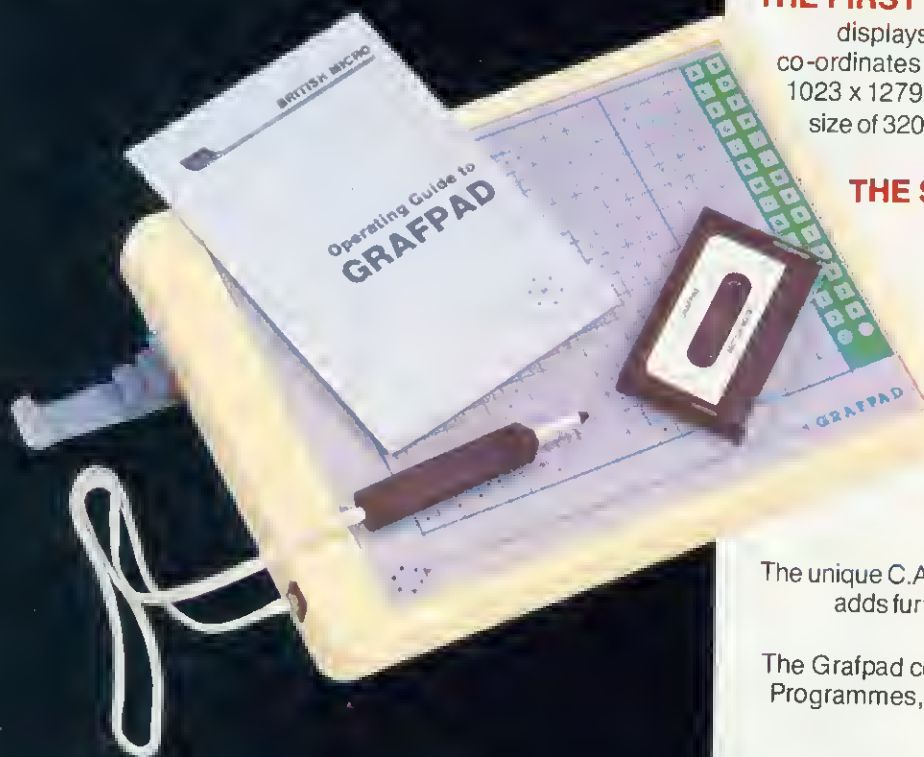

Figure 2. Sample printout using technical option

# GRAFPAD

...for as many uses  
as YOU  
can imagine!



## BBC MODEL B • SPECTRUM COMMODORE 64

With Grafpad you can now add a new dimension to your computer enjoyment, but most important, it helps you create your own application programmes by the simple use of the Grafpad!

The BBC Grafpad comes complete with cassette and disk comprising of three programmes.

### THE FIRST PROGRAMME

displays the co-ordinates of your screen area. The co-ordinates are based on the screen with a grid size of 1023 x 1279 pixel, also in the Grafpad giving you a grid size of 320 x 256 pixels! This is to allow you to write your own graphic programmes.

### THE SECOND PROGRAMME

provides you with the utilities for circles, squares, triangles, free-hand, erasing line-drawing etc, and of course, full "Fill-in" facility in 16 different colours by the simple use of the pen!

Draw from a simple apple to a computer circuit - store in cassette or disk, perhaps transfer direct to a printer - in black and white or full glorious colour!

### THE THIRD PROGRAMME

The unique C.A.D. (Computer Aided Designs) programme adds further enjoyment and professionalism to your computer designs!

The Grafpad comes complete with Operational Manual, Programmes, The Grafpad and Pen and it simply plugs in your computer.

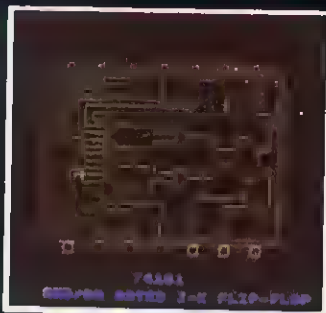
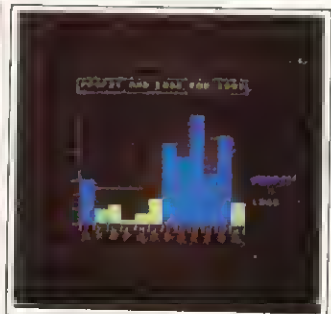
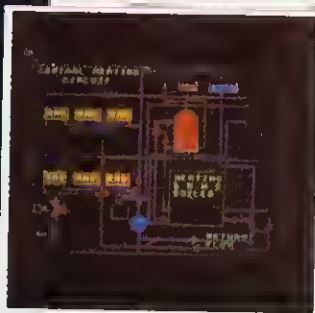
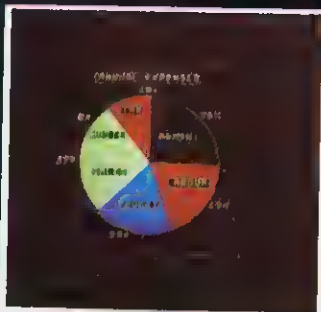

(The above designs were drawn by a 12-year-old at our showroom!)

(Size: 25mm height x 355mm width x 260mm depth)  
Weight: 1.2kg (Gross)

#### HOW TO ORDER:

##### BY TELEPHONE:

If you are an Access Card Holder simply telephone us giving your Card No., Name, Address and item(s) required and your orders will be dispatched within 48 hours!

##### BY POST:

Simply fill in your requirements on a sheet of paper, enclosing your cheque/P.O. made payable to: BRITISH MICRO. Please allow 14 days for delivery.

- DEALER INQUIRIES WELCOMED
- SPECIAL DISCOUNTS FOR EDUCATIONAL AUTHORITIES

## BRITISH MICRO

A HEGOTRON GROUP COMPANY

Unit Q2, Penfold Works, Imperial Way, Watford,  
HERTS WD2 4YY  
TEL: (0923) 48222.  
TELEX: 946024





AMER DE TOUR (N°1) - FR. (ETAL.) LONG FILE-D. COMPLE. HOME FILE-D. BRUELE  
 applaudit notre spectacle et voir à travers nos danseurs et nos musiciens  
 l'âme à la fois rude et gaie de nos pères.

Fondé en 1933 par un musicien local de talent, Jean PITACCO, après  
 de notre pays, notre Groupe fut dirigé par un autre Vellave talentueux:  
 le peintre Pierre FAVIER. Il est actuellement fort d'une cinquantaine  
 de membres, tous amoureux de leur pays, de leurs traditions, et prêts à  
 porter bien haut le blanc et le bleu vellaves.

Notre but est ambitieux : conserver scrupuleusement notre patrie  
 moine : chant, danse, musique, langue, costumes, coutumes, vieux métiers,  
 habitat, etc... La tâche est complexe, difficile et de longue haleine, et  
 nous y apportons tout notre enthousiasme.

Groupe Folklorique "Le Velay" du Puy.

Commandes: COPY-print, BEEP1 COPY-load, CTRL COPY-save, BEEP2 CTRL COPY-restore

Figure 3. BBtype text screen with reminder at line 22

mathematics and so on. A 'cold' start is achieved by pressing CTRL+Shift+Copy simultaneously: All irrevocable actions are trapped and you are given the choice whether or not to continue. The Break key is tully trapped. Nothing is lost from the accidental use of this key.

BBtype provides an exit mode. Pressing Escape allows you to wander 'off-stage' into Basic should you wish to perform some calculations or access the DFS commands. I found the \*TYPE command invaluable here. It enables you to list any BBtype file for reference while you edit the current one. Typing RUN <RETURN> enables you to return to the text.

The 12-page A5 instruction booklet is

clearly written and straightforward, providing useful tips such as how to mix character sets in one document. It also provides a good deal of assistance when things go wrong.

Clearly, BBtype is not a wordprocessor. Its lack of wordprocessing facilities places it firmly in the text editor bracket. Yet it provides a useful tool for anyone who needs characters other than normal English. Its lack of printer control codes is a limiting factor for those wishing to get the most from their Epson printers. Double printing is possible but many other printer facilities are not. Linguists and purists will complain that the capital letters are printed with accents, but in my experience it is something that most people do any-

way. One application of BBtype that is not readily apparent is its uses for Gaelic-speaking people. I'm sure our Scottish, Welsh and Irish colleagues could use its French character set.

Educationalists will be disappointed to learn that BBtype will not function on the Econet Level 1 system.

BBtype allows the BBC micro to create and edit documents with non-standard characters in addition to the normal characters. At £23, though, it appears overpriced. Its general-purpose approach and use of cassette for the system master is to be commended. It is very user-friendly and failsafe. It is unfortunate that the limitations of the mode 3 screen permit only the most fundamental WP facilities.

## A MINDER FOR ALL THOSE PROCEDURES

Source Library Manager (SLM) ROM, Guardian Software, 21 Harvey Road, Walton-on-Thames, Surrey, BBC micro, £36 (inc P&P)

'EVENING guv, nice 'ouse you got 'ere. Need any extension work doing - kitchen, loft? No? Well 'ow about your BBC micro? With all those extra ROMs you need the Acme backwards ROM expansion board. ROMs are easily removed with a chisel and it draws no power from the computer - instead it uses a 12-volt car battery discreetly mounted on the board. Guarantee? You trying to ruin me?'

So many ROMs seem to be coming onto the market these days that I wouldn't be surprised if I were subjected to this kind of spiel from a foot-in-the-door salesman. One of the recent additions is grandly called the *Source Library Manager* - SLM for short.

SLM is a ROM-based utility program that lets a programmer store commonly used procedures and routines on disc. Up to 199 such 'members' can be stored on a 40-track drive and these can be retrieved and then assembled together to form a program. You still need to add code to call these routines

but nevertheless a lot of the slog of programming can be avoided.

The ROM chip is inserted in a spare sideways ROM socket - if there are none spare see special offer above - and it is accessed by \*SLM. To show that the ROM is in use, a 'frame' appears around the screen consisting of the title 'Source Library Manager' at the top and a 'command' line at the bottom.

The 'Member Functions Menu' appears in this window and this contains the commands used most often. Assuming that before typing \*SLM you had a piece of code on the screen, this can be saved to disc with the 'Create Source Member' option. You supply a name for the routine - up to eight characters - and a 20-character description. If you decide to change that routine, it can be retrieved off disc, modified and saved with the same name, but SLM will also keep the old version - in fact up to 99 versions of the same member can exist. Normally only the latest version is retrieved from the disc but there is a menu option to make any older version retrievable.

As well as 'source members' there are 'definition members'. A definition is

a list of source member names that you want to use to make a program. Definition members, like source members, can be created, deleted and obtained from disc, and different versions can exist of the same definition member.

The most powerful feature of SLM is the 'Construct Defined Program' option: this will take a definition, fetch all the source members named in it from the disc and assemble all the pieces of code together, in order, so as to make up a program. All you then have to do is finish it off with a few lines to call the various procedures.

Once you've got the hang of the jargon used, *Source Library Manager* works very well and, being ROM-based, it takes up no user RAM. The disc capacity, in terms of the number of members that can be held, is a great improvement on the 31 files allowed by the DFS. For serious programmers who often find themselves using standard procedures in their programs, it will quicken this process and it's considerably easier than the method quoted in the BBC micro *User Guide* for merging pieces of code. However, few other users would be able to justify the £36 price-tag.

Geoff Nairn

### NOTRE GROUPE

De nombreuses régions de France et de pays étrangers ont pu déjà applaudir notre spectacle et voir à travers nos danseurs et nos musiciens l'âme à la fois rude et gaie de nos pères.

Fondé en 1933 par un musicien local de talent, Jean PITACCO, après de notre pays, notre Groupe fut dirigé par un autre Vellave talentueux: le peintre Pierre FAVIER. Il est actuellement fort d'une cinquantaine de membres, tous amoureux de leur pays, de leurs traditions, et prêts à porter bien haut le blanc et le bleu vellaves.

Notre but est ambitieux : conserver scrupuleusement notre patrie moine : chant, danse, musique, langue, costumes, coutumes, vieux métiers, habitat, etc... La tâche est complexe, difficile et de longue haleine, et nous y apportons tout notre enthousiasme.

Groupe Folklorique "Le Velay" du Puy.



# Electronequip

(Authorised BBC Micro Dealer, and Econet Service Centre)

**NEW View Printer Driver.**  
For FX-80, BROTHER HR15, JUKI  
and KAGA/TAXAN 40/80T disc  
£9.95 inc VAT

Ref	BBC Cassette Software	Exc VAT	Inc VAT
BCAAFRAK	Aardvaak Frak (Caveman game) (BBC Cass)	7.00	8.05
BCAAZAEA	Aardvaak Zalaga (BBC Cassette Software)	7.00	8.05
BCADFOOT	Addictive Football Manager	5.87	6.75
BCAFBOUN	A & F Software Bouncer	5.92	6.81
BCAFCHIC	A & F Software Chuckle Egg	5.84	6.72
BCAFCYLO	A & F Software Cylon Attack	5.84	6.72
BCAFFROG	A & F Software Frogger	5.92	6.81
BCAFPAIN	A & F Software Painter	5.92	6.81
BCAFSHRI	A & F Software Shrinking Professor	5.92	6.81
BCAIAOVE	Adventure International Adventureland	7.36	8.45
BCAIPIRA	Adventure International Pirate Adventure	7.35	8.45
BCAISECR	Adventure International Secret Mission	7.35	8.45
BCAIVOODO	Adventure International Voodoo Castle	7.35	8.45
BCAKCHL	ASK Children from Space (XBE16)	7.35	8.45
BCAKCRAN	ASK Cranky (XBE17)	7.35	8.45
BCAKFACE	ASK Facemaker (XBE10)	7.35	8.45
BCAKHIDE	ASK Hide & Seek (XBE11)	7.35	8.45
BCAKLETS	ASK Let's Count (XBE12)	7.35	8.45
BCAKNUMC	ASK Number Chaser (XBE15)	7.35	8.45
BCAKNUMG	ASK Number Gulp (XBR13)	5.82	6.69
BCAKNUMP	ASK Number Puzzler (XBE14)	7.35	8.45
BCAKWORDO	ASK Words, Words, Words (XBE19)	7.35	8.45
BCALBUBS	Alligata Software Bug Blaster	5.88	6.76
BCALCOSM	Alligata Software Cosmic Asteroids	4.39	5.06
BCALDAMB	Alligata Software Dembusters	5.87	6.75
BCALEAGLE	Alligata Software Eagle Empire	5.87	6.75
BCALFRUI	Alligata Software Fruit Machine (B006)	4.39	5.05
BCALUNCL	Alligata Software Uncle Claude (BBC Cas)	7.00	8.05
BCAMALGE	Ampalsoft Cheshire Cat Algebra 0 level	5.13	5.90
BCAMARIT	Ampalsoft Cheshire Cat Arithmetic 0 level	5.13	5.90
BCAMCALC	Ampalsoft Cheshire Cat Calculus 0 level	5.13	5.90
BCAMCONS	Ampalsoft Cheshire Cat Construction "G"	5.13	5.90
BCAMGRAP	Ampalsoft Cheshire Cat Graphs 0 level	5.13	5.90
BCAMTRIG	Ampalsoft Cheshire Cat Trigonometry "O"	5.13	5.90
BCASIDOP	Acornsoft 100 Programs for BBC Micro	8.50	9.78
BCASAACCT	Acornsoft Arcade Action (SBG06)	8.80	10.12
BCASAPCA	Acornsoft Arcadians (SBG14)	7.35	8.45
BCASAVIA	Acornsoft Aviator flight simulator (SBG02)	11.05	12.71
BCASBUSI	Acornsoft Business Games (SBG03)	7.35	8.45
BCASCARD	Acornsoft Carousel (SBG24)	7.35	8.45
BCASCASG	Acornsoft Castle of Riddles (SBG17)	7.35	8.45
BCASCHAN	Acornsoft Chemical Analysis (SBE12)	10.20	11.73
BCASCHES	Acornsoft Chess (SBG10)	7.35	8.45
BCASCHSI	Acornsoft Chemical Simulations (SBE13)	10.20	11.73
BCASCHST	Acornsoft Chemical Structures (SBE14)	10.20	11.73
BCASCOLL	Acornsoft/ICL Collectors Catalogue (SBX06)	7.35	8.45
BCASCOUN	Acornsoft Countdown to Doom (SBG19)	7.35	8.45
BCASCRAZ	Acornsoft Crazy Tracer (SBG26) (B)	7.35	8.45
BCASCREA	Acornsoft Creative Graphics (SBX01)	7.35	8.45
BCASDESK	Acornsoft Desk Diary (SB001)	7.35	8.45
BCASDRAU	Acornsoft Draughts & Revers (B) (SBG20)	7.35	8.45
BCASOROG	Acornsoft Drogna (SBG27) (BBC Cassette)	7.78	8.95
BCASELIT	Acornsoft Ellie (BBC Cassette)	12.35	14.20
BCASEXAM	Acornsoft Examiner Cassette (SBE17) (B)	7.35	8.45
BCASFORE	Acornsoft Forecast (SBB02)	8.80	10.12
BCASFORT	Acornsoft Forth Cassette (SBL01)	12.45	14.32
BCASFREE	Acornsoft Free Fall (SBG28)	7.35	8.45
BCASFPRE	Acornsoft French (Linkword) (SBX13)	11.05	12.71
BCASGERM	Acornsoft German (Linkword) (SBX16)	11.05	12.71
BCASGRAD	Acornsoft Graphics on the BBC	8.50	9.78
BCASGRAP	Acornsoft Graphs & Charts (SBX02)	7.35	8.45
BCASHOOK	Acornsoft/ICL Hooked on Numbers (SBX08) (B)	7.35	8.45
BCASHOPP	Acornsoft Hopper (SBG23)	7.35	8.45
BCASITAL	Acornsoft Italian (Linkword) (SBX14)	11.05	12.71
BCASJARS	Acornsoft Jars (SBE15)	8.83	10.15
BCASJIBD	Acornsoft JCB Digger (SBG09)	7.35	8.45
BCASJING	Acornsoft Kingdom of Hamill (SBG25)	7.35	8.45
BCASLISD	Acornsoft Lisp Demonstration Progs (SBL09)	7.35	8.45
BCASLISP	Acornsoft Lisp Cassette (SBL02)	12.45	14.32
BCASMAGI	Acornsoft Magic Garden (B) (SBX04)	7.35	8.45
BCASMEMB	Acornsoft/ICL Membership Manager (SBX06)	7.35	8.45
BCASMETE	Acornsoft Meteors (SBG13)	7.35	8.45
BCASMETM	Acornsoft Meteor Mission (SBG29) (B Cas)	7.78	8.95
BCASMICR	Acornsoft Microtext (SBL04)	36.85	42.38
BCASMISSB	Acornsoft Missile Base (SBG18)	7.35	8.45
BCASMISS	Acornsoft Missing Signs (SBE09)	8.83	10.15
BCASMONS	Acornsoft Monsters (SBG03)	7.35	8.45
BCASNUMB	Acornsoft Number Balance (SBE08)	8.83	10.15
BCASONET	Acornsoft/ICL One to Nine (SBX07)	7.35	8.45
BCASPEEK	Acornsoft Peeko-Computer Pack (SBE02)	7.35	8.45
BCASPICT	Acornsoft Personal Money Management (SBB05)	8.80	10.12
BCASPHIL	Acornsoft Philosophers Quest (SBG01)	7.35	8.45
BCASPICT	Acornsoft Picture Maker (SBX03)	7.35	8.45
BCASPLAN	Acornsoft Planetoid (Defender) (SBG15)	7.35	8.45
BCASROCK	Acornsoft Rocket Raid (SBG05)	7.35	8.45

Ref	BBC Cassette Software	Exc VAT	Inc VAT
BCASSENT	Acornsoft Sentence Sequencing (SBE07)	8.83	10.15
BCASINNV	Acornsoft Super Invaders (SBG18)	7.35	8.45
BCASSLIO	Acornsoft Sliding block puzzles (SBG12)	7.35	8.45
BCASSNAP	Acornsoft Snapper (SBG04)	7.35	8.45
BCASSNOO	Acornsoft Snooker (SBC21)	7.35	8.45
BCASSPAN	Acornsoft Spanish (Linkword) (SBX15)	11.05	12.71
BCASSPAS	Acornsoft S Pascal (SBL08)	12.45	14.32
BCASSPHI	Acornsoft Sphinx Adventure (SBG07)	7.35	8.45
BCASSSTAR	Acornsoft Starship Command (SBC22)	7.35	8.45
BCASTETR	Acornsoft Tetrapod (SBG32) (BBC Cassette)	7.78	8.95
BCASTREE	Acornsoft Tree of Knowledge (SBE04)	7.35	8.45
BCASTURT	Acornsoft Turtle Graphics (SBL07)	12.45	14.32
BCASVIEW	Acornsoft View Printer Driver (SBB04) (B)	7.35	8.45
BCASVOLC	Acornsoft Volcano (SBG33) (BBC Cassette)	7.78	8.95
BCASWORH	Acornsoft Word Hunt (SBE05)	8.83	10.15
BCASWORS	Acornsoft Word Sequencing (SBE06)	8.83	10.15
BCBEAVM	BES Animal Vegetable Mineral (XBE03)	6.63	7.62
BCBEHAPL	BES Happy Letters (XBE07)	6.63	7.62
BCBEHAPN	BES Happy Numbers (XBE04)	6.63	7.62
BCBEMAPR	BES Map Rally (XBE08)	6.63	7.62
BCBETIMI	BES Timeman One (XBE05)	6.63	7.62
BCBETIM2	BES Timeman Two (SBE06)	6.63	7.62
BCBEWORH	BES Wordhang (XBE02)	6.63	7.62
BCBEWORW	BES World-Wise (XBE01)	6.63	7.62
BCBSBOWV	BBCsoft Beyond Basic Cassette (B)	8.50	9.76
BCBSBANY	BBCsoft Canyon (B)	7.40	8.51
BCBSDRAW	BBCsoft Drawing	7.40	8.51
BCBSDRWH	BBCsoft Dr Who: The First Adventure (B)	7.40	8.51
BCBSSEARL	BBCsoft Early Learning	7.40	8.51
BCBSGAMS	BBCsoft Games of Strategy	7.40	8.51
BCBSHOMF	BBCsoft Home France	7.40	8.51
BCBSHAKM	Making the most of your Micro (Inc book)	9.57	11.01
BCBSMOTO	BBCsoft Motorists' Log	7.40	8.51
BCBSPAIN	BBCsoft Painting	7.40	8.51
BCBSPRO1	BBCsoft Programs Vol 1	7.40	8.51
BCBSPRO2	BBCsoft Programs Vol 2	7.40	8.51
BCBSRECO	BBCsoft Record Keeper (B)	10.20	11.73
BCBSSTAX	BBCsoft Taxcalc (B)	8.16	9.38
BCBSTOOL	BBCsoft Tool Box (B)	15.52	17.85
BCBSVUTY	BBCsoft VU Type (Typing Tutor) (B)	11.90	13.68
BCBSWHIT	BBCsoft White Knight Mark Eleven (B)	8.50	9.78
BCBUTWIN	Bug-Byte Twin Kingdom Valley	7.02	8.07
BCCCANDR	Computer Concepts Android Attack	6.61	7.60
BCCCASTE	Computer Concepts Asteroid Bell	6.67	7.65
BCCCCHES	Computer Concepts Chess	6.61	7.60
BCCCLOGO	Computer Concepts Logo II	8.50	9.78
BCCCSNAK	Computer Concepts Snake	5.87	6.75
BCCCSPAC	Computer Concepts Spacehawks	5.87	6.75
BCCCSWAR	Computer Concepts Swamp	6.61	7.60
BCDS747	Doctor Soli 747	5.87	6.75
BCGEBEEB	Gemini Beebcalc (Spreadsheet)	14.75	16.96
BCGEBEEP	Gemini Beebplot (Graph Plot)	14.75	16.96
BCGECATE	Gemini Caterpillar	7.35	8.45
BCGGFAIR	Griffin & George Fairshare	7.35	8.45
BCGGGETS	Griffin & George Getset	7.35	8.45
BCGGNUMB	Griffin & George NumberFun	7.35	8.45
BCGGTABL	Griffin & George Tablesums	7.35	8.45
BCGGWORG	Griffin & George Wordgames	7.35	8.45
BCGGWORS	Griffin & George Wordspell	7.35	8.45
BCGHTALP	Good Houseke's Mr T's Alphabet	9.57	11.01
BCGHTMEA	Good Houseke's Mr T's Measuring Games	9.57	11.01
BCGHTMON	Good Houseke's Mr T's Money Box	9.57	11.01
BCGHTNUM	Good Houseke's Mr T's Number Games	9.57	11.01
BCGHTNUM	Good Houseke's Mr T's Shape Game	9.57	11.01
BCGHTTEL	Good Houseke's Mr T Tells the Time	9.57	11.01
BCHGADBV	Honeyfold Advanced Basic course	12.10	12.71
BCHOBECA	Honeyfold Beginners Assembly Language	12.10	12.71
BCHOBEGB	Honeyfold Beginners Basic course	12.10	12.71
BCIBCRIM	Ivan Berg Crime & Detection Quiz (XBX02)	9.35	10.75
BCIBOATI	Ivan Berg Dating Game (XBX08)	9.35	10.75
BCIBHIST	Ivan Berg History Quiz (XBX04)	9.35	10.75
BCIBIDO	Ivan Berg '... I O' (XBX07)	9.35	10.75
BCIBMUSJ	Ivan Berg Music Quiz (XBX03)	9.35	10.75
BCIBROYA	Ivan Berg Royalty Quiz (XBX06)	9.35	10.75
BCIBSCIE	Ivan Berg Science Fiction Quiz (XBX05)	9.35	10.75
BCIBTHER	Ivan Berg Theatre Quiz (XBX01)	9.35	10.75
BCILHYPE	IJK Hyperdrive for BBC (13)	4.80	5.52
BCIJINVA	IJK Invaders for BBC (9)	5.54	6.37
BCIJSTRA	IJK Stralobomber for BBC (14)	5.54	6.37
BCIJSUPE	IJK Super Hangman for BBC (16)	3.32	3.82
BCIJOYST	Joystick Utility program for BBC	5.06	5.82
BCKAGALA	Kansas Galactic Firebird	7.01	8.06
BCKOFREA	Kosmos Software French Mistress A	7.35	8.45
BCKOFREB	Kosmos Software French Mistress B	7.35	8.45
BCKOGERA	Kosmos Software German Master A	7.35	8.45
BCKOGERB	Kosmos Software German Master B	7.35	8.45
BCKOSPAA	Kosmos Software Spanish Tutor A	7.35	8.45
BCKOSPAB	Kosmos Software Spanish Tutor B	7.35	8.45
BCL9COL0	Level 9 Colossal Adventure (B)	7.32	8.42
BCL9DUNG	Level 9 Dungeons (B)	7.32	8.42
BCL9LORO	Level 9 Lords of Time (B)	7.32	8.42
BCL9SNOW	Level 9 Snowball (B)	7.32	8.42
BCMHOBBO	Melbourne House Hobbit	11.95	12.71
BCMSQUIC	Mirrorsoft Quick Thinking (B)	5.13	5.90
BCOCMRWV	Ocean Mr. Wimpy	5.10	5.87
BCPAFORT	Pace Software Fortress	6.61	7.60

Ref	BBC Cassette Software	Exc VAT	Inc VAT
BCPPADVE	Program Power Adventure (B)	5.87	6.75
BCPPALID	Program Power Alien Destroyers (Invader)	5.91	6.80
BCPPALIE	Program Power Alien Swirl	5.13	5.90
BCPPASTE	Program Power Asteroid Storm (B)	5.87	6.75
BCPPASTR	Program Power Astro Navigator	4.21	4.84
BCPPBAND	Program Power Bandits at 3 o'clock	5.14	5.91
BCPPBARR	Program Power Barrage for BBC	5.13	5.90
BCPPBEEB	Program Power Beeb-Tale (B)	4.40	5.06
BCPPBUMB	Program Power Bumble Bee (B)	5.87	6.75
BCPPCAVA	Program Power Caveman Adventure	5.06	5.82
BCPPCHEM	Program Power Chemistry	5.13	5.90
BCPPCHES	Program Power Chess	5.87	6.75
BCPPCOSM	Program Power Cosmic Combat (B)	5.14	5.91
BCPPCOWB	Program Power Cowboy Shoot-Out	5.06	5.82
BCPPCROA	Program Power Croaker	5.87	6.75
BCPPCYBE	Program Power Cybertron Mission (B)	5.87	6.75
BCPPDANG	Program Power Danger! UXB	5.87	6.75
BCPPDEMO	Program Power Demon Decorator (Painter)	5.06	5.82
BCPPDISC	Program Power BBC Discassembler	5.06	5.82
BCPPDUINE	Program Power Dune Rider (BBC Cassette)	6.22	7.15
BCPPELDO	Program Power Eldorado Gold (Adventure)	5.08	5.82
BCPPESCA	Program Power Escape from Moonbase Alpha	5.87	6.75
BCPPFFAC	Program Power Felix In the Factory	5.87	6.75
BCPPFFRU	Program Power Felix & the Fruit Monsters	5.87	6.75
BCPPGHOU	Program Power Ghouls	5.87	6.75
BCPPHELL	Program Power Hell Driver (B)	5.37	6.15
BCPPINTE	Program Power Intergalactic Trader (B)	6.61	7.60
BCPPJETP	Program Power Jet Power Jack	5.87	6.75
BCPPKILL	Program Power Killer Gorilla	5.87	6.75
BCPPLABC	Program Power Labyrinths of la Cashe	5.87	6.75
BCPPPLAS	Program Power Laser Command	5.87	6.75
BCPPMART	Program Power Martian Attack (B)	5.87	6.75
BCPPMINE	Program Power Mine (B)	5.87	6.75
BCPPMOON	Program Power Moon Reader	5.87	6.75
BCPPNEME	Program Power Nemesis (B)	5.87	6.75
BCPPPHYS	Program Power Physics	5.06	5.82
BCPPPROK	Program Power Poker Dice (B)	4.40	5.06
BCPPPDSI	Program Power Position (B)	5.14	5.91
BCPPPREV2	Program Power Revers (32K)	4.21	4.84
BCPPPROUL	Program Power Roulette for BBC	4.21	4.84
BCPPPSEEK	Program Power Seek	5.06	5.82
BCPPSPAC	Program Power Space Jailer (B)	5.14	5.91
BCPPSTOC	Program Power Stock Car (B)	6.58	7.54
BCPPSWOO	Program Power Swoop	5.87	6.75
BCPPTIMT	Program Power Timetrek (Star Trek Plus)	5.87	6.75
BCPPWALL	Program Power Wall (B)	4.40	5.06
BCPPWHERE	Program Power Where (B)	5.14	5.91
BCPPWORLD	Program Power World Geography (B)	5.14	5.91
BCPPZARM	Program Power Zarm (B)	5.87	6.75
BCPSALON	Psion Saloon Sally	4.39	5.05
BCOSBEEB	QuickSiva Beeb Art (B)	11.05	12.71
BCOSMUSI	QuickSiva Music Processor (B)	11.05	12.71
BCRHGALA	RH Software Galactic Wreopul (RHS001C)	6.61	7.60
BCRHSKIS	RH Software Ski Slalom (RHS002C)	6.61	7.60
BCSHGBLT	Simon W Hessel GB Ltd	5.13	5.90
BCSHINNE	Simon W Hessel Intertance	4.39	5.05
BCSHTRAV	Simon W Hessel Travel Game	4.29	5.05
BCSIOBBO	Software Invasion 3D Bomb Alley	5.87	6.75
BCSIATTA	Software Invasion Attack on Alphacentaur	5.87	6.75
BCSIEAGL	Software Invasion Eagles Wing (B)	5.87	6.75
BCSINGULS	Software Invasion Gungsmoke	5.87	6.75
BCSISPOO	Software Invasion Spooks & Spiders (B)	5.87	6.75
BCSIVORT	Software Invasion Vortex	5.87	6.75
BCSMOSDI	Simonsol I Disassembler	5.87	6.75
BCSS2002	Superior Software 2002	5.87	6.75
BCSSALI0	Superior Software Alien Dropoul	5.87	6.75
BCSSBATT	Superior Software Battle Tank	5.87	6.75
BCSSCENT	Superior Software Centipede	5.87	6.75
BCSSCOLO	Superior Software Colditz Adventure	5.53	6.36
BCSSCRAZ	Superior Software Crazy Painter	5.87	6.75
BCSSFAIR	Superior Software Fairground	5.87	6.75
BCSSFROG	Superior Software Frogger	5.87	6.75
BCSSFRUI	Superior Software Fruit Machine	5.87	6.75
BCSSGALA	Superior Software Galaxians	5.87	6.75
BCSSHUNC	Superior Software Hunchback	5.87	6.75
BCSSINVA	Superior Software Invaders	5.87	6.75
BCSSOVER	Superior Software Overdrive	5.87	6.75
BCSSPONT	Superior Software Pontoon	5.13	5.90
BCSSOBER	Superior Software Oberl	5.87	6.75
BCSSROAD	Superior Software Road Runner	5.87	6.75
BCSSSPAF	Superior Software Space Fighter	5.87	6.75
BCSSLUNW	Suits Software Junior Wordspits	7.35	8.45
BCSUJUST	Suits		



# Electronequip

(Authorised BBC Micro Dealer, and Econet Service Centre)

**\* SPECIAL OFFERS**  
Mail order only

**\* EPSON**

**RX-80FT** £225.25 + VAT

**FX-80** £320.88 + VAT

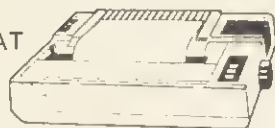

Printer price includes cable for BBC and screen dump rom is available for £11.50

**\*KAGA/TAXAN KP810** £242.58 + VAT

**VOLTMACE JOYSTICKS**

**\* 10% off list prices**



Discounted price

JSVOLT 14 Voltmace Delta 14B Joysticks ..... 13.46  
 JSVOLTAD Voltmace 14B/1 Adaptor Box ..... 13.36  
 JSVOLT3B Voltmace Delta 3B Twin Joysticks ..... 18.09

**SIDeways**

**SIDeways FITTED**



"SIDeways" rom board for BBC Micro.  
NO SOLDERING REQUIRED £36.00 + VAT

**NORDMENDE**

**14" TV/Monitor**  
£202.35 + VAT

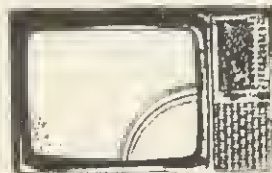

**5 FREE ACORNSOFT GAMES**  
**WITH EVERY BBC SOLD**  
(while stocks last)



Electronequip is an authorised Acorn service centre and has been an Acorn dealer since the introduction of the Atom. Our demonstration facilities include 20 station Econet and Torchnet systems.

Ref.	BBC Micros	Ex VAT	Inc VAT
ANB01	BBC Model B Micro Computer	348.26	399.00
ANB02	BBC Model B with Econet Interface	389.14	446.00
ANB03	BBC Model B with Disc Interface	409.14	469.00
ANB04	BBC Model B with Disc & Econet Interface	450.01	516.00
ANC01	6502 Second Processor	174.35	199.00
ANC04	Z80 Second Processor	348.26	399.00
ACBBITST	Acorn Bit Stick (ANF04)	327.39	376.50
ACBTELET	Teletext Receiver (ANE01)	195.65	225.00

**NOW REDUCED TO £89 (incl VAT)**

**3" Micro Disc £89.00**

**Disc Interface & Drive**  
£181.30 (inc VAT)



**Micro Disc Drive for the BBC Micro**

The Micro disc drive offers a method of low cost quick access to programs. The drive is essentially a small version of a 5 1/4" disc drive and offers similar features to the larger drive. The data is stored on a 3" disc, this is enclosed in a protective hard plastic cassette which features a write protect switch. The micro drive requires the standard Acorn disc interface, but a new disc filing system rom. Acorn DFS may be exchanged for the micro DFS for £2.30. The new micro disc filing system can read and write to Acorn DFS discs. Thus if a 5 1/2 inch and a micro floppy were connected on the same cable files could be transferred between them.  
**Capacity:** 80.64 K bytes. **Transfer Rate:** 125k bit/s.

Prices subject to variation without prior notification  
 Prices for monitors and printers include BBC cable  
**TRADE ENQUIRIES WELCOME**  
 Access & Barclaycard Accepted  
 Large Stocks - 24 Hour Despatch  
 Carriage 46p  
 No Soldering Required £36.00 + VAT

SHOP/TECHNICAL: 59 WEST STREET  
 FAREHAM, HANTS. (0329) 230671  
 (0553) 3782

**Electronequip**

36-38 West Street, Fareham, Hants (0329) 230670



# microFAST LATEST BARGAIN PRICES

## colour MONITORS

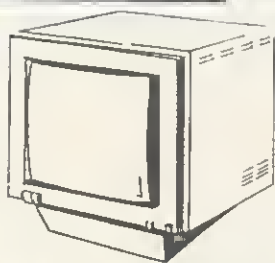

Microvitec 1451 **£239.13**  
+ VAT = £275

	ex VAT	inc VAT
Amstrad CTM640	£146.97	£169
Microvitec 1431	£169.58	£195
1431 (RGB/PAL/AU010)	£195.66	£225
KAGA Vision EX	£186.97	£215
JVC 1302-1 (OL/BBC)	£169.58	£195
Microvitec 1451/OL	£221.75	£255
Microvitec 1451	£239.14	£275
1451 (RGB/PAL/AU010)	£295.66	£340
KAGA Vision II	£234.79	£270
JVC 1302-2 (OL/BBC)	£220.00	£253
Microvitec 1441	£433.92	£499
KAGA Vision III	£321.75	£370

## DISK DRIVES

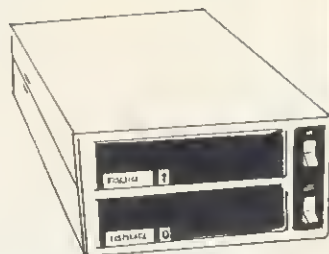

100K 40T **£86.09**  
+ VAT = £99\*

Single	ex VAT	inc VAT
100K ALPS 40T	£86.10	£99*
100K Chinon 40T	£126.10	£145
200K Sanyo 3" 40T	£160.88	£185
400K Mitsubishi 40/80T	£173.00	£199
400K Cumana 80T	£186.97	£215

Double	ex VAT	inc VAT
800K Cumana 80T	£364.36	£419
800K Mitsubishi 40/80	£381.75	£439
800K Cumana 40/80T	£433.92	£499

## mono MONITORS

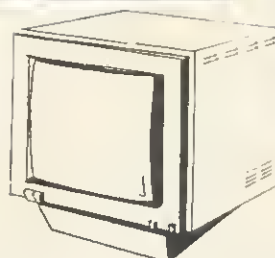

ISL 18 **£53.91**  
+ VAT = £62

	ex VAT	inc VAT
Amstrad GT64	£60.00	£69
Sanyo OM2112 (15 MHz)	£65.23	£75
Sanyo OM8112CX	£86.10	£99
ISL 18 (18 MHz)	£53.92	£62
ISL 20 (Swivel 80 col)	£63.49	£73
Teco with Zoom	£91.31	£105

## DOT MATRIX

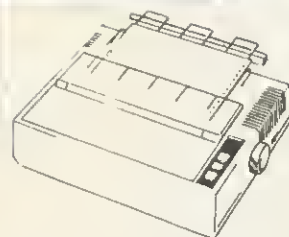

Epson RX80 F/T **£221.73**  
+ VAT = £255

	ex VAT	inc VAT
Star Delta 10 with special portable I/F 8K buffer)	£317.40	£355
KOC FT-5001	£203.49	£234
Epson RX80	£190.44	£219
Epson RX80 F/T	£221.75	£255
Fpson FX80	£329.58	£379
Epson FX100 (132 col)	£511.31	£588
Mannesman MT80	£195.66	£225

## PROCESSORS



BBC Model B **£320.87**  
+ VAT = £369\*

	ex VAT	inc VAT
BBC 'B' + s/ware	£320.87	£369*
BBC 'B' with OFS	£399.14	£459
Acom Z80 Ext. Processor	£260.00	£299
Torch Unicorn Package		P.O.A.
Amstrad CPC464	£139.14	£160
6v power + UHF	£24.36	£28
ISL 8083 (IBM Comp)	£1173.92	£1350
OFC 11/23 + 40 MB	£6086.97	£7000
OEC 11/73 + 170 MB	£10434.79	£12000
LVL 00/00S	£103.49	£119

Phone for quotation on  
*bespoke Accounting  
Software Invoicing/  
Ledgers/Payroll*

## VARIOUS

	ex VAT	inc VAT
Torch Ext. Processor + Software	£260.01	£299
Torch Ext. Processor + twin drives	£651.31	£749
Computer Concepts ROMS from	£27.84	£32
Acorn Business Software	£20.88	£24
Acorn Data recorder	£27.84	£32
Computer Work Station	£49.58	£57
Holds Micro*, Monitor, Printer with Storage Space	£14.79	£17
Desk Stacking Unit	£20.00	£23

(Lockable version available)

## DAISYWHEEL

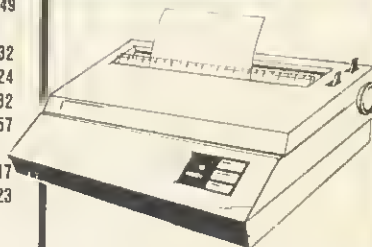

Juki 6100 **£326.08**  
+ VAT = £375

	ex VAT	inc VAT
JUKI 6100	£326.08	£375
Daisy Step 2000 Plus	£216.53	£249
JUKI Sheet Feeder	£207.84	£239
JUKI Tractor Feed	£94.79	£109
Serial Interface Conversions		
8143—Epson	£26.10	£30
8148—Epson (2k buffer XON/XOFF protocol)	£56.53	£65
JUKI	£47.84	£55
Plus cables from	£10.44	£12

★ SPECIAL OFFER WHILE STOCKS LAST

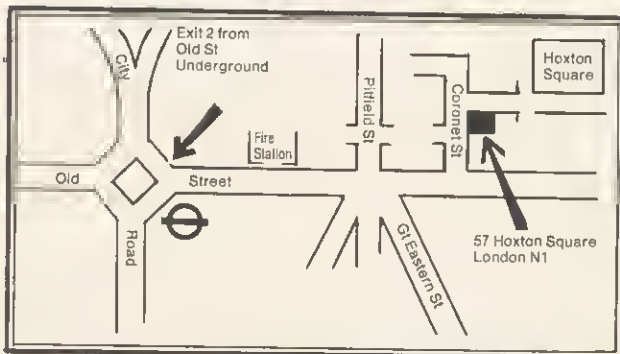

## BOLD PRICES INCLUDE VAT

Prices shown are for cash & carry sales and are correct at  
time of going to press in September

Export price list available

Mail order and credit cards accepted

OPEN 9-6 Monday to Saturday

57 Hoxton Square, London N1

Tel: 01-729 1778

## BUSINESS SYSTEMS

A.C.T. Apricot  
Processors and  
Business Systems  
assembled to your  
specification. Price  
dependent on  
equipment supplied.  
Call us to discuss your  
requirement.

# microFAST

## THE EXPERTS

## MODEMS

Selection of Acoustic Couplers and  
Mini Modems in stock.

	ex VAT	inc VAT
Minor Miracle WS2000	£126.10	£145



# TAKE TWO TABLETS

Malcolm Banthorpe draws practical conclusions in this comparative review of two inexpensive digitisers

**Robot Plotter** by Robot Computer Developments, National Industrial Estate, Bontott Avenue, Hult HU5 4HF, tel: (0482) 448562, £59.50 inc VAT.

**Tarren Digigraph Mk II** by Tarren Products, Factory D1, Treforest Industrial Estate, Pontypridd, Mid Glam., CF37 5UR, tel: (0443 85) 3723/4, £86 plus VAT with cassette software, £91 plus VAT with disc software.

LIKE most of the digitisers currently available for the BBC micro, the two graphics tablets reviewed here work on the pantograph arm system. This system provides a cheaper alternative to the one used on the Grafpad type of tablet, where the position of the drawing stylus is detected by electromagnetic coupling between it and a grid of fine wires embedded in the tablet. While the accuracy of these pantograph devices is generally slightly lower and their physical construction makes them difficult to use for freehand drawing, they can be used quite efficiently to trace existing artwork for transfer to the screen.

Two potentiometers connected to the analogue input port supply all the information required to allow the position of the pointer at the free end of the jointed arm to be calculated by suitable software. As mentioned in my review of the Grafpad (May issue), one of the design problems to be overcome in making one of these digitisers is that the overall structure should be rigid enough to prevent errors due to flexing or backlash while still allowing the joints to rotate freely, so that diagrams and sketches can be easily traced. The standard of construction on both the Robot Plotter and Tarren Digigraph Mk II tablets was high and met the above requirements well.

Given that the hardware performs as

it should, the usefulness of a graphics tablet is heavily dependent on the software used with it. The restricted memory available on the BBC micro when modes 0, 1 and 2 are used means that software designers cannot generally include all the features that they would like and must therefore decide which are going to be most useful and use their skill to include as many as

moment, then, they must be capable of running on unexpanded, cassette-based machines.

This review will therefore concentrate on the software aspect of the digitisers since this will probably be the deciding factor in whether they meet your requirements.

The Robot Plotter (figure 1) employs a transparent smoked perspex base board through which artwork can be traced. The software is supplied on cassette but includes a routine to facilitate its transfer to disc. The memory constraints of the micro mean that only graphics modes 4 and 5 can generally be used with a disc filing system. Another routine is included to move the program down to PAGE = &E00 once loaded from disc, so that modes 0, 1 and 2 can be used, but it will then not be possible to save or load pictures from disc.

Once the main program has been loaded, prompts are displayed to calibrate the tablet by moving the pointer to the upper right and lower left corners of the grid and pressing return. The program then asks if extended mode is required. The main part of the program can operate either in a simple mode, allowing the more commonly used drawing commands to be accessed rapidly, generally with a single keystroke, or in extended mode where additional features are available and a single keystroke often presents several options.

Commands available in the simple mode include line, rectangle and circle drawing and 'follow', which allows irregular shapes such as maps to be traced. In each case the line or circle or rectangle is continually redrawn according to the pointer position until accepted by pressing the space bar. This feature is of considerable assistance in getting the pointer cor-

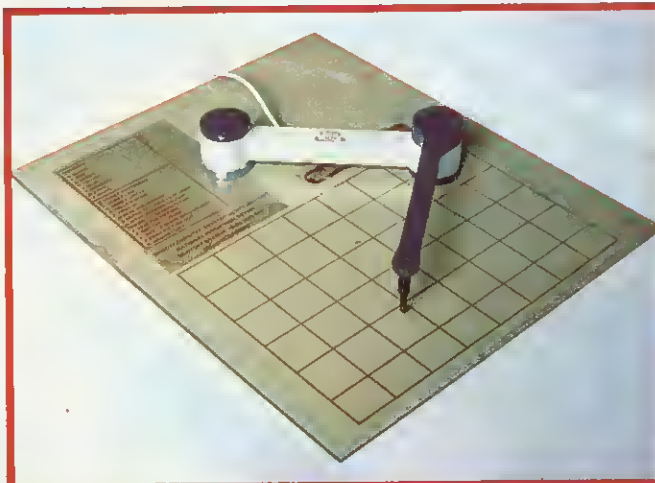

Figure 1. The Robot Plotter



Figure 2. The Tarren Digigraph Mk II

possible, at the same time keeping the program friendly. The use of disc overlays or a second processor opens the door to greater freedom in graphics software design but commercial programs generally need to be usable by as many customers as possible. For the

# Clearing Business Hurdles

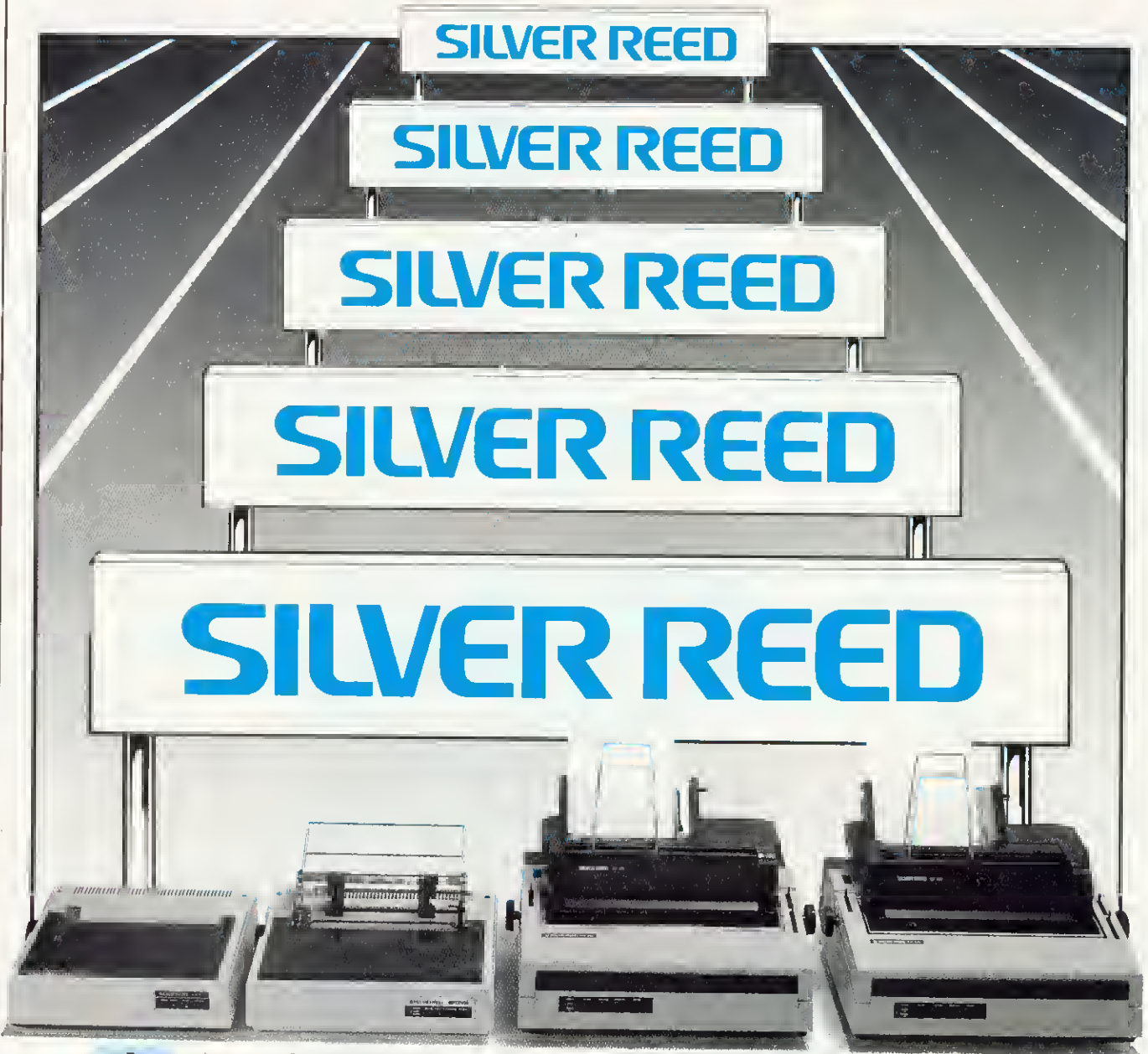

**I**n the sprint for business efficiency no doubt you're finding plenty of obstacles, backlogs of paperwork, communications problems and the like.

In such circumstances it's well worth evaluating SILVER-REED'S range of bi-directional daisywheel printers. They'll deal with mailings, lists, labels, reports and generally enhance your office capability, with a clear, letter quality presentation that protects your company image.

They clear the technology hurdle – they're developed with SILVER-REED'S renowned R & D expertise. They clear the presentation hurdle – using the same unmistakable clear, letter quality print as on SILVER-REED'S EX55 electronic typewriter, the "Silver Fox". They clear the efficiency hurdle – as part of a complete system for

word processing applications, all are centronics or RS232C compatible.

Take some positive steps towards clearing your business hurdles – ask for more details of SILVER-REED'S range of computer peripherals. Contact your local dealer or clip this coupon.

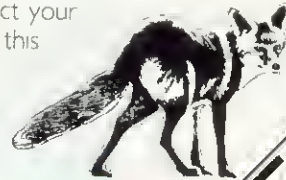

## SILVER REED

**SILVER-REED (U.K.) LTD.**

SILVER SEIKO HOUSE, 19 23 EXCHANGE ROAD  
WATFORD, HERTFORDSHIRE WD1 7EB  
TEL. WATFORD (0923) 45976 & 35616  
TELEX 923029 (SILVER G)  
FACSIMILE (0923) 27693

Please send me details  
Company Name  
Company Address  
Name  
Position

EXP 400  
EXP 500  
EXP 550  
EXP 770  
Post Code

Free  
**FREEPOST**  
No Stamp  
required  
AU/11/84



rectly positioned. There is provision for entering text, which can be 'dragged' around the screen by the cursor and therefore positioned quite precisely. Enclosed shapes can be filled with a colour and at any point the drawing colour can be selected from any of those available to the graphics mode in use. The physical colour displayed by each logical colour can also be redefined.

Extended mode offers in addition the choice of dotted or solid lines and when 'fine' is selected there is a choice of horizontal and vertical - useful in constructing diagrams - as well as sloping lines. 'Multicolour fill' gives the user the chance to define a 'super pixel' of four normal pixels, which greatly extends the number of colours or textures available for filling enclosed shapes.

One of the most useful features of this software is the way that each drawing instruction is memorised as it is executed, in both simple and extended modes. Thus all or part of a drawing can be repeated in a different screen position. A drawing can also be 'edited' by stepping through the memorised list of drawing instructions and either accepting or deleting each item. Pictures are stored on tape or disc as a series of drawing instructions rather than as a dump of screen memory and can therefore still be edited after storing and recall. Time taken to save or load a screen from tape is therefore reduced.

The instruction booklet lists two procedures that may be appended to the main program to allow screen dumps to either Seikosha or Epson printers.

The Tarren Digigraph Mk II (figure 2) has a wooden baseboard surfaced with white plastic laminate. Software can be supplied on either tape or disc, both allowing all graphics modes to be used.

The plotter is calibrated by positioning the pointer at each of three reference marks on the baseboard and pressing return. The height of the pointer is adjustable so that various thicknesses of paperwork, placed on the baseboard for tracing, can be

accommodated.

The software supplied has a wide range of drawing options that allow the creation of almost any type of diagram to be tackled. The number of functions is too long to list in detail. Apart from the usual line/circle/rectangle/fill etc

separate windows can be defined on the tablet and on the screen so that movement of the pointer within the tablet window will correspond to movement of the cursor within the screen window. In this way it is possible to scale up or scale down the movement of the pointer.

● One of the options for line drawing allows the length and angle of a line to be entered from the keyboard (not unlike turtle graphics), having established its starting point either with the pointer or as the end position of the previous drawing operation. This feature makes it very easy to create isometric drawings.

When the infill command is used to fill an enclosed area with solid colour, the number of screen pixels filled is shown in the prompt area at the lower edge of the screen.

As so many drawing options are available practice will be required before the user can get the most out of the software. To this end a series of worksheets and a booklet of exercises has been included. The worksheets contain shapes to be copied using various drawing techniques, and the booklet takes you step by step through the operations required. It's not essential to work through them all before producing your own drawings, but they provide a useful introduction to the use of the graphics tablet.

## Conclusions

Both tablets are well constructed and the hardware performs well. Both, too, show evidence that a lot of thought has gone into their software.

The Robot Plotter, with its smaller range of functions, is probably easier and quicker to use for general-purpose drawing and tracing. The inclusion of simple and extended modes means almost anybody can produce

pleasing screen drawings with minimum practice. Although the range of functions is limited, most things may be drawn without fuss. The only feature I felt lacking was that of arc and ellipse drawing.

By restricting the drawing functions to those most commonly used, enough



Figure 3. Mode 1 picture created on the Robot Plotter, making use of the repeat and multicolour pixel facilities

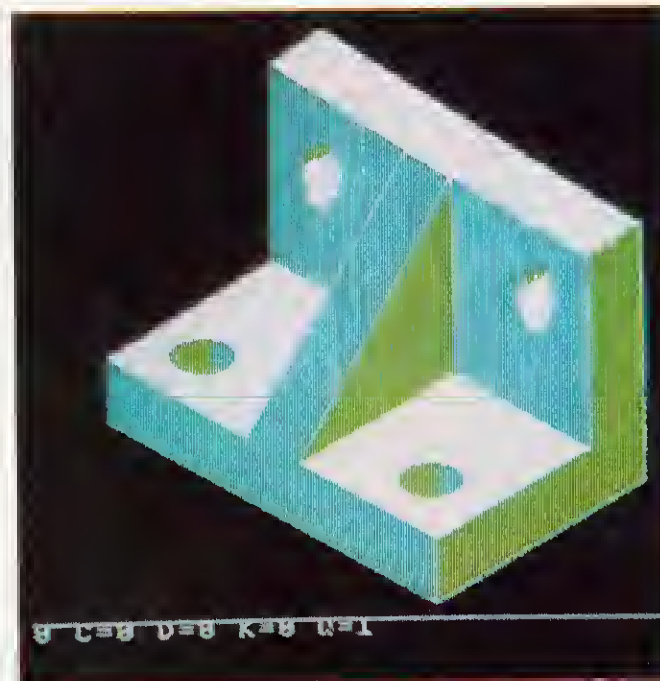

Figure 4. Mode 1 picture created on the Tarren Digigraph Mk II

commands, options worthy of note are:

- Drawing filled and outlined arcs and ellipses.
- Any rectangular block of the screen can be copied, pixel by pixel, to any other part of the screen.
- To assist with drawing fine detail,



M I C R O P O W E R M I C R O P O W E R M

ANOTHER CHALLENGE FROM BRITAIN'S LEADING SOFTWARE HOUSE

# FELIX

Meets  
The

# EVIL WEEVILS



Clamber up the pipes, dodging the coscoding ball bearings to despatch the Weevils and Superweevils using your sproy con. Features oxygen cylinders, bonus letters, belt lever and ponc button.  
**NEW PRICE! B.B.C. and Electron cossette: £6.95. B.B.C disk version: £9.95.**

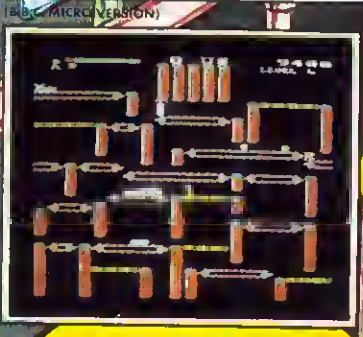

electron  
**B.B.C. MICRO**

## M I C R O P O W E R

MICRO POWER LTD.,  
NORTHWOOD HOUSE, NORTH STREET,  
LEEOS LS7 2AA TEL: (0532) 458800  
MICRO POWER SOFTWARE IS AVAILABLE FROM  
SELECTED BRANCHES OF WH SMITH, BOOTS, JOHN  
MENZIES, CO-OP, WOOLWORTHS AND ALL GOOD  
DEALERS  
AUTHORS! WE PAY 20% ROYALTIES!

"WATCH OUT  
FOR THE FANTASTIC  
NEW PACKAGING!!"

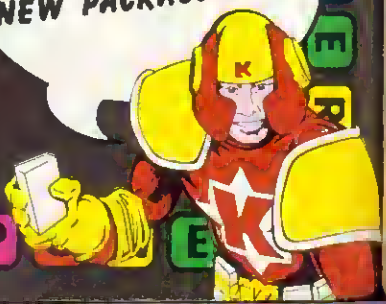

M I C R O P O W E R M I C R O P O W E R M



## THE VITAL

### CONNECTION

**Romex 13 Expansion ROM board, GCC (Cambridge) Ltd, BBC, £45.94**

MANY readers will know what a sideways ROM board is—an additional printed circuit board which connects into one of the five 'sideways' ROM sockets on the BBC and allows you to add extra ROMs or EPROMs. You might also think that that is about all there is to say, but not so.

This particular board is well made and appears to use good quality components. It also has decided advantages and disadvantages compared with other ROM boards. It will allow up to the full 16 additional ROMs—the maximum the operating system can support. It is also supplied with a comprehensive manual, mainly concerned with fitting instructions and suitable diagrams. Most ROMs you will come across will be 8k or 16k versions. However, the guide does show how to make minor modifications to the board to use 2k and 4k ROMs.

The board itself is fitted to the inside of the lid of the micro and therefore can be used in conjunction with a number of other accessories without interference, eg the Aries B20 RAM board. It also means that in this position, away from

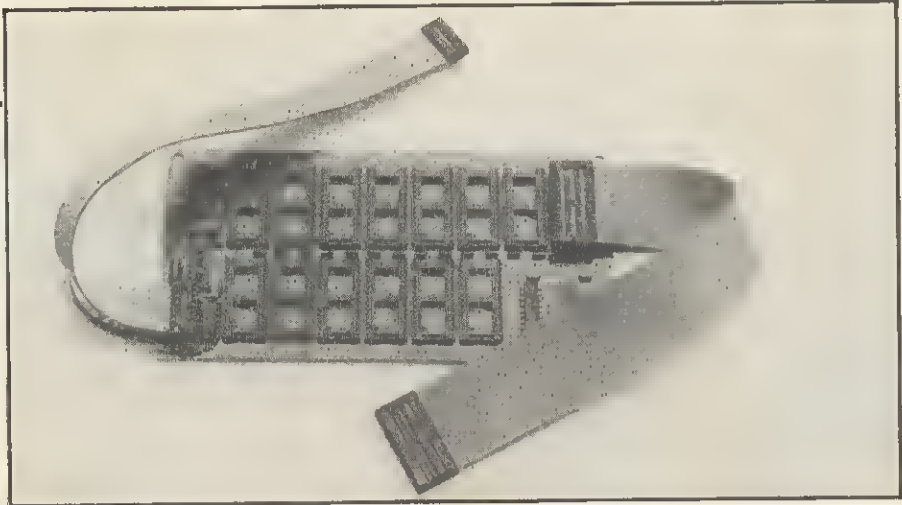

the main board, it is less likely to suffer overheating problems.

The main disadvantage will in fact only apply when fitting the board to certain BBC micros. There are three connections in all, two of which are straightforward. These involve inserting the main 28-way connection into one of the spare ROM sockets and removing an illustrated link on the micro to fit the second connection. The third connection is likely to be the main problem. It requires that you remove IC76 from the main board and insert it into the ROM board, replacing it with the 16-way cable supplied. This is easy to do as long as IC76 on your particular micro is in a socket. Unfortunately, mine is soldered directly to the board, as I believe many are nowadays. This problem is overcome by using an additional 4-way cable supplied and

soldering it directly to the legs of the chip—ugh!

This can be done but is by no means easy. There is very little room to work in and unless you are an expert with a soldering iron I don't recommend it. I'm quite used to that sort of thing but still had problems.

Having eventually succeeded in getting it all fitted I tested the board with about 10 ROMs and it worked perfectly well.

Unfortunately, my whole attitude towards the product is tainted by the IC76 difficulties. I don't like anything that requires additional soldering or the like. If your chip is in a socket then it is well worth considering this product for the advantages it does provide, especially with the Aries B20; if it is not then I would not recommend it.

Ian Rowlings

## TAKETWO TABLETS

◀ page 189

memory has been reserved to store each drawing operation. I found the facility this gives to edit drawings extremely helpful. The use of 'super-pixels' for filling means that mode 1 can be used to give reasonable line resolution while still offering about 15 fill 'colours'.

The more comprehensive software of the Tarren Digigraph Mk II is reflected in its higher price. With its extended range of functions it should be possible to produce high-quality drawings and diagrams for display on the screen, as transparencies or as printer dumps. The ability to use modes 1 or 0 while retaining full disc facilities is desirable if detailed drawings are required. Although lacking the picture-editing facility of the Robot Plotter, the ability to copy and move blocks of the screen and selectively erase parts of it allows corrections and alterations to be made.

## A MONITOR ABOUT THE HOUSE

**Philips TP200 monochrome monitor, Telefusion Communications, Unit 9, Barrs Fold Close, Wingates Industrial Park, Westhoughton, Bolton BL5 3XH, £83.80**

ANYONE using a TV as a computer display will, at some time, have thought of buying a dedicated monitor. Not only do they free the TV, they give a much improved display. Further, they overcome the problems which can be caused by TVs interfering with the computer's video signal (frequency 'beating') which tends to make the picture unstable.

The Philips TP200 is a black and white monitor with a green phosphor display on a 12in screen. It has a worst case resolution of 700 lines and a frequency response of 18MHz: in plain language this means it can more than cope with an 80-column display and the Beeb's highest resolution mode.

The monitor is nicely styled and has external controls for: on/off; brightness; contrast; vertical hold; horizontal and vertical centring (nice touch that!). Internally there are controls for horizontal hold, focus and voltage. The unit

is cased in impact resisting plastic, with a fold-out stand, and, at 8kg, is lighter than most 'portable' TVs. It uses a standard 1vpp composite video input and connection is via an RCA-type (phono) jack.

In use, it was found to be totally reliable on both the Atom and the Beeb, giving good picture resolution. There was, however, a noticeable degree of 'persistence' (the image remaining on the screen after blanking). This was confirmed by the supplied retrace times, which were 11µs for horizontal trace and 1.2ms for vertical trace. While this would not be a problem for a domestic user, it could cause fatigue for someone using the monitor continuously. That aside, the unit was a joy to use and the price makes it an attractive proposition for any home user. It comes complete with a multi-lingual instruction booklet and a circuit diagram.

Special prices are available for bulk orders and for bona fide computer clubs. I can recommend this unit as a worthwhile and value-for-money buy for domestic users.

Barry Pickles

# SYSTEM SOFTWARE

## •ROMS FOR THE BBC MICROCOMPUTER•

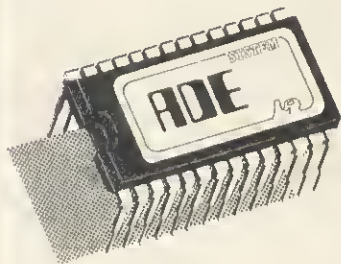

The complete program development package for assembly language programmers. ADE is the de facto industry standard for professional software writers using the BBC microcomputer. The 16k ROM contains a full 6502 MACRO assembler; a dynamic text editor; a front panel debugging monitor and disassembler. ADE comes complete with a 16D page comprehensive reference manual and a utility/macro library disc. ADE can also be used with tape based machines.

The ASSEMBLER features macros with library facilities; nestable conditional assembly; flexible listing options (with or without macro expansion); hex, decimal, binary and ASCII data formats; dummy section; full range of arithmetic and logical operators; symbol table sort and dump; file chaining and 29 powerful pseudo ops. Source and object files are kept on disc so there is no limit on program size or location.

The EDITOR is designed with the programmer in mind for writing both programs and documentation. The editor includes a very powerful command language (including macros) that enables much editing to be done on a semi-automatic basis. It features full screen editing and deferred edit modes; no limit to document size; edit with backup facilities and a versatile text formatter.

The DEBUGGER is instantly accessible for inspecting, modifying and disassembling machine code programs. Features include full 64 byte display in hex, ASCII and disassembled format; registers; stack; single step; breakpoints; memory search and much more.

Price £60 inc vat. Please specify 40 or 80T utility disc.

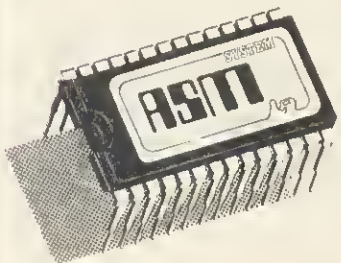

ASM provides all the superb features of the ADE macro assembler on its own ROM.

The program source file may be written using any editor (even Wordwise or View). Complete with reference manual and utility/macro library disc. Use the assembler that professional software writers use.

Price £35 inc vat. Please specify 40 or 80T utility disc.

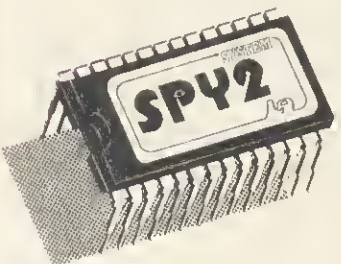

SPY2 is a front panel debugging monitor, disassembler and disc utility ROM. SPY2 is instantly accessible to the programmer for inspecting, modifying, debugging and disassembling machine code programs. SPY2 also features a relocater and program trace facilities. SPY2 will access any ROM either in the sideways ROM sockets or on an extension board. ROM memory may be displayed, single-stepped through or disassembled.

SPY2 includes a set of powerful disc recovery commands for interrogating, editing and retrieving data stored on a floppy disc. SPY2 also includes a disc formatter as well as a non-destructive single track reformatter.

In all SPY2 has a comprehensive set of 23 utility commands. These are supported by an excellent Reference Manual.

The SPY2 front panel encompasses all the superb, easy-to-use facilities of the renowned SPY debugging monitor PLUS additional commands for toggling and finding breakpoints; relocating machine code programs; single stepping through subroutines in one go and facilities for accessing the front panel from programs in RAM or ROM with breakpoints, OSBYTE or CTR-F.

SPY2 features a versatile disassembler with hex dump, full and intelligent disassembly. This identifies data areas in the program; these being displayed as a hex/ASCII dump. Operating system calls are labelled creating very readable code. The powerful trace facilities enable program instructions and register contents to be traced to printer whilst the program is running. Indispensable for graphics programs as they can be stepped through whilst observing the effects on the screen.

SPY2 features a disc sector editor displaying the contents of a whole sector; disc search facilities for finding byte patterns or strings and free disc space. Files may be recovered by creating a directory entry with all the data concerning the deleted file. Directory entries can be easily amended using the \*AMEND command. The \*FORMAT command formats discs with any number of tracks. A verify command checks discs. The \*REFORMAT command is extremely useful for recovering information from a bad track, reformatting it and restoring the data. Commands are included for loading files at &#1900 and automatically downloading (and running) them.

The most comprehensive of all debugging/disc utility ROMs.

Price £30 inc vat.

NOW order by phone.



(0742) 682321

# SYSTEM

Dept. A 12 Collegiate Crescent, Sheffield S10 2BA





## THREE LANGUAGE LEARNING PROGRAMS

## TAKE A RAP ON THE KNUCKLE

'Vocab - Five Language Learning Aid for the BBC Micro', Beebugsoft, PO Box 50, St Albans, Herts, £10

'French Tutor', BBC, Salamander Software, 17 Norfolk Road, Brighton, Sussex BN1 3AA, tel (0273) 771942, £9.95

'The French Mistress Level B', BBC and Electron, Kosmos Software, 1 Pilgrims Close, Harlington, Beds LU5 6LX, tel (05255) 3942, £9.95

THESE three programs seem to be representative of what's happening on the language-learning front as far as micros are concerned. Much as many of us would like to believe that computers make marvellous teaching aids in this area, the results all too often don't live up to expectation. In effect computer software tends to reduce both itself and its pupils to the level of parrots.

Let's start with the Beebug program. This comes equipped with the program *Vocab* followed by 'starter' vocabularies in French, Italian, Spanish and German.

For reasons of space, I'll confine my comments to the French version. The vocab test slings words at you, answering 'correct' or 'wrong' according to your response. The function keys are used to place accents on the words.

Unfortunately, the slightest disagreement between the user and the machine produces 'wrong', however trivial the fault. At first, I found it mildly irritating to discover that 'to advise' is the wrong response to 'conseiller'. 'Advise' alone is the correct answer. My irritation increased when my responses to 'surtout' and 'volontiers' - 'above all' and 'willingly' - were also 'wrong' ('especially' and 'gladly' are the only accepted responses). Yet my Harrap French-English dictionary gives my word as its own first choice of translation for the latter.

Far worse than this, however, is that in the space of 10 words I was given 'paques', 'mars', 'angleterre' and 'je suis'. In each case the program accepts only 'easter', 'march', 'england' and 'i am'... My old French teacher would have rapped my knuckles for such lower-case abominations.

The other two programs suffer from the same lack of flexibility, though not in such extreme degrees. The Salamander Software package covers general vocab, irregular verbs and idioms. I found the program tedious to use, with strange use being made of the function keys for compatibility with the 0.1 Operating System (surely a thing of

the past now). The function keys are also used to enable you to put French accents on the words, a tortuous process made only just acceptable through the use of an overlay card.

The Kosmos Software package is probably the best of the bunch, although it is also little more than a rigid database. It is a menu-driven program with nine options, although only two of them are related to learning (the others relate to creating new lessons and tape I/O).

Option 2 displays a word or phrase in one language for a user-specified amount of time; it then displays the translation for another specified amount of time. The best feature is that masculine and feminine words are shown in different colours.

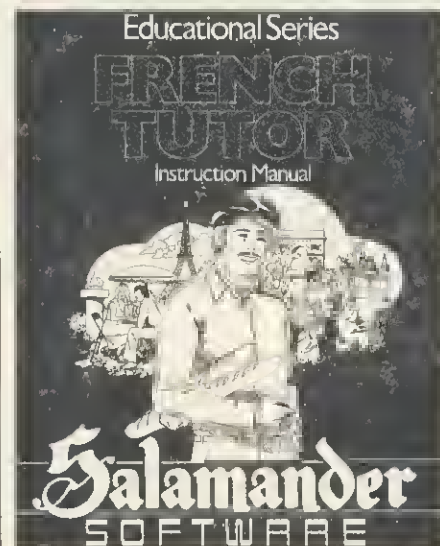
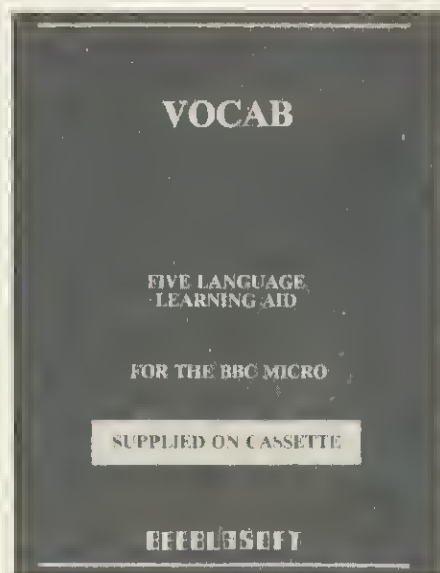

Kosmos  
Software

A French Language  
Learning Aid.



Option 9 is supposed to test your translation abilities but won't allow an incorrect answer. If you press a wrong key the program beeps - and won't allow you to use Delete. Non-perfect typists will find it wearisome to have to press Copy to continue, at which point the program provides the next letter. At the end of the lesson a table shows you how many questions you answered correctly - ie, with no typos - and the number answered incorrectly: ie, the number of answers with typing errors which the program wouldn't allow you to correct.

All three programs offer the facility to write your own vocabularies but in no case does the problem of flexibility ease. Surely it is not beyond the imagination of a programmer, especially on a machine with really fast Basic like the Beeb, to introduce a little analysis into the answers. Thus, if the problem is merely one of upper or lower case, or a simple typing error, it's not asking too much of the program to give the user a line like: 'I think you're nearly there, please try again.' Similarly, any program which can't give a response other than 'wrong' to synonyms or near-synonyms can hardly be described as a learning aid.

Learning vocabulary by rote is somewhat out of fashion these days, but even my old teacher, who was a stickler for making O and A-Level pupils learn from 10 to 25 words a day, would have given these programs the electronic equivalent of a rap over the knuckles.

Would-be students of French are advised to put their money towards a day-trip to France.

Simon Dally

# FOOTBALL MANAGER

Designed by Kevin Toms

## for the BBC Model B

### Some outstanding features of the game

- Matches in 3D graphics • Transfer market
- Promotion and relegation • F.A. Cup matches
- Injury problems • Full league tables • Four Divisions
- Pick your own team for each match • As many seasons as you like
- Managerial rating • 7 skill levels • Save game facility
- Financial manipulations • 64 teams and customising feature
- You can even be sacked!

Prices: BBC Model B	£7.95
Commodore 64	£7.95
Spectrum 48K	£6.95
ZX81 16K	£5.95

(N.B. 3D GRAPHICS ARE NOT INCLUDED IN THE ZX81 VERSION)  
Overseas orders add £1.50

Strategy Game of the Year, 1983  
(Nominated)

Golden Joystick Awards

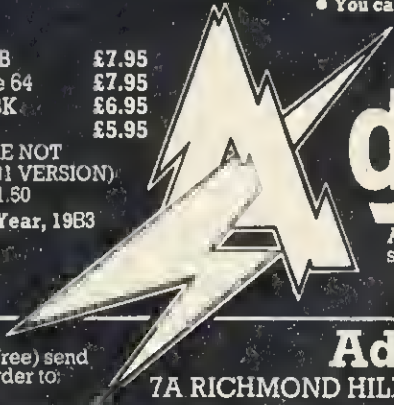

# Addictive

Available from computer software stockists nationwide, including



and

John Manzes



To order by mail (p&p free) send cheques or postal order to:

## Addictive Games

7A RICHMOND HILL, BOURNEMOUTH BH2 6HE

# Micro Resources Limited

Southfield House, 11 Liverpool Gardens, Worthing, Sussex BN11 1RY  
Telephone: Worthing (0903) 213174

### COMPUTERS

BBC Model B	£399.00
BBC Model B Disc Interface	£469.00
BBC Model 8 Econet	£446.00
BBC Model B Econet & Disc	£516.00
Acorn Electron	£199.00

### DISC DRIVES

TEC Single Sided 100K	£124.95
TEC Single Sided 200K 40/80	£149.95
TEC Double Sided 400K 40/80	£189.95
TEC Dual Double Sided 800K 40/80	£379.90

### PRINTERS

Epson P-40 Thermal 40 Col	£99.95
Brother HR5 Thermal 80 Col	£159.95
Admate ADM-80 F/T B0cps	£225.00
Epson RXB0 F/T 100cps	£279.95
Kaga Taxan KPB10 160cps & NLO	£299.95
Juki 6100 Daisywheel	£379.00

### MONITORS

Phillips 12" TP200 Green Mono	£75.00
Microvitec 14" Colour Std.Res.	£209.95
Sanyo 14" Colour Std.Res.	£199.00
Sanyo 14" Colour Med.Res.	£324.95
Sanyo 14" Colour Hi.Res.	£459.95
ITT 14" TV/Monitor	£239.00

### ACORN ADD-ONS

6502 2nd Processor	£199.00
ZB0 2nd Processor + Software	£399.00
Teletext Adaptor	£225.00
Acorn 8bitstik	£375.00
Acorn IEEE 488 Interface	£325.00

### SOFTWARE

Acorn Word Processor View	£59.00
Acorn Spreadsheet Viewsheets	£59.00
Starbase Database	£69.00
Wordwise	£46.00
Disc Doctor	£33.35
Mass Macro Assembler	£35.00

### VISA

All Prices Include VAT and Delivery - No Extra Charges -  
Send cheque to above address or phone to use your  
Barclaycard. Quantity and Education Discounts Given  
Phone for a Quotation



## BASICALLY IMPURE

## BUT FUN

'Quality Programs for the BBC Micro' by Simon, Micro Press, £6.50, 207 pages (program tape £9.45)

### QUALITY PROGRAMS FOR THE BBC MICRO

Simon



THE book is split into five sections and contains 18 programs. The sections are headed Applications, Educational, Graphics, Games, and Mathematical.

The programs themselves are not remarkable, although they are probably as good a collection as I have seen in the flood of computer books now available.

What is really good about this book is not so much what the programs do but how they are written. It does much to advance the case for structured programming, mainly because the author never falls into the trap of being pompous or messianic. His nice, subtle sense of humour, evident throughout the book, makes it a pleasurable read. He is not afraid, on the odd occasion, to use GOTO but this almost seems like devilment on his part. Purists may also take exception to the technique of providing multiple exits to functions, as in the *Tachistoscope* program, but it adds to the fun.

The section for each program has an introduction explaining what it does and how to use it, the listing, a good blow by blow explanation, a discussion of each new technique used and suggestions for modifications. There are examples of just about every type of Basic program you could want, with the exception of utilities, each excellently written and clearly explained.

With a few exceptions the programs are not over long and I don't think I would bother buying the optional tape. It is often quite a good exercise to type in programs - if they are accurately printed, as these appear to be.

What I most enjoyed about this book is the feeling it gives that the author had a good time writing it. After all, if he was bored you probably will be too. I recommend it to anybody wishing to improve his or her Basic programming technique and have some fun doing it.

Harry Sinclair

## COLOURFUL PRIMER

'Step-by-Step Programming' (Books 1 and 2) by Ian Graham, Dorling Kindersley (London), £5.95 each

MANY people entering the world of computers seek a book that explains in plain, readable English the language of their computer and its applications. These books do this by beginning with the basics and progressing to more complex forms of programming in easily followed stages.

The books explain in detail the layout



and various parts of the computer, Basic commands, first programming steps and the more advanced rudiments of graphics, sound and games programming. A section dealing with the conversion of other computer languages to BBC Basic may be useful to some users.

The books are extended versions of the BBC user guide but the lucid illustrations and accompanying text make them more interesting to read and use. Thus the reader is more likely to use the books in conjunction with the computer than read them as one might a

novel, and to supplement reading by practising the skills learnt. The programs illustrate well the topics discussed.

An attractive inclusion is the addition of photographs of the screen output when the listed programs are entered and run, but when used to present the program listings this format has its drawbacks, for the small compressed print makes entering mistake-free programs difficult. The size of the books could also present a problem for the user who works in a small area.

The inclusion of flowcharts in Book 1 is helpful and they should have been used throughout the book to explain program design, especially in the sections on games programming.

The glossary at the back of both books is handy for the newcomer but the index is rather limited and deals mainly with the commands used.

To sum up, these two books are comprehensive guides to the operation and programming of the BBC micro for student computer users or those who wish to broaden their knowledge. They would be a helpful, colourful addition to all but the most proficient micro users' bookshelf.

Wendy Nash-Steer

## WHATEVER TAKES

## YOUR FANCY

'Handbook of Procedures and Functions for the BBC Micro' by Audrey and Owen Blishop, Granada, 143 pages, £6.95

THIS is the 13th book from Granada for the BBC micro and I think they're getting a bit short of ideas. For your £7 you





# ADD 40 COMMANDS TO BBC BASIC WITH ONE ROM

**G  
R  
A  
P  
H  
I  
C  
S**

**SCALE** is a powerful and totally flexible statement that allows the user to take control of the scaling of the screen. Integers, real numbers and variables can be used. **ROTATE** is used to 'rotate' the axes about a point and by an angle both defined by the **ROTATE** statement on a scaled screen.

**CIRCLE** and **ELLIPSE** allow a multitude of shapes to be drawn using a single statement, including: any regular polygon, circles, arcs, solid sectors, triangles, squares, etc.

**FILL** is used to 'fill' a previously drawn area, with **CFILL** setting the colour/pattern/shade within pre-drawn bounds.

**TRANS** is used to translate the scaled area across the screen by the use of cartesian co-ordinates, subsequent graphics commands making use of the now displaced scaled area.

Plus: **SMOVE**, **SDRAW**, **SLOT** and **UNSCALE**.

**4  
I  
N  
1**

**LIST** can be programmed, unlike **LIST**, and under the User's control, multiple statement lines can be split up into their component parts allowing for greater ease of reading.

**LGOTO** is similar to the **GOTO** statement but more powerful in that it enables the user to jump to 'labelled lines' allowing for neater and more readable programmes.

**SORT** allows the user to sort all or part of a string array into alphabetical order using a single statement. Invaluable for data processing.

**SETWIN** and **WIN** allow the user to define, using **SETWIN**, and display, using **WIN** up to seven complete windows on the screen. The user being able to select and return to previously de-selected windows at will, the cursor maintaining it's last used position within that window.

Plus: **OPT**, **POFFOR**, **POFGOS**, **POPREP** and **ADDCOMM**.

**G  
E  
N  
E  
R  
A  
L**

Compatible with: Acorn DFS, AmcoR(Pace) DFS, Watford DFS, Wordwise, Disc Doctor. Model B, BASIC 1 or 2, OS 1.20

## ADDCOMM

Plus: \***HELP** displays the full syntax of all commands. Price includes a detailed ring-bound User Guide.

**L  
O  
G  
O**

**LMOVE** is used to position the **LOGO** cursor, usually used prior to further **LOGO** statements.

**ANGLE** is used to set the intended direction of the **LOGO** cursor, the angle being described in degrees.

**ADVANCE** is used to move the cursor in the direction as set by **ANGLE** by the distance described in the **ADVANCE** statement.

**TURN** gives the cursor a new direction by turning it a certain number of degrees anti-clockwise from its previous direction.

**PEN** defines the kind of trail left by the **LOGO** turtle using the internal plot codes.

**LCIRCLE** and **LELLIPSE** are the **LOGO** equivalents of the similar enhanced graphics commands, the shape centre being the current **LOGO** cursor position.

**LPOS** is used to return the position of the **LOGO** cursor from a **SCALED** screen.

**£28**

includes V.A.T. post and packing.

**CHAR** is a simplified 'character' designing facility using an enlarged grid that enables the user to quickly and easily construct or alter graphic and pseudo-alphanumeric characters.

**COMPACT** is used to reduce the size of all or part of an existing program by intelligently appending lines together.

**FIND** is used to search all or part of a program to find any desired character or set of characters.

**CHREPL** and **SREPL** are two related commands that enable the user to replace a character or group of characters with any other character or group of characters, under total control of user.

**LVAR** is used to list all, or alphabetically selected, variable names currently within memory.

**VERIFY** is a simple command to confirm that a copy to tape or disc is exactly the same as the original program in memory.

Plus: **MEM**, **GOODTRG**, **KILLREM** and **FKEYS**.

**H  
O  
M  
E  
C  
O  
M  
P  
U  
T  
E  
R**

These commands are unlike those on any other ROM, since they are used in exactly the same way as the standard BASIC commands - i.e. any numeric/string expression, multi-line statements, access to any variable, etc. etc. etc.

NOW AVAILABLE FOR

**ELECTRON**  
WITH ROM BOARD

VINE MICROS, MARSHBOROUGH,  
SANDWICH, KENT. CT13 0PG.  
(Or send stamp for Brochure.)

Home Computers can Cater for Cooks

**NEW!** "COMP-u-CATER"

—takes the calculating out of cooking

SIX ITEM MENU SELECTIONS plus QUANTITIES FOR REQUIRED SERVINGS

400 INGREDIENT DATABASE plus COMPREHENSIVE USER MANUAL

COLLATED SHOPPING LIST plus AMENDMENT BEFORE PRINTING

RECIPE MODIFICATION plus EASY ENTRY OF YOUR OWN

PRINTED TABLE MENUS plus PRINTED SCALED RECIPES

OVER 200 RECIPES plus INGREDIENT QUANTITIES RANDOM ACCESS FILES

"COMP-u-CATER" full menu planner 40T disc £24.95\*

"WHAT'S TO EAT?" simple menu planner cass. £9.95\*

"WHAT'S TO EAT?" teaching pack 40T disc £17.45\*

also NEW!

"PRINTER DRIVER" JUKI 6100 with view 40T disc £10.00\*

\*ADD 50p p. & p. (overseas deduct 15% VAT add £1 p. & p.)

**SHUMWARI ASSOCIATES**

(Dept. B)

12 Marlin Court, Marlow, Bucks. SL7 2AJ

**E**ducational  
**E**ngineering  
**M**athematical  
**S**cientific

## PROGRAMMING

NEW - "EMS-BEEBGRAPH"  
NEW - "NAVIGATION-AID"  
STILL AVAILABLE - METRICATOR

PROBLEMS WITH METRIC OR SI UNITS?

The **METRICATOR** suite of programs for the BBC B and **ELECTRON** may be your answer. Can convert ANY unit into ANY other compatible unit eg KM/LITRE into MILES/GAL or BTU/HOUR/FT<sup>2</sup> into JOULES/SEC/M<sup>2</sup>. "SI" may be specified and the correct SI equivalent automatically calculated. Saves hours of work. 15 UNIOQUE routines designed for EASY insertion into YOUR program give instant access to many thousands of combinations of units.

NEED TO ANALYSE AND PLOT EQUATIONS?

**EMS-BEEBGRAPH** will solve-it. **EMS-BEEBGRAPH** finds ALL real solutions of equations; finds max/min, turning points, areas, volumes, differentials and other properties. The function may be plotted complete with scaled axes making for easy to produce clear illustrations. Ideal for presentations and as a teaching aid

LEARNING NAVIGATION?

LIGHTS AND BOUY'S RECOGNITION

**NAVREC** helps you learn the navigation lights of sea going vessels, the shapes of bouys seen around our coast, signal code flags and morse code (using signals through the BEEB's loudspeaker). Altogether eight menu driven programs giving full graphic illustrations including actual simulated views of ship's lights from different directions at night. Question and answer tests included. This suite is great value for money and would please any nautical man.

NEED ANYTHING? Contact us! We will have it or will find it. WANTED! more programs of any sort provided they are useful, of a high standard and your own. Send yours to us for evaluation (tape, disc or sample run with instructions).

Prices (Inc p&p)

**METRICATOR** Tape version £6.95. 40 track disc ----- £9.95  
Instruction manual and program listing only ----- £3.75  
**EMS-BEEBGRAPH** TAPE £7.95 40 track disc ----- £9.95  
**NAVREC** 40-track disc only ----- £9.95

Remittance to:- "EMS Programming", 134 Buckswood Drive, Crawley, Sussex, RH11 1BJ. Or send SAE for more details.



get 70 listings of procedures and functions and an introductory chapter explaining what they are.

Dealing with graphics first, there are procedures to draw circles, animate and rotate characters, and simulate an explosion. The best one is for scrolling the screen sideways or downwards. The three sound effects programs simulate gunfire, a spaceship and the BBC time pips. There are procedures that do strange things with lists of words and - tricky one this - a procedure to calculate averages.

The functions cover mainly mathematical and string applications: anagrams, number bases, factorials, yes/no validation and some functions to read the various 6502 registers.

None of the procedures or functions is particularly novel and some are very trivial. I typed in half a dozen of each and found two mistakes: ENDPROC had been missed off one procedure and in another the Owens got their formal and actual parameters confused. Still, there might be a few routines here that take your fancy.

**Geoff Nairn**

## BIG HELP FOR SHORT PEOPLE

'Take off with the Electron and BBC Micro', by Audrey and Owen Bishop, Granada Publishing, £5.95, 144 pages

THERE are 11 programs in this book, all quite short, and all in Basic except the last one, *Attack*, which contains some assembler. It is obviously aimed at younger people who are fairly new to the two machines and the authors go out of their way to be helpful. There is a gentle introduction to the basics of the PRINT command in a chapter called 'Your Briefing' and then you're into the programs themselves.

I like the layout of the program

chapters. There's a general overview of what the program does, the listing, a clear flowchart, an explanation of how the program works set out in exactly the same sequence as the flowchart, a discussion of each new keyword introduced, and finally suggestions on extending the program with tips on how this may be done. In addition, in chapters where a new idea has been brought in - such as file handling, rounding numbers, or formatting output - there is a section called 'The way to do it'.

The programs range from simple games such as *Stunt Car* and *Attack* to



spelling tests, tune learning, weather forecasting, birthday files and keeping track of your pocket money.

The book would make a nice, instructive present for any short person of your acquaintance who is even mildly interested in the new black art.

**Harry Sinclair**

## SIMPLE BUT MARRED

'Child's Play' pack, Dial Sott, 72 Downend Road, Downend, Bristol BS16 5UE, BBC, £6.95 (disc £8.50)

THE *Child's Play* tape consists of the following four programs: 'Numberbond', a program designed to help the child learn simple arithmetical bondings; 'Spellaway', a spelling and multiplication tables tester; 'Shapes', a program to show the relationship between objects of different shape and colour; and 'Fractions', which tests and develops perception of the relationship between a fraction and the original whole.

All these programs are brightly presented in a pleasant format and are easy to use. As they are intended for the early learner they need to be set up by an adult ready for the child's use. They all appear to do what they set out to do but there are aspects that mar the overall picture. Spelling programs should be scrupulously checked for spelling and grammatical correctness and yet Spellaway contains at least two major spelling mistakes as well as misplaced apostrophes. Moreover, the categories of words and their contents were peculiar - especially as this is

supposed to be Child's Play! How many adults would expect to know the meaning of 'frequentative' or 'quadrumanous'? And is 'intumescence' really a child's word? This criticism applied to most sections of this program but fortunately was counteracted by the fact that one could create one's own word lists.

Having made that criticism it must be said that the simple and straightforward programs offered by Dial represent good value for money, especially if the programs fill a particular need for your child or your class, and - yes - they can be transferred to disc!

**Nick Evans**

## PLUG-IN SECURITY

Security ROM, Software Services, £15

THIS device is supplied on an EPROM that plugs into the right-most ROM socket (IC 101) or the first ROM socket to be accessed on power-up. It is encoded with your own personal details and a five-character alphanumeric security code. When you switch on the details are displayed and you are required to enter the code before being allowed to continue. The code is not, of course, displayed and if

you make a mistake while typing it, the device will either reset itself after receiving five characters or you will have to press Break and start again. As it is not designed to be user-friendly - for obvious reasons - no prompts are given.

An additional feature is \*SEC. Typing this command while the machine is in use provides a temporary software lockout. You can recover from this without loss of program, but I don't want to give too many secrets away!

I wonder, however, how effective such devices are as a deterrent. After all, if it is that easy to install it is just as easy for anyone with a little common sense to remove, rendering the micro bog-standard and traceable only by its serial number. For those more conscientious I suppose you could go to the trouble of removing the ROM socket and soldering the device in permanently. It's certainly a possibility but again one that could be overcome by the more determined criminal.

Whether or not a device of this type serves a useful purpose and is value for money is a personal attitude. If it provides what you are looking for then it is obviously worth having. An important question is whether the supplier will change the device if your personal details change.

**Ian Rowlings**

Put an end to inefficient, slow cassette tape storage



# Speed your data access with a TEAC disk drive from Viglen

Comprehensive, fact-filled, 53 page manual including techniques of loading from cassette to disc. Not available elsewhere

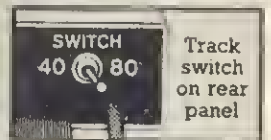

Replacing your cassette with a disk drive means data access in seconds! VIGLEN TEACS unlike others have been specially modified to operate successfully with ACORN and other filing systems, over coming RANDOM accessing problems normally experienced with these disk drives. Prices include VAT, Formatting Disk, User Manual, Case and Leads.

When ordering Dual Drives, please state which layout you prefer A or B

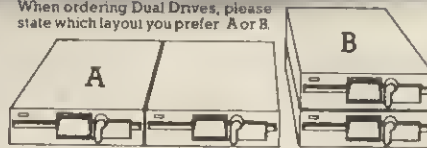

TEAC 55 Slimline Drives		DUAL DRIVES	
SINGLE DRIVES	Inc. Excl.	CASED	Inc. Excl.
	VAT VAT		VAT VAT
40 TRACK 100K	£119.00 £103.48	40 TRACK 200K	£240.00 £208.69
40 TRACK 200K	£160.00 £139.13	40/80 TRACK	£280.00 £243.48
40/80 TRACK	£140.00 £121.74	SWITCHABLE 400K	
SWITCHABLE 200K		40/80 TRACK	£378.00 £328.70
40/80 TRACK	£189.00 £164.35	SWITCHABLE 800K	
SWITCHABLE 400K	£25.00 £21.74	Integral power supply	
Integral single		for dual drives	
power supply	£25.00 £21.74	Acorn Disk	
		Interfaces	

please ring  
£45.00 £39.13

All prices correct at time of going to press and all offers subject to availability  
 ● Utilities disk includes 13 useful utilities including: ● formatting ● verifying ● screen dump ● disassembler ● generating 62 files, etc.  
 ● Orders welcomed from Educational Establishments and Government Departments



**Full Twelve Months Guarantee**

### How to order

**By post:** To purchase any of the items simply fill in the coupon with your requirements. Enclose your Cheque/P.O. or use your Access/Barclaycard. Please make cheques payable to: VIGLEN COMPUTER SUPPLIES and post to above address. Allow seven days for delivery and add £8.00 carriage, package and insurance on all items.

**By telephone:** Ring (01) 843 9903. Credit Card holders (Access/Barclaycard only) can purchase by telephone. Please give Card No., Name, Address and the items required.

# Viglen

COMPUTER SUPPLIES

Unit 7 Trumplers Way  
Hanwell W7 2QA  
Tel: (01) 843 9903

**EASY ON-THE-SPOT PARKING AND IT'S FREE!**

Please send me the following items:

I enclose Cheque/P.O. for £ \_\_\_\_\_

I prefer to pay by ACCESS/BARCLAYCARD\* . Card No: \_\_\_\_\_

Signature \_\_\_\_\_

Name \_\_\_\_\_

Address \_\_\_\_\_

Unit 7 TRUMPERS WAY, HANWELL, W7 2QA

Layout A or B\*  
Add £8 carriage. \*Delete as necessary

AUT111



# Canon 200K Disk Drive + Acorn DFS

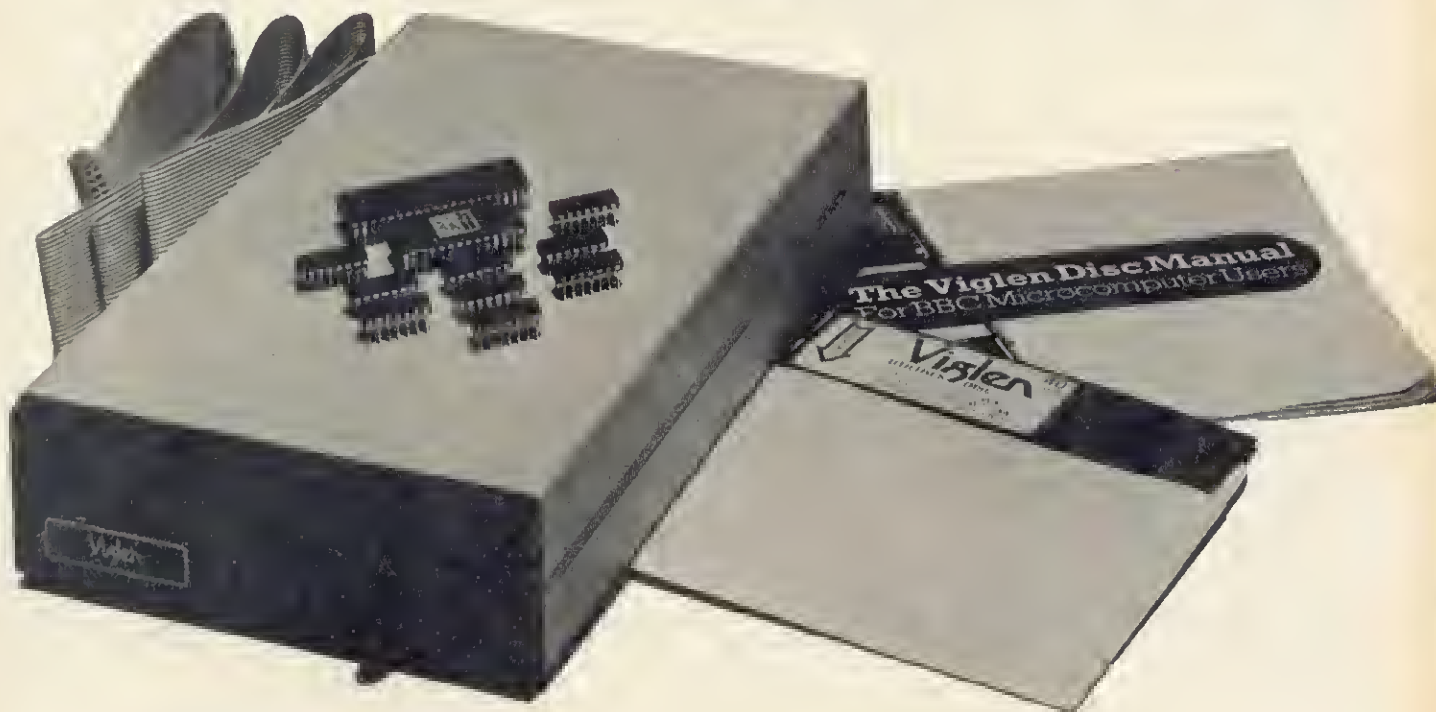

## COMPLETE DISK SYSTEM FOR THE BBC MODEL B

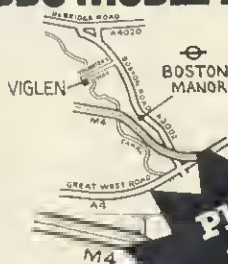

• Package assumes you own a BBC Model B with switched mode power supply plus 1.2 operating system.

### OFFER INCLUDES:

- Disk Interface (call at factory for free fitting while you wait, or supplied with easy to fit instructions)
- 200K 40 track double-sided Canon Disk Drive including case and all leads
- User Guide
- Utilities Disk including formatting, verifying, BASIC program comparator, disassembler, Epson screen dump, dual catalogue (giving 62 files), large printing and others

Please Ring  
01-843 9903  
for LATEST  
PRICES

**DISK DRIVE  
& ACORN  
INTERFACE  
£199  
INC  
VAT**

**Viglen**  
COMPUTER SUPPLIES  
Unit 7 Trumplers Way  
Hanwell W7 2QA  
Telephone: (01) 843 9903  
AMPLE ON-THE-SPOT  
CAR PARKING -  
AND IT'S FREE!

Prices correct at time of going to press - offer subject to availability

Post to: VIGLEN COMPUTER SUPPLIES UNIT 7, TRUMPERS WAY, HANWELL, W7 2QA

Please send me \_\_\_\_\_ (Qty) TEC 200K + DFS

I enclose Cheque/P.O. for £ \_\_\_\_\_

I prefer to pay ACCESS/BARCLAYCARD \_\_\_\_\_ made out to VIGLEN COMPUTER SUPPLIES (please add £8 for carriage)

Signature \_\_\_\_\_

Name \_\_\_\_\_

Address \_\_\_\_\_

Order with your Access/B Barclaycard number where applicable

AD1172

# USER GROUPS

✓ This indicates clubs that have responded to our circular asking for confirmation of details and continued existence. Would those clubs who have not responded please do so, otherwise they will be deleted from our list.

200

- ✓ **The Secretary Wakefield BBC Micro User Group**  
116 Pinderfields Road  
Wakefield  
West Yorkshire WF1 3PL
- Colin Price  
**Keighley Computer Club**  
Red Holt  
Hainsworth Wood  
Keighley  
W. Yorks  
Tel: Keighley 603133
- Jennifer Woeller  
**Sutton Library Computer Club**  
Sutton Central Library  
St Nicholas Way  
Sutton, Surrey  
Tel: 01-861 5031
- Mr C. Rutter  
**Medway Atom Users Club**  
St John Fisher School  
Ordnance Street  
Chatham  
Kent
- Mr J. Ashurst  
**Acorn Computer Users Group**  
Abraham Moss Centre  
Crescent Road  
Manchester 8
- ✓ **BBC Adventure Club**  
18 Weardale House  
Woodberry Down  
London N4 1ON
- ✓ **John Wood Atom Users' Group of Canada**  
812 Cabot Trail  
Milton  
Ontario L9T 3M8  
Canada
- ✓ **Austin Vaughan Irish Amateur Computer Club**  
35 Monastery Drive  
Clondalkin  
Dublin 22  
Eire  
Tel: (01) 593112 (evenings)
- ✓ **Miss J. Lines South East Essex BBC User Group (SEEBUG)**  
97 Oakhurst Drive  
Wickford  
Essex SS12 0NW  
Tel: 03744 63396
- ✓ **D. Donaldson, Secretary Bracknell Primary Schools Computer Users' Group**  
Wildridings County Junior School  
Netherton  
Bracknell  
Berks RG12 4DX
- Stuart Mallinson  
**Huddersfield BBC Micro User Group**  
34 Ryefields  
Scholes  
Huddersfield  
West Yorks HD7 1XF
- J. Smith, Secretary  
**Brighton, Hove & District Computer Club**  
30 Leicester Villas  
Hove  
E. Sussex BN3 5SQ
- ✓ **Mr Ric Keyworth North London BBC Micro Users Group**  
'The Penthouse'  
4b Kilburn High Road  
London NW6 5JL  
Tel: 01-734 9235  
(7am-3pm Mon-Fri)
- **West Midlands Computer Group**  
12 Apsley Road  
Oldbury  
West Midlands B68 0OZ
- Mr J. Price  
Bedford House  
27-28 St George's Road  
Brighton  
Sussex
- Mr P. Beverley  
**Norwich Area Acorn User Group**  
Room 12a  
Norwich City College  
Ipswich Road  
Norwich NR2 2LJ
- Keith Mitchell  
**Edinburgh ZX Computer Club**  
19 Meadowplace Road  
Edinburgh  
Tel: 031-334 8483
- Robin Bradbeer  
**Association of London Computer Clubs**  
Polytechnic of North London  
Holloway  
London N7 8DB
- ✓ **Andy Purkiss North & Mid-Essex User Group (NAMEBUG)**  
12 Palm Close  
Witham, Essex  
Tel: 0376 515609  
Prestel: 376515609
- ✓ **M. A. Cowley, President Beebnet**  
PO Box 262  
Kingswood  
South Australia 5062
- Mr D. L. Evans  
23 Hitchin Camp  
Henlow Camp  
Bedfordshire
- ✓ **R. Welch Harpenden Microcomputer Group**  
7 Tylers  
Harpenden  
Herts AL5 5RT
- Mr P. Frost  
**Atom Users Group**  
3 Leyland Road  
Bulkington  
Warks CV12 9LW
- Ray Mitcham  
**Southport BBC Micro Group**  
5 Easedale Avenue  
Ainsdale  
Southport  
Tel: 79936
- ✓ **The Secretary Radio Amateur User Group (G4KCS)**  
c/o R. A. Webb  
39 Aldworth Road  
Stratford  
London E15 4DN
- Malbeeb  
**BBC Users Club**  
'Micar'  
St Monica Street  
Guardamangia  
Pieta  
Malta
- ✓ **John Hannon Tasbeeb (BBC Users' Group)**  
Box 25 PO  
North Hobart  
7002 Tasmania  
Australia  
Tel: (002) 342704
- A. F. Powell  
**The Daventry and District Computer Club**  
c/o The Daventry  
Ex-Servicemans Club  
Market Square  
Daventry  
Northants
- ✓ **BBC INFO**  
Horten Ingeniorhogskole  
Skippergt. 6  
3190 Horten  
Norway
- ✓ **E. R. Piper Bognor Computer Group (BUG)**  
2 Ely Gardens  
Aldwick Park  
Bognor Regis  
Sussex PO21 3RY
- Andrew Pike  
**Peterborough Personal Computer Club**  
920 Bourges Boulevard  
Peterborough PE1 2AN  
Tel: 0733 44342 (after 5pm)
- ✓ **John Farris Mid-Cheshire Computer Club**  
75 Swanlow Lane  
Winsford  
Cheshire CW7 1JD  
Winsford 53339
- **Liverpool BBC Microgroup**  
c/o Fred Shaw  
14 Albany Avenue  
Eccleston Park  
Prescot  
Merseyside L34 2OW
- John Harris  
**Bottisham Acorn User Group**  
1 Rowan Close  
Bottisham  
Cambridge CB5 9BN  
Tel: (0223) 811487
- ✓ **Brian Pain BEEBACC**  
40a High Street  
Stony Stratford  
Milton Keynes  
Tel: (0908) 564271
- ✓ **Duncan Coulter Preston BBC User Group**  
8 Briar Grove  
Ingol  
Preston PR2 3UR
- **Acorn Users Group of Sweden**  
c/o Janne Soderberg  
Frihetsvagen 32  
S-175 33 Jarfalla  
Sweden
- ✓ **Anders Wickman BBC User Group (BUG)**  
Folkungagatan 58  
116 22 Stockholm  
Sweden
- Peter Wilson  
**Universal Micro Club**  
26 North Cape Walk  
Corby  
Northants NN18 9DO  
Tel: Great Oakley 742622
- ✓ **John Haigh Iver Computer Society (IC's)**  
11 Colliston Walk  
Fords Farm  
Calcot, Reading  
Berks RG3 5ZJ  
Tel: 0734-417534
- John Eary  
**Kinder Peak Computer Club**  
36 Parkway  
New Mills  
Tel: New Mills 43870
- C. Verrier  
**Wandsworth Computer Club**  
Earlsfield Library  
Magdalen Road  
London SW18
- Mr J. Craig  
**National BBC User Group**  
40 Mount Pleasant Avenue  
Wells  
Somerset BA5 2JO
- Mr R. Luff  
**Kingbee**  
54 Arlington Close  
Kingswinford  
West Midlands
- ✓ **Computer Club**  
Caterham Leisure Centre  
Godstone Road  
Caterham  
Surrey CR3 6RE  
Tel: Caterham 48304/43316
- Ted Ryan  
**Eastwood Town Microcomputer Club**  
15 Queens Square  
Eastwood  
Nottingham NG16 3BJ
- ✓ **Mr T. A. Kayani SOBAT Computer Club (East London)**  
12 Calderon Road  
London E11 4EU  
Tel: 01-556 5423
- ✓ **Mr J. Forrest Potbug BBC Users Group**  
50 Cliff Street  
Smallthorne  
Stoke on Trent  
Staffs.  
Tel: 818430
- ✓ **Steve MacLeod BBC Users Group of Canberra**  
5 Hatfield Street  
Evatt A. C. T. 2617  
Australia  
Tel: (062) 587719
- A. H. Fowler  
**Tonbridge School Computer Society**  
44 Birling Road  
Tunbridge Wells  
Kent TN2 5LY
- J. Assies, Secretary  
**Big Ben Club**  
PO Box 177  
4670 AD Zevenbergen  
The Netherlands
- H. W. H. Fisher  
**Sunningdale BBC User Group**  
82 Cedar Dive  
Sunningdale  
Berks SL5 0UB  
Tel: Ascot 25030
- ✓ **Peter Hughes Format 40/80 Club**  
BBC Disc User Group  
5 Marsh Street  
Bristol BS1 4AA
- Dave Davies  
229 Manley Road  
Chorlton-cum-Hardy  
Manchester M21 1RB  
Tel: 061-881 0382
- ✓ **Tony Latham Computer Users Club**  
69 Hadlow Road  
Welling, Kent DA16 1AX
- ✓ **Tony Pickard Newcastle & Washington BBC User Group (NEWBUG)**  
c/o Washington Town Centre  
Library  
The Galleries  
Washington, Tyne & Wear  
Tel: Houghton (927) 849342  
after 6pm
- ✓ **John Fryer, Treasurer ABUG**  
17 Edgedale Road  
Sheffield S7 2BO
- ✓ **Chris Parry, Secretary Stratford Computer Club**  
15 Kipling Road  
Stratford-on-Avon  
Tel: 0789 68080
- ✓ **Robert Watt Inverclyde BBC Micro Users' Club**  
9 St John's Road  
Gourock  
Renfrewshire PA19 1PL  
Tel: Gourock 39967
- ✓ **Antony Hurden West Suffolk BBC Micro Users' Club**  
14 Plovers Way  
Bury St Edmunds  
Suffolk IP33 2NJ
- **Forum 80**  
421 Endike Lane  
Hull HU6 8AG
- ✓ **Simon Ward Porchester & Fareham Computer Club**  
9a East Cams Close  
Downend  
Fareham  
Hants PO16 8RP
- ✓ **D. Davidson Central Scotland BBC User Group**  
1 Roxburgh Place  
Larbert  
Stirlingshire FK5 4UE
- ✓ **Linda Yeomans, Secretary Beeb Users Group (Bug Club)**  
13 Regent Street  
Church Gresley  
Burton-on-Trent  
Staffs DE11 9PL
- ✓ **Arjen Raateland Hopeatie 10A21**  
00440 Helsinki 44  
Finland  
Tel: 90-5625027
- ✓ **Sqn Ldr J. A. Upham RAF Personal Computer Association**  
Man S (ADP)  
HO RAFSC  
RAF Brampton  
Huntingdon PE18 8OL
- ✓ **Bazyle Butcher Harrow Computer Group**  
16 St. Peter's Close  
Bushey Heath  
Watford WD2 3LG  
Tel: 01-950 7068
- ✓ **MUSE (for teachers)**  
PO Box 43  
231/2 Friary Chambers  
Whitefriargate  
Hull HU1 2HD  
Tel: 0482 20268
- ✓ **Nik Kelly Mersey BBC User Group**  
56 Queen's Drive  
Liverpool L4 6SH
- ✓ **R. V. Souter, Secretary TRS-80/Beeb Users Group**  
4 Risby Garth  
Skidby  
Cottingham, Hull  
HU16 5UE  
Tel: 0482 845326
- ✓ **BBC Micro Club Tenerife**  
PO Box 1297  
Santa Cruz de Tenerife  
Canary Islands (Spain)  
Tel: (922) 216546
- ✓ **Rupert Steele Association of Computer Clubs**  
17 Lawrie Park Crescent  
London SE26 6HH
- ✓ **Andy Leeder Amateur Computer Club**  
Church Farm  
Stratton St. Michael  
Norwich NR15 2QB
- ✓ **Bob Hindle South Yorks Personal Computer Group (SYPCG)**  
139 Penrhyn Road  
Sheffield S11 8UP
- ✓ **J. G. Dowling Acorn Atom Users Group**  
27 Oribi Avenue  
Van Riebeeck Park  
Kempton Park 1620  
South Africa



# Buy from the specialists.

# VIGLEN offer of TEC drives

(As used by Cumana) **beats all comers**

Replacing cassettes with disc drives means programme loaded and data accessed in seconds not minutes.

Our guaranteed disc drives are supplied with a comprehensive fact-filled 53 page manual, exclusive to Viglen, which shows loading from cassette to disc and other information for the BBC Model B.

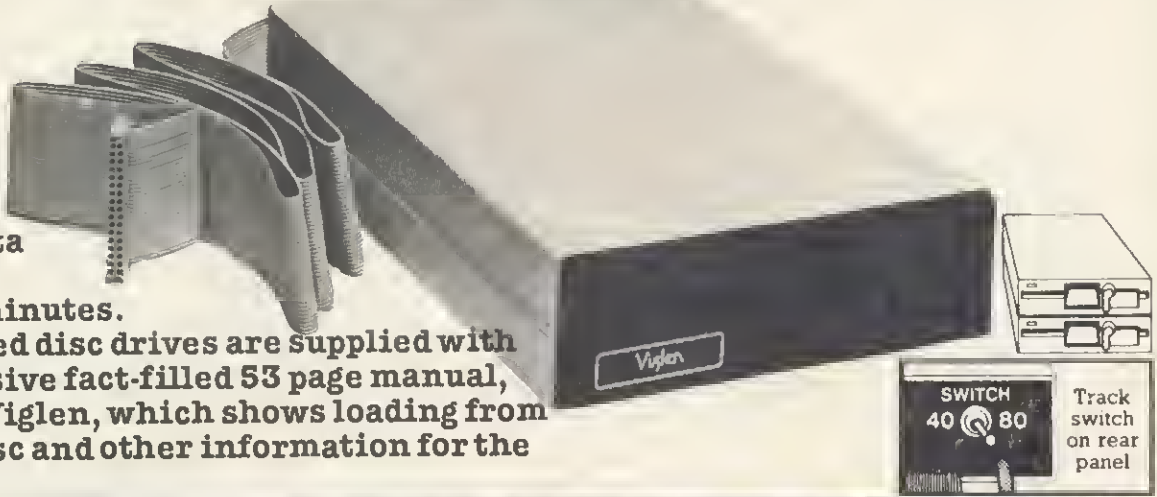

## TEC 504 SLIMLINE DRIVES

	Incl VAT	Excl VAT		Incl VAT	Excl VAT
<b>Single Drives</b>			<b>Dual Drives</b>		
40 Track 100K 5 1/4"	£119.00	£103.48	40 Track 200K	£238.00	£206.96
Single sided 40/80 track 200K switchable 5 1/4"	£139.00	£120.87	40/80 Track Switchable 400K	£278.00	£241.74
Double sided 40/80 track 400K switchable 5 1/4"	£179.00	£155.65	40/80 Track Switchable 800K	£358.00	£311.30
Integral Power supply for single drive	£20.00	£17.39	Integral Power supply for dual drive	£40.00	£34.78
			ACORN Disc Filing System	£105.00	£91.30

**Please Ring 01-843 9903 for LATEST PRICES**

# Viglen

COMPUTER SUPPLIES

Unit 7 Trumpers Way  
Hanwell W7 2QA  
Telephone: (01) 843 9903

All prices correct at time of going to press and all offers subject to availability.  
All disk drives are supplied complete with Professional Screened Case - Ribbon Cable to connect to BBC Micro - Power Cable to connect to BBC Micro - Comprehensive Manual - Formatting and utilities disc, which includes 15 useful utilities including \* formatting \* verifying \* screen dump \* dis- assembler \* generating 62 files, etc.

**AMPLE ON-THE-SPOT CAR PARKING - AND IT'S FREE!**  
Post to: VIGLEN COMPUTER SUPPLIES UNIT 7, TRUMPERS WAY, HANWELL W7 2QA  
Telephone: 01-843 9903. Personal Callers Welcome.  
I enclose cheque/P.O. for £  
I prefer to pay ACCESS/BARCLAYCARD (Delete whichever is not applicable)  
Card No. \_\_\_\_\_  
Signature \_\_\_\_\_  
Name \_\_\_\_\_  
Address \_\_\_\_\_  
Incl 528 carriage Cheques payable to Viglen Computer Supplies.  
Cards/cheques valid subject to our card rules.

• Orders welcomed from Educational Establishments and Government Departments



**Full Twelve Months Guarantee**

### How to order

**By post:** To purchase any of the items simply fill in the coupon with your requirements. Enclose your Cheque/P.O. or use your Access/Barclaycard. Please make cheques payable to VIGLEN COMPUTER SUPPLIES and post to above address. Allow seven days for delivery and add £8.00 carriage, package and insurance on all items.

**By telephone:** Ring (01) 843 9903. Credit Card holders (Access/Barclaycard only) can purchase by telephone. Please give Card No., Name, Address and the items required.

## EXPANDABLE CONSOLE FOR BBC MICRO

As supplied to Universities, Colleges, Schools, business & home users

A professional console to house disc drives/2nd processor/Torch dual drives/teletext, etc. All untidy wiring out of sight in the strong aluminium console in a matching textured colour. AVAILABLE NOW a bolt on extra module for extra expansions.

Also available a matching printer stand, yes stack your paper under the printer.

ALSO VDU STANDS AVAILABLE

Torch version available

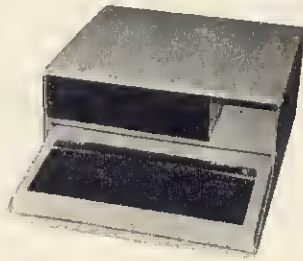

### ELECTRON CONSOLES

The console houses the electron and will safely support the expansion interfaces which plug into the rear of the micro, supports the VDU and tidies up all wiring, allows expansion to disc at a later date.

#### PRICES

Special Torch Version £46.99 + £4 p/p  
BBC Console £44.99 + £4 p/p  
Bolt on expansion £14.99 + £2 p/p  
VDU/Printer Stand £14.99 + £2 p/p  
Electron Console £34.99 + £4 p/p

Please add VAT @ 15% to all prices

For further information enclose sae or send cheque to,

Mail Order Only **Silent** 01-801 3014 27 Wycombe Rd London N17

Viewing by arrangement

**COMPUTERS**

24 hour ansaphone

Please allow 28 days for delivery

# SCOTLAND

BBC MICROCOMPUTER	£399
ACORN ELECTRON	£199
ELECTRON PLUS ONE	£59.95

## SPECIAL OFFER

ELECTRON WITH PLUS ONE £244.95

## TORCH GRADUATE

PHONE FOR AVAILABILITY

LARGE RANGE OF PRINTERS, MONITORS AND ACORN ACCESSORIES/SOFTWARE AT DISCOUNT PRICES.

## WEST COAST PERSONAL COMPUTERS

47 Kyle Street, Ayr KA7 1RS  
Telephone (0292) 285082

ALL PRICES INCLUDE VAT

# On the Road to Artificial Intelligence: BBC Micro

Unlike other introductions to BASIC, this book will also introduce you to artificial intelligence and teach you how to write exciting interactive programs. You will quickly discover the techniques needed to build data banks, beat the bugs, disentangle strings, establish a tamper-proof machine and allow free communication between you and your Beeb.

## On the Road to Artificial Intelligence: BBC Micro

Jeremy Vine



## Other Titles

Easy Programming for the BBC Micro £5.95  
Eric Deeson  
'Probably the best elementary BBC Basic text' - The Micro User.

Further Programming for the BBC Micro Alan Thomas £5.95  
'If you are sinking with Basic on your BBC Micro, this could be your life raft' - Educational Computing.

BBC Micro in Education Eric Deeson £6.50  
'Invaluable to a teacher who already knows BBC Basic and wants to write his or her own educational software' - Acorn User.



Shiva titles are available from large branches of Boots, Menzies, W. H. Smith and bookshops, computer shops and department stores. In case of difficulty, please write to: SHIVA PUBLISHING LTD, FREEPOST, 64 Welsh Row, Nantwich, Cheshire CW5 5BR. Telephone orders welcome: 0270 628272 (24 hrs/7 days) Telex: 367258 (GASEOP)

Qty	Title	Price	ORDER FORM
.....	On the Road to Artificial Intelligence: BBC Micro	£5.95	1 enclose a cheque for £..... made payable to Shiva Publishing Ltd. For payment by Access/Barclaycard/American Express:
.....	Easy Programming for the BBC Micro	£5.95	Card No. ....
.....	Further Programming for the BBC Micro	£5.95	Signature .....
.....	BBC Micro Assembly Language	£7.95	
.....	BBC Micro In Education	£6.50	

Name .....  
Address .....

Please send full catalogue of computer books and software

AU



# NEW!

# FROM Viglen



— Full Twelve —  
Months Guarantee

## DISK STORAGE

**No. 1**  
This diskette storage holds 70 diskettes

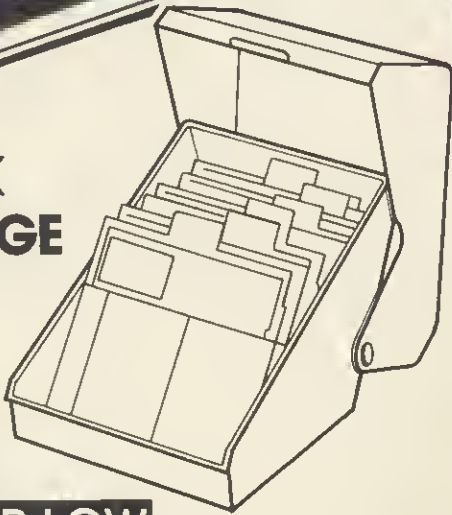

Our **SUPER LOW** price **£18.00** Including VAT

## COMPUTER SUPPLIES

Unit 7 Trumplers Way Hanwell W7 2QA Tel: (01) 843 9903

## DISK STORAGE

**No. 2**  
This lockable diskette storage holds 80 diskettes

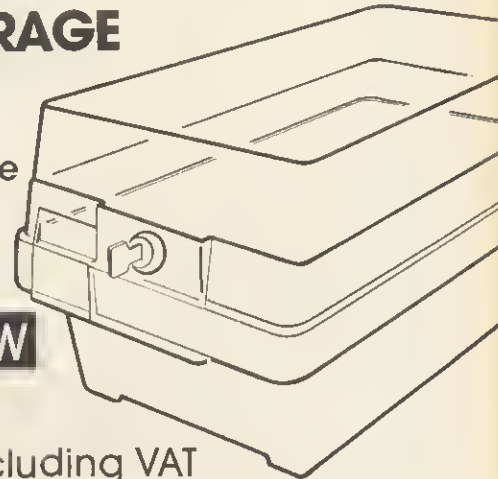

Our **SUPER LOW** price **£18.00** Including VAT

## 3M SCOTCH DISCS

5 1/4" diskettes single sided

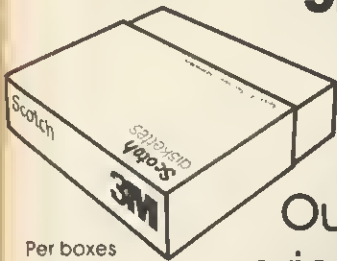

Per boxes of 10

boxes	1-2	3-9	10+
SS 40 TRACK	£15.00	£13.50	£13.00
DS 40 TRACK	£20.00	£18.40	£17.70
SS 80 TRACK	£23.00	£20.70	£20.00
DS 80 TRACK	£26.70	£24.00	£23.00

Our **SUPER LOW** prices Inc.VAT

## PERSPEX KEYBOARD STOWAWAY & VDU STAND

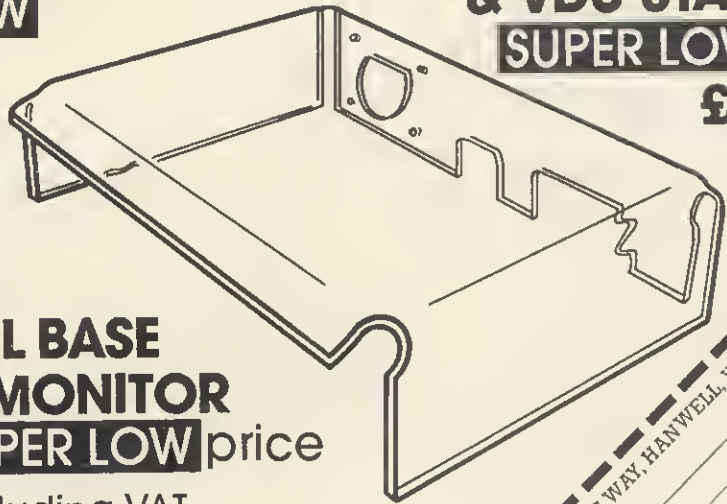

Our **SUPER LOW** price

**£14.95**  
Inc VAT



## SWIVEL BASE FOR MONITOR

Our **SUPER LOW** price **£16.00** Including VAT

## GRAFPAD Our **SUPER LOW** price **£143.75** Including VAT

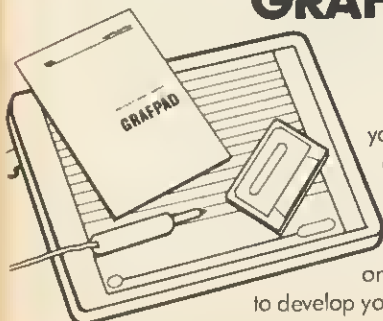

This remarkable Grofpod from British Micro allows you to input information into your computer - very accurate and high resolution, not to be confused with other models which are both more expensive and less accurate. Supplied with all necessary cables, manual and sample programs, to allow you to develop your own application programmes.

**AMPLE ON-THE-SPOT PARKING. AND IT'S FREE!**  
Post to: VIGLEN COMPUTER SUPPLIES, UNIT 7, TRUMPERS WAY, HANWELL, W7 2QA. Tel: 01-843 9903

Please send me the following items:

I enclose Cheque/PO for £ \_\_\_\_\_  
I prefer to pay by ACCESS/BARCLAYCARD\* Card No: \_\_\_\_\_  
Signature \_\_\_\_\_  
Name \_\_\_\_\_  
Address \_\_\_\_\_

All items £2.00 only for P & P.  
\*Delete as necessary

AU 11/4

Authorised

**acorn**  **dealer**

**B.B.C. B & acorn  
electron**

CUMANA disk drives  
DECCACOLOUR & MICROVITEC monitors  
SEIKOSHA, EPSON & DAISYSTEP printers  
ACORNSOFT/MERLE business software  
ACORNSOFT full range

**NEXUS HOUSE  
2 CRAY ROAD  
SIDCUP, KENT  
01 300 3075/6**

ACCESS/BARCLAYCARD WELCOME

## EXPORT

WE SUPPLY ACORN & TORCH. . . .

SPARE PARTS  
PERIPHERALS  
EPROMS  
DISKS  
SPECIALIST SOFTWARE  
UPGRADE KITS

TO ANY PART OF THE WORLD

ALL AT COMPETITIVE PRICES.  
VAT FREE.  
SEND FOR OUR CURRENT PRICE LIST.

**£19 FOR TEN**

VERBATIM DISKS.  
FREE DISKHEAD CLEANING KIT  
WITH EACH BOX OF 10 5¼" DISKS.

**HOLDERNESS COMPUTERS**  
17 Westgate, Patrington, near Hull,  
North Humberside.  
0964 30225.

## P. L. GRAPHICS SYSTEM

A complete hardware and software package for use with the BBC Model B and Research Machines Limited 380Z and 480Z micro-computers.

The system consists of the "digitising" tablet, software—on tape or disc containing five programs—instruction manual, key card, quick reference card, and exercise diagrams making an extremely powerful and versatile graphics/CAD package.

### KEY FEATURES INCLUDE

- \*Control Program with comprehensive range of instruction blocks
- \*Complete editing facilities
- \*Complete image manipulation
- \*Cursor utility calls
- \*Accuracy/speed
- \*Storage on cassette or disc file
- \*Plotter and printer dump programs
- \*User-defined character program
- \*Display program
- \*Select program

Supplementary software available to:

- \*List picture or diagram into X/Y co-ordinates. This enables other numerical data to be calculated, and the data may also be used to drive plotters, numerically controlled machinery and robots.
- \*Enter hundreds of items of information into computer with speed and accuracy thus giving a Questionnaire Analysis Package.

Write or phone for details. Educational discounts available.

**B. S. Dollamore Limited, Castle Gresley,  
Burton upon Trent, Staffs DE11 9HA.  
Tel: [0283] 217905.**

**U.K. Distributor Leasalink Viewdata Limited, Bridge Street,  
Sandiacre, Nottingham.  
Tel: (0602) 394000.**

## The Original "NEWARK" TV/RGB Monitor



It's £249.94  
incl. VAT — complete  
package!!

The package:

**£249.94** for a remote control 14" TV with a computer lead — delivered to your door — including VAT (we even fit a mains plug!) and carriage.

We have a **Large** range of **Grundig** models from 14" to 26" with or without Teletext.

Contact Elaine for an up to date leaflet package.

## NEWARK VIDED CENTRE LTD.

108 London Road, Balderton, Newark, Notts.  
0636 71475 to order by Access or Visa  
Mon—Sat/9 am—6pm



# NEW!

from

# Viglen

COMPUTER SUPPLIES

# A PRINTER STAND

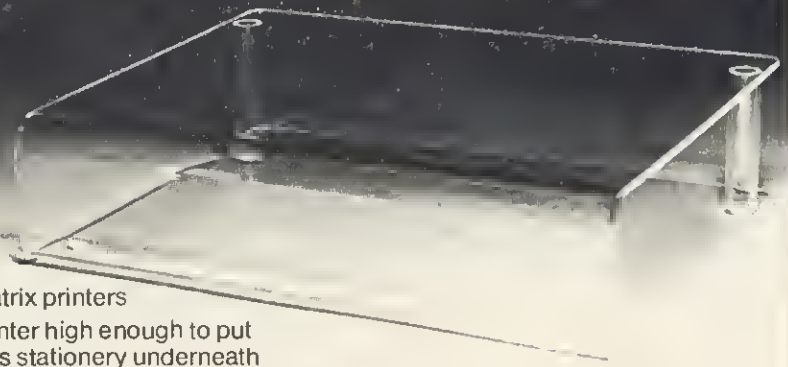

Printer Stand

£12.95 INC. VAT

Carriage & Packing £3.00

- For dot matrix printers
- Raises printer high enough to put continuous stationery underneath
- Beautifully finished in clear perspex • Viglen quality every time
- Will accept paper up to 12½" wide • Non slip rubber pads

Dimensions: 15" (380mm) wide 12½" (320mm) deep 4" (90mm) high

## COME TO VIGLEN FOR A FAST, FRIENDLY, PERSONAL SERVICE

### DEALER ENQUIRIES WELCOME

Post to: VIGLEN COMPUTER SUPPLIES, UNIT 7, TRUMPERS WAY, HANWELL, LONDON W7 2QA.

Please send me \_\_\_\_\_ (qty) PRINTER STANDS at £15.95 each. I enclose Cheque/P.O. for £ \_\_\_\_\_ made out to

VIGLEN COMPUTER SUPPLIES or debit my ACCESS/BARCLAYCARD No. \_\_\_\_\_

Name \_\_\_\_\_   Signature \_\_\_\_\_

Address \_\_\_\_\_

AU11/5

# PHILIPS 14" COLOUR TV/MONITOR

£235 inc VAT

TV/Monitor (resolution better than 585 x 450 pixels. Dot-to-dot distance .65mm)

(TV only: £185 inc VAT)

As a company we chose the Philips because we believe it to have the clearest picture as well as being the best value.

Take our word for it, or come and see for yourself.

**EASY ON-THE-SPOT PARKING. AND IT'S FREE!**

# Viglen

Plus £8 carriage and packing

COMPUTER SUPPLIES

Personal Service & Quality coupled with Wholesale Prices, Unit 7 Trumpers Way, Hanwell, London W7 2QA. Telephone: 01-843 9903

For special attention to your orders or enquiries concerning MONITORS, PRINTERS, COMPUTERS, DISC DRIVES, ring 01-843 9903 NOW or fill in the coupon below.



- Easy to carry • Lightweight • Sparkling picture in seconds • Reliability and performance excellent • Headphone Socket can also be connected to tape recorder • Loudspeaker mute switch • Retractable carrying handle
- Monitor/TV selected by switch • Includes RGB lead connecting direct to your BBC Micro. • Philips Model No. 14CT 2006/05T

Post to VIGLEN COMPUTER SUPPLIES, UNIT 7, TRUMPERS WAY, HANWELL, LONDON W7 2QA.

Please send me \_\_\_\_\_ (qty) Philips TV/Monitor at £243 each. I enclose Cheque/P.O. for £ \_\_\_\_\_ made out to

VIGLEN COMPUTER SUPPLIES or debit my ACCESS/BARCLAYCARD No. \_\_\_\_\_

Name \_\_\_\_\_   Signature \_\_\_\_\_

Address \_\_\_\_\_

AU 11/6

©



# Computer Concepts

## Facilities include:

- Global or selective search/replace.
- Single-key entry, similar to Electron.
- Renumber parts of programs.
- Easy function key load and save.
- Merge programs.
- Compact programs removing REMS, spaces, and creating multi-statement lines.

*"Undoubtedly Caretaker was the most complete program shortener."*

- The Micro User

*"Caretaker is the perfect tool for anyone doing a lot of BASIC programming."*

- Which Micro & Software Review

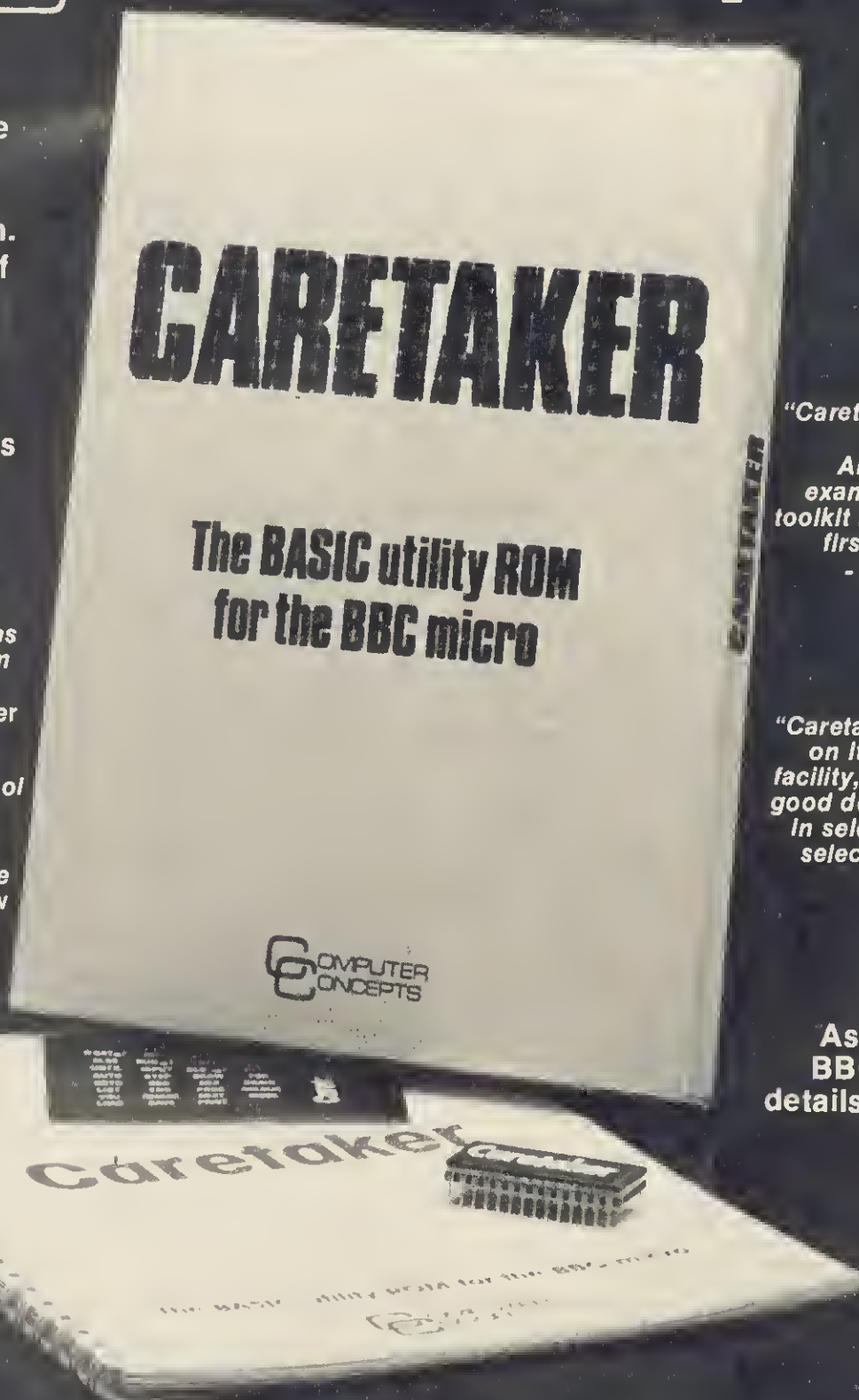

*"Caretaker (Computer Concepts) Another excellent example of a BASIC toolkit ROM, certainly first division stuff!"*

- The Micro User

*"Caretaker also scores on its EXCHANGE facility, which allows a good degree of control in selecting global or selective search and replace."*

- Acorn User

Ask your local BBC dealer for details, or contact us direct.

## Computer Concepts

Gaddesden Place,  
Hemel Hempstead,  
HERTS HP2 6EX  
(0442) 63933  
Mail order/phone orders only.

Supplied with spiral-bound manual and easy fitting instructions

Price  
**£33.35** incl.



# The only ROM



# Cartridge System that does not overload your pocket or your BBC Micro

Why risk damage to your BBC micro every time you want to change ROM's? Instead, store your growing collection of ROM's in professionally-made protective cartridges!

- Insert and remove Wordwise, View, Disc Doctor etc. at will from your micro in absolute safety - no wear or damage to pins to your ROM's.
- Low, low power consumption unlike other systems.
- Saves on memory.
- Price for complete kit including one cartridge only **£19.95 inc. VAT.**
- Extra ROM cartridges £27.75 for five, £49.50 for ten cartridges and single cartridges £6.95 each.

Dealer enquiries welcome.



## Viglen

COMPUTER SUPPLIES

Unit 7 Trumpers Way  
Hanwell W7 2QA  
Tel: (01) 843 9903

Post to: VIGLEN COMPUTER SUPPLIES UNIT 7, TRUMPERS WAY, HANWELL W7 2QA

Telephone: 01-843-9903. Personal Callers Welcome

I enclose Cheque/P.O. for £ \_\_\_\_\_

I prefer to pay ACCESS/BARCLAYCARD (Delete whichever is not applicable)

Card No. \_\_\_\_\_

Signature \_\_\_\_\_

Name \_\_\_\_\_

Address \_\_\_\_\_

Please add £2.00 for postage and packing (50p only for single cartridge)

Kits \_\_\_\_\_

Cartridges \_\_\_\_\_

Credit cards will not be accepted by card holder. Address below must be the same as card holder.

Cheques payable to  
Viglen Computer Supplies

AU 11/77

## A J SOFTWARE for BBC



### 'The Record Changer'

32K £19.95 Cass. £24.95 Disc.

for indexing, membership lists, directories, inventories, budgeting, etc, etc.

don't buy a database in the dark –  
check the spec!

### 'The Wordsmith' 32K for Centronics 737/739

AND NOW FOR EPSON FX80:

£19.95 Cass. £24.95 Disc.

Options Timetable 32K

£14.95 Cass. £19.95 Disc.

Simple Word Processor 32K

£9.95 Cass. £14.95 Disc.

Picture Maths

£9.95 Cass. £12.95 Disc.

An arithmetic practice program for primary schools.

Character Definer £9.95 Cass.

Enlarge, reduce, etc, etc.

Tape Catalogue £5.95 Cass.

Catalogue all your tapes using this program and never lose one again

Copy Disc £9.95

Copy disc to tape, tape to disc, M/C, Data or Basic.

ROM Read

£8.95 Cass. £11.95 Disc.

A machine code program to read the contents of any ROM socket and copy to RAM, tape or disc. Not to be used for illegal copying.

Machine code Disassembler

£5.95 Cass. £7.95 Disc.

Open Evening Timetable 32K

£14.95 Cass. £19.95 Disc.

Utility Eprom £19.95

for basic programmers

Mitsubishi Disc Drives

Dual 80 Track 800K £380 + VAT

Single Track Drives

Dual Sided 200K £199 + VAT

Double Density Disc Interface £85 + VAT

The best there is.

Epson Printers

FX80 £370 + VAT

RX80 £270 + VAT

£8.00 Carr

BBC Epson Cable £15 + VAT

Normende

Not only the cheapest, but the best

Switchable 14" RGB Monitor/Colour TV £250 inc. VAT and cable, £8.00 carr.

Royalties for quality software

All prices VAT inclusive except where shown

AJ Vision Service Ltd, 43 The Drive  
Loughton, Essex IG10 1HB

## THE BBC MICRO SOUND SYSTEM MICROVOC

As supplied to Schools & Colleges

### SYSTEM INCLUDES:

Speakers, Volume control, jack sockets and all connections (assembled).

Buzzgo to eliminate the infernal B.B.C.

Buzz additional £3.00 inclusive

Special offer

Easily fitting with no drilling, soldering or

cabinet modifications £15.00 inc VAT, add £2 p&p

**MICROVOC WITHOUT SPEAKERS**  
£10 inclusive

Microvoc's external socket also allows you to connect directly to your hi-fi system – now you can rattle the windows with Planetoid etc. . .

**MICROVOC IS IDEAL FOR SPEECH SYNTHESIS OR COMPUTER PRODUCED MUSIC**

### MICRO-ADVENT

Ashlyn House, 113 Writtle Road, Chelmsford, Essex.  
Tel: 0245 59708

## an INTRODUCTION to



**R A N D O M**

**A C C E S S**

**F I L I N G**

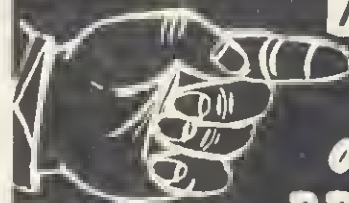

*on the*  
**BBC MICRO**

This 120 page book is supplied with a FREE floppy disc containing TWO demonstration systems - a STOCKFILE SYSTEM and a PERSONNEL SYSTEM

### IF YOU WANT

- to use your disc drives as something more than just fast cassettes.
- to be able to store and retrieve data instantly.
- to learn how to create your own systems.
- to understand how Filing Systems can work.
- to join the vast numbers of people worldwide who have benefited from this package.

**THEN YOU CAN BUY THE BOOK FOR  
£12.50 COMPLETE FROM:**

**The Computer Room 206 Main Street  
Newthorpe Nottingham 0773 718578**



# VIGLEN

gives you the best value

in monitors, printers

& BBC Micros

Please Ring  
01-843 9903  
for LATEST  
PRICES

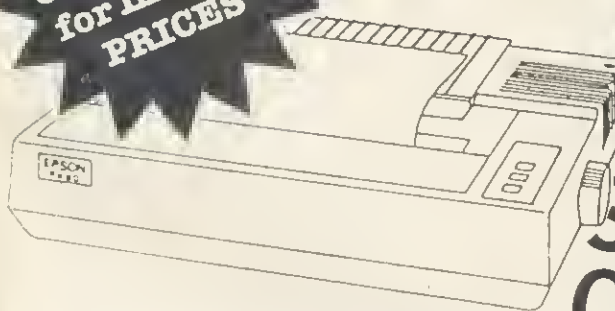

**NEW  
SPECIAL  
OFFERS**

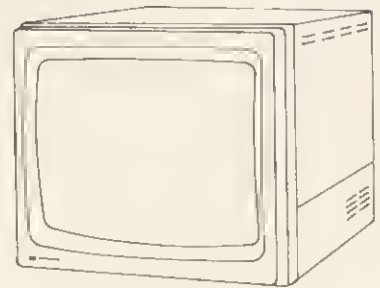

### Dot Matrix Printers

#### Canon PW 1080A - KAGA - TAXAN.

New printer recently reviewed shows near letter quality printing from dot matrix printer. Friction and tractor feeds. 160 cps. Highly recommended.

**Epson RX 80/FT** Brand leader. A reliable well established printer with friction and tractor feeds. 80 cps

**Epson FX 80** The upmarket printer from the Epson range. 160 cps. All other facilities you would expect.

**Shinwa CP 80**

INC VAT	EXCL VAT
£289	£257.30

### Colour Monitors

#### Microvitec standard 1431

#### Microvitec medium 1451

#### Microvitec high 1441

#### Philips 14" TV/monitor (RGB Input)

INC VAT	EXCL VAT
£189	£164.34
£305	£265.20
£442	£384.34
£235	£204.34

### Monochrome Monitors

#### Philips 12" Green V2001

High-resolution

INC VAT	EXCL VAT
£75	£65.27

### Daisywheel Printers

#### Juki 6100

#### SAN PLE 2000

INC VAT	EXCL VAT
£375	£326.09
£229	£199.13

### BBC Micros

#### Model B

#### Model B + DFS

INC VAT	EXCL VAT
£369	£320.87
£459	£399.13

Please add £8 for 1 1/2 metre printer lead for BBC Micro

Please add £8.00 for carriage.  
We also stock other computer peripherals, accessories and complete work processor systems at unbelievable prices. Please call for our latest offers.  
You may also purchase these items direct by calling at our factory/showroom in Hanwell, London.  
Prices correct at time of going to press and offers subject to availability.

AMPLE ON-THE-SPOT CAR PARKING - AND IT'S FREE!  
Post to: VIGLEN COMPUTER SUPPLIES UNIT 7, TRUMPERS WAY, HANWELL W7 2QA

Please send me (state number required)  
I enclose Cheque/P.O. for £  
I prefer to pay ACCESS/BARCLAYCARD (Delete whichever is not applicable)

Card No. \_\_\_\_\_  
Signature \_\_\_\_\_  
Name \_\_\_\_\_  
Address \_\_\_\_\_

Credit cards valid if generated by card holder. Address below must be the same as card holder.

AU11/A

# CLARES NO1 IN UTILITY SOFTWARE!

ENHANCED

**BETA-BASE £25 DISC  
8 GREAT FEATURES**

## WHAT IS A DATABASE?

It is a FILE which contains RECORDS. Records consist of a number of FIELDS containing the information—an analogy can be drawn with a card index in which a box of cards is the file. Each card is a record and each line on the card is a field.

## SPECIFICATION

- 1) Random Access—disc based, single or dual drives
- 2) File Size—99K (40 track), 199K (80 track)—65,000 + records
- 3) Record Size—up to 2048 characters and 200 fields
- 4) Field Size—up to 254 characters with complete line scanning
- 5) Access any record using Primary Key in 2 seconds
- 6) Holds—1200 NAMES AND ADDRESS records on 100K disk
- 7) Search—500 records on 5 fields in 60 seconds
- 8) Sort—500 records on 3 fields in 60 seconds

## SYSTEM FEATURES

- CALCULATE—using any valid expression and store results
- POWERFUL PRINTOUT OPTION—Eliminates need for separate mailing program, Parallel/Serial Printout allows setting of printer control codes, line spacing, tabulation, Headings etc, plus label printing with horizontal and vertical tab control.
- REDEFINE—Titles, field widths, number of fields, number of records etc.
- TRANSFER—Records from one file to another.
- SEARCH LISTS—Allow creation of sub-Databases within main Database.

## NEW\*

- \* GLOBALENTRY enables repetitive data to be typed in once and placed in as many records as required. Can also be used with a search list to provide a powerful global edit/update facility that will save hours of typing.
- \* SPOOLER enables you to create spooled files that are compatible with Wordwise, View and other word processors. You can therefore present your data within a document or in varying formats etc. The spooler program will allow to format your spooled file in the same way as the print out option. You can therefore have headings, columns, titles, numbers etc.
- \* INPUT is a routine included on the disc which will allow you to write utilities for accessing your data and tailored specifically to your needs.
- \* TUBE compatible with the 6502 second processor.
- \* Comprehensive manual and tutorial. All timings and sizes are relative to ACORN DFS. Compatible with ACORN DFS, WATFORD 1.3 and latest AMCOM DFS SERIES B.
- \* ORIGINAL USERS send your disc plus £3 for up grade.

  
MICRO SUPPLIES

**REPLICA II: £12.00.**

**DISC**

The original REPLICA set a very high standard so the specification we set our chief programmer included some impossible features. In fact ACORN state that some of the things that we have done are impossible, it just took us longer that's all. REPLICA II transfers most cassette based programs to disk, even more than REPLICA. When you buy disk drives you do not have to throw away expensive cassette based programs.

REPLICA II transfers 'LOCKED' programs, programs loading as files, programs that load below &EOO, those with up to 6 sections and those up to &6E in length eg adventure programs. No waiting for 6 minutes whilst adventure programs load.

REPLICA II is very easy to use. The user enters a name, how many sections and whether CHAIN\*, RUN\* or \*LOAD to load the first section. Press play and let the program do the rest, even a menu. Think how much it will cost you to buy just 1 disk version of your favourite program—REPLICA II which will hold up to 16 programs, limited only by the disk capacity.

**FX 80 PRINTER DRIVER £12.00**

## PRINTER DRIVER FOR EPSON FX80 AND VIEW

Multi-page driver with print menu allowing the setting of global (document wide) printer functions at printer initialisation. The print menu program contains a sophisticated character generator which allows the construction of 95 user defined characters which are then accessible from VIEW via a highlight option. Supplied on disc with comprehensive user manual.

NEW

**DISCDEX: £15.00 DISC**

- Catalogues all your discs quickly and easily.
  - Room to store four thousand titles.
  - Quick search and load option.
  - Compatible with single or dual drives.
  - Extensive print options for catalogue and disc labels.
  - Update and delete options.
  - Supplied with stick on labels to number your discs and a supply of labels for printing your own disc labels.
- DISCDEX is the answer to a disc users nightmare. How many times have you had to wade through your discs looking for the file that you know is there somewhere? Now with DISCDEX those days are gone. DISCDEX will catalogue all your discs and store them in alphabetic order. In addition to the very useful search and load facility DISCDEX will also print out a full catalogue in alphabetic or disc order. Even more useful is the ability to print disc labels for sticking on the disc or the jacket. DISCDEX is only suitable for discs with 31 file names as in the standard ACORN system. It is not suitable for double density interfaces.

Send for detailed newsletter.  
All prices inclusive of VAT & Carriage—  
NO EXTRAS! Please state 40 or 80 track disc  
Dept. AU11  
98 Middlewich Rd.,  
Northwich, Cheshire CW9 7DA.  
Tel 0606 48511  
Open 9—5pm Monday—Friday

NEW

**ONESHOT: £12.00 DISC**

- Full feature trace utility.
  - Single step through BASIC program or halt at user determined interval.
  - Print line number prior to execution.
  - Obey fixed instructions before executing a line.
  - Trace window allows screen to be seen whilst tracing execution.
  - "Printer only" will force trace output to a printer allowing full screen display.
  - Ability to dynamically alter control of ONESHOT.
  - ONESHOT can be configured to run in any area of memory.
- ONESHOT is a 1.25kb machine code program which gives the user several powerful aids in debugging BASIC programs. These include the ability to SINGLE STEP through the BASIC code of the target program, stopping the processing at specified points and comprehensive trace functions of the variables used by the target program.

A very powerful option allows the user to enter a command string into function key 0 and instruct ONESHOT to obey this command BEFORE each line is executed e.g. \*KEY0 PRINT X%; M will print the value of X% before executing each line. This is a very simple example and it is possible to do much more complex things including printing the value of a variable only when it changes or when it reaches a certain value or falls within a certain range. This option can also be used to dynamically alter ONESHOT as it is working. The power of this option is only limited by the users ingenuity. In addition to ONESHOT the disc also contains 3 very useful function key routines. The first will search for any DEFPROC or DEFFN and print the line numbers in which they appear together with the name of the procedure or function. The second will search for a specific procedure or function and print the line numbers containing it. The third routine will print out every active variable together with its present value. ONESHOT is not compatible with double density interfaces.

NEW

**FUN HOUSE: £10.00 DISC**

FUN HOUSE is a highly original suite of educational programs suitable for ages 3 to 13. The program is designed to encourage children to spell words which relate to objects found around the home. Animation and music are used to good effect and some highly original ideas are incorporated. Each room exercise is terminated with a warning item e.g. the lounge finishes with 'FIRE' which goes on to engulf the whole lounge. Tests with a newly hired 4 year old resulted in us having to prise him away from the keyboard after 2 hours. In that time he had gone from never having used a keyboard to finding the location of all the keys very quickly and entering the correct answer. He had thus started on the path to learning spelling and familiarised himself with the keyboard including the use of DELETE to correct his mistakes. Can you afford not to give your children the same start?

FUN HOUSE is not compatible with double density interfaces.

**All Disc Software now  
available on 3" disc—  
add £3 to printed prices**





Clares

UTILITY SOFTWARE

UK's LOWEST PRINTER PRICES!



# PRINTERLAND



ORDERED TODAY - DELIVERED TOMORROW

FREE manual with every printer explains fully how to interface and pass control codes from your BBC to Epson compatible printers. Includes multi mode screen dumps plus much more.

EPSON RX 80	£189.95
EPSON RX 80 F/T	£219.00
EPSON RX100	£329.00
EPSON FX 80	£317.00
EPSON FX100	£425.00

DOT MATRIX PLUS NEAR-LETTER QUALITY

CANON PW1080A	£249.00
---------------	---------

DAISY-WHEEL

JUKI 6100	£325.00
EPSON DX100	£356.00

ACCESSORIES

WORDWISE	£32.00
PAPER (2000 Sheets)	£12.00
BBC/PRINTER CABLE	£10.95

COPYALL DISK

• Copies ALL protected disks inc. tape to disk utilities.	
• Best on the market	
• Copies from original to your blank disk	£10.25

Educational, G'ment plus O'seas Orders Welcome  
Please add 15% VAT. Delivery Printers £10.00. Paper £3.00. Other 50p  
Printerland, Unit 27, Estate Buildings, Railway St. Huddersfield HD1 1JP

TEL (0484) 514105 Open Mon-Fri 9.15-5pm.  
Open Sat Morn 9.15-12.30pm.

# PRO-SOFT

## 'OFFICE MANAGER'

An entirely new RANGE OF SOFTWARE written especially for the SMALL BUSINESS using a BBC B COMPUTER. It is based on MDDULES which can be used INDEPENDENTLY or INTEGRATED into a full system. The MODULES are, briefly:

1. **CUSTOMER/SUPPLIER DATABASE:** Name, Address, Phone & Contact Fields with ALPHABETIC SORT & FULL PRINTOUT or NAME/ADD only for MAILING.

2. **SALES LEDGER:** INDEXED ENTRY of each CUSTOMER, showing CURRENT BALANCE and full HISTORY of A/C. Prints STATEMENTS with DEBT AGEING, Process, Reconcile, Store & List PAYMENT RECEIVED. Lists SALES.

3. **PURCHASE LEDGER:** Records CASH/CREDIT PURCHASES. Displays items for PAYMENT and recent PAYMENTS to SUPPLIER. Lists all PURCHASES.

4. **V.A.T. RETURNS:** Prints all SALES and PURCHASES within USER SPECIFIED PERIOD. ANALYSES EXPENDITURE into USER DEFINED CATEGORIES (Graphics Option available) Prints copy of COMPLETED V.A.T. RETURN

5. **APPLICATIONS PACK:** SPECIALISED INPUT ROUTINES create TRANSACTION DATABASE from which appropriately formatted INVOICES & CREDIT NOTES can be produced at any time. The system caters for 2 V.A.T. RATES or NO V.A.T. and will support SEVERAL APPLICATIONS DN LINE at one time.

APPLICATION PACKS AVAILABLE NOW: ROAD HAULAGE, SERVICE COs, GENERAL SALES and PLANT & EQUIPMENT HIRE (which includes automatic HIRE UPDATE and COST calculations). Others packs are being prepared but if YOU have a specific requirement please enquire, we may be able to help.

The MODULES are available on either 40/80 SS/DS Discs from £25.00 + V.A.T. and are supplied complete with FULL DOCUMENTATION, CONFIGURATION ROUTINE and UTILITIES to enable PRINTING, AMENDING, DELETING and SEARCHING of FILES.

ALSO AVAILABLE FOR THE TORCH Z80, ACDRN Z80 & 6502 2nd PRD-CESSDRS

SEND FOR FURTHER DETAILS AND SAMPLE PRINTOUTS TO -

**PRO-SOFT, 136 CROSLAND ROAD, OAKES,  
HUDDERSFIELD, WEST YORKSHIRE  
TELEPHONE: 0484 659186**

# MAKE THE MOST OF YOUR COMPUTER.

## INTERFACE PUBLICATIONS

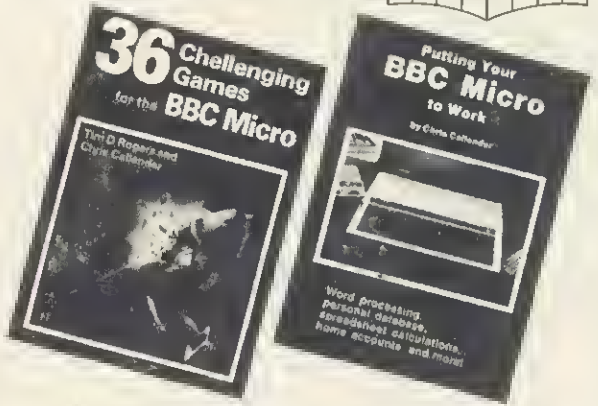
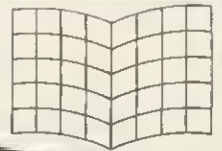

### Acclaimed books from the experts...

- Dynamic Games for your Electron  
Neal Cavalier-Smith. £4.95
- 36 Challenging Games for the BBC Micro  
Chris Callender and Tim Rogers. £5.95
- Let Your BBC Micro Teach You to Program  
Tim Hartnell. £6.45
- Putting Your BBC Micro to Work (includes a full word-processing program, plus 14 others)  
Chris Callender. £4.95
- Creating Adventure Programs on your Computer  
Andrew Nelson. £4.95
- The Easy Way to Program Your New Computer  
Tim Hartnell. £3.95
- Practical Applications for the Microcomputer in the Home.  
David Hole. £4.95
- The Art of Structured Programming  
Peter Juliff. £5.95

These books are available from most book and computer stores. In case of difficulty, order directly from us.

**Interface Publications, Dept. QAU,  
9-11 Kensington High Street, London W8 5NP.**

Please send me the indicated books. I enclose £ \_\_\_\_\_

Name \_\_\_\_\_

Address \_\_\_\_\_

## INTERFACE PUBLICATIONS



**We're the Experts.**

(TRADE ONLY: Interface Publications are distributed exclusively in the UK and Eire by W H S Distributors. Export trade handled by Interface Publications)





# BBC MICRO

## - USER SUPPORT -

LOOK WHAT YOU  
MISSED IN BEEBUG  
VOLUME TWO.

- 10 ISSUES OF BEEBUG MAGAZINE  
MAILED FREE TO MEMBERS
- 30 EXCITING GAMES AND VISUAL PROGRAMS
- 43 SOFTWARE REVIEWS
- 33 HARDWARE REVIEWS
- 16 BOOK REVIEWS
- 150 HINTS AND TIPS
- 25 APPLICATION PROGRAMS
- SERIES OF ARTICLES FOR BEGINNERS
- MANY ADVANCED TECHNICAL ARTICLES
- NEWS AND PRODUCT INFORMATION
- PLUS SPECIAL OFFERS
- BIG DISCOUNTS ON A WIDE RANGE OF PRODUCTS
- EVENTS
- BRAIN TEASERS
- LOCAL CLUBS
- FULL MAGAZINE INDEX

**A YEARS SUBSCRIPTION WOULD HAVE BOUGHT YOU ALL THIS**

*Figures based on the 10 issues of BEEBUG Volume 2.*

**BUT IT'S NOT TOO LATE TO JOIN FOR VOLUME THREE**

BEEBUG PUBLICATIONS LTD. PO BOX 109, HIGH WYCOMBE, BUCKS

PLEASE ENROL ME FOR VOLUME 3  
OF BEEBUG AT £11.90 (10 ISSUES)

NAME .....

ADDRESS .....

AMOUNT ENCLOSED .....

PLEASE MAKE CHEQUES PAYABLE TO  
BEEBUG PUBLICATIONS LTD.

AND SEND TO:- DEPT 13, PO BOX 109

HIGH WYCOMBE, BUCKS.

(DISTRIBUTION AGENTS FOR BEEBUG)

BEEBUG HAS BEEN  
ESTABLISHED FOR TWO  
YEARS AND NOW HAS  
OVER 25,000 MEMBERS. IT  
OFFERS TOTAL USER  
SUPPORT TO ALL BBC  
MICRO USERS.





# WHY LOGO?

is a free 16-page booklet published by LOGO Software Ltd to introduce their new full LOGO for the BBC Micro.

**CONTENTS** ● The history of LOGO ● LOGO's conceptual framework ● LOGO questions and answers ● LOGO in quotes ● LOGO in action ● LOGO from LSL ● LOGO of a glance ● LOGO access

To get your free copy of **Why LOGO?** please fill in the coupon below and send it to: LOGO Software Ltd, FREEPOST, Twickenham, Middlesex TW1 1BR.

Please send me \_\_\_\_\_ copies of **Why LOGO?**. I am interested in LOGO because I am

a teacher  a parent  other (please specify)

NAME \_\_\_\_\_

ADDRESS \_\_\_\_\_

If you have a professional interest in LOGO, please give the name of your Local Education Authority:

## FAST FOURIER TRANSFORM

Fast & accurate machine code implementation for the Model B.

Speed:	256 points:	3 seconds
	1024 points:	11 seconds
	4096 points:	50 seconds

A special compact data format allows 4096 complex data points to be transformed within the standard memory.

Details from: **Structured Software,**  
23 Redcar Drive,  
Eastham, Wirral,  
ROM chip £60 Merseyside. L62 8HE.

## BBC VOLUME CONTROL

At last turn your sound UP/DOWN or OFF with this variable volume control. Fitted discreetly to the back of your Beeb. Easy to fit. Some soldering necessary.

Kit of parts and step by step instructions.

Only £2.80 inc.

**RACEY DESIGNS**  
47 TWYXCROSS RD, BURBAGE  
LEICS LE10 2SF

# HACKERS!

HERE, NOW, AN ADVANCED MODEM ESPECIALLY DESIGNED FOR YOU AND THE BBC MICROCOMPUTER. ONLY THE LOCO SYSTEMS SCM-100 OFFERS ALL THESE ADVANCED FEATURES:

- MULTI STANDARD - V21, V23; BELL 103,202 - gives access to Bulletin boards home and abroad and Prestel
- FULL SOFTWARE CONTROL of all modes plus: orig/ans; line seize; carrier detect etc., using BBC micro user port
- AUTO ANSWER/AUTO DIAL - software monitoring facilities give automatic mode selection on answer
- OPERATING SOFTWARE in ROM gives 12 new O.S. commands for easy control
- COMPATIBLE WITH standard comms software including TERMI etc.
- EXPANSION PORT in modem allows for future developments. These include telephone answering capability using BBC speech synthesiser and tone dialler
- POWERED FROM BBC MICRO - splitter available for use with discs if required
- B.T. APPROVED ISOLATION COMPONENTS - BABT approval applied for
- INCLUDES ALL CONNECTING LEADS

THERE IS ONLY ONE CHOICE

## LOCO SYSTEMS

As this modem represents the latest in technology, BABT approval is still awaited.



LOCO SYSTEMS, PO BOX 9, TWICKENHAM, MIDDXX.  
Please send me \_\_\_\_\_ SCM-100 software controlled modems (at £149.95 each, \_\_\_\_\_ Disc power adaptor (at £5.95 each)

I enclose a cheque/PO order for £ \_\_\_\_\_ made payable to Loco Systems  
Please send me further details (enclose S.A.E.) \_\_\_\_\_

Name \_\_\_\_\_

Address \_\_\_\_\_

please allow 28 days for delivery



**FOR SALE.** Atari 400 16k including Basic, cassette recorder, two joysticks and many games including Air Strike II and Astro-chase (cartridge). Must sell. £135 ono. Tel: Woking 67454 eves.

**GRAPHICS** posters. Set of 10 computer generated graphics posters. Ideal for hi-tech decoration, bedroom, classroom, boardroom, library. Only £8.95. Bill, 12 North Orive, Girvan, Scotland.

**HELLO!** Have you got a lully working Atom joystick interface? Will pay £5 or swap for software (A&F, Aardvark). Write: Philip Arkley, 384 Whalley Road, Clayton-le-Moors, Accrington, Lancashire BB5 5OX.

★**HELP.** Seeking P8271 floppy disc controller chip or complete interface at reasonable cost. Also interested in purchasing disc drives and ROM based software but P8271 priority need. Please contact Steve 0344 425870.

★**HELP.** Wanted: copy of operating manual of Epson printer MX82 made by Casio. At cost plus postage. Send to Mohd Khairi, 9a, Maahad Swissri Street, Zamalek, Cairo, Egypt.

**HOBBIT** floppy tape system for BBC. Leads, manual, ROM plus twelve tapes. £65. Tel: 0531-820865 (Gloucestershire).

**8 INCH** disc units, two off (plus spare) double sided DRI manufacture £225 or will split. 0604-585118 after 6 pm (Northampton).

**JOYSTICK** for BBC B. Voltmace Delta 14/B including 12 page instructions. Self-centering, as good as new. Only £10 (costs £15 new). Telephone (0730) 62934 or write to T. Taylor, 13, Durlford Road, Petersfield, Hants. GU31 4EW.

**JOYSTICK** - Quickshot for sale. Excellent feel, two fire buttons, brand new, in box. Paid £20, will take £10. Chris Wootton, 39 Coundon Road, Coventry CV1 4AR.

**JUKI** single sheet feeder for 6100 printer. New. Instructions. £180 ono. Croydon. Dr Hopkinson 01-777-9241.

**LATEST** Dual Ultradrive by Ikon Computer Products, complete with four boxes of six data certified cassettes. This is the full system costing over £200: bargain at £100. Tel: St. Albans (0727) 59323.

**LOOKING** for someone in the London, Tottenham, area to swap programs and ideas. Age 14. Phone Michael between 5pm-8pm in the week, all day weekend. 800-8128.

**MICRO** Style singled sided 40 track 100k disc drive, £120 ono. Tel: 08444 3301.

**MICROVITEC** 1431 std. res. mint perfect £130. Prism acoustic modem plus Micronet software £40. Grave-send area. Tel: 047483 2862 anytime. E S Tillaney, 6 Flowerhill Way, Istead Rise, Northfleet, Kent.

**MCP40** four colour printer/plotter, Technomatic speech synthesiser, farge selection of software, compatible tape cassette recorder. All good condition. £200 ono. Luton (0582) 574931.

**MICROWARE 200k** double sided 40 track disc drive £170 ono. Tandy 4 pen colour plotter £80 ono. Telephone 0226-83100 evenings and weekends only.

**NASCOM** Imp printer serviced by Lucas micros Feb 84. Screen dump for BBC, service manual, leads etc. for BBC £110 ono. Tel: Don after 6 pm on Thanet (0843) 33398.

**NEW** 6116-LP3 CMOS RAM chips, can be used on computer village ROM/RAM board for BBC micro. 8 chips for £25 or £3.15 each + postage. Also 2764 EPROMs. Phone 01-202-6410 after 6 pm. L. Vekaria.

**8271** New floppy disc, controller interface chip, surplus to requirement. For sale at £50 ono. Tel: 01-204 6894.

**ORIC 1 48k**, little used, some software. £89. P Barton, 11 Princes Gardens, SW7. Please write to arrange viewing. London.

**PACE** 100k 40 trk drive £105. AMS Microdrive 100k 40 trk £115. Double sided cartridges for AMS £2 each (used). Stab power supply £17.50. All perfect, with cables. Reading 582524.

**PACE** double sided disc drive (200k) complete with utilities disc and manual. Still in box. Fast and reliable. £270 new, asking £200. Tel: T Goodfey on Holbeach 380621 after 6 pm or at weekends.

**PACKAGE BBC** model B with fitted View and StarBase ROMs and Cumana 1Mb double d/d, BBC greenscreen monitor, all utilities, manuals and boxed spare discs. Exceptional wordprocessor - database chance. Offers around £1000. 01-852 7616.

**PAIR** of BBC joysticks. Can be used on any game with joystick facility. Great bargain at £12 (needs no interface), ideal Christmas gift. Interested? Telephone Slough 43526.

**PRESTEL** modem (Prism) for BBC B complete with software, cables, power supply and handbook. Price £45 ono, or would exchange for View ROM. Call Mike Matthews, Tel: Gorsley (098982) 326. (Near Ross-on-Wye, Herefordshire).

**PRINTER** Boxed Acorn branded Seikosha AP100A graphics and text printer with cable, spare ribbons, paper, manual. £140. Will throw in software free. Phone Julie, Cuffey 872229, evenings or weekends.

**PRINTER** cable for BBC, brand new, bought by mistake! Telephone: Paul, (0462) 36152 (day).

**PRINTER** \*\*\*\* RO90 Teletype 110 baud RS232 will interface to most micros. Full service manuals provided. £50. Tel: 01-959 1844 evenings.

**PRINTER** Olivetti JP101, Bitstik compatible, £250ish, also Watford ROM/RAM board £10ish, or free with printer, owner upgrades. Will consider interesting hardware/software swaps. Robert Chrismas, Gosport (0705) 526950 or via Prestel Mailbox.

**PRINTER** Seikosha GP100A, centronics interface. Graphics mode allows screen dumps. Variable

width pin feed. Boxed, excellent condition, £145. Tel. Chorley 78286 (Lancs).

**PRISM** acoustic modem, power unit, inter-connecting hardware software for Prestel, Micronet, operating instructions. Phone Sid, 0843 582719.

**PRISM** acoustic modem plus Micronet/Prestel Software £40. Wordwise boxed as new £25. Telephone Romford (Essex) 63407. Available anytime.

**PSU** regulated, 12V, 1.6A, pilot light, cased, includes mains power lead. Short circuit, thermal shut down. £16. R A Lober, 13 Pwll-y-min, Peterston-super-Ely, Cardiff CF5 6LR. Ideal for disc drives.

**22" RGB** Ramtec monitor in veneered & polished console cabinet, with doors, on casters. Mint condition incl. manual, circuit diagram. £150 ono. Parkings, 18 Southill Court, Westmoreland Rd, Bromley, Kent. Tefe: 01-466 6246.

**6502** second processor, 1 month old, excellent condition includes ROMs and manual, hardly used, sell for £175. Telephone SOT (0782) 620657. Ask for Anthony.

**SEIKOSHA** GP250X graphic printer with paper £200. Beginners Assembly Language book and tape £7.50. Tel: Hemel Hempstead 49395 after 5pm.

**SEIKOSHA** GP100A printer in original packaging. Hardly used. £100. Tel: (0933) 679961. (Northants).

**SHUGART** 10 megabyte Winchester drive and a Shugart 8 inch disc drive. Both used with home CP/M system. Bargain at £475 for both or will split. Tel: (0703) 455909 after 6pm.

**48k** Spectrum includes Protek interface and Quickshot joystick also a wide range of games and a C15 cassette and a book on games for the Spectrum £130 ono. Phone Bolton 53700.

**SOLIDISK** 32k sideways RAM, originally purchased 13-6-84, complete with receipt. Unit not compatible with my system, hence sale. Cost £64, accept £50 ono. Telephone Alton 87401

**SPECIAL OFFER** for quick sale. Microware Z6242 dual double sided disc drives 400k, own PSU to avoid overheating computer. Cable for Beeb. Only £275 for immediate cash sale. Phone 01-458 2787 anytime.

**SPEECH** synthesiser, Acorn, boxed, manual, as new. Unwanted gift. £45 ono. Tel: Cottenham (0954) 50739.

**SURESHOT** joystick. Still in box. Will sell for £10. Ring (0423) 872474.

**STACK** lightpen. Cost £28.75, sell for £20 or swap for good quality joystick suitable for BBC B. Scott, Gloucester 770798.

**SUPERIOR** Teletype ASR33 RS232 £50. Unit with two 8" floppy drives £50. Sharp PC1211 pocket computer and cassette interface £30. TRS80 RAM and disc expansion circuit boards (need finishing) £40. 01-451 0520.

**SWAP** Commodore 64, C2N, joysticks, 7 books and software includ-

ing Pole Position etc, worth well over £500, for BBC B, 5 1/4" disc drive and software. Phone Jason on 0790 53161 after 4 pm.

**TANDY** colour printer/plotter. CGP-115, lead, paper, pens, manual, cover, pristine condition £80 ono. G Brown, 01-341-2187.

**TANDY** CGP-115 printer/plotter. Prints in 4 colours, 4 directions, 64 sizes, with paper, pens and dust cover. Excellent condition £100. Phone (07073) 35949.

**TANDY** fine printer VII. Simple dot matrix printer, enlarged type, bit image graphics, tractor feed, serial or parallel. £100 only. Tel: 01-340 2666 or Micronet mailbox 013402666 (Chris).

**TANDY** I. L2 32k + 15A teleprinter + interface, + monitor + recorder + £1000 + software. Over 215 programs. Many games, applications, utilities: Edtasm, Scripsit, Invaders etc + books, manuals, leads etc. Want BBC B DFS hence £575 ono complete. Tel: B'ham (021) 784 2405. Waseem.

**TANTEL** Prestel adaptor cost £180, accept offers around £45. Phone 0379-4892 after 6 pm. Ask for Barry.

**TEACHER WANTED** for O level computer studies. Two children, London and Oxford syllabus. One evening weekly. Wimbledon home with BBC B. 879-1187 after 7.30 pm.

**TEAC** 100k disc drive plus utils disc, manual and 20 discs, £105. Seikosha GP250X graphic printer £200. Acorn-soft Forth and manual £10. Phone Hemel Hempstead 49395.

**TEXAS T166** programmable calculator. 512 steps or 64 memories plus 170 scientific functions. As new, £35. Phone 01 330 1554 (Worcester Pk, London). Collect if possible please.

**TI-99/4A** computer, extended Basic, Parsec, Pilot and manuals. Little used, new condition. Worth £130 (approx), sell for £75 ono. Cassette recorder £8 extra (+ lead). J Bosworth, 27 Lammas Way, Letchworth, Herts. Tef. 77166.

**TORCH** Z80 2SD processor card with free software, £200. Watford ROM board £20. Tandy model-I with VDU, 16K-Lif, £190. 32K expansion interface £150. All as new. Tel: 0761-71675 after 6 pm.

**200k**, 80 track 5 1/4" disc drive wanted. Also Wordwise or View ROM. Mike, 202 Barncroft Way, Havant, Hants PO9 3AN.

**TRS-80** 16k colour extended computer with word processing cartridge £120 ono, or with printer £250. Phone Oxford (0865) 65213.

**UNWANTED PRIZE** - must spend £1800 + VAT on personaf computer. Will buy to your specification and sell to you unused for £1600. Contact 0734 474985 (evenings) for further details.

**TRS-80** model 1, level 2, 16k + editor/assembler + manuals. Offers? Ring Mark on Wakefield 255355.

**UK101** with 8k RAM. Switchable 1/2MHz and 300/600 baud. Cased. No longer required. Offers around £35 please. Ring Graeme on Orpington (0689) 29230 (evenings).



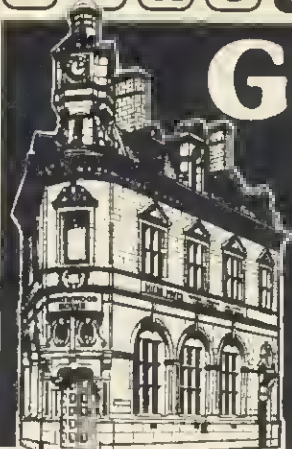

# GET ON THE RIGHT TRACK WITH MICRO POWER



Micro Power are an official service and information centre, and we are major suppliers to Government and educational establishments. We stock the complete range of Acornsoft and Micro Power software as well as a wide range of B.B.C. Micro and general computing books. Our expert staff are always on hand to provide advice and assistance in the relaxed atmosphere of our showroom.

## COMPUTERS

### AUTUMN SPECIALS

- B.B.C. Micro + Cessette Recorder AND Five Micro Power or selected Acornsoft Tapes ..... 399.00
- 8.8.C. Model B plus OFS + 4 tapes ..... 469.00
- B.8.C. Model 8 plus Econet + 4 tapes ..... 446.00
- 8.B.C. Model B plus DFS end Econet ..... 516.00
- Acorn Electron + Cessette Recorder OR Five Micro Power Tapes ..... 199.00

## MONITORS

- Kege 12" Green Screen ..... 123.05
- Ferguson TX Monitor/TV ..... 264.50
- Senyo DM2112 12" Green Screen ..... 74.95
- Microvitec 14" RGB/PAL end audio output ..... 258.75
- Microvitec monitor (plastic) ..... 228.85
- Microvitec monitor (metal) ..... 228.85
- Microvitec medium resolution monitor ..... 299.00

## DISK DRIVES

- Pace 40 track 100K ..... 156.40
- Pace 40 track double sided 200K ..... 220.80
- Pace 40/B0 track double sided 200/400K ..... 241.50
- Pace 40 track dual drive 200K ..... 310.50
- Pace 40 track double sided dual drive 400K ..... 434.70
- Mitsubishi 40/80 track double sided dual drive 400/800K ..... 567.85
- Torch Z80 Disk Pack B0 track double sided dual drive (including Perfect software) ..... 803.85
- AMS HFD 3055 3" 100K ..... 169.00

ALL PRICES INCLUSIVE OF V.A.T.  
We provide free fitting for all firmware.  
ALL ROADS LEAD TO MICRO POWER!

## PRINTERS

- Epson FX80 ..... 416.40
- Epson RX80 F/T ..... 268.90
- Juki 6100 Deisywheel ..... 415.00
- Smith Corona TP-I deisywheel ..... 270.20
- Cannon PW1080 ..... 332.58

## ACCESSORIES

- Acorn 8.B.C. cassette recorder (inc. leads) ..... 35.00
- Morwood 8.8.C. cessette recorder (inc. leads) 29.95
- Sureshot self-centering ercede joystick ..... 18.22
- Micro Power potentiometer joystick ..... 12.95
- Acorn Oisk Interface ..... 115.00
- Pace Modem ..... 136.85
- Commstar ROM ..... 34.00
- 1.2 ROM upgrede ..... 11.50
- Speech synthesiser plus certridge socket (Free 1.2 ROM if required) ..... 55.00
- View wordprocessor ROM ..... 59.80
- Wordwise wordprocessor ROM ..... 45.42
- Quickshot II Joystick ..... 12.95
- Electron Plus 1 printer/joystick interface ..... 59.90
- First Byte Electron joystick interfece (including cessette) ..... 24.95
- ATPL sideways RAM board ..... 45.00
- Teletext edepter (Free 1.2 ROM if req.) ..... 225.00
- Softlight EPROM progremmer ..... 75.90
- Printer cables (perellel or serial) ..... 15.50
- 3M unlabelled disks (ten) ..... 15.00
- Scotch O/S O/O disks (8ox of ten) ..... 32.50
- Maxell 3" disk ..... 4.95
- Oisk storage case ..... 19.95
- Vinyl dust cover for computers, disk drives, monitors end printers ..... 4.50
- Steck light pen ..... 28.75
- Tutor Mete Monitor stands ..... 10.50
- Wide selection of computer leads end printer ribbons in stock.

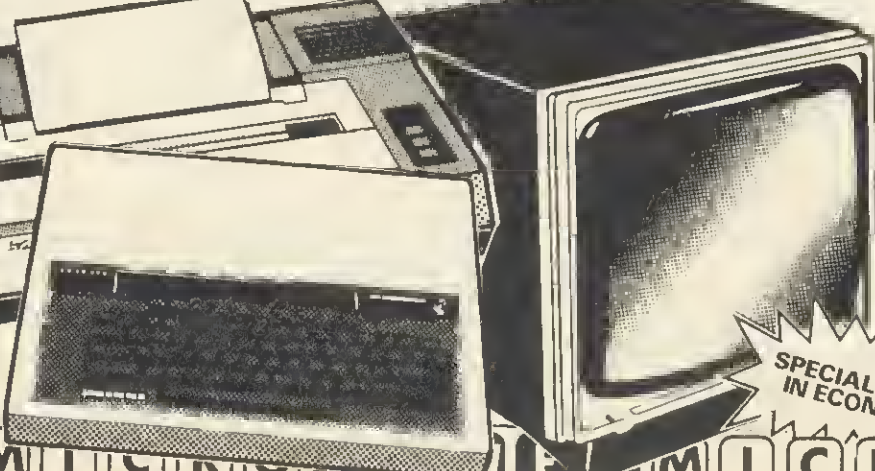

\*HP facilities available. Please contact us for further details.  
\*Free parking. All prices correct at time of going to press.

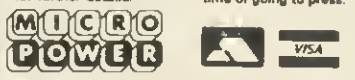

Showroom: MICRO POWER LTD., Northwood House, North Street, Leeds LS7 2AA; Tel: (0532) 458800  
Mail Order: MICRO POWER LTD., DEPT. MU11, Sheepscar House, Sheepscar Street South, Leeds LS7 1AD; Tel: (0532) 434006

Send an SAE for our complete listing of hardware, software and books.

**CARRIAGE FREE for ALL hardware**  
Books and software only 55p per order U.K. Mainland Only

SPECIALISTS IN ECONET



**TANOY** colour graphics plotter, as new, with BBC cable, £80 ono. RH Electronics lightpen (unused), £25 ono. Write to Mus, 31 Longfield, Harlow, Essex CM18 6JZ or phone Ali on 01-881 7046 during the evening.

**WANTEO:** Atom accessories. Wordpack ROM, extra RAM, joysticks, Toolkit ROMs, games, etc. Everything of interest. Send details to Anders Reuterswärd, Bagatorpsringen 58, S-171 65 SOLNA, Sweden.

**BBC B**, disc interlace, 1.20S, joysticks and over £200 software and cassette recorder and all leads and books, magazines. All in perfect condition, must sell. £315. Sensible offers considered. Tel: 01-898 2644 evenings, 01-600 1200 Ext. 3274 day.

**TORCH Z80** second processor with utilities 1.4 and 1.5, perfect writer speller calc and liler and BBC Z80 Basic with manuals £250 ono. Tel: Walton (0932) 245593 after 8 pm or weekends.

**BBC model B** with Acorn DFS, £350. Canon 100k disc drive, £110 (with lead and own power supply). Tel: 01-659 1303 (alter 7 pm).

**LIGHTPEN** by RH Electronics. Perfect condition, little used, cost £45. Best offer over £20 within ten days of publication. Tel: David, 0752 775654 (between 5 pm and 9 pm only please).

**PRINTER** Tandy line printer VII. Good condition, including BBC cable and print utilities (disc or cassette). Plus 200 sheets paper and manual, £120. Tel: 04352 6167.

**PRINTER** Star DS10 with manual, paper controller, paper roller, friction and sprocket feed, £150. Modem, including cables, separate power supply, 1/2 full duplex, self-test, £70. Modem lor Prestel etc, £30. Amersham 21702.

**MAGAZINES** galore. Weekly and monthly covering the last 7 months. Interested? Contact: John Humphreys, 33 Ringsbury Close, Purton, Swindon, Wiltshire. Will sell for around 10p to 30p each.

**RGB** medium resolution monitor and BBC B lead, £125. Tandy CGP115 plotter and BBC B parallel lead, £89. Voltmace joystick and keyboard adaptor box, £18. Tel: Martin (0280) 816475.

**BBC B**, 1.20S, joysticks, programs, tape deck, dust cover, games. No offers. N A Malik, tel: 0224 323276. 12 games free. £385. 2 months old, guaranteed lor 12 months.

**KENOA** professional DMFS, single or double density, unerase erased files, users manual, three months old, perfect, utilities disc, fitting available. Can be seen working. £80. Tel: Ash Green (0474) 873186.

**FOR SALE.** Books: Easy Programming and Further Programming for the BBC Micro and 30 Hour Basic. Cost £5.95 each new. Sell for £3.95 each or £11 lor all three inclusive. Tel: 0288 4682.

**VOLTMACE** Delta B handset and adaptor box plus Delta driver cassette, used once. Cost £36, will accept £25 ono. Buyer to pay postage. Tel: John on Marshalls Cross 819453, Merseyside.

**BBC B**, View, Epson MX80 F/T III, Zenith monitor, offers. Tel: Hugh, 0865 711829 daytime, 0235 23523 evenings.

**ELECTRON** plus cash and £80 worth of software in exchange for BBC model B. Tel: 01-952 6491 (Edgware).

**13-ROM** expansion board lor BBC model B, SIR Computers mark one (fully buffered). Never fitted, still in original packing with full instructions. Cost £41, offered at £30. Tel: 01-211 4184 (daytime).

**WATFORO** DFS with manual, £75. Tel: Oakley (02302) 4579 evenings.

**SHURE SHOT** joystick lor sale. Hardly used, unwanted gift. Sell-centering, two fire buttons, arcade quality. Worth £18.22. Send cheque for only £9.50 to Mark de Wegee, Rippeedaboeg 4, 9502 XL Stadshanciaal, Holland.

**FOR SALE.** CT-403 keyboard. Choice of 24 instruments, 16 rhythms. Ideal lor beginner. Worth £250, bargain at £175. Will exchange lor Electron. Tel: Bourton (Dorset) 840449.

**FOR SALE.** Acorn Magazines from two years back, 80p each. 224 Feltham Road, Ashford, Middlesex. Tel: 47679.

**WANTEO** AB Graphics Design. For sale: Watford ROM board, £25; DMP 100 printer, £135; LVL DD board, £80. Tel: (0225) 27066 evenings.

**ATOM** 12k+12k, FP ROM, programmers toolbox, colour board, PSU, all leads, manual, books, software. Tel: St. Albans 64975. Sell lor £100.

**BRANO NEW** Micro Decision magazines for sale at 90p each (Inc p&p). Costs £1.20 normally. An excellent business micro magazine which comes through the post: I didn't order it! Editions July '84+. Tony, 46 Chalcot Crescent, London NW1. (01) 586 9341.

**FOR SALE.** Tandy CGP115 four colour printer/plotter, centronics/serial interlace, £90 ono. Acorn S/S S/D 100k disc drive plus formatting disc etc, £100. Sgt Boyd, RAF Gatow, BFPO 45.

**JUPITER** Ace wanted. Anyone sick of Forth? Reasonable offers made. Tel: Malcolm on 01-505 2955.

**DISC ORIVE**, double sided 40 track with Acorn DFS kit. Comes complete with manuals and fitting instructions plus a utility disc. Still under guarantee, £198. Tel: 01-202 6410 alter 6 pm. L. Vekaria.

**PRINTER** Texas 8 1/2 inch thermal, Centronics/BBC lead, circuit diagrams. Print head faulty. Suggest modify or break lor parts (including stepper motors). Offers? £5 paper rolls (new) - £3. Tel: Mike on 0981 250764.

**FOR SALE:** Vol 1 - Fundamental Algorithms and Vol 2 - Sorting & Searching by Donald Knuth. Cost £11.95 and £21.95 new, 2 weeks old, too mathematical for me, hence £25 including postage. Tel: 0288 4682 and ask for Jonathan.

**ATOM** software wanted. Super-Racetrack and Micromania Delender. Anything considered. Send list, details and price to Martin, 11 Courtfield Rd, Ashford, Middx TW15 1JN.

**COMMODORE** Vic-20 for sale. 16k RAM, joystick, C2N tape recorder, £90 worth of games, books, dust cover. Excellent condition, original boxes. All worth over £250 - selling for £150. Tel: Medway 364009.

**SIR ROM/RAM** expansion board. Unused, full litting instructions. Currently advertised lor £55, yours for only £40. Tel: Huntingdon (0480) 50117 after 6.30 pm or weekends.

**ACORN USER** back issues wanted for informative reading, in Aberdeen area. Up to issue 25 needed. Please phone (0224) 877798 alter 6 pm if you can help. Niall Saunders BSc.

**DISC** drive (100k) including disc interface £150. UDM double density disc interface £80. Ask for John on 0923 775583.

**ATARI** VCS as new, complete with joysticks and paddles and two games, £55 ono. Tel: 0795 874869 alter 6 pm.

**TELETEXT** adaptor for BBC micro, £150. Ian Coulson, 26 Westmorland Rd, Felixstowe, Suffolk IP11 9TS. Tel: Felixstowe 272452.

**BBC B** 1.20S, Acorn DFS, Wordwise, software and books worth £100, all for £399. 400k double sided 40/80 disc drive £175. Mannesmann Tally printer £200. Drive and printer guaranteed. Tel: Leeds (0532) 732113.

**WANTEO** Information on RTTY. Also does anyone listen to Armed Forces Radio and TV service? If so, what receiver are you using? Write to G. Hart, 92 Carfield, Skelmersdale, Lancs WN8 9DN.

**ACORN** JP101 parallel printer lor BBC B. Brand new duplicated gift, £170 ono. Includes manual, lead, paper, graphics dump tape. Tel: Ruislip 73671 (Middlesex) after 6 pm or weekends.

**FOR SALE** ZX81 plus 16k RAM. Including games and books £40 ono. Tel: Marton Heath 411 (after 6).

**ATOM** disc pack contains disc drive, power supply, disc interlace etc. With manual, connecting ribbon, cable & utilities disc. £150. Tel: Maldon (Essex) (0621) 56137, (Roy Burgin), evenings and weekends.

**WANTEO** - Epson printer, RX80FT or FX. Must be perfect lor use with BBC. Up to £150 cash waiting. Tel: Cardliff 615595.

**ELECTRON**, three months old, £60 worth of software and books, £170. Tel: 0953 454902 or write to 3 Dairy Farm Court, Attleborough, Norfolk NR17 2BT.

**CASIO** FX-502P programmable calculator and FA1 music and cassette I/O interface, manuals & tape. Sell lor £45. Casio FX-700P pocket computer, qwerty keyboard, 1.5k, sell for £40. Tel: (061) 624 5284 alter 5.30 pm.

**TANDY** CGP115 colour printer/plotter, together with spare pens, paper and BBC parallel lead. Bargain at only £85 ono. Tel: 0242 37954.

**SEIKOSHA** GP100A dot matrix printer with centronics interface to suit most computers. Ten months old, £120. Tel: Morecambe (0524) 411780 after 6 pm and ask lor Vincent.

**DISC** drive, double sided SD/DD, 35 track with leads and manuals, software included, utilities, in good working order, £75. Tel: Nottingham 53312. 99 Kenrick Rd, Mapperley, Nottingham.

**ATOM**. New user club £6 membership. 4/6 newsletters annually. Original software wanted for use in above. Send tape, listing & SAE. Money for best. Martin, 11 Courtfield Road, Ashford, Middx TW15 1JN.

**EPSON** RX800 lor sale, box and manual, £200. Tel: Geoff Spring, 0494 783071.

**HELP!** Anyone know how to connect an Electron to a VCR (via-video in-socket) in order to record colour graphics? B & W is boring! John Heavyside, 66 Farley Way, Reddish, Stockport SK5 6JD. Tel: (061) 431 4169.

**PRINTER** Star DP510 + BBC cable. Original packaging, still under guarantee, 2.4k buller roll, tractor, friction feed, Epson compatible. Cost £300 + new, bargain at £215. 100 CPS 80 cols. Tel: Mike, Abingdon (0235) 25480 evenings.

**BBC B**, latest OS, DFS, 100k Vlgten drive, discs, Wordwise fitted, leads, manuals. Plus Doscolt 727 and Which? Taxcalc. Six months old, boxed, £499. Manning, 105 Station Road, March, Cambs. Tel: 55284.

# MUSICSOFT

MUSIC SPECIALISTS FOR THE 32K BBC MICRO

## ★ THE SYNTH ★ (O.S. 1.0+)

"A very flexible and inventive program that's highly recommendable." (Dr David Ellis, E&MM, Oct 83). This synthesizer program has features which to our knowledge are unique. ALTER RHYTHM. The rhythm of a recorded melody may be altered by tapping on a single key. REPEAT. No need to play a phrase twice, great saving in space. REAL TIME PLAYING. With alteration of volume, envelope and octave pitch as you play a note. EDITING. Back and forwards whilst hearing the tune. INPUT. May be hesitant or in correct time. TDDY. "Cleans up" inaccuracies of input on demand! NUMBER OF NOTES. From 3000 for 1 channel to 1000 for 3, etc. Plus all the other synthesizer programs do PLUS. IE sophisticated envelope editing (very easy), larger keyboard used (TAB to ↓ cursor). No secrets, user transparent. This is the program for the experimenter who wants to make HUMAN music rather than perform mathematical finger dexterity exercises. THE SYNTH. Cassette & instructions only £8.75 inc. P&P.

## ★ KEYBOARDS ★ (O.S. 1.0+)

5 programs to turn your BBC into 5 real-time keyboards. 1.3 simultaneous voices (in Basic for easy understanding) 2. Single voice M/C with Pitch Bend. 3.3 simultaneous voice M/C with Envelope control built in. 4. Single finger Chord organ ranging over the whole keyboard, 2 variations for each chord. 5. Chord organ 2 with different chord configuration. These are all separate programs designed for you to use as they are or in your own programs. KEYBOARDS cassette & instructions £5.75 inc P&P

## ★ MUSICTOOLS ★ (all O.S.)

"Music soft also produce an excellent 'Musictools 1' cassette ... all in all, rather good value" (E&MM, Oct 83). Five music utility programs on one tape. Tune Generator with dynamic graphic Keyboard & Stave display. Envelope Command Explorer (Very easy to use). Musical Symbols Graphic routine. Simple single line organ with sophisticated controls. Over 60 procedures for you to use in your programs already in working programs. MUSICTOOLS 1 cassette & instructions £5.75 inc. P&P.

## ★ PIEMAN ★ (all O.S.)

"The best version of Simon Pie seen, it goes in much further than most" (Quote by a vivid software firm). Recommended for Primary & Middle Schools. Not as simple as Simon! It develops into a fun set of car cleaning and musical concentration games. PIEMAN cassette & instructions £5.75 inc. P&P

ALL PROGRAMS TRANSFER EASILY TO DISC.  
Cheques and official orders to:  
MUSICSOFT, Dept N, 12 Fallowfield, Amptill, Beds.  
Telephone: 0525 402701

All 4 programs on 40 track disk - £26.00

ACORN  
APPROVED

## EPROM PROGRAMMER

FOR THE BBC

A very high quality product direct from the manufacturers, contained in attractive sloping box with low insertion force socket and neon indicator for programming fitted as standard, the software adopts the high efficiency method for programming 2764 and 27128. This allows up to 100% faster programming, software in machine code, supplied on cassette and can be placed in eprom. Very easy to use, menu driven with easy to use instructions. This unit is completely self contained with its own power supply and plugs into the user port.

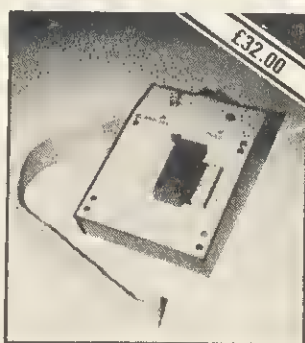

### THIS PROFESSIONAL UNIT ALLOWS:

1. Will program: 2716, 2732, 2532, 2764 and 27128 eproms.
2. Copy eprom into memory and compute checksum.
3. Blank check eprom.
4. Program eprom from memory.
5. Verify byte by byte and compute checksum.
6. allow buffer start area to be changed.
7. All operating system calls may be used when in menu mode.
8. Semi-intelligent programming. Typical time to program a 2764 8k device is approx. 50 sec. depending on the data to be programmed.
9. Additional software supplied to enable your own program (basic or machine code) to be put into eprom with the necessary leader information to allow calling with a \*command. Downshift routine to enable basic programs to be run is also supplied.

COST £32.00 please add 15% VAT £1.00 post and packing

ALSO AVAILABLE RAM/ROM CARD  
(Details on Request)

### ORDERS TO:

H.C.R. ELECTRONICS, Industrial Unit,  
Parker Road, Chelmsford, Essex CM2 0ES  
24 Hour Answer Phone Service:  
Chelmsford (0245) 350188



ELECTRONIC  
SERVICES

**FREE**  
with "Your Team"  
a Bobby Charlton  
Leather Match Ball  
worth £6.99

## A must for all soccer enthusiasts

Yes, absolutely free for a limited period, with every copy of the program "Your Team" a real leather Match Ball autographed by Bobby Charlton (R.R.P. £6.99). "Your Team" is a database program to record and analyse your favourite team's match results, scores, attendances, statistics etc. All recorded in your club's colours. Football league, Scottish league or your own team school or club can be kept season after season.

Available for Spectrum, BBC, Electron, CBM  
64 - £9.95 plus £1.00 P&P.

Order today enclosing cheques/P.O. Access/  
Visa to:

Bec Sports, Dept AU, Bec House, Highlands  
Ave, Northampton.

Tel: 0604 499 246

## BBC POOLS PREDICTOR

### WITH 11,000 MATCH DATABASE

Now in its 3rd successful season, Mayday Software's Pools Predictor has been made even more powerful with a new and unique 11,000 match database. Seven separate forecasting techniques have been combined to give you the best forecasts yet. And, just as easy to use, is our new Racing Analyser. This uses the racecard from your daily paper to analyse any horse race—and it's yours for no extra charge!

..... Also available for the Spectrum.....

MAYDAY  
SOFTWARE

181, PDRTLAND CRESCENT  
STANMORE, MIDDX HA7 1LR

## FREE RACING ANALYSER

BOTH PROGRAMS  
FOR ONLY

£8.99

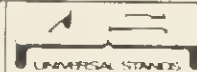

## UNIVERSAL STANDS

43 Pearce Avenue, Parkstone, Poole,  
Dorset BH14 8EG. Telephone: (0202) 740147

- SPACE SAVING VDU /MONITOR STAND ●  
Suitable for BBC  
and most other microcomputers
- Deluxe version with Duraplug 4-way connector, mounted on back, 2 metre cable and plug £25
- Dimensions: 48cm (wd) x 36cm (d)

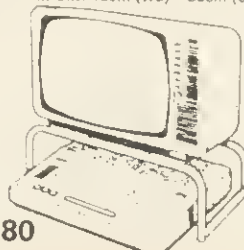

£15.80

- FREE STANDING PRINTER STAND ●

Accepts any 80 character printer. Equally at home on desk or wall

- Dimensions: 40cm (wd) x 40cm (d) x 24cm (h)



£19.95



■ **Advanced User Guide** binders. Stiff plastic backed, titled, open flat, ring binders. £3.50 inc. p&p. Hepworth & Co, Waulkmill Farm, Ingersley Vale, Bollington, Cheshire SK10 5BP.

■ **Bargain software** BBC/Electron. Minimum 15% discount, up to 50% discount! Special offers only best titles. SAE to Coastal Software, 17 Pembroke Gardens, Holland-on-Sea, Essex.

■ **Bargain software:** Overdrive, Battletank, Alpha Centauri, Pengwyn, £5.50 each. Aviator £10. Replica versions 1+2, £8 each. Genuine originals, private sale. Tel: (051) 336-2812 (6pm+)

■ **BBC B Viglen's DFS** £385. BBC B Acorn DFS £365. Epson MX-100 F/T £245. Zenith 12" green screen £55. Disc drive 5 1/4" D/S 40-track (uncased) £65. Watford (0923) 33118.

■ **BBC/Electron 'Image'** - ultimate tape back-up copier. Copes with locks, files, 300+ 1200 baud, ?'s in filename, false addresses, any length. Locks/unlocks programs. 100% m/c. £3.80. P. Donn, 33 Little Gaynes Lane, Upminster, Essex RM14 2JR.

■ **BBC/Electron library**, £5 membership fee. Tapes £1+23p p&p. Large selection. Stamp for details to: E. Tucker, 58 Blenheim Walk, Corby, Northants.

■ **BBC keypad**. Speed up data entry with 25-key add-on. Eliminates Shift for + \* = etc. SAE for details. Extron, 16 Priory Park, Bradford on Avon, Wiltshire BA15 1OU.

■ **BBC micros inoperable** without your password. Embedded, encrypted IC, reveals proof of ownership on request. OS1.00 onwards. Send name, address, password, 12 characters max. £18. M. Gillett, 135 Honey Lane, Waltham Abbey, Essex.

■ **Beam design** to BS.449 (steel) and CP.112 (timber) for architects, engineers, builders. Cassette £40, disc £45. SAE to Beamscan, 20 Vaughan Avenue, Hendon, London NW4 4HU.

■ **Coordinates I and II**. Colourful, interactive software packages for BBC B. Pupil performance monitored. £3.95 each cassette, both £7. Cheques to Micromedia Supplies, Freepost, Roydon, Diss, Norfolk IP22 3BR.

■ **Compact BBC disc drives**. Group purchasing dual D/D 5 1/4" 40/80 guarantee. VAT, carriage included. Unboxed: S/S £262.50,

D/S £320. Boxed: S/S £286.65, D/S £351.05 including utility disc, manual, + power, £30. Baldock 895405.

■ **Cross assemble** and disassemble 6805 microprocessor code on the BBC micro. In EPROM £20, on disc or tape for sideways RAM £16. SAE for full details. N. Jenkinson, Brosscroft, Hadfield, Via Hyde, Cheshire SK14 7HE. Tel: Glossop 66207.

■ **Daisywheel** printer, new, boxed, £230 including dust cover and Centronics cable. Tel: 01-836 0589 business hours, (09326) 5239 weekends. Ask for Mr Martin.

■ **Database**. Most Beeb users are neither tyros nor experts - in-betweeners use our DIY database kit, £5. Soft Options, 6 Remigius Grove, Glebe Park, Lincoln.

■ **Discount BBC and Electron software**. Unique sell-back option. All new original programs. S. O. Software, 13 Edge Avenue, Grimsby, S Humbs DN33 2DD. Tel: (0472) 751444.

■ **Discounts** on computers and peripherals, most makes, large and small, hardware only. Some used equipment bought and sold. Tel: Ascot 26875 or Crawley 883853.

■ **Disc Menu** for single or double sided drives. User friendly menu auto-updated when files added or deleted. Disc title easily altered. 61 files per disc. Sorts alphabetically. Up/down scroll feature. Single key run. £10 payable: E. F. Cavanagh, 14 South View, Woodley, Stockport SK6 1PD. Tel: (061) 494-2253.

■ **Floppy discs** 5 1/4" & 8". Maxell, Fuji & Dyson at very competitive prices. Also Maxell 3" discs at £4 each including VAT. Ring 460-0934 (evenings), Kevin or Ian.

■ **Frustrated?** Christmas Disc Logger will read your directories, sort, search and print a catalogue. Indispensable! Cheques £6 to Bacsoft, 81 Village Road, Gosport, Hants. PO12 2LE.

■ **Geology**. Hand specimen identification. 'Igneous', 'Sediment', 'Identimin' - three programs of A-level standard, BBC B. £8 each cassette or details from Micro Prof, 68 Ferndown Road, Solihull B91 2BA.

■ **'How-to'** move software from tape to disc. Utilities + extensive text, hints, tools. Recommended to frustrated disc owners! £5. R-Soft, 22 Marriotts Close, Felmersham MK43 7HD, Beds. Tel: (0234) 781730.

■ **Joysticks** - top quality at amazing low price. Only £10.95 a pair. Easier to handle and faster than others costing twice as much. Cheque/PO to Peritron, 21 Woodhouse Road, London N12 9EN.

■ **Juki G100** daisywheel printers. New/guaranteed, £369 including VAT. Free delivery in UK. Also disc drives from £95 delivered. Woking (04862) 62020, anytime.

■ **Key-joystick** converter, converts 99% of software to joystick control, inkey (-n) or otherwise. Program only £3. N. Nock, Cwm Ifor House, Bowls Lane, Caerphilly, Mid Glamorgan CF8 2TW.

■ **Micro Arts** - new independent computer art magazine and software. Issue One: micro music/language as virus/electronic Beowulf/film/video/more. 90p including postage. Software: BBC model B graphics (6 programs) by Martin Rootes - £3. Spectrum software also available. Micro Arts (A), PO Box 587, London SW4 9PH.

■ **Money**, money, money. Proven programs for all horse racing or football pools forecasting. Send £12 to The Butronics Co, Penterrick House, Budock, Falmouth, Cornwall.

■ **Open University** 'Microprocessor and product design' course. Includes 8085 development computer plus interface hardware. Excellent course in all respects. £265 ono. Tel: (06517) 2483.

■ **Perfect condition**. Torch Z80-pack plus BBC micro. 2x400k disc drive, Z80 second processor. 64k RAM. Perfect software packages. CIS-COBOL (over £400). All for £990. Helen, 01-584 7580.

■ **Printwise** adds power to Wordwise/Epson. Simple commands replace messy control codes. Also Greek (FX only), macros, autonumbering! £12.50 (disc) or SAE for details. Astrosoft, 39 Latimer Way, North Pickenham, PE37 8JY.

■ **Random access mailing list** for BBC micro. Holds up to 300 addresses. 40 track disc £12 from D. S. Buckley, 46a Pinner Road, Harrow, Middx HA1 4HZ.

■ **Sideways** ROM extension cartridge system. Includes easy change cartridge to protect ROM. Located on LHS of keyboard. £17.95 inclusive, (extra cartridges £4 each). SAE for details. Steelappel, 3 Hambleton Close, Blandford, Dorset. Tel: (0258) 53742 anytime.

■ **Timetabling**. T-squared, friendly sophisticated disc formatting and analysis. £25. Money-back guarantee. Yorke House Software, 33 West Street, Oundle, Peterborough PE8 4EJ. Tel: (0832) 72362.

■ **V.F.M!** Egg - The Upgrade enhances 'Chuckie Egg' - includes 8 new boards - joysticks, £3.50. Efficient machine-code dis-assembler £3.50. Edit 7 - full-feature, 10 page text/graphics editor £5. SAE for details. Value for money from Crystalsoft, Dower Cottage, Goldhill East, Chalfont St Peter, Bucks SL9 9DL.

## £10 SMALL AD SERVICE

**Please include your cheque for £10 made payable to Redwood Publishing. This is the standard fee. Don't forget your name, address or phone number. Send cheque plus form to Acorn User Small Ads, 68 Long Acre, London WC2E 9JH.**



# HIGH TECH- HIGH RISK!

Protect and secure your valuable equipment.

Tidybase Housings, Covers, Locking Systems for Computers, Disc Drives, Monitors, Printers, Video Recorders etc.

Features include unique new Locking System (patents pending) with optional alarm back-up giving protection without restricting normal operation.

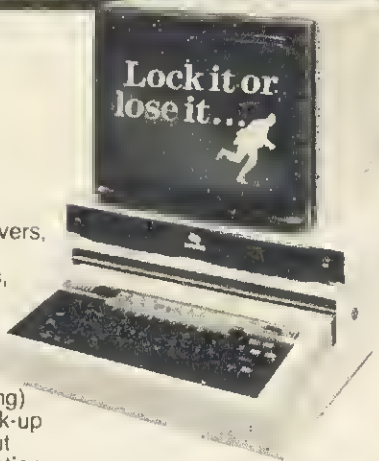
Standard specialised systems available.



Range includes Turntables and computer based Work Stations for the handicapped.



Find out more from... **remedian** INSTRUMENTS LIMITED  
3 Over Links Drive, Poole, Dorset BH14 9OU.  
Tel: (0202) 708404. Telex: 418297

## BBC MICRO REPAIRS by MICROFIX

ACORN AUTHORISED SERVICE CENTRE

"Cumana Disc Drive and Acorn DFS supplied and fitted at low prices"

We will repair your faulty BBC micro, disc drive or monitor quickly and at a reasonable charge. Most repairs cost between £10 and £20.

We can also offer extended warranties on all your equipment.

Send S.A.E. for full price list.

Phone 01-968 9214  
or call in at

191 Freston Road,  
(Latimer Road Tube)  
London W10

and ask for  
Mark Duffill or Derek Mullings.



HIGHLIGHT SOFTWARE,  
36, Sherbourne Close, Barry, S. Glam, CF6 5AQ.  
Telephone: (0446) 745482

"If I say there is an arcade flavour about them that's not meant in a derogatory sense, rather that they are the sort of games that will immediately appeal to children, and the graphics are superb!...."

A & B COMPUTING.

### B.B.C. + ELECTRON

Reading Pack 1. Age 5-8

**SPLASHDOWN**

Building 3 letter words

**FIREFIGHT**

sl-,sm-,sn-,sp-,bl- etc.

Reading Pack 2. Age 6-9

**PYRAMIDS**

th-,ch-,sh-,wh-

**SPLASH**

oo-,ee-,ea-,oi-,ou-,oa-,ai-

Reading Pack 3. Age 7-10

**MAGIC E**

"magic e" spelling rule.

**BREAK-IN**

Soft "c"/soft "g" sounds.

Reading Pack 4. Age 8-11

**SORTOUT**

Alphabetical sorting.

**LETTERBUGS**

Unscrambling hidden words.

PRICE PER READING PACK.

CASSETTE: £7.95

40 TRACK DISC: £11.95

### B.B.C. ONLY

**ROADCRAFT 1**

Road Safety Skills for 5-9 year olds.

CASSETTE: £4.95

DISC: £6.95

**BERT BOOT**

Multiplication and Division Problems.

CASSETTE: £4.95

DISC: £6.95

**CARRYADD**

Addition and Subtraction with "Carrying".  
(12 Programs)

CASSETTE: £5.95

DISC: £7.95

**DICTIONARY**

Enables children to produce stories and language work from their own personal "Dictionaries".

DISC: £9.95

PLEASE STATE WHETHER YOU REQUIRE ELECTRON OR B.B.C. VERSIONS.

All prices include V.A.T.

## SOURCE LIBRARY MANAGER (SLM)

ROM based software for DISK owners on the BBC MICRO.

Have you ever overwritten an amended program that you haven't got around to backing-up yet? It need never cause a problem again with SLM. Your previous version is always available until you decide to delete it.

Have you ever spent hours searching through magazines looking for that useful little routine that you "would have keyed in at the time" but didn't want to clutter up your catalogue and waste most of your disk space. SLM is designed for exactly this purpose (but without the clutter and wastage).

Have you ever wished you could specify a "comment" of up to 20 characters when you save a program or routine so that later you can remember what it does. SLM allows this, even for different versions of the same program!

You paid a lot of money for your disk drives and diskettes, and if the storage of BASIC and/or ASSEMBLER source code is one of your major resource wasters then SLM will help you make much more efficient use of your investment.

\*\*\* Features include \*\*\*

- \* Stores and retrieves any amount of BASIC and/or ASSEMBLER source code, up to the full capacity of each disk (100k/200k).
- \* Creates a library of up to 399 "members" per 80 track, or 199 "members" per 40 track disk.
- \* Allows up to 99 versions of a single program or routine.
- \* Will simply and easily "construct" programs developed in a modular fashion.
- \* Stores fully documented code which can be "stripped" when required for execution.
- \* Uses 8 char names and a 20 char description for each "member".
- \* Is fully menu-driven (i.e. no messy command syntax).
- \* Includes comprehensive User Guide and fitting instructions.
- \* Many other features too numerous to list here (i.e. little things like not requiring any User RAM areas, and, leaving all function key settings unchanged, etc. etc.).

\*\*\* FULLY COMPATIBLE WITH 6502 SECOND PROCESSOR \*\*\*  
IDEAL FOR BEGINNERS AND EXPERIENCED PROGRAMMERS  
ALIKE

**GUARDIAN SOFTWARE**  
21 Harvey Road, Walton-on-Thames, Surrey  
KT12 2PZ

Or alternatively, ask your dealer if he stocks SLM.  
Dealer enquiries welcome.



# DEFINE

## A MULTICOLOUR SPRITE CREATOR, EDITOR & ANIMATION CONTROLLER FOR THE BBC B COMPUTER

DEFINE is a suite of programs providing all the sprite and animation facilities needed to produce high speed arcade type games using your own multicoloured characters (sprites).

The package is extremely easy to use, every command being made with a lightpen, or joystick, directly from the screen. Real size and enlarged views of your sprites are continuously updated while you define or edit them and you may test animation sequences in the editor package as you go along. New sprites may be created by editing old versions and the number of sprites you may define is unlimited. Sprites may be any size up to 12 x 16 pixels and each pixel may have any of the 16 standard mode2 colours. The software needed to animate your sprites is provided as a separate program, which you can merge into your own BASIC, or machine code, program, allowing high resolution positioning with fast, simple commands. The number of sprites, or clones, you may have at any one time is unlimited (except by computer memory) and the speed of movement can be very fast if desired — over 400 sprites per second may be printed from BASIC, or 700 per second from machine code. Of course, you may link sprites in your own programs, producing giant sprites, or sub-animation. A 24 page handbook is supplied as well as a BASIC example program.

LIGHTPEN OR JOYSTICK CONTROLLED

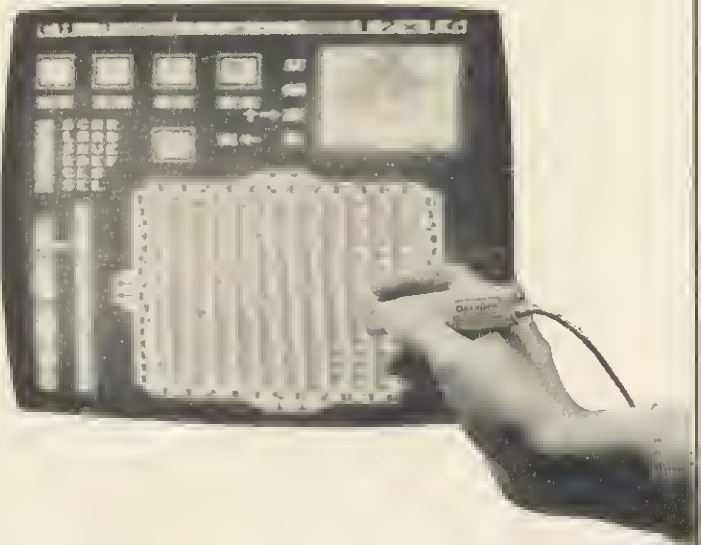

DEFINE tape version £9.95  
 DEFINE disc version £11.95  
 Datapen Lightpen Pack (optional) £25.00

All prices inc. VAT & Postage

(Software included with lightpen; introduction and 2 drawing programs)

**Datapen**

Datapen Microtechnology Ltd., Kingsclere Road, Overton, Hants RG25 3JB  
 TEL: (0256) 770488

### ACORN USER ADVERTISEMENT PAGES – NOVEMBER ISSUE

AB Designs	120	First London Micro Market	86	Pace	172
Abacus Business Machines	132	Garland Computing	126	Paw Systems	134
Abacus Software	134	Golem	159	Penguin Books	178
ACK Data	132	Griffen Computers	194	Phimag	12/13
Acornsoft	88/89/174/175	GSL Computing	158	Picotel	91
Addictive Games	178	Guardian Software	222	Prentice Hall	162
AJ Vision	208	HAL Computers	11	Printerland	212
Akhter	14/80/81	HCR Electronics	220	Prism	26/27
AMS	1	Highlight Software	222	Prosoft	212
B.S. Dollamore	204	Holderness	204	Proxima	180
BBC Soft	86	Intelligont Interfaces	136	Raven Computer Products	48
Beavan Technology	68	Interface	212	Reekie Technology	176
BEC Sports	220	Island Logic	72/73	Remedial Instruments	222
Beebug	214	Kansas	64	Rexel	42
Beebugsoft	116/117/118	Legend	176	Salamander	144
Beltech	139	Lincoln Micros	91	Screens	173
Big K	69	Loco Systems	216	Shard Software	130
British Micro	182	Logo Software	216	Shiva Publishing	202
C-Tech	145	LVL	IFC	Shumwari	196
Cambridge Micro Centre	161	Mayday Software	220	Silent Computers	202
Care Electronics	150	Mega Marketing	25	Silver Reed	188
Chase Data Ltd	92/93	Mertin	170	Slogger Software	76
CJE Micros	138	Michael's Business Systems	86	Softshop	51
Clares Micros	210/211	Micro-Advent	208	Software Invasion	71
Classic	156	Micro-Aid	54	Solidisk	146/147/148/149
Colisoft	173	Micro-Fix	222	Statacom Distribution	85
Commotion	6	Micro-Management	55/56/57	Structured Software	223
Communitel	114	Micro-Resources	194	Superior Software	IBC
Computamate	60	Micro-Tek	204	Synergy	152
Computer Concepts	53/140/206	Micro-User Show	40	Systems	192
Computer Marketplace Exhibitions	44	Microbyte	156	Tandy	194
Computer Room	208	Microchoice	150	Technomatic	19/20/21/22/23/24
Computerama	46	Microfast	186	Three D Computers	120
Control Universal	173	Microman	91	Torch	4/5
Cumana	79	Micropower	90/124/141/189/218/OBC	Twillstar	154/155/157/159/161/163
Datapen	223	Microtect	153	UCC	128
Dastar	166	Microvitec	142	Ultimate Play The Game	66
Dastore	159	Microworld	62	Unisoft	76
David Windrow Marketing	150	Microwriter	143	Universal Stands	220
Digisolve	166	Musisoft	220	Viglen	198/199/201/203/205/207/209
Discotechnology	75	Newark Video	204	Vine	196
DRG Business Systems	17	Opus	70/122/160/213	Virgin	134
Durrel Software	8			Virgin Games	132
Elbug	52			Voltmace	180
Electronequip	184/185			Watford	32/33/34/35/36/37/38/39
EMS Programming	196			West Coast Personal	202
English Software	132				

## FRIDAY TELEVISION

### BBC 1

#### 1.45 Postman Pat

Once Bitton twice shy. A *See-Saw* programme (Repeat)

#### 2.0 King Kurry

**F**In a remote corner of Cambridge, geologists in search of chips discover Kurry - the eighth wonder of the world - a 50-foot ape who 'rules' his company like a god. Introduced to London society, King Kurry escapes from his cage in Covent Garden and runs amok. Director **Steven Iceberg's** last film: 'Never work with animals and kids' being the verdict.

Apes.....ACORN R&D  
Make-up.....PELLE O'COIFFURE  
'Hold Me, Touch Me' Old Lady.....LAY WRAY

#### 3.35 Tom and Jerry

Cartoon fun with marketing men Tom Horrorfilm and Jeremy Pastry.

#### 3.50 Play School

**Jack Trampleson** people and **Uncle Clive** take younger viewers for a ride and ask "is the clock a prop or an electrical device?" If you think this is hard, you should see some of the educational software.

#### 4.10 The Rombles

Making good use of the EPROMs we find

#### 4.20 Cartoon Time

Viewers with two Crays and ten Vax computers to spare can tune to **Andre** and **Wally B** on Unix. For those with Ceefax, it's **Ballblazer** and **Resene** on Fractalus.

#### 4.30 Frakanory

The tale of the Aardvark and the Pilchard.

#### 5.5 Blue Peter

In a classic compilation **Lesley Judder** goes earthmoving. **Peter Pervert** reviews video-game nasties and **John Networks** makes an ABC with a written-off Volvo, a wine-soaked keyboard and a bag of French fries. Producer.....SMILEY MERRIMAN  
French fries.....BARBARA COLD

#### 5.30 \*Trek

While the Enterprise adventures on with **Elan**, the ageing **FX** calls you to boldly toggle to ITV for less punishment. Technical effects.....LORRY HARDWIRE  
Choreography.....MIKE RIGGISE

#### 6.0 The Six O'Clock News

**Kenneth Kendall** drones on while **Sue Lawless** and **Angela Nippon** play Joe Telford's game 'Let's make Ken say naughty words'.

#### 6.15 Or Who

An anonymous timelord arrives in the star system Gemini looking for intelligent lifeforms. Unable to find



Everything has to be just so as *Tony Quinnine of the Elite Squad* prepares for the safari.

#### BBC1 3.50 pm Play School

any, he crashlands on Earth and takes a job as R&D director with typewriter makers Acorn while looking for a new car. Burns effects.....HOWARD HISKEY

#### 6.30 Tomorrow's World

The trendy team reports on the Acorn Business Computer: Sixth generation or 1986? **Jumpsuit Hahn** interviews the PCW Show.

#### 7.0 Top of the Pops

Featuring **Frak** goes to Hollywood, **Michael Jackson's Thrilla Gorilla**, the **Aubrey Singers** and (straight in at number one and **Oric Muser** still don't know who **Commander Jameson** is) a live performance of **Elite** from the Acorn Softies with backing vocals from the Family Planning Advisory Service. Your DJs...IAN MACNAUGHTY-DAVIS  
JOHN 'DOO-BOP' COLE

Dancers.....JOHN WINECASE AND THE PROMOTIONELLES

#### 7.30 Gardeners' World

from Altrincham with **Shirley Conflab** Earthy **Shirley** takes Chris 'to the manor born' Curry down the garden path for a tour of the flower beds. **Shirl's** helpful hints include how to treat forget-me-nots and exactly how much manure to put on red roses. Conan.....HERSELI  
Barbarian.....HIMSELF

#### 8.0 Life on Earth

**David Atombord** explores the great Redwood Forest of Long Odour and discovers Ward-hogs, Smircen slugs, and bony Quinn-fish. Not for the squeamish. Six-legged bugs.....CHAS MIRE  
Welsh leaks.....BOB PICKERING

#### 9.0 The Nine O'Clock News

with **Richard Witless**. Weather Guesser with rain-loving **Michael Fish**.

#### 9.25 The Survivors

An accident in **Hermann's** particle physics laboratory wipes out all but a few of the world's computer companies. The survivors struggle to rebuild civilisation and force the share price back over 120p. This week... combatting Dutch Oak disease.

#### 11.0 Micro Live

How does a nightmare begin? For **John Coil** and **Lesley Judder** it began on BBC2 at 6pm when trying to load paper into an Epson during a printer review. Daisy Wheel.....DAVID ALLIN  
Tea Boy.....PATRICK TETLEY  
Frefl.....BORIS KARLOFF  
Epson.....ROBIN FUDCL  
Topical Piece.....CLIVE PENGUIN

#### 11.40 The Good, the Bad and the Elkey

Western: Torch cowboys against Indians from Watford in which **Clint Redwood** gets his comeuppance from the evil, cheroot-smoking **Mad Alex van Cleef**. Music courtesy of **Generator** from **Quicksilver** surfer. Man With No Name.....ROBBIE McMILLAN

Greasy little Mexican.....SIMON DALLY  
van Cleef.....GIBB

#### 1.15 am The Epilogue

Comedian **Mark Colton** talks about why Wheelchair is an invalid command in View.

#### 1.30 Closedown

**Bill Cotton** explains why he took Acorn Abuser's Diary off the air: 'You didn't tell the one about **Aubrey Singer's** garage being called **The Fuehrer's Bunker** because it's so full of technical gadgetry.'

## THE WEEKEND STARTS HERE

### SATURDAY

To remind us that Summer's nearly over it's the **Last Night of the EPROMs** on BBC1 with **The Tube** pushing out some high-speed stuff on BBC2. Meanwhile, **Music Box** brings us the sounds of **Ceefax**.

### SUNDAY

**Chess** enthusiasts will welcome the first of ten programs on the **World Championships** between **White Knight** and **Dontee Carpon**.

### WEEKDAYS

Finally for all fans of old lace, buck teeth and pebble-dash spectacles, we have the return of the ever-popular **Dear Ladies** starring **Dr Maria Hauser** and **Hilda Bracket**.

... and in

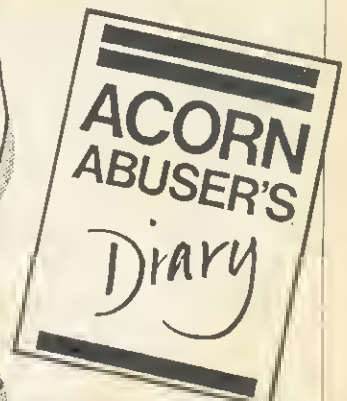

A power wheelchair of such advanced perfection it's in a class of its own



Discover a new era in comfort and control at your local E&J dealer. Finance available through Motability.

Send for our colour brochure  
Everest & Jennings, Pinewood Road,  
Corby, Northants NN17 2DX  
NAME.....  
ADDRESS.....



# THE BEST BBC MICRO SOFTWARE

\* PRODUCED BY AN INDEPENDENT SOFTWARE HOUSE \*

\* TOP QUALITY MACHINE-CODE PROGRAMS \*

**BBC  
MICRO**

**SPECIAL  
OFFER!**

Deduct £1 per  
cassette when  
ordering 2  
or more



## BMX ON THE MOON (32K)

**£7.95**

Smooth scrolling-screen arcade action. In this game you control a moon cycle which you use to patrol the surface of the moon. You must avoid the rocks on the surface, and also the monsters bouncing high in the low gravity. You should try to shoot down the spaceships which fly overhead dropping bombs onto the moon surface: A further hazard are the flying barrels which are often just too high to shoot or jump over, and just too low to squeeze underneath.

●●●NEW RELEASE●●●



Many of our titles are available in Boots, W.H. Smiths, John Menzies, Rumbelows, Laskys, Currys, HMV, Greens at Debenhams and Spectrum Shops. Also at all major computer dealers - Eltec Computers, Mira Management, West Coast Personal Computers, Microstyle, Electronequip, 3D Computers, Computerama, GTM Computers, etc. Our software is also available through all the major distributors, and directly from us by mail-order.



## WINGED WARLORDS (32K)

**£7.95**

A fascinating arcade-style game for one or two players. Each player rides an ostrich, and the aim is to knock the enemy riders off by colliding with them. In a collision the rider with the highest jousting pole will be victorious. If you are successful, the enemy will revert to its original form: on egg. The egg must be collided with to prevent it from hatching. Avoid the lava bath at the bottom of the screen, and remember: you can fly better by using stronger strokes - imagine you are on ostrich trying to fly!

(KEYBOARD OR JOYSTICKS)

●●●NEW RELEASE●●●



## SUPERIOR SOFTWARE LTD.

Dept. AU11, Regent House,  
Skinner Lane, Leeds 7  
Tel: 0532 459453

### OUR GUARANTEE

- (1) All our software is available before we advertise.
- (2) All our software is despatched within 48 hours by first-class post.
- (3) In the unlikely event that any of our software fails to load, return your cassette to us and we will immediately send a replacement.



# Mr Be!

A SENSATIONAL RELEASE FROM THE AUTHOR OF THE BEST SELLING "KILLER GORILLA" Dig channels through the earth collecting the cherries. Crush the hungry Umpbs, Maras and Diggers with the apples, or bounce the Crystal Ball down the tunnels to catch one. Features ten different screens, superb graphical animation and top quality sound.

B.B.C. MICRO

NEW PRICE!

BBC Cassette £6.95

BBC Disk £9.95



MICRO  
POWER

WATCH OUT  
FOR OUR NEW  
PACKAGING AND  
CATALOGUE

MICRO POWER LTD.  
NORTHWOOD HOUSE, NORTH STREET,  
LEEDS LS7 2AA TEL: (0532) 458800  
SELECTIVE BRANCHES OF BOOTS CO-OP,  
MENZIES W. H. SMITH WOOLWORTHS AND ALL  
GOOD DEALERS  
AUTHORS! WE PAY 20% ROYALTIES!

