

EPSON®

STYLUS® SCAN

2500

User's
Guide

Copyright Notice

All rights reserved. No part of this publication may be reproduced, stored in a retrieval system, or transmitted in any form or by any means, electronic, mechanical, photocopying, recording, or otherwise, without the prior written permission of SEIKO EPSON CORPORATION. The information contained herein is designed only for use with this EPSON printer. EPSON is not responsible for any use of this information as applied to other printers.

Neither SEIKO EPSON CORPORATION nor its affiliates shall be liable to the purchaser of this product or third parties for damages, losses, costs, or expenses incurred by purchaser or third parties as a result of: accident, misuse, or abuse of this product or unauthorized modifications, repairs, or alterations to this product, or (excluding the U.S.) failure to strictly comply with SEIKO EPSON CORPORATION's operating and maintenance instructions.

SEIKO EPSON CORPORATION shall not be liable for any damages or problems arising from the use of any options or any consumable products other than those designated as Original EPSON Products or EPSON Approved Products by SEIKO EPSON CORPORATION.

Trademarks

EPSON and EPSON Stylus are registered trademarks of SEIKO EPSON CORPORATION.

Micro Piezo, PhotoEnhance, and Smart Panel are trademarks of Epson America, Inc.

General Notice: Other product names used herein are for identification purposes only and may be trademarks of their respective owners. EPSON disclaims any and all rights in those marks.

The ENERGY STAR emblem does not represent EPA endorsement of any product or service.

C

Contents

<i>Welcome</i>	Special Features	2
	About Your Software	3
	Getting More Information	4
	Warnings, Cautions, Notes, and Tips	5
	Registering	5
	Reading Your Reference Guide	5
	Reading Your Other Electronic Manuals	7
	Using the EPSON Smart Panel	9
	Copy Utility	10
	Scan to Fax	11
	Scan to E-mail	12
	Scan to OCR	13
	Photo Print (Windows)	14
	PrintFun (Macintosh)	15
	Scan to Application	16
	Scan for Creativity	17
	Using Smart Panel in Palette Mode (Windows)	18
<i>Copying</i>	Positioning the Original Document	20
	Using the Control Panel	21
	Using the Copy Utility	23
	Basic Copying	23
	Adjusting the Copy Size	25
	Making Advanced Settings	28
	Adding Time Stamps and Watermarks	31
	Saving Advanced Settings	34

Printing

Choosing the Right Paper and Settings	35
Handling Paper	36
Printing on Photo Paper	37
Printing on Envelopes	38
Basic Printing with Windows	39
Basic Printing on a Macintosh	42
Printing with Special Settings	44
Enhancing Photographs	45
Using Custom Project Types	45
Using Advanced Print Settings	46
Choosing the Right Settings for EPSON Papers	48
Using Photo Print (Windows)	49
Scanning in Your Photo	49
Opening Images on Your Computer	52
Printing Your Photos	53
Using PrintFun (Macintosh)	58
Scanning in Your Photo	58
Opening Images on Your Computer	62
Printing Your Photos	63
Printing a Catalog of Your Photos	66

Scanning

Basic Scanning with TWAIN	70
Starting Your Scan	70
Making Changes to Your Scan	72
Scanning Part of an Image	75
Scanning to OCR	76
Scanning the Text	76
Processing the Text	78
Saving the Text File	80
Opening a Word Processing Program	82
Scanning to E-mail	85
Scanning Your Document	85
Formatting and Sending the File	89
Scanning for Creativity	91
Scanning Your Images	91
Creating Your Project in Windows	92
Creating Your Project on a Macintosh	94

Scanning to an Application	95
Registering New Applications	98
Removing Applications or Changing Properties	100
Quick Scanning	101
Setting Up the EPSON Scanner Monitor (Macintosh)	101
Selecting an Application in EPSON Smart Panel	102

Faxing

Faxing with Smart Panel	104
Sending a Fax	104
Receiving Faxes	106
Customizing Scan to Fax	108
Using eFax	109

Using the Automatic Document Feeder

Installing the Automatic Document Feeder	111
Loading Your Document	114
Clearing Paper Jams	115
Cleaning the Paper Path Guide	117

Maintenance

Replacing an Ink Cartridge	121
Removing and Installing Ink Cartridges	122
Replacing an Outdated Ink Cartridge	125
Cleaning the Print Head	126
Using the Head Cleaning Utility	126
Using the Control Panel to Clean the Print Head	127
Examining the Nozzle Check Pattern	128
Aligning the Print Head	129
Cleaning the EPSON Stylus Scan	129
Transporting the EPSON Stylus Scan	130

Solving Problems

Diagnosing Problems	133
Running a Printer Check	135
EPSON Stylus Scan Parts	136
Problems and Solutions	137
Solving Problems Setting Up the EPSON Stylus Scan or Installing Its Software	137
Solving Problems with Printing and Copying	140
Solving Problems with Paper Feeding	141
Solving Miscellaneous Printout Problems	142
Solving Problems with Scanning and Copying	143
Solving Print Quality Problems	145
Solving Scan Quality Problems	150
Uninstalling the EPSON Stylus Scan Software	152
Uninstalling in Windows (USB Connection)	152
Uninstalling in Windows (Parallel Connection)	153
Uninstalling on a Macintosh	153
Where To Get Help	154
EPSON Technical Support	154
Technical Support for Other Software	155

Notices

Windows System Requirements	157
Macintosh System Requirements	158
ENERGY STAR Compliance	159
Options	159
Important Safety Instructions	160
Ink Cartridge Safety Instructions	161
DECLARATION of CONFORMITY	163
FCC Compliance Statement	164
EPSON AMERICA, INC. LIMITED WARRANTY.	165

Index

W *Welcome*

The EPSON Stylus® Scan 2500 is the complete solution for full-featured printing, scanning, and copying in a single device, without compromising quality.

It's the ideal printer for business graphics, single-page layout proofs, digital photography—or any project you create on your computer. It's also a 36-bit professional color scanner that lets you capture images with amazing detail. You can scan, then e-mail or fax images, or publish them on a web site. You can even scan in a printed document, and then edit the text on your computer.

You can also use your EPSON Stylus Scan 2500 as a copier. You can select copy settings from the printer's control panel, then print the copies without ever turning on your computer. Or you can use a control panel on your computer screen to select custom settings and copy.

The EPSON Stylus Scan 2500 comes with these features:

- Print resolutions up to 1440 × 720 dpi, for photo-quality color and sharp text even on plain paper
- EPSON's unique variable dot Micro Piezo™ technology for superior printing results
- 600 × 2400 dpi scanning with 36-bit color depth for capturing images with over 68 billion colors
- Photo-quality color copying
- Plug and play setup on both Windows® 98 and Macintosh® computers with a USB connection (if your system meets the system requirements on page 157 and page 158)
- Parallel connection for Windows 95 and 98

- Quick scanning, which lets you automatically send your scan to a target application whenever you press the  **Scan** button on the EPSON Stylus Scan control panel
- Easy-to-use software for printing, scanning, and copying
- Optional automatic document feeder (included with the EPSON Stylus Scan 2500 Pro model) for copying or scanning up to 20 pages at a time. Also lets you scan and copy legal-size documents.
- Optional transparency unit for scanning slides, negatives, and transparencies

Special Features

Your EPSON Stylus Scan makes it easy to do specialized projects using these features:

W
M

- **Photo Print** (Windows) or **PrintFun** (Macintosh)

You can make extra prints of your favorite photos, starting with an actual photograph or with an image on your computer. You can choose the size, number, and format of your prints, and use special paper for professional results.

- **Copy Utility**

Place a printed document on the document table and then use the control panel on your computer screen to make custom settings for high-quality copies.

- **Quick Scanning**

When you set up this feature, you just press the  **Scan** button on the control panel for quick access to EPSON® Smart Panel™ applications.

- **OCR**

Most scanning creates an image, even when you're working with text. OCR (optical character recognition) lets you scan a page of words and create a text file that you can edit in your word processing application.

note:

W means the information is for Windows users only.

M means the information is for Macintosh users only.

- **Fax**

If you have a modem in your computer, you can send and receive faxes on your EPSON Stylus Scan 2500. Anything that you can scan in or create on your computer, you can fax. The same utility lets you receive incoming faxes. Or you can use eFax™ to receive faxes through your e-mail. See Chapter 4 for more information.

- **E-mail**

If you have a modem, an Internet connection, and an e-mail application, you can scan an image or a document, then send it to colleagues, customers, or friends.

About Your Software

Your software enables the EPSON Stylus Scan to print, scan, and copy. Make sure you follow the instructions on the *Start Here* sheet to install this software:

- **Your printer driver and scanner driver**

Work behind the scenes to let you print and scan. You can access the printer driver and scanner driver (called TWAIN) directly if you want to experiment with advanced settings. Even if you don't, your drivers operate whenever you use your EPSON Stylus Scan 2500.

- **EPSON Smart Panel**

Lets you scan, copy, and print by clicking a few buttons on your computer screen. You can also use it with the  **Scan** button on your control panel for quick scanning.

W ■ **WinFax® Basic** (Windows) or

M ■ **FAXstf®** (Macintosh)

Let you send and receive faxes through the modem in your computer.

- **eFax**

Internet fax service provided by eFax.com, which lets you receive faxes through your e-mail. For instructions on installing and using eFax, see page 109.

- **Adobe® Acrobat® Reader**
Lets you read the on-screen manuals for EPSON Smart Panel, WinFax, FAXstf, Adobe PhotoDeluxe,® or any other files in the Portable Document Format (PDF).
- **Adobe PhotoDeluxe (on a separate CD-ROM)**
Image-editing software for enhancing your scanned photos, adding special effects, and creating projects like web pages, business cards, and calendars.

Getting More Information

There are several sources of information for your EPSON Stylus Scan 2500, including printed materials, help utilities and electronic manuals. Here's where to look for help:

- **Start Here sheet**
Read this first to set up your EPSON Stylus Scan 2500 and install its software. You need to follow these instructions carefully before you can use the EPSON Stylus Scan.
- **Electronic EPSON Stylus Scan 2500 Reference Guide**
Check here for detailed information about your EPSON Stylus Scan 2500, including technical specifications. You must have a web browser (Netscape® Navigator® or Microsoft® Internet Explorer, version 3.0 or later) to read your *Reference Guide*; see page 5 for instructions.
- **On-screen Help**
Whenever you're working with EPSON Smart Panel or any of the other software that came with your EPSON Stylus Scan 2500, you can click the **Help** button or **Help** menu.
- **Other Electronic Documents**
EPSON Smart Panel, WinFax, FAXstf, and Adobe PhotoDeluxe include electronic manuals in the Adobe Acrobat PDF format. See page 7 for instructions on accessing and reading your Acrobat manuals.

If none of these sources answers your questions, please see "Where To Get Help" on page 154.

warning

caution

note

tip

Warnings, Cautions, Notes, and Tips

Please follow these guidelines as you read this manual:

- Warnings must be followed carefully to avoid bodily injury.
- Cautions must be observed to avoid damage to your equipment.
- Notes contain important information about your EPSON Stylus Scan.
- Tips give you useful hints for printing, scanning, and copying.

Registering

Please take a minute to fill out the registration card for your EPSON Stylus Scan 2500 and mail it back to us, if you haven't already registered when you installed your software. This enables you to receive special information on options, new products, and software upgrades. You'll get immediate attention if you have a problem with your EPSON Stylus Scan.

Reading Your Reference Guide

Your electronic *EPSON Stylus Scan 2500 Reference Guide* is on your EPSON Stylus Scan 2500 software CD-ROM. You can view it from the CD-ROM or copy it to your hard drive and view it from there. Follow these steps:

1. Insert your EPSON Stylus Scan 2500 software CD-ROM.
- W** 2. Double-click the **My Computer** icon on your desktop. Then double-click the **Epson_ss2500** CD-ROM icon.
- M** Double-click the **EPSON SS2500** CD-ROM icon.
- W** 3. Double-click the **Manual** folder, then double-click the **Ess2500** icon.

note:

You must have a web browser (Netscape Navigator or Internet Explorer, versions 3.0 or later) to view your Reference Guide.

M

Double-click the **Manual** icon, then double-click the **EPSON STYLUS SCAN 2500** icon.

The Reference Guide window opens:

note:

Click *Install Reference Guide* to copy the manual to your hard drive so you can read the guide at any time. To read the copied guide, do one of the following:

Windows: Click *Start*, point to *Programs*, *EPSON*, and select *EPSON Stylus Scan 2500 Reference Guide*.

Macintosh: Double-click the *View Reference Guide* icon in the *EPSON STYLUS SCAN 2500* folder on your hard drive.

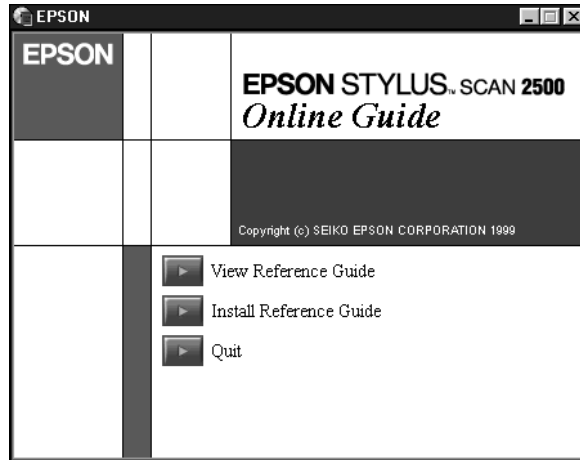

4. Click **View Reference Guide**. You see this window:

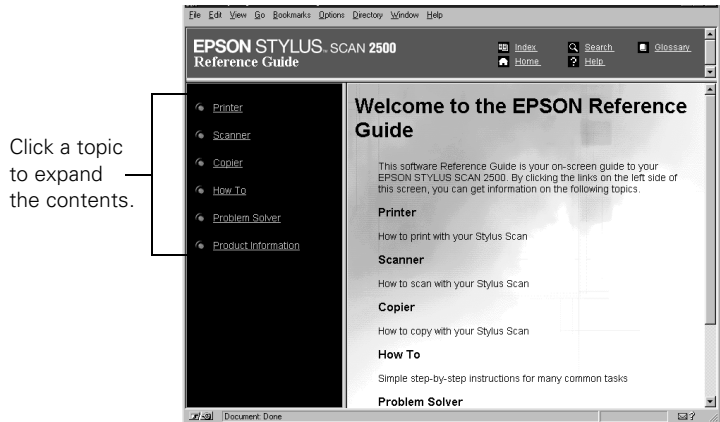

Click topics on the left to expand the contents.

After expanding the contents, you can click on the topic you want to view. If there's a right arrow , click it to view subtopics. Then click the topic you want to see.

Click here to expand a subtopic.

Click here to view a topic.

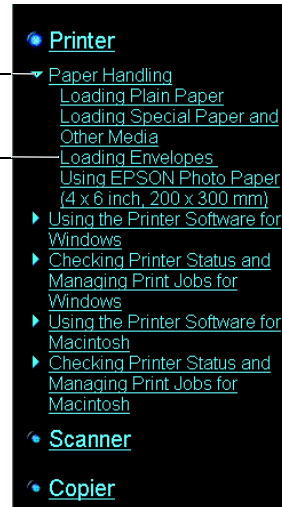

note:

You probably installed Acrobat Reader when you installed your other EPSON Stylus Scan 2500 software. If not, you can install it from the EPSON Stylus Scan 2500 CD-ROM. Follow the instructions on your Start Here sheet.

W

If you already have a version of Acrobat Reader on your system, you can use it to open your manuals.

M

W

M

Reading Your Other Electronic Manuals

To read your electronic manual for EPSON Smart Panel, WinFax, FAXstf, PhotoDeluxe, or any other PDF manuals, you'll use Adobe Acrobat Reader.

Here's where your software PDF manuals are located:

- For Smart Panel, do one of the following:
 - Click Start, point to Programs, EPSON Smart Panel, and click Smart Panel User's Manual.
 - Open the EPSON SMART PANEL folder and double-click EPSON Smart Panel User's Guide.
- For WinFax, locate the *User's Guide* (Wfscript.pdf) in the WinFax/Docs folder on the EPSON software CD-ROM.
- For FAXstf, locate the *FAXstf User Manual* in the FAXstf folder on your hard drive.

- For PhotoDeluxe, locate the *Getting Started* guide (GetStart.pdf) in the **English (Windows)** or **Extras (Macintosh)** folder on your Adobe PhotoDeluxe CD-ROM.

When you open an electronic manual, you'll see this toolbar:

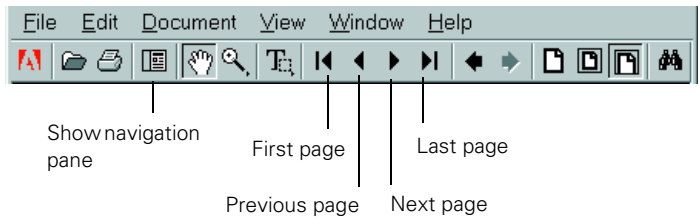

With Acrobat Reader, you have several ways to navigate through text:

- Use the navigation pane on the left side of the screen to move quickly to the topic of your choice.
- Use the arrow buttons in the toolbar or the vertical scroll bar on the right side of the document to move through a manual. (The box to the left of the scroll bar displays the current page number.)
- Click on hot topics, which are usually underlined or displayed in a different color. To find out if a topic is hot, move your cursor over it. If the cursor turns into a pointing hand, the topic is hot—you can jump to it by clicking once.

For more information, see your Acrobat Reader online guide.

Using the EPSON Smart Panel

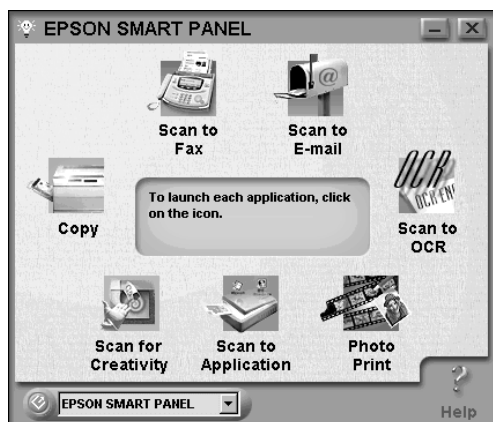

Windows

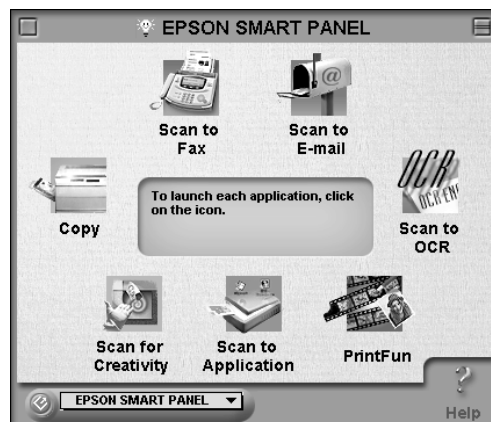

Macintosh

note:

Make sure you've installed your EPSON Smart Panel software, following the instructions on the Start Here sheet.

You can use the EPSON Smart Panel for all types of scanning, as well as for high-quality copying and photo printing. You can also use it for quick scanning to any of the Smart Panel applications (see page 101 for details).

To open the EPSON Smart Panel, do one of the following:

- W** ■ Click the  Smart Panel icon on the right side of the Windows task bar.
- M** ■ Smart Panel opens automatically when you start your Macintosh. If you closed it and need to open it, select EPSON SMART PANEL from the Apple menu or from the EPSON Smart Panel folder on your hard drive.

You see the EPSON Smart Panel window shown above. Click an icon on the panel to use any of the applications described on the following pages.

If you need more information, see the electronic *Smart Panel User's Manual*, as described on page 7.



Copy Utility



You can use the control panel on your computer screen to make copies of printed pages and photos, with customized settings to enhance your copies. When you make copies using the Smart Panel Copy utility, you have more control over the quality of your output than when you make copies without your computer.

For detailed instructions, see “Using the Copy Utility” on page 23.



Scan to Fax



Click the speed-dial buttons, or ...

Click the numbers on the keypad to dial.

Then click the Start button.

If you have a modem, you can use a virtual “fax machine” on your computer screen to send photos or text. First place your page or photo face down on the EPSON Stylus Scan’s document table, then enter the fax number by clicking the keypad on your screen and click the Start button. The EPSON Stylus Scan scans your document and converts it to a fax image. You can also set up Scan to Fax to print received faxes automatically (Windows only).

For detailed instructions, see “Faxing with Smart Panel” on page 104.



Scan to E-mail

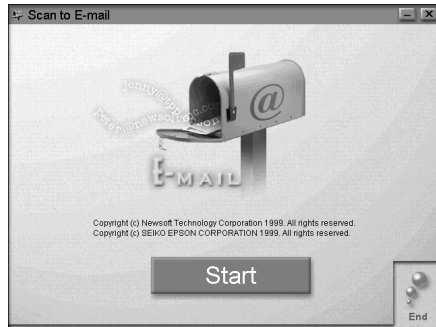

If you have a modem and e-mail service, you can use your EPSON Stylus Scan to send photos or documents. The Scan to E-mail utility saves the scan in any format you choose, including text. Then it opens your e-mail program so you can attach the scanned file and share it with friends or colleagues.

For detailed instructions, see “Scanning to E-mail” on page 85.



Scan to OCR



Optical character recognition, or OCR, converts a scanned text image into text that you can edit in a word processing program. The Scan to OCR utility makes it easy for you to do all the steps in this process:

- Scan the document
- Process and edit the text, using a window like this:

If you scanned more than one page, click the page in this column that you want to edit.

This window shows a close-up of the scanned image.

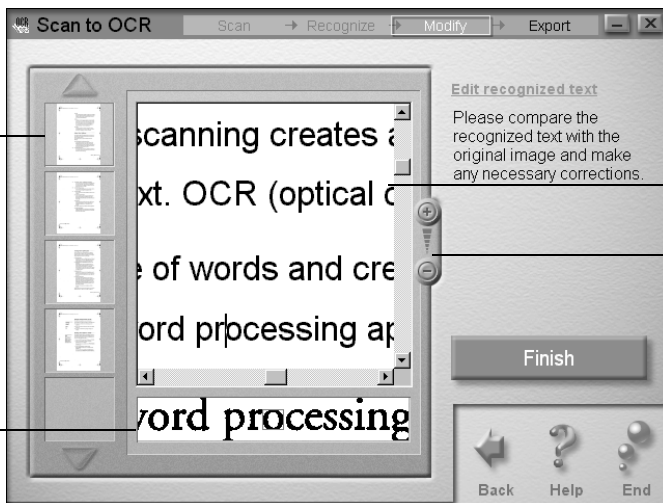

Edit your text here.

Click the + or - button to enlarge or reduce the view.

- Save the file in any format you choose, including HTML.
 - Open your word processor so you can work with the text.
- For detailed instructions, see "Scanning to OCR" on page 76.



Photo Print (Windows)



tip:

Try using the EPSON Photo Paper that came in your Media Pack to print your photos.

The Photo Print utility gives you an easy way to reprint your photos in any size you want. You can scan in your photos and then print them on EPSON snapshot-size photo paper or cards. You can also use full-size sheets of photo paper to create enlargements or combine several prints on one sheet.

After you scan or open your images, you see a window like this, where you can select the print layout:

The number of sheets you'll need for the selected image(s) in the layout shown.

To select a page size, click its button.

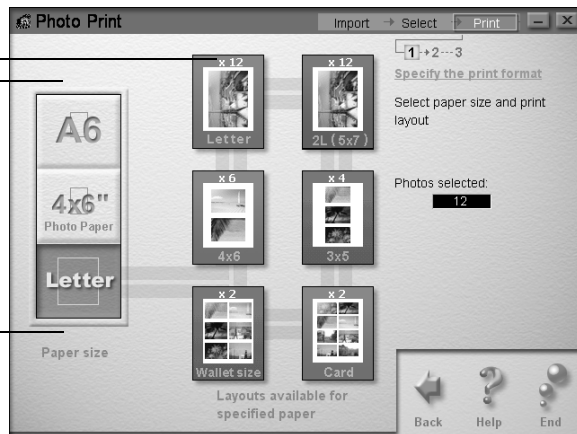

For detailed instructions, see “Using Photo Print (Windows)” on page 49.



PrintFun (Macintosh)



tip:

Try using the EPSON Photo Paper that came in your Media Pack to print your photos.

The PrintFun utility gives you an easy way to reprint your photos in any size you want. You can scan in your photos and then print them on EPSON snapshot-size photo paper or cards. You can also use full-size sheets of photo paper to create enlargements or combine several prints on one sheet.

After you scan or open your images, you see a window like this, where you can select to print individual photos or a catalog of photos on one sheet, like a proof sheet:

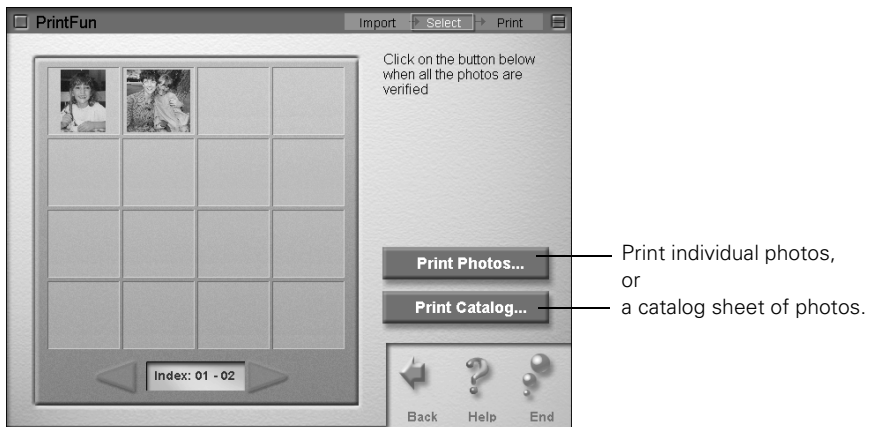

For detailed instructions, see “Using PrintFun (Macintosh)” on page 58.



Scan to Application



This utility automatically scans your image and then opens it in any supported application program on your computer. You can select the program you want to use and the default file format for the scanned image, using this window:

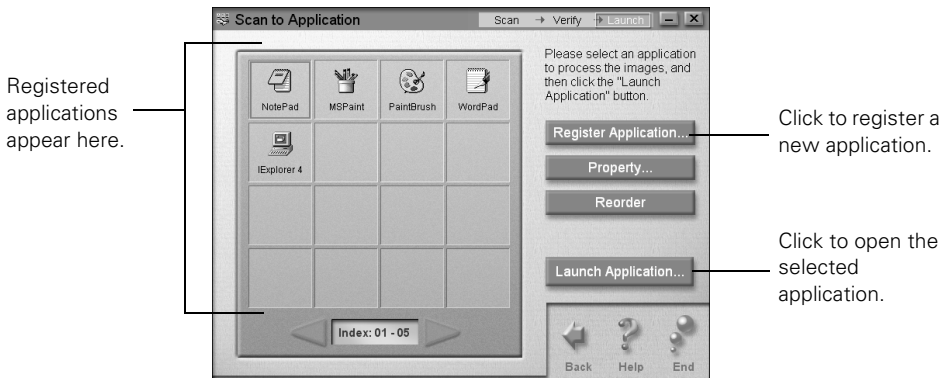

For detailed instructions, see “Scanning to an Application” on page 95.



Scan for Creativity



This utility scans your image automatically and then opens it in PhotoDeluxe, which guides you through the steps to create a print project—such as a calendar, card, label, or web page.

W With Windows, you first choose from 25 different project types you can create with your scanned images.

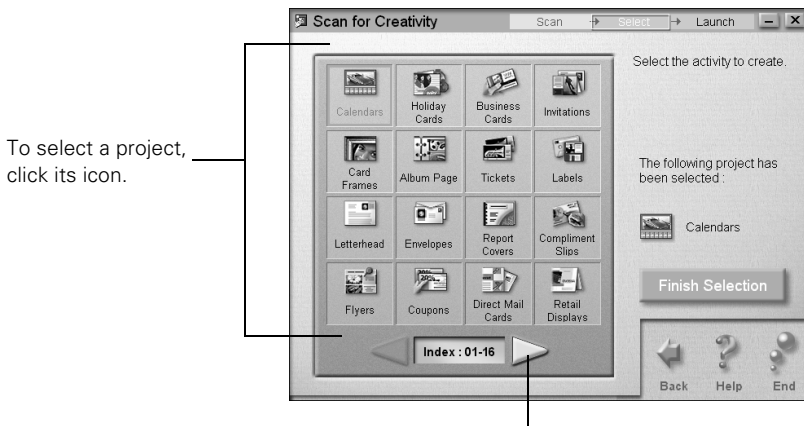

To select a project, click its icon.

Click here to display more projects.

For detailed instructions, see “Scanning for Creativity” on page 91.

If you need more information about PhotoDeluxe, see its electronic manual as described on page 7.

W **Using Smart Panel in Palette Mode (Windows)**

In palette mode, your Smart Panel icons are arranged in a compact toolbar rather than a panel:



To switch to palette mode:

1. Click the  Smart Panel icon in the upper left corner of the Smart Panel window. You see the system menu:
2. Select **Switch to Palette Mode**.

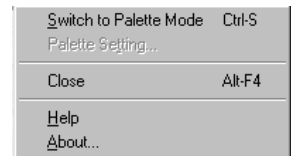

To switch from palette mode back to panel mode, click the  Smart Panel icon on the palette toolbar and select **Switch to Panel Mode**. EPSON Smart Panel returns to this view:

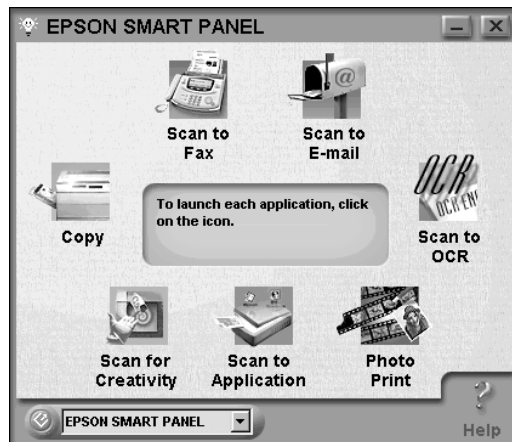

1 Copying

You can use your EPSON Stylus Scan like a standard copier—load paper in the sheet feeder, place a document on the document table, then press the **Copy** button. You don't even have to turn on your computer. The buttons on the EPSON Stylus Scan's control panel let you make all the basic settings: paper and copy size, copy quality, number of copies, color or black and white, and lighter or darker copies.

If you want more copying options, you can use the EPSON Smart Panel Copy Utility to control copying from your computer.

You'll find instructions in this chapter for the following:

- Positioning your original on the document table
- Using the control panel to copy without a computer
- Using the Smart Panel Copy Utility

note:

You can't use the optional transparency unit with the copy function.

Positioning the Original Document

note:

If you have the automatic document feeder, you can copy up to 20 pages at a time. See “Loading Your Document” on page 114 for instructions on loading your original in the automatic document feeder.

First make sure you have paper loaded, following the instructions in “Handling Paper” on page 36. Then follow these steps to place the document you want to copy:

1. Open the document cover.

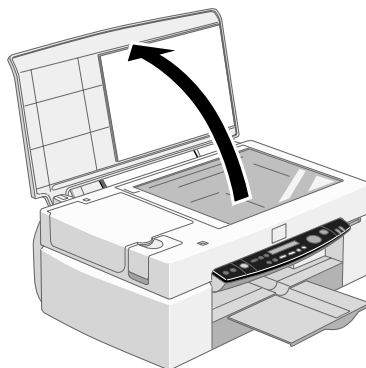

2. Place the original document face down on the document table. Position it so the horizontal and vertical edges are carefully aligned with the scales along the sides of the document table.

top corner of document

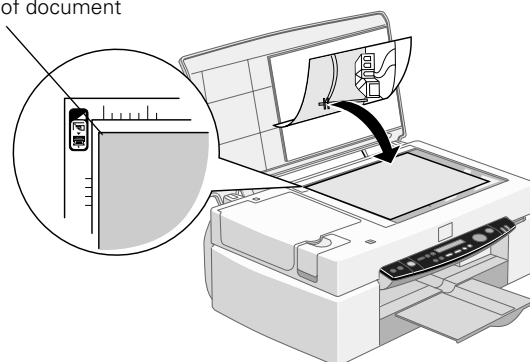

3. Close the document cover slowly. Be careful not to move the document.

Using the Control Panel

You can perform most basic copy operations from the EPSON Stylus Scan's control panel.

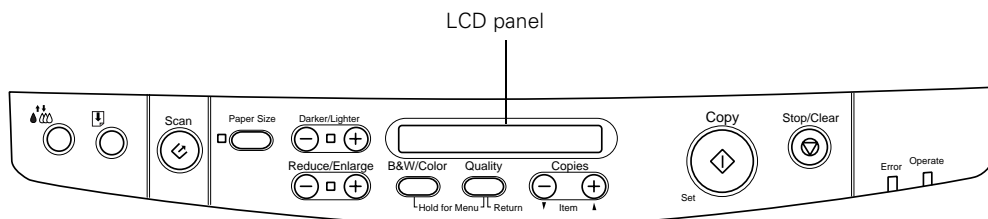

note:

You can use the control panel's Menu Mode to print a status sheet, set the bottom margin, change from U.S. to metric paper sizes, set the language on the LCD panel, or reset the control panel to the factory defaults. For detailed information about Menu Mode, see your electronic EPSON Stylus Scan 2500 Reference Guide.

The LCD panel displays the current copy settings. When you first turn on the EPSON Stylus Scan, you see these default settings: **100% B&W Normal 1**. This means you're set to produce one black and white copy, of the same size as the original document, at Normal quality (360 dpi resolution for everyday copying).

Follow these steps to copy using the control panel:

1. Press the **Operate** button to turn on the EPSON Stylus Scan. Wait until the **Operate** light stops flashing.
2. Load paper in the feeder and place your original face down on the document table. Close the document cover.
3. Press the **Paper Size** button. A list of paper sizes appears in the LCD panel, with brackets around **Letter**. To change paper size, press the **Paper Size** button to move the brackets.

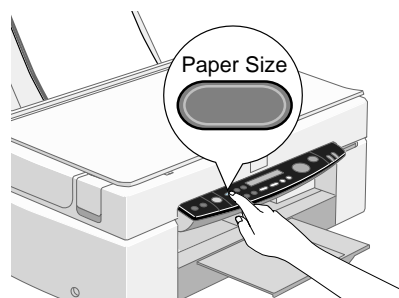

note:

To return a setting to its default, press the Stop/Clear button while changing the setting.

When you restart the EPSON Stylus Scan, all settings automatically return to their defaults.

note:

The Photo setting doesn't appear in the LCD panel unless the EPSON Stylus Scan is set to produce color copies.

4. If you want to make your copy lighter or darker, press the + or – button under **Darker/Lighter**. The settings appear temporarily in the LCD panel, with the current setting bracketed. Continue to press the + or – button to move the brackets to a new setting. (You can make your copy up to twice as light or twice as dark as the original.)
5. To make your copy smaller or larger than the original, press the + or – button under **Reduce/Enlarge**. You can make copies as small as 50% of the original size, or as large as 200%.
6. If you want to make a color copy, press the **B&W/Color** button.
7. Press the **Quality** button to set copy quality. The following settings are recommended for different originals:

Normal: Text, line art, or graphics on plain paper

Fine: Photographs on plain paper

Photo: Color photographs on EPSON Photo Paper

8. To make more than one copy, press the + button under **Copies**. You can make up to 20 copies.
9. Press the green **Copy** button to begin copying.

Using the Copy Utility

The Copy Utility on the EPSON Smart Panel gives you a way to produce professional quality copies with special features, like watermarks and time stamps.

Make sure the Smart Panel software is installed and your printer is set up, connected to your computer, and turned on. Then continue with the instructions in these sections:

- Basic copying
- Adjusting the image size
- Making advanced settings
- Adding time stamps and watermarks
- Saving custom settings

Basic Copying

1. Load paper in the sheet feeder. For instructions on loading paper, see “Handling Paper” on page 36.
2. Position your original on the document table (as described on page 20) or in the automatic document feeder (as described on page 114).
3. Do one of the following:

W Click the  Smart Panel icon on the Windows taskbar to open the Smart Panel.

M Click the Apple menu icon, then click **EPSON SMART PANEL** to open the Smart Panel.

4. Click the  Copy icon.

You see the Copy Utility control panel on your screen.

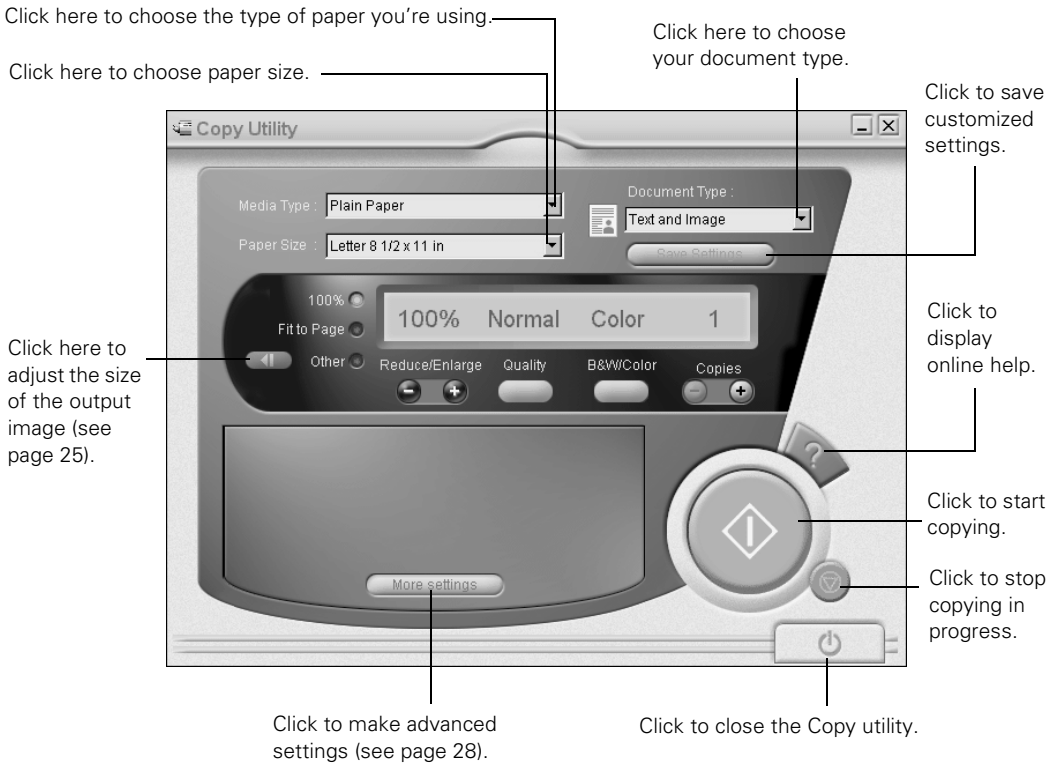

note:

The EPSON Stylus Scan automatically adjusts the ink coverage according to your Media Type setting. That's why this setting is so important for high-quality copies. See "Choosing the Right Settings for EPSON Papers" on page 48 for details.

5. Choose the type of paper you're using in the **Media Type** list. Then choose your paper size.
6. Choose your document type in the **Document Type** list.
 - Choose **Text** if your document contains text only.
 - Choose **Photo** if you're copying a photograph.
 - Choose **Text and Image** if your document includes both text and illustrations.
 - Choose **Multi-page Document** if you're using the automatic document feeder to copy multiple pages. (To print collated copies, see "Saving Advanced Settings" on page 34.)

7. Click the appropriate buttons to set copy quality, switch from color to black and white, or increase the number of copies you want to make.
8. When you're finished selecting copy settings, click the large, green Copy button on the screen.

The EPSON Stylus Scan scans the image and displays a progress bar on the screen. Then it loads paper and prints your copies. A print job control window also appears on the screen; see page 41 (Windows) or page 44 (Macintosh) for instructions on controlling printing.

Adjusting the Copy Size

You can use the Copy Utility to fine-tune the size of your copies.

If you don't need to preview your image, you can use the following methods to change the copy size:

- If you want the output image to be the same size as the original, select **100%** on the screen's control panel.
- Select **Fit to Page** to set the image to fit your paper size setting. **Auto** appears on the Copy Utility control panel.
- Click the + or – button under **Reduce/Enlarge** to gradually increase or decrease the size of your image from 25% to 400%. (The percentage expresses the ratio of the copy size to the original image size. It changes by one percentage point each time you click a button.)

You can also use the Scaling window to preview your copy and adjust the size. Follow these steps:

1. Click the  Scale button on the Copy Utility control panel. You see the window below.

Click and drag to resize your image by an exact percentage.

Click to fit your image to a standard page size, or preview it before you resize it.

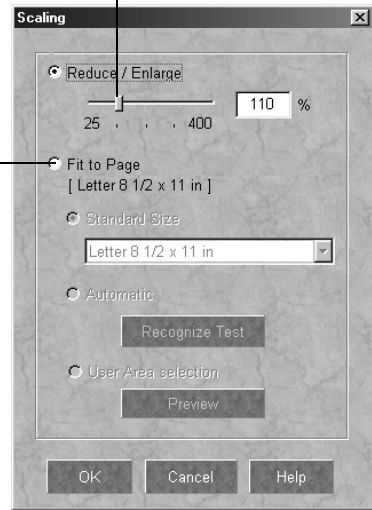

2. If you don't need to preview the image, use the slider to reduce or enlarge it by an exact percentage. Then click OK to return to the control panel.

3. If you want to select a standard page size or preview the image, select **Fit to Page**. You see this window:

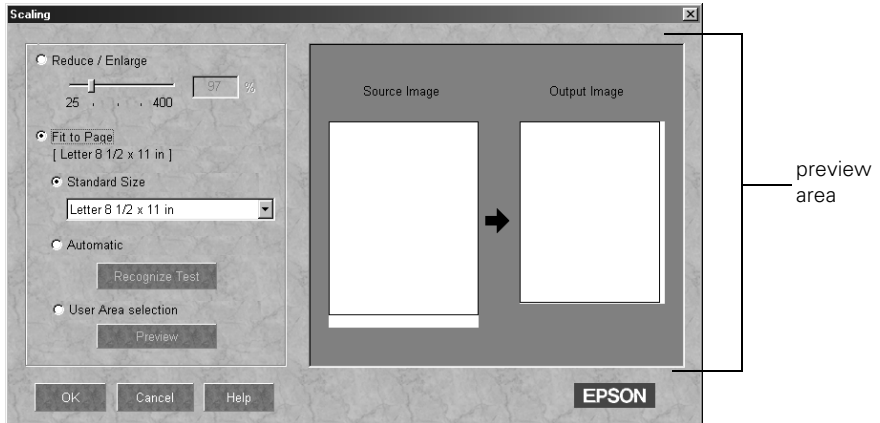

4. Do one of the following:
 - Choose a page size from the **Standard Size** list. Continue with step 6.
 - If you want the software to automatically detect the correct image size, click **Automatic**, then click **Recognize Test**. A preview of your **Output Image** appears in the preview area beside your **Source Image**. Continue with step 6.
 - To adjust the **Output Image** manually, click **User Area selection**, and then click **Preview**. You see a preview of your **Source** and **Output Images** in the preview area. Continue with the next step.
5. Do one of the following:
 - To resize the image manually, click and drag the frame around the **Output Image**. Release the mouse when the image is the correct size.
 - To define the area you want to copy, click and drag the frame around the **Source Image**. The results are immediately visible in the **Output Image**.
6. Click **OK** to return to the **Copy Utility** control panel.

note:

When you make changes via the More settings button, the Document Type on the Copy Utility's control panel automatically changes to User Setting. If you change to a different Document Type, you will lose your settings unless you save them. See page 34 for instructions on saving your settings.

Making Advanced Settings

You can automatically enhance your photograph or text, adjust a photo layout, apply a blue or sepia tint, change your image's brightness, contrast, and saturation, and collate multi-page copies via the More settings button. Follow the instructions in the sections below.

Using Automatic Enhancements

To automatically enhance photographs or text, follow these steps:

1. Click **More settings** on the Copy Utility control panel. You see this box:



Click the arrows to see additional options.

2. On the **Imaging** tab, select **Enhanced Copy**, if necessary.
3. To optimize the quality of your copy automatically, select **Automatic Document Enhancement** and click the arrow. You see this box.



4. Select the option that best describes your source document and click **OK**. You return to the Imaging tab.

Using an Automatic Photo Layout

If you're copying a photograph and want to adjust the layout automatically, follow these steps:

note:

If Automatic Photo Layout is grayed out, click the arrow on Automatic Document Enhancement. Make sure Photograph is selected, then click OK to return to the Imaging tab.

The number of copies of an image you can fit on a page depends on the image size and page size. You may need to reduce the size of your images to fit several copies on a page.

1. Click **More settings** on the Copy Utility control panel.
2. On the **Imaging** tab, select **Enhanced Copy**, if necessary.
3. Select **Automatic Photo Layout** and click the arrow. You see this box:



4. Choose one of the following options:
 - **Straighten Only** automatically straightens your image on the page.
 - **Maximum Enlargement** enlarges the image to the maximum size that fits on the page.
 - **Extra Copy** fits multiple copies of the image on a page.
5. Click **OK**. You return to the Imaging tab.

Adding a Monotone Tint

If you want to produce a copy in a single color tint, follow these steps:

1. Click **More settings** on the Copy utility control panel.
2. On the **Imaging** tab, select **Enhanced Copy**, if necessary.

3. Select **Monotone Conversion** and click the arrow. You see this box:



4. Choose the tint you want to add to your copy and click OK. You return to the Imaging tab.

Adjusting Colors and Collating Multiple Copies

To adjust the colors in your image or to collate multi-page copies when using the automatic document feeder, follow these steps:

1. Click **More settings** on the Copy utility control panel.
2. Click the **Color Setting** tab:

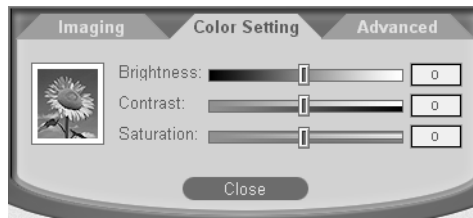

3. To adjust colors, use the sliders to adjust the following settings:
 - **Brightness** controls the amount of light in the image.
 - **Contrast** defines the degree of difference between light and dark extremes in the image's colors.
 - **Saturation** determines the intensity of color. The greater the saturation, the less gray in the color.

4. If you're using the automatic document feeder and you selected **Multi-page Document** as the Document Type setting, you see the **ADF Feature** options. If you want to collate copies of multi-page documents into sets, select **Collate Order**. If not, leave **Normal Order** selected.
5. Click **Close** when you're done. You return to the Copy Utility control panel.

Adding Time Stamps and Watermarks

Follow these steps to create a time stamp or watermark:

1. Click **More settings** on the Copy utility control panel.
2. Click the **Advanced** tab. You see this box:

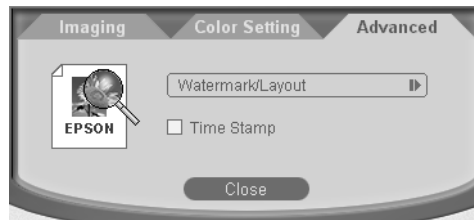

3. If you want to show the printing date and time on your copy, select **Time Stamp**. (The date and time come from your computer's clock.)
4. To add a watermark, click the arrow next to **Watermark/Layout**. A message appears asking you to choose **Layout** on the printer software window.

- Click OK. Your printer driver opens and you see one of the following printer settings windows:

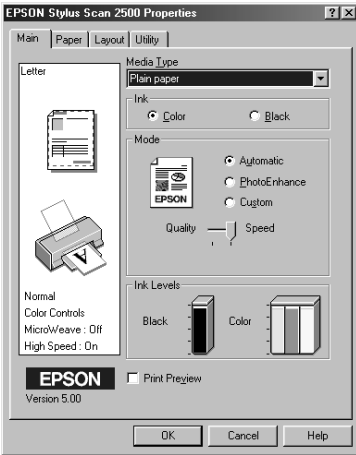

Windows

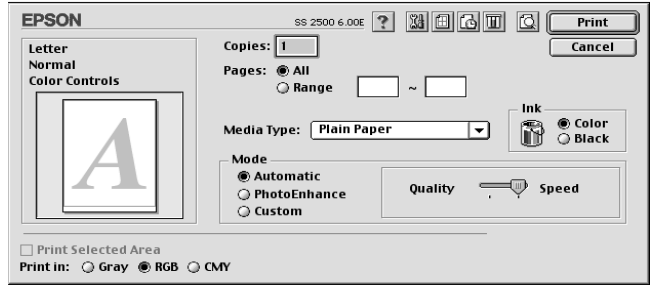

Macintosh

- Click the **L** Layout tab to open the Layout window.
- Click the  Layout icon to open the Layout window.

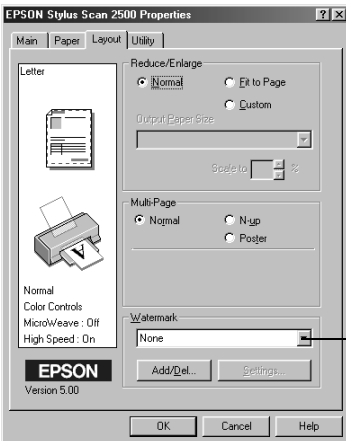

Windows

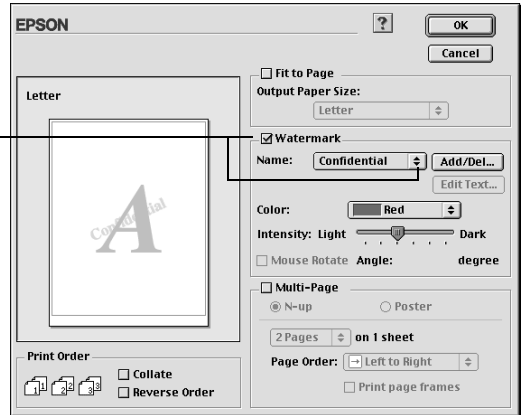

Macintosh

- Click the arrow in the **Watermark** selection box and select a predefined watermark from the list.
- Click the **Watermark** checkbox, then select a predefined watermark from the list.

8. If you want to change the color, position, size, or density of the watermark, do one of the following:

W Click **Settings**. You see the Watermark window. Make any changes you want and click **OK**.

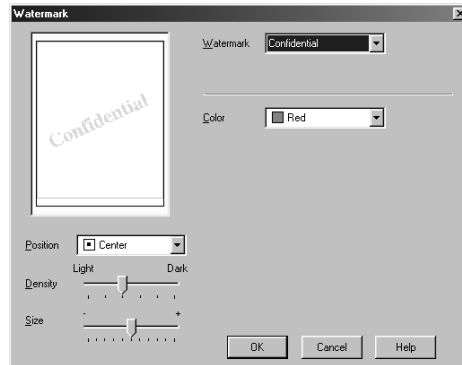

M Change the watermark settings on the Layout window and click **OK**. You return to the printer settings window.

W 9. Click **OK** again to close the Properties window.

M Click **Print** to close the printer settings window.

You return to the Advanced tab in the Copy Utility control panel.

10. Click **Close**. You return to the Copy Utility control panel.

Saving Advanced Settings

You can save your advanced settings as a user-defined document type. Then, when you want to use the same settings again, select your new document type in the **Document Type** list.

Follow these steps to save your settings:

1. After you're finished making changes to your settings, click **Save Settings** on the Copy Utility control panel. You see the Document Type Setting box:



Type a name for your document type here.

2. Type a name in the **Name** box and click **Save**.
3. Click **Close**. You return to the Copy Utility control panel. The name you entered is added to the **Document Type** list on the control panel.

If you later decide to delete a user-defined document type, just click **Save Settings**, select the document type you want to delete, and click **Delete**.

2

Printing

Printing with your EPSON Stylus Scan 2500 is a lot like using any other printer; just click the **Print** button (or select **Print** from the File menu) in any Windows or Macintosh program. For printing photographs in a variety of creative layouts, you can use Photo Print (Windows) or PrintFun (Macintosh) in the EPSON Smart Panel.

To print with your EPSON Stylus Scan, follow the instructions in these sections:

- Choosing the right paper and printer settings
- Handling paper
- Basic printing with Windows
- Basic printing with a Macintosh
- Printing with special settings
- Using Photo Print (Windows)
- Using PrintFun (Macintosh)

Choosing the Right Paper and Settings

No matter how you print, you need to remember two things:

- Use the right paper
- Choose the right printer settings

You may be surprised at how much difference your paper and printer settings can make. Plain paper is fine, but special photo and ink jet papers, like those in the Media Pack that came with your printer, are even better.

Your printer adjusts itself for each type of paper, which is why the Media Type setting in your printer's software is so important. Although you only need to make a few basic settings, such as ink color and paper size, you may want to experiment with your printer software's advanced settings. These allow you to fine-tune your printouts for professional results. See "Printing with Special Settings" on page 44 for details.

Handling Paper

For the most vivid colors and sharpest text, always use EPSON's special ink jet papers. You can demonstrate the difference for yourself by experimenting with the Media Pack that came with your EPSON Stylus Scan.

To load paper, slide out the left edge guide and place the stack of paper against the right side of the sheet feeder. Then slide the left edge guide against the paper.

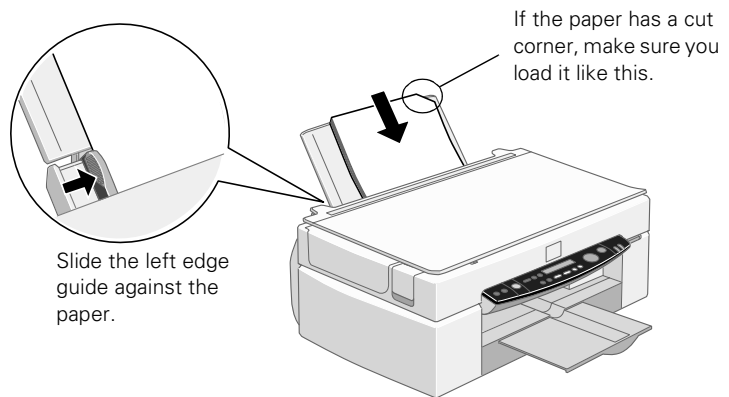

Follow these guidelines for loading paper:

- Always load the printable side (the whiter and brighter side) face up. Some special papers come with a cut corner to help you load them correctly.
- Load letterhead or preprinted paper so the top of the paper feeds into the printer first.

note:

For limitations on other special papers, see the Printer section of your electronic EPSON Stylus Scan 2500 Reference Guide.

- Don't load paper above the arrow on the left edge guide.
- You can load up to 20 sheets of Photo Paper, 30 transparencies, or 30 Photo Quality Ink Jet Cards. For Photo Quality Ink Jet Paper, you can load up to the arrow mark on the left edge guide.
- Use a support sheet if you find it in the paper package.
- Return unused paper to the original package as soon as you finish printing.

Printing on Photo Paper

You can use the EPSON Photo Paper that came in your Media Pack to print photographs that look almost as good as the ones you get from film processing. EPSON 4 × 6-inch Photo Paper is micro-perforated around the edges so you can trim your printouts and “bleed” the photo—extend it to the edge of the paper—on all sides.

You'll also find letter-size Photo Paper in your Media Pack. In addition, Photo Paper is available in A4 (8.3 × 11.7 inches) and panoramic (8.27 × 23.4 inches) sizes.

Whatever size of Photo Paper you choose, select **Photo Paper** as the Media Type and select the correct Paper Size before you print.

Keep the following in mind when you use EPSON 4 × 6-inch Photo Paper:

- You can load up to 20 sheets of Photo Paper at a time.
- Before you print, size your photo to 4.25 × 6.25 inches.
- After you print, fold the paper back and forth along the perforations and carefully tear off the margins.

For optimal results and longer print life, print your digital photos on EPSON Photo Paper. See the inside back cover for a list of EPSON papers and ordering information. For complete instructions on using all of EPSON's special ink jet papers, see the electronic *EPSON Stylus Scan 2500 Reference Guide*.

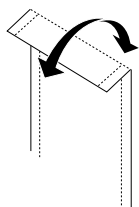
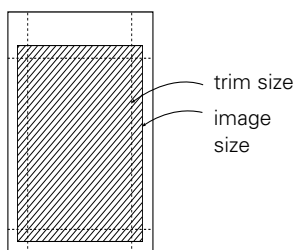

Printing on Envelopes

You can print on almost any kind of envelope. Load up to 10 envelopes in the printer's sheet feeder, flap edge first, with the flap side down. Slide the left edge guide against the envelope's edge.

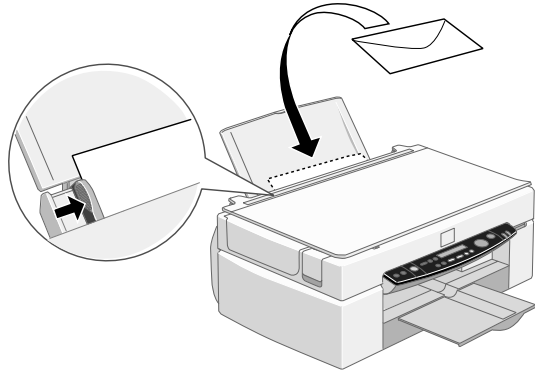

Set the paper thickness switch to the + position. (Return the switch to the 0 position before you print on regular paper.)

note:

Be sure to select Plain paper as the Media Type setting and select the correct envelope size before you print.

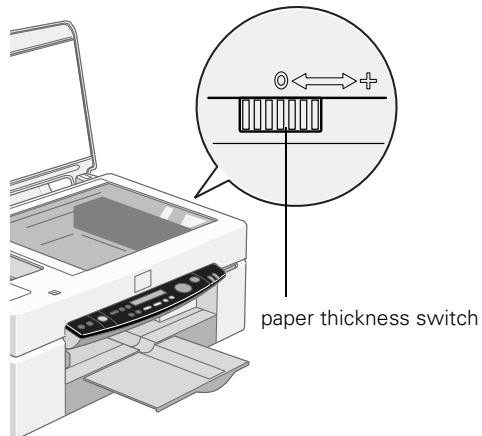

W *Basic Printing with Windows*

note:

For more information on printing, see the electronic EPSON Stylus Scan 2500 Reference Guide.

You can print any type of document from any Windows program following the steps in this section.

Before you start, make sure the EPSON Stylus Scan is set up, connected to your computer, turned on, and the software is installed. See the *Start Here* sheet for instructions.

1. Load paper as described on page 36.
2. Open the File menu and click **Print**. You see windows like those below.

(If you click the **Print** button on your screen you may not see a print window.)

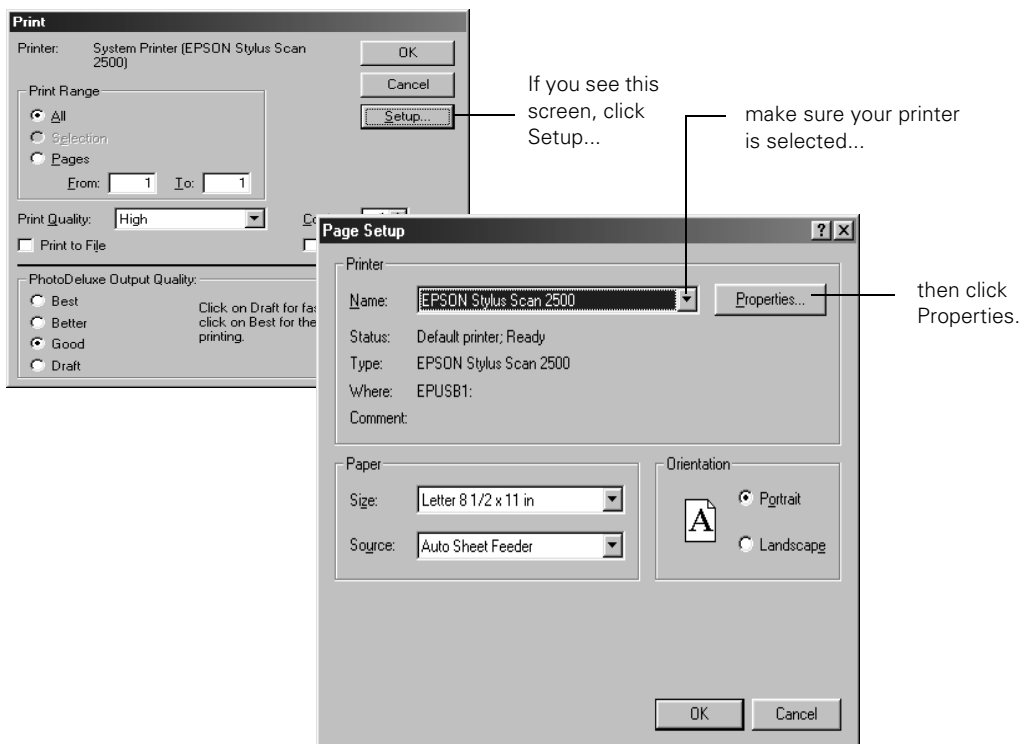

- After you click the **Properties** button, you see the EPSON Stylus Scan 2500 Properties window:

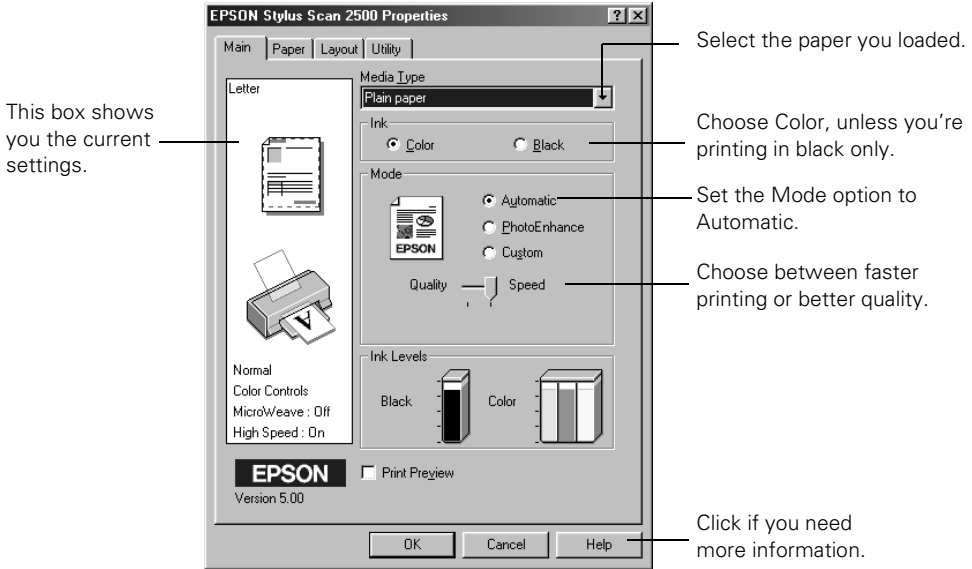

Choose the settings noted above. If you're not sure which Media Type to choose, see page 48.

- Click the **Paper** tab at the top of the box if you need to change the paper size, number of copies, page orientation, or printable area.

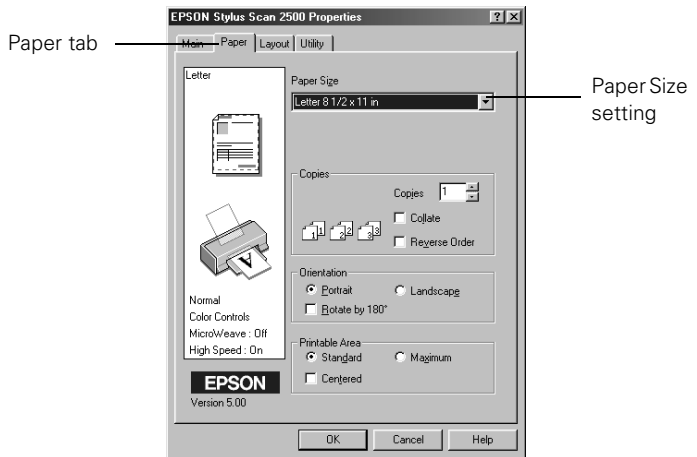

note:

The settings in the *Paper and Layout* tabs are often available in your application software. If so, you should select them there instead.

Click the *Help* button for more information about any setting. Or check the electronic EPSON Stylus Scan 2500 Reference Guide, as described on page 5.

- Click the **Layout** tab if you want to do any of the following: reduce or enlarge your printed image, print multiple pages on one sheet of paper, “tile” an image to make a large poster, or add a watermark.

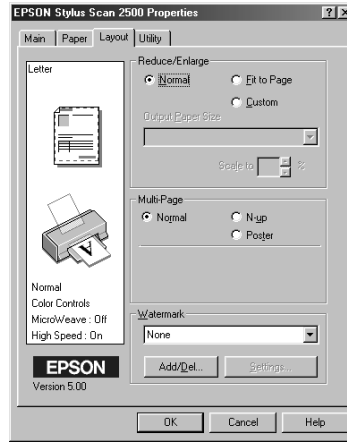

- Click **OK** until you see the Print window again. To start printing, click **OK** or **Print**, depending on your application.

After a moment, the Progress Meter window appears. You can cancel, pause, or restart your print job. You can also see how much ink you have left and view printing tips.

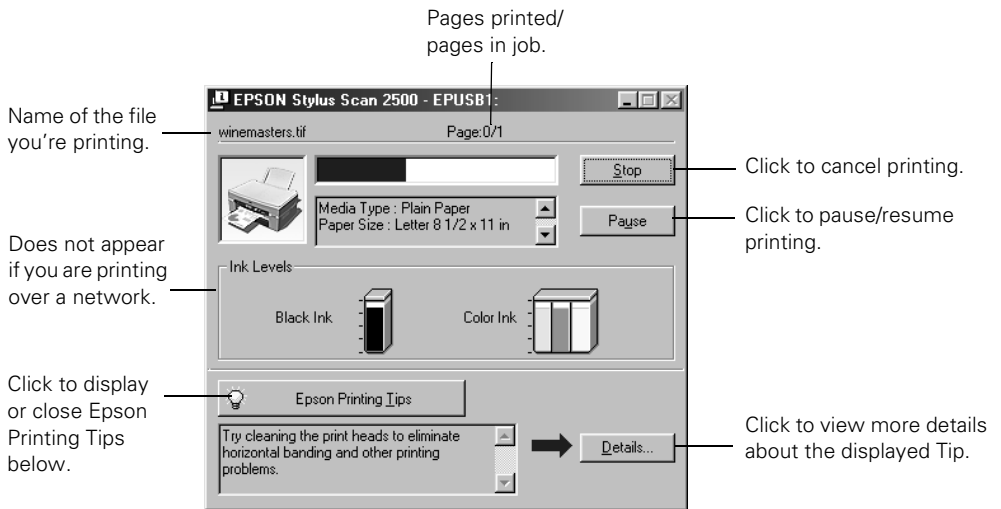

M *Basic Printing on a Macintosh*

You can print any type of document from any Macintosh program, following the steps in this section.

Before you start, make sure the EPSON Stylus Scan is set up, connected to your computer, turned on, and the software is installed. Also, make sure you've selected **SS 2500** in the Chooser. See the *Start Here* sheet for instructions.

1. Follow the instructions for loading paper on page 36.
2. Open the File menu and click **Page Setup** (or **Print Setup**). You see a Page Setup window like this:

note:

Click the Help icon for more information about any setting. Or check the electronic EPSON Stylus Scan 2500 Reference Guide, as described on page 5.

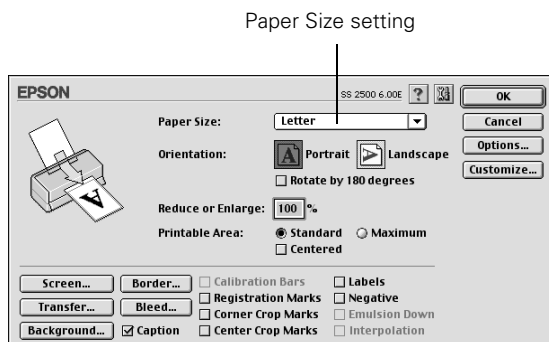





3. Choose your paper size, page orientation, and printable area as necessary. Then click **OK**.

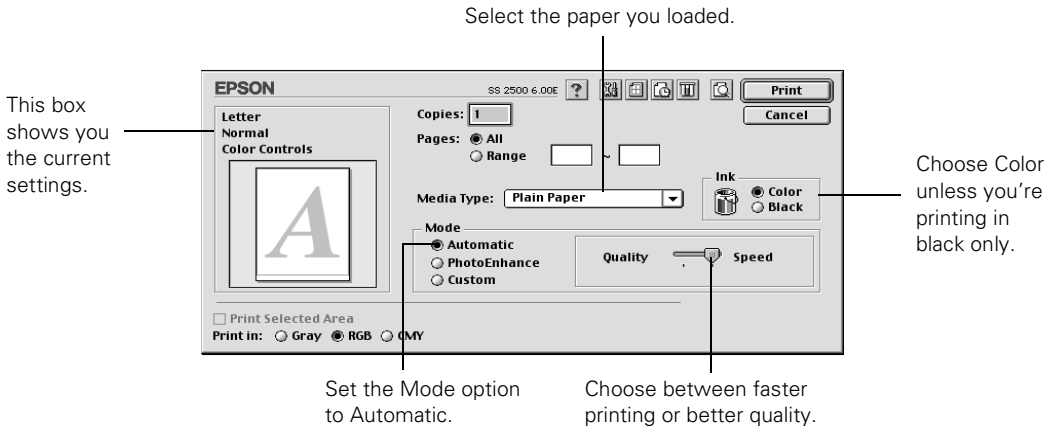

4. Now open the File menu and choose **Print**. You see the Print Options window.

(If you click the **Print** button on your screen you may not see a print window.)



5. Choose the settings noted above. If you're not sure which Media Type to choose, see page 48.
6. You can also do the following:
 - Click the  Layout icon to reduce or enlarge your image, print multiple page layouts, or add a watermark.
 - Click the  Background Printing icon to prioritize printing of your print job.
 - Click the  Preview icon to change the **Print** button to **Preview**. You can then click it to preview your printout.
 - Click the  Ink icon to check your ink levels.
7. Click **Print** to start printing.

If you turned on background printing, EPSON Monitor3 begins. To display the EPSON Monitor3 window, select EPSON Monitor3 in the Macintosh Application menu.

In addition to viewing your print job's progress, you can cancel , pause , or restart  your print job from this window.

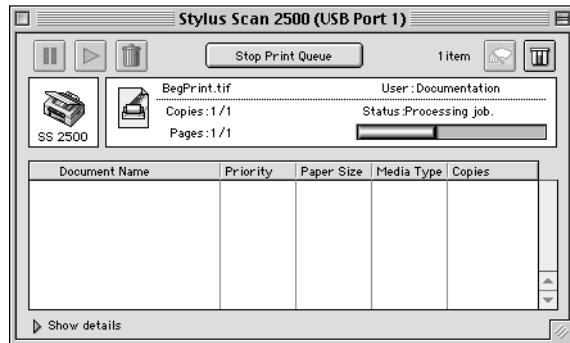

Printing with Special Settings

You can choose special settings for photographs and other types of print jobs, or customize advanced printing features to fit your needs. This section covers the following special settings for both Windows and Macintosh:

- Enhancing photographs
- Using custom project types
- Using advanced print settings

Enhancing Photographs

If you have low resolution photographs, special print settings can improve their appearance. Although you can also edit your photos with PhotoDeluxe, the changes you make are permanently applied to your photos. When you use your print settings, it only affects the printout, not the photo itself.



Windows

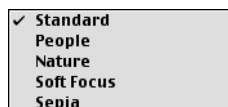

Macintosh

1. Open your EPSON Stylus Scan 2500 Properties window (Windows; see page 39) or Print options (Macintosh; see page 43).
2. Set the Media Type for the paper you're printing on, then choose the **Color Ink** setting.
3. Click **PhotoEnhance**, then click **Standard** to display the available settings, as shown at the left.
4. Choose **Standard** for most photos, or experiment with the other settings.
5. Select any other settings you need to change, then:
W Click OK until you see the Print window again. Then click OK (or Print) to start printing.
M Click Print to start printing.

Using Custom Project Types

Custom project types let you choose settings for presentation graphics, ink savings, or color matching. Some project types may not be available, depending on your operating system and other settings you choose.

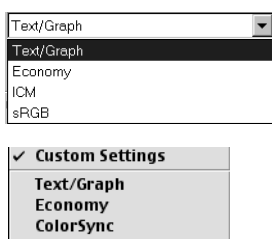

1. Open your EPSON Stylus Scan 2500 Properties window (Windows; see page 39) or Print options (Macintosh; see page 43).
2. Select the Media Type setting for your paper, then choose **Color** or **Black Ink**.
3. Click the **Custom** button, then click the **Custom Settings** list. You see a list of custom project types, as shown to the left.

Select one of the types listed below:

- **Text/Graph:** For printing graphics-intensive documents like presentations with charts and graphs.
 - **Economy:** For rough drafts on plain paper. Saves ink.
 - W** ■ **ICM:** (Image Color Matching; Windows only)
For printing documents created in an ICM compatible application, and for matching monitor colors as closely as possible.
 - W** ■ **sRGB** (standard Red Green Blue; recommended for Windows 98 only): For printing documents created in an sRGB compatible application using sRGB colors, such as those designed for the Web. See your Windows 98 online help for details.
 - M** ■ **ColorSync** (Macintosh only): For printing documents in conjunction with ColorSync® compatible devices and applications.
4. Select any other settings you need to change, then:
- W** Click **OK** until you see the Print window again. Then click **OK** (or **Print**) to start printing.
 - M** Click **Print** to start printing.

note:

For instructions on using all your printer software's advanced settings, see the electronic EPSON Stylus Scan 2500 Reference Guide, as described on page 5.

Using Advanced Print Settings

For maximum control over your projects, you can use advanced settings. You can even save your advanced settings as a group so you can use them whenever you print a similar project.

1. Follow the instructions in the previous section to open your EPSON Stylus Scan 2500 Properties window (Windows) or Print options (Macintosh).
2. Select the correct Media Type setting for your paper, then choose **Color** or **Black Ink**.

- Click the **Custom** button, then click the **Advanced** button. You see the Advanced window:

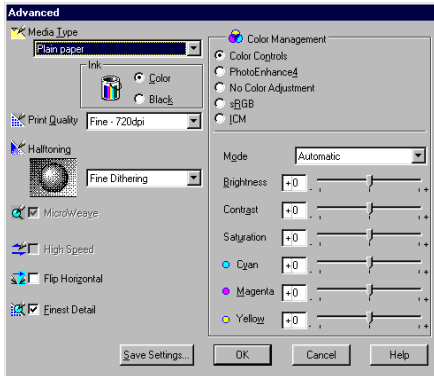

Windows

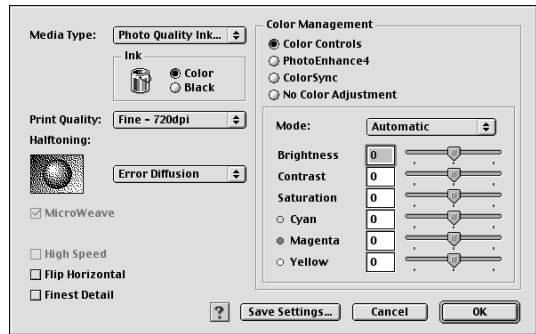

Macintosh

tip:

*After you customize your print settings, you can save them as a group. Then you can reuse them whenever you print a similar project. Click **Save Settings** in the **Advanced** window. Type a name for your setting group and click **OK**.*

W

M

- Check the **Media Type** and **Ink** settings. These are the same as the ones you selected on the main printer software screen. You can change them here as you customize your settings, if needed.
- Choose a **Print Quality** (resolution) setting.
- Select a **color management system** (the availability depends on your operating system).
- Select any other settings you need to change, then:
 - W** Click **OK** until you see the **Print** window again. Then click **OK** (or **Print**) to start printing.
 - M** Click **OK** to return to the **Print options** window. Then click **Print** to start printing.

Choosing the Right Settings for EPSON Papers

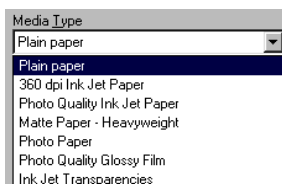

You need to choose the right Media Type setting so your EPSON Stylus Scan can adjust the ink coverage accordingly. This ensures that you'll get the best print results on any kind of paper.

Before you print, always check your Media Type setting. Here are the settings you should choose for EPSON paper:

For this paper . . .	Select this Media Type setting . . .
Plain paper sheets or envelopes	Plain paper
EPSON 360 dpi Ink Jet Paper	360 dpi Ink Jet Paper
EPSON Iron-On Cool Peel Transfer Paper	
EPSON High Quality Ink Jet Paper	Photo Quality Ink Jet Paper
EPSON Photo Quality Ink Jet Paper	
EPSON Photo Quality Ink Jet Cards	
EPSON Photo Quality Self Adhesive Sheets	
EPSON Matte Paper – Heavyweight	Matte Paper – Heavyweight
EPSON Photo Paper	Photo Paper
EPSON Photo Quality Glossy Paper	
EPSON Photo Quality Glossy Film	Photo Quality Glossy Film
EPSON Photo Stickers	
EPSON Ink Jet Transparencies	Ink Jet Transparencies

For the EPSON Photo Paper that came in your Media Pack, choose **Photo Paper**. For the ink jet paper in your Media Pack, choose **Photo Quality Ink Jet Paper**.

W *Using Photo Print (Windows)*

The easiest way to print photographs is to use Photo Print on the EPSON Smart Panel (Windows only). You can print on special snapshot-size paper (like the 4 × 6-inch EPSON Photo Paper in your Media Pack), create enlargements, or print several small pictures on one sheet.

You start by scanning in one or more pictures or opening images that are already saved on your computer.

First, make sure your printer is set up, connected to your computer, turned on, and the software is installed. Then follow the instructions under “Scanning in Your Photo” below, or “Opening Images on Your Computer” on page 52.

Scanning in Your Photo

1. Place your photo(s) face down with the first one in the upper right corner of the document table. Line up the edges of the photo with the scales bordering the document table. If you have more than one photo, leave a little space between each one.
2. Click the  Smart Panel icon on the Windows task bar to open the Smart Panel. Then click the **Photo Print** icon. You see the Photo Print welcome.
3. Click **Start**. The Photo Print window opens:

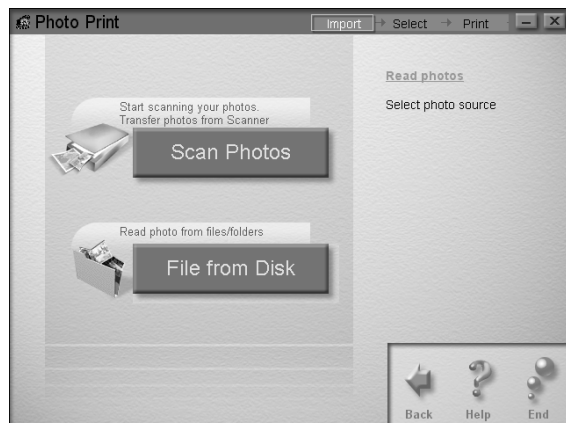

4. Click **Scan Photos**. You see this window:

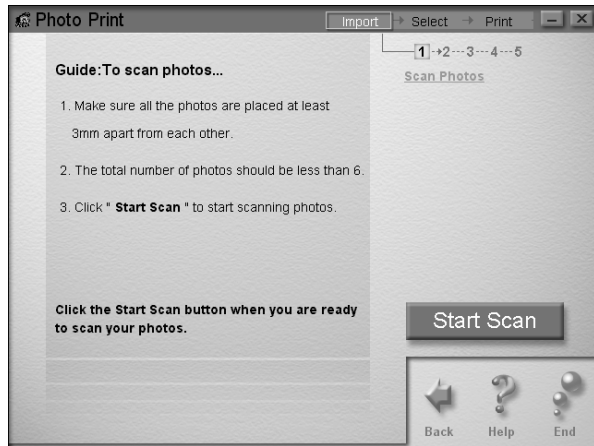

5. Click the **Start Scan** button on your screen to scan your photo. When scanning is finished, you see a window like this on your screen:



6. If you want to scan more photos, click **Yes** and repeat steps 4 and 5 above. If you're finished scanning, click **No**. You see your photo(s) in a window like this:

For a closer look, double-click an image to open it in the Image Viewer window. See page 88 for more information.

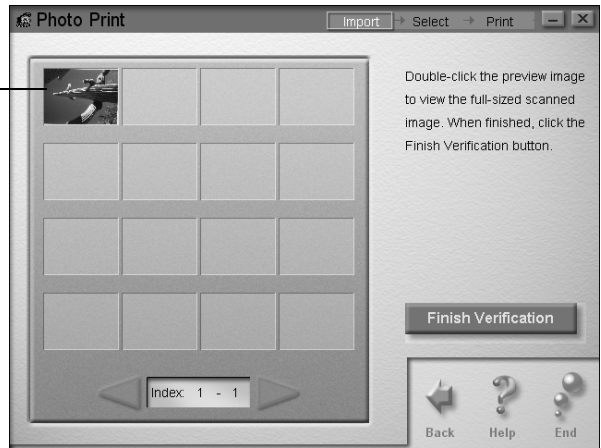

7. Click **Finish Verification**.

Then continue with the steps in "Printing Your Photos" on page 53.

Opening Images on Your Computer

1. Click the  Smart Panel icon on the Windows task bar to open the Smart Panel. Then click the **Photo Print** icon. You see the Photo Print welcome.
2. Click **Start**. The Photo Print window opens:

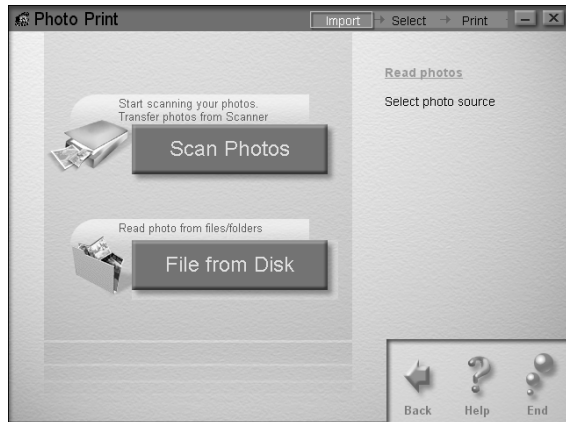

3. Click **File from Disk**. You see a Select Folder window:

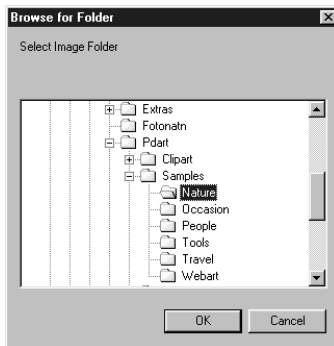

4. Locate the folder where your image(s) are stored. Then click **OK**. You see your image(s) displayed briefly on the screen. Then you see the Photo Print selection window. Continue with the instructions in the next section.

Printing Your Photos



You can choose to print one copy of all the scanned or opened images, or you can set the number of prints for each image.

- If you click **Select All**, you see the layout window. Continue with step 1 on page 54.
- If you click **Specify number of prints**, you can click an image, and then use the up and down arrows to set the number of prints for each image, as shown below.

Click here to increase the number of prints for an image.

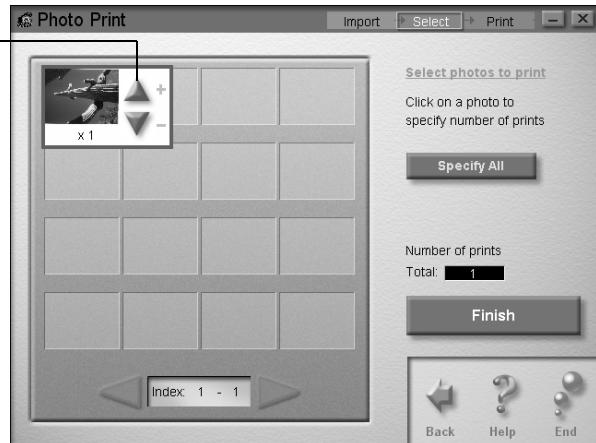

When you've set the number of prints you want for each image, click **Finish**. You see the layout window:

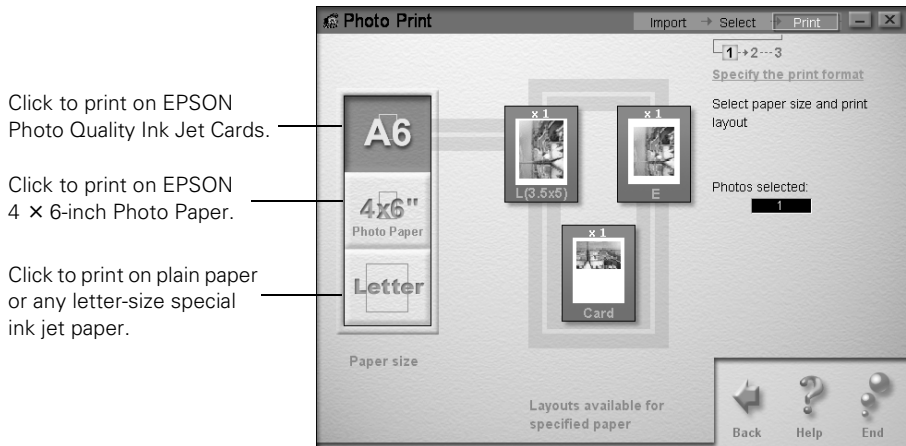

note:

See page 36 for instructions on loading and handling paper.

1. Click the button for the paper you're printing on. You can choose from three different paper sizes:
 - **A6**, for printing on EPSON Photo Quality Ink Jet Cards (or similar size paper)
 - **4 x 6**, for printing on 4 x 6-inch EPSON Photo Paper
 - **Letter**, for printing on letter-size plain paper or any type of special paper.

You see several layout choices, depending on which paper you're using.

If you click **Letter**, for example, you see the following:

Displays the number of sheets you'll need to print your photos in that layout.



2. Click the layout that you want to use for printing. On a letter-size sheet, for example, you can have 1, 2, 3, 6, or 8 prints per page, depending on the size print you want.

If you are only printing one image, you can have up to 8 copies of the picture on one sheet. If you're printing several images, you can print each one on a separate sheet (enlarged), or combine them.

After you click the layout you want, you see this window:

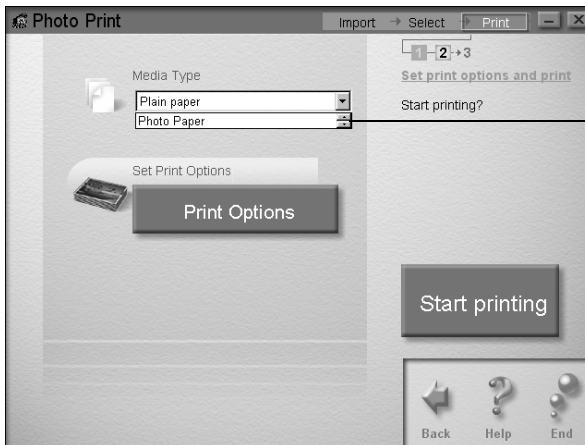

Click here to scroll through the Media Type list.

note:

Your printer automatically adjusts the ink coverage according to the Media Type setting you choose.

For complete instructions on using all of EPSON's special ink jet papers, see the electronic EPSON Stylus Scan 2500 Reference Guide.

3. Click **Plain Paper**, then click the small arrows at the right to scroll through the Media Type list. Choose the right Media Type for the paper you're printing on, For example:

- Choose **360 dpi Ink Jet Paper** if you're printing on EPSON 360 dpi Ink Jet Paper.
- Choose **Photo Quality Ink Jet Paper** for EPSON Photo Quality Ink Jet Paper (like the ink jet paper that came in your Media Pack) or EPSON Photo Quality Ink Jet Cards.
- Choose **Matte Paper – Heavyweight** if you're printing on EPSON Matte Paper – Heavyweight.
- Choose **Photo Paper** if you're printing on EPSON Photo Paper.

For a list of EPSON papers and their corresponding Media Type settings, see page 48.

4. After you choose your Media Type, click **Print Options**. You see this window:

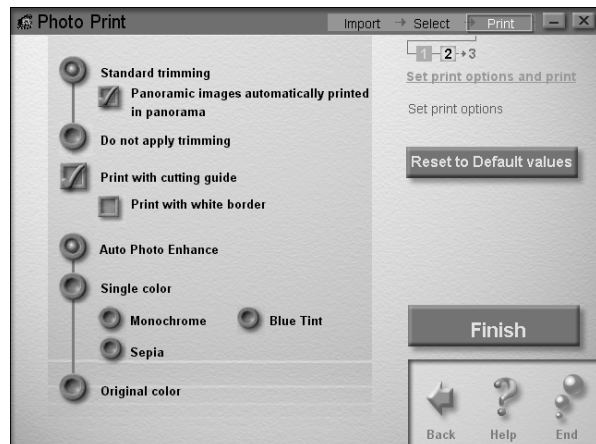

5. Choose from the following settings (not all settings are available for all paper sizes and layouts):
 - **Standard trimming**, which automatically crops and enlarges your photo slightly to fit the layout, or **Do not apply trimming**.
 - If you chose **Standard trimming**, you can select **Print with cutting guide** to print a cutting guideline around your images. You can then select **Print with white border** to add a white border between your image and the cutting guideline, if you want.
 - Choose an enhancement option: **Auto Photo Enhance** (to increase contrast and sharpness), **Single color** (for one of three special effects), or **Original color** (to retain the image's original colors).
6. When you're done making settings, click the **Finish** button. You return to the Photo Print printing window. Click **Start Printing** to print your photo(s).

After a moment, the Progress Meter window appears, as shown on page 41.
7. When you're finished printing, click **End** to close Photo Print.

M *Using PrintFun (Macintosh)*

The easiest way to print photographs is to use PrintFun on the EPSON Smart Panel (Macintosh only). You can print on special snapshot-size paper (like the 4 × 6-inch EPSON Photo Paper in your Media Pack), create enlargements, or print several small pictures on one sheet.

You start by scanning in one or more pictures or opening images that are already saved on your computer.

First, make sure your printer is set up, connected to your computer, turned on, and the software is installed. Then follow the instructions under “Scanning in Your Photo” below, or “Opening Images on Your Computer” on page 62.

Scanning in Your Photo

1. Place your photo face down with the first on in the upper right corner of the document table. Line up the edges of the photo with the scales bordering the document table. If you have more than one photo, leave a little space between each one.
2. Open the Apple menu and click **EPSON SMART PANEL** to open the Smart Panel. Then click the **PrintFun** icon. You see the PrintFun welcome.
3. Click **Start**. The PrintFun window opens:



4. Click **Scan Photos**. You see the PrintFun scanning window:

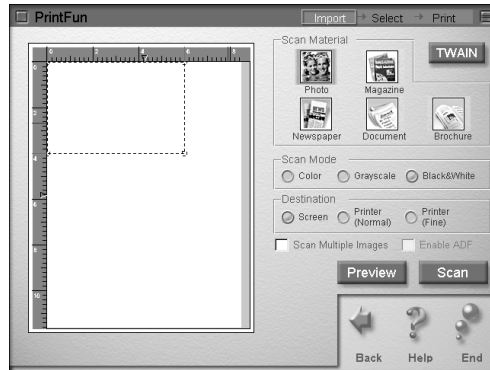

note:

If you're scanning a printed picture that is not a film-processed photograph), make sure you choose Magazine, Newspaper, or Brochure. These settings will give you better scans and eliminate unwanted dot patterns.

5. Select the type of document(s) you're scanning from the Scan Material icons. If the basic settings listed beneath the icons are correct, go to step 8.

To change the basic settings chosen by the Scan Material selection, go to steps 6 and 7.

If you're an advanced user and want more control over your settings, click the TWAIN button. See page 70 for information about using the TWAIN settings.

6. Choose one of the following Scan Mode buttons:
 - **Color:** For any type of document or photo in color
 - **Grayscale:** For black and white photographs or artwork with subtle shading
 - **Black&White:** For text or drawings with no shading.
7. Choose one of the following Destination buttons:
 - **Screen:** For images that will be displayed on the Internet or viewed on the screen only
 - **Printer (Normal):** For text or images that will be printed normally
 - **Printer (Fine):** For photographs or other images that will be printed at the highest quality or resolution (scanning is slower with this setting)

8. If you're using the document table to scan more than one image, click **Scan Multiple Images**.
9. If you're using the optional automatic document feeder, click **Enable ADF**. Then go to step 12.

If you're not using the automatic document feeder, go to step 10.

10. Click the **Preview** button. The EPSON Stylus Scan scans your document and displays a preview in the scan window on your screen:

note:

You can't use the Preview button if you're using the optional automatic document feeder.

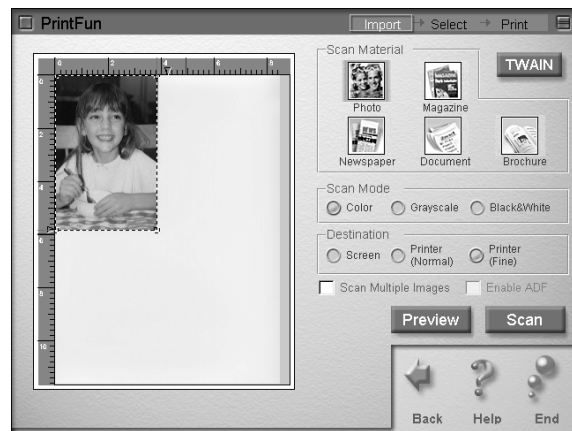

11. Click and drag the dotted-line border on the preview to define the area you want to scan. You can adjust any of your other settings at this point.
12. When you're satisfied that the settings are correct, click the **Scan** button. Your original document is scanned.

If you selected **Scan Multiple Images**, a message appears asking if you want to continue scanning.

13. If you click **Yes** to scan more images, click inside the dotted line border on the first preview image and move it to the next image. Size the border as necessary and repeat step 12.

If you click **No**, go to step 14.

14. When scanning is completed, you see a window like this:

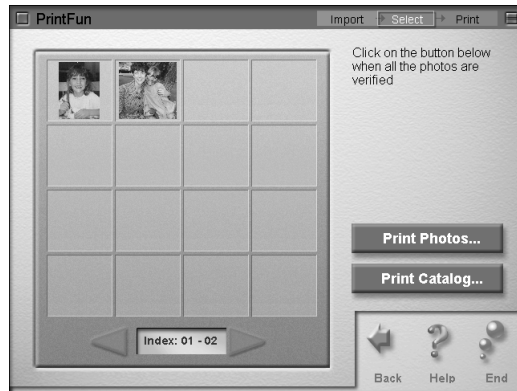

If you want to print individual photos, click the **Print Photos** button. After a moment, the Presto! PrintFun - Photo window opens. Continue with “Printing Your Photos” on page 63.

If you selected multiple images and you want to print them all on one sheet of paper (like a proof sheet), click the **Print Catalog** button. The Presto! PrintFun - Catalog window opens. Continue with “Printing a Catalog of Your Photos” on page 66.

Opening Images on Your Computer

1. Open the Apple menu and click EPSON SMART PANEL to open the Smart Panel. Then click the PrintFun icon. You see the PrintFun welcome.
2. Click Start. The PrintFun window opens:



3. Click File from Disk. You see the Select Image Files' Folder window.

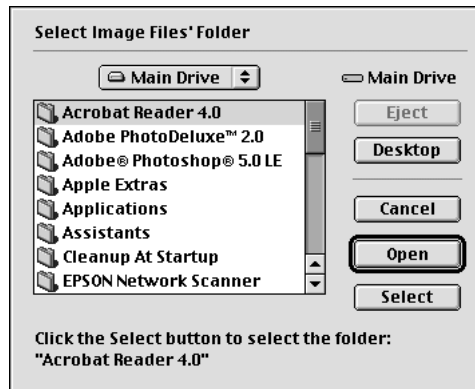

4. Locate your image folder. Then click Open. You see your image(s) displayed briefly on the screen. Then you see the Presto! PrintFun - Photo window described in the next section.

Printing Your Photos

You can choose to print one copy of all the scanned or opened images, or you can set the number of prints for each image.

1. Scan your photos or select your files as described in the previous sections.
2. From the PrintFun index window, click **Print Photos**. You see the PrintFun - Photo window:

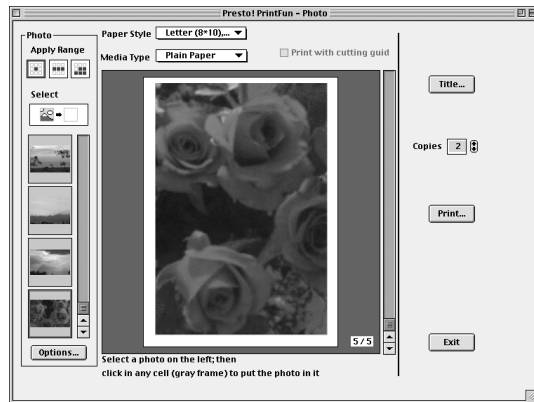

3. Select your paper size and desired layout from the **Paper Style** list. You can choose from a variety of different paper sizes.

Each size has multiple layouts to choose from. On a letter-size sheet, for example, you can have 1, 2, 3, 6, or 8 prints per page, depending on the size print you want.
4. To add photos, click the image thumbnail on the left and then click the frame where you want the photo to appear. (You can replace the existing photos with different ones.)

5. Select your paper from the **Media Type** list. You can select one of the following settings:
 - Plain Paper
 - 360 dpi Ink Jet Paper
 - Matte Paper - Heavyweight
 - Photo Paper
 - Photo Quality Glossy Film
 - Ink Jet Transparencies
6. Select the number of copies by clicking the arrow buttons. (The number of copies applies to all the pages, so if you have three pages of images and you choose 2 copies, you'll print six pages.)
7. To add a title to the top of all your pages, click the **Title** button. Type your title in the box. You can also change the font for your title. Click **OK** when you are done.
8. To rotate your photo or change other layout settings, click the **Option** button. You see the following window:

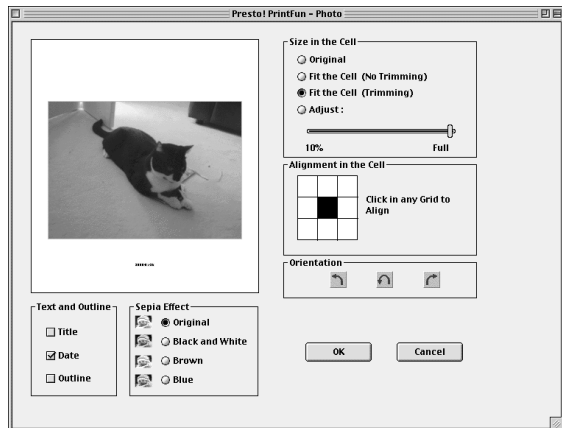

9. Make any changes you want as described below (the preview reflects your selections):
 - Add a **Title**, **Date**, or **Outline** to your photo by clicking the corresponding boxes to select them.
 - Add a color effect to your image by clicking **Black and White**, **Brown**, or **Blue**.
 - Resize the image in its cell by selecting one of the following: **Original**, **Fit the Cell (No Trimming)**, **Fit the Cell (Trimming)**, or **Adjust**. If you select **Adjust**, you can drag the slider to resize the image to an exact size.
 - Align the image to a specific part of the cell by clicking one of the nine squares in the grid.
 - Rotate the image to the left or right by 90 degrees, or rotate it 180 degrees by clicking the arrows under **Orientation**.
10. When you're finished making settings, click **OK**.
11. Click **OK** to apply your changes to the current photo or click **All Photos** to apply your changes to all the photos.
12. Click **OK** to return to the main window.
13. When you are finished with all your settings, click **Print**. Your EPSON Stylus Scan prints your photos.
14. Click **Exit** at the PrintFun - Photo window.
15. Click **Exit** if you're finished printing, or one of the other buttons to continue.

Printing a Catalog of Your Photos

You can print out a catalog of all your scans to use for reference or to see your images before you print them. Follow these steps:

1. Scan your photos or select your files as described in the previous sections.
2. From the PrintFun index window, click the **Print Catalog** button. You see the PrintFun - Catalog window:

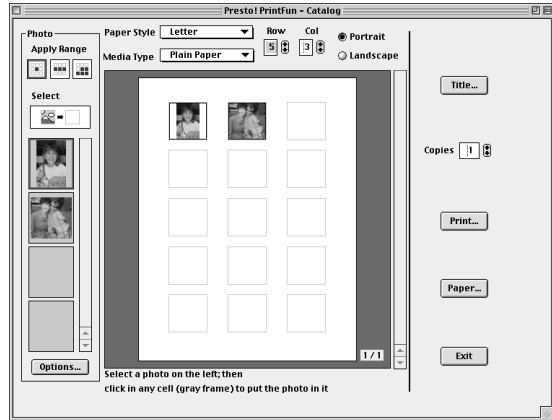

3. To add photos, click the image thumbnail on the left and then click the frame where you want the photo to appear. (You can replace the existing photos with different ones.)
4. Select a paper size from the **Paper Style** list. You can choose from a variety of different paper sizes.
5. Select your paper type from the **Media Type** list. You can select one of the following settings:
 - Plain Paper
 - 360 dpi Ink Jet Paper
 - Matte Paper - Heavyweight
 - Photo Paper
 - Photo Quality Glossy Film
 - Ink Jet Transparencies
6. Select **Portrait** or **Landscape** for the print orientation.

7. Change the number of printouts and their size with the **Row** and **Col** (column) settings. (The settings are reversed when you switch between **Portrait** and **Landscape**.)
8. To add a title, click the **Title** button. Type your title in the box. You can also change the font for your title. Click **OK** when you're done.
9. Select the number of copies by clicking the arrow buttons. (The number of copies applies to all the pages, so if you have three pages of images and you choose 2 copies, you'll print six pages.)
10. If you want to adjust your page margins or layout, click the **Paper** button. Select the settings you want, then click **OK**. In the window that appears, name your settings to create a new **Paper Style** option, then click **OK**. The new option is automatically selected as the current **Paper Style**.
11. To rotate your photo or change other layout settings, click the **Option** button. You see the following window:

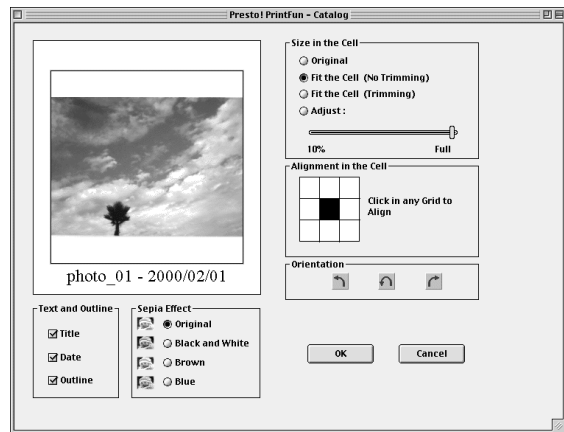

12. Make any changes you want as described below (the preview reflects your selections):
 - Add a **Title**, **Date**, or **Outline** to your photo by clicking the corresponding boxes to select them.
 - Add a color effect to your image by clicking **Black and White**, **Brown**, or **Blue**.
 - Resize the image in its cell by selecting one of the following: **Original**, **Fit the Cell (No Trimming)**, **Fit the Cell (Trimming)**, or **Adjust**. If you select **Adjust**, you can drag the slider to resize the image to an exact size.
 - Align the image to a specific part of the cell by clicking one of the nine squares in the grid.
 - Rotate the image to the left or right by 90 degrees, or rotate it 180 degrees by clicking the arrows under **Orientation**.
13. When you are finished making settings, click **OK** to return to the main window.
14. When you are finished with all your settings, click **Print**. Your EPSON Stylus Scan prints your catalog.
15. Click **Exit** at the PrintFun - Catalog window.
16. Click **Exit** if you're finished printing, or one of the other buttons to continue.

3 Scanning

Scanning with the EPSON Stylus Scan 2500 lets you turn pictures and text into digital files on your computer. Then you can fax or e-mail the files, display them on your web site, or use them to create projects that you can print out.

If you're experienced with scanning, you can use the EPSON Stylus Scan TWAIN interface to scan with applications like Adobe Photoshop® or any other TWAIN-compliant program.

Or, you can use the Smart Panel for all types of scanning with a convenient on-screen control panel.

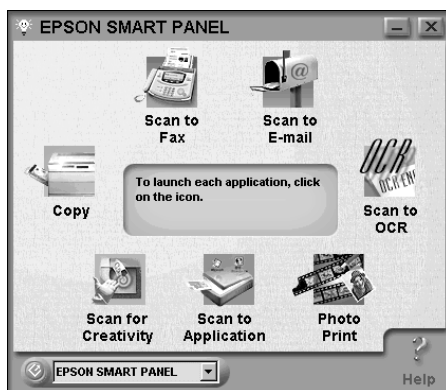

Your EPSON Stylus Scan also offers quick scanning, which lets you send your scan to a Smart Panel application by simply pressing the  Scan button on your scanner's control panel.

You'll find instructions for the following in this chapter:

- Basic scanning with TWAIN
- Scanning to OCR (word processing)
- Scanning to e-mail

- Scanning for creativity (PhotoDeluxe projects)
- Scanning to an application
- Quick scanning

Basic Scanning with TWAIN

The basic scanning process involves a number of steps:

- Placing your photo or page on the document table
- Opening an application (such as PhotoDeluxe or Photoshop)
- Opening the TWAIN window and setting scan options
- Scanning and saving your scanned image

The first time you scan with your EPSON Stylus Scan 2500, you'll also need to select it as your TWAIN source. For detailed instructions on using your EPSON TWAIN software, see your electronic *EPSON Stylus Scan 2500 Reference Guide*.

Starting Your Scan

Before you scan, make sure your scanning software is installed and your EPSON Stylus Scan is set up, connected to your computer, and turned on.

1. Place the document you want to scan face down on the document table. Position it so the horizontal and vertical edges are carefully aligned with the scales on the sides of the document table. Then close the document cover.
2. Start your application, for example, Adobe Photoshop.
3. From the File menu, choose **Import**, then select one of the following:

- W** Select TWAIN 32 Source
- M** TWAIN Select

note:

*The commands you choose in steps 3 and 5 differ from one host application to another. For example, with some host applications you might choose **Acquire** or **Select Source** from the **File** menu instead of **Import**.*

*If you're using PhotoDeluxe, start by clicking **GET AND FIX PHOTO**, then click the arrow below the **Scanners** icon and select **Stylus Scan FB** as your input source. Click the **Scanners** icon to open the **Scanning** tab, then click **Mode** to open the **EPSON TWAIN** window.*

4. Select EPSON Stylus Scan FB and click one of the following:

W Select

M OK

5. From the File menu, choose **Import**, then select one of the following:

W TWAIN 32

M TWAIN Acquire

The EPSON TWAIN window opens. (The Windows screens are shown, but the Macintosh screens are the same.)

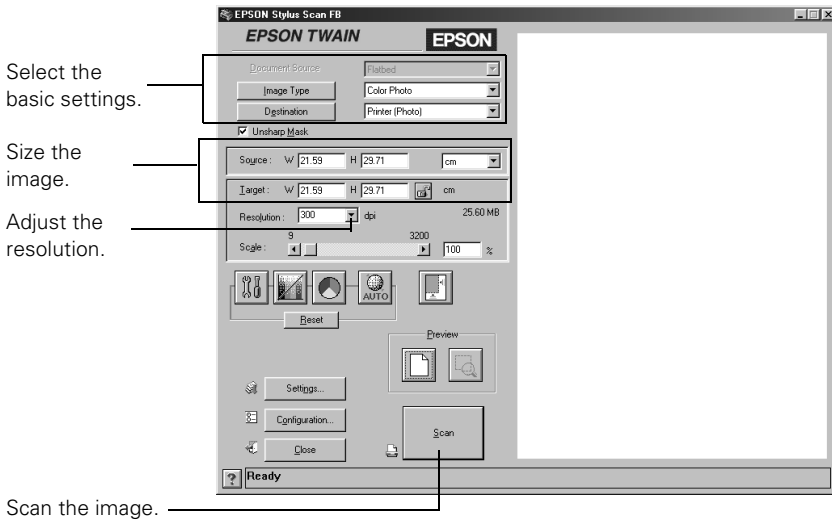

6. Choose the Document Source:

note:

If the optional transparency unit or automatic document feeder are not installed, you won't see those options in the Document Source list.

- Select Flatbed if you're scanning from the document table.
- Select Auto Document Feeder if you're scanning from the optional automatic document feeder.
- Select TPU for Neg. Film if you're using the optional transparency unit to scan negative film.
- Select TPU for Pos. Film if you're using the transparency unit to scan positive film.

7. Choose your Image Type:
 - Select **Color Photo** to scan a color photograph in 24-bit color.
 - Select **Color Photo De-screening** to remove moiré patterns from a halftone picture (for example, from a photo in a magazine).
 - Select **Black & White Photo** to scan a photo in gray tones.
 - Select **Line Art** to scan your image in black and white without shading.
 - Select **OCR** to scan text.
 - Select **Copy & Fax** to scan a document combining text and graphics in black and white at draft quality.
8. Choose the Destination: **Printer (Photo)**, **Screen/Web**, **Fax**, **OCR**, **Printer (Fine)**, or **Laser Printer**. For the highest quality photo prints, choose **Printer (Photo)**.
9. Click the  Preview icon to preview your image. To make further adjustments, see the next section and “Scanning Part of an Image” on page 75.



Making Changes to Your Scan

You can adjust the quality and size of your scan or make corrections to the color, tone, contrast, and highlights.

1. To change the size of your final image, type new values in the **Source** and **Target** boxes, or drag the **Scale** slider. (The percentage of reduction or enlargement is shown to the right of the slider.)
2. Choose the resolution for scanning:
 - Choose **300 dpi** for photos you plan to print (or **72 dpi** to view them only on your computer or the Web).
 - Choose **400 dpi** for most text scanning.
 - Choose a higher resolution for line drawings, or if you plan to enlarge a photo.

note:

Higher resolutions create larger files that take longer to print and process.

3. Click the  Auto Locate button to automatically set the scan area for your image. (To scan only part of your image, see page 75.)
4. To optimize your image automatically, click the  Auto Exposure button. Your TWAIN software adjusts color, tone, contrasts, and highlights for you. Skip to step 8 if you choose this setting.
5. To adjust the highlights and contrast in your image, click the  Image Controls button. You see the following box:

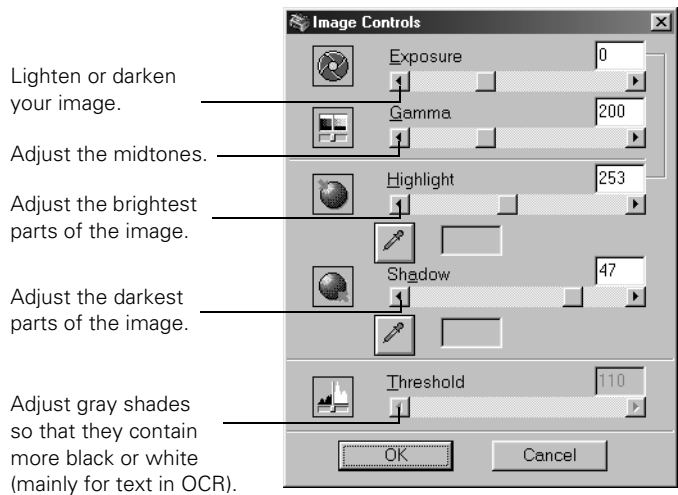

- To correct image tones, click the  Tone Correction button. You see the following box:

Select the colors you want to modify. Drag points on the tone curve to adjust the tone.

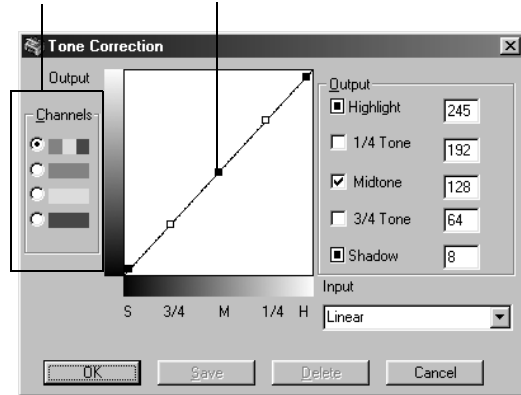

- To adjust colors, click the  Color Adjustment button. You see this box:

Remove unwanted color casts from your image.

Adjust the intensity of the color.

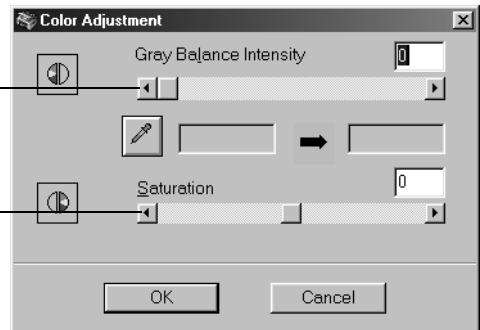

- When you've finished making changes, click the **Scan** button. Your image is scanned to your host application.

When it's finished, close the EPSON TWAIN window so that you can continue working with your image in the host application.

If you're not happy with the results, click the **Reset** button to return to your original image.

Scanning Part of an Image

Scanning is faster if you reduce the size of the image by scanning only part of it. If you want to select a portion of your image for scanning, follow these steps:

1. Click the  Auto Locate button on the EPSON TWAIN window. A frame appears around your preview.
2. Click and drag a corner of the frame to define the area you want to scan.

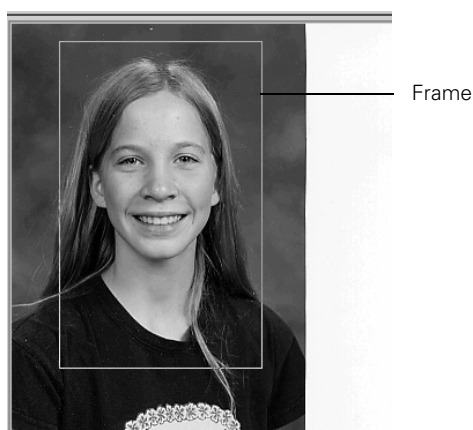

3. Click the  Zoom Preview button to preview your redefined image.
4. Follow the steps in “Making Changes to Your Scan” on page 72 to make any necessary changes and scan the image.

Scanning to OCR

OCR (optical character recognition) is the process of converting a scanned image into text that you can edit in a word processing program. After you scan your document, the software processes or “recognizes” it. Then you can edit it and either save the file or open it in any word processing program on your computer.

This section covers:

- Scanning the text
- Processing the text
- Saving the text file

Scanning the Text

1. Place your original document face down on the document table, as described in “Positioning the Original Document” on page 20.
2. Do one of the following to open the EPSON Smart Panel:
 - W** Click the  Smart Panel icon on the Windows taskbar.
 - M** Open the Apple menu and select EPSON SMART PANEL.
3. Click the **Scan to OCR** icon. You see the OCR welcome.
4. Click **Start**. The Scan to OCR window opens:

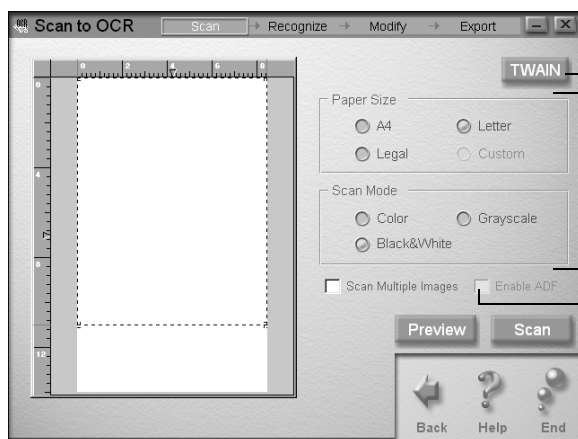

Click here to use EPSON TWAIN, or...

Select your scan settings here.

Click here if you're using the optional automatic document feeder.

note:

If you're an advanced user and want more control over your settings, click the TWAIN button. See page 70 for information about using the TWAIN settings.

note:

You can't use the Preview button if you're using the automatic document feeder.

5. Click the **Paper Size** button that corresponds to the page you're scanning.
6. Choose one of the following Scan Mode buttons:
 - **Color:** for documents printed in color
 - **Grayscale:** for documents that include black and white photographs or artwork with subtle shading
 - **Black&White:** for documents that include black text only or text with black line drawings
7. If you're using the document table to scan more than one page, click **Scan Multiple Images**.
8. If you're using the optional automatic document feeder, click **Enable ADF**.
9. If you want to scan the entire page, go to step 10. If not, click the **Preview** button. The EPSON Stylus Scan scans your document and displays a preview in the scan window on your screen.
10. Click and drag the dotted-line border on the preview to define the area you want to scan. You can adjust any of your other settings at this point.
11. Click the **Scan** button to begin your scan.
12. If you selected **Scan Multiple Images**, a message appears asking if you want to continue scanning.

If you click **Yes** to scan more images, replace the page on the document table and repeat steps 9 through 12.

If you click **No**, follow the steps in the next section to process or "recognize" the text.

Processing the Text

When scanning is completed, you see this window:

If you have a different OCR program on your computer, you can select it here.

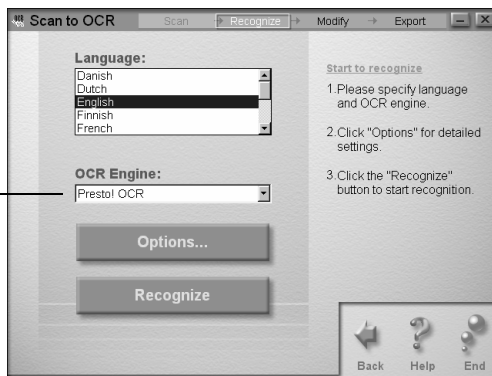

1. If the text you scanned is not in English, select the correct language.
2. Make sure the OCR Engine option is set to use the OCR program you have on your system. If necessary, select one from the list.
3. Click Options. You see the box shown below.

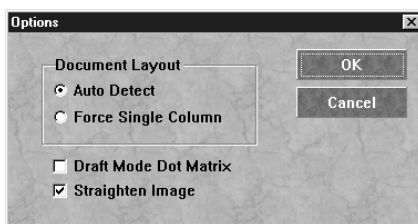

4. Choose one of the following Document Layout options:
 - **Auto Detect:** retains the original page format, which is especially useful for documents with columns, tables, and lists
 - **Force Single Column:** aligns all text into one column
5. Click Draft Mode Dot Matrix if the document you're scanning was printed on a dot matrix printer.

6. Click **Straighten Image** to have the software automatically correct crooked scans and improve the accuracy of the text.
7. Click **OK** to return to the Scan to OCR window. Then click **Recognize** to process the text.

When processing is completed, you see a window like this:

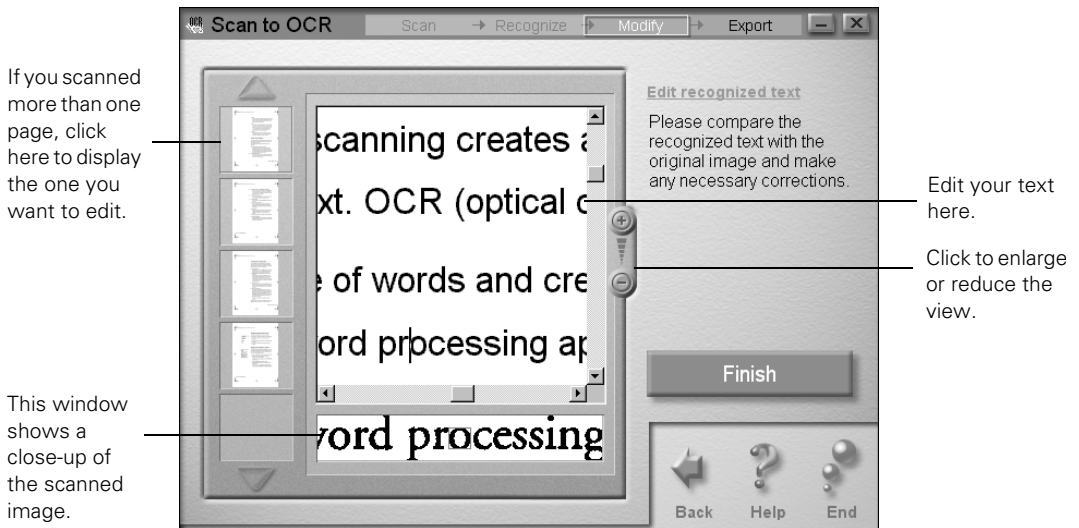

8. Your text appears in the square window. If necessary, click the + or – button to change the size of the display. Use the scroll bars to display the rest of the page.
9. Unclear characters are highlighted in blue (Windows) or underlined (Macintosh). Unrecognized characters are marked with a tilde (~).

Click on the text in the square window and correct or edit it as necessary. The small window at the bottom shows an enlarged view of the original scanned image, corresponding to the text you are editing.

- When you're done editing the text, click the **Finish** button. You see the **Export** window:



You can either save the text file or open it in a word processing program for further editing. Follow the instructions in “Saving the Text File” below, or “Opening a Word Processing Program” on page 82.

Saving the Text File

- Click **Save** in the **Export** window. You see this window:

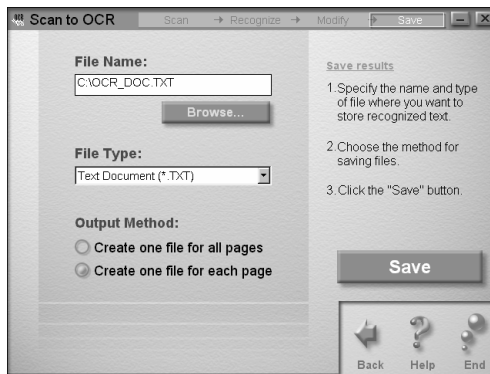

2. Choose a file type from the following list.
 - **Text Document:** For files that you can open and edit with any text editor. Text documents contain no formatting.
 - **RTF Document:** (Rich Text Format) For files that you can open and edit in Microsoft® Word (Windows), SimpleText (Macintosh), or many other popular programs. Rich Text Format documents contain limited formatting.
 - **HTML Document:** (Hypertext Markup Language) For files that can be viewed in a browser or posted on the Web.
 - **PDF Document:** (Portable Document Format; Windows only) For files that you can open in Adobe Acrobat.
3. Type a name for the file; the file extension is added automatically. If you're saving multiple files, the program automatically adds an identifying number to the end of each filename.
4. Click the **Browse** button to choose the folder where you want to save your file(s).
5. Under Output Method, choose one of the following:
 - **Create one file for all pages:** Saves all scanned pages in one file.
 - **Create one file for each page:** Saves each page in a separate file, using the file name you entered, plus an additional number to identify each page.

W

note:

If you're saving your file in PDF format, you'll see the Save As window instead of the Continue Exporting window.

Navigate to the folder where you want to save your file, type a new file name, and click OK.

Type any information you want to add on the next screen, then click OK again.

6. Click the **Save** button. You see the following window:



7. Click **Exit** to close Scan to OCR, **Continue Exporting** to save additional files, or **Return to Start** to delete your edited text file and start the scanning to OCR process from the beginning.

Opening a Word Processing Program

1. Click **Open** in the Export window. You see a window like this:

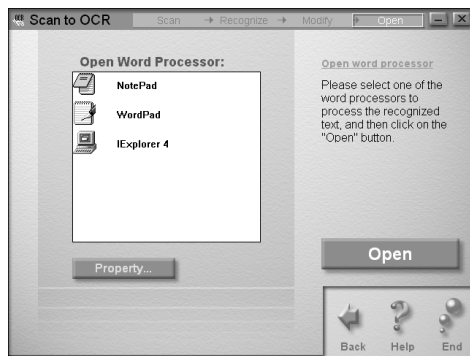

The software automatically detects the word processing programs that can open the scanned file.

2. Select the program you want to use, then click the **Open** button. (If you want to remove a program from the list or change a default file format for a program, click **Property** and see page 84 *before* you click **Open**.)

The program opens and displays your file. You can work with it just like any other file on your computer. The file is automatically named as follows:

W

- The default file name is DOCU0001 in your Windows\temp folder.

M

- The default file name is ocr___01 (three underscores) in the Temporary Items folder.

For each new file, the number used in the file name increases (for example, DOCU0002 or ocr___02).

3. Save the file(s). You can change the location and file name in your word processing application as you save the file(s), if you want. See your application's help utility for instructions.
4. When you exit your word processing application, you see the Scan to OCR exit window. Click **Exit** to close Scan to OCR, **Continue Exporting** to save additional files, or **Return to Start** to start the scanning to OCR process from the beginning.

note:

Your files are not actually saved until you save them in your word processing program. If you close the program before saving the files, they are lost.

Changing Word Processor Program Properties

If you want to change the way your program opens scanned files, click the Property button. You see this window:

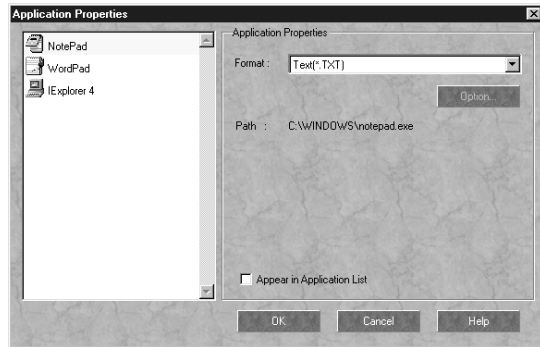

- To change the default file format, select a program on the list. The default file format appears in the Format box. You can select any of the other formats (there may be only one available).
- If you want to add a program to the list, you need to use Scan to Application. See page 98 for instructions.
- If you want to remove a program from the list, select the program and click **Appear in Application List** to remove the check.
- Click **OK** to close the Application Properties window.

Scanning to E-mail

note:

Before you can scan to e-mail, you need to have a modem that is already connected to the Internet.

If you have a modem, Internet service, and an e-mail application, you can easily share photos and other images. After you scan the image, your software can convert it to a variety of file formats for easy viewing. You can even have the image open automatically when the recipient reads your e-mail message.

Scanning Your Document

1. Place your original document(s) face down on the document table, as described in “Positioning the Original Document” on page 20.
2. Do one of the following to open the EPSON Smart Panel:
 - W** Click the  Smart Panel icon on the Windows taskbar.
 - M** Open the Apple menu and select EPSON SMART PANEL.
3. Click the Scan to E-mail icon. You see the Scan to E-mail welcome.
4. Click **Start**. The Scan to E-mail window opens:

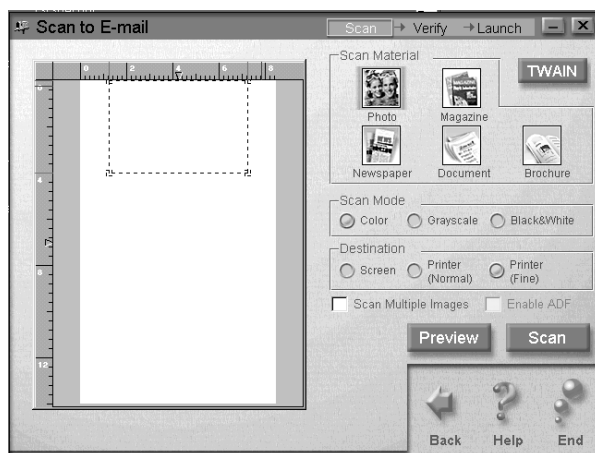

note:

If you're scanning a printed picture that is not a film-processed photograph, make sure you choose Magazine, Newspaper, or Brochure. These settings will give you better scans and eliminate unwanted dot patterns.

5. Select the type of document(s) you're scanning from the Scan Material icons. If the basic settings listed beneath the icons are correct, go to step 8.

To change the basic settings chosen by the Scan Material selection, go to steps 6 and 7.

If you're an advanced user and want more control over your settings, click the **TWAIN** button. See page 70 for information about using the TWAIN settings.

6. Choose one of the following Scan Mode buttons:
 - **Color:** For any type of document or photo in color
 - **Grayscale:** For black and white photographs or artwork with subtle shading
 - **Black&White:** For text or drawings with no shading.
7. Choose one of the following Destination buttons:
 - **Screen:** For images that will be displayed on the Internet or viewed on the screen only
 - **Printer (Normal):** For text or images that will be printed normally
 - **Printer (Fine):** For photographs or other images that will be printed at the highest quality or resolution (scanning is slower with this setting)
8. If you're using the document table to scan more than one image, click **Scan Multiple Images**.
9. If you're using the optional automatic document feeder, click **Enable ADF**. Then go to step 12.

If you're not using the automatic document feeder, go to step 10.

note:

You can't use the Preview button if you're using the optional automatic document feeder.

10. Click the **Preview** button. The EPSON Stylus Scan scans your document and displays a preview in the scan window on your screen:

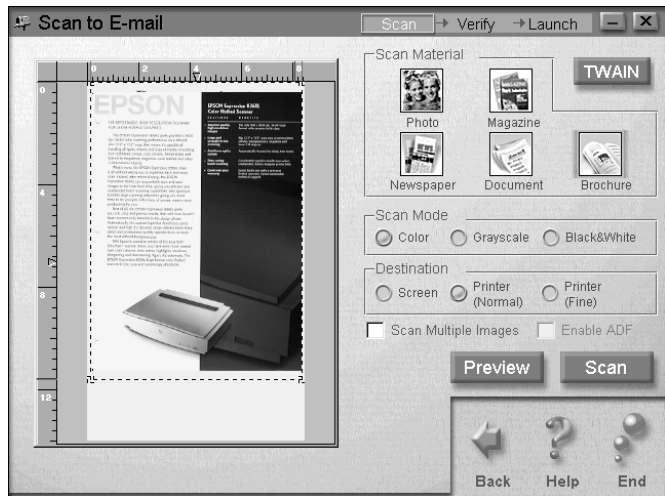

11. Click and drag the dotted-line border on the preview to define the area you want to scan. You can also adjust any of your other settings at this point.
12. Click the **Scan** button. Your original document is scanned.
If you selected **Scan Multiple Images**, a message appears asking if you want to continue scanning.
13. If you click **Yes** to scan more images, click inside the dotted line border on the preview image and move it to the next image. Size the border as necessary, then repeat steps 12 and 13.
If you click **No**, go to step 14.

14. When scanning is completed, you see a window like this:

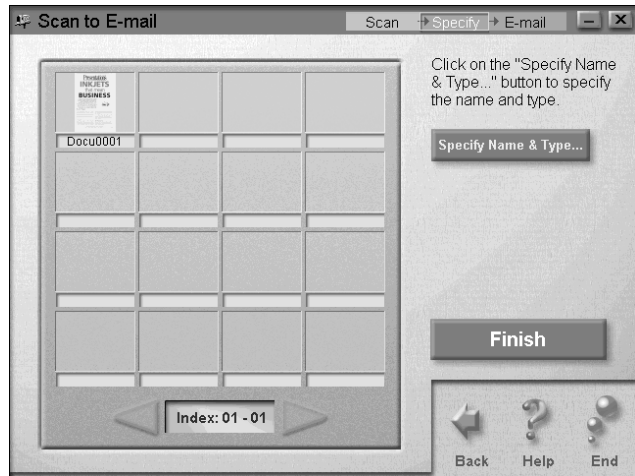

For a closer look, double-click any image to display it in the Image Viewer window.

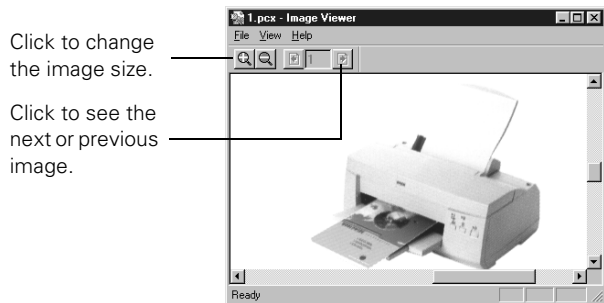

Choose **Exit** (Windows) or **Quit** (Macintosh) from the File menu when you're finished viewing your file. You return to the image selection window.

To format and send your scanned file, see the next section.

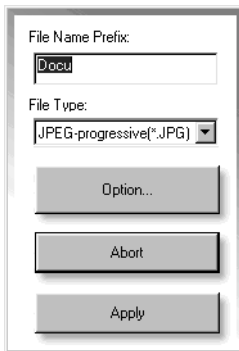

Windows



Macintosh

W

Formatting and Sending the File

1. At the Specify window, click **Specify Name & Type**. You see this box (shown to the left) next to the window.
2. Enter a file name prefix for your scans. If you scanned more than one image, they will be automatically numbered.
3. Under **File Type**, choose a file format for your scanned images.

- The JPEG format is a good choice for most images.

If you select JPEG as the image type, the **Option** button becomes active. If you want to adjust the image quality or compression of JPEG files for your application, click the **Option** button and use the slider to choose between high image quality and high compression. Then click **OK**.

- If you want to e-mail mainly text, choose **Text**, **Rich Text Format**, or **HTML**. The software will automatically perform OCR and convert the file into editable text. See page 76 for more information.
- Choose **Presto! Wrapper** (Windows only) to have your file open automatically in a “viewer” when the recipient clicks it.

The available file formats are based on the type of image you’re scanning. See your EPSON Smart Panel online help for a complete list of supported formats.

4. Click **Apply** to save your choices and close the box.

note:

Scan to E-mail supports Lotus® cc:Mail® 6.0, Qualcomm® Eudora Pro® 3.0, Netscape Mail™ 4.x, and MAPI-compliant mail programs like Microsoft Exchange® and Microsoft Outlook® 97.

5. Click **Finish** in the image selection window.

The software detects the e-mail programs on your computer and lets you choose the one you want to use.

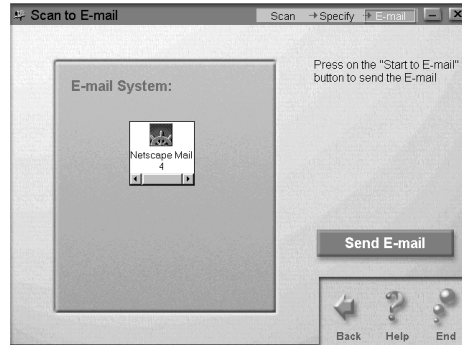

6. Select the e-mail program you want to use, then click **Send E-mail**.

Your e-mail program opens. You can write a message and then send it with your image or text file attached.

7. When you're finished e-mailing, close your e-mail program. You see the Scan to E-mail exit screen.
8. Click **Exit** to close Scan to E-mail, **Continue E-mailing** to e-mail additional files, or **Return to Start** to start the scanning to e-mail process from the beginning.

Scanning for Creativity

Your EPSON Stylus Scan lets you turn your photos into creative projects like calendars, business cards, and letterheads. Scanning for Creativity makes these projects simple by automatically opening the PhotoDeluxe program that came with your EPSON Stylus Scan.

Scanning Your Images

1. Place your original document(s) face down on the document table, as described in “Positioning the Original Document” on page 20.
2. Do one of the following to open the EPSON Smart Panel:
W Click the  Smart Panel icon on the Windows taskbar.
M Open the Apple menu and select **EPSON SMART PANEL**.
3. Click the Scan for Creativity icon. You see the Creativity welcome.
4. Click **Start**. The Scan for Creativity window opens:

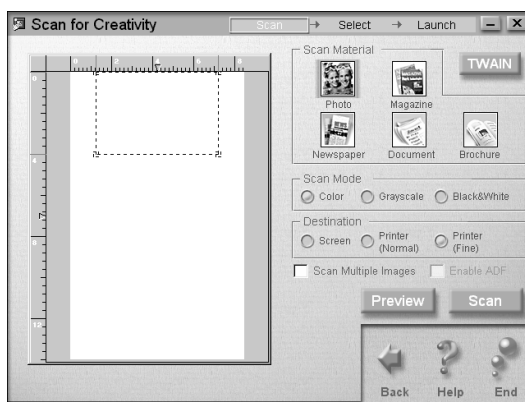

5. Follow the steps in “Scanning Your Document” beginning on page 85 to choose your settings and preview your image.
6. Click the **Scan** button. Your original document is scanned.

7. If you selected **Scan Multiple Images**, a message appears asking if you want to continue scanning.

If you click **Yes** to scan more images, click inside the dotted line border on the preview image and move it to the next image. Size the border as necessary, then repeat steps 6 and 7.

If you click **No**, continue with one of the following sections:

- “Creating Your Project in Windows” below
- “Creating Your Project on a Macintosh” on page 94

W *Creating Your Project in Windows*

If you’re using Windows, you see the activity selection window:



Click here to display more projects.

1. Click the project you want to create, for example, **Letterhead**.
2. Click the **Finish Selection** button. You see a window confirming your choice.
3. Click the **Launch PhotoDeluxe** button to open PhotoDeluxe.

note:

Once PhotoDeluxe is open, you can use all of its features to edit and enhance your photo, add text and special effects, or create many types of projects. For more information, click Help or check the electronic manual for PhotoDeluxe, as described on page 7.

PhotoDeluxe opens with your scanned image in the Hold Photo area on the left:

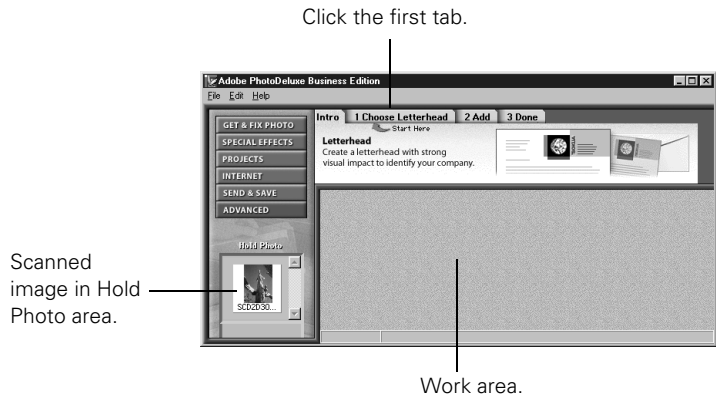

4. Drag your photo to the work area if you want to edit it or add special effects before you begin your project.
5. Click the first tab to start working on your project. Then follow the instructions on the screen to complete the project.

Make sure you have your PhotoDeluxe CD-ROM handy so you can insert it when requested.

M **Creating Your Project on a Macintosh**

You see the Scan for Creativity launch window.

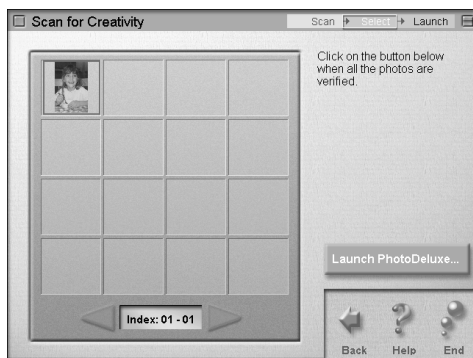

1. Click the Launch PhotoDeluxe button to open PhotoDeluxe. PhotoDeluxe opens with your scanned image in the work area:



note:

Once PhotoDeluxe is open, you can use all of its features to edit and enhance your photo, add text and special effects, or create many types of projects. For more information, click Help or check the electronic manual for PhotoDeluxe, as described on page 7.

2. To begin a project, click the Cards and More button, select a project, and follow the instructions on the screen to create it.
3. When you're finished working, exit PhotoDeluxe. You see the Scan for Creativity exit screen.
4. Click Exit to close Scan for Creativity, Continue Launching to work with additional files, or Return to Start to start the scanning for creativity process from the beginning.

Scanning to an Application

For complete flexibility, Smart Panel lets you scan and send your scanned files to any application program on your computer.

1. Place your original document(s) face down on the document table, as described in “Positioning the Original Document” on page 20.
2. Do one of the following to open the EPSON Smart Panel:
 - W** Click the  Smart Panel icon on the Windows taskbar.
 - M** Open the Apple menu and select **EPSON SMART PANEL**.
3. Click the Scan to Application icon. You see the Scan to Application welcome.
4. Click **Start**. The Scan to Application window opens:

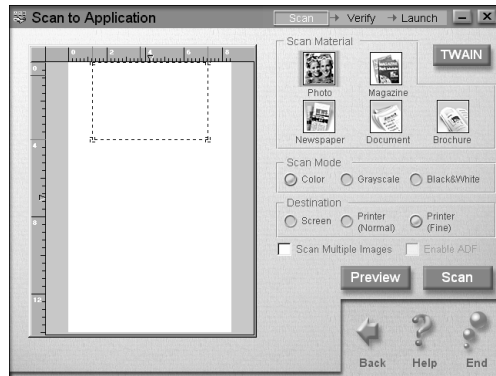

5. Follow the steps in “Scanning Your Document” beginning on page 85 to choose your settings and preview your image.
6. Click the **Scan** button. Your original document is scanned.
7. If you selected **Scan Multiple Images**, a message appears asking if you want to continue scanning.

If you click **Yes** to scan more images, click inside the dotted line border on the preview image and move it to the next image. Size the border as necessary, then repeat steps 6 and 7.

If you click **No**, go to step 8.

8. When scanning is completed, you see a window like this:

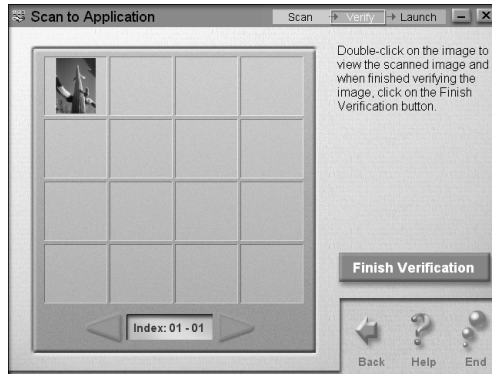

For a closer look, double-click any image to display it in the Image Viewer window.

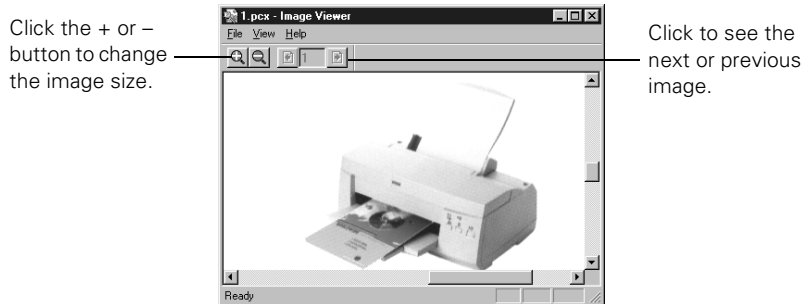

9. Choose **Exit** (Windows) or **Quit** (Macintosh) from the File menu when you're finished viewing your file. You return to the image verification window.

10. Click **Finish Verification**. You see a window like this:

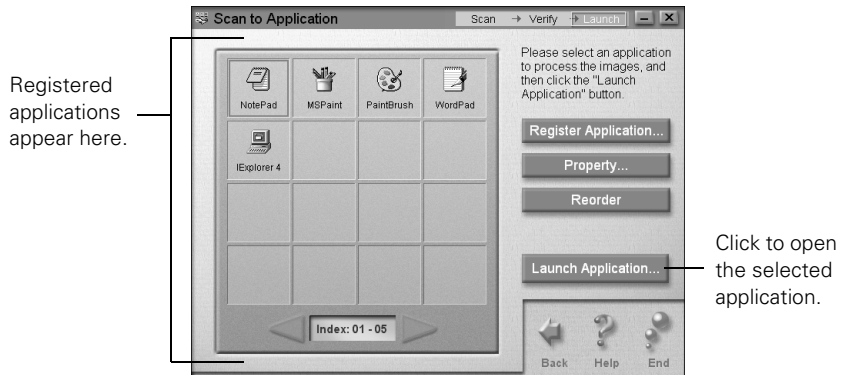

(To register additional applications, see page 98. To remove applications from the display or change application properties, see page 100.)

note:

If your application can only open one file at a time and you have more than one image selected, you'll have a chance to save the rest of them for later use.

11. Click the application you want to use, then click the **Launch Application** button. The application opens and displays your image(s). (Your application opens multiple images only if it supports multiple images.)

Your image is automatically converted to the default format for that application. You can change the default format using the Application Properties window; see page 100 for instructions.
12. When you're finished working, exit the application. You see the Scan to Application exit screen.
13. Click **Exit** to close Scan to Application, **Continue Scanning** to work with additional files, or **Return to Start** to start the scanning to application process from the beginning.

Registering New Applications

You can register any program on your computer so you can open it with Scan to Application. Follow these steps:

1. In the Scan to Application launch window, click the Register Application button. You see the following window:



Windows

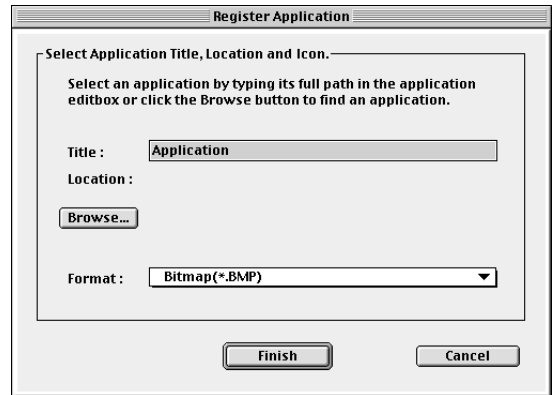

Macintosh

2. Click the **Browse** button to locate the application you want to register.

3. Select the .exe file (Windows) or program file (Macintosh) that launches the application, then click **Open**. You return to the Register Application window, with the program information displayed:

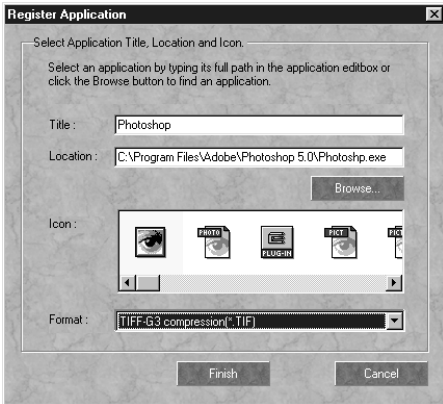

Windows

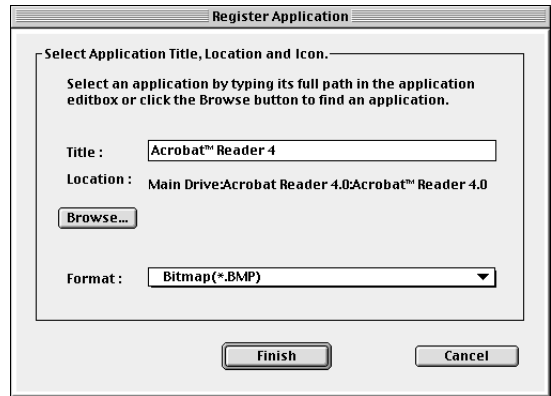

Macintosh

4. The application name appears in the Title box, but you can type in a new one, if you want.
- W**
5. Select the icon you want to display in the Scan To Application window.
 6. Select the default file format for scans opened in the application you're registering. (See page 81 for more information about file formats.)
 7. When you've made all your choices, click **Finish**. The application appears in the Scan to Application launch window.

Removing Applications or Changing Properties

You can remove programs that you don't want to appear in the Scan to Application window, or change the default format for each program's files.

1. In the Scan to Application launch window, click the Property button. You see a window like this:

Unregister appears only if you registered the application, as described in the previous section.

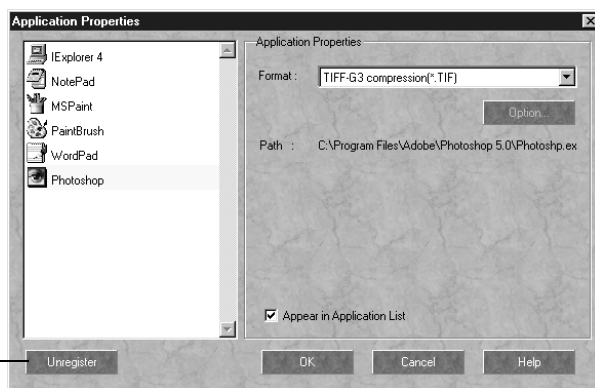



2. Select the program you want to remove or change. The default file format appears in the Format box.
 - If you want to change the default file format, select any of the other formats available for that application.

If you want to adjust the image quality or compression of JPEG files for your application, choose JPEG in the Format list and click the **Option** button. Use the slider to choose between high image quality and high compression, then click **OK**.
 - If you want to remove the selected program from the Application window, click **Appear in Application List** to uncheck it.
 - If you want to remove the program from Smart Panel, click the **Unregister** button.
3. When you're finished, click **OK**.

Quick Scanning

If you often work with your scans in the same way, you can save time by setting up your EPSON Stylus Scan for quick scanning. For example, you might find that you generally want to e-mail your scans to customers or colleagues, or work with them in PhotoDeluxe. You can set up your scanner so that you automatically start the Smart Panel's Scan to E-mail or Scan for Creativity by just pressing the  Scan button on the EPSON Stylus Scan's control panel.

- W** When you installed your EPSON Stylus Scan Windows software, your system was set up to automatically start EPSON Smart Panel when you press the  Scan button. To select an application that you'd like to open automatically in the EPSON Smart Panel, see "Selecting an Application in EPSON Smart Panel" on page 102.
- M** On a Macintosh, you need to set up the EPSON Scanner Monitor to automatically open the EPSON Smart Panel when you press the  Scan button. See the next section for instructions.

Setting Up the EPSON Scanner Monitor (Macintosh)

Follow these steps to set up quick scanning:

1. Select EPSON Scanner Monitor Setup in the Apple menu. You see a window like this one:

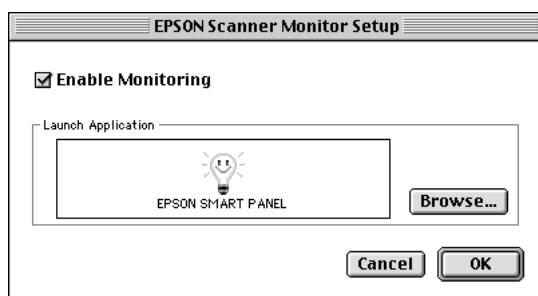

2. If necessary, click **Browse**, locate the EPSON Smart Panel program file, and click **Open**. When the EPSON Smart Panel icon appears in the Launch Application box, click **OK**.

To select an application for quick scanning in EPSON Smart Panel, see the next section.

Selecting an Application in EPSON Smart Panel

1. Do one of the following to open the EPSON Smart Panel:

W

Click the  Smart Panel icon on the Windows taskbar.

M

Open the Apple menu and select **EPSON SMART PANEL**.

2. Select your target Smart Panel utility from the list at the bottom of the Smart Panel. A  Scan button icon appears beside the utility you select.

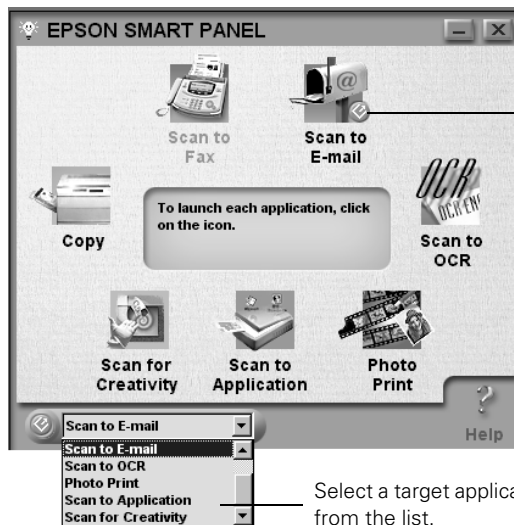

An icon appears beside the application you select.

Select a target application from the list.

Now whenever you press the  Scan button on the EPSON Stylus Scan's control panel, the target Smart Panel utility starts.

4 Faxing

If you have a modem, you can send and receive faxes with your EPSON Stylus Scan. You can fax anything that you can scan in or create on your computer.

Depending on your system, you'll use different utilities and software for faxing:

- If you have Windows, you'll use the WinFax and Smart Panel software that came with your EPSON Stylus Scan.
- If you have an iMac™ with an internal modem, you'll use Smart Panel with the FAXstf software that came with your iMac.
- If you purchased a third-party modem for your Power Macintosh, you can install the FAXstf software that comes on your EPSON Stylus Scan software CD-ROM and use it with Smart Panel. See the *Start Here* sheet for installation instructions.

Your EPSON Stylus Scan 2500 CD-ROM includes an offer for eFax, software that lets you receive faxes through your e-mail. See page 109 for instructions on installing and using eFax.

Before you begin, make sure the software is installed and your EPSON Stylus Scan is set up, connected to your computer, and turned on.

Faxing with Smart Panel

Your EPSON Stylus Scan works with your Smart Panel software and the modem in your computer to send and receive faxes. In addition, all incoming faxes can be automatically printed or stored on your hard drive (Windows only).

Using the Scan to Fax utility on the Smart Panel is just like using a fax machine on your computer screen. Follow the instructions in this section for:

- Sending a fax
- Receiving faxes
- Customizing Scan to Fax

Sending a Fax

You need to have a modem installed in or connected to your computer and connected to a phone line. If you have an external modem, make sure it's turned on. Then follow these steps:

1. Place the document you want to fax face down on the document table and close the document cover. (See "Positioning the Original Document" on page 20 for details on placing your document.)
2. Do one of the following to open the EPSON Smart Panel:
 - W** Click the  Smart Panel icon on the Windows taskbar.
 - M** Open the Apple menu and select EPSON SMART PANEL.

tip:

If your document doesn't exist on paper, you don't have to print it out and scan it. You can use your fax utility alone to fax documents that you create on your computer.

3. Click the **Scan to Fax** icon. You see the Scan to Fax window:

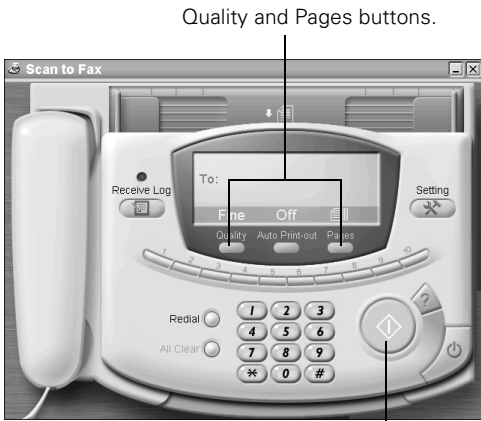

Windows

Start button.



Macintosh

Start button.

4. Click the **Quality** button to select one of these settings:
 - **Normal** for everyday fax quality
 - **Fine** for higher resolution quality
 - **Photo** for faxing smooth-looking photographs
5. Click the **Pages** button to indicate whether you are faxing a single page or multiple pages.
6. Click the numbers on the keypad to dial your fax number. The number you dialed appears on the green “To” area on your screen.
7. Make sure the number is correct; then click the green **Start** button on your screen to begin the scan to fax process.

A “scanning in progress” message appears on your screen, then you see a message about your document being converted into a fax image.

8. If you selected multiple pages in step 5, a message appears asking if you want to continue scanning. Replace the page on the document table and click **Yes**. Your new page is scanned. Click **No** when you’ve finished scanning pages.

tip:

You can also position the cursor in the “To” area and type the fax number.

9. Click the  Close button on your screen to close the Scan to Fax window.

note:

If you have only one phone line for your modem and telephone, you might want to set up your system to receive faxes manually. See your fax program documentation for instructions.

Receiving Faxes

When you install your EPSON Stylus Scan software, your fax system is set to receive faxes automatically. You can continue working on your computer while your faxes are received in the background.

This is what happens when you receive a fax:

- You see a “receiving fax” message on your screen.
- W** ■ When the receiving process is complete, the Scan to Fax window opens (Windows only). The green light blinks above the  Receive Log button on the Scan to Fax screen. See “Viewing a Received Fax (Windows)” below for instructions on viewing your received fax.
- M** ■ With FAXstf, you see a blinking icon over the Apple menu. See “Viewing a Received Fax (Macintosh)” on page 107 for instructions on viewing your received fax.

W Viewing a Received Fax (Windows)

1. To view the fax, click the  Receive Log button. The Receive Log window opens:

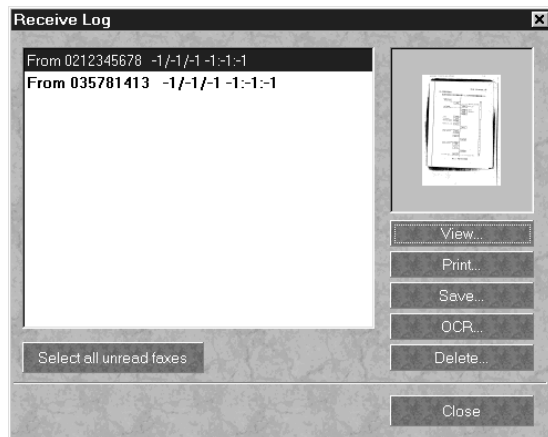

note:

You can have faxes print out automatically when you receive them (Windows only). Click the Auto Print-out button on the Scan to Fax window to turn on this feature.

2. Click a fax entry to display a small thumbnail image. Then you can do any of the following:
 - Click the **View** button to open the Image Viewer window and display the faxed document. See “Scanning Your Document” on page 85 for information about the Image Viewer.
 - Click the **Print** button to print the selected document. See “Printing” on page 35 for more information.
 - Click the **Save** button to save the fax on your computer. See “Saving the Text File” on page 80 for instructions.
 - Click the **OCR** button to open the Scan to OCR window and turn the fax into a text file. See “Scanning to OCR” on page 76 for more information.
 - Click the **Delete** button to delete the fax file.
3. Click **Close** to close the Receive Log window.

M **Viewing a Received Fax (Macintosh)**

Follow these steps to view a received fax with FAXstf.

1. Open the Apple menu and select **EPSON SMART PANEL**.
2. Click the **Scan to Fax** icon. You see the Scan to Fax screen.
3. To view the fax, click the  **FAXstf** button. The FAXstf Fax Browser opens. (If you don't see the Fax Browser window, select **Show Browser** in the Windows menu.)
4. Click the **FAX In** folder to view a list of your received faxes. Double-click the fax you want to view to open the contents. (See the electronic *FAXstf User's Manual* for complete information about FAXstf.)
5. When you're finished, select **Quit** from the File menu to close the Fax Browser.

Customizing Scan to Fax

You can add (or change) header information that appears at the top of your faxes and set up the speed dial buttons. Follow these steps:

1. In the Scan to Fax window, click the  Setting button. You see the Setting window:

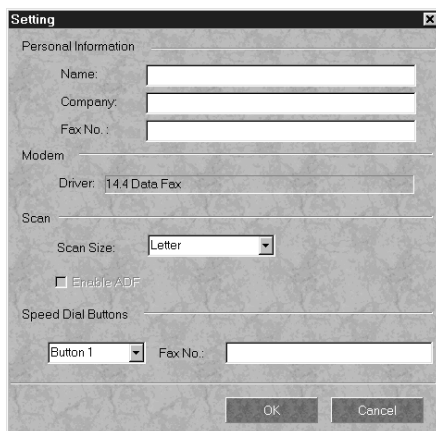

2. Under Personal Information, enter the text you want to appear on the header at the top of your faxes.
3. If necessary, select a Scan Size. Normally you will leave the Scan Size setting on **Letter**. However, you can also choose **A4** or **Legal** if you're faxing documents on these paper sizes. For sizes not listed, choose **Custom**. Then enter the size of the document you're faxing.
4. If you're using the automatic document feeder, select **Enable ADF**.
5. You can enter fax numbers for up to 10 speed-dial buttons. These numbers will then be dialed automatically when you click the corresponding speed dial button on the Scan to Fax window. Click a button number, then enter the fax number for each one.
6. Click **OK** to close the Setting window. You return to the Scan to Fax window.

note:

You must use the optional automatic document feeder to fax documents more than 11.7 inches long.

Using eFax

note:

eFax is an Internet service provided by eFax.com. To use eFax, you need an active e-mail account, and you need to be able to receive e-mail from outside your domain.

eFax works in both Windows and Macintosh environments. For more information, go to the eFax.com web site at <http://www.efax.com>.

Because it lets you receive faxes through your e-mail, eFax eliminates the need for a dedicated phone line for your faxes. You don't have to worry about missing faxes when your computer is off or when you're connected to the Internet. Your friends and associates send you faxes by dialing your eFax number on their fax machines, just as if you had a fax machine. And if you want to send faxes as well as receive them, you can sign up for eFax Plus.

Follow these steps to begin using eFax:

1. Insert the EPSON Stylus Scan CD-ROM in your drive.
2. Do one of the following to access eFax:

W

Double-click **My Computer** on your desktop. Then double-click the **Epson_ss2500** CD-ROM icon. Open the **eFax** folder and double-click **faxoffer.exe**.

M

Double-click the **EPSON SS2500** CD-ROM icon. Then double-click the **Free eFax Offer** icon. Double-click the second **Free eFax Offer** icon.

You see the following screen:

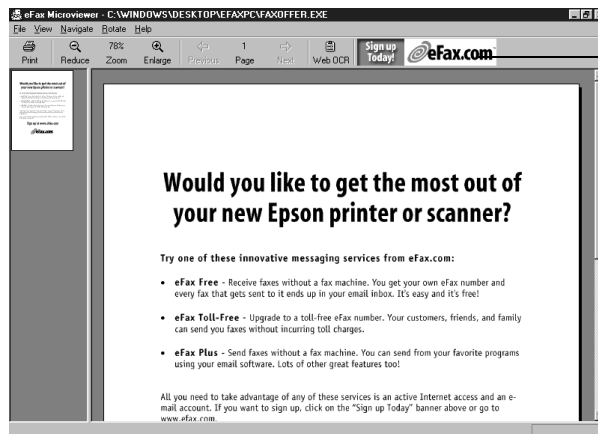

Click here to activate your eFax account.

3. Click **eFax.com** on the toolbar. Your browser opens and connects you to the eFax.com web site, where you can register for eFax. In a few days, you'll receive a confirmation e-mail from eFax.com that includes your personal fax number and PIN.
4. Close the eFax microviewer when you're finished.

Share your fax number with others and print it on your business cards. Faxes will arrive as attachments to your e-mail messages. To read them, just open the attachments.

You can use your PIN number to access your account on the eFax.com web site (<http://www.efax.com>). Your account includes an Activity Log that stores up to 10MB. When the Activity Log is full, the oldest faxes are automatically deleted. If you want to manage your account so that you don't lose important faxes, you can delete faxes, forward them to others, or resend them to yourself.

5 *Using the Automatic Document Feeder*

note:

If you don't have the EPSON Stylus Scan 2500 Pro model, you can purchase the automatic document feeder as an option. See page 159 for details.

If you have the EPSON Stylus Scan 2500 Pro model, your printer came with an automatic document feeder. This unit is handy when you need to scan or copy multi-page documents.

You can use the automatic document feeder with the EPSON Stylus Scan's control panel for copying without using your computer. You can also use the automatic document feeder with the EPSON TWAIN software and EPSON Smart Panel for multi-page scanning, faxing, and printing. Follow the instructions in the previous chapters to process documents with the automatic document feeder.

You'll find instructions in this chapter for the following:

- Installing the automatic document feeder
- Loading your document
- Clearing paper jams
- Cleaning the paper path guide

Installing the Automatic Document Feeder

Follow these steps to install the automatic document feeder:

1. Make sure your EPSON Stylus Scan is turned off. Then unplug the power cord.
2. Remove any packing materials from the automatic document feeder.

3. Raise the EPSON Stylus Scan document cover and remove the option cover, as shown below.

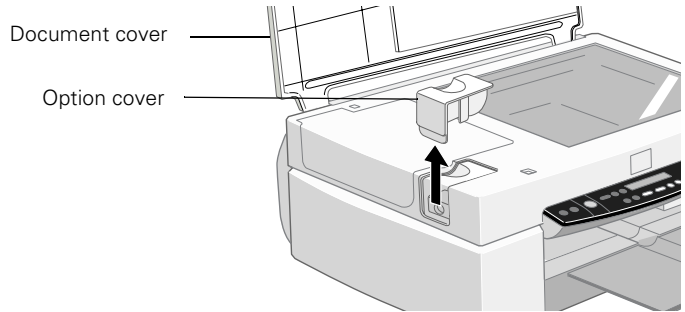

4. Hold the automatic document feeder as shown and insert its hinges into the holes. Then close the automatic document feeder.

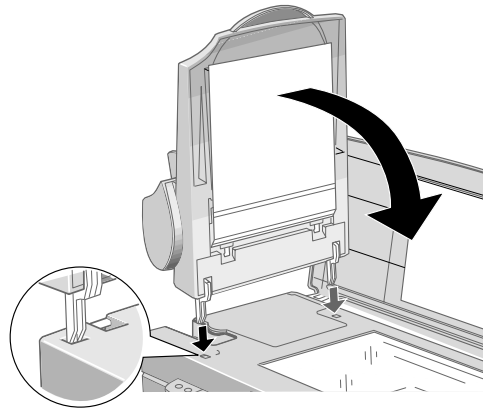

5. Attach the automatic document feeder's connector to the EPSON Stylus Scan's option interface.

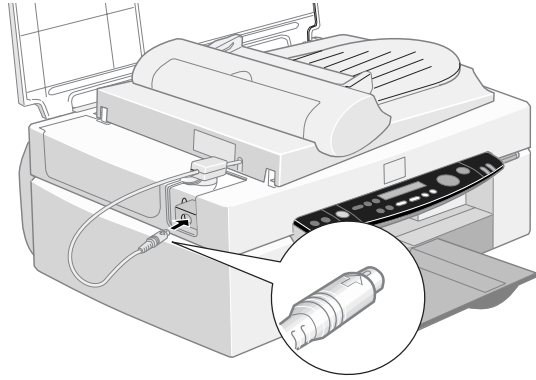

6. Attach the paper support to the automatic document feeder by sliding it into the slots, as shown below.

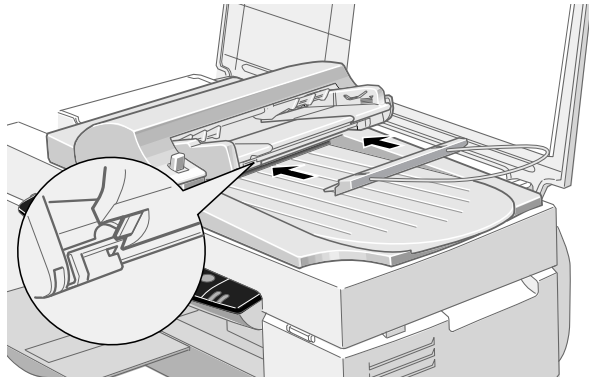

Loading Your Document

Your automatic document feeder can load up to 20 sheets of the following paper sizes: Letter, Legal, Checks, A4 (8.27 × 11.7 inches), and B5 (7.17 × 10.1 inches).

note:

Don't load multi-page forms or paper with carbon coating in the automatic document feeder. It's also best not to load original artwork, in case of a misfeed.

Before loading a document, check the following:

- Remove any document(s) from the document table.
 - Clean off any dust from the document table as described on page 129.
 - Check the document you'll be loading to make sure it is free of holes, rips, wrinkles, or attachments such as staples or clips.
1. Slide the automatic document feeder's right edge guide all the way to the right.

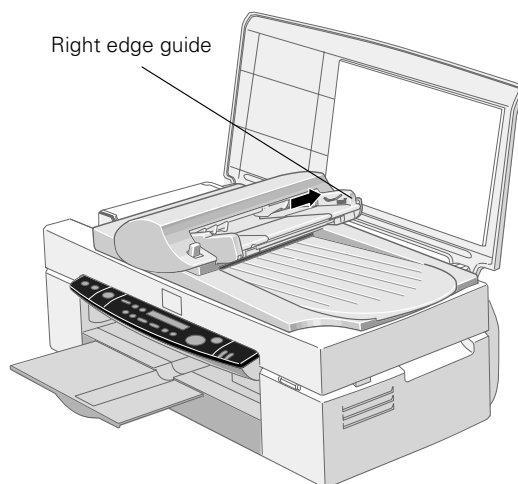

2. Insert your document face up, with the top edge leading into the automatic document feeder. Feed it in until it meets resistance. Then move the right edge guide until it touches the right edge of your paper.

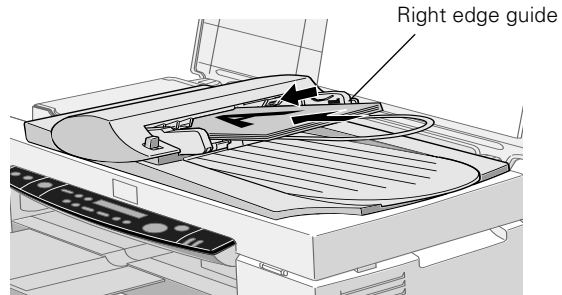

note:

If you open the automatic document feeder while your EPSON Stylus Scan is operating, you'll get an option error and paper feeding will stop. Close the automatic document feeder to resume paper feeding.

3. Scan or copy your document as described in previous chapters.

You can place documents on the document table when the automatic document feeder is installed. Just lift the automatic document feeder and place your document face down on the document table.

Clearing Paper Jams

Turn off your EPSON Stylus Scan, then follow these steps to clear paper jams in the automatic document feeder:

1. Push down the release lever and raise the feeder mechanism slightly.

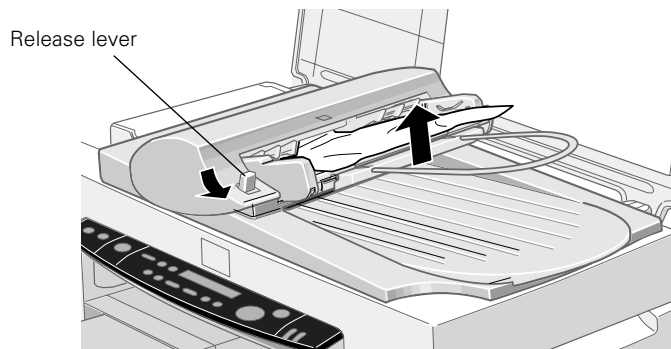

2. Carefully pull the jammed paper out of the feeder mechanism, taking care not to tear the paper.

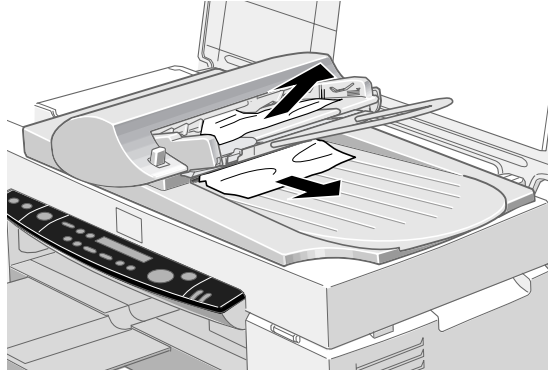

3. If paper is jammed inside the automatic document feeder, open the cover at the back of the unit.

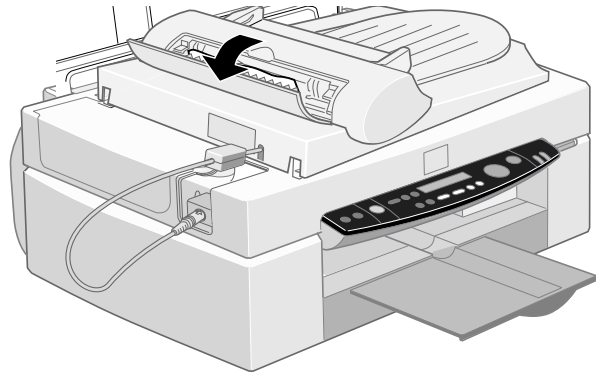

4. Remove any jammed paper, close the cover, and push the feeder mechanism down until it clicks into place.

Cleaning the Paper Path Guide

note:

If quality doesn't improve after you clean the paper path guide, or you notice the guide is scratched, replace it with a new guide.

If the quality of your scans or copies declines, cleaning the paper path guide might fix the problem. Turn off the EPSON Stylus Scan, then follow these steps to clean the guide:

1. Disconnect the automatic document feeder's connector from the EPSON Stylus Scan's option interface (see page 113).
2. Remove the paper support from the automatic document feeder.

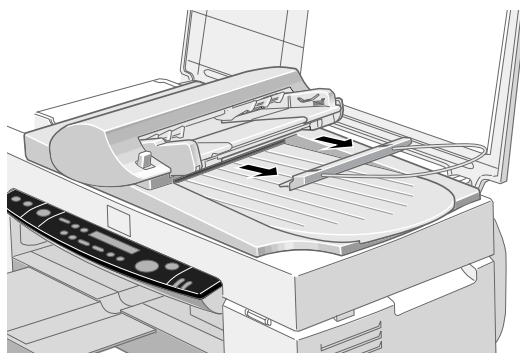

3. Lift the automatic document feeder straight up to remove it.

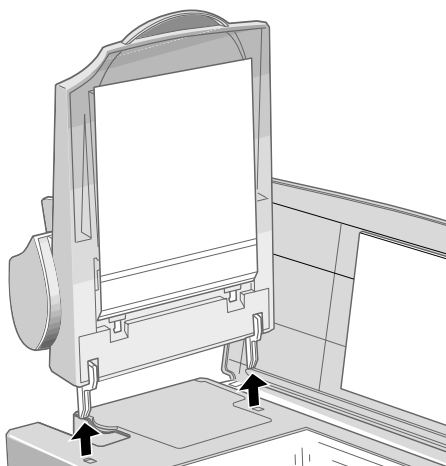

4. Turn over the automatic document feeder and place it on a flat surface. Locate the two white tabs at one end of the paper path guide. Pull the tabs up slightly, then push them through the brackets.

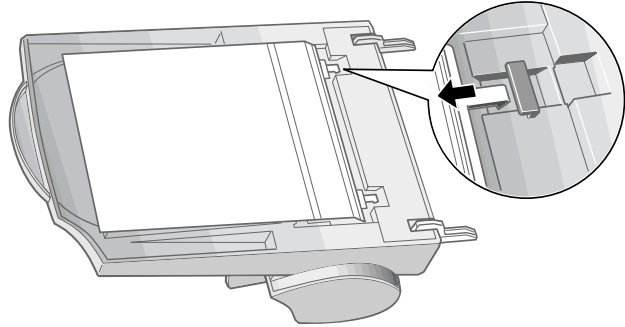

5. Pull the paper path guide up and out.

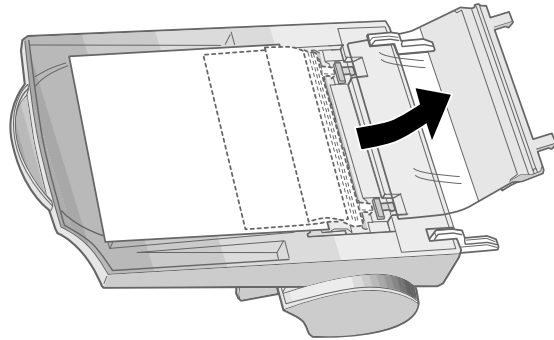

caution:

Be careful not to touch the automatic document feeder's rollers or any metal parts. Doing so may damage the parts.

6. Using a soft, dry cloth, gently wipe any dust from the guide's transparent plastic sheet. Be careful not to scratch the guide.

7. Reinstall the paper path guide. Insert the transparent plastic sheet under the white mat.

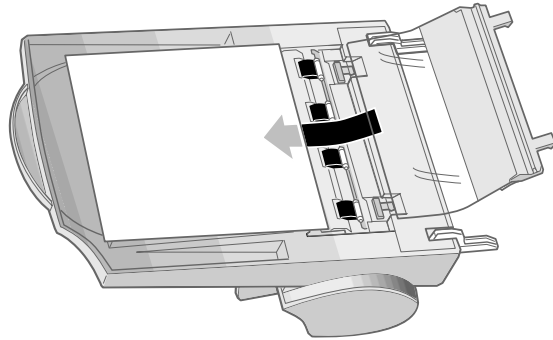

8. Insert the guide's tabs through the brackets at the back of the automatic document feeder. Push in the tabs until they clip into place.

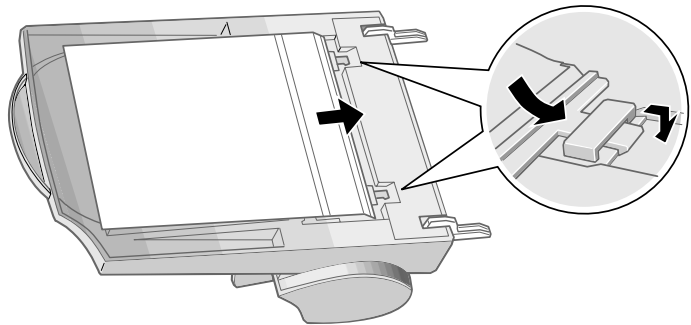

6 *Maintenance*

This chapter describes the most common maintenance procedures you'll need to perform to keep your EPSON Stylus Scan working at its best. For more details, see your electronic *EPSON Stylus Scan 2500 Reference Guide*.

You'll find instructions in this chapter for the following:

- Replacing ink cartridges
- Cleaning the print head
- Aligning the print head
- Cleaning the EPSON Stylus Scan
- Transporting the EPSON Stylus Scan

Replacing an Ink Cartridge

When you're low on ink or one of the cartridges is empty, you'll see a message on the LCD panel and the Error light will turn on or flash. It's a good idea to keep new cartridges on hand, since you can't print if either ink cartridge is empty.

Use these EPSON ink cartridges within six months of installing them and before the expiration date on the package:

- Black ink cartridge: S020189
- Color ink cartridge: S020191

Cartridges should be available where you bought your printer. You can also order them from EPSON Accessories at (800) 873-7766 or visit our web site at www.epsonsupplies.com (U.S. sales only). In Canada, please call (800) 873-7766 for dealer referral.

caution:

To ensure good results, use genuine EPSON cartridges and do not refill them. Other products may cause damage to your printer not covered by EPSON's warranty.

Don't remove a cartridge until you have a replacement ready or the print head nozzles may dry out.

If you need to replace an ink cartridge **before** you see a message (because the ink is too old, for example) follow the instructions in “Replacing an Outdated Ink Cartridge” on page 125.

Removing and Installing Ink Cartridges

You can replace a cartridge whenever you see a message that the cartridge is low on ink or empty. (If you press the  cleaning button before you see a message, the EPSON Stylus Scan cleans the print head, as described on page 126.) Follow these steps:

1. Make sure the EPSON Stylus Scan is turned on and not printing. Open the document cover, and then open the maintenance cover. The internal cover opens automatically.

note:

If you've installed the automatic document feeder, remove it from the EPSON Stylus Scan, but don't disconnect it from the option interface.

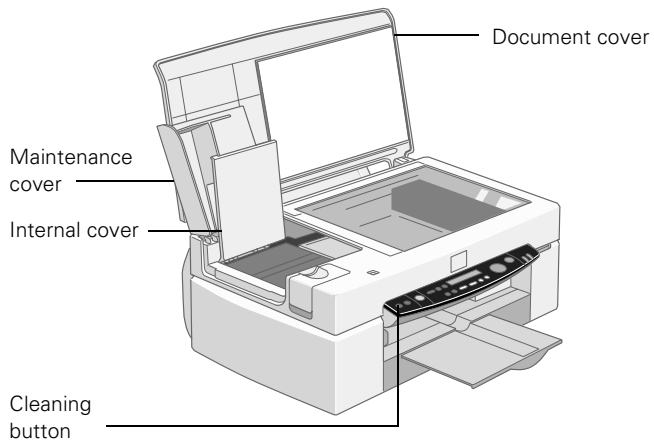

2. Press the  cleaning button and hold it for about three seconds until the print head moves left and the Operate light begins flashing.

caution:

Don't open the clamp or remove a cartridge except to replace it with a new one. Once you remove a cartridge, you can't reuse it, even if it contains ink.

Also, never move the print head by hand.

warning:

If ink gets on your hands, wash them thoroughly with soap and water. If ink gets into your eyes, flush them immediately with water.

Keep ink cartridges out of the reach of children.

caution:

You must remove the yellow tape from the top of the cartridge or you will permanently damage it. Do not remove the clear seal from the bottom of the cartridge, or ink will leak out.

3. Pull up the ink cartridge clamp. The cartridge rises up from its holder.

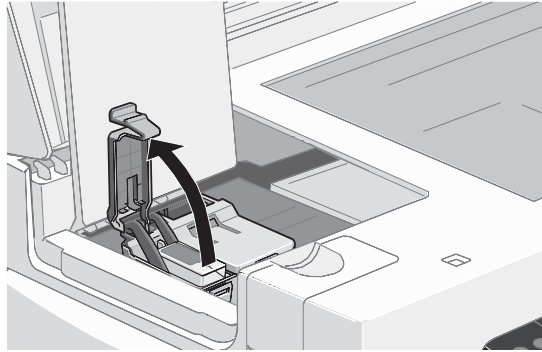

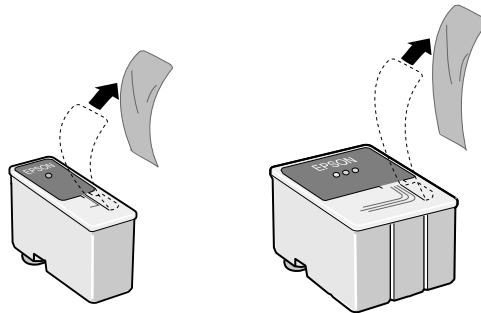

4. Lift the cartridge out of the EPSON Stylus Scan and dispose of it carefully.
5. Remove the new ink cartridge from its package.
6. Remove only the yellow part of the tape seal on top. Don't pull off the blue portion or try to remove the clear seal underneath the cartridge.

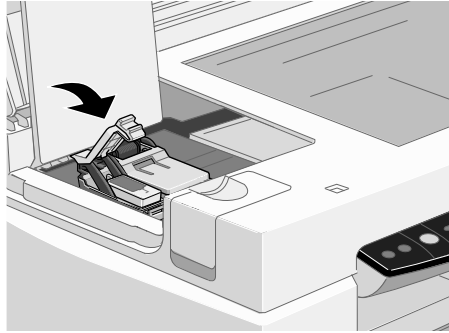

7. Lower the new ink cartridge into its holder with the label facing up and toward the back of the printer. Don't press down on the cartridge.

8. Press down the ink cartridge clamp until it locks in place.



9. If you need to replace the other ink cartridge, repeat steps 3 through 8 before going on to step 10.
10. Close the maintenance and document covers, and then press the  cleaning button.

caution:



Never turn off the printer while the Operate light is flashing, unless the printer hasn't moved or made any noise for more than five minutes.

The EPSON Stylus Scan moves the print head and begins charging the ink delivery system. The **Operate** light flashes and the printer makes various sounds. Charging takes about one minute. When it's finished, the **Operate** light stops flashing and stays on.

Replacing an Outdated Ink Cartridge

Even if you don't see a message that a cartridge is low on ink or empty, you may need to replace it if it's more than six months old. If your printouts don't look as good as they used to, try cleaning and aligning the print head first. If print quality doesn't improve, replace one or both cartridges.

Follow these steps to replace an ink cartridge **before** you see a message on the LCD panel:

1. Make sure the EPSON Stylus Scan is turned on and not printing. Then open the document and maintenance covers.
2. Press the  load/eject button and hold it down for about three seconds until the print head moves left. The **Operate** light begins flashing.
3. Remove the old ink cartridge and install the new cartridge as described in "Removing and Installing Ink Cartridges" on page 122. **Don't press the  cleaning button, however.** Close the maintenance and document covers and press the  load/eject button instead.

The EPSON Stylus Scan moves the print head and begins charging the ink delivery system. The **Operate** light flashes and the printer makes various sounds. Charging takes about one minute. When it's finished, the **Operate** light stops flashing and stays on.

caution:

To avoid damaging the printer, never move the print head by hand.

Never turn off the printer while the Operate light is flashing, unless the printer hasn't moved or made any noise for more than five minutes.

Cleaning the Print Head

If your printouts are light or have gaps in the image, you may need to clean the print head. This unclogs the nozzles so they can deliver ink properly.

Cleaning the print head uses ink, so clean it only if print quality declines. You can clean the print head using either:

- The Head Cleaning utility in your printer software (with the printer connected to a local port, not over a network)
- The EPSON Stylus Scan's control panel buttons.

Using the Head Cleaning Utility

Follow these steps to use the Head Cleaning utility (recommended method):

1. Make sure the EPSON Stylus Scan is turned on but not printing. Also, make sure that there's no ink out message on the LCD panel.
2. Start an application and open a document. Access the printer settings dialog box as described in "Basic Printing with Windows" on page 39 or "Basic Printing on a Macintosh" on page 42.
3. Click the **Utility** tab (Windows) or the  Utility icon (Macintosh). You see the Utility menu.
4. Click the **Head Cleaning** icon.
5. Follow the on-screen instructions to clean the print head.

Cleaning takes a few minutes, during which the EPSON Stylus Scan makes some noise and the **Operate** light flashes. When the **Operate** light stops flashing, continue with the next step.

6. Make sure paper is loaded in the EPSON Stylus Scan and click **Print nozzle check pattern** (Windows) or **Confirmation** (Macintosh). The nozzle check pattern prints. (See page 128 for details.)

caution:

Never turn off the EPSON Stylus Scan while the Operate light is flashing, unless it hasn't moved or made any noise for more than 5 minutes.

7. If the nozzle check pattern is complete, click **Finish**.

If the pattern is missing dots, click **Clean** to run another cleaning cycle. If you don't see any improvement after cleaning two or three times, check the print quality solutions in "Solving Print Quality Problems" on page 145.

You can also turn off the printer and wait overnight—this allows any dried ink to soften—then clean the print head again.

Using the Control Panel to Clean the Print Head

1. Make sure the EPSON Stylus Scan is turned on but not printing. Also, make sure that there's no ink out message on the LCD panel.
2. Press the  cleaning button and hold it down for three seconds. Cleaning takes a few minutes, during which the EPSON Stylus Scan makes some noise and the **Operate** light flashes.
3. After the **Operate** light stops flashing, start an application and open a document. If you're connected directly to the EPSON Stylus Scan, continue with step 4.

If you're on a network, print a short document containing black and color data. Check the quality of your printout, then go to step 8.

4. Access the printer settings dialog box as described in "Basic Printing with Windows" on page 39 or "Basic Printing on a Macintosh" on page 42.
5. Click the **Utility** tab (Windows) or the  Utility icon (Macintosh). You see the Utility menu.
6. Make sure paper is loaded in the printer and click the **Nozzle Check** icon. Then follow the instructions on the screen to run the nozzle check. (See page 128 for details on the nozzle check.)

caution:

Never turn off the EPSON Stylus Scan while the Operate light is flashing, unless it hasn't moved or made any noise for more than 5 minutes.

7. If the nozzle check pattern is complete, click **Finish**.

If the pattern is missing dots, click **Clean** to run another cleaning cycle.

8. If you don't see any improvement after cleaning two or three times, check the print quality solutions in "Solving Print Quality Problems" on page 145.

You can also turn off the printer and wait overnight—this allows any dried ink to soften—then clean the print head again.

Examining the Nozzle Check Pattern

Examine the nozzle check pattern you print. It should look something like this (the upper pattern is black; the lower section is cyan, magenta, and yellow):

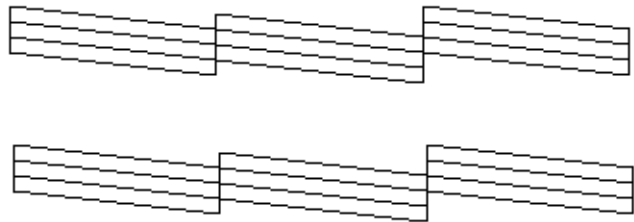

Each staggered horizontal and straight vertical line should be complete, with no gaps in the dot pattern. If your printout looks okay, you're done. If any dots are missing, as shown below, clean the print head again.

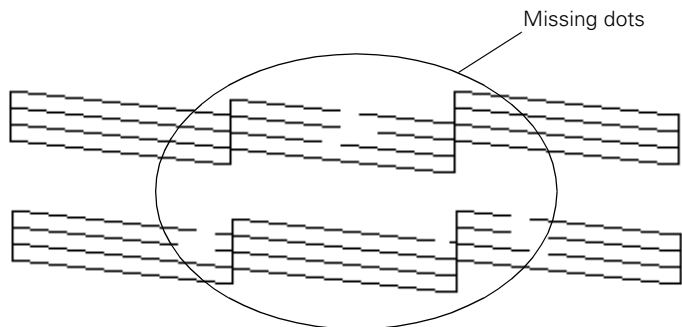

caution:

Load paper that's at least letter-size width to prevent ink from spraying inside the EPSON Stylus Scan and smudging your printouts. For best results, load EPSON ink jet paper whenever you check the print head alignment.

Aligning the Print Head

If your printouts contain vertical bands or crooked vertical lines, you may need to use the Print Head Alignment utility in your printer software. Your EPSON Stylus Scan must be connected directly to a local port, not over a network, to use this utility. Follow these steps:

1. Make sure the EPSON Stylus Scan is turned on and paper is loaded.
2. Start an application and open a document.
3. Access the printer settings dialog box as described in “Basic Printing with Windows” on page 39 or “Basic Printing on a Macintosh” on page 42.
4. Click the **Utility** tab (Windows) or the  Utility icon (Macintosh). You see the Utility menu.
5. Click the **Print Head Alignment** icon. Follow the instructions on the screen to print a test page.
6. Select the most precise alignment pattern from the choices on the test page.
7. Enter the number of the best aligned pattern following the instructions on the screen.

caution:

Never use hard or abrasive brushes, or alcohol or thinners, and never spray lubricants inside the EPSON Stylus Scan. You could damage the printer mechanisms.

Cleaning the EPSON Stylus Scan

To keep your EPSON Stylus Scan operating at its best, clean it several times a year, as described below. For instructions on cleaning the automatic document feeder, see “Cleaning the Paper Path Guide” on page 117.

1. Turn off the EPSON Stylus Scan, unplug the power cord, and disconnect the interface cable.
2. Remove all paper from the sheet feeder.
3. Use a soft brush to clean loose dust and dirt.

warning:

Be careful not to touch the internal gears.

4. Use a soft, clean cloth and mild detergent to clean the outer case and inside of the sheet feeder. Be careful not to soak the cloth—just dampen it. Keep the document and maintenance covers closed to prevent moisture from getting inside.
5. Clean the document table with a soft, dry cloth, or with a blower brush.
6. If ink leaks inside the EPSON Stylus Scan, wipe it away with a damp cloth.

Transporting the EPSON Stylus Scan

For short moves, you can just pick up the EPSON Stylus Scan and set it down. For longer moves, you need to repack it in its original box and lock the print head and transportation lock.

Follow these steps:

1. Turn on the EPSON Stylus Scan and wait until the print head locks in position. Then turn off the EPSON Stylus Scan.
2. Unplug the power cord, then disconnect the interface cable.
3. Open the document and maintenance covers.

caution:

To avoid damage, always leave the ink cartridges installed when transporting the EPSON Stylus Scan. Also, remember to lock the print head and the transportation lock.

4. Push the transportation lock right to lock the scanner carriage.

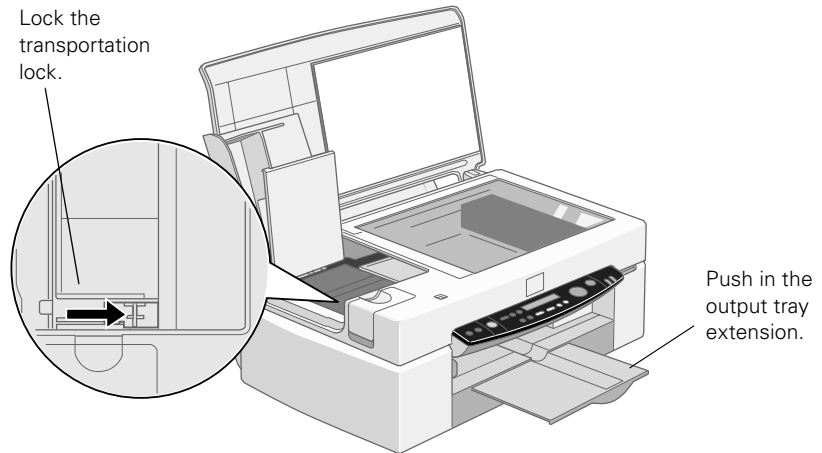

5. Close the maintenance and document covers.
6. Remove all paper from the sheet feeder, and then remove the paper support.
7. Push in the output tray extension.
8. Use tape to secure the document cover. Secure the ink cartridge holder to the printer with tape, as shown below.

caution:

Be sure to remove the tape used in step 8 before printing.

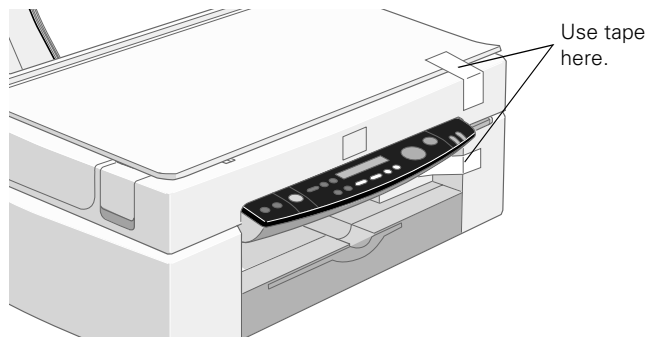

9. Use the original box and packing materials to repack the EPSON Stylus Scan.

Keep the EPSON Stylus Scan level as you transport it.

7 Solving Problems

This chapter gives you the basics for diagnosing and solving problems with your EPSON Stylus Scan.

note:

It's a good idea to check EPSON's web site periodically for possible updates to your drivers. Visit <http://support.epson.com> and check the section for your product to see if there is a new driver available, free of charge, for downloading to your computer. Download instructions are posted for your convenience.



- First see “Diagnosing Problems” to help determine what the cause of the problem may be.
- Then see “Problems and Solutions” on page 137 for solutions to common setup and software problems.

Diagnosing Problems

You can diagnose most problems by checking the LCD panel for a message. The **Error** light may also flash or come on. If a problem occurs while you're printing, you'll see an error message in the progress window on your computer (Windows only). It may also be helpful to try running a printer check; see page 135 for instructions.



Follow these guidelines when you see an error message in the LCD panel:

Message	Problem and Solution
Printer Error	An unknown printer error has occurred. Turn off the EPSON Stylus Scan and contact your dealer.
Call Service	The used ink tank is full. Turn off the EPSON Stylus Scan and contact your dealer.
Scanner Error	The transportation lock may be locked or the fluorescent lamp may need to be replaced. Make sure the transportation lock is in the unlocked position, and then turn the EPSON Stylus Scan off and back on. If it still doesn't operate properly, contact your dealer.

Message	Problem and Solution
ADF Jam	No paper is loaded or paper is jammed in the automatic document feeder. Load paper in the automatic document feeder, or turn off the EPSON Stylus Scan and remove the jammed paper.
ADF Cover Open	Either the automatic document feeder is not flat against the document table or the cover at the back of the automatic document feeder is open. Close the cover or gently push down on the automatic document feeder until it rests on the document table.
Printer Jam	Paper is jammed in the EPSON Stylus Scan. Press the  load/eject button. If the error doesn't clear, remove the jammed paper from the printing area. Check that paper is loaded in the sheet feeder, then press the  load/eject button to resume printing or copying.
Printer Paper Out	There's no paper loaded in the sheet feeder. Load paper into the sheet feeder, then press the  load/eject button to resume printing or copying.
Black Ink Low	The black ink cartridge is nearly empty. You'll need to replace it soon. See page 121 for instructions.
Color Ink Low	The color ink cartridge is nearly empty. You'll need to replace it soon. See page 121 for instructions.
Black Ink Out	The black ink cartridge is empty. Replace it. See page 121 for instructions.
Color Ink Out	The color ink cartridge is empty. Replace it. See page 121 for instructions.
Maint. Cover Open	The EPSON Stylus Scan won't operate if the maintenance cover is open. Close it. See page 136 for help locating it.

Running a Printer Check

You can run a printer check to determine whether the problem comes from the EPSON Stylus Scan or your computer.

1. Make sure both the EPSON Stylus Scan and your computer are turned off.
2. Disconnect the interface cable from the EPSON Stylus Scan.
3. Make sure paper is loaded.
4. Hold down the  load/eject button, then press and release the  Operate button. Continue holding down the  load/eject button until the **Operate** light starts to flash, then release it.

A check page is printed, showing the ROM version number, ink counter, and a nozzle check pattern.

5. After the page is printed, turn off the EPSON Stylus Scan. Then reconnect the interface cable and turn on your EPSON Stylus Scan and computer.
 - If the check page prints, the problem lies in your software settings, the interface cable, or your computer.
 - If the check page does not print, you may have a problem with your EPSON Stylus Scan. Try the suggestions in “Problems and Solutions” on page 137 for more information.

EPSON Stylus Scan Parts

If you need help identifying the parts of the EPSON Stylus Scan, refer to the following illustrations:

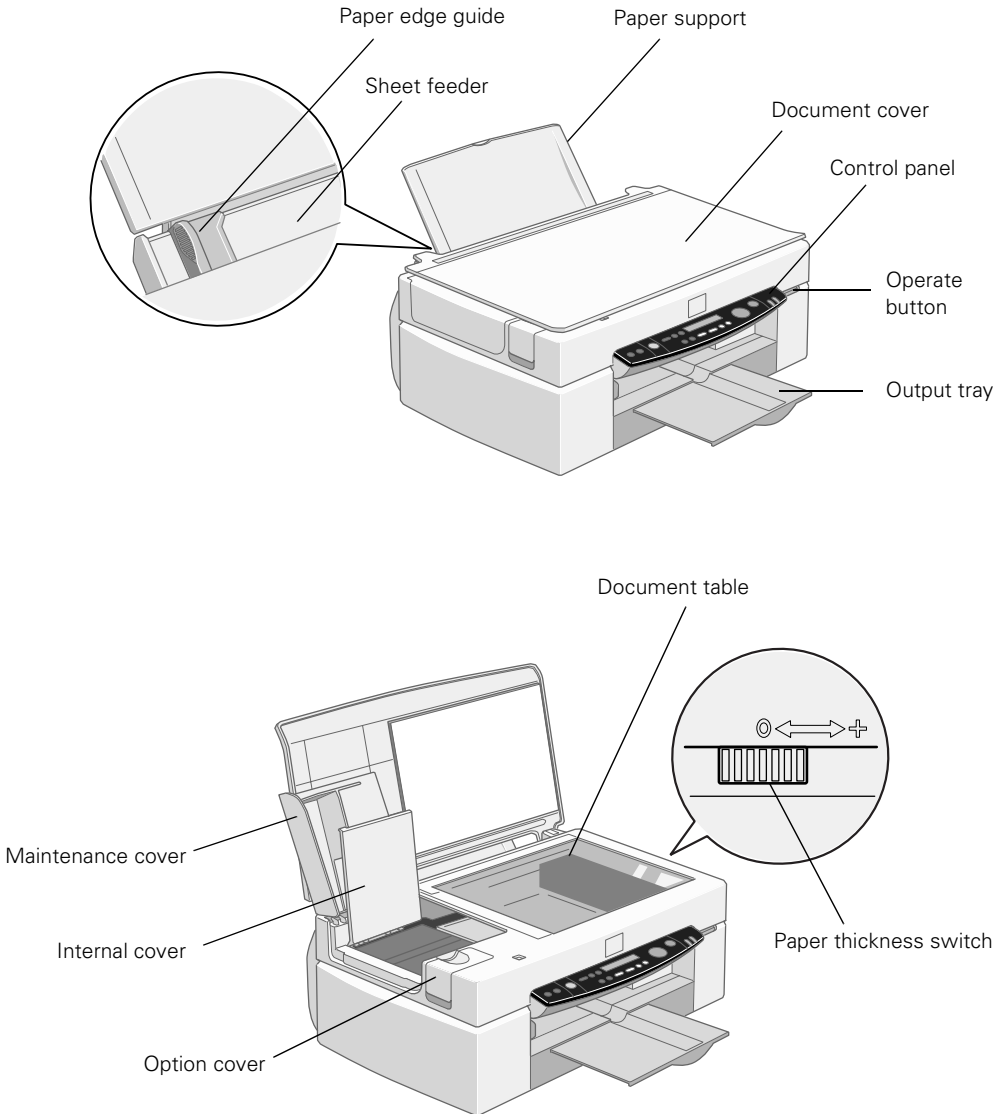

Problems and Solutions

Here are some basic troubleshooting tips if you have any problems setting up your EPSON Stylus Scan, installing software, printing, scanning, or copying, or getting good print and scan quality.

Since copying involves both printing and scanning, look for copy problems in both “Solving Problems with Printing and Copying” on page 140 and “Solving Problems with Scanning and Copying” on page 143.

Solving Problems Setting Up the EPSON Stylus Scan or Installing Its Software

The Operate light doesn't come on or blinks slowly.

Make sure the power cord is securely plugged into the power outlet and the EPSON Stylus Scan is turned on. Also, check that the outlet is working and provides sufficient power.

The printer started making noise after you installed the ink cartridges.

- The first time you install ink cartridges, the printer must charge its ink delivery system for a few minutes. Please wait until charging is finished (the Operate light stops flashing) before you turn off the printer. Otherwise, you will waste ink.
- Make sure the ink cartridge clamps are locked down completely and that no packing material remains in the printer.

The printer has finished charging the ink cartridge, but the Operate light is still flashing.

- Make sure the ink cartridge clamps are locked into place.
- Make sure all packing material has been removed from the printer.
- If the printer is not moving or making noise, but the light is still flashing after 5 minutes have passed, turn the printer off. If the light is still flashing when you turn it back on, contact your EPSON dealer or see “Where To Get Help” on page 154.

You’re having problems installing the software.

- Make sure your EPSON Stylus Scan is plugged in and turned on.
- Make sure you’ve closed all other applications, including any screen savers. Then try installing the software again, following the instructions on the *Start Here* sheet.

When you connect to a USB port on a Windows computer, several USB devices are recognized and installed.

This is the correct installation procedure. Your EPSON Stylus Scan includes a printer, scanner, and internal USB hub. Even though the process may seem repetitious, make sure you don’t cancel out of the installation.

You see the following message: *Setup cannot find the Windows printer files needed to set up the WinFax printer driver.*

Remove the EPSON Stylus Scan 2500 CD-ROM and insert your Windows 95 or Windows 98 CD-ROM. Then click OK. If you don’t have a Windows CD-ROM, locate the Windows source files on your hard disk drive. (They may be in the Win 95 or Win 98 folder.) If you need help locating the Windows source files, contact your computer manufacturer.

You see the following message: *Please insert your WinFax Basic Edition installation media.*

Remove your Windows CD-ROM and insert the EPSON Stylus Scan 2500 CD-ROM. Then click OK.

When you connect it to a parallel pass-through port on your Zip® drive, your EPSON Stylus Scan doesn't work.

The EPSON Stylus Scan is not designed to work on this type of port. You must remove the Zip drive and connect it to a different port. (You may need to install a second parallel port.)

Connect the EPSON Stylus Scan directly to your computer's built-in parallel port. Do not use a switch box. You can also connect the EPSON Stylus Scan to your USB port (Windows 98 only).

After you use your EPSON Stylus Scan with a parallel connection, your Zip drive doesn't work when you reconnect it to the same parallel port.

You may need to reinstall your Zip drive software. To avoid this problem, you can disable the Zip drive in your Windows Device Manager before you connect the EPSON Stylus Scan. See your Windows Help for more information.

You're printing over a network.

See your electronic *EPSON Stylus Scan 2500 Reference Guide* for computer configuration instructions.

Solving Problems with Printing and Copying

Only the Operate light is on, but nothing prints.

- Turn off the EPSON Stylus Scan and your computer. Make sure the interface cable is connected securely. (Use a fully shielded USB “AB” interface cable or an IEEE-1284 compliant parallel cable.)
- Make sure there’s no packing material inside the EPSON Stylus Scan or the automatic document feeder, if you’re using it.
- Run a printer check as described on page 135. If the check page printed, make sure your EPSON Stylus Scan and application software are installed correctly. If you’re printing on a network, you need to set up your EPSON Stylus Scan for network printing, as described in your electronic *EPSON Stylus Scan 2500 Reference Guide*.

note:

If you’re trying to print or copy a large image, your computer may not have enough memory.

The EPSON Stylus Scan sounds as though it is printing, but nothing prints.

Make sure the print head nozzles are not clogged. To run a cleaning cycle, see “Cleaning the Print Head” on page 126.

Your EPSON Stylus Scan makes noise when you turn it on or after it has been sitting for a while.

Your printer is performing routine maintenance.

Printing is too slow.

Make sure your system meets the requirements listed in Chapter 8. If you are printing a high-resolution image, you need more than the minimum requirements listed. You may also need to do the following:

- Clear space on your hard drive or run a defragmentation utility.
- Don't run too many applications at the same time.
- Increase your system's memory (RAM).

For the fastest printing, try the following:

- Choose **Black** ink if your document does not include any other color.
- Set the Quality/Speed slider to **Speed**.
- If you upgraded from Windows 95 to Windows 98, you need to uninstall and reinstall your driver. See page 152 for instructions on uninstalling software.
- If you're using a parallel port, enable ECP/DMA mode. See your computer documentation for instructions.

Solving Problems with Paper Feeding

If your EPSON Stylus Scan doesn't feed paper or feeds multiple pages, or if paper is jammed in it, remove and replace the stack of paper (and remove any jammed paper). Then press the  load/eject button. To prevent paper feeding problems, make sure of the following:

- Paper isn't old, creased, damp, or too thin.
- Fan the stack of paper and then even the edges before loading it.
- The edge guide is against the stack of paper.
- Paper isn't loaded above the arrow on the edge guide.
- Make sure your EPSON Stylus Scan is on a stable, level surface.

If paper doesn't eject fully, you may have set the wrong paper size. Press the  load/eject button to eject the paper. Then make sure you select the correct paper size in your application or print settings.

Solving Miscellaneous Printout Problems

The margins are incorrect.

- Make sure the paper settings are correct for your paper size.
- Check your software documentation for instructions on selecting the correct margins for your paper size.

The image size or position is incorrect.

Make sure the paper and/or layout options are set correctly.

The printer prints blank pages.

- Make sure the EPSON Stylus Scan 2500 is selected in your application. Also, if you're running Windows, make sure it's selected as the Windows default printer. If you have a Macintosh, select **SS 2500** in the Chooser.
- Make sure you have selected the correct paper size.
- Make sure the print head nozzles are not clogged. To run a cleaning cycle, see page 126.

Solving Problems with Scanning and Copying

You can print, but you aren't able to scan.

If you're using a parallel port, make sure you've connected the EPSON Stylus Scan to LPT1. Your scanner won't work if you're using LPT2.

Your EPSON Stylus Scan software doesn't work properly.

- If you're running other software at the same time, using memory resident programs, or using many device drivers, the computer may not have enough memory. Also, if you're scanning a large image or scanning at a high resolution, your computer may not have enough memory to process the image. Try closing other applications or increasing your system's memory (RAM).
- If you're using the EPSON TWAIN software, make sure you select **EPSON Stylus Scan FB** as your TWAIN source.
- Make sure your EPSON Stylus Scan is turned on, and that the interface cable is securely connected at both ends.
- Try restarting your computer. Make sure you turn on the EPSON Stylus Scan before you turn on your computer.

You see one of these messages: *Cannot find the scanner on the bus* (Macintosh) or *Scanner not ready* (Windows).

- Make sure your EPSON Stylus Scan is turned on and securely connected to your computer or USB hub.
- If your EPSON Stylus Scan is connected to a USB hub, make sure it's connected to a first tier hub. The first tier hub is the one closest to the host computer, if more than one hub is connected to the computer.
- If you're copying, make sure **SS 2500** is selected in the Chooser (Macintosh).
- If you're using the EPSON TWAIN software, make sure you select **EPSON Stylus Scan FB** as your TWAIN source.
- Try restarting your computer. Make sure you turn on the EPSON Stylus Scan before you turn on your computer.

When you try to copy on a Macintosh, your original is scanned but not printed.

Open the Chooser, select **SS 2500**, and turn on background printing. Then try copying again.

Solving Print Quality Problems



note:

For other image quality problems when you're copying, see "Solving Scan Quality Problems" on page 150.

You see horizontal banding.

- Make sure the print head nozzles are not clogged. To run a cleaning cycle, see "Cleaning the Print Head" on page 126.
- Make sure the Media Type setting matches the paper you loaded. See "Choosing the Right Settings for EPSON Papers" on page 48 for guidelines.
- Make sure the printable side of the paper is face up. It's usually whiter or shinier.
- Check the LCD panel for a message that you're low on ink; see page 121 for instructions. If your ink cartridge is more than six months old, you may need to replace it; see "Replacing an Outdated Ink Cartridge" on page 125.
- If you see banding when you print, but not when you copy, try using Automatic mode. See "Basic Printing with Windows" on page 39 or "Basic Printing on a Macintosh" on page 42 for instructions.
- Make sure you're not using the Maximum Printable Area setting. Banding may occur in the expanded area.
- Set the paper thickness switch to the 0 position, as shown on page 146.
- Place the EPSON Stylus Scan on a stable, level surface. Make sure none of the five rubber feet is missing from the bottom.



You see vertical banding or misalignment.

- Make sure the print head nozzles are not clogged. To run a cleaning cycle, see “Cleaning the Print Head” on page 126.
- Run the Print Head Alignment utility. See “Aligning the Print Head” on page 129 for instructions.
- Make sure the printable side of the paper is face up. It is usually whiter or shinier.
- Don’t use the High Speed setting in the printer software.
- Set the paper thickness switch to the 0 position.

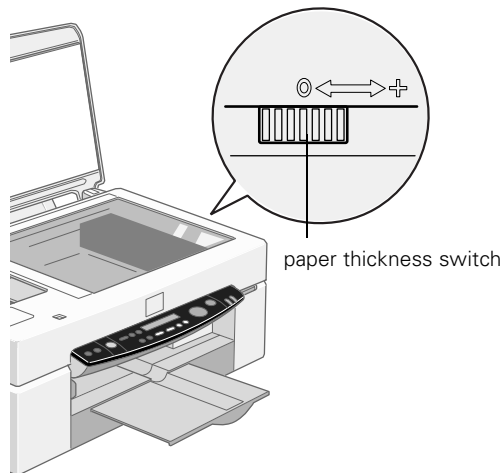

- Place the EPSON Stylus Scan on a stable, level surface. Make sure none of the five rubber feet is missing from the bottom.



note:

Make sure your Media Type setting matches the paper you're using. See "Choosing the Right Settings for EPSON Papers" on page 48 for guidelines. For the best printouts, use EPSON papers and other media.

Your printout is blurry or smeared.

- Make sure your paper isn't damp, curled, or loaded face down (the printable side should be loaded face up).
- Try using Automatic mode. See "Basic Printing with Windows" on page 39 or "Basic Printing on a Macintosh" on page 42 for instructions.
- Use a support sheet with special paper or film, or try loading it one sheet at a time.
- Run the Print Head Alignment utility. See "Aligning the Print Head" on page 129 for details.
- Make sure the print head nozzles are not clogged. To run a cleaning cycle, see "Cleaning the Print Head" on page 126.
- If you're using the automatic document feeder, try cleaning the paper path guide. Follow the instructions on page 117.
- Check the paper thickness switch position. If it's in the + position, your printer is set for thicker paper or envelopes and your image may smear. For most papers, set the paper thickness switch to the 0 position, as shown on page 146.

Your printout is faint or has gaps in the image.



- Make sure the print head nozzles are not clogged. To run a cleaning cycle, see “Cleaning the Print Head” on page 126.
- Check the LCD panel for a message that you’re low on ink; see page 121 for instructions.
- Make sure the **Media Type** setting matches the paper you’re using. See “Choosing the Right Settings for EPSON Papers” on page 48 for guidelines.
- Make sure your paper isn’t damaged, old, dirty, or loaded face down.
- Try using Automatic mode. See “Basic Printing with Windows” on page 39 or “Basic Printing on a Macintosh” on page 42 for instructions.

Your printout is grainy.

- Try using a higher quality paper.
- Run the Print Head Alignment utility. See “Aligning the Print Head” on page 129 for instructions.
- You may need to increase the image resolution or print it in a smaller size. See your software documentation for instructions.

Your printout has incorrect or missing colors.

- Make sure you selected the **Color Ink** setting for color images.
- Make sure the print head nozzles are not clogged. To run a cleaning cycle, see “Cleaning the Print Head” on page 126.
- If you are printing a high-resolution image, turn off PhotoEnhance™ as described on page 45.
- Try using Automatic mode. See “Basic Printing with Windows” on page 39 or “Basic Printing on a Macintosh” on page 42 for instructions.
- Your printed colors can never exactly match your on-screen colors. However, you can use a color management system to get as close as possible. For information on your printer software’s color matching options, see your electronic *EPSON Stylus Scan 2500 Reference Guide*.

Your printout contains incorrect characters.

- Make sure the interface cable is connected securely at both ends.
- Make sure your EPSON Stylus Scan 2500 is selected as the current printer in your application or as the Windows default printer. If you have a Macintosh, make sure SS 2500 is selected in the Chooser.
- Make sure there aren’t any stalled print jobs. If there are, delete them and then try printing again.
- Don’t use a switch box with your printer.

Color documents print in black and white.

- Make sure your printer and port are selected in your software application.
- Make sure color printing is selected in your application and the printer software.



Solving Scan Quality Problems

The scanned image is slanted or crooked.

- Make sure the original document is positioned so that the horizontal and vertical edges are carefully aligned with the scales along the sides of the document table.
- If you're using the automatic document feeder, make sure the document guides fit snugly against the edges of the original document.
- If you're using EPSON Smart Panel's Copy utility, select **Straighten Only** in the Automatic Photo Layout box.



The scanned image quality is poor.

- If you're scanning or copying a photograph using EPSON Smart Panel, make sure you select **Photo** as your Scan Material or Document Type. If you're using EPSON TWAIN, select **Color Photo** (or **Black & White Photo** if your photo is black and white) as your Image Type.
- If you're using EPSON TWAIN, adjust your **Resolution** setting.
- If you're using EPSON Smart Panel to scan a picture in a magazine or newspaper, make sure you choose **Magazine**, **Newspaper**, or **Brochure** as your Scan Material setting.
- If you're using the automatic document feeder, try cleaning the paper path guide. Follow the instructions on page 117.
- If you're copying a photograph, use the EPSON Photo Paper in your Media Pack for the best results.

Something is missing or incorrect in the scanned image.

- If your page is blank, make sure you place the original document face down on the document table. If you're using the automatic document feeder, make sure you load the document face up in the feeder.
- If text is missing or incorrect in your scanned image, try using the TWAIN software to adjust the **Threshold** setting. See your electronic *EPSON Stylus Scan 2500 Reference Guide* for more information.
- If your original document contains both text and graphics, text may not be recognized correctly by the OCR software.
- If you're using the TWAIN software, make sure you select the **Quality & De-screening** setting.

Vertical lines are missing from the final image.

Make sure your original is not wrinkled and the glass on the document table is clean. See "Cleaning the EPSON Stylus Scan" on page 129 for cleaning instructions.

You see vertical banding or misalignment on your copy.

See the solutions on page 146.

You see horizontal banding on your copy.

See the solutions on page 145.

The scanned image is faint or out of focus.

- Make sure the original document is placed flat on the document table.
- Check if your original document is damaged, dirty, or wrinkled; these imperfections will mar your scan or copy.
- Adjust the **Gamma** and **Exposure** settings in your EPSON TWAIN software.

note:

For other image quality problems when you're copying, see "Solving Print Quality Problems" beginning on page 145.

Straight lines in the image appear jagged.

Make sure the edges of your original document are carefully aligned with the scales on the sides of the document table.

The edges of the document are not scanned or copied.

Check the position of your original document. Adjust your document's position so that the image is within the glass area.

Uninstalling the EPSON Stylus Scan Software

If you need to uninstall your EPSON Stylus Scan software, follow the steps for your operating system and type of connection:

Uninstalling in Windows (USB Connection)

1. Click **Start**, point to **Programs**, **EPSON Smart Panel**, and click **Uninstall EPSON Smart Panel**. Then follow the instructions on the screen.
2. Double-click the **My Computer** icon, then double-click the **Control Panel** icon.
3. Double-click the **Scanners and Cameras** icon, select **EPSON Stylus Scan 2500**, click **Remove**, then click **OK**.
4. Double-click **Add/Remove Programs**, select **EPSON Printer Software**, then click **Add/Remove**.
5. Select the **EPSON Stylus Scan 2500** printer icon and click **OK**. Then follow the instructions on the screen.
6. After uninstall is complete, select **EPSON USB Printer Devices**, click **Add/Remove**, then follow the instructions on the screen. Your computer restarts automatically.

To reinstall your software, follow the instructions on your *Start Here* sheet.

Uninstalling in Windows (Parallel Connection)

1. Click **Start**, point to **Programs**, **EPSON Smart Panel**, and click **Uninstall EPSON Smart Panel**. Then follow the instructions on the screen.
2. To uninstall the parallel scanner driver, click **Start**, point to **Programs**, **EPSON Stylus Scan**, and click **Uninstall EPSON Stylus Scan FB TWAIN**. Then follow the instructions on the screen.
3. Double-click **My Computer**, then double-click the **Control Panel** icon.
4. Double-click **Add/Remove Programs**, select **EPSON Printer Software**, then click **Add/Remove**.
5. Select the **EPSON Stylus Scan 2500** printer icon and click **OK**. Then follow the instructions on the screen.
6. After uninstall is complete, restart your computer.

To reinstall your software, follow the instructions on your *Start Here* sheet.

Uninstalling on a Macintosh

1. Insert the EPSON Stylus Scan 2500 CD-ROM in your drive.
2. Double-click the EPSON SS2500 CD-ROM icon.
3. Scroll down to the EPSON Stylus Scan 2500 folder and double-click its icon.
4. Double-click the EPSON Stylus Scan 2500 icon in the folder.
5. Click the arrow next to Easy Install and select **Remove**.
6. Click the **Remove** button at the bottom of the window.
7. When it's finished, click **OK**. Then click **Quit**.

To reinstall your software, follow the instructions on your *Start Here* sheet.

Where To Get Help

If you need help with your EPSON Stylus Scan or its drivers, see the contact information below. For help with Smart Panel, WinFax, FAXstf, Adobe PhotoDeluxe, or eFax, see page 155 for contact information.

EPSON Technical Support

EPSON provides technical assistance 24 hours a day through the electronic support services and automated telephone services listed in the following table:

Service	Access
World Wide Web	From the Internet, you can reach EPSON Support at http://support.epson.com . At this site, you can download drivers and other files, look at documentation such as product brochures and user manuals, and access troubleshooting information.
EPSON Internet FTP Site	If you have Internet FTP capability, use your Web browser (or other software for FTP downloading) to log onto ftp.epson.com with the user name anonymous and your e-mail address as the password.
EPSON E-MAIL Technical Support	To receive technical advice through e-mail, go to http://support.epson.com and complete the form under the troubleshooting tab, as requested.
Automated Telephone Services	A variety of automated help services are available 24 hours a day, seven days a week. To use these services, you must have a touch tone telephone and call (800) 922-8911 .

To speak directly to a technical support representative, dial:

- U.S.: (562) 276-4382, 6 AM to 8 PM, Pacific Time, Monday through Friday and 7 AM to 4 PM, Saturday. Toll or long distance charges may apply.
- Canada: (905) 709-2567, 6 AM to 6 PM, Pacific Time, Monday through Friday. Toll or long distance charges may apply.

Before you call, please have the following information ready:

- Product name (EPSON Stylus Scan 2500)
- Product serial number (located on the back of the printer)
- Proof of purchase (such as a store receipt) and date of purchase
- Computer configuration
- Description of the problem

You can purchase ink cartridges, paper, manuals, and accessories from EPSON Accessories at (800) 873-7766 or visit our web site at www.epsonsupplies.com (U.S. sales only). In Canada, please call (800) 873-7766 for dealer referral.

If you need help using another manufacturer's software with an EPSON product, see the documentation for that software for technical support information.

Technical Support for Other Software

If you need technical assistance with EPSON Smart Panel, WinFax, FAXstf, Adobe PhotoDeluxe, or eFax, contact the software manufacturer as described in the table below:

Software	Online and E-Mail	Fax	Phone
EPSON Smart Panel WinFax FAXstf	www.newsoftinc.com tech@newsoftinc.com	(510) 445-8601	(510) 445-8616
Adobe PhotoDeluxe	www.adobe.com/prodindex/photodeluxe.gethelp.html techdocs@adobe.com	(650) 556-8481 Fax-on-demand system	Windows: (900) 555-2200 Macintosh: (900) 555-3300 \$2.00 per minute
eFax	www.efax.com	—	—

8

Notices

Check this chapter for system requirements, safety instructions, and other important information about your EPSON Stylus Scan 2500.

Windows System Requirements

- An IBM® compatible PC with at least a 486/66 MHz processor (Pentium® processor recommended)
- Microsoft Windows 95 or 98
- At least 16MB of RAM (32MB or more recommended)
- At least 50MB of free hard disk space (100MB recommended)
- VGA or better display adapter and monitor (24-bit color recommended)
- Double-speed (2x) CD-ROM drive for installing the software (quad-speed [4x] or faster recommended)

Your system should have one of the following interfaces (USB recommended):

- An available USB port or hub connection on a computer running Windows 98 with a Windows 98 compliant USB port and a shielded USB “AB” interface cable up to 6.5 feet (2 meters) long
- An available parallel port with a high-speed, bidirectional, IEEE-1284-compliant parallel cable up to 10 feet (3 meters) long. The cable must have a D-SUB, 25-pin, male connector for your computer and a 36-pin, Centronics® compatible connector for the EPSON Stylus Scan

caution:

Using an improperly shielded USB cable—especially a cable more than 6.5 feet (2 meters) long—may cause the EPSON Stylus Scan to malfunction.

The EPSON Stylus Scan cannot be used with a switch box or a parallel pass-through port (for example, on a Zip drive).

Macintosh System Requirements

- iMac series or Power Macintosh® G3 or later with a built-in USB port
- Mac OS 8.1 or later (8.5 or later recommended)
- At least 32MB of available memory (64MB recommended)
- At least 50MB of free hard drive space (100MB recommended)
- VGA or better monitor (24-bit color recommended)
- Double-speed (2x) CD-ROM drive (quad-speed [4x] or faster recommended) for installing the software
- Available USB port or hub connection, with shielded USB “AB” interface cable, from Series A (computer) to Series B (EPSON Stylus Scan), up to 6.5 feet (2 m) long

If you have an iMac, you may need to update your operating system before installing your printer software:

- If you’re running OS 8.1, you must install iMac Update 1.0
- If you’re running OS 8.5 or 8.5.1, Apple recommends that you install iMac Update 1.1

Download the update for your system from Apple at <http://asu.info.apple.com>. Contact Apple if you have problems installing an update.

To find out which operating system your iMac is running, select **About This Computer** from the Apple menu.

caution:

Using an improperly shielded USB cable—especially a cable more than 6.5 feet (2 meters) long—may cause the EPSON Stylus Scan to malfunction.



ENERGY STAR Compliance

As an ENERGY STAR Partner, EPSON has determined that this product meets the ENERGY STAR guidelines for energy efficiency. The EPA ENERGY STAR office equipment program is a voluntary partnership with the computer and office equipment industry to promote the introduction of energy-efficient personal computers, monitors, printers, fax machines, and copiers in an effort to reduce air pollution caused by power generation.

Options

You can purchase the following options for your EPSON Stylus Scan:

- Transparency unit (B813172)— Also called a film adapter, this device lets you to scan transparent materials, such as film strips and slides. See the *EPSON Stylus Scan 2500 Reference Guide* for instructions on installing and using the transparency unit.
- Automatic document feeder (B813142)— Lets you scan or copy documents of up to 20 pages. See “Using the Automatic Document Feeder” on page 111 for more information. If you have the EPSON Stylus Scan 2500 Pro model, the automatic document feeder came with the product.

You can purchase these options from EPSON Accessories at (800) 873-7766 or visit our web site at www.epsonsupplies.com (U.S. sales only). In Canada, please call (800) 873-7766 for dealer referral.

Important Safety Instructions

Before using your EPSON Stylus Scan 2500, read the following safety instructions to make sure you use it safely and effectively:

- Be sure to follow all warnings and instructions marked on the EPSON Stylus Scan.
- Place the EPSON Stylus Scan on a flat, stable surface that extends beyond the base in all directions. The EPSON Stylus Scan will not operate correctly if it is tilted or at an angle.
- Avoid locations with high temperature or humidity, direct sunlight or dusty conditions, poor ventilation, subject to shock and vibration, or near sources of heat or electromagnetic interference, such as a cordless telephone base unit.
- Leave enough room around the EPSON Stylus Scan to allow for sufficient ventilation.
- Use only the type of power source indicated on the label.
- Place the EPSON Stylus Scan near a grounded wall outlet where it can be easily unplugged.

Placez l'imprimante près d'une prise de contact où la fiche peut être débranchée facilement.

- Don't use an outlet that can be turned off by a wall switch or timer, or one on the same circuit as an appliance. This may disrupt the power, which can erase the printer's memory or damage its power supply.
- Connect all equipment to properly grounded power outlets. Avoid using outlets on the same circuit as photocopiers or air control systems that regularly switch on and off.
- Do not let the power cord become damaged or frayed.

note:

Always turn the printer off using the  Operate button. Don't switch off the power strip, or unplug the printer until the power light is off.

- If you use an extension cord with the EPSON Stylus Scan, make sure the total ampere rating of the devices plugged into the extension cord does not exceed the cord's ampere rating. Also, make sure the total ampere rating of all devices plugged into the wall outlet does not exceed the wall outlet's ampere rating.
- Turn off and unplug the EPSON Stylus Scan before cleaning. Clean with a damp cloth only. Do not spill liquid on the EPSON Stylus Scan.
- Do not block or cover the openings in the case or insert objects through the slots.
- Except as specifically explained in this manual, do not attempt to service the EPSON Stylus Scan yourself.
- Unplug the printer and refer servicing to qualified service personnel under the following conditions:

If the power cord or plug is damaged; if liquid has entered the printer; if the printer has been dropped or the case damaged; if the printer does not operate normally or exhibits a distinct change in performance. Adjust only those controls that are covered by the operating instructions.

Ink Cartridge Safety Instructions

- Install the ink cartridge immediately after you remove it from its foil package. Leaving the cartridge unpacked for a long time before use may result in reduced print quality.
- Under normal circumstances, ink will not come out of the cartridge. If it does get on your skin, wash it off with soap and water. If it gets in your eyes, flush them immediately with water.
- Keep ink cartridges out of the reach of children and do not drink the ink.
- Do not move the print head by hand; otherwise you may damage the printer.

- Do not put your hand inside the EPSON Stylus Scan or touch the cartridge during printing.
- Once you install an ink cartridge, do not open the clamp or remove the cartridge except to replace it with a new one. The cartridge may become unusable otherwise.
- Do not use an ink cartridge beyond the date printed on the cartridge package. For best results, use up the ink cartridges within six months of installing them.
- Do not shake an ink cartridge; this can cause leakage.
- Do not dismantle the ink cartridges or try to refill them. This could result in damage to the print head.
- Before transporting the EPSON Stylus Scan, make sure the print head is capped in the far right position and the ink cartridges are in place. Also lock the transportation lock and tape the ink cartridge holders to the case as described on page 130.

DECLARATION of CONFORMITY

According to 47CFR, Part 2 and 15 for Class B Personal Computers and Peripherals; and/or CPU Boards and Power Supplies used with Class B Personal Computers:

We: EPSON AMERICA, INC.
Located at: MS: 6-43
3840 Kilroy Airport Way
Long Beach, CA 90806-2469
Telephone: (562) 290-5254

Declare under sole responsibility that the product identified herein, complies with 47CFR Part 2 and 15 of the FCC rules as a Class B digital device. Each product marketed, is identical to the representative unit tested and found to be compliant with the standards. Records maintained continue to reflect the equipment being produced can be expected to be within the variation accepted, due to quantity production and testing on a statistical basis as required by 47CFR §2.909. Operation is subject to the following two conditions: (1) this device may not cause harmful interference, and (2) this device must accept any interference received, including interference that may cause undesired operation.

Trade Name: EPSON
Type of Product: Multi Function Printer
Model: C130A
Product: EPSON Stylus Scan 2500

FCC Compliance Statement

For United States Users

This equipment has been tested and found to comply with the limits for a Class B digital device, pursuant to Part 15 of the FCC Rules. These limits are designed to provide reasonable protection against harmful interference in a residential installation. This equipment generates, uses, and can radiate radio frequency energy and, if not installed and used in accordance with the instructions, may cause harmful interference to radio or television reception. However, there is no guarantee that interference will not occur in a particular installation. If this equipment does cause interference to radio and television reception, which can be determined by turning the equipment off and on, the user is encouraged to try to correct the interference by one or more of the following measures:

- Reorient or relocate the receiving antenna.
- Increase the separation between the equipment and receiver.
- Connect the equipment into an outlet on a circuit different from that to which the receiver is connected.
- Consult the dealer or an experienced radio/TV technician for help.

WARNING

The connection of a non-shielded equipment interface cable to this equipment will invalidate the FCC Certification of this device and may cause interference levels which exceed the limits established by the FCC for this equipment. It is the responsibility of the user to obtain and use a shielded equipment interface cable with this device. If this equipment has more than one interface connector, do not leave cables connected to unused interfaces. Changes or modifications not expressly approved by the manufacturer could void the user's authority to operate the equipment.

For Canadian Users

This Class B digital apparatus meets all requirements of the Canadian Interference-Causing Equipment Regulations.

Cet appareil numérique de la classe B respecte toutes les exigences du Règlement sur le matériel brouilleur du Canada.

EPSON AMERICA, INC. LIMITED WARRANTY

What Is Covered: Epson America, Inc. (“Epson”) warrants to the first end user customer that the EPSON product covered by this limited warranty statement, if purchased and used in the United States or Canada, conforms to the manufacturer’s specifications and will be free from defects in workmanship and materials for a period of one year from the date of original purchase. EPSON also warrants that the consumable ink cartridges enclosed with the product will perform to the manufacturer’s specified usage, which usage may expire before the expiration of the limited warranty for the EPSON printer.

What Epson Will Do To Correct Problems: Should your EPSON product prove defective during the warranty period, please call the EPSON Connection at (562) 276-4382 (U.S.) or (905) 709-2567 (Canada) for warranty repair instructions and return authorization. An Epson service technician will provide telephone diagnostic service to determine whether the unit requires repair. If service is needed during the warranty period, Epson will, at its option, exchange or repair the unit, without charge for parts or labor. If Epson authorizes sending a replacement unit in exchange for the defective unit, Epson will ship the replacement product, freight prepaid. You are responsible for securely packaging the defective unit and returning it to Epson within five (5) working days of receipt of the replacement. You must provide a credit card number to secure the cost of the replacement unit, in the event that you fail to return the original product. Epson will exchange the same model product as your original unit, or, at Epson’s option, will exchange another model with equivalent features. If your product is being repaired, Epson will direct you where to send the unit. You will be responsible for packing the product and for shipping costs to and from the Epson authorized service center. When warranty service involves the exchange of the product or of a part, the item replaced becomes Epson property. The exchanged product or part may be new or refurbished to the Epson standard of quality. Exchange products and parts assume the remaining warranty period of the product covered by this limited warranty. For all warranty service, you must provide proof of the date of original purchase.

What This Warranty Does Not Cover: This warranty covers only normal use in the United States and Canada. This warranty does not cover damage to the EPSON product caused by parts or supplies not manufactured, distributed or certified by Epson. This warranty does not cover ink cartridges or third party parts, components, or peripheral devices added to the EPSON product after its shipment from Epson, e.g., dealer or user-added boards or components. Epson is not responsible for warranty service should the Epson label or logo or the rating label or serial number be removed or should the product fail to be properly maintained or fail to function properly as a result of misuse, abuse, improper installation, neglect, improper shipping, damage caused by disasters such as fire, flood, and lightning, improper electrical current, software problems, interaction with non-Epson products, or service other than as authorized by Epson. If a claimed defect cannot be identified or reproduced in service, you will be responsible for costs incurred.

THE WARRANTY AND REMEDY PROVIDED ABOVE ARE EXCLUSIVE AND IN LIEU OF ALL OTHER EXPRESS OR IMPLIED WARRANTIES INCLUDING, BUT NOT LIMITED TO, THE IMPLIED WARRANTIES OF MERCHANTABILITY OR FITNESS FOR A PARTICULAR PURPOSE. SOME LAWS DO NOT ALLOW THE EXCLUSION OF IMPLIED WARRANTIES. IF THESE LAWS APPLY, THEN ALL EXPRESS AND IMPLIED WARRANTIES ARE LIMITED TO THE WARRANTY PERIOD IDENTIFIED ABOVE. UNLESS STATED HEREIN, ANY STATEMENTS OR REPRESENTATIONS MADE BY ANY OTHER PERSON OR FIRM ARE VOID. NEITHER EPSON AMERICA, INC. NOR ITS AFFILIATES SHALL BE LIABLE FOR ANY LOSS, INCONVENIENCE, OR DAMAGE, INCLUDING DIRECT, SPECIAL, INCIDENTAL, OR CONSEQUENTIAL DAMAGES, RESULTING FROM THE USE OR INABILITY TO USE THE EPSON PRODUCT, WHETHER RESULTING FROM BREACH OF WARRANTY OR ANY OTHER LEGAL THEORY.

In Canada, warranties include both warranties and conditions.

Some jurisdictions do not allow limitations on how long an implied warranty lasts and some jurisdictions do not allow the exclusion or limitation of incidental or consequential damages, so the above limitations and exclusions may not apply to you. This warranty gives you specific legal rights, and you may have other rights which vary from jurisdiction to jurisdiction.

Epson America, Inc. ● P.O. Box 93012 ● Long Beach, CA 90809-9941 ● MS:6-40

Index

A

- Accessories, ordering, 121, 155, 159
- Adobe Acrobat Reader, using, 7 to 8
- Aligning the print head, 129, 146
- Applications
 - changing properties in Smart Panel, 100
 - registering in Smart Panel, 98 to 99
 - removing from Smart Panel, 100
- Automatic document feeder
 - cleaning paper path guide, 117 to 119
 - clearing paper jams, 115 to 116
 - installing, 111 to 113
 - loading original document, 20, 114 to 115
 - option cover, 112
 - ordering, 159
 - problems, 134

B

- Background printing, 43
- Banding problems, 129, 145 to 146
- Blank pages, 142
- Blurry printouts, 147
- Brightness, 30
- Buttons, control panel, 21 to 22

C

- Cable requirements, 157 to 158
- Catalog, PrintFun, 66 to 68
- Cleaning
 - EPSON Stylus Scan, 129 to 130
 - paper path guide, 117 to 119
 - print head, 126 to 128

Color

- copy settings, 30
- correcting in scans, 72 to 74
- problems, 149
- ColorSync, 46
- Contrast, 30
- Control panel
 - cleaning print head, 127 to 128
 - using, 21 to 22
- Copy Utility
 - adjusting brightness, 30
 - adjusting colors, 30
 - adjusting contrast, 30
 - adjusting copy size, 25 to 27
 - adjusting quality, 25
 - adjusting saturation, 30
 - advanced settings, 28 to 31, 34
 - automatic enhancements, 28
 - basic copying, 23 to 25
 - collating multiple copies, 30 to 31
 - Media Type setting, 24
 - monotone conversions, 29 to 30
 - multiple copies on a page, 29
 - multiple pages, 24
 - photographs, copying, 24
 - previewing image, 27
 - saving settings, 34
 - scaling, 26 to 27
 - straightening the image, 29
 - text, copying, 24
 - time stamps, 31 to 33
 - using, 23 to 34
 - watermarks, 31 to 33

Copying

- adjusting colors, 30
- darkening and lightening, 22
- photographs, 22, 24, 28 to 29
- positioning the original document, 20
- previewing image, 27
- problems, 140 to 141, 143 to 152
- reducing and enlarging, 22
- setting Media Type, 24
- setting number of copies, 22
- setting paper size, 21, 27
- setting quality, 22, 25
- straightening the image, 29
- text, 22, 24
- using control panel, 21 to 22
- using the Copy Utility, *see* Copy Utility
- without the computer, 21 to 22

Crooked images, 150

D

Declaration of Conformity, 163

Diagnosing problems, 133 to 135

Document Type setting, 24, 28, 34

Documentation

- location of electronic manuals, 5 to 8
- using, 4 to 8

E

Economy setting, 46

eFax, 109 to 110, 155

ENERGY STAR, 159

Envelopes, loading, 38

EPSON

- Accessories, 121, 155, 159
- help, 154 to 155
- paper, 48
- web site, 133, 154

EPSON Monitor3, 44

Error messages, 133 to 134

F

Faint images, 148, 151

Faxing

- problems, 138 to 139
- using eFax, 109 to 110
- using WinFax, 103, 138 to 139, 155
- with Smart Panel, *see* Scan to Fax

FAXstf, 103, 106 to 107, 155

FCC Compliance Statement, 164

Features, 1 to 3

Focus problems, 151

G

Grainy printouts, 148

Graph setting, 46

H

Head Cleaning Utility, 126 to 128

Help, 154 to 155

I

ICM (Image Color Matching) setting, 46

Image quality problems, 117, 145 to 152

Image size, 25 to 27, 142

Image Viewer, 88, 96

Incorrect characters in printout, 149

Incorrect colors in printout, 149

Ink cartridges

- level of ink in, 41, 43
- ordering, 121
- outdated, 125
- replacing, 121 to 125
- safety instructions, 161 to 162

Installation problems, 137 to 139

Installing

- automatic document feeder, 111 to 113
- ink cartridges, 121 to 125

Internal cover, 136

L

- Layout settings
 - copying, 29, 31 to 33
 - in OCR processing, 78
 - Photo Print, 54 to 55
 - PrintFun, 63
 - printing, 41, 43
- LCD messages, 21 to 22, 133 to 134
- Loading paper, 36 to 38
- Lock, transportation, 130 to 131, 133

M

- Macintosh
 - basic printing, 42 to 47
 - ColorSync, 46
 - EPSON Monitor3, 44
 - PrintFun, *see* PrintFun
 - system requirements, 158
 - uninstalling software, 153
- Maintenance, 121 to 131
- Maintenance cover, 134, 136
- Manuals, locating electronic, 5 to 8
- Margins, incorrect, 142
- Media Type setting
 - copying, 24
 - Photo Print, 56
 - PrintFun, 64, 66
 - printing, 36, 48
- Menu Mode, accessing, 21
- Missing colors, 149
- Moving the EPSON Stylus Scan, 130 to 131

N

- Network printing, 139
- Noise, 137, 140
- Nozzle check pattern, 126 to 128

O

- OCR, *see* Scan to OCR
- Operate light, 137 to 138, 140
- Option cover, 112
- Options, ordering, 121, 155, 159

P

- Palette mode, using, 18
- Paper
 - choosing, 35 to 36
 - EPSON, 48
 - feeding problems, 115 to 116, 141 to 142
 - handling, 36 to 38
 - jams, 115 to 116, 134, 141 to 142
 - loading, 36 to 38
 - Media Type settings, 36, 48
 - size, 21, 40, 42, 54, 63, 66
 - thickness switch, 38, 136, 145 to 147
- Paper path guide, cleaning, 117 to 119
- Parallel port problems, 139
- Parts, identifying, 136
- Photo Paper, 37, 48
- Photo Print
 - cutting guide, 57
 - layout settings, 54 to 55
 - Media Type settings, 56
 - opening images, 52
 - paper size, 54
 - PhotoEnhance, 57
 - printing photos, 53 to 57
 - scanning photos, 49 to 51
 - trimming settings, 57
 - using, 49 to 57
- PhotoDeluxe
 - selecting TWAIN source, 70
 - support, 155
 - using with Smart Panel, *see* Scan for Creativity
- PhotoEnhance setting, 45, 57
- Positioning the original document, 20
- Presto! Wrapper, 89
- Previewing image, 27, 72
- Previewing printout, 43
- Print head
 - aligning, 129, 146
 - cleaning, 126 to 128
- Print quality problems, 145 to 149
- Printer check, running, 135
- Printer software, 39 to 48

PrintFun

- layout settings, 63
- Media Type settings, 64, 66
- opening images, 62
- printing catalog, 66 to 68
- printing photos, 63 to 65
- scanning photos, 58 to 61
- titles, 64 to 65, 67 to 68

Printing

- basic, Macintosh, 42 to 47
- basic, Windows, 39 to 41
- color management, 46
- enhancing photographs, 45
- loading paper, 36 to 38
- Photo Print, *see* Photo Print
- PrintFun, *see* PrintFun
- problems, 140 to 142
- with custom settings, 44 to 47

Problems

- banding, 129, 145 to 146
- blank pages, 142
- blurry printouts, 147
- color, 149
- copying, 140 to 141, 143 to 152
- diagnosing, 133 to 135
- faint images, 148, 151
- faxing, 138 to 139
- focus, 151
- grainy printout, 148
- image quality, 145 to 152
- image size, 142
- incorrect characters, 149
- incorrect or missing colors, 149
- installing software, 137 to 139
- margins, 142
- miscellaneous printing problems, 142
- network, 139
- paper feeding, 115 to 116, 141 to 142
- parallel port, 139
- print quality, 145 to 149
- printing, 140 to 142
- scan quality, 150 to 152

Problems (continued)

- scanning, 143 to 152
- setting up EPSON Stylus Scan, 137 to 139
- smearing, 147
- USB, 138
- vertical lines missing, 151
- WinFax, 138 to 139
- Zip drive, 139

Progress Meter, 41

Project types, printing, 45 to 46

Q

Quick scanning, 101 to 102

R

Reference Guide, reading, 5 to 7

Registering, 5

Registering applications in Smart Panel, 98 to 99

Removing applications from Smart Panel, 100

Replacing ink cartridges, 121 to 125

S

Safety instructions, 160 to 162

Saturation, 30, 74

Scaling an image, 26 to 27

Scan button, 69, 101 to 102

Scan for Creativity

- creating Macintosh project, 94
- creating Windows project, 92 to 93
- scanning, 91 to 92

Scan to Application

- registering applications, 98 to 99
- removing applications, 100
- using, 95 to 97

Scan to E-mail

- file formats, 89
- Presto! Wrapper, 89
- previewing image, 87
- scanning, 85 to 88
- sending, 89 to 90

- Scan to Fax
 - customizing, 108
 - dialing, 105
 - faxing multiple pages, 105
 - printing faxes automatically, 106
 - receiving faxes, 106 to 107
 - sending faxes, 104 to 106
 - speed dial, 108
- Scan to OCR
 - changing program properties, 84
 - editing text, 79
 - file formats, 81 to 82
 - multiple pages, 77
 - opening a word processing program, 82 to 83
 - processing text, 78 to 80
 - saving text file, 80 to 82
 - scanning text, 76 to 77
 - straightening image, 79
- Scanning
 - for creativity, *see* Scan for Creativity
 - in Photo Print, *see* Photo Print
 - in PrintFun, *see* PrintFun
 - positioning the original document, 20
 - problems, 143 to 152
 - quality problems, 150 to 152
 - quick, 101 to 102
 - to an application, *see* Scan to Application
 - to E-mail, *see* Scan to E-mail
 - to OCR, *see* Scan to OCR
 - with TWAIN, *see* TWAIN
- Service, 154 to 155
- Smart Panel
 - changing application properties in, 100
 - Copy Utility, *see* Copy Utility
 - overview, 9 to 18
 - palette mode, 18
 - Photo Print, *see* Photo Print
 - PrintFun, *see* PrintFun
 - quick scanning, 101 to 102
 - registering applications, 98 to 99
 - removing applications, 100

- Smart Panel (continued)
 - Scan for Creativity, *see* Scan for Creativity
 - Scan to Application, *see* Scan to Application
 - Scan to E-mail, *see* Scan to E-mail
 - Scan to Fax, *see* Scan to Fax
 - Scan to OCR, *see* Scan to OCR
 - technical support, 155
- Smears, 147
- Software
 - list of, 3 to 4
 - problems installing, 137 to 139
 - problems, scanning, 143
 - uninstalling, 152 to 153
- Speed dialing, 108
- sRGB (standard Red Green Blue) setting, 46
- Status sheet, printing, 21
- Support, 154 to 155
- Switch, thickness, 38, 136, 145 to 147
- System requirements, 157 to 158

T

- Technical support, 154 to 155
- Testing the EPSON Stylus Scan, 135
- Text scanning, *see* Scan to OCR
- Text/Graph setting, 46
- Thickness switch, 38, 136, 145 to 147
- Time stamps, 31 to 33
- Titles, PrintFun, 64 to 65, 67 to 68
- Transparencies, scanning, 71
- Transparency unit, ordering, 159
- Transporting the EPSON Stylus Scan, 130 to 131, 133
- Troubleshooting, 133 to 155
- TWAIN
 - adjusting settings, 72 to 74
 - previewing image, 72
 - resolution, 72
 - scanning transparencies, 71
 - scanning with, 70 to 75
 - selecting scan area, 75
 - selecting source, 70 to 71
 - starting a scan, 70 to 72

U

Uninstalling software, 152 to 153

USB

problems, 138

requirements, 157 to 158

uninstalling software, 152

V

Vertical banding, 129

W

Warranty, 165

Watermarks, 31 to 33

Windows

basic printing, 39 to 41

Photo Print, *see* Photo Print

system requirements, 157

uninstalling software, 152 to 153

WinFax, 103, 138 to 139, 155

World Wide Web, 154 to 155

Z

Zip drive problems, 139

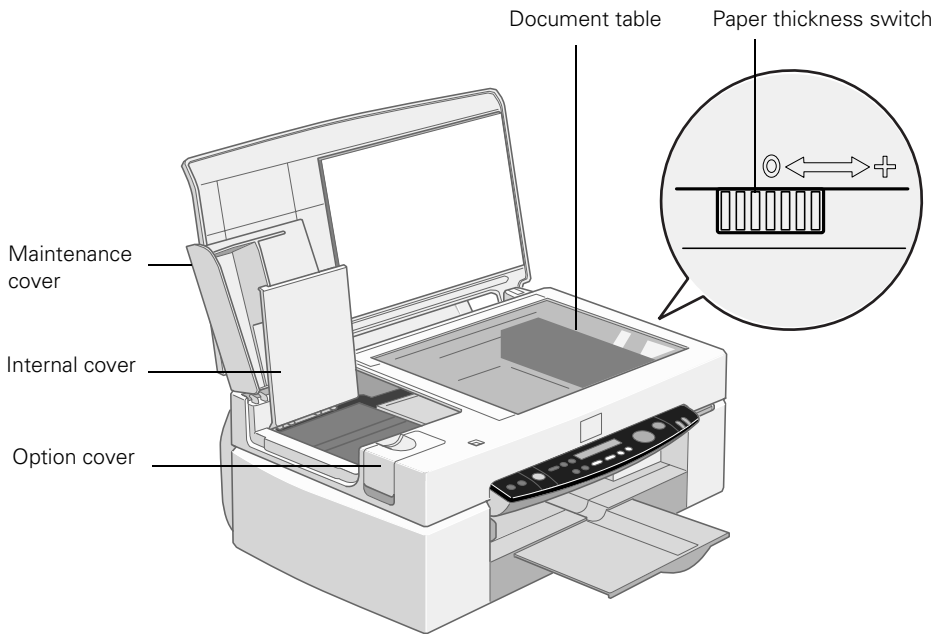
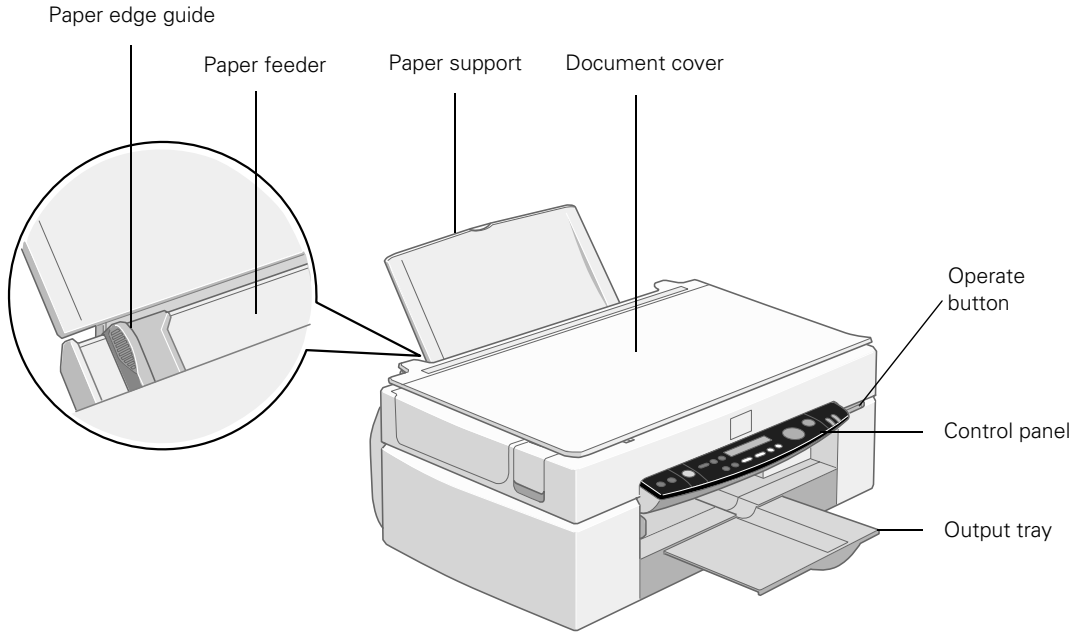

How to Order EPSON Ink and Paper

To order EPSON ink cartridges, paper, and other printing media, contact your dealer or call EPSON Accessories at (800) 873-7766 or visit our web site at www.epsonsupplies.com (U.S. sales only). In Canada, please call (800) 873-7766 for dealer referral.

Ink Cartridges

Black S020189
Color S020191

EPSON Papers

Paper name	Size	Part number
EPSON 360 dpi Ink Jet Paper	Letter (8.5 x 11 inches)	S041060
	A4 (8.3 x 11.7 inches)	S041059
EPSON High Quality Ink Jet Paper	Letter (8.5 x 11 inches)	S041111
	A4 (8.3 x 11.7 inches)	S041117
EPSON Photo Quality Ink Jet Paper	Letter (8.5 x 11 inches)	S041062
	A4 (8.3 x 11.7 inches)	S041061
	Legal (11 x 17 inches)	S041067
EPSON Photo Quality Ink Jet Cards	A6 (4.1 x 5.8 inches)	S041054
	8 x 10 inches	S041122
EPSON Matte Paper - Heavyweight	Letter (8.5 x 11 inches)	S041257
EPSON Photo Paper	4 x 6 inches	S041134
	Letter (8.5 x 11 inches)	S041141
	A4 (8.3 x 11.7 inches)	S041140
	Panoramic (8.3 x 23 inches)	S041145
EPSON Photo Stickers Kit (CD-ROM/paper)	A6 (4.1 x 5.8 inches)	S041144-KIT
EPSON Photo Stickers (refill)	A6 (4.1 x 5.8 inches)	S041144
EPSON Photo Quality Glossy Film	Letter (8.5 x 11 inches)	S041072
	A4 (8.3 x 11.7 inches)	S041071
	A6 (4.1 x 5.8 inches)	S041107
EPSON Ink Jet Transparencies	Letter (8.5 x 11 inches)	S041064
	A4 (8.3 x 11.7 inches)	S041063
EPSON Photo Quality Self Adhesive Sheets	A4 (8.3 x 11.7 inches)	S041106
EPSON Iron-On Cool Peel Transfer Paper	Letter (8.5 x 11 inches)	S041153/S041155
EPSON Photo Quality Glossy Paper	Letter (8.5 x 11 inches)	S041124
	A4 (8.3 x 11.7 inches)	S041126