

A MATTER OF DESIGN

MAKING SOCIETY THROUGH
SCIENCE AND TECHNOLOGY

PROCEEDINGS OF THE 5TH STS ITALIA CONFERENCE 2014

EDITED BY
CLAUDIO COLETTA
SARA COLOMBO
PAOLO MAGAUDDA
ALVISE MATTOZZI
LAURA LUCIA PAROLIN
LUCIA RAMPINO

sts
italia



A MATTER OF DESIGN

MAKING SOCIETY THROUGH
SCIENCE AND TECHNOLOGY

PROCEEDINGS OF THE 5TH STS ITALIA CONFERENCE 2014

EDITED BY
CLAUDIO COLETTA
SARA COLOMBO
PAOLO MAGAUDDA
ALVISE MATTOZZI
LAURA LUCIA PAROLIN
LUCIA RAMPINO



sts
italia

***A Matter of Design: Making Society through Science and Technology
Proceedings of the 5th STS Italia Conference***

*Edited by Claudio Coletta, Sara Colombo, Paolo Magaudda, Alvise
Mattozzi, Laura Lucia Parolin and Lucia Rampino*

*An Open Access Digital Publication by STS Italia Publishing
Released: December 2014*

ISBN: 978-90-78146-05-6

*Publishing project: Paolo Magaudda
Editing and layout: Stefano Crabu
Cover design: Sara Colombo*

*Contact: STS Italia, Via Carducci 32, 20123, Milano.
Email: stsitalia.org@gmail.com*

*The 5th STS Italia Conference was supported by: Doctoral Programme in
Design - Politecnico di Milano, Fondazione Bassetti and Fastweb.*

A pdf version of this publication can be downloaded at: www.stsitalia.org



*This publication is licensed under the
Creative Commons: Attribution,
Noncommercial, No Derivative Works - 2.5
Italian License (CC BY-NC-ND 2.5 IT).*

TABLE OF CONTENTS

EDITORS' INTRODUCTION	I
An 'Epistemic' Encounter between STS and Design	

SECTION I

Design, Social Innovation, and Cultural Identities

Diachronous Dilemma: representing American hegemony in three centuries of attitudes to design	3
<i>Ted Cavanagh</i>	
Design Practice: Making Beyond Borders	17
<i>Carla Cesare</i>	
'We, L'Aquila': Production and representation of urban space through a social map platform	35
<i>Manuela Farinosi, Alessandra Micalizzi</i>	
The game as social activator, between Design and Sociology: a multidisciplinary framework to analyse and improve the ludic experiences and their social impact	51
<i>Enrico Gandolfi, Ilaria Mariani</i>	
Towards a transnational history of urban design	69
<i>Michel Geertse</i>	
L'approccio storico al design. Stereotipi, aporie, paradigmi (?)	85
<i>Giorgio Giallocosta, M. Cristina Tonelli</i>	
Valorizzazione, fundraising, design: un'innovazione sostenibile per il patrimonio culturale italiano	99
<i>Gianluca Grigatti</i>	
Identità visive generative. Programmare la corporate identity	111
<i>Francesco E. Guida</i>	
Street Furniture and the Nation State: A Global Process	127
<i>Eleanor Herring</i>	
Beyond social innovation: design as cultures active-action	137
<i>Eleonora Lupo</i>	
(Dis)placement of/by Design: Social Construction of Pojang-macha (Re)Designing in Seoul	155
<i>Min Soo-hong</i>	
Cities transformations, social innovation and service design	169
<i>Alessandro Deserti, Francesca Rizzo</i>	
Temporal merging of actantial models of space	185
<i>Gunnar Sandin</i>	
Narrare il Territorio: Dispositivi e Strategie d'Innovazione per gli Spazi Percepiti	201
<i>Giovanni Baule, Daniela Anna Calabi, Sabrina Scuri</i>	

TABLE OF CONTENTS / INDICE

[Social Design for whom and what purpose? Community network knowledge, conversation-as-commoning and design research](#) 217
Kaye Shumack

[Otherwise Engaged: designing a post-digital Space of Appearance in Auckland, New Zealand](#) 233
Charles Walker, Dermott McMeel

SECTION II

Design, Creativity, and Process

[A Manifesto of Change or Design Imperialism? A Look at the Purpose of the Social Design Practice](#) 245
Danah Abdulla

[Exploring Model Making: Translating Intuitive Aspects Of Conceptual Models Into Digital Realm](#) 261
Elif Aktaş

[L'immaginazione ludica, un sapere incarnato nella materia](#) 281
Francesca Antonacci

[Doing Stuff with Stuff: Designing for the Everyday Metamorphosis of Collaborative Work Environments](#) 295
Chris Berthelsen, Charles Walker

[Designing the Body of Architecture Through Biological Analogies](#) 311
Jean-Pierre Chupin, Carmela Cucuzzella

[Are Open Innovation processes structured for disturbance?](#) 329
Jan Eckert, Lukas Scheiber, Peter Schwehr

[Innovative processes for jewellery production](#) 341
Paola Garbagnoli, Maria Vittoria Diamanti, Barbara Del Curto, Valeria Masconale, Maria Pia Pedeferra

[Procedures for Community Based Parametric Design and Making](#) 351
Jason S. Johnson, Alyssa Haas, Guy Gardner

[Smart materials: development of new sensory experiences through stimuli responsive materials](#) 367
Esther Lefebvre, Agnese Piselli, Jenny Faucheu, David Delafosse, Barbara Del Curto

[Participating in infrastructuring. The active role of visitors and curators in museums](#) 383
Teresa Macchia, Lily Diaz, Vincenzo D'Andrea

[The Human Creator as an Interface](#) 395
Sandra Plontke

[Research Through Design: What Does it Mean for a Design Artifact to be Developed in the Scientific Context?](#) 409
Selena Savic, Jeffrey Huang

<u>D-STEM: a Design led approach to STEM innovation</u>	425
<i>Anne Toomey, Veronika Kapsali</i>	
<u>The 'Makers contradiction'. The shift from a counterculture-driven DIY production to a new form of DIY consumption</u>	439
<i>Alessandro Carelli, Massimo Bianchini, Venanzio Arquilla</i>	
<u>Foretelling and Shaping the Future of Technology: the Role of Communication Designers in the Design of Innovation</u>	461
<i>Margherita Pillan, Marco Spadafora, Annamaria Andrea Vitali</i>	
<u>Break-it, hack-it, make-it: the 'Hack-a-Thing' workshop series as a showcase for the integration of creative thinking processes into FabLab Genk</u>	477
<i>Katrien Dreessen, Selina Schepers, Danny Leen, Kris Luyten, Tom De Weyer</i>	

SECTION III

Digital Media and Knowledge Society

<u>Designing Identities on the Digital Mirrors of Facebook: The Reflection & the Real</u>	495
<i>Zeynep Arda</i>	
<u>Quis Monet Ipsos Monitores? Motivations, methodological issues and techniques for monitoring the controversy on surveillance as a topic in on-line scraped textual data</u>	511
<i>Alberto Cammozzo, Andrea Lorenzetti</i>	
<u>Affrontare il divario generazionale tecnologico attraverso il gioco</u>	527
<i>Giuliana Catapano, Ilaria Mariani</i>	
<u>From bits to atoms: sensory displays for digital information</u>	547
<i>Sara Colombo, Lucia Rampino</i>	
<u>The Big Data as 'presentification' of knowledge</u>	569
<i>Sabino Di Chio</i>	
<u>Networked and Technological Paradigms of Digital Whistleblowing</u>	583
<i>Philip Di Salvo</i>	
<u>Identità immortali. L'Afterlife digitale come estensione dell'identità</u>	595
<i>Fiorenza Gamba</i>	
<u>Big Data and Nate Silver's Computational Protocols: predictive Analytics and innovative Digital Methods for the Study of the Political Trends. A critical debate</u>	609
<i>Michele Infante</i>	
<u>Towards a typology of materiality/corporeality of music in the digital multimedia regime</u>	635
<i>Stefano Lombardi Vallauri</i>	
<u>Borders. Visual analysis of Cinema's inner dynamics and evolutions. A case study based on the Internet Movie Database</u>	647
<i>Giovanni Magni, Paolo Ciuccarelli, Giorgio Uboldi, Giorgio Caviglia</i>	

TABLE OF CONTENTS / INDICE

Smart Meters as boundary objects in the energy paradigm change: the CIVIS experience	667
<i>Giacomo Poderi, Matteo Bonifacio, Andrea Capaccioli, Vincenzo D'Andrea, Maurizio Marchese</i>	
The materiality of code: Towards an understanding of socio-technical relations	681
<i>Winnie Soon</i>	
Digital literacy e disuguaglianze tra i giovani: oltre le metafore semplificatorie	697
<i>Simona Tirocchi</i>	
Orientare l'analisi. Una semiotica critica e materiale è possibile?	711
<i>Matteo Treleani</i>	
Mobility and the Smart City. Innovative Solutions for Responsive Urban Spaces	725
<i>Marco Zilvetti, Fausto Brevi</i>	

SECTION IV

Aesthetics, Narration and Critical Design

Narratives And The Co-Design Of Spaces For Innovation	743
<i>Anzoise Valentina, Stefania Sardo</i>	
Lições de Salazar [Salazar's lessons] 1938: the role of progress and technology on an authoritarian regime ideology	763
<i>Carlos Bártolo</i>	
Experts, Expertise and Qualitative Judgment in Canadian Architectural Competitions	781
<i>Carmela Cucuzzella, Jean-Pierre Chupin</i>	
Il concetto di sostenibilità nella moda: il caso della lana rustica italiana	797
<i>Monica Cariola, Greta Falavigna, Valentina Moiso, Elena Pagliarino</i>	
Eстетiche dei futuri come estetiche dei contrasti. Processi design driven di costruzione condivisa di scenari	813
<i>Flaviano Celaschi, Elena Formia</i>	
The rhetoric and rhetoricality of Bio-Design	829
<i>Marjan Groot</i>	
Chasing The Hobbit. The Cultural Contents Of Mainstream Media Products	847
<i>Luca Guerrini</i>	
Design, scienza ed estetica nei territori dell'innovazione	863
<i>Francesca La Rocca</i>	
The Human Emotional System and the Creativity in Design	881
<i>Marco Maiocchi, Margherita Pillan</i>	
Autarchy: The Making of Dutch Design in Practice	901
<i>Joana Ozorio De Almeida Meroz</i>	

<u>Interferenze digitali. Un'estetica delle pratiche digitali a supporto del discorso di design</u>	921
<i>Elisa Bertolotti, Federica D'urzo, Francesca Piredda</i>	
<u>Design Narratives and Social Narratives for Community Empowerment</u>	935
<i>Valentina Anzoise, Francesca Piredda, Simona Venditti</i>	
<u>Today's culture jamming aesthetics: an investigation to understand the consumption of visual resistance</u>	951
<i>Andréa Poshar</i>	
<u>Unpleasant Design. Designing Out Unwanted Behaviour</u>	975
<i>Gordan Savicic, Selena Savic</i>	
<u>When Human Body Meets Technology: The Designer Approach to Wearable Devices</u>	989
<i>Venere Ferraro, Matteo O. Ingaramo</i>	
<u>Per una sperimentazione materica postdigitale. Oltre i bits, i nuovi atomi</u>	1005
<i>Chiara Scarpitti</i>	

SECTION V

New and Responsible Socio-Technical Paradigms

<u>Anticipating and Responding to Challenges Regarding Digital Technologies and Valuing</u>	1017
<i>Barbara Andrews, David Hakken, Maurizio Teli</i>	
<u>Citizens'veillance on environmental health through ICT and genes</u>	1031
<i>Annibale Biggeri, Mariachiara Tallacchini</i>	
<u>The Corporation and the Panchayat. Negotiations of knowledge in an Indian Technology Park</u>	1045
<i>Elena Bougleux</i>	
<u>From physical to digital. A new way of interaction with an Integrated System of smart appliances</u>	1059
<i>Silvia D. Ferraris, Lucia Rampino</i>	
<u>Grounded Reflexivity: an approach to the polysemy of Responsible Research and Innovation</u>	1075
<i>Robert Gianni, Philippe Goujon</i>	
<u>La valutazione delle prestazioni urbanistiche dei parchi scientifici e tecnologici: alcuni casi italiani a confronto</u>	1089
<i>Giampiero Lombardini</i>	
<u>Digital Makers: an Ethnographic Study of the FabLab Amsterdam Users</u>	1105
<i>Irene Maldini</i>	
<u>Collective decision making on risk management and sustainable manufacturing of nanomaterials and the role of decision support tools</u>	1115
<i>Ineke Malsch, Vrishali Subramanian, Elena Semenzin, Danail Hristozov, Antonio Marcomini</i>	

TABLE OF CONTENTS / INDICE

RECYCLE TOOLKIT. Strategie per il riciclo di aree dismesse <i>Chiara Olivastri</i>	1131
In the Interior of Innovation: The FabLab Synthesis of Physical and Virtual Environments <i>Ricardo Saint-Clair</i>	1145
Radical Innovation in Urban Development as Making Unfolds Its Potential <i>Peter Troxler, Gert-Joost Peek</i>	1163

SECTION VI

Health, Safety, and Wellbeing

The document use as a situated practice in pre-hospital emergency care <i>Petra Auvinen, Hannele Palukka, Ilkka Arminen</i>	1179
L'interpenetrazione tra valori e design nell'ideazione, implementazione e funzionamento della rete di Telessaùde brasiliana <i>Carlo Botrugno</i>	1197
Una tutela 'by design' del diritto alla salute. Prospettive di armonizzazione giuridica e tecnologica <i>Raffaella Brighi, Maria Gabriella Virone</i>	1211
The role of artefacts in the coordination of home care practices <i>Adeline Hvidsten, Antonalla La Rocca, Thomas Hoholm</i>	1223
Taking Care of Drivers/Taking Care of Technologies? Tensions and Promises of Advanced Driver Assistance Systems <i>Oana Mitrea</i>	1239
Spazi di transizione tra strutture sociosanitarie e città. Condividere funzionalità in ambiente urbano <i>Valentina Napoli</i>	1253
Design partecipato e pratiche della sicurezza nei cantieri <i>Silvia Pericu</i>	1269
Connective practices in the access of immigrants to healthcare services: The role of the language and cultural mediator as a boundary subject <i>Paolo Rossi, Mara Tognetti Bordogna</i>	1283
Improving medical information of blood tests results through the application of co-design <i>Mónica Santos, Susana Barreto, Katja Tschimmel</i>	1297
Enhancing Corporeal Boundaries through Technology <i>Secil Ugur Yavuz</i>	1312
Il progetto della casa sensibile – Designing the Sense-Able Home <i>Niccolò Casiddu, Claudia Porfirione, Matteo Zallio</i>	1325
Organizzare la cura fuori dai contesti istituzionali: il caso dei pazienti anziani con terapie complesse <i>Alberto Zanutto, Francesco Miele, Enrico Maria Piras, Claudio Coletta, Attila Bruni</i>	1343

EDITORS' INTRODUCTION

An 'Epistemic' Encounter between STS and Design

The present publication contains a selection of the works presented at the 5th STS Italia Conference, held in Milan from June, 12–14 2014. The main theme of this STS Italia conference's edition was the intersection between Design Studies and Science & Technology Studies. The Conference was the main event of STS Italia, the Italian Society for the Study of Science & Technology and the 2014 edition was organized in collaboration with the Design Department of Politecnico di Milano. Thanks to this cooperation, the conference was a unique space for interdisciplinary encounters between different scientific and intellectual milieus, which have interacted on very practical terms, fostering a reflexive account both in Design and STS practices.

In the last thirty years, the word 'design' along with all the practices that compose this word have become more relevant and ubiquitous in our societies. Today, design is often linked to new technological developments and at the same time is conceived as a practice that gives meaning to artefacts, services and experiences defining our everyday life. Thus, from being just 'styling', design has become, in our artefacts-dense world, the main practice related to the articulation of social relations through artefacts; indeed, it is through the very act of articulating artefacts' forms and meanings that design shapes our social networks – either those brought about by artefacts or those that make artefacts possible.

Because design is part of a complex network, it cannot be explained as the result of independent rational choices carried out by isolated individuals, whether designers, producers or users. Rather, design processes are the outcome of collective processes in which humans and nonhumans interact. For these very reasons, design has become of interest for Science and Technology Studies, which have been assessing these networks of humans and non-humans, giving way to innovation for the last 40 years.

Whether the reciprocal interest between these two fields is recent, as shown by many publications (among others: Binder, 2011; Fallan, 2010;

EDITORS' INTRODUCTION

Farias and Bender, 2011; Houdart, 2006; Ingram et al., 2007; Latour, 2008; Latour and Yaneva, 2008; Shove et al., 2007; Storni, 2012; Suchman, 1987; Wilkie, 2011; Woodhouse and Patton, 2004; Yaneva, 2009a; 2009b), the overlap between issues of interests for these two fields emerged in the more distant past with the development of IT, as witnessed by the well-known Italian designer Ettore Sottsass, who in the 1960s collaborated with the Italian computer manufacturer Olivetti on the Elea, one of the first microcomputers:

It was immediately obvious in the first years in which I worked on the ELEA that in the design of certain gigantic instruments, as electronic machines were then, or in the design of groups of machines which have a logical and operational relationship between each other, one ends up immediately designing the working environment; that is, one ends up conditioning the man who is working, not only his direct physical relationship with the instrument, but also his very much larger and more penetrating relationship with the whole act of work and the complex mechanisms of physical culture and psychic actions and reactions with the environment in which he works, the conditionings, the liberty, the destruction, exhaustion and death. (Ettore Sottsass quoted in P. Sparke, *Ettore Sottsass Jnr.* London: Design Council. 1982, p. 63.)

Although such an encounter could seem obvious since it literally follows the order of things, it has not been simple or straightforward, nor can it be taken for granted, in general and especially at the STS Italia Conference. As it has been also noted by Paolo Volonté (2014) in presenting the conference keynote lectures – which have been published on a special issue of the journal 'Tecnoscienza' – we witnessed, indeed, to a meeting between two 'epistemic cultures', i.e. two 'sets of practices, arrangements and mechanisms bound together by necessity, affinity and historical coincidence which, in a given area of professional expertise, make up how we know what we know', as clarified by Knorr-Cetina (2007, p. 363); or between two 'epistemic communities' (Haas, 1992; Akrich, 2010), each sharing policy orientations on problems at stake and a technoscientific repertoire for possible ways of solving them. In other terms, they represent different 'machineries of knowledge construction' (Knorr-Cetina 1999, p. 3). What occurred at the STS Italia conference was encounters between different practices, artefacts, references, values and ways of judging what is relevant

and what is not, what can be taken for granted and what has to be made explicit and must be justified and grounded, what is reliable and what is not.

Such an epistemic encounter has occurred – as the many thematic sessions of the conference showed – in studying the more diverse subjects: from communication tools to innovation processes, from robotics to smart fibres, from workplaces to medical products or even the human body. These proceedings bear the traces of all these differences and the slow negotiations over them. In this sense, these proceedings can be considered as an on-going preparation for a dialogue (or a clash) where each party places its troops and studies the other, rather than dwelling on its ending accomplishment.

The published papers reflect the heterogeneity of the conference in terms of the specific themes considered, the theoretical frameworks adopted and the epistemic perspectives owned by the different authors. The six sections of this volume reflect the conference structure, and together they draw a variegated picture of the topics and perspectives in the encounters between two different 'epistemic cultures'. Section 1 (Design, Social Innovation and Cultural Identities) reveals how recently design has been seen as an instrument to create and sustain social change and innovation stemming from local communities. The papers in this section present case studies on social design and discuss its role in the creation of both culture and (urban or local) identities. Section 2 faces the challenges raised by the Digital Media and Knowledge Society. The rise of the knowledge society has several implications in terms of, for instance, the epistemological consequences of the availability of a large amount of data and the social consequences of ubiquitous wireless networking. The papers in this section analyse such implications from different disciplinary points of view. Section 3—Design, Creativity and Processes—addresses the analysis of design practices and creativity processes. The papers explore practices and processes through which new artefacts and services emerge, become stabilized and acquire a specific identity. The emphasis is on the entanglement of human and non-human elements (material, symbolic, sensorial, imaginative) involved in these processes. Aesthetics is a key issue in design, traditionally linked to the physical and static aspects of a product. Section 4 (Aesthetics, Narration and Critical Design) points out that nowadays the 'aesthetic' appraisal of products and services can take into account different aspects, linked to the temporal and expressive aspects of interactive behaviours, or to the sustainability of the manufacturing process.

EDITORS' INTRODUCTION

This adds both a narrative and a critical dimension to aesthetics. The spread of new manufacturing possibilities (i.e. rapid prototyping tools) is causing a socio-technical paradigm shift taking place in the processes of materialization and production of goods and services. Section 5, titled *New and Responsible Socio-Technical Paradigms*, deals with this changing scenario, where the relevance of sustainability and ethics in industry is increasing. At the same time, there is a growing call for responsibility in research and innovation activities. Finally, the last section (*Health, Safety and Wellbeing*) deals with the STS analysis of design issues related to healthcare, mobility, housing and work that affect the way services and welfare take place. The emphasis is especially on the hybrid and collective dimension of values, technological infrastructures and practices that re-create social relations, communities and everyday life.

The published papers are a selection of the full papers submitted to the Conference. These were already a selection of all the works (244 in total) presented to the various tracks of the conference since many, by author choice, remained just abstracts (available as documentation on the conference's website). The selection of the abstracts for the conference was managed by the track convenors, while reviewing and the subsequent selection of the full papers for publication in the present Proceedings has been managed by the editorial committee. Each paper has been reviewed by the editorial team and has been accepted on a few porous selection criteria related to the desire to include different points of views and voices, regardless of the main perspective adopted and the main disciplines of origin. As a result, this publication contains 86 reviewed papers representing a variegated and multi-perspective output of this encounter among scholars coming from different fields and sectors but bound together by a special sensitivity toward design processes and practices, materials, technologies and the social and cultural issues imbricated into and through these elements.

Given the huge work done and the several steps that brought to this book, we need to thank several people that have directly and indirectly contributed to the final outcome. First of all, we want to thank STS Italia Board's members Paolo Volonté, Manuela Perrotta, together with the members of the conference's scientific committee: Paolo Ciuccarelli, Stefano Maffei, Giuseppina Pellegrino and Francesco Trabucco, for their contribution in the design of the overall programme of the conference.

Many thanks to the several convenors and organizers of the tracks at the conference: they articulated the main theme into a multiplicity of subjects and questions and have been responsible for the initial selection of abstracts, as well as for feedbacks on the presentations during the conference: Christophe Abrassart, Gabriele Balbi, Filippo Barbera, Davide Bennato, Massimo Bianchini, Philip Boucher, Johanne Brochu, Johannes Bruder, Attila Bruni, Roberto Cibir, Fausto Colombo, Michela Cozza, Vincenzo D'Andrea, Antonella De Angeli, Greta Falavigna, Giolo Fele, Alain Findeli, Peter Gall Krogh, Renaud Gaultier, Guido Gorgoni, Luca Guerrini, Luca Guzzetti, Klaus Hadwiger, Christine Leuenberger, Eleonora Lupo, Marina Maestrutti, Dario Mangano, Claudia Mareis, Iliaria Mariani Javier Gimeno Martínez, Fabien Mieyeville, Francesco Miele, Dario Minervini, Valentina Moiso, Alessandro Mongili, Francesca Musiani, Federico Neresini, Guido Nicolosi, Joana Ozorio de Almeida Meroz, Tatsuma Padoan, Jean-Patrick Piché, Giuseppe Pellegrini, Annalisa Pelizza, Enrico Maria Piras, Giacomo Poderi, Sébastien Proulx, Gene Rowe, Philippe Silberzahn, Matteo Tarantino, Simone Tosoni, Mauro Turrini, Thomas Vangeebergen and Carolin Wagner. We are particularly grateful to the PhD School of Politecnico di Milano that enabled this publication with its generous financial support. Special thanks go to Stefano Crabu for his precious work in publishing production.

Lastly we have to highlight that this is the first volume released directly by STS Italia, under the label STS Italia Publishing, with the aim of extending the scientific activities of the Society. The choice has been to publish the papers with an open access policy, both to help the visibility of these works and also to experiment alternative ways in scientific publishing and therefore in what we can define our 'epistemic machineries'.

Claudio Coletta (IUAV Venice)

Sara Colombo (Politecnico di Milano)

Paolo Magaudo (University of Padova)

Alvise Mattozzi (Free University of Bozen)

Laura Lucia Parolin (Ca' Foscari University)

Lucia Rampino (Politecnico di Milano)

References

- Akrich, M. (2010) From communities of practice to epistemic communities: health mobilizations on the Internet. [Online] *Sociological Research Online*, 15. Available from: <http://www.socresonline.org.uk/15/2/10.htm> [Accessed: 17th November 2014].
- Binder, T., De Michelis, G., Ehn, P. Jacucci, G., Linde, P. and Wagner I. (2011) *Design Things*. Cambridge MA: MIT Press.
- Farias, I. and Bender T. (2011) *Urban Assemblages: How Actor-Network Theory Changes Urban Studies*. London: Routledge.
- Haas, P.M. (1992) Introduction: Epistemic Communities and International Policy Coordination. *International Organization*, 46 (1), 1-35.
- Houdart, S. (2006) Des multiples manières d'être réel. La représentation en perspective dans le projet d'architecture. *Terrain*, 46 (1), 107-122.
- Ingram, J., Shove, E. and Watson, M. (2007) Products and Practices: Selected Concepts from Science and Technology Studies and from Social Theories of Consumption and Practice. *Design Issues*, 23 (2), 3-16.
- Knorr-Cetina, K. (1999) *Epistemic Cultures: How Scientists Make Sense*. Chicago: Indiana University Press.
- Knorr-Cetina, K. (2007) Culture in global knowledge societies: knowledge cultures and epistemic cultures. *Interdisciplinary Science Review*, 32 (4), 361-375.
- Latour B. (2008) *A Cautious Prometheus: A Few Steps Toward a Philosophy of Design*. In Hackne, F., Glynne, J. and Minto V. (eds), *Proceedings of the 2008 Annual International Conference of the Design History Society – Falmouth, 3-6 September 2009*. Boca Raton: Universal Publishers.
- Latour, B. and Yaneva, A. (2008) *Give me a Gun and I Will Make All Buildings Move: An ANT's View of Architecture*. In Geiser, R. (eds.), *Explorations in Architecture: Teaching, Design, Research*. Basel: Birkhäuser.
- Shove, E., Watson, M., Hand, M. and Ingram, J. (2007) *The Design of Everyday Life*. New York: Berg.
- Storni, C. (2012) Unpacking design practices: the notion of things in the making of artifacts. *Science, Technology and Human Values*, 37 (1), 88-123.
- Suchman, L. (1987) *Plans and situated actions : the problem of human-machine communication*. Cambridge: Cambridge University Press.
- Volontè, P. (2014) Design Worlds and Science and Technology Studies. *Tecnoscienza: Italian Journal of Science & Technology Studies*, 5 (2), 5-14.

- Wilkie, A. (2011) Regimes of Design, Logics of Users. *Athenea Digital*, 11 (1), 317-334.
- Woodhouse, E. and Patton, J.W. (2004) Design by Society: Science and Technology Studies and the Social Shaping of Design. *Design Issues*, 20 (3), 1-12.
- Yaneva, A. (2009a) *Made by the Office for Metropolitan Architecture: an Ethnography of Design*. Rotterdam: 010.
- Yaneva, A. (2009b) Making the Social Hold: Towards an Actor-Network Theory of Design. *Design and Culture*, 1 (3), 273-288.

SECTION I

Design, Social Innovation, and Cultural Identities

Diachronous Dilemma: representing American hegemony in three centuries of attitudes to design

Ted CAVANAGH*
Dalhousie University

This paper contends that the historiography of balloon-frame construction is a metonym of the historiography of the national design of the United States. At various points in time, balloon-frame construction has been promoted, debased and/or described in a matter of fact way. This paper surveys hundreds of nineteenth century accounts of balloon-frame construction and analyses its origins based on Brian Stross' cycle of hybridity.

It originated in a process of continuous refinement and combination. In the middle decades of the twentieth century, Sigfreid Giedion's view held sway. Balloon-frame construction was celebrated as a particularly American root of modernism. In today's pluralist times, balloon-frame construction again stands in for a particular view of national design history. Hybridity and the social construction of technology have deep acceptance in our era of globalism and overlapping cultures. In this and many other ways, this method of construction represents the view that Americans have of themselves and their design, a view of national design that shifts over time.

Keywords: *Balloon frame; national design; social construction of technology; innovation; technique; dialogic; exceptionalism; multicultural; hybrid*

Introduction

North Americans build their houses with wood using a construction method that is unique. Or rather, it was unique and is now spreading across the world as with many other American ways of doing things. In the nineteenth century, North Americans developed this way of building as the country itself was developing – forged by the hybridization and creolization of immigration. This paper contends that the historiography of balloon-

* Corresponding author: **Ted Cavanagh** | e-mail: ted.cavanagh@dal.ca

frame construction – its roots, its development, its leveling influence, and its global hegemony – is a metonym of the historiography of the United States.

An aspect of national design that is truly representative of a culture – a habitus that changes over time as the U.S. itself changes.



Figure 1 The balloon frame being erected in the 1940s. Built with 2x4 inch dimension lumber, cut and butt-jointed and fastened with nails. The structure is redundant and each joint is reasonably solid such that the entire system has a statistical probability of sufficient bearing capacity.

This analogy works at least two levels, those of fact and interpretation or, in other words, of description and analysis. And, as you might imagine, since this technique stands in for the entirety of American building culture, the interpretations are contested mightily and the facts are selected to suit the interpretations. As discussed below, its roots hinge on the interpretation of historical accounts of the first days of Chicago either as invention or as ‘closure’ described in the social construction of technology (SCOT) (Pinch and Bijker, 1985). Its development is either deterministic technological adoption or a more gradual road to technological domination described in the SCOT. Its leveling influence is part loss and part gain. And, like Benjamin’s quote about architecture: ‘This is most obvious with regard to buildings. Architecture has always represented the prototype of a work of art the reception of which is consummated by a collectivity in a state of distraction. The laws of its reception are most instructive’ (Benjamin, 1976).

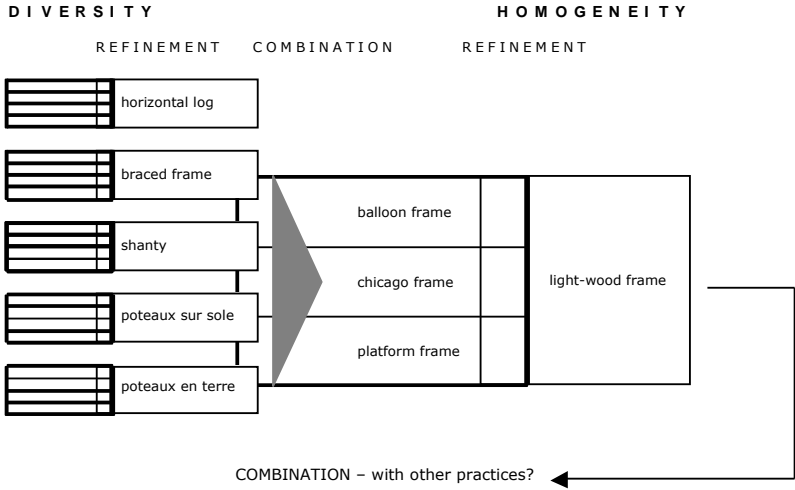


Figure 2 The cycle of hybridity diagram for the balloon frame showing examples of some of the root ethic traditions on the left – notched horizontal log, diagonally-braced heavy timber frame, a shanty bricolage of available materials, and two forms of vertical log either on sills or in earth palisade. Notice the tendency to refine technique in competition or by assimilation. Refined techniques are susceptible to combination. After all forms of light frame combine there is ‘closure’ and ‘stabilization’ as in the SCOT.

The evidence of construction is submerged behind finished appearances, influencing other building techniques, promoting a distracted way of experiencing buildings. This way of doing things is spreading worldwide.

Considering roots

The balloon-frame method of wood frame construction is a clear metonym of the history of nineteenth-century United States. In North America, the interaction among multiple cultures has long contributed to a creative tension that spawns innovation. The balloon frame is an example of this plurality leading to a singular form of construction unique to North America. The balloon frame is considered a convention –a culturally–constructed procedure that circumscribes the practice of designers and builders. The introduction of the balloon frame did represent a decisive change in how people built their houses. There are no ‘missing links’ to discover and no simple lineage to connect the wood-building techniques

and materials of the 1780s with those of the 1880s. Its technique was a product of broad cultural possibilities and the cumulative effort of many builder-innovators. Innovative revisions to construction practice were introduced continually, but accepted unevenly – variations of building technique (such as the continued use of heavy timber for sills) occurred into the last decades of the nineteenth century. All this happened in a context of sweeping cultural change that made it both possible and acceptable.

In the 1840s and the 1880s, both Margaret Fuller and Frank Lloyd Wright interpreted situation around them with the eyes of a recent arrival (Wright, 1977). Their diaries describe a creative tension in apparently neutral buildings and ordinary landscapes. In an 1843 account of a landscape (contemporary with the transformation of house-building practice due to the introduction of the balloon frame), the philosopher and journalist Margaret Fuller recounted a delightful anecdote describing Midwest settlers. With Voltaire and rattlesnakes, Norwegian peasants and French milkmaids, bookish landlords and *coureurs-de-bois*, it was a cascade of cultures, encounters, overlaps, and hybrids.

‘He showed us a bookcase filled with books about this country; these he had collected for years, and become so familiar with the localities that, on coming here at last, he sought and found, at once, the very spot he wanted.

There is that mixture of culture and rudeness in the aspect of things as gives a feeling of freedom, not of confusion. The young ladies were musicians, and spoke French fluently, having been educated in a convent. Here in the prairie, they had learned to take care of the milk-room, and kill the rattlesnakes that assailed their poultry yard. Beneath the shade of heavy curtains you looked out from the high and large windows to see Norwegian peasants at work in their national dress’ (Fuller, 1844).

Similar cultural circumstances were found in the city. ‘In 1843 Chicago’s first census counted 7,580 residents. ... Chicago was polyglot, its population ‘derived from every nation under heaven’ (Havinghurst, 1962). Chicago continued the American tradition of the polyglot city on the frontier. Not only the frontier was polyglot. Social histories of labour and immigration show that ‘the creation of compound identities has been a highly significant aspect of Americanization as a social process’ (Kammen, 1993).

Buildings are interesting windows on history. Each historical construction technique manifests a specific ethnicity such that buildings are individual or hybrid cultures frozen in time. It is evident that some builders were resistant, some combined different cultures, and some allowed easy penetration of new building materials. As predicated in the model, the cycle

of hybridity (figure 2), builders refined the 'parent' construction practices just prior to the balloon frame (Stross, 1999). Then, once the hybrid was initiated and its new properties emerged, there was a process of testing, establishing practice, and removing difference. The 'initially (perceived as) heterogeneous hybrid becomes progressively more homogenous through such processes as adapting to the environment, adopting formats, adapting conventions, creating rules, generating traditions...' (Stross, 1999).

There was an unprecedented demand for houses in the Midwest in the early 1800s and this hot economy 'fast-tracked' the development of balloon frame. Similarly, the diversity of cultures in the Midwest in the early 1800s was unlike that seen anywhere before. This diverse ethnicity led to a diversity of construction practices, more varied than elsewhere. This multiplied the SCOT concept of 'relevant social groups' beyond roles to include ethnicity (Pinch and Bijker, 1985). This diversity created a huge vocabulary of available building techniques. When combined with the incredible demand, this created an environment where all these techniques were competing for primacy. Each was refined for mass production and, in the act of refinement, they became predisposed for combination with each other. Eventually, the balloon frame was assimilated out of these practices and became the technique of choice; 'stabilization' in terms of the SCOT.

There are important counter-tendencies to the homogenizing effect of hybridization. One is the resistance of locality under the circumstances of concentrated settlement or occupational concentration. Often, in the United States, ethnically-defined influence does not halt once the language disappears or the work customs no longer resemble those of the homeland, as long as some culture-forming community remains.

The immigrant culture itself [can come] to define that of the class or locality it enters. ... National culture and economic constraints set outer limits on the range of local variance, but within those limits, ... local ways of doing things, develop, continuously evolve, and reproduce themselves in socializing agencies... [that] construct rules for conflict, and styles of resolution.

This issue echoes a present-day concern about local culture being subsumed by homogenizing global forces. Pluralism of place makes local variation a powerful addition to historical theory, resistant to the hegemonic power of capital or modernization (Conzen,1991).

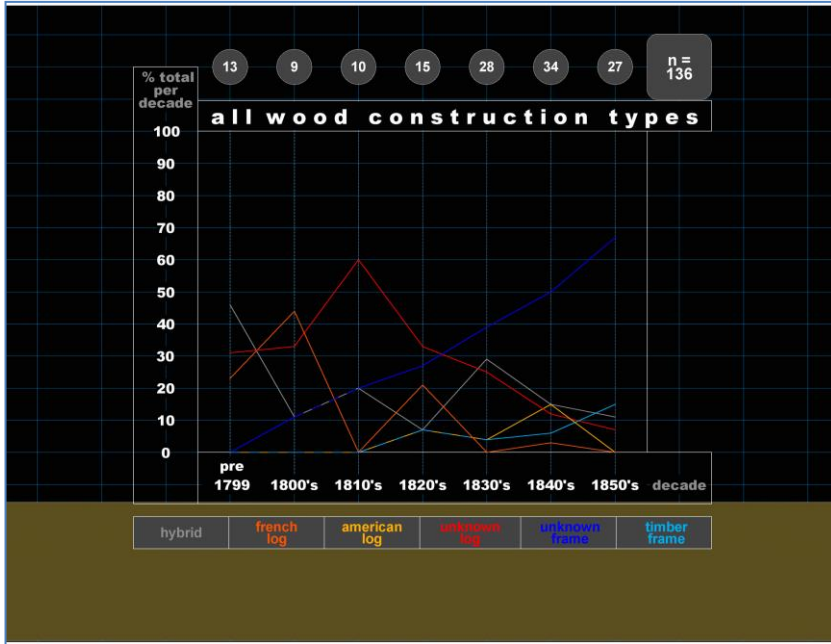


Figure 3 Chart of 136 references to types of construction in Illinois and Missouri organized by decade and percentage of total. Notice the general decline of the three log types and the increase of the two frame types. Hybrids are significant during the 1830s.

Immigrant-constructed culture can embed and reproduce itself in the culture of the broader local community, sometimes becoming the local ‘charter’ culture by establishing itself in areas of life influenced by local choice (Breen, 1984). As late as 1842, the local Franco-American ‘charter’ culture in Margaret Fuller’s Illinois landscape included the French language, convent education, and genteel musical accomplishment (Fuller, 1842).

Diverse ethnic building practices form a set of fuzzily distinct practices early in the nineteenth century. Gradually, these practices hybridized, continued to have local influence, or were adopted into wider practice. In terms of the balloon frame, however, these counter-tendencies are latent, dormant, or non-existent (figure 3). As each constituent technique was refined in order to compete with others to become preeminent, in its refined form it became more susceptible to combination with its competitors. Thus, a diversity of construction technique became homogeneous and resistant to further combination through hybridization.

Beyond hybridization, other concepts can be used to analyze the nineteenth century accounts of this design innovation. For instance, house-building is an industry with rural roots like other forms of capitalism.

Nineteenth-century builders were domestic manufacturers and then itinerant entrepreneurs. Furthermore, each historical construction technique manifests a specific ethnicity such that buildings are individual or hybrid cultures frozen in time. Some builders were resistant, some combined different cultures, and some allowed easy penetration of new building materials. In all these ways, balloon-frame construction is a clear metonym of the history of nineteenth-century United States.

The development of the balloon frame is a story of an original heterogeneity, one that North Americans need to maintain as part of their collective cultural and technological memory. *E pluribus unum* is founded in diversity: cultural, technological, and ecological. It is also the story of increased standardization and the loss of these diverse building techniques. By the late nineteenth century, the balloon frame was the predominant way of building a home in the United States.

Rising hegemony

Modern historians such as Sigfried Giedion and Daniel Boorstin find in the balloon frame a quintessentially American story of invention (Gideon, 1939; Boorstin, 1965). They place its invention precisely in a particular Chicago building. I have argued elsewhere why this cannot be so (Cavanagh, 1999). However, while the documentary evidence does not support the story of invention that collected by Walker Field and Paul Sprague it does suggest that Chicago might have been the first place the balloon frame was recognized in any predominantly English-speaking settlement despite the fact that it had been in use for some time (Field, 1942; Sprague, 1981).

In the mid-twentieth century the balloon frame was idealized by Sigfried Giedion as an original example of modernism. It has been assimilated into simple historical accounts. It has been overblown in stories of Yankee ingenuity, American exceptionalism, and vulgar negligence. Within a year of his arrival at Harvard, he and his student, Walker Field, found a hero, created a story of invention, and promoted a new origin in 1832 Chicago.

This new history supported a particular heroic view of modern architecture, a view of history prevalent in the twentieth century. Today, it can be seen as a diachronic example of closure; rather than an invention it was a stabilization of technique in 1832 and a stabilization of architectural history just over a century later (Pinch and Bijker, 1985).

There are two stories of the balloon frame: one is the historical reconstruction of its origins, the other is the history of the advocacy for its invention. Sigfried Giedion, a 'modern' twentieth-century historian, is important to both. Almost single-handedly, he established the significance of this construction technique to U.S. architectural history. He uncovered substantial, if circumstantial, documentary evidence and he projected contemporary practices back on to 'pre-modern' times. He advocated a radical change in construction authored by one creative individual. This 'modern' history of the balloon-frame credit its invention to a heroic individual, either George Snow and/or Augustine Taylor and situate it in the first year of the city of Chicago. Walker Field wrote the most extensive account of the balloon frame as an invented system in 1942. He credited an earlier article by Sigfried Giedion attributing 'the honor to George Washington Snow of Chicago. Thus, Giedion restored the lowly balloon frame to academic architectural circles, and appeared to have solved the problem of its birth for good.'

He and the many, many subsequent histories of Chicago and historical surveys of American Architecture disregard the fact that there is no extant evidence and no deeds, contracts or descriptions recorded about any novel building process. Despite the attempt by subsequent historians such as Daniel Boorstin and Paul Sprague to describe one man as an 'inventor,' he was entirely constructed from external conditions – his creativity from his Yankee culture and his necessity of invention from encounters with an alien environment and a booming economy. These arguments for an 'inventor' are a forced construct that has been refuted in detail elsewhere.

Gideon's account has become a cornerstone of an extensive advocacy for its invention. As historians, Field and Giedion depended on documentary evidence. Rather than their explicit argument for invention, unknowingly they were collecting evidence that can be used in revised history of the balloon frame where this historical moment in early Chicago is a moment of closure. They were also instigators of the contemporary understanding of the origin of the balloon frame making them advocates for a cessation of all further history, a rhetorical closure par excellence. After all, the end of history was the modernist project in national design.

The virulent attacks on my dismantling of the story of its invention are only one of the many pieces of evidence that suggest there are vested interests on the part of producers and historians who depend on the perpetration of the myth of its invention. The meaning of 'invention' is much more contested than it was fifty years ago when everyone assumed a

heroic view. Similar to the view of the majority of the public today, all historians used to consider 'invention' as an act of a creative genius, often by one man at one instant of time. Certain inventors epitomized this heroic view and have become well known for the new things they discovered; people like Alexander Graham Bell invented the telephone and went on to apply his genius to improve hydrofoils and aeronautics. Bell and outstanding individuals like him provide a driving creative force usually associated with technological invention. Historians that concentrate on the role of the heroic inventor assume that most 'technological change can be brought about by the 'break-away' action of non-conforming individuals and that communal regulations and restrictions impede the enterprise of such individuals.' This has been an important, but is by no means the sole way to instigate technological innovation.

In the field of construction, invention is difficult to pin down. Buildings are sophisticated assemblies and any invention revising the whole is complicated. Some firsts are hard to define, as in the first skyscraper; and even new construction processes such as those found in the 1880s skyscrapers of the 'Chicago School' are not singular advances but are composed of a series of innovative techniques, created by different architects, working together for the first time (Haag Bletter, 1987). There are further examples of the necessity of 'interpretive flexibility' in the social construction of technology in building construction (Pinch and Bijker, 1985). Particular techniques such as float glass and components such as elevators are more likely subjects of invention (though Otis only designed a revolutionary safety brake rather than the entire elevator) (Leslie, 2004). Building is a creative and, in the best instances, an innovative act. However, the invention paradigm applies less to construction than most other areas of technology.

The massive system

The balloon-frame construction system has remained preeminent for a long time, over one hundred and fifty years. Over that time, what was once a technologically diverse set of methods used to produce wood and construct buildings has been reduced to a single possibility and, if an analogy to biological diversity holds, then the housing industry has lost its technological resilience. The result is a strong vertically integrated forestry and construction industry, creating a massive system of wood production that ties our forests to our singular method of construction (Hughes, 1989).

Specific varieties of trees are farmed in plantations for their suitability for construction. Our forests are rapidly decreasing their biological diversity to suit the housing industry. Add to this the singular insistence we have about building houses with wood, and this massive industry now tailors everything from the planting of trees to the marketing of houses. Thus a lack of diversity of technique leads to a lack of diversity in our landscape.

The integration of the industry happened in an unusual way. Since housing was built by thousands of small building contractors, construction developed pervasive standards and norms rather than centres of production. It connected forestry to the consumer by standardizing the contractor's building technique rather than by collecting building production under a factory roof. Wood frame construction as it is built today is almost entirely resistant to change or innovation. This is particularly striking when one considers constant revisions to materials and techniques that have typified the last two hundred years. It is resistant to change in an interesting way. It has assimilated minor variations of production such as air-powered staples, small changes in standards such as air tightness, or revisions of consumer preferences such as energy efficiency. As a result, change is incremental rather than systemic, and the integrity of the overall system remains unchallenged. Aside from this, the system is unresponsive, similar to all massive and vertically integrated industries.

Our system of construction is being exported. It is surprisingly successful in other countries despite the impediments of local custom and adverse regulation; it is even making inroads in Japan and Norway, countries with a wood-rich heritage of building. This is not only due to its inherent efficiencies, but also to its integration with North American forestry production (Cavanagh and Kroeker, 2004). Industry sees light wood frame construction as the leading edge of a marketing initiative. North America is pressuring other countries to adopt this way of building in order to create a demand for its forestry products. Many national building regulations and standards such as grading of wood are labelled as trade barriers, and countries are forced to accept global (often North American) norms. Thus, the system is invasive, resists change, and breeds uniformity in both building and landscape. In fact, as this way of building is exported around the world, it arrives as a massive technological system, controlling everything, a massive system with many controls such as the forced plantation of invasive species in the North American landscape and the uniform height of rooms in the houses we live in.

The industry remains rooted in the construction practices of the nineteenth century. The balloon frame depends on a set of parameters that suit the century of its inception. In a time of plentiful materials and scarce labor, it improved the economic use of wood over its whole wood predecessors. However, it has resisted change based on similar transitions. For example, it has not been revised to suit the faster growing plantation wood and more rigid wood composites prevalent today. Plantation wood is less dense, less strong, and less stable than wood harvested in the wild changing the material qualities of lumber significantly. Wood composites contain oriented wood fiber in a resin medium, not just a change in material quality but a change in material. The properties are fundamentally different, not a question of degree but of kind. The introduction of sophisticated computer-driven machinery to build roof trusses replacing rafters, the most complex part of wood framing, has caused no revision to the system. They are simply substituted one for the other. These new materials and new techniques might indicate some larger trend, the possible end to the period of plentiful material and the beginning of computerized framing.

In the middle decades of the nineteenth century, just as construction was undergoing its last major revision, beams and posts disappeared inside the walls and ceilings of our houses hid the technological improvement of the supporting structure and building process. Like many contemporary products, the very process of manufacture and the marks of the craft of assembly are concealed, hidden behind painted drywall and siding. It takes a trained eye to distinguish between a plaster wall and one made with gypsum wallboard. Similarly, the limitations and constraints of our only method of construction have receded well below our conscious awareness.

The individual appearance of houses becomes an adding on of decoration, adding difference. Houses are apparently individual but essentially the same. This attention to decoration can be explained as an attention to style, individual differentiation of applied decoration expressing a range of cultural and individual preferences.

The pluralist return

The determinist and modernist reading would be to assume that contemporary practices are the culmination of centuries of testing and exploration leading to a refined and efficient way of building in wood.

However, current habits of building are not inevitable. Its use has become so customary that we rarely consider alternatives. It is so ubiquitous that it is rarely drawn or detailed in the construction contract – it

is an assumed common practice. This is merely part of a lack of awareness that has contributed to its habitual use.

Building technology does not necessarily lead to uniformity. History demonstrates that increased industrialization of material supply and distribution developed new standards that were often necessary, but sometimes just convenient and arbitrary. For instance, plywood and other sheet goods were introduced with dimensions to suit the standard spacing of wood frame, dimensions not based in any material advantage for the plywood. Some arbitrary standards have wider impact, just as a twelve-foot width of carpeting often limits the size of living rooms, so does the consistent eight-foot length of the wood stud confine us all to live our lives in rooms of uniform height. We are willing to accept a uniform eight-foot ceiling height in almost every room in every house in the country simply because those that supply building materials and construct houses convince us that this is common sense. After all, they say, we all stand about the same height and these taller rooms would be more expensive to heat; why do we need different ceiling heights? As a result, we have been persuaded to care more about plan arrangements and total floor area of houses than their volume and spatial variety. This underlying unconscious assumption that all rooms are the same height is surprising given a cultural emphasis on individuality; one would expect a diversity of spatial living experiences.

Today, nineteenth century stories of hybridity are revived as part of a diachronic, contested, multicultural view of what constitutes national design in an era of globalism. This paper represents this current pluralist view. The reasons for this return to a pluralist interpretation of its origins are to be found in the reinforcement of the idea that it might have been otherwise, balloon frame was not the inevitable technological result for building houses. Instead, the diversity of historic building practices might be reinvested in contemporary practices to make them more diverse and perhaps, more responsive and more resilient.

References

- Benjamin, W. (1976) *The Work of Art in the Age of Mechanical Reproduction*. In Mast, G. and Cohen, M. (eds.), *Film Theory and Criticism* London: Oxford University Press.
- Boorstin, D. (1965) *The Americans*. Toronto: Random House.

- Breen, T.H. (1984) *Creative Adaptations: Peoples and Cultures*. In Greene, J. and Pole, J.R. (eds.), *Colonial British America*. Baltimore: Johns Hopkins Press.
- Cavanagh, T. (1997) Balloon Houses: Original Aspects of Conventional Wood-Frame Reconsidered. *Journal of Architectural Education*, 51 (1), 5-15.
- Cavanagh, T. (1999) Who Invented Your House?. *American Heritage of Invention and Technology Magazine* 14/2.
- Cavanagh, T. and Kroeker, R. (2004) Revaluating Wood in Sustainable Architectures. In Moore, S.A. and Guy, S. (eds.), *Sustainable Architecture*. London: Routledge.
- Conzen, K. (1991) Mainstreams and Side Channels: The Localization of Immigrant Culture. *Journal of American Ethnic History*, 11 (1), 5-20.
- Field, W. (1942) A Re-examination into the Invention of the Balloon Frame. *Journal of the Society of Architectural Historians*, 2 (4), 3-29.
- Fuller, M. (1844) *Summer on the Lakes in 1843*. Boston: C. C. Little.
- Gerstle, G. (1989) *Working Class Americanism: The Poetics of Labor in a Textile City, 1914 – 1960*. Cambridge: Cambridge University Press.
- Giedion, S. (1939) American Development in Design. *New Directions in Prose and Poetry*, 4, 167-179.
- Giedion, S. (1941) *Space, Time and Architecture*. Cambridge: Harvard University Press.
- Haag Bletter, R. (1987) The Invention of the Skyscraper: Notes on its Diverse Histories. *Assemblage*, 2 (Feb.), 110-117.
- Havighurst, W. (1962) *The Heartland: Ohio, Indiana, Illinois*. New York: Harper and Row.
- Hughes, T. (1989) *American Genesis: A Century of Invention and Technological Enthusiasm, 1870 – 1970*. New York: Viking.
- Kammen, M. (1993) The Problem of American Exceptionalism: A Reconsideration. *American Quarterly*, 45 (1), 1-43.
- Leslie, T. (2004) Glass and Light: The Role of Interior Illumination in the Chicago School. *The Journal of Architectural Education*, 58 (1), 13-23.
- Pinch, T. and Bijker, W. (1985) *The Social Construction of Facts and Artifacts: Or How the Sociology of Science and the Science of Sociology of Technology might Benefit Each Other*. In Bijker, W., Hughes, T. and Pinch, T. (eds.), *The Social Construction of Technological Systems*, Cambridge: MIT Press.
- Sprague, P. (1981) The Origin of Balloon Framing. *Journal of the Society of Architectural Historians*, 40 (4), 311-319.

TED CAVANAGH

Stross, B. (1999) The Hybrid Metaphor From Biology to Culture. *Journal of American Folklore*, 112 (445), 254-67.

Wright, F.L. (1977) *An Autobiography*. London: Pomegranate Communications.

Design Practice: Making Beyond Borders

Carla CESARE*
Syracuse University

What does it mean to be British or French when the design processes we engage in are not as local as we imagine? Contemporary maxims such as 'think global, act local' simplify the complexity of design. This paper analyses historical design practices and concepts of being modern to create a new understanding of the creation of national and individual identity. It asserts that the design practice process is central to creating both national and individual identities with construction and consumption as key points, linking the individual and their larger society.

The design practices of middle-class British women used in constructing their identity through home sewing in the interwar period will be set against the complex, international changes led by modernity. Asked will be how 'local' were design practices, when various non-British factors were leading to changes in media, manufacturing, and retail; and as these factors were creating variations in modern taste, to what extent did they cause national identities to be less 'local' and more globally influenced? In light of these variations, historians must question what the boundaries of national identity are as defined by design, and what must be questioned in our understanding of design practices and its history.

Keywords: *Design; identity; design practice; nation-state; home sewing*

Introduction

The development of the nation-state and the individual can, through design practice, be understood as parallel experiences that were formed by conditions of modernity, specifically where identity and shifting boundaries intersected. Location, practice, the impact of science, technology, the economy, and politics—all have a bearing on the socio-cultural development of a society and individual, and design is firmly entrenched in both. In this paper design practices by the individual will be the framework for understanding the role of science and technology in the development of

* Corresponding author: **Carla Cesare** | e-mail: cesarephddesign@yahoo.com

a national design identity. This paper, based in part upon my doctoral research, will analyse the construction of national design identities through the middle-class British women's construction of their identity using the practice of home sewing in the interwar period, set against the complex, international changes led by modernity. It will look at what makes a nation-state, where and how design history fits into that narrative, and how globalization has impacted our ideas of a nation-state while addressing concepts of practice and location through home-sewing.

This parallel between the idea of the nation-state and design history is based upon the premise of their similar changing boundaries and complex make-up. A nation-state is unified by commonalities of culture, customs, goals (economic/political) and history, as is design, yet they are both impacted by change. In this paper they are linked through the creation of identity. 'The modern state developed new technologies of its own to build up, configure, manipulate and mobilize that sense of 'national identity'.

Therefore, when we write about almost any kind of human cognition, behaviour or activity, we are (or should be) writing in part about 'national identity'—and vice versa; [they] also act to construct our national identity.' (Mandler, 2006, pp. 272-273) We also typically regard both histories through major events/iconic designs, or important figures/designers. Events that shift our interpretation of either may be political or technological, but academically we interpret our understanding either through the same means. Both have historical boundaries that shift in large part due to either internal strife or international influence. Today, globalization is a key factor in the evolution of the nation-state. For design history it is important that we look at what these 'shifts' are made up of, and their impact on practice.

The boundaries, events and conditions may change, but their nature and impact do not, therefore, using practice as our framework we can better understand the link between the development of the nation-state and design history.

Methodology

This paper will first examine the characteristics of the nation-state and design history, from both historical and contemporary perspectives. It will explain how design history functions and how it relates to the nation-state.

Identities, both individual and national, are not only linked, but are related to concerns of boundaries, location and community. They are impacted by access to technology and its outcomes, and the ability, need, or desire to move across real and imagined boundaries. Through a visual

analysis and reading of objects, images and text, and their interplay with the individual process of home sewing, the link between the individual and national identity will be forged.

Importantly, the role of design as a practice will be used to investigate where individual and national identities intersected through everyday design practices. The process of design, specifically home-sewing, will be utilized as an investigation of that intersection demonstrating how global influences impacted the individual and local access, along with subsequent decisions. This will be evidenced through technology, retail and mass media; lastly where Britain, which was in a period of great social change, stood in relation to other European responses to modernity.

Discussion: The Nation-State

It has been stated that whereas 'nation-state' once referenced a place of birth it is more recently that, 'the nation-state, even national consciousness, is a result of a deliberate effort to mobilise economic and social resources in the pursuit of large political aims' (The Economist, 1990, p. 73). However historian Eric Hobsbawm notes that 'nations exist not only as functions of a particular kind of territorial state or the aspiration to establish one—broadly speaking... but also in the context of a particular stage of technological and economic development' (1994, p. 10). Design reflects the conflation of these ideas. In relating the development of the Serbian design identity, Branislav Pantelić states that the idea of a nation is created through a mix of language, migration, settlement patterns, myth, beliefs and customs which have no real regard for political borders (2008, p. 131). 'The story of the nation, woven from episodes in history and legend and often blurring the distinction between fact and myth, provides a semblance of historical authenticity and is accepted as indisputable truth and testimony to cultural continuity.' (ibid., p. 131). The shifting boundaries of design history and that of the nation-state share similar conditions. Thus, the dissection of actual behaviours through practice can lead to the dispersion of myth and a better understanding of the intersection of identity and practice, both individual and national.

Further, one can link the terrain of the individual to the terrain of the nation state through its relationship with those entities or conditions which surround it and to which it must relate. As Hobsbawm notes the nation 'is...the product of particular, and inevitably localized or regional, historical conjunctures' (1994, p. 5) yet, he states further, 'official ideologies of states and movement are not guides to what is in the minds of even the most loyal citizens or supporters. We cannot assume that for the most people national

identification—when it exists—excludes or is always or ever superior the remainder of the set of identifications which constitute the social being’. (ibid., 1994, p. 10) As Anderson has defined national identity ‘it is an imagined community...It is imagined because even the smallest nation will never know most of its fellow-members, meet them, or even hear of them, yet in the minds of each lives the image of their communion. (2006, p. 6) We link abstract concepts of national identity through individual, yet common, practices. This struggle between individual and nation and public and private is a pivotal aspect of home sewing in Britain between the wars. Embattled by the war, the domestic front signified safety in tradition, and did not rest easily with the modern.

Design History

Science and technology reach everyday lives through design, each reflecting the capacity of society to evolve. Design is used to create identity, and the ability to do so is affected by this potential. It is this relationship that creates a direct link between nation-states and design. Brinkman states, ‘Culture evolves with the evolution of knowledge which in its application appears as technology. Technological advances, as a process of economic development relate to the core of culture and accounts for the dynamics of culture evolution’. (2008, p. 426) Hence ‘nations and their associated phenomena must therefore be analysed in terms of political, technical, administrative, economic and other conditions and requirements’. (Hobsbawm, 1994, p. 10)

These are all factors that are related to consumption as well, particularly in the interwar period when mass production was on the rise. Less expensive goods, new job markets and social opportunities made the potential to have more possible, and in turn created new reasons to have more. Consumption and design go hand-in-hand, as stated by Clark that ‘aesthetics, taste and design are drivers in consumption, just as they are the construction of identity’, (2009, p. 258) and construction requires production. We see this idea of the machine being linked to our lives and society continued today as is reiterated by Gonzaga, ‘through desire, machines connect or conjunct with other machines to form new machines and assemblages, production life itself-affects, signs, values, relations multiplicities, subjectivities, lines of rigid segmentarity, lines of supple segmentarity, and material and immaterial flow of all kinds...the producer and the product are both the products of machinic production’ (2009, p. 4).

Through a growing consumer society the boundary between relations of man and machine are no longer separate, just as the physical boundaries of a nation-state are not fixed to one notion, but linked to the varying factors which create it.

Location

This idea of place and space is central to the concept of a nation-state, and the creation of one's identity. When we attempt to define a nation by its geographic boundaries, they are frequently challenged or changed, therefore a different interpretation is required. In this research place is defined by the practices and relationships between objects, individuals and larger social groups creating not only a physical location but a way of managing one's world, via identity, memory, the temporal; the negotiation of real and imagined boundaries. Place becomes space by the actions which occur there, making requires movement, both intellectual and physical, and design is a process of actions. These actions and relations are determined by location and propriety, as Mayol states that, 'the neighbourhood thus appears as the place where one manifests a social 'commitment'; in other words an art of coexisting with the partners (neighbours, shopkeepers) who are linked to you by the concrete, but essential, fact of proximity and repetition...propriety...is at the level of behaviours, a compromise in which each person, by renouncing the anarchy of individual impulses, makes a down payment to the collectivity...the dweller becomes a partner in a social contract that he or she consents to respect so that everyday life is possible'. (1998, p. 8) These accepted commonalities of practice, both public and private, ideally, allow a nation to live together and evolve. Home sewing is both a public and private practice, which requires a network of people to both learn from, purchase from and interact with to create, not just an individual identity, but one that allows the owner to function in their community. If, as de Certeau and Giard state, 'a culture is judged by its operations,' (1998, p. 254) then who we are is defined as much by where we are as by propriety, the rules of negotiating the space.

This *idea* of the British home and its boundaries was particularly important during the interwar period when domestic practices and social boundaries were changing. The conditions of modernity in interwar Britain were of rapid change on the technological, social and political fronts and the subsequent impact on women was enormous. The boundaries were no longer just physical walls of the home or of the neighbourhood but outside influences that were less tangible. They were at odds not only with other European identities, the foreign, the left, but the influences of 'new

cultures' forsaking tradition and an era when Britain ruled. It was being lured by the mass production possibilities of the machine-driven United States and its glamorous world of Hollywood. After the war Britain was reeling from the number of men lost in WWI and the need to acclimatize to having the returning soldiers back, which included their desire to move women from the work front to the domestic front (Cesare, 2013, p. 83).

Home and hearth were being promoted as synonymous with the British identity of tradition, and in a period of class fluctuation this thinking could be a stabilizing or conflicting concept of everyday life in the act of creating one's identity. As Bingham notes, 'once the conflict was over they were unceremoniously sent 'back to home and duty.' A post-war 'backlash' meant that traditional gender dichotomies were re-established, and an ethos of 'domesticity' pervaded popular culture.' (2004, p. 225). Reflecting this, home building nearly tripled between 1920-1934 from 369, 446 to 1,147 million plus homes being built. (Montgomery, 1957, p. 30) With increasing home ownership, concepts of the construction of home and family were changing as identified by Jeremiah with 'the image of the family in the context of home and as a consumer of products directs attention to the representation of social order and values'. (2000, p. 39) Importantly, 'the house was the last refuge for expression...informed by an exact understanding of the needs of everyday life'. (ibid., p. 71) Home sewing is a domestically based, gendered-practice caught between being traditional and modern, British and worldly. Social boundaries are manifest in behaviours that are visually translated through the body and buildings via practice. Practices in the home played a part in the construction of identity while simultaneously reflecting outside influences on a community.

Design as Practice

The process of design is a series of steps, which in the most simplistic terms is production, consumption and mediation: defining media as dissemination, as a designed object and the object as a form of mediation (Lees-Maffei, 2009). However, it would be erroneous to consider them in that linear method as each step requires parts of the other, overlaps and shifts during the process. This paper asserts that this model should be expanded to include all the steps of the design process to more fully integrate the depth of possibilities that exist in studying design as practice to appreciate the breadth of variety of identities that are involved. As Buckley suggests 'defining design is not just about things, but the matrix of independent practices' (2007, p. 7). This matrix allows for the visualization

of home sewing as a design practice. Home and body are the terrain of everyday life and this link is best understood through the realization of practices in a bounded space, it becomes a means of passing through the conventional limits between public and private. Sewing is an activity necessary for both private and public appearances.

Application of the production-consumption-mediation paradigm in relation to practice starts with desire or need. For home sewers in the interwar period inspiration came from magazines, movies, or shop windows (mediation). These require to be purchased (consumption) along with materials (fabric, notions, patterns), it also required the ability to actually make goods or find a resource to have it made (production).

The reading of mass media, magazines, trade journals and advertisements allows for an understanding of the conditions and aspirations of society and its relationship to the value placed on objects, their making and how they are being made. As Aynsley and Forde state, 'design decisions about the appearance of a magazine layout can be informed by a number of aesthetic, economic, political and social forces.' (Aynsley and Forde, 2007, p. 17). Because desire is often spurred on through media, those images and placements are essential not only to the making of goods, but also to the making of identity. Media analysis also strengthens history's understanding of the everyday practices in the individual's daily life. This 'reading' of media is best understood threaded throughout our interpretation of design as a practice.

Further, an understanding of how science and technology impacted these practices is required. The types of technology available to women, and what they reveal about inter-war Britain is a significant part of the story.

Technology was an aspect of practice that reflected the contradictory nature of home sewing. The long history of the sewing machine, hence sewing, as an essential part of the home has caused it to be taken for granted. A tradition and object passed down through generations, a literal part of the furniture as it became encased in cabinetry, lacking the novelty of the new appliances that required electricity.

From fabric to frock in two hours

At just after three Joan arrived home with the material for her new frock. Two hours later she was admiring the finished garment. Such is the speed a Singer Sewing Machine brings to home dress-making. Such is the ease. The newest device can acquire the "two hour habit" if she owns a Singer. Fancy stitching is as simple as the placement of pins. Tucking, Braiding, Quilting, Hemming, Darning, Ruffling, Embroidery, Plating are only a few of the effects that can be achieved. Singer machines, too, are no longer just marvellously efficient sewing machines. They constitute artistic pieces of furniture with no suggestion of their real utility. By one simple movement the machine disappears leaving a handsome table or cabinet. All can be purchased on the easiest of easy terms. Ask to see the newest machines at your local shop.

SINGER SEWING MACHINES
Hand, Treadle or Electric

Singer Sewing Machine Company Ltd., Singer Building, City Road, London, E.C.1 Shops in every town
You see it in "Modern Home"!

Figure 1 Singer Sewing Advertisement, *Modern Home*, October 1931. The Bankfield Museum 2009.252, Halifax, UK.

By the 1930s however, the sewing machine of the inter-war period could range from a hand machine or a foot treadle to the new electric type (which would have been out of the price range for most women at the time). Singer sewing machines recognized these concerns and in their advertisements emphasized the variety of machines available; treadle, hand or electric, but regardless of which technology you chose you could have a dress made in two hours (figure 1). Of the fifteen women interviewed ranging from working-class to upper middle-class, all kept what they had and did not buy anything new until absolutely necessary, often handing down their old machine to family.

Technological changes in the sewing machine reflected its importance and investment in the household. The hand sewing machine was a tabletop machine with a wheel on the right that the user would have to continually turn to move the needle up and down. During the inter-war years the foot treadle, which left your hands free, was of increasing popularity. It was encased and set on a metal frame with the pedal at the base and a pulley system attached to the flywheel at the machine on the right hand side. As

the operator pushed the pedal it moved the flywheel allowing the (former hand) wheel to move so the operator could now use two hands to manipulate the fabric and do more complex stitching much faster. While dress silhouettes were simplified the speed at which fashion was changing, and propriety required greater efficiency for a woman's rapidly transforming wardrobe.

These advancements affected its location in the home and its static status. Its location could be both prominent and functional. They could be portable or located in a wooden cabinet; stored away or in a place of 'status'; or, logically located for the best access to light. 'This does not mean that the newer electric machines did not have lights, in *The Big Book of Needlecraft* [1932] it mentions a Singer machine which had a 'Singerlight', 'an ingenious little electric light fixed to the arm of the Sewing Machine in such a way as to throw a pleasant light just on the right part of the work being sewn'. (Cesare, 2013, p. 163) If affordable this would have been useful for a working woman that did not have daylight hours to sew, and required the evening to work on her home sewing.

All of these require consideration in the overall experience and accessibility of participating in a practice. As skills levels varied a woman had options for 'running up' a dress at home if she had the skills and confidence, or to go to a draper's shop or department store where they would occasionally hold special sales where you could purchase fabric and the pattern and the shop would cut it and sew it up for you, but you could add the embellishments. Levels of engagement with modernity were often based upon a woman's skill, time and the budget to sew at home. It was not just sewing machines that were reflective of technology.

Textiles were another area of home sewing that was greatly impacted by science and technology. The increase in varieties from fabric blends to 'artificial silks' added to the decision making process of design. The different materials created questions of choice, affordability and quality, and it had broader economic implications. The affordability of the new fabrics was a result of the new synthetic materials that were being produced. These reflected and supported the more active lives that women led from sports to new jobs in retail and businesses. The fabrics would supposedly wear well and not wrinkle as easily. However, while there were concerns about shrinkage and washability, the biggest impact was the greater range and affordability.



Figure 2 Tobralco Fabric Sample, 1927, author's collection.

Frequently the newer materials such as rayon had trouble with washability and shrinkage, leaving them to be used for special events. (de la Haye, 1993, p. 46). This is supported in an interview with a Mrs. Alexander, who remembered taking trips into town to window shop and compare quality of fabrics and ready-made wear; notably her mother was generally concerned with the quality of many goods. (Cesare, 2013, p. 149) Indeed, they were just as likely to spend a day shopping for fabrics that her mother would then sew into dresses, 'lovely' skirts or blouses. (ibid., p. 169) The economics of how long one could wear a dress had to be considered in relation to the quality of shop goods, and individual taste. The increasing options for styles, fabrics, shopping and means of production meant women were negotiating a multitude of ways of determining their lives. (ibid., p. 154).

An example of the importance of fabrics can also be understood through the experience of another interviewee, Mrs. Sheldon, who was able to recall a fabric she purchased in 1932 called Tobralco, a new cotton blend available in a variety of patterns and colours. (Cesare, 2013, p. 138) In this sample shown here from 1927 (figure 2) the changing lifestyle for women is evident in the use of both a tennis player and young children on the packaging, as well.



Figure 3 *Tricoline and Righton's advertisements, Weldon's Bazaar, June 1924, Beamish, The Living Museum of the North, Durham, UK.*

as the variety of traditional floral and bolder, graphic prints. In particular the floral pattern is reminiscent of a pattern recalled by Mrs. Sheldon, and Mrs. Alexander's memory of her enthusiasm for tennis playing. This research supports the marketing of Tobralco as an interesting reflection of the flexibility that was required for life at the time. The fabric came in a large variety of patterns and could be used for both sport and everyday needs.

Women could be both sportive and domestic and new technological advances would allow them to fulfil these opportunities (ibid., p. 138-139).

Technological advancements in textiles, both promoted and supported the life of a modern woman, with her traditional domestic duties of home sewing and 'new' lifestyle of sports and working.

The variety of these new fabrics such as Celanese and Tricoline, are seen in the advertisements women would have read in magazines, and as promoted in the trade journal *The Draper's Record*. The inexpensive fashion monthly *Weldon's Bazaar* featured an advertisement for Tricoline, the equal to silk. It heralded its rich appearance of silk and considerably less cost.

Right next to it is another advertisement for Rightons, offering wool, silk, art-silk and cotton fabrics. (figure 3) Tricoline also used a very modern aesthetic in a double page spread of an active woman in 1934 in *The Draper's Record*.



Figure 4 Russian Influence, *Fashions For All*, January 1931, Bankfield Museum, Halifax, UK.

As these advertisements and experiences evidence, there is a clear relationship between the trade, retail and media both promoting international, modern style and the values of Britishness and British goods, requiring the negotiation of increasing foreign products coming onto the market. Retailers and middle-class women alike had to strike a balance between being worldly, yet local. The textile industry tradition in Britain had to respond to the new demands for affordable fabrics and the interest in novelty designs.

One of the markers of the period was the rapid change in fashion and the ability of not only the consumer, but also the retailer to manage it.

These new synthetic materials and others, such as machine-made lace, were a concern to retailers, specifically drapers, the fabric salesmen. In the trade journal *The Draper's Record* of January 1931 'Fashion Forecasts' included the interest in Manchester cottons and artificial silk velvets, Nottingham lace alongside Russian influence in daytime dresses. This is also evidenced in a monthly fashion magazine *Fashions for All* in January 1931 (figure 4). It should be noted that references to Parisian style influence were ubiquitous throughout trade and retail magazines. Yet, an advertisement for straw-hat dyes emphasized that it was 'Entirely British'. In the midst of the

internationalism was a focus on regionalism and an assertion of 'Britishness' (figure 5).



Figure 5 British Straw Hat Dye, Mab's Fashions for Children, May 1926, Bankfield Museum, Halifax Museum, UK.

Domestic and international production and influence were having an impact in the retail world. The possible economic threat of cheaper, imported goods was also an issue. Relations with Japan were becoming a concern as noted in two articles 'Why Go To Japan' where it was revealed that some London firms were buying the much lower priced Japanese textiles, while in 'Italy to Combat Japanese Competition' it noted that, while Anglo-Japanese relations were at a standstill, the fascist government of Italy was acting aggressively through nationalization of the industry and guaranteed price controls, with the goal of improving exports (April 17, 1934, p. 4). Earlier, in July 1933 the journal reported that an increase in duties on imported lace and embroidery was levied, much to the satisfaction of British manufacturers (p. 7).

Changing retail methodologies were a concern and they often looked to the United States for inspiration. American use of sales psychology and pricing systems was much admired as evidenced by articles in the *The Draper's Record* where it noted the success of even and uneven (\$2.49 as opposed to \$2.50) marking of prices in a mail-order catalogue. (April 7, 1934, p. 26) Following the sales projections in 'American Stores Plan Bigger Sales in 1934' noted the National Retail Dry Goods Association was expecting an increase averaging 20% for 1934. (Sept. 30, 1933, p. 47), excluding mail-order or chain stores. This designation is significant as drapers were feeling pressured by the growth of department chain stores and their sales techniques. Standardized stock and limited price ranges, no

credit, delivery or approval sales, and regular sales events were overtaking traditional, customized service. This simplification by the new retail settings was creating angst and concern about the traditional way of selling. (Oct. 15, 1932, p. 21-22) The appearance of these 'bazaar' style stores (co-ops and chains) deemed more attractive than the small shops and storefronts where most drapers were located, was considered. (ibid., p. 15,16) The more impersonal relationship where the price was the greatest motivator for a sale minimized the relationship the consumer had with the shop owner altering the sense of community.

European Modernity

Influence, methods, new aesthetics and technology were all having an impact on the British way of life; and as evidenced it was due to domestic changes and international influence. These concerns and responses are part of the experience of early twentieth-century modernity. Contemporary understandings of globalization may consider our current era to be different from earlier periods; according to Gonzaga, 'Our world is said to represent a distinct break from previous epochs with its frenzied mobility of goods, bodies, images, information, money and technology over porous remaking everyday spaces and no borders'. (2009, p. 1) This research suggests that this porousness, and these fissures and changes were evident well before the twenty-first century. The rise and fall of countries with their last gasps of nationalism are evident in design practices. Modernist architect Le Corbusier recognized that 'modern industry was not only remaking every day spaces and things; it was also producing new kinds of consciousness and desired and, in turn, new inhabitants and citizens.' (Crowley, 2006, p. 342).

In the midst of this change these were often at odds with a desire to maintain one's local or regional identity, the use of traditions and the vernacular regionalism was often 'a conscious response to the homogenizing and universalizing effects of modernity'. (ibid., p. 348) The vernacular could be interpreted as a new form of democracy as some have debated in Swedish design, a type of liberty in what was seen to be 'an increasingly authoritarian age'. (ibid., p. 350). Whereas in Italy, 'in the fascist vision, the countryside was not sacred the site or autochthonous tradition from which *italianità* (Italianess) could be drawn...but a world to be improved' (ibid., p. 354). 'While Swedish Modernism accommodated local materials and craftsmanship, modern Italian architecture and design were applauded for their deep historical reserves' (ibid., p. 351). Ironically, Britain, which held long reservations against modernism, became one of the

few places (due to migration) where it could develop just prior to World War II. However, it largely did not take hold outside of civic building design.

Conclusion

The history of design has a parallel existence with that of our understanding of the nation-state. They are defined by boundaries, modes of existence and subjectivity. Is it cultural? Social? Political? Is it material, technological or economic? The reality of design history and the nation-state is that it is all of those things. These varying facets reflect society and the biography of an object. Being both made and material, objects can be understood through science and technology, and that understanding is refracted back to the industry through materials and methodologies. Nation-states have ever changing boundaries that go beyond the geographical, leaving us to map the definition of a nation-state through a variety of narratives.

In this research we pinpoint three facets where science, technology and practice are connected to help us re-evaluate their role in 'nation' building: mass media, materials, and retail through technology. The production-consumption-mediation paradigm, expanded and defined through design as a practice, was impacted by science and technology through: mass media, new fabric blends and artificial silks, developments in sewing machine technology, different international selling methods and style influences. The development of mass media, aided by technology, allowed women to access and be a part of these imagined communities beyond their local boundaries. International influence through stylistic influence, retail methodologies and materials created both a pressure and a change on shop owners to 'modernize'. New materials and improved machinery allowed women to design for themselves faster and less expensively. These combined changes revealed to them a world of possibilities of how they could present themselves, not just as British women, but as more worldly British women: modern, sophisticated and knowledgeable.

The paradox of defining oneself was aided by the opportunity to redefine one's personal and cultural boundaries through dress and home, yet remain part of a broader community. The precarious nature of the individual is stabilized by the ideals and practices of the wider world; and a stabilized individual can better weather the changing boundaries of the wider world. Much like the nation-state whether one is defining it through language, politics or economics, design history leaves traces drawn in the past. This research states that it is the practices of the individuals that

define who they are privately and socio-culturally. These practices, when applied to design and making, in this case home sewing, are directly impacted by science and technology. It exposed them to more ideas, it made affordable more materials, and it sped up the process of making. This research proves that understanding design history and the nation-state through practice, reveals the underlying network of ideas, means and materials and how they study can highlight how practice is not just a question of skill, but also a network of ways, understandings and methods to create new objects, new identities, and in turn new histories of identity and place, individual and national.

References

- Anderson, B. (2006) *Imagined Communities: Reflections on the Origin and Spread of Nationalism*. London: Verso.
- Aynsley, J. and Forde, K. (2007) *Design and the Modern Magazine*. Manchester: Manchester University Press.
- Bingham, A. (2004) An Era of Domesticity? Histories of Women and Gender in Interwar Britain. *Cultural and Social History* 1 (2), 225-233.
- Brinkman, R.L. and Brinkman, J.E. (2008) Globalization and the Nation State: Dead or Alive. *Journal of Economic Issues*, 42 (2), 425-433.
- Buckley, C. (2007) *Designing Modern Britain*. London: Reaktion.
- Butler, J. and Spivak, G.C. (2007) *Who Sings the Nation-State?* London: Seagull Books.
- Cesare, C. (2013) *Sewing the Self: Needlework, Femininity and Domesticity in Interwar Britain*. A Thesis Submitted in partial fulfilment of the Requirements of Staffordshire University for the Degree of Doctor of Philosophy. Newcastle-upon-Tyne: Northumbria University.
- Clark, H. (2009) *Introduction*. In Clark, H. and Brody, D. (eds.), *Design History Reader*. London: Bloomsbury.
- Crowley, D. (2006) *National Modernisms*. In Wilk, C. (eds.), *Modernism: Designing a New World, 1914-1939*. London: V&A.
- de Certeau, M. and Giard, L. (1998) *A Practical Science of the Singular*. In de Certeau, M., Giard, L. and Mayol, P. (eds.), *The Practice of Everyday Life: vol.2 Living and Propriety*. Minneapolis: University of Minneapolis Press.
- de La Haye, A. (1993) The Dissemination of Design from Haute Couture to Fashionable Ready-to-wear during the 1920s with Specific Reference to the Hodson Dress Shop in Willenhall. *Textile History*, 24 (1), 39-48.

- Gonzaga, E. (2009) *Globalization and Becoming Nation*. Quezon city: University of Philippines Press.
- Pantelič, B. (2008) Designing Identities, Reshaping the Balkans in the First Two Centuries: The Case of Serbia. *Journal of Design History*, 20 (2), 131-144.
- Hobsbawm, E. (1994) *Age of Extremes: The Short Twentieth Century 1914-1991*. London: Abacus.
- Lees-Maffei, G. (2009) The Production–Consumption–Mediation Paradigm. *Journal of Design History*, 22 (4), 351-376.
- Mandler, P. (2006) What is ‘National Identity’? Definitions and Applications in Modern British Historiography. *Modern Intellectual History*, 3 (2), 271-297.
- Mayol, P. (1998) The Neighborhood. In de Certeau, M., Giard, L. and Mayol, P. (eds.) *The Practice of Everyday Life: vol.2 Living and Propriety*. Minneapolis: University of Minneapolis Press.
- Montgomery, J. (1957) *The Twenties: An Informal Social History*. London: George Allen & Unwin, Ltd.
- Renan, Ernst. (1882) *What is a Nation?* A lecture delivered at the Sorbonne, 11 March 1882. Available from: http://www.cooper.edu/humanities/core/hss3/e_renan.html [Accessed April 29, 2014].
- Said, E. (1978) *Orientalism*. New York:Vintage.
- The Draper’s Record* (1931) Fashion Forecasts. (p. 24) 3rd January.
- The Draper’s Record* (1932) Why Go to Japan. (p 4,27) 15th October.
- The Draper’s Record* (1932) London Drapers Developing the ‘Cash and Carry’ Trade. (p 15-16) 15th October.
- The Draper’s Record* (1932) New Forms of Trading Challenge the Draper. (p 15, 21-22) 15th October.
- The Draper’s Record* (1933) Higher Duties on Headwear, Lace and Embroidery. (p. 7) 1st July.
- The Draper’s Record* (1933) Clothing Plus ‘Living-in’ for Retail Assistants. (p 31) 30th September.
- The Draper’s Record* (1933) American Stores Plan Bigger Sales. (p. 47) 30th September.
- The Draper’s Record* (1934) Price Psychology: An American Store’s Experiment. (p. 4) 7th April.
- The Draper’s Record* (1934) Why Go to Japan. (p. 4) 14th April.
- The Draper’s Record* (1934) Italy to Combat Japanese Competition (p. 27) 14th April.

CARLA CESARE

The Economist (1990) *With All Her Faults She Is Still My Country* (The State of the Nation-state). (December 22) 317 (7686),73.

'We, L'Aquila': Production and representation of urban space through a social map platform

Manuela FARINOSI^{*a} and Alessandra MICALIZZI^b

^a Università degli Studi di Udine; ^b Università Cattolica del Sacro Cuore

Socio-technical objects play a pivotal role in transforming and handing down the perception of a certain space. The most recent mapping software allows representing the physical and the relational characteristic of the space. This practice takes on a new meaning when the space in question is no longer accessible by the citizens. When a city has been destroyed by a strong earthquake, the representation of the urban space as it was before the disaster can take place in interactive space and its reconstruction passes through a 'socio-technical network' composed by heterogeneous actors.

The following paper is about the qualitative and quantitative content analysis of the content posted on a social map platform named 'Noi, L'Aquila', created by Google after the L'Aquila earthquake of 6 April 2009.

The main aim of the research is to verify how the urban space of L'Aquila has been represented through the Google social map. The main findings of our analysis show that the social production of the urban space through an online map platform represents a complex process and highlights the role played by a socio-technical object in emotionally supporting the impossibility to access to the offline spaces damaged by the earthquake.

Keywords: *Disaster; new media studies; emotion; memory; geolocalization*

1. L'archivio digitale come realtà interattiva geolocalizzata: prassi e procedure della rimemorazione

Si tende a considerare la memoria secondo due accezioni differenti: come competenza connessa alla capacità di trattenere episodi relativi a un tempo antecedente; come pratica narrativa (Sciolla, 2005), ovvero un

*Corresponding author: **Manuela Farinosi** | e-mail: manuela.farinosi@uniud.it

processo dinamico e in costante divenire volto a reinterpretare e ricostruire il passato a partire da un dialogo mai interrotto con il presente (Zerubavel, 2003). E ciò vale sia quando parliamo dell'individuo e della sua esperienza (Jedlowski, 2009), sia quando ampliamo lo sguardo considerando un'intera comunità (Halbwachs, 1997). In questa sede, cercheremo di guardare soprattutto alle pratiche rimemorative e alle loro evoluzioni negli ambienti digitali ed interattivi della Rete, ponendo l'accento sul valore elaborativo della condivisione in questi spazi quando l'esperienza collettiva risulta traumatica. In modo particolare, ci soffermeremo sugli aspetti locativi: la memoria infatti può essere rappresentata da mappe, che ne descrivono i processi da un punto di vista cognitivo (Kuraman e Maguire, 2005) e le evoluzioni socio-culturali (Zerubavel, 2003); è localizzabile 'internamente', ovvero in precise aree cerebrali, o 'esternamente', in supporti di archiviazione di massa.

L'elaborazione di un'esperienza in termini narrativi diviene 'un attivo ritornare del soggetto sulla propria storia che porta alla luce il sapere non-ancora-cosciente di ciò che è stato' (Jedlowski, 2009, p. 21). Nel caso del trauma, soprattutto se collettivo, la memoria diviene una forma di resistenza alla crisi, intesa nel suo originario significato di separazione che, rispetto all'oggetto di studio presentato nelle prossime pagine, coincide con uno strappo violento da case, cose e soprattutto luoghi.

In questa prospettiva, narrazione, memoria ed esperienza diventano termini tra loro strettamente interconnessi. Nelle situazioni particolarmente critiche e traumatiche, però, la competenza narrativa viene meno, come sottolinea Jedlowski (2009, p. 20):

questo deperimento dell'esperienza è ciò che accade nelle situazioni acute di disagio, dove l'incapacità di rendere conto del vissuto, di stabilire le coordinate della propria esistenza, assume esattamente la forma dello spaesamento

Da questo breve stralcio, risulta evidente l'imprescindibile legame tra memoria e spazio, come metafora e come coordinata locativa del ricordo.

Spostando lo sguardo sulla Rete e sul suo ruolo nei processi di sedimentazione e negoziazione della memoria collettiva, è possibile guardare al web, e in modo particolare agli ambienti social, nella doppia accezione di potenti archivi di frammenti narrativi (De Carli, 1997) e di contesti di negoziazione e co-costruzione della memoria condivisa (Ferron e Massa, 2011). Detto in altre parole, la Rete si presta a essere studiata come luogo della memoria e come contesto della rimemorazione. Luogo che

presenta delle architetture peculiari, su cui si innestano precise pratiche da parte degli user, dove la presenza passa soprattutto attraverso la pubblicazione di uno o più frammenti narrativi. E tali «artefatti digitali presentano caratteristiche peculiari a livello di composizione, autorialità, significato, circolazione, lettura, visualizzazione, navigazione, interattività ed espressività» (Burdick et al., 2012). Ma non solo. Secondo boyd (2007), lo spazio digitale è accostabile a quello geografico, pur presentando degli elementi che lo rendono unico e che sono la persistenza – o permanenza – la scalabilità, la replicabilità e infine la ricercabilità: tutti aspetti che intervengono sulla disponibilità dei contenuti e sulla loro preservazione nel tempo.

Contemporaneamente il web e in modo particolare alcune piattaforme come Wikipedia, forniscono contesti per la negoziazione della memoria e la costruzione partecipata. In questi spazi, «le memorie collettive si formano in maniera discorsiva e situata, attraverso la discussione, la ricerca e la selezione di informazioni rilevanti, l'argomentazione di diverse prospettive e l'interazione tra gli utenti mediante gli strumenti messi a disposizione della piattaforma» (Ferron, 2013, p. 146). Per quanto dinamico e aperto, il processo rimemorativo in questo caso è più prossimo alla cosiddetta 'memoria di conferma' (Namer, 1996).

Sia che si tratti di una mera opportunità di archiviazione che di una pratica volontaria ricostruttiva, la Rete ospita e fornisce occasioni di visualizzazione della memoria, oltre che di oggettivazione ed esternalizzazione della stessa (Frostig, 2014). Una visualizzazione che in genere viene restituita da una mappatura, da una precisa geografia della memoria o delle memorie.

Tra sedimentati spontanei e processi ricostruttivi volontari e specifici si pone il progetto 'Noi, L'Aquila', descritto in modo approfondito nel prossimo paragrafo, dove si abbina alla rimemorazione, come pratica condivisa, aperta e partecipata, l'opportunità di costruzione di un archivio geolocalizzato delle memorie di una città – L'Aquila – attraverso stralci autobiografici. Questa contaminazione tra luogo fisico e luogo digitale acquista maggiore rilevanza nella misura in cui le geografie mnestiche ricostruiscono un territorio colpito dal terremoto del 2009, che ha causato la distruzione di molti spazi di rilevanza sociale e culturale. In questo caso la micro-narrazione del singolo cittadino, intima e ad alto potere locativo, diviene il frammento minimo per la ricostruzione.

2. Crisi dei luoghi e vissuti dell'emergenza: la ricostruzione digitale proposta da Google

Un terremoto rappresenta un momento di distruzione e di crisi profonda per l'intera comunità, un evento catastrofico che sovverte il normale ordine delle cose, creando un diffuso senso di incertezza e una totale alterazione delle routine quotidiane (Cattarinussi e Pelanda, 1981; Dynes, DeMarchi e Pelanda, 1987; Quarantelli, 1998). Colpendo sia la sfera personale sia quella socio-politica, destabilizza l'intero sistema sociale e sottopone a una 'situazione di stress collettivo' (Barton, 1970). Nei casi più gravi tali fenomeni possono portare anche alla perdita dei tradizionali luoghi di aggregazione che diventano inagibili e/o inaccessibili a seguito dei danni provocati dalle scosse sismiche. E questo è esattamente quanto si è verificato a L'Aquila, capoluogo abruzzese che la notte del 6 aprile 2009 è stato duramente colpito da un sisma di 6.3Mw. Il terremoto ha causato la morte di 309 persone, e ingenti danni agli edifici, in particolare alle costruzioni del centro storico, cuore pulsante della vita sociale, politica e culturale del territorio aquilano. Nei giorni immediatamente successivi al sisma il centro è stato oggetto di una serie di ordinanze di inagibilità riguardanti l'intero patrimonio edilizio pubblico e privato e di disposizioni di divieto di accesso e percorrenza per i 'non addetti ai lavori' all'interno di una vasta area dichiarata 'zona rossa'.

In questo drammatico scenario prende forma 'Noi, L'Aquila' (figura 1 - <http://www.noilaquila.com>), progetto sviluppato da Google in collaborazione con il Comune dell'Aquila, l'ANFE (Associazione Nazionale Famiglie Emigrati), l'Università degli Studi dell'Aquila e l'architetto inglese Barnaby Gunning. L'iniziativa, basata principalmente su una piattaforma online composta da una mappa digitale navigabile ed editabile, ha un duplice obiettivo: 'ricordare il passato della città e preservare il ricordo dell'Aquila prima del terremoto, al fine di tramandarlo alle generazioni future; e ispirare il futuro dell'Aquila, mobilitando la comunità italiana ed internazionale per stimolare il progetto di ricostruzione della città attraverso l'utilizzo di modelli 3D'.¹

Fornendo le immagini a livello stradale a 360° acquisite da StreetView prima del verificarsi del disastro, Google vuole contribuire a far riscoprire - seppur digitalmente - agli abitanti dell'Aquila la sensazione di camminare lungo strade che non sono più percorribili, rivedere posti in cui purtroppo

1 Sezione 'Domande frequenti' del sito <http://www.noilaquila.com/>

non potranno far ritorno, e ritrovare palazzi e monumenti che attualmente non esistono più, facendo in modo che quanto è andato distrutto non venga dimenticato e permettendo agli utenti di condividere online un loro ricordo.

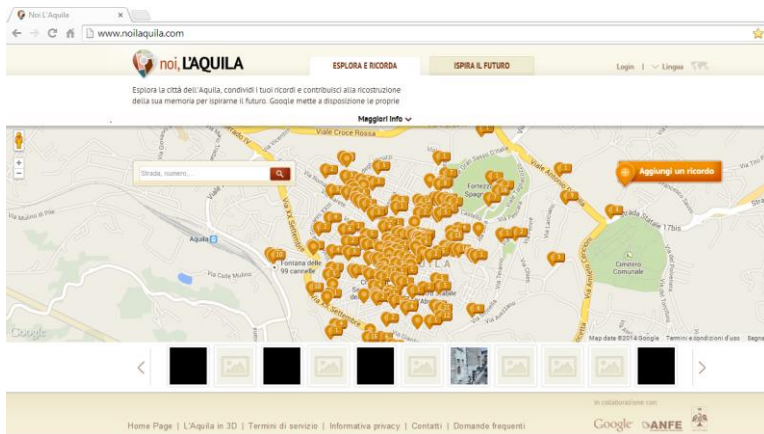


Figura 1 Schermata iniziale della piattaforma 'Noi, L'Aquila'.

Potenzialmente il più grande merito di 'Noi, L'Aquila' è quello di non considerare la città come un semplice spazio geografico, ma di vederla anche come una rete di relazioni, storie, desideri, dando visibilità ai singoli racconti individuali e, al tempo stesso, rendendo la memoria collettiva di quel territorio accessibile al vasto pubblico della Rete.

Google ha sviluppato una piattaforma simile a 'Noi, L'Aquila' anche per il Giappone e la zona di Fukushima, interessata da terremoto, tsunami e disastro nucleare nel marzo 2011. Sulla falsariga del modello aquilano, il sito, chiamato 'Mirai e no kioku', ovvero 'Memorie per il futuro', consente di fare una comparazione tra il prima e il dopo e di vedere l'attuale situazione delle zone colpite. Ma le piattaforme Google non sono gli unici esempi esistenti di archivi digitali creati per supportare la riappropriazione della memoria collettiva a seguito di un evento traumatico. Due importanti precedenti possono essere individuati in '911digitalarchive', una raccolta online di racconti, immagini, email, documenti, suoni e video relativi agli attentati terroristici dell'11 settembre 2001, e in 'HDMB (Hurricane Digital Memory Bank), archivio online creato a seguito dell'uragano Katrina che nel 2005 colpì la città di New Orleans.

La piattaforma 'Noi, L'Aquila' è composta da due sezioni specifiche (figura 1):

1) 'Esplora e ricorda', che, grazie alle immagini precedentemente catturate da Google Street View, consente alle persone di girovagare virtualmente per la città prima del terremoto. L'utente ha la possibilità di selezionare uno o più luoghi e condividere memorie testuali o visuali legate al passato degli stessi;

2) 'Ispira il futuro', che permette a quanti interessati di cimentarsi nella ricostruzione in grafica 3D degli edifici del centro storico, riportandoli virtualmente allo stato in cui erano prima del sisma e fornendo una possibile traccia da seguire per la futura ricostruzione della città.

Parlando di 'Noi, L'Aquila' il sindaco Massimo Cialente ha sottolineato che l'iniziativa rappresenta 'un modo per far conoscere al mondo L'Aquila. [...] Un ponte tra noi e il futuro, passando per una memoria comune fatta di emozioni e di ricordi, che sono poi la base della nostra identità e del nostro ritrovarci come individui e come collettività'².

3. Uno sguardo empirico sul caso di 'Noi, L'Aquila'

L'analisi della piattaforma, proposta nelle prossime pagine, è focalizzata sulla prima sezione della piattaforma 'Noi, L'Aquila' - 'Esplora e ricorda' – la sola ad essere stata popolata di contenuti creati dagli utenti³. L'obiettivo generale è quello di comprendere le pratiche e gli 'effetti' dell'interazione utente-piattaforma, mettendo al centro la narrazione come strumento di costruzione e appropriazione di questo spazio digitale. I frammenti biografici digitalizzati divengono precipitato del reciproco adattamento: del ricordo rispetto allo spazio digitale e alla sua architettura, e della piattaforma rispetto al principale scopo di ricostruzione dello spazio attraverso memorie condivise. A differenza di molti altri ambienti interattivi, infatti, 'Noi, L'Aquila' pone al centro il luogo, rappresentato attraverso la mappa nella sua distribuzione fisica e ricostruito narrativamente dai ricordi dei testimoni diretti.

Al fine di rispondere al meglio al nostro obiettivo ci siamo soffermati su:

2 <http://googleitalia.blogspot.it/2011/06/noi-laquila-ricostruire-il-futuro-senza.html>

3 La sezione 'Ispira il futuro', potenzialmente molto interessante in ottica STS, quando è stata condotta la ricerca conteneva esclusivamente un insieme di istruzioni e video-tutorial atti ad illustrare come utilizzare al meglio i software di modellazione 3D (Google Building Maker e Google SketchUp). Non è stato pertanto possibile visualizzare e analizzare i modelli proposti dagli utenti della piattaforma.

- Gli elementi 'locativi' della memoria, per comprendere quanto la distribuzione dei ricordi potesse restituire una mappa topografica della memoria della città;
- Le caratteristiche narrative dei frammenti condivisi attraverso la piattaforma;
- La relazione con il passato, ovvero il ruolo della dimensione temporale all'interno della narrazione e nella condivisione dei processi di costruzione della memoria collettiva.

L'analisi ha riguardato tutti i post (N=278) pubblicati a partire da giugno 2011, mese del lancio dell'iniziativa, fino a fine novembre 2011. Abbiamo adottato un approccio integrato, conducendo in prima istanza una lettura di tipo quantitativo e, successivamente, un'analisi qualitativa di stampo narrativo (Corbetta, 2003; Silverman, 2011; Marvasti, 2004). Tale approccio metodologico consente di 'semplificare e ridurre una grande massa di dati in segmenti organizzati' (Marvasti, 2004, p. 91). Per quanto riguarda l'analisi quantitativa, abbiamo costruito una griglia di codifica centrata sulla categorizzazione dello spazio (pubblico vs privato) e del luogo secondo precise categorie (case/chiese/strade/piazze, etc.). Tale operazione ci ha consentito di effettuare una misurazione della frequenza dei ricordi relativi ad un determinato luogo e di capire così su che tipo di spazi gli utenti hanno preferito concentrare il proprio ricordo.

L'indagine qualitativa, invece, ha permesso di soffermarci sulle caratteristiche narrative dei post e di identificare la loro relazione con il passato.

Occorre specificare che il materiale a nostra disposizione era particolarmente eterogeneo, includendo stralci di testo corposi, ricchi sul piano del contenuto e su quello emotivo, con una forte vocazione autobiografica e testi ri-mediati da altri ambienti, privi di un taglio personale, ma comunque utili a restituire la descrizione di alcuni dei luoghi socio-antropologicamente rilevanti.

Le considerazioni che seguiranno, dunque, sono il frutto di una riflessione sintetica che, sia pure tesa a semplificare la varietà e la complessità del corpus di dati, cerca al contempo di fornire un modello interpretativo volto a spiegare e immaginare i possibili percorsi di appropriazione della piattaforma digitale.

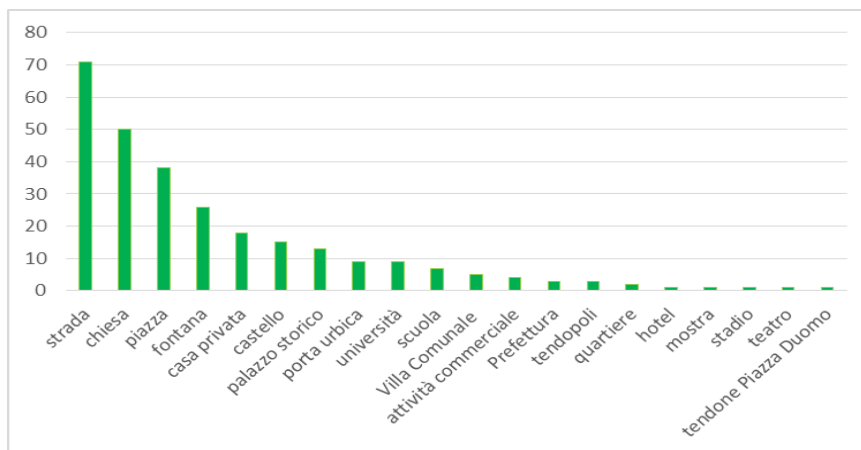
4. Principali risultati

La tabella sottostante (tab. 1) mostra le distribuzioni di frequenza relativa alla locazione dei ricordi sulla piattaforma di ‘Noi, L’Aquila’. Una prima lettura mette in luce il prevalere di spazi pubblici, parte della memoria storica della città, sottolineando la vocazione ‘collettiva’ e comunitaria dell’iniziativa lanciata da Google.

Sono un esempio le percentuali relative a luoghi come le chiese, i palazzi pubblici e le fontane della città.

Allo stesso tempo però, è riscontrabile una percentuale significativa di post dedicati alla casa e, se mettiamo in relazione questo dato con la numerosità di testi dedicati alle strade – spesso citate come luoghi propri o in riferimento al proprio domicilio – è evidente che ha un ampio spazio anche la narrazione di contesti ritenuti più personali e radicati alla propria identità.

Tabella 1 Distribuzioni di frequenza relativa alla locazione dei ricordi sulla piattaforma di ‘Noi, L’Aquila’.



Scarsamente indicizzati sono i luoghi legati al post-sisma, come le tendopoli, quasi a marcare il valore rimemorativo della piattaforma, la cui finalità è appunto quella di offrire uno spazio per la ricostruzione della memoria della città. A nostro avviso, questa assenza può essere interpretata alla luce dei principali studi dedicati alla pratica narrativa a seguito di un trauma (Rimè, 2008) che dimostrano come un vissuto particolarmente lacerante causa spesso una contrattura nell’espressione narrativa. In fondo,

come suggeriscono diversi autori (Jedlowski, 2009; Demetrio, 2009), il processo del racconto 'obbliga' il narrante a sottostare alle logiche lineari del testo e al contempo a oggettivare quello che è un vissuto, nel caso del trauma, spesso confuso, complesso, carico di emozioni contrastanti.

La categorizzazione dei luoghi rappresentata in tab. 1 riporta in termini quantitativi il numero di post legati a ciascun punto della mappa. Occorre però precisare che, proprio in virtù della ricchezza narrativa di alcuni contributi, un singolo frammento poteva contenere diversi riferimenti locativi, mettendo in luce una forte dinamicità topografica dei ricordi connessi a L'Aquila. Ecco che dunque a partire dai vissuti legati a una strada, l'autore del post racconta il percorso per raggiungere la scuola, condiviso con amici e compagni, per arrivare a parlare della sua casa o di altri luoghi significativi della città. Questa profondità narrativa che caratterizza la maggior parte dei frammenti ci ha spinti ad accostare a una 'lettura distante' una 'lettura ravvicinata' (Burdick et al., 2012).

Il lavoro di analisi narrativa, più approfondito, ci ha permesso di classificare i post secondo alcune tipologie, la cui individuazione è legata sostanzialmente a tre driver concettuali:

1. Il tempo del racconto, ovvero la collocazione sull'asse temporale degli accadimenti riportati nel post. Ci è parso rilevante individuare una temporalità della narrazione collocabile su un immaginario *continuum* che va dal passato, il tempo per molti user dell'infanzia e dell'adolescenza, al presente;
2. Il soggetto della memoria. I post presentano sostanzialmente due tipi di centratura narrativa: sull'*io* del narratore o sul *noi*, di volta in volta associabile a diversi protagonisti;
3. Il carattere locativo della memoria, ovvero le caratteristiche dello spazio associato alla memoria secondo le comuni categorie sociologiche (pubblico vs privato).

A partire da questi ordinatori dello sguardo, abbiamo individuato quattro differenti tipologie di post: il vissuto personale; il vissuto condiviso; la denuncia; la ricostruzione storica. Si tratta di categorie idealtipiche non sempre capaci di restituire la ricchezza e la complessità narrativa dei frammenti analizzati.

Il vissuto personale include i post in cui il soggetto della narrazione è l'autore del post. Vi è una forte centratura sull'*IO* e un legame con quegli spazi considerati privati marcati solitamente dall'uso di possessivi come 'la mia casa', 'la mia strada'. Alcuni luoghi condivisi come la scuola, il quartiere

o il bar più frequentato subiscono in questo tipo di narrazione un processo di ri-territorializzazione biografica.

La mia Piazzetta, la mia parrocchia, la mia vita nell'adolescenza...in questa chiesa mi sono battezzato nel 1981, mi sono fatto la prima comunione nel 1991 e la cresima nel 1996...quante volte ho giocato a pallone in quella piazzetta... (autore: Cancer3.10 | luogo: Chiesa di Santa Maria Paganica | data del post: 21/07/2011)

Dimensione più complessa è quella temporale. Nel vissuto personale prevale certamente lo schiacciamento sul passato ma non sempre allo stesso modo. Abbiamo infatti distinto un vissuto personale cristallizzato, in cui il ricordo sembra rimanere limpido e focalizzato su un tempo antecedente, in genere particolarmente passato, e un vissuto personale prospettico in cui invece la narrazione si evolve fino a toccare il presente con un rimando esplicito alla situazione attuale.

Il mio primo bacio con Francesca, il mio primo amore della mia vita. La colonna sonora di quel ricordo era Franco Battiato ed il suo centro di gravità permanente. A quel tempo ancora nessuno lo aveva trovato, ma in compenso c'era l'attesa ed i progetti del futuro. Oggi a 50 anni di distanza, allora ne avevo appena 16, la scalinata è ancora lì, io ho preso una strada nella vita e Francesca anche. Da quella estate, non ci siamo più incontrati. Ma il ricordo che rimane è sempre bellissimo. (autore: valmarco62 | luogo: Basilica di San Bernardino | data del post: 15/06/2011)

In alcuni casi, infine, il vissuto personale è celato dietro una narrazione che sul piano enunciativo appare impersonale e contratta, ma dietro cui è visibile, soprattutto attraverso i toni valutativi utilizzati, la presenza del soggetto e il legame con il posto, quasi a sottintendere una memoria che rimane strettamente personale e dunque non condivisibile:

Bel posticino (autore: elena.barnabba | luogo: Convitto nazionale | data del post: 02/09/2011)

Il vissuto condiviso è invece quel tipo di narrazione in cui prevale il noi, la connotazione fortemente passata della memoria, e il richiamo a luoghi se non proprio di tutti, di molti. In realtà questo riferimento al collettivo, attraverso il pronome plurale, assume sfumature differenti. In alcuni casi, include la cerchia di soggetti più vicini all'autore del post: gli amici del

quartiere, gli altri membri della famiglia, etc. In altri, è chiaro il riferimento a categorie sociali di persone, come ad esempio i molti rimandi nei post al 'popolo studentesco'. In questi casi il *noi* è aleatorio: abbraccia le proprie conoscenze più strette e anche tutti quegli sguardi anonimi che, per il fatto di condividere un luogo o un'esperienza, rientrano nella categoria indicata.

La dimora che ci ha ospitato per tutto il nostro viaggio universitario, fino al 6 aprile 2009. [...] Se quella casa potesse parlare, parlerebbe di noi, le ragazze di via chiassetto d'arischia che quella casa l'abbiamo vissuta al 100 per cento, di noi, che continuiamo a sentirci nonostante le distanze [...] (autore: scmia | luogo: Casa di Tolleranza | data del post: 24/06/2011)

Meno presenti, ma altrettanto significative sono le denunce, schiacciate sul presente e riferite a uno spazio pubblico, in cui al centro della narrazione vi è un *noi* impersonale. È marcato il senso di appartenenza all'identità collettiva e comunitaria, alla città nel suo tradursi in spazio e in storia. Sono spesso narrazioni brevi e amare, dense sul piano emotivo e il cui tono è marcato dall'uso di una punteggiatura 'forte' come i punti esclamativi e le virgolette.

Quel giorno la Piazza era VIVA col suo mercato, come le PERSONE che la frequentavano. Quando tornerà a VIVERE??? (autore: Islauta | luogo: Piazza Santa Lucia 3 | data del post: 23/06/2011)

Infine, vi sono le ricostruzioni storiche, ovvero narrazioni che hanno al centro L'Aquila in quanto città di origine medievale, con evidenti richiami al passato del territorio. Il loro carattere impersonale li rende descrittivi e riferiti a luoghi pubblici ritenuti di particolare interesse culturale. Anche questo tipo di contenuti ha una sua importanza nei processi di ricostruzione e preservazione della memoria condivisa della città. Utilizzando Namer (1996) potremmo parlare in questo caso di una 'memoria di conferma', una memoria che supporta una storia della città già testata e approvata, offrendo un nuovo contesto, digitale per l'appunto, per la sua condivisione e conservazione.

Le pratiche narrative messe in atto dai vari utenti possiedono però dei tratti comuni. Tutte, infatti, possono essere viste come forme emergenti di un modo possibile di affrontare l'elaborazione del trauma legato al terremoto che, avendo messo in crisi, in modo brutale ed improvviso, punti di riferimento spaziali e fisici, trova nella piattaforma di Google una sua trasposizione virtuale.

Dalle organizzazioni cognitive si passa a strutture informatiche e architettrurali esterne al soggetto, volte a integrare, arricchire e, soprattutto, amplificare il compito svolto dall'ippocampo (Kumara e Maguire, 2005).

Facendo riferimento agli ordinatori concettuali indicati poco sopra, abbiamo provato a definire gli aspetti generali di un modello interpretativo delle tipologie di memorie emergenti dalle pratiche narrative messe in atto sulla piattaforma di Google. Infatti, incrociando il soggetto della narrazione con le caratteristiche locative della memoria si vengono a formare quattro quadranti su cui abbiamo posizionato le categorie di post individuate (figura 2).

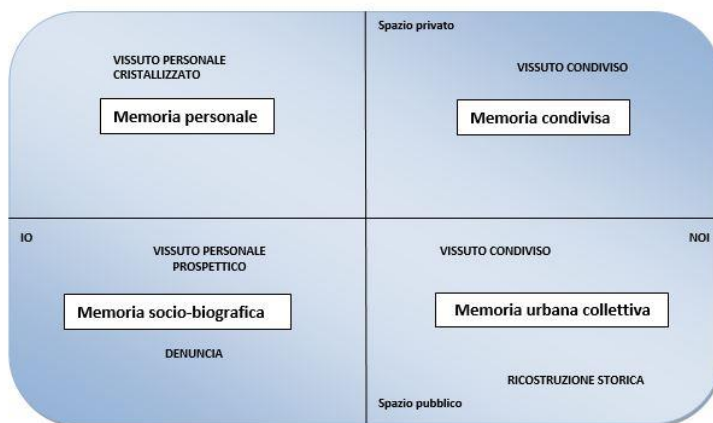


Figura 2 Le tipologie di memorie nel progetto Noi L'Aquila.

In alto a sinistra possiamo collocare tutte quelle narrazioni che intercettano la **memoria personale** del soggetto. Sono stralci biografici con un contenuto altamente emotivo che raccontano L'Aquila attraverso vissuti della gente, punto di incontro tra Storia della città e storia personale/famigliare.

Via Roio 17-21... il MaiUguale... il sangue e il sudore dei nostri ultimi anni... troppo pochi per veder nascere soddisfazioni a lungo termine. con fatica ci siamo reinventate [...] possibile che il sacrificio non venga mai ricompensato in egual misura? (autore: Francescaviola84 | luogo: Via Sassa | data del post: 05/07/2011)

In basso a sinistra troviamo le narrazioni che pur mantenendo il focus sul sé presentano una contestualizzazione in spazi pubblici, di tutti e per tutti. È la voce della gente che racconta di sé, descrivendo L'Aquila come il contesto di vissuti importanti per la propria storia. Possiamo definire questo tipo di memoria *socio-biografica* proprio perché in genere il racconto riporta momenti che fanno parte della vita sociale, come l'andare a scuola, il frequentare gli scout, o vissuti affini.

Io e mia sorella ci passavamo la maggior parte del nostro tempo libero, insieme a pochi amici che abitavano lì intorno [...] Ho passato tutta la mia vita in quel quartiere e ancora adesso ce l'ho nel CUORE !!! (autore: Gloria Marinelli | luogo: Chiesa di San Pietro di Coppito | data del post: 09/06/2011)

In alto a destra vi sono quei post ambientati in spazi privati ma che sembrano riportare le vicende comuni a più persone. È il caso del ricordo accorato di 'noi migranti' o di 'noi studenti fuori sede', 'noi della via xxx'. Tutte storie che sono ambientate in luoghi specifici, in genere, strade, vie e case, verso cui quel meccanismo semantico di demarcazione descritto poco sopra è particolarmente forte. L'appropriazione possessiva dello spazio condiviso, o meglio il bisogno di esplicitarlo narrativamente, interviene sulle espressioni utilizzate. In questo modo i percorsi pedonali diventano 'la nostra strada', le abitazioni 'il nostro condominio', e così via. Abbiamo definito questo tipo di memoria *condivisa* perché, pur mantenendo toni personali, intercetta altre storie senza divenire per questo collettiva o pubblica.

Casa Tartari, 5 anni di università, centinaia di amici, serate indimenticabili episodi unici, a volte paradossali, giornate sempre incredibili. Gli anni più belli che uno studente abbia potuto vivere durante la sua carriera universitaria (autore: simone.goingo | luogo: Casa Tartari | data del post: 12/07/2011)

Infine, il quadrante in basso a destra include i post che hanno per soggetto il *noi* e che sono riferibili allo spazio pubblico. Sono parte di questo quadrante gli esempi già citati di ricostruzioni storiche, ma anche alcuni vissuti riferiti a pratiche comuni, che appartengono alla 'gente dell'Aquila'.

Si ricostruisce attraverso il racconto dunque, una memoria urbana collettiva, la memoria della città e dei suoi abitanti.

5. Conclusioni

A livello generale l'analisi dei contenuti presenti all'interno della piattaforma 'Noi, L'Aquila' ha mostrato come oggi i media digitali e, in particolare, le piattaforme social, giochino un ruolo importante non solo nella condivisione dei vissuti quotidiani in situazioni ordinarie, ma anche nella narrazione e socializzazione delle esperienze traumatiche in condizioni extra-ordinarie, confermando così quanto già emerso da studi precedenti (Farinosi e Micalizzi, 2013; Farinosi e Treré, 2014). Realtà materiale e realtà digitale si co-costruiscono dialetticamente l'un l'altra, dando vita a quella che possiamo definire come 'società aumentata' (Jurgenson, 2012).

Indagando l'interconnessione esistente tra narrazione e tecnologie, abbiamo potuto vedere come l'iniziativa promossa da Google dopo il terremoto abbia permesso di condividere e preservare principalmente quattro differenti tipologie di memoria: 1) memoria personale; 2) memoria socio-biografica; 3) memoria condivisa; 4) memoria urbana collettiva. È emerso inoltre il ruolo importante giocato nella conservazione della storia individuale e collettiva dell'Aquila, nella raccolta delle esperienze passate dei suoi cittadini, e nello sviluppo di pratiche di resilienza nella fase del post-terremoto. Prima di concludere occorre però soffermarci su alcune ulteriori considerazioni. Se, infatti, da un lato, il progetto di Google si è rivelato uno strumento innovativo per condividere e conservare i ricordi relativi a L'Aquila prima del sisma del 2009, dall'altro bisogna riconoscere che dal punto di vista quantitativo non è stato in grado di raccogliere e veicolare un gran numero di contenuti, sia testuali che visuali. Abbiamo interpretato questo limite in due modi:

1. Dato che la memoria è il risultato di un incessante processo di selezione condotto sulla base dei bisogni del presente, richiede un certo lasso di tempo prima di poter essere ordinata e organizzata. 'Noi, L'Aquila', dunque, è stato lanciato quando i tempi non erano ancora maturi e solo una piccola parte della popolazione si sentiva pronta a raccontare e condividere le proprie esperienze passate;
2. La piattaforma sviluppata da Google riflette un approccio 'top-down'. Pur presentando, per lo meno a livello strutturale, grandi potenzialità, si pone come uno strumento calato dall'alto che non riesce a coinvolgere pienamente la popolazione locale.

Futuri sviluppi della ricerca prevedono in prima istanza l'analisi dei contenuti visuali condivisi dagli utenti sulla piattaforma, e, successivamente,

in un'ottica comparativa, l'analisi di iniziative analoghe condotte in altre parti del mondo.

Riferimenti bibliografici

- Barton, A.H. (1970) *Communities in Disaster. A Sociological Analysis of Collective Stress Situations*. Garden City, NY: Doubleday & Co.
- boyd, d. (2007) *Why youth (heart) social network sites: the role of networked publics in teenage social life*. In Buckingham, D. (eds.), *Youth, Identity, and Digital Media*. Cambridge: MIT Press.
- Burdick, A., Drucker, J., Lunenfeld, P., Presner, T. e Schnapp, J. (2012) *Digital Humanities*. Cambridge: MIT Press.
- Cattarinussi, B. e Pelanda, C. (eds.) (1981) *Disastro e azione umana. Introduzione multidisciplinare allo studio del comportamento sociale in ambienti estremi*. Milano: FrancoAngeli.
- Corbetta, P. (2003) *Social Research: Theory, Methods and Techniques*. London: Sage.
- De Carli, L. (1997) *Internet, memoria e oblio*. Torino: Bollati Boringhieri.
- Demetrio, D. (2009) *Momenti e figure della scrittura di sé*. In Velastro, O.M. (eds.), *Scritture relazionali autopoietiche*. Roma: Aracne.
- Dynes, R.R., DeMarchi, B. e Pelanda, C. (eds.) (1987) *Sociology of disasters. Contribution of sociology to disaster research*. Milano: FrancoAngeli.
- Farinosi, M. e Micalizzi, A. (eds.) (2013) *NetQuake. Media Digitali e Disastri Naturali. Dieci ricerche empiriche sul ruolo della Rete nel terremoto dell'Aquila*. Milano: FrancoAngeli.
- Farinosi, M. e Treré, E. (2014) Challenging mainstream media, documenting real life and sharing with the community: An analysis of the motivations for producing citizen journalism in a post-disaster city. *Global Media and Communication*, 10 (1), 73-92.
- Ferron, M. (2013) *Wikimemories: la costruzione della memoria collettiva del terremoto dell'Aquila in Wikipedia*. In Farinosi, M. e Micalizzi, A. (eds.), *NetQuake. Media digitali e disastri naturali. Dieci ricerche empiriche sul ruolo della Rete nel terremoto dell'Aquila*. Milano: FrancoAngeli.
- Ferron, M. e Massa, P. (2011) *Collective memory building in Wikipedia: the case of North African uprisings*. Paper Presented at the Proceedings of the 7th International Symposium on Wikis and Open Collaboration, ACM, New York, USA.
- Frostig, K. (2014) *Making memory visible: memory about the holocaust and national socialism in Austria at the 75th anniversary of the Anschluss*. In Fawns, T. (eds.) *Memory and meaning*. Oxford: Interdisciplinary Press.

- Halbwachs, M. (1997) *I quadri sociali della memoria*. Napoli: Ipermedium.
- Jedlowski, P. (2009) *Il racconto come dimora*. Torino: Bollati Boringhieri.
- Jurgenson, N. (2012) When Atoms Meet Bits: Social Media, the Mobile Web and Augmented Revolution. *Future Internet*, 4 (1), 83-91.
- Kumara, D. e Maguire, E. (2005) The Human Hippocampus: Cognitive Maps or Relational Memory? *The Journal of Neuroscience*, 25 (31), 7254-7259.
- Marvasti, A. (2004) *Qualitative Research in Sociology*. London: Sage.
- Namer, G. (1996) *Memorie d'Europa: identità europea e memoria collettiva*. Soveria Mannelli: Rubettino.
- Quarantelli, E.L. (eds.) (1998) *What is a disaster?* London: Routledge.
- Rimè, R. (2008) *La partage des emotions*. Paris: Press Universitaires de France.
- Sciolla, L. (2005) *Memoria, identità e discorso pubblico*. In Rampazi, M.E and Tota, A. (eds.), *Il linguaggio del passato. Memoria collettiva, mass media e discorso pubblico*. Roma: Carocci.
- Silverman, D. (2011) *Interpreting Qualitative Data: A Guide to the Principles of Qualitative Research*. London: Sage.
- Zerubavel, E. (2003) *Time maps: collective memory and the social shape of the past*. Chicago: University of Chicago Press.

The game as social activator, between Design and Sociology: a multidisciplinary framework to analyse and improve the ludic experiences and their social impact.

Enrico GANDOLFI^{*a} and Ilaria MARIANI^b

^a Luiss 'Guido Carli' University of Rome; ^b Politecnico di Milano

This paper introduces a tool of a framework for the observation and analysis of play experiences (PEOF - Play Experience Observation Framework). PEOF consists of a multidisciplinary set of theoretical and empirical tools and guidelines between Sociology and Design that scholars, designers and researchers may use in order to comprehend and exploit the ludic dynamics in terms of meaningful experiences. It is mainly addressed to Persuasive Games and Games for Change, as communication systems for social innovation capable of generating experiences that stimulate a reflection on socio-cultural issues. Indeed, through the play activity, we can experience (and therefore understand) perspectives that are different from our usual ones.

Specifically, we describe the set of concepts of frames, patterns and scripts on the ground of the PEOF and in particular of the Evidence-Interpretation Matrix (EIM), a PEOF related research tool. EIM focuses on how the mentioned concepts can be empirically used to attest that a change is occurring by playing certain games. Through observation and interpretation of a playing activity, it aims to understand what happens when players are encouraged to open their mind to new ideas. The overall framework and related EIM tool have been tested and refined through several case studies developed at the School of Design, Politecnico di Milano, like the Persuasive Urban Game A Hostile World, here used as main example to explain and validate our suggestions.

Keywords: Social innovation; multidisciplinary framework; game design; player experience analysis; persuasive games

Introduction

The game is something we are all familiar with, but if we are asked to formally define what 'to play a game' means, we would be rather in a

* Corresponding author: Enrico Gandolfi | e-mail: egandolfi@luiss.it

quandary. This happens because play is a spontaneous activity, wherever and whenever diffused: it is part of us, as human beings. Albeit with forms and terms widely different, the ludic activity has the role and traits of a *real* social convention, deeply rooted in human traditions and instincts (Huizinga, 1938; Fink, 1957; Caillois, 1958). Thanks to the tools and languages that characterize its own nature, it has progressively spread: today an increasing number and variety of people play indeed to a growing amount of games.

Games that often are not designed with the sole purpose to entertain and elicit fun. On the contrary sometimes they aim to improve aspects of ordinary life, such as *Tiltfactor's Massively Multiplayer Urban Games: Soba, MuShu and Wancan*, which are a collection of team-based games designed by Flanagan and Looui in 2008 and focused on sharing different culture, food and language to increase collaboration and dialogue among people of different ethnicity; or *Superbetter*, designed by McGonigal in 2012 to help build personal resilience, the ability to stay strong, motivated and optimistic even in the face of difficult challenges with benefits on health, boosting both physical and emotional well-being

Frequently, a properly and wisely designed ludic artefact can appear as a *facilitator*: an involving system able to transfer knowledge, activate reflections, foster critical thinking, encourage collaboration with others, suggest a constructive competition that leads to increase problem-solving capacities (Flanagan, 2009; Gee, 2007). In this paper we especially focus on Persuasive Games (Bogost, 2007) (in the following PG) and Games for Change (in the following G4C) as artefacts precisely designed to interact with and influence certain social dynamics that take place in specific community, targets or contexts. The issues addressed can be various and varied in nature; generally they relate to perceived, emerging or situated problems and topics that are sensitive and, as a consequence, require to sensitise citizens by activating critical reflection and increasing awareness.

Today the ground is fertile for these games: mainly because of the theoretical and practical research, and its progressive crossbreeding with other disciplines, this branch of the ludic field is obtaining very interesting results. Never the less, even the growing number of players and ludic products has an important role: it led to change the very concept that associate the act of play to the typical ideas of childhood or waste of time (Fink, 1957, p. 12).

Therefore, the game has significant potentials, in terms of communication and transmission of socio-cultural practices (Flanagan,

2009): it is the reason why we investigate games – PGs and G4Cs in particular – and why we consider their analysis and research remarkable.

Especially, our intent is to enquire, through sociological and design tools, into how certain games, as communication systems for social innovation, are capable of generating experiences that stimulate a reflection on socio-cultural issues.

Those experiences can be observed and analyzed: to date, however, the methodologies and the theoretical and practical tools that allow this empirical analysis are neither consolidated nor defined among the scientific community. This is the reason why we feel the need to define a structured framework. The starting point is to understand how the immersion into ludic/fictional world encourages players to open their mind to new ideas. Hence our research question: Which elements identify that the ludic paradigm can sensitize and foster a change in perspective towards social innovation issues? Then we need a framework aimed at understanding the experience by providing guidelines useful to the designer in the first place and the researcher accordingly. A framework that takes into account both the different positions/roles that are synergically involved and mainly the original/complementary contribution these figures can give.

The designer and the sociologist can indeed work together in harmony with different benefits: their complementary and combined skills allow them to better observe and understand players' *meaningful play experiences*. This consideration is on the ground of the goal of our framework that aims to help the designer to understand and refine the mechanisms by which sensible concepts like identity, social change and civic engagement are translated into a ludic project and make the activity of playing *meaningful*.

In particular the purpose of the framework and the related tool we are proposing is to better comprehend how players interact with the ludic structure, considering also the role of the related socio-cultural background, and the resulting *play experience*. In such way, we are able to ponder the significant variables concerning how individuals experience a game and react to its traits and heats. Namely, we can observe and understand the players' *meaningful play experiences*. Specifically, we intend to achieve this purpose through a critical approach and a respectful attitude, aware of contexts and cultures that surround, influence – and are often influenced by – the game (Mayra, 2008). As every human practice, also the ludic one happens within a specific 'here and now'; a dimension that constantly affects players' behaviours through the dialogue that takes place within the *magic circle*, namely the set of tangible and imaginary boundaries that

defines the place wherein the play activity happens (Montola, Stenros and Waern, 2009; Salen and Zimmerman, 2004; Huizinga, 1938). Society and culture represent relevant factors to consider in judging play experiences, and precious resources that can be exploited by a *good* design. Thus, we propose a structured and replicable framework that arises from intertwining design consciousness and sociological attention to allow designers, scholars and researchers to go deep into the ludic experience analysis.

Hence, its utility is both in setting an aware play experience (from a design point of view) and in comprehending its dynamics as observers (through a humanistic lens).

Background knowledge

Ludic artefacts are too often designed without a complete knowledge and consciousness of their potential output in terms of experiences and meanings, of the experiential dynamics they raise in users, and of the available methods to analyse/design them neither. The study of games as objects rich of meaning is therefore a necessary condition to formally identify a conceptual framework to share with the scientific community, contributing to understand and apply the ludic communicative potential.

Research field and focus

An emerging but grounded perspective on games comes from the Game Studies: they investigate the variety of aspects that characterise the relation among human beings and the game itself; thus, as a matter of fact, they are a sort of crossroad between different fields and standards. They are a young discipline, born at the end of '900, wherein knowledge from a large set of backgrounds merges. As observed by Mayra (2008, p. 6), they are 'a multidisciplinary field of study and learning with games and related phenomena as its subject matter', wherein a number of methodologies and perspectives coexists. The game has indeed a pre-cultural and anthropological origin (Huizinga, 1938) and shows a meaning so much rich and multifaceted that a unique approach is neither adequate nor advantageous. Accordingly, the discipline is hybrid in its core, with contributions from Mathematics, Philosophy, Psychology, Sociology, Design and so on. The result is a rich and integrated landscape of suggestions, theories and research that contributes to characterize this scenario with a significant variety. Therefore, our specific goal is to merge sociological and

design attitudes coherently with this mixed tradition, enforcing the synergy between heterogeneous, alternative and complementary lenses.

Before defining the proposed tool of analysis, it is necessary to formally explicate the subject we deal with, especially how we intend to observe and investigate it. Hence, primarily, *what does it means to play?* Even if many classifications have been tempted in last decades, due to the *trans-nature* of such concepts, a complete and holistic definition remains a hard task to achieve. Among the various suggestions, Huizinga (1938, p. 13), argues that: ‘Summing up the formal characteristics of play we might call it a free activity standing quite consciously outside "ordinary" life [...], but at the same time absorbing the player intensely and utterly’. Almost seventy years later, Salen and Zimmerman (2004, p. 366) recovered and evolved the *magic circle* concept and propose a remarkable definition that efficaciously describes play as: ‘To play a game is to move into the magic circle, to move from the domain of everyday life into a special place of meaning’. In the light of that, we consider that the nodal center of the play activity is the experience the game generates into players (and in them lasts), and its distinguishing traits. It is an experience that becomes further significant and *meaningful* when we deal with PGs and G4Cs.

The concept of experience is constituted of a multiplicity of factors – psychological, emotional, cognitive, behavioral, just to mention a few – that makes it a phenomenon extremely articulated and faceted. As anticipated, the play activity may affect not only the game system itself, but also a broader reality and concrete aspects of the player's everyday life. Whereas each individual approaches the play activity with a set of individual knowledge that are original and unique, there is reason to stand that there isn't actually a common and generalized experience. Far from it, each game proves itself capable of causing a particular experience according to the specific player. Each of us is involved into the play activity in its own way, and as a consequence lives situations that can be defined as personal and original (Bertolo and Mariani, 2014). Hence, the experience emerges as something unique that strongly depends on the specific individual. It is indeed closely linked with the social and cultural baggage that outlines each of us, lying to the background of knowledge, habits and customs that identifies us as persons belonging to a society, with a specific culture.

To understand how the game can stimulate *meaningful experiences* that engender potential change and foster the player towards the adoption of new concepts and habits impacting the daily life in a social innovation perspective, we have to look at play as an activity that dives players into

other worlds. This allows a momentaneous detachment from the ordinary life and the roles we play everyday.

Our proposal stands indeed on a set of crucial ground concepts. (1) The first one is the so-called *magic circle* (Salen and Zimmerman, 2004), namely the space (physical as imaginative) set by games. It provides a sort of boundaries, a membrane (Goffman, 1971; Montola, Stenros and Waern, 2009), within which the player moves and acts according to a ludic perspective. Playing, we enter the 'circle', we (2) *immerse into the fictional world*: it is a reality set apart from the *ordinary* one that demands the player to trust and believe in the game world – just like a reader trusts his narrator and, when reading a story, is drawn into the narrative context. This immersion often stimulates and encourages the player to (3) *detach from her usual frames of reference* and momentarily adopt other frames (Bateson, 1956, 1972). The concept of immersion into a fictional world and the fact of being conscious of playing a 'safe experience' result in a state of (4) *openness towards changes of positions*. For example, we can think to the switch of frames of reference that happens each time we play a game that asks player to identify herself with someone else. Playing, our *mental and behavioural schemata* are indeed filtered, problematized and made relative (Goffman, 1974; Consalvo, 2009). In the ludic protected space, player can experiment and live representations that are *reductions* with significant communicative potentials (Baudrillard, 1979). Indeed, the game forces us to think and react in a way that differs from the ordinary. As we will, see each of these concepts plays an important role in the proposed framework and its tools: they are the elements that allow the designer and the observer/researcher to understand if a change occurred.

Methodology and tool of analysis

We propose a multidisciplinary view, enforced by several case studies (developed with the supervision of Maresa Bertolo and Ilaria Mariani at the School of Design, Politecnico di Milano). The Play Experience Observation Framework (PEOF) is an integrated framework dedicated to whom design and research, permitting the collection, analysis and 'mapping' of the 'experiential cornerstones' on which the gameplay is based. Then, the matrix we propose allows a particular observation and study of the steps and elements that identify that a certain change is actually occurring. This is a central step to rule and enhance the gameplay dynamics comprehension

and – above all – understand if a social meaning is transferred to players thanks to the ludic activity attended.

Games can be activators of behaviours and attitudes, working as remarkable social innovation tools. To understand what kind of behaviour and change PGs and G4Cs can activate, it is fundamental to observe how the immersion into ludic/fictional world encourages players to open their mind to new ideas and perspectives. The PEOF is based on this concept and it is composed of a set of multidisciplinary tools, which can be useful, operational, formalized and adaptable into different contexts and to different projects of study.

Here we present a tool of our framework (PEOF), the *Evidence-Interpretation Matrix (EIM)*, and, in the following paragraph, its application to a case study. This matrix intends to help researchers and designers to increase their awareness of what happens during the gameplay. It is based on a user centric approach and, from a theoretical and design perspective, it should be a matter of interest for whom is using the game as an activator of good practices for social innovation.

Play Experience Observation Framework

The PEOF proposes a set of elements to analyse and observe the changes that PGs and G4Cs can stimulate. It is composed of well-established concepts from different fields of studies, as Sociology and Design, with a strong record of applications and validations. These multidisciplinary concepts are *frames of reference* (Goffman, 1974; Sclavi, 2003), *patterns* (Alexander, 1979) and *scripts* (Abelson and Schank, 1977). Together, they represent the bricks of the human action and, as theoretical drivers, they bring to light how individuals think and act in everyday life. Due to this basilar dimension, we intend to translate and apply them to the ludic instance, and to PGs and G4Cs in particular, in order to provide the resulting tool to other scholars across disciplines and perspectives. These concepts can indeed be useful to outline the individual's play experience and the conditions that foster the adoption of specific point of views and therefore suggest a condition of openness of mind towards change.

As human beings we have absorbed and interiorised a social legacy that is the result of a system of thoughts and choices passed down over the years. This heritage manifests itself not only in our own way of thinking, feeling and believing, but also in our actions and reactions. Thus, as indicators of the ludic experience that each player lives, we include in the

PEOF the following concepts (from the interpretation of the situation to the different behaviours actually adopted):

Frames of reference: as argued by Goffman (1974) and Sclavi (2003), they are the overall definition of the situation itself, what we suppose is happening 'here and now' around us. According to such lecture, we activate peculiar behaviours and habits that are pertinent in that specific frame. For example, institutional places and moments are able to evoke glaring systems of references, think about the particular meaning we give to a raised fist when we are playing at *rock-paper-scissors*; the same gesture, in almost any other circumstance, would rather be read as an indicator of threat (Bertolo and Mariani, 2014, p. 9).

Patterns: working connections between situations, approaches and actions that people keep in mind in order to overcome the social interaction. 'As an element in the world, each pattern is a relationship between a certain context, a certain system of forces which occurs repeatedly in that context, and a certain spatial configuration which allows these forces to resolve themselves. As an element of language, a pattern is an instruction, which shows how this spatial configuration can be used, over and over again, to resolve the given system of forces, wherever the context makes it relevant' (Alexander, 1979, p. 247). They can be developed personally and in group, anyway a significant role is played by the 'accounts': assertions and patterns diffused and taken for granted in a socio-cultural context (Garfinkel, 1964). They could be interpreted as rules and tips that usually are efficient in everyday life or in special conditions. For example, people know that in the hospital frame a man in white coat is probably a doctor and can be consulted concerning medical issues, even if only in opportune moments; however, a man in white coat in a bakery is presumably the cook responsible of the bread in sale and not a doctor.

Scripts: sequences of actions activated by the individual in order to succeed in the social situation that he/she is experiencing (Abelson and Schank, 1977). They represent the observable dimension of the play activity, however they are also within our cognitive system as standard procedures of action, with a high grade of repeatability. For example, people are usually driven by behavioural routines in everyday activities like having breakfast (e.g., first I drink my coffee, then I read the newspaper and finally I eat biscuits) or going to the

post-office (e.g., first I take the turn number, then I sit down waiting for the call, finally I do my operations at the counter).

The point is to ground and connect these concepts in action: together, frames, patterns and scripts follow a logical and temporal progression. First (figure 1a), the player tries to understand in which social situation she is and, if she comprehends that her initial interpretation is wrong, she must adjust her perspective. Second, according to the frame activated, she adopts respondent patterns (figure 1b) and exploits adequate accounts; obviously, if she evolves her lecture of the situation, patterns also change. Finally and following the right patterns, she starts coherent scripts of actions (figure 1c). Throughout games it often happens that ordinary acquires new and unexpected features, urging players to face unfamiliar and unsettling situations.

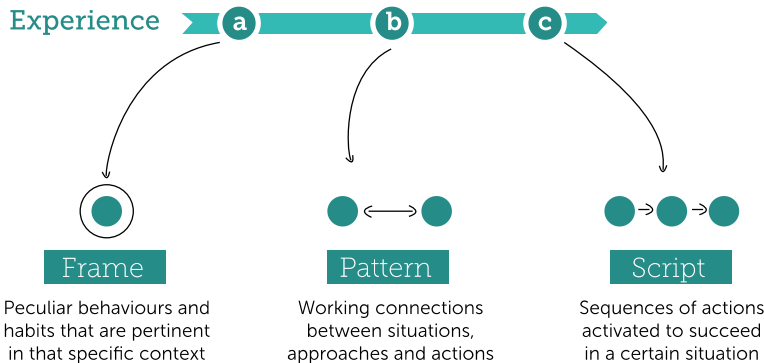


Figure 1 Frames, patterns and scripts are concept that arise during an experience. They are on the ground of the PEOF in general, and of the structure of the EIM in particular.

Usually people adopt ordinary set of frames, patterns and scripts that can be outlined as a circle: it is the iterative process that represent an ordinary experience (figure 2a). However, people can adapt to the experiences in a dynamic way, in a sort of 'trial and error' process, switching from the original iterative process to a new one (figure 2b). The game and the switch it implies can be remarkable. Indeed, during the ludic moment, the new dimension reached by the player may require approaches different from our standards with the aim to succeed. PGs and G4Cs can be meaningful social activators: they can suggest new perspectives and points of view. As designers and sociologist, however, we need a set of concepts

that helps us to analyse the experience a game can generate and to understand its potential social impact in terms of possible good practices and reflections.

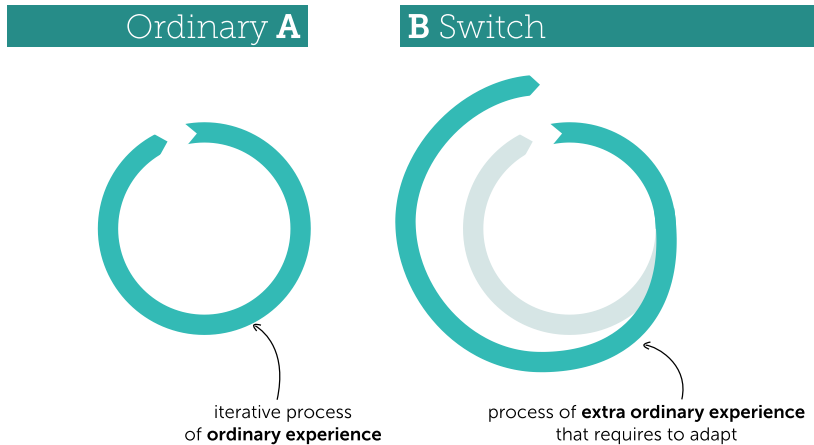


Figure 2 The iterative process of the ordinary experience (a). The process of the experience that requires to adapt (b).

The Evidence-Interpretation Matrix (EIM)

In order to understand the progression from ordinary to "extra-ordinary" (figure 2) from a tangible and observable point of view, we introduce the first tool of the PEOF, the EIM. It is based on three different levels of knowledge through which we can categorize frames, patterns and scripts occurring during the play activity. These levels concern specific domains in terms of knowledge, habits and schemata:

First level – Ordinary domain: frames, patterns and scripts connected to the everyday life and the core culture (Crane, 1992); a sort of *default* background we can follow, often in an unconscious way.

Second level – Gaming domain: frames, patterns and scripts that belong to our personal gaming tradition. It depends on personal ludic habits and consumptions, and it is influenced by opinions and prejudices about games themselves. Who plays automatically bring his/her ludic expertise: it could be described as a baggage of information and habits that stems from previous play experiences; it is similar to a default background players activate when they deal with specific artefacts (for example, if the player loves wargames he/she shows a

strong 'capital' in terms of rules, ability and predisposition when he/she begins a new one).

Third level – Breaking domain: frames, patterns and scripts that surprise us due to their newness, being in a certain way creative and responsive. They drive us to modify our assertions, beliefs and behaviours. Sometimes these perspectives are totally created *ad hoc*, sometimes the innovation is due to a translation of external patterns/scripts to new frames (in our case the one evoked by the ludic session).

Starting a game, the player uses both the first (Ordinary Domain) and the second level (Gaming Domain) as main sources to understand and interpret the ongoing game experience. Anyway, she can rapidly discover that these levels simply do not work. Thus, she should try to construct or rescue (from unexpected frames of reference) different ways of thinking and act in order to overcome the game challenges. According to this consideration, we have to comprehend the socio-cultural and gaming background of the player (defined as first and second levels: Ordinary and Gaming Domains) in order both to satisfy her expectations or, instead, to suggest alternative lenses (enabling a third level: Breaking Domain).

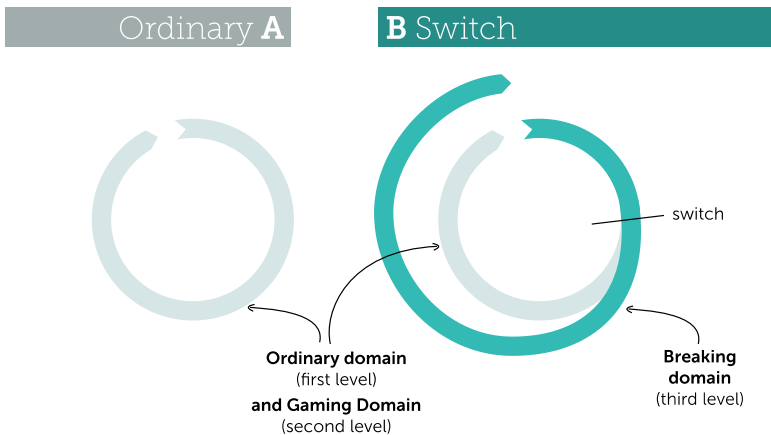


Figure 3 The Breaking Domain and the switch it provokes: when a Breaking situation happens, the usual iterative process of both the ordinary and gaming experience (grey path) can't work anymore. A change occurs and provokes a switch (turquoise path).

Now we propose to put ourselves in the shoes of the researcher who analyses an experience: she will deal with and ponder over a complexity of elements and aspects. Such a richness of variables can cause the so-called ‘analytic paralysis’, in a word the situation in which the observer remains stuck due to the potential variety of things to consider. This condition can often represent a halt, preventing the researcher from moving from the act of thinking to the act of doing.

However, adopting PEOF and EIM it is possible to lessen this kind of disorientation. Following its cornerstones, we are able to reason about the dynamic key elements within the ludic experience, from both an observer point of view (external, as said before: the designer and the scholar/researcher) and a player one (internal). PEOF helps us to answer two fundamental questions: How can we look at the play experience and understand if it is supporting a possible change? In which of the proposed terms (frames, patterns, scripts) can the game affect our ordinary way of thinking? Fundamental questions that need systematic answers and clear processes of investigation as the ones offered by our EIM tool.

Application

PEOF and EIM have been developed both theoretically and on the ground, observing several PGs and G4Cs sessions. Specifically, even if the latter can be applied to about every type of game, it is particularly effective in understanding how particular games can influence our perspective, allowing us to problematize and make relative our assertions.

EIM tool applied to case studies

We are actually applying and testing the EIM to games developed at the School of Design, Politecnico di Milano under the supervision of Maresa Bertolo and Ilaria Mariani. We are especially analysing projects designed to be performed in the urban spaces to reduce the technological mediation between players and the game space: a physical and concrete immersion into the game space can indeed lead to a more significant and meaningful experience. We are interested in analysing game experiences that can create meaning and introduce benefits in players’ lives and everyday activities; for example, encouraging dialogue, mutual understanding and empathy towards others (McGonigal, 2011; Bogost, 2007; Bertolo and Mariani, 2014). Playing, a process of social change can be indeed activated, enforced by the

acquisition of new points of view that, as written above, emerge through a change of frames, patterns and scripts.

Among the case studies we used to test and perfect the framework, *A Hostile World* (Bertolo and Mariani in Ruggiero, 2014) is exemplar in the change of perspective implied and in the manner in which the framework is able to fix the switch. This game was performed four times in the period of time between 2013 and 2014. After few playtest sessions to define its gameplay and mechanics (March 2013), the game was played twice in Politecnico di Milano, School of Design, university campus (June 2013 and June 2014), in the center of Modena city (March 2014) and in Bicocca university campus (March 2014). A total amount of 141 players, mainly Italians, attended the sessions: 38% male and 62% female; with different ages and level of education: 1% primary education, 6% secondary education, 41 % higher education, 46% graduate education and 5% PhD.

Briefly, this pervasive game consists of simple missions typical of everyday life (like rent a book at the library or buy a sandwich at the restaurant) to accomplish; however, the in-game language is the Esperanto, an idiom both unknown and familiar due to its mixed vocabulary. Thus, banal tasks become extremely hard because players have to interact with Actors, not playing supporting characters, whom speak and answer in Esperanto, pretending not to understand Italian, English nor other languages: therefore this is a significant linguistic barrier that players have to face and overcome. The situations experienced are connected with the immigrants' critical situation, in order to increase empathy and comprehension.

But, how can designers and researchers be sure that this game is actually affecting players and their attitude toward immigrants/foreigner? In figure 4 we present the EIM tool applied to *A Hostile World* case study through a shadowing observation method (McDonald, 2005; Laurel, 2003; Cross, 2006) on different players and playing groups during the four ludic experiences.

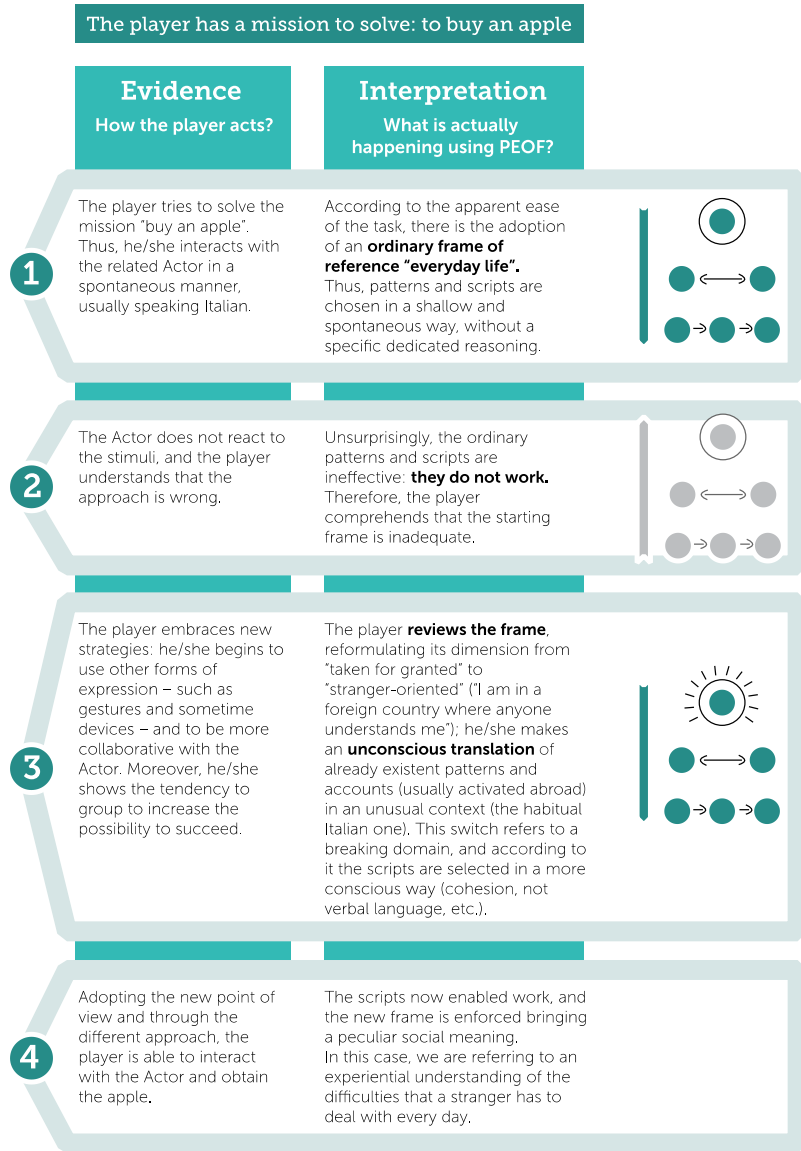


Figure 4 The Evidence-Interpretation Matrix applied to the mission 'buy an apple' of A Hostile World case study.

Adopting the EIM, designers and researchers were able to observe and compare what happened in ordinary situations (A circle), and what happened when a certainty is not respected (B circle), asking for a review of our approach to that specific situation. During the observation, it was noticed that players were firstly activating the frame 'everyday life', interacting with actors in a superficial manner (often speaking in Italian) due to the simplicity of the missions (1). Anyway, the patterns activated and the related scripts did not work: Actors did not respond to the (Italian in our case) stimuli proposed (2). Therefore, players considered again the frame, reformulating its dimension from 'taken for granted' to 'stranger-oriented' ('I am in a foreign country where anyone understands me'), and, as a consequence, patterns were chosen in a more conscious way according to different accounts: people began to use other forms of expression (e.g., gestures and sometime devices) and appear more collaborative with Actors.

Moreover, they showed the tendency to group to increase their possibility to succeed (3). In the end, the scripts enabled were working, and the new frame was enforced bringing a peculiar social meaning (4). In this case, we were referring to an experiential understanding of the difficulties that a stranger has to deal with every day.

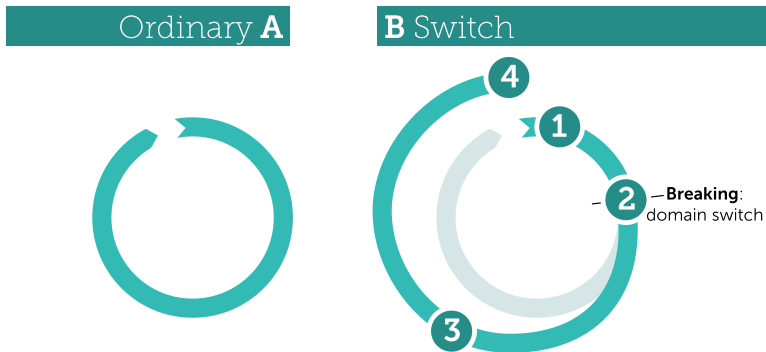


Figure 5 The iterative process we meet when we encounter an ordinary experience (A). The process of the experience that a Persuasive Game or Game for Change can provoke, with enlightened the switch from Ordinary/Gaming to Breaking Domain (B).

In the end, the ordinary domain makes way for a breaking one, where frames, patterns and scripts are translated from another situation (characteristic when we are abroad without knowing the local language) in a

new context (how difficult is living in our country for a stranger). Moreover, the gaming domain can influence the player behaviour if she is skilled in this kind of games (for example she should be more confident in moving and acting in public spaces).

Discussion

The EIM has been tested, as described above, in several PGs and G4Cs case studies aiming to encourage players to experience (and therefore understand) roles that are different from their usual ones, and therefore to increase consciousness and sensitise them to the community's everyday dynamics. The EIM application has shown that the tool is a valuable support not only to systematically observe the play experience, but it also facilitates a detailed study and analysis of each moment of 'change' that occurs by guiding the observation of the game session and, as a consequence, the evaluation of the game experience itself. This awareness can help the designer in setting the gaming experience in a more conscious way.

Our point, in short, is to provide the observer with a structured tool (EIM) that allows to look at the ludic session and take note of the situations that characterise the play experience of games dealing with socio-cultural issues. In particular, focusing on the players, the EIM facilitates to understand when the 'switch' that is on the ground of a possible change of perspective happens. This observations becomes of clear evidence for the designer who has to understand if the PG or G4C's mechanics are efficiently working and suggesting a reflection on player's habits and behaviours; and for the researcher – if the researcher does not correspond to the designer – who has to review, reflect on and reason about what actually happened during the game, in order to study the experience and eventually discuss for changes and improvements with the designer.

According to the PEOF and due to its potential, we are developing further tools connected to quantitative (e.g., surveys and questionnaires) and qualitative methods (e.g., single and group interviews) in order to enrich this perspective.

References

Abelson, R. and Schank, R. (1977) *Scripts, plans, goals, and understanding*. Hillsdale: Earlbaum Assoc.

- Alexander, C. (1979) *The Timeless Way of Building*. New York: Oxford University Press.
- Baudrillard, J. (1979) *De la séduction*. Paris: Galilée
- Bateson, G. (1956) *The Message 'This is Play'*. New York: Josiah Macy Jr. Foundation.
- Bateson, G. (1972) *Steps to an Ecology of Mind*. New York: Ballantine Books.
- Bertolo, M. and Mariani, I. (2014) *Game Design. Gioco e giocare tra teoria e progetto*. Milano: Pearson.
- Bertolo, M. and Mariani, I. (2014) A Hostile World. A Pervasive Urban Game to Sensitise and Foster a Cross-Cultural Reflection. In Ruggiero, D. (eds.) *Cases on the Societal Effects of Persuasive Games*. Hershey: IGI Global.
- Bogost, I. (2007) *Persuasive Games: The Expressive Power of Videogames*. Cambridge: MIT Press.
- Caillois, R. (2000 – ed. or. 1958) *I Giochi e Gli Uomini*. Milano: Bompiani.
- Consalvo, M. (2007) *Cheating: gaining advantage in videogames*. Cambridge: MIT Press.
- Consalvo, M. (2009) There is no magic circle. *Games and Culture*, 4 (4), 408-417.
- Crane, D. (1992) *The Production of Culture*. London: Sage.
- Cross, N. (2006) *Designerly ways of knowing*. London: Springer.
- Fink, E. (2008 – ed. or. 1957) *L'Oasi Del Gioco*. Milano: Raffaello Cortina.
- Flanagan, M. (2009) *Critical Play*. Cambridge: MIT Press.
- Garfinkel, H. (1964) Studies of the routine grounds of everyday activities. *Social Problems*, 11 (3), 225-250.
- Gee, J.P. (2007) *What Video Games have to Teach Us about Learning and Literacy*. New York: Palgrave Macmillan.
- Giddens, A. (1984) *The Constitution of Society*. Cambridge: Polity Press.
- Goffman, E. (2003 – ed. or. 1961) *Espressione e identità*. Bologna: Il Mulino.
- Goffman, E. (1974) *Frame analysis: An essay on the organization of experience*. Boston: Northeastern University Press.
- Huizinga, J. (1972 – ed. or. 1938) *Homo Ludens*. Torino: Einaudi.
- Laurel, B. (2003) *Design research: Methods and perspectives*. Cambridge: MIT Press.
- Mayra, F. (2008) *An Introduction to Game Studies*. London: Sage.
- McDonald, S. (2005) Studying actions in context: a qualitative shadowing method for organizational research. *Qualitative Research*, 4 (5), 455-477.
- McGonigal, J. (2011) *Reality is Broken*. New York: Penguin Press.
- Montola, M., Stenros, J. and Waern, A. (2009) *Pervasive Games: Theory and Design*. Burlington: Morgan Kaufmann.

ENRICO GANDOLFI, ILARIA MARIANI

Salen, K. and Zimmerman, E. (2004) *Rules of Play: Game Design Fundamentals*. Cambridge: MIT Press.

Sclavi, M. (2003) *Arte di ascoltare e mondi possibili*. Milano: Bruno Mondadori.

Silverman, D. (2013) *Doing Qualitative Research*. London: Sage.

Towards a transnational history of urban design

Michel GEERTSE*

Independent researcher

Urban design history increasingly is being perceived as a history of the circulation and migration of urban designers and design practices within comparative and global networks. So far studies on the internationalization of urban design between the world wars have been dominated by the Congrès Internationaux d'Architecture Moderne (CIAM). Recent studies demonstrate that the urban design discourse in the CIAM was informed by another transnational platform: the International Federation for Housing and Town Planning (IFHTP). These studies focus on the design concepts being discussed at an international level, not the ambiguous relations between the national and international dimensions of urban design culture. Recent historical studies on international expert networks in the field of technology and social sciences offer interesting leads to frame urban design history from a transnational perspective. This paper uses the IFHTP as a case study to explore the performance of transnational dialogue within international expert networks of planners and urban designers.

Keywords: Architectural history; planning history; transnationalism; IFHTP

Introduction

The architectural historiography on urban design usually focuses on individual designers within the dominating framework of the nation state, although in a globalizing world it is much more interesting to explore the networks in which urban designers and planners navigated to investigate how models, ideas and practices travelled (Smith, 2001; Nasr and Volait, 2003). Clément Orillard (2014) has demonstrated that in the first half of the twentieth century the internationalization of urban design was mainly structured around the constitution of the professional and academic discipline of planning. Within social economic history, especially the fields of

* Corresponding author: **Michel Geertse** | e-mail: ma.geertse@casema.nl

political history, cultural history and history of technology, planning history is increasingly framed as a history of the migration and circulation of planners and their ideas and experiences within transnational networks.

Pierre Yves Saunier and Shane Ewen refer to an international professional dialogue sustained by an 'Urban Internationale' which, although informed by 'worldwide understandings of technocratic expertise' (Ewen, 2008), represented a continuous struggle for the definition of 'the most appropriate objects, methods, tools and people to think about and act upon the city' (Saunier, 2001). Transnational experts navigated between universal values and the political and cultural requirements of nation states (Kohlrausch, Steffen and Wiederkehr, 2010). International expert networks between the wars sought to formalize transnational exchange and to disentangle technical challenges from their political connotations in order to create a sheltered environment where technical solutions for societal issues could be conceived (Schot and Lagendijk, 2008).

The time has come for us architectural historians to tap into this academic discourse and explore how the concept of transnationalism can enhance our perception of urban design history. So far, architectural historical studies on the internationalization of planning and urban design have focused on the *Congrès Internationaux d'Architecture Moderne* (CIAM), an international gathering of a select group of modernist architects, although the CIAM was only a marginal player before the Second World War (Van der Woud, 1983, p. 110-155; Albers, 1997). Recent studies (Somer, 2007; Domhardt, 2012) reveal that the CIAM discourse on urbanism was informed by another transnational platform: the International Federation for Housing and Town Planning (IFHTP). Renzo Riboldazzi (2010) labels the body of ideas of this organization as *un'altra modernità*, an alternative conception of modern urban design culture that was very influential in the Inter-bellum period.

This paper uses the IFHTP before World War II as a case study to explore the performance of transnational expert networks in the field of urbanism.

Who participated in transnational planning dialogue, why did they participate and how was this dialogue structured?

Transnational travellers

It is impossible to assess total IFHTP membership. The historical membership administration is lost. But we do not need to assess total IFHTP membership to grasp the essence of its performance. Although its

congresses eventually drew audiences of more than a thousand registered delegates, the trajectory of the IFHTP nevertheless was dictated by a relatively small population of executive members and regular contributors (Geertse, 2012).

In his account of the IFHTP between the wars, Riboldazzi focuses on the papers and national reports presented at the IFHTP congresses. This account easily enables us to identify regular contributors. They are leading (architect-) planners and scientists of the like of Patrick Abercrombie, Raymond Unwin, Gustav Langen, Robert Schmidt, Fritz Schumacher, Thomas Adams, John Nolen and Louis Bonnier. Obviously, the IFHTP favored technical experts to disseminate its town planning message. Riboldazzi's account also demonstrates that – with the positive exception of the IFHTP congress at Mexico City in 1938 –the transnational dialogue of the IFHTP was rooted in the Western World, with definite anchor points in 'imperial Europe'. Riboldazzi does not elaborate on the structure of the IFHTP, nor the machinations behind the transnational formation of urban design culture.

Political and cultural historians that have researched the IFHTP usually focus on the fierce contestations and negotiations in its Bureau. They portray a power struggle between the British initiators of the IFHTP, with an inclination towards liberal views on urbanism, and prominent executive members from Continental Europe, which predominantly held socialist convictions. In the 1930s, American 'New Dealers' around the Public Administration Clearing House (PACH) wanted to use Rockefeller Foundation dollars to push the IFHTP towards a new world order on American lines, while representatives of the Nazi regime wanted to use the IFHTP as a means to spread the Nazi ideology of one united Europe under German leadership. These historians focus on other participants in the IFHTP, like George Montagu Harris from Britain, Kurt Jeserich from Nazi Germany, Henri Sellier from France, Emil Klöti from Switzerland and Charles Merriam and Louis Brownlow from PACH. These people were not urban design experts; they had a background in public administration.

Geertse (2012) has assessed active IFHTP membership. He defines active membership as actively participating in the drafting of the agenda of the international organization by attending meetings of the Bureau and the Council or engaging in committee work. Although an international organization in name, the outlook of the IFHTP was very Eurocentric. The British garden city workers of the Garden Cities and Town Planning Association had established the IFHTP in 1913 to distribute their garden city

message on a global scale. Initially, they provided all the officers for the international body and held a majority at the meetings of the Bureau and the Council (which were all organized in London). The earliest foreign members were predominantly recruited among befriended garden city workers abroad. During the First World War the target group changed. It looked beyond its original backing of garden city enthusiasts. Now it targeted the administrators and urban designers that were to take the reconstruction task at hand. This newfound focus persevered after the War. Representation of public and professional bodies rapidly advanced, reflecting the post-war institutionalization of housing and town planning in the Western world. The interested laymen that had dominated the prewar garden city movement stepped back; technocrats gained the upper hand.

The IFHTP transformed into an international planning expert network organization. The growth of membership can be evidenced by the steadily increasing audiences at the IFHTP congresses: the London congress in 1920 attracted about 170 registered delegates, whereas the Vienna congress (1926) lured more than 1,000 registered delegates. In this new era of mass participation the British garden city workers soon found themselves outnumbered. By the mid-1920s British active membership was counterbalanced by growing active membership from Continental Europe and Scandinavia. Non-European active members only attended meetings at the annual IFHTP congresses. It is important to note that active membership was primarily defined by institutional representation, not expertise (which was the foremost criterion to select lecturers and reporters for the congresses). Also at the transnational stage, material design culture was framed by institutional structures.

Motivations and modes for transnational dialogue

Antony Sutcliffe (1981, p. 168) has identified two major considerations to engage in transnational planning dialogue: inspiration, a traditional motive derived from art historiography, and Joseph Schumpeter's classic innovation diffusion theory. The first IFHTP congress at London in 1914 attracted many foreign garden city workers, seeking inspiration and support from their British peers. Their general receipt was one of 'admiration, not unmixed with envy' (Brown, 1914). The IFHTP congresses with formal sessions and informal talks, exhibitions and post-congress tours offered excellent annual opportunities to stay in touch with the latest ideas and experiences. An American representative at the IFHTP conference in

Gothenburg in 1923 enthusiastically reported that the event enabled to acquaint oneself with the latest town planning ideas and to personally meet renowned urban planning pioneers. The adjoining international town planning exhibition 'was considered the largest and best ever assembled of that subject'¹.

Being an association, the rationale of civil society of course also applies to the IFHTP. By engaging in (transnational) associative life the IFHTP members gained a sense of belonging and by allying interests they could produce a forceful lobby to promote their urban models. Officially, the IFHTP had been established to unify the garden city and town planning movement (Culpin, 1913, p. 225). Dutch planner Lou Scheffer stressed the importance of the IFHTP for building and maintaining a professional network (Scheffer, 1987). Similarly, Bernard Marrey (1988) points out the significance of the first postwar IFHTP congresses for the international contacts of leading French architect-planner Louis Bonnier.

The IFHTP also represented a place of symbolic power to negotiate the legitimacy of ideas, methods, tools, and participants to think about and act upon the city (Saunier, 2001). The IFHTP was an international arena to gain standing and support for ideas, policies and positions. International endorsement could be used to further one's goals at home. In his memoirs C.B. Purdom (1951) revealed that the British initiators of the IFHTP wanted to use the IFHTP for their own agenda. Dirk Hudig, director of the Netherlands Institute for Housing and Town Planning, deliberately used the IFHTP congress at Amsterdam in 1924 to place regional planning on the political agenda in the Netherlands (Bosma, 1993; De Ruijter, 1987). Representatives of the Nazi regime wanted to the international prestige of German planning experience to propagate German leadership through the IFHTP, especially in the late 1930s when Nazi Germany became politically isolated (Nachtmann, 1995).

Stanley Buder (1990, p. 143) characterizes the IFHTP as a major conduit for professional affiliation. Branding oneself an urban planner in the early twentieth century meant participation in the formation and institutionalization of the emerging town planning profession.

Internationalization played a vital role. It created a sense of an international professional community to share the latest experiences, to try to set common professional standards and to build a network of advisors

1 Hertfordshire Archives and Local Studies. Howard papers. DE/HO/F28/6/3. International Town Planning Conference Held in Gothenburg. Paper clipping from American newspaper, August 4, 1923.

and supporters (Saunier, 1999). Following the observations of Pierre Chabard on city planning in the United States, we can distinct two competing approaches to urbanism in the IFHTP: urban interventions as a kind of civic action and town planning as an emerging autonomous profession. Initially, the former dominated, but in the 1920s it was ousted by the latter. The institutionalization of the modern planning profession was secured through two distinct strands of transnational networking. The first mobilized transnational resources to legitimize the position of professional planners and designers. The second promoted town planning and urban design among local authorities to create a field of action for this new profession.

Considerations to engage in transnational dialogue should not be confused with motivations to join the IFHTP. The Urban Internationale was populated by various organizations that continuously squabbled over scarce resources and overlapping audiences (Saunier, 2001). Despite these tensions, IFHTP members often joined rivaling international organizations to pursue their agenda. Cross-membership at times did prompt loyalty issues.

The British executives in the Bureau were wary of fellow executives Emile Vinck from Belgium and his 'henchman' George Montagu Harris. They suspected these executive members of the rivaling *Union Internationale de Villes* (UIV) of trying to sabotage the advance of the IFHTP (Purdom, 1951, p. 63-64).

The performance of competing international organizations did affect the IFHTP. The British garden city workers had established the IFHTP in 1913 to challenge international organizations such as the UIV and the *Congrès Internationaux des Habitations à Bon Marché* (CIHBM). They wanted to set up an 'a circulatory regime': by institutionalizing transnational planning dialogue they sought to control the diffusion of ideas, agendas and professional standards (Saunier, 2008). The explosive growth of participation in the 1920s can partly be attributed to the appeal of the message of the IFHTP and the attraction of its congresses, but to a large extent must also be attributed to the inactivity of competing platforms immediately after the First World War. The members of these dormant bodies joined the IFHTP to resume their transnational trade. Safely located in London, the IFHTP had continued its activities during the War and even launched a new initiative, the Belgium Reconstruction Campaign, whereas the organizations located in Brussels, an epicenter for transnational activity, suddenly had found the War at their doorsteps.

The competitive advantage of the IFHTP did not just originate in practical circumstances. There were fundamental differences at play as well. The IFHTP was governed by a quintessentially British culture of harmony and unanimity, whereas its continental counterparts had a culture of fierce debates and majority voting. The postwar CIHBM was rendered impotent by fierce internal debates on the role of the State and the principal choice between apartments and cottages (Saunier, 2010). The harmonious culture of the IFHTP held such confrontations at bay. The postwar UIV suffered from its institutional character (Gaspari, 2002). It principally served local authorities and promoted the idea of global governance by associated local authorities to replace belligerent nations, although after the War the nation state was generally acknowledged as the basic unit for global governance.

This new reality was most clearly embodied in the League of Nations, an authority that drastically pruned the municipalities' liberties of action on the international stage. The UIV first reestablished itself in the mid-1920s once it abdicated its original ideological outlook and focused on practical issues instead.

According to Stephen Ward (2000), the participants could adopt to different modes for transnational planning dialogue: borrowing and imposition. These modes correlate to the agenda of the participants and the form of membership (active or passive) adopted. Passive membership provided a ticket to the IFHTP congresses, enabling members to digest the offered body of knowledge and to maintain their transnational networks.

This type of borrowing was laborious. Passive members could not directly influence the IFHTP agenda, so they depended on like-minded active members or had to 'shop around' at other transnational platforms. As a consequence, passive members were not loyal participants. To (directly) influence transnational flows of planning knowledge, active membership was essential. Active members could put domestic issues on the IFHTP agenda (focused borrowing) and seek international endorsement for their domestic models, policies and positions. Sometimes they even managed to 'impose' their domestic agenda upon an international audience.

Mechanisms of transnational dialogue

To perform successfully as a transnational planning platform, the IFHTP had to conceive a shared discursive formation, based on a common language. And this discourse had to have significant appeal to sustain itself.

The IFHTP had to cater for the agendas of its affiliated national societies.

This was achieved by representation in the executive and governing bodies of the international association. French philosopher Michel Foucault has pointed out that within discursive formations knowledge is both the creator and creation of power. Presenting papers and reports at the IFHTP congresses provided (symbolic) power to the experts concerned, but the real power in the IFHTP was concentrated at its Bureau which had the authority to define appropriate experts and subjects for discussion.

Initially the power in the Bureau was concentrated with the British initiators. The early foreign members were recruited among befriended garden city workers abroad. These foreigners looked to the British garden city workers to take the lead. Thus the IFHTP was administered by GCTPA officers from GCTPA headquarters in London. These British officers modeled the IFHTP after the GCTPA, introducing a strict hierarchical structure, an unpaid staff (honorary officers) and a culture of consensus-seeking (unanimity). The IFHTP congress agenda was informed by the official GCTPA policy of 'town planning on garden city lines', delivered by protagonists of the British garden city movement.

World War I turned the world of the IFHTP upside down. Many foreign garden city enthusiasts were no longer able to participate. To stay in business, the IFHTP launched its Belgium Reconstruction Campaign in 1915. It looked beyond its original backing and directly addressed the experts – designers, administrators, lawyers, technicians et cetera – that were to take the reconstruction task at hand. In their eagerness to transform Belgium into a model garden city nation, the British leaders of the IFHTP insisted on the implementation of true, independent garden cities (Culpin, 1915). However, Belgium and the rest of Continental Europe preferred housing estates and garden suburbs and ignored the British diktat (Uyttenhove, 1985). The British leaders soon lost interest in the reconstruction campaign.

Even in Britain the garden suburb had triumphed over the true garden city. Thus the British leaders introduced a new objective at the IFHTP congress at London in 1920 which was endorsed as official GCTPA policy: satellite towns. A satellite town basically was a garden suburb with all the properties of a true garden city. The satellite idea failed to convince the continental members. Grand satellite schemes did not provide immediate affordable mass housing near existing population centers.

Supported by the rapid post-war institutionalization of housing and town planning in the Western World (Ward 2002) and the absence of immediate competitors (Geertse 2012, p. 68), the IFHTP matured into one of the largest transnational planning platforms in the first half of the 1920s. The British

members lost their upper hand in the Bureau and the naturalness of (exclusive) British leadership was questioned (Geertse 2012, pp. 100-105).

The Bureau became a political arena in which the organizational outlook of the IFHTP and the agenda of its congresses were being negotiated.

Pressured by the continental members, the IFHTP changed. It left the office of the GCTPA, employed its own paid secretary and nominated its first non-British officer (IGCTPA 1922, 1). The conception of satellite or garden city planning broadened into the concept of regional decentralization to accommodate pioneering (regional) planning accomplishments of the other members. Despite these reforms, the IFHTP did retain a distinct British flavor (Saunier, 2001).

The explosive growth of membership called for reorganization by the mid-1920s. The IFHTP resolved to divide its membership into four sections, dedicated to respectively housing, garden cities, regional planning and town planning². The proposed housing section was warmly received by continental housing reformers in the IFHTP. They recognized an ideal successor of the faltering CIHBM and an opportunity to emphasize the housing question on the IFHTP agenda. The CIHBM was willing to transfer all its activities to the housing section, provided that this section would retain some autonomy³. Obviously, the continental 'housers' thought the IFHTP was still too British. The IFHTP accepted these terms and subsequently the CIHBM formally transferred its activities to the IFHTP in 1926⁴.

The Bureau of the IFHTP and the former dignitaries of the CIHBM almost instantly clashed. The former envisioned a secretariat of the housing section on the continent, that was to be independent from the hosting country, but would resort under the central secretariat in London, whereas the latter demanded a secretariat independent from London headquarters with authority to secure support from the hosting country. This 'housing controversy' was a direct confrontation between political convictions. The socialist members of the former CIHBM wanted to exclusively pursue collective, state-sponsored housing, whereas liberal members in the IFHTP Bureau refused to relinquish cooperative housing and voluntary action. The controversy also represented a clash between the British style of

2 IFHP Secretariat. IFHP Archives. Minutes of the Council, April 23rd, 1925 and minutes of the Executive Committee, September 26th, 1925.

3International Institute for Social History. Wibaut Papers. Folder 346. Correspondence between Wibaut and other CIHBM members in 1925.

4 IFHP Archives. Minutes of the Council, September 14, 1926.

governance in the IFHTP (unanimity and honorary officers) and the more business-like continental culture of majority-voting and paid staff.

Ultimately, the discontent continental housers stepped outside the IFHTP to establish their own International Housing Association (1929), usually referred to as the *Verband*, with its seat in Frankfurt. The housing controversy initiated a rigid, at times artificial, separation between housing and town planning issues at the IFHTP congresses.

The departure of the discontented housers did not restore internal peace. Many sympathizers with the *Verband* retained their IFHTP membership. Both organizations contested who was the true heir apparent of the CIHBM. The *Verband* refused to join the IFHTP, but insisted on practical collaboration, starting with the congresses of both organizations at Berlin in 1931. These congresses barely managed to distinct themselves from one another, embarrassing their proprietors. Thus the two agreed to explore a possible reunion. Negotiations took place in an atmosphere of mutual distrust. The IFHTP Bureau considered the *Verband* an exclusive vehicle for socialist views on housing and, after the Nazi take-over, as an extension of Nazi propaganda. The Nazis effectively had kidnapped the *Verband* and only agreed to a reunion if they would gain sound footing in the IFHTP. The *Verband* was annoyed by the slow decision-making by the IFHTP, suspecting a strategy of endless delays to weaken the *Verband*. Eventually, terms for reunion were agreed upon in 1937. These terms posed a heavily contested compromise that especially benefited the Nazis. The honorary officers were abolished and central IFHTP headquarters were relocated to Brussels (Geertse 2012, pp. 157-163 and pp. 207-212). Nazi Germany was offered the presidency of the reunited body. The IFHTP slowly turned into an extension of Nazi propaganda, propagating *Weltraumplanung* as a means to reinforce the Nazi ideology of *Neues Europa* (Nachtmann, 1995).

If we scrutinize the planning discourse of the IFHTP from its inception in 1913 until the outbreak of the Second World War we can track the evolution of the common language of IFHTP discourse. Initially, an ideological rhetoric of social reform and land reform prevailed as the common language of garden city enthusiasts. Henry Vivian (1914) and C.B. Purdom and Chambers (1922) promoted a strategy of land reform and co-partnership housing, Ebenezer Howard urged the establishment of an ideal

international garden city⁵ and Gustav Langen intimated that town planning was to focus on community building, 'to restore the people to the land' (IGCTPF 1923, 39-49).

In the 1920s administrators, politicians and planning and urban design experts gradually gained the upper hand. They preferred a technical treatment of urban issues, detached from political aspirations. Conference papers started to focus on technical issues such as zoning, survey, administrative foundations and legislative requirements. Conclusions conceived on the basis of discussion and comparison could be implemented under different political regimes (liberal, socialist and totalitarian) (IFTCPGC, 1924). Technocratic internationalism offered a language that was able to transcend political convictions and national peculiarities. Technocratic rationalism was advanced by the introduction of national reports in 1926, based on standardized questionnaires, in the mid-1920s to replace personal (subjective) papers (IFHTP, 1926). Furthermore, it was promoted by projects aimed at conceiving universal technical standards and transcending cultural differences. In the early 1920s the IFHTP attempted to constitute a uniform international town planning notation, an attempt that failed because of national rivalries. The IFHTP was more successful in compiling an influential international tri-lingual glossary of technical terms in town planning and housing, which was published in the early 1930s (Albers, 1997). Political ambitions became the domain of the new international sphere embodied by organizations such as the League of Nations and the International Labour Organization. This sphere was dominated by nation-states, not exponents of transnational civil society.

The IFHTP heavily depended on its congresses for revenue. Therefore it had every interest in attracting as many delegates as possible to its congresses. Participating experts increasingly complained about the disadvantages of mass participation: overcrowded session rooms and shallow discussions. They called for restricted participation by experts only, which was unacceptable to the IFHTP Bureau (Albers, 1997, pp. 191-192).

Attracting the largest possible audience meant the congress program not only had to accommodate the agenda of the affiliated national societies; it also had to appeal to the transnational community of planners and urban designers at large. The decision in 1923 to give the hosting country the authority to make proposals for the congress agenda was not just part of the attempts to reduce the British grip on the IFHTP. It also served to raise

5 Hertfordshire Archives and Local Studies. Howard papers. DE/HO/F12/2. Typescript of address given by Howard to Belgian representatives at Letchworth, February 11, 1915.

commitment and attendance from the hosting country. Sometimes the local organizers had to compromise, because a majority in the Bureau feared proposed subjects for discussion would not appeal to sufficient people. For example, the proposal to discuss national parks at the planned IFHTP congress at Los Angeles for 1940 was dismissed because it held little relevance for most countries.⁶ The IFHTP deliberately sought the vicinity of other major international events – world exhibitions, international planning exhibitions and congresses, et cetera – to raise the attraction and prestige of its own congresses. We can be sure that the IFHTP checked out the competition of its congresses, trying to make its congresses more appealing and, if that was not possible, trying to avoid unnecessary competition. In the 1930s the IFHTP anxiously followed the activities of the *Verband*, intent to keep the upper hand. For its congress at Amsterdam in 1924 the IFHTP tried to make arrangements with the UIV and the CIHBM that were organizing congresses around the same time.⁷

Conclusions

This paper argues that twentieth century urban design culture defies the restrictions imposed by national design histories. Throughout this period designers exchanged ideas and experiences in an international planning society, embodied in international associations, institutions, exhibitions, competitions and periodicals. Although this international sphere was very important for the diffusion of planning and urban design practices, it by no means was a neutral stage where all design ideas could be put forward, nor could everybody participate.

The congresses of the IFHTP demonstrate that urban designers engaged in transnational dialogue for very different reasons, ranging from seeking inspiration, knowledge and camaraderie, to soliciting international endorsement for domestic practices and (supposedly) universal professional standards. Platforms such as the IFHTP had to accommodate the potentially conflicting agendas of their members and to promulgate a common language, whilst securing a large audience. The Bureau of the international association presented an arena where political domestic agendas, (universal) professional interests and potential external collaborations and rivalries were fiercely contested. On the basis of consensus-seeking subjects for discussion and experts to invite were being negotiated. At the

⁶ IFHP Archives. Minutes of an extraordinary meeting of the Bureau, July 10th 1939.

⁷ IFHP Archives. Minutes of the Executive Committee, May 17, 1924.

congresses, a apolitical, highly technical approach of planning and design issues dominated. Urban designers were eager to lend their expertise to discuss and define urban models and design strategies in a sheltered transnational environment. 'Technocratic internationalism' represented a language to transcend political convictions and national peculiarities (Schot and Legendijk, 2008).

References

- Albers, G. (1997) *Zur Entwicklung der Stadtplanung in Europa. Begegnungen, Einflüsse, Verflechtungen*. Braunschweig: Vieweg Verlag.
- Bosma, J.E. (1993) *Ruimte voor een nieuwe tijd: vormgeving van de Nederlandse regio 1900-1945*. Rotterdam: NAI Publishers.
- Buder, S. (1990) *Visionaries and Planners. The Garden City Movement and the Modern Community*. New York: Oxford University Press.
- Chabard, P. (2009) Competing scales in transnational networks: the impossible travel of Patrick Geddes' Cities Exhibition to America, 1911-1913. *Urban History*, 36 (2), 202-203.
- Culpin, E.G. (1913) International Garden Cities and Town Planning Association. *Garden Cities and Town Planning Magazine*, 3, 225-226.
- Culpin, E.G. (1915) Principes des Cités-Jardins et leur Application à la Belgique. *Garden Cities and Town Planning Magazine*, 5, 57-63.
- De Ruijter, P. (1987) *Voor Volkshuisvesting en Stedebouw: over Woninghervormers en de Beweging voor een Goede Stedebouw, 1850-1940*. Utrecht: Matrijs.
- Domhardt, K.S. (2012) *The Heart of the City. Die Stadt in den transatlantischen Debatten der CIAM 1933-1951*. Zürich: Gta Verlag.
- Ewen, S. (2008) *Lost in Translation? Mapping, Molding and Managing the Transnational Municipal Movement*. In Saunier, P.Y. and Ewen, S. (eds.), *Another Global City. Historical Explorations into the Transnational Municipal Movement, 1850-2000*. New York: Palgrave MacMillan.
- Gaspari, O. (2002) Cities against states? Hopes, dreams and shortcomings of the European municipal movement, 1900-1960. *Contemporary European History*, 11 (4), 597-621.
- Geertse, M.A. (2012) *Defining the universal city. The International Federation for Housing and Town Planning and transnational planning dialogue 1913-1945*. Unpublished PhD thesis VU University, Amsterdam.
- Harris Brown, M.E. (1914) Some impressions. *Garden Cities and Town Planning Magazine*, 4, 181-184.

- International Garden Cities and Town Planning Federation (1922) *Report of Conference, Paris, 1922*. London: IGCTPA.
- International Garden Cities and Town Planning Federation (1923) *Report of Conference, Gothenburg, 1923*. London: IGCTPF.
- International Federation for Town and Country Planning and Garden Cities (1924) *International Town Planning Conference, Amsterdam 1924*. London: IFTCPGC.
- International Federation for Housing and Town Planning (1926) *International Housing and Town Planning Congress, Vienna 1926*. London: IFHTP.
- Kohlrausch, M., Steffen, K. and Wiederkehr, S. (eds.) (2010) *Expert Cultures in Central Eastern Europe. The Internationalization of Knowledge and the Transformation of Nation States since World War I*. Osnabrück: Verlag.
- Marrey, B. (1988) *Louis Bonnier 1856-1946*. Liège: Mardaga.
- Nachtmann, W. (1995) *Karl Strölin. Stuttgarter Oberbürgermeister im 'Führerstaat'*. Stuttgart: Silberburg Verlag.
- Nasr, J. and Volait, M. (eds.) (2003) *Urbanism - imported or exported? Native aspirations and foreign plans*. Hoboken: John Wiley & Sons.
- Orillard, C. (2014) The Transnational Building of Urban Design: Interplay Between Genres of Discourse in the Anglophone World. *Planning Perspectives*, 29 (2), 209-229.
- Purdom, C.B. and Chambers, T.G. (1922) How to Get Garden Cities Started Throughout the World. *Garden Cities and Town Planning Magazine*, 12, 97-99.
- Purdom, C.B. (1951) *Life over Again*. London: Dent & Sons.
- Putnam, R. (2000) *Bowling alone: the collapse and revival of American community*. New York: Simon & Schuster.
- Riboldazzi, R. (2010) *Un'altra Modernità. L'IFHTP e la cultura urbanistica tra le due guerre 1923-1939*. Rome: Gangemi.
- Saunier, P.Y. (1999) Atlantic Crosser. John Nolen and the Urban Internationale. *Planning History*, 21 (1), 23-31.
- Saunier, P.Y. (2001) Sketches of the Urban Internationale, 1910-50: Voluntary Associations, International Institutions and US Philanthropic Foundations. *International Journal of Urban and Regional Research*, 25 (2), 380-403.
- Saunier, P.Y. (2008) Les régimes circulatoires du domaine social 1800-1940: projets et ingénierie de la convergence et de la différence. *Genèses*, 71 (2), 4-25.

- Saunier, P.Y. (2010) *Borderline Work: ILO Explorations onto the Housing Scene up to 1940*. In Van Daele, J., Rodríguez G.M., Van Goethem, G. and Linden, M. van der (eds.), *ILO histories. Essays on the International Labour Organization and its Impact on the World During the Twentieth Century*. Bern: Peter Lang.
- Scheffer, L.S.P. (1987) *Herinneringen aan de periode 1887-1963*. The Hague: NIROV.
- Schot, J. and Legendijk, V. (2008) Technocratic internationalism in the interwar years: building Europe on motorways and electricity networks. *Journal of Modern European History*, 6 (2), 196-217.
- Smith, M.P. (2003). *Transnational urbanism: locating globalization*. Oxford: Blackwell.
- Somer, C. (2007) *The Functional City. CIAM and the legacy of Van Eesteren, 1928-1960*. Rotterdam: NAI Publishers.
- Sutcliffe, A. (1981) *Towards the Planned City: Germany, Britain, the United States and France, 1780-1914*. New York: Saint Martin's Press.
- Uyttenhove, P. (1985) *Internationale inspanningen voor een modern België*. In Smets, M. (eds.), *RESURGAM. De Belgische wederopbouw na 1914*. Brussels: Gemeentekrediet.
- Van der Woud, A. (1983) *Het Nieuwe Bouwen International: CIAM - Housing - Town Planning*. Delft: Delft University Press.
- Vivian, H. (1914) The organization of co-partnership housing. *Garden Cities and Town Planning Magazine*, 4, 192-195.
- Ward, S.V. (2000) *Re-examining the international diffusion of planning*. In Freestone, R. (eds.), *Urban planning in a changing world: the twentieth century experience*. London: Routledge.
- Ward, S.V. (2002) *Planning the twentieth-century city: the advanced capitalist world*. Chichester: John Wiley & Sons.



L'approccio storico al design. Stereotipi, aporie, paradigmi (?)

Giorgio GIALLOCOSTA*^a and M. Cristina TONELLI^b

^a Università di Genova; ^b Politecnico di Milano

Discrasie di storiografia del design coinvolgono altrettante problematiche circa le sue accezioni: dal disegno industriale alle più recenti connotazioni, che ne ampliano background sedimentati, ma determinano continue ridefinizioni adduttrici di slittamenti, aporie, rischi di stereotipi qualora avvengano, in ambiti storiografici, marginalizzazioni o enfattizzazioni di talune esperienze rispetto ad altre. Letture insufficienti sulle relazioni fra antefatti motivanti determinati eventi, a cui spesso si attribuiscono incipit per nuovi scenari, rischiano in effetti enfattizzazioni dei secondi e marginalizzazioni dei primi. Così emergono improprie disarticolazioni in quel continuum di processi, dinamiche, rotture talora sovvertitrici di paradigmi: non ravvisandosi in effetti sovversioni avulse da pulsioni anticipatrici.

Similmente ogni storia dell'innovazione emerge da quella fascia di confine che distingue ma non separa differenti fattualità operative, modi di produzione, ecc.: così, atteggiamenti non deterministici nell'interpretazione dei processi storici si fondano anche sulle capacità di snidare antefatti che anticipano caratteri di epoche successive. Né le componenti socio-tecniche, spesso invocate per un corretto approccio al design e all'innovazione, sfuggono a riduzionismi in ricognizioni lacunose di fatti storici: emergono invece, quanto più ridefinizioni storiografiche rimuovono lacune. Possono così restituirsi accezioni dinamicamente aggiornate di storia del design (e dell'innovazione), e ricostruzioni circa il senso (o i paradigmi?) delle loro ricorrenti connotazioni.

Keywords: Storiografia; design; criticità

Quella gerarchia di valori che presso Goethe o Winckelmann determina la concezione dell'arte, talora:

[...] non esercita più alcun influsso. Certo, sarebbe errato ritenere che così venga scardinata la stessa considerazione dialettica dell'arte. Ciò non

*Corresponding author: **Giorgio Giallocosta** | e-mail: giallocosta@dada.it

può avvenire prima che i disiecta membra che l'idealismo cerca di tenere insieme, la rappresentazione storica da un lato e l'apprezzamento dall'altro, siano diventati un'unica e medesima cosa e superati come tali. La soluzione di questo problema rimane riservata a una scienza della storia che non abbia più come oggetto un groviglio di puri dati di fatto, bensì quel gruppo definito di fili che rappresenta la trama di un passato nell'ordito del presente. (Benjamin, 1937, trad. it. p. 93)

Qualcosa di simile può argomentarsi circa le discipline del design. Queste ultime peraltro ormai assumono connotazioni estremamente diversificate, e spesso in sostanziale discontinuità con assunti *classici* (o presunti tali) di *disegno industriale*. Qui in effetti quel *groviglio di puri dati di fatto*, che non può ancora rappresentare *la trama di un passato nell'ordito del presente* (Benjamin, 1937), si addensa tanto più a fronte di un flusso, pressoché incessante, che costantemente pervade ridefinizioni, connotazioni, sviluppi disciplinari, propri di quest'area di interesse e positivamente espansiva (pur con i problemi che, come in parte si vedrà, possono evincersi) dei suoi *originari* background e sedimentazioni esperenziali. Tuttavia, soprattutto le tradizioni relativamente recenti delle discipline del design (dall'*originario industrial design* al *fashion design*, al *social design*, ecc.), o l'assunzione di riferimenti diversificati o comunque non ancora compiutamente consolidati e pertinenti, rendono le stesse ancor meno sistematizzabili secondo ottiche storiografiche che non in termini di precise connotazioni disciplinari.

Storicamente, il termine *industrial design* viene proposto per la prima volta intorno al 1927 da Ernest Elmo Calkins (Pulos, 1983), a indicare l'esito dell'attività di un progettista che lavora a fianco dell'industria nella definizione di un prodotto di serie, con l'obiettivo di valorizzarne gli aspetti funzionali, formali e quelli finalizzati al successo di mercato. Solo con la progressiva importanza acquisita dalla disciplina nel decennio successivo, il termine, dapprima tiepidamente considerato, diviene condiviso nei paesi di lingua inglese; in Italia nel secondo dopoguerra, seppure già in uso, è sostituito da una sua disinvolta traduzione, *disegno industriale*, nonostante tale locuzione (avendo il precedente di una sua sedimentata connotazione nell'ambito operativo del disegnatore industriale) potesse ingenerare non poche perplessità. Successivamente, con l'accredito del *soft power* americano e la maggior diffusione della lingua inglese per l'uso delle moderne strumentazioni informatiche, l'ormai desueto *disegno industriale* diviene (nella *vulgata italica*) *design*: termine certamente più *rapido*, ma suscettibile di altre impreviste promiscuità. Il suo significato di *progetto* lo

rende *flessibile* (ai limiti del genericismo) e riferibile ad ambiti diversi, o lontani, rispetto a quelli dell'industrial design, perlomeno laddove non lo si ancori, come nella lingua inglese, a termini *declaratori*: quelli che, nel progredire del tempo, ampliano i confini originari della disciplina (*furniture, graphic, interaction, interior, web*). Se da essi scissa (soprattutto concettualmente), una connotazione generica di *design* si rende disponibile, di fatto, a *qualificare* qualsiasi attività che implichi scelte e formalizzazioni organizzative, quella del programmatore elettronico, dell'ingegnere gestionale, del bancario che individua rocamboleschi prodotti finanziari, e quant'altro: così come gli *atti creativi*, che esulano da previsioni di serialità.

Il mondo dei prototipi, degli oggetti *vintage*, degli artefatti artigianali con alto contenuto di ricerca formale, registra in questi anni un'imprevista fortuna grazie a un articolato network di selezionate gallerie artistiche, antiquari, case d'asta, ecc., che, valorizzato da ibridi eventi annuali (*Design Miami*, per esempio), *sponsorizza* l'oggetto come elemento di *status symbol* (lusso, esclusività, ecc.): il fenomeno, gonfiatosi a dismisura, richiede un'*etichetta*, e si viene così accreditando come *design art*, con appagamento di operatori e clienti, ma ingenerando ulteriore confusione in uno contesto già di per sé poco chiaro.

Esemplificative circa le ricorrenti discrasie in ambiti di *storiografia del design* appaiono, dunque, le questioni fin qui citate. Ma non solo. Con l'esordio del nuovo secolo, il design si presta a ulteriori declinazioni, quella del *design strategico* per esempio, o del *design dei servizi*, o del *design per i Beni Culturali*, ambiti nei quali la figura del progettista *pretende* una centralità metodologica (oltre che ideativa e organizzativa), benché in pressoché tutti i casi la sua incidenza appaia complementare (se non addirittura subordinata) ad altre competenze, professionali o meno: quelle del sociologo, dell'economista, del direttore di museo, del politico, ugualmente determinanti nell'assunzione delle decisioni e nella definizione delle scelte. In questi casi, si incorre in palesi contraddizioni che non creano antinomie solo perché i diversi protagonisti coinvolti appaiono disinteressati a esigenze di chiarezza, i destinatari delle diverse proposte permangono largamente inconsapevoli circa tali questioni, e nel mondo del design si reitera l'assenza di figure che operino criticamente nell'ambito di un'opportuna perimetrazione e definizione della disciplina, così consentendo la sussistenza di ambiguità, come quella di prestazioni *progettuali* di fatto limitate ad attività di mera meta-progettazione, prive di credibili possibilità di emersione come tali (e delle salutari contromisure che credibilmente se ne opporrebbero), e dunque *attivamente* costitutive di una

più generale *opacità* di scenario. Anche la recente enfasi sul *social design* si presta a non poche ambiguità, non solo per i diversi (e poco chiari) orientamenti che assume e con cui si declina, ma soprattutto per i tentativi di arrogarsi ruoli di esclusivismo, che dovrebbero invece connotare di diritto finalità e funzioni di ogni attività di progetto. Né in tal senso vanno sottovalutati i fenomeni connessi alle attuali e crescenti disponibilità di stampanti 3D: in questo caso gli sviluppi evolutivi che potrebbero delinearsi, ancorché fin qui *solo potenziali*, vengono di fatto riduttivamente ancorati ad atteggiamenti comportamentali con cui per esempio i designer, *semplicemente*, si limitano a interpretare anche ruoli di produttori e venditori dei propri artefatti.

Tali discrasie, come accennato, convergono dunque in altrettanti aspetti problematici circa le molteplici accezioni degli ambiti del design, le cui ricorrenze inoltre accomunano, a quanto già pur positivamente rimarcato, necessità di continue ridefinizioni concettuali che spesso comportano *slittamenti* o anticipazioni circa *incipit* di nuovi scenari fenomenologici, formalizzazioni disciplinari, ecc. Anche a fronte di una situazione di questo tipo, nel 2008 l'ICSID - International Council of Societies of Industrial Design ritiene necessario mettere a punto una nuova definizione di *design* che, pur ribadendo le finalità pregresse (sociali, culturali, ecc.), amplia l'interpretazione di *industrial*, riferendola tanto a *industry* (inteso come settore di produzione) quanto a *industrious activity*. Tutto ciò conferma gli *slittamenti* ai quali la disciplina è continuamente sottoposta, così come il suo radicamento teorico-metodologico solo relativo, data la recente formalizzazione della stessa, e soprattutto la mancanza di una tradizione apprezzabilmente consolidata di ricerche e studi storico-critici che non sempre peraltro, fra quelli disponibili, evitano marginalizzazioni o enfattizzazioni di talune esperienze, rischiando così di incorrere in letture stereotipate o aporetiche.

Atteggiamenti aporetici, o ricorrenze di stereotipi, persistono dunque qualora, in ambiti inclusivi di attività di ricerca storiografica, se ne enfattizzino o se ne marginalizzino eventi, iniziative, ecc., assunti come anticipatori o meno di nuove *declinazioni* disciplinari. Sintomatica in tal senso è anche la connotazione attribuibile ai concetti di *innovazione*, o di *sviluppo* (qui enfattizzandone gli assunti coerenti con orientamenti in senso industriale), a seconda che, per esempio, si privilegi l'una o l'altra delle *tre fasi* dell'industrialismo moderno, come già definite da Argan: la prima, egli sostiene:

L'approccio storico al design. Stereotipi, aporie, paradigmi (?)

[...] è quella della ripetizione meccanica o della «spersonalizzazione» dei motivi e dei processi formali dell'artigianato [...] La seconda è quella che constata il carattere razionale o scientifico dei processi meccanici, riduce il bello al pratico e il pratico al razionale; ammette che non vi può essere bellezza fuori della razionalità [...] A loro volta (nella terza fase - nda) i processi pratici della produzione, che non possono che plasmarsi sui processi del pensiero, tendono a sormontare la «razionalità» tradizionale: ed ha, in questa sede, poca importanza stabilire se si tratti di un passaggio dal razionale all'irrazionale [...] o di una estensione dei confini del razionale [...]. (Argan, 1965, 134-135)

ciò che interessa è piuttosto rimarcare come la *terza fase* si connoti in quanto maturazione compiuta dei *processi pratici della produzione*, con cui si sviluppano processi evolutivi, da semplice modificazione di fatti puramente operativi a determinazione di nuovi assunti axiologici (*bellezza-praticità, praticità-razionalità, ecc.*), a configurazioni di nuovi scenari in certa misura *paradigmaticamente* (?) sovvertitori di concezioni tradizionali.

E' evidente come la definizione indistinta di ciascuna delle tre *fasi storiche* (come brevemente delineate), in quanto *incipit* di nuovi scenari produttivi (e di organizzazione della produzione), produca aporie sia nella determinazione/individuazione di fenomenologie mature e coerenti con assunti innovatori di tipo rigorosamente industriale, che in orientamenti per sviluppi successivi; parimenti emergono stereotipi, soprattutto a fronte della persistenza di *abitudini* (concettuali, storiografiche, ecc.), poco inclini a riconsiderazioni critiche circa *assunti* consuetudinari e non apprezzabilmente centrati in termini di esaustività/pertinenza disciplinare (con particolare evidenza per le molteplici declinazioni da qui evincibili, e per le loro interazioni), o ancora contraddistinti da mancate obliterazioni o mitigazioni di rischi circa improprie enfattizzazioni o marginalizzazioni di ruoli, esperienze, ecc. Anche in tal senso, molti dei fatti che storiograficamente ancora contraddistinguono l'*industrial design* richiedono una maggiore puntualizzazione, che riorganizzi letture ormai sedimentate benché frutto di punti di vista opinabili o parziali. Le marginalizzazioni di alcune esperienze o l'enfattizzazione di altre determinano una struttura storica che, consolidandosi, viene assunta senza alcun interesse verso esigenze di revisione critica, generando uno scenario pressoché inamovibile che incide anche sulla comprensione della contemporaneità. La Bauhaus per esempio gode di un'attenzione assoluta da parte degli storici, avvalorata anche dalla sua musealizzazione grazie alla creazione del Bauhaus-Archiv a

Berlino, a scapito però di altre realtà (formative, didattiche e produttive) della Germania di Weimar: considerata un *movimento* e accreditata come unica struttura di formazione progettuale del periodo, se ne enfatizza il ruolo nonostante di fatto costituisca una scuola simile ad altre presenti nella Repubblica di Weimar e, come queste, erede diretta della riforma delle Kunstgewerbeschulen operata da Muthesius nel 1904 e inserita nella strategia organizzativa del Werkbund. Non si tratta di un *unicum* quindi, né di una realtà autonoma gestita da Walter Gropius, e non appare disarticolata rispetto a quel tessuto culturale della Germania del II Reich che continua a persistere negli anni di Weimar: riposizionarne la presenza in un contesto contraddistinto da altre scuole, da realtà di produzione industriale, da attività orientate a ricerche di ottimizzazione seriale e ispirate a concreti problemi sociali, aiuterebbe certamente a ridimensionare stereotipi e condizionamenti che ancora coinvolgono la storiografia corrente.

Estremamente carente, inoltre, è la lettura usuale del design americano fra le due guerre, di fatto limitata a una mera questione di *styling* contraddistinto da *suggestive* linee aereodinamiche ed etichettata come *streamlining*; appare evidente come ricostruzioni storiche di questo genere, a fronte dei prodotti, materiali, tecnologie regolarmente *messi in campo* nelle esperienze statunitensi, non solo risultino riduttive o addirittura infondate, ma lesive soprattutto in termini di scorrette rappresentazioni così depotenziate circa il valore della ricerca americana, invece particolarmente attenta alle logiche industriali, alle esigenze dei consumatori, ai problemi di congiuntura economica. Se fosse attribuito al termine *streamline* l'altro suo significato, quello di studio mirato a migliorare l'efficienza di un processo, alla sua modernizzazione e/o semplificazione, tale connotazione (ancorché *solo tendenzialmente* accettabile) implicherebbe una notevole revisione di gran parte delle applicazioni storiografiche fin qui condotte. Allo stesso modo, gran parte degli apporti storiografici inerenti le discipline del *fashion design* si caratterizza per le sue carenze circa letture e applicazioni, che appaiono quasi esclusivamente centrate sulle proposte stilistiche delle Case d'alta moda (e marginalizzandone, per esempio, questioni di strategia comunicativa, di organizzazione aziendale e produttiva, di approccio ai mercati, ecc.). Si indulge nello stereotipo della *moda* come mero fatto artistico e non pure come *business*, peraltro con ripercussioni negative anche circa analisi e valutazioni delle esperienze italiane contemporanee, e con riferimento alle questioni economiche a queste connesse (assolutamente non marginali per tale realtà).

Parimenti, e come in parte già osservato, occultamenti o marginalizzazioni di taluni eventi precorritori di nuove determinazioni di scenario (*produzione artigianale - produzione industriale*, per esempio), o comunque letture insufficienti circa le relazioni con ulteriori episodi o fatti storici di più ampia divulgazione, producono stereotipi (o comunque rischi di questo tipo) circa *incipit* di nuovi modi di produzione, modelli organizzativi, ecc., assegnati invece a esperienze maggiormente note (o consuetudinariamente considerate tali, seppure con reale portata e significazione meno interessanti per i casi in questione), e ledendo ruoli e senso di antefatti (*logici e cronologici*), *motivanti* e strutturanti *quelle* nuove determinazioni di scenario. Il rischio maggiore in questi casi è tuttavia quello di assecondare obliterazioni di tali antefatti soprattutto in loro possibili propensioni a rappresentare un novero di esperienze eventualmente foriere di inedite indicazioni, suggerimenti, e quant'altro, circa ulteriori opportunità innovatrici. Né interpretazioni decontestualizzate di determinati fatti storici producono assunti stereotipati, poco pertinenti con le questioni qui trattate.

Uno dei fattori, fra quelli maggiormente marginalizzati dalla storiografia del design, è quello inerente il *mercato* (spesso adducendo motivazioni di difficoltà nel reperimento di dati e informazioni utili in merito): è possibile in tal senso avanzare, fra quante possibili al riguardo, almeno una considerazione relativa a un particolare episodio storico (assai noto) che, ancora privo di significative riletture e reinterpretazioni critiche, contribuisce a reiterare, anche qui, quel *groviglio di puri dati di fatto* (Benjamin, 1937) assolutamente inidoneo a garantire efficaci rimozioni di stereotipi e loro sostituzioni con trame finalmente chiarificatrici *di un passato nell'ordito del presente* (Benjamin, 1937). Tale considerazione riporta cronologicamente alla metà dell'Ottocento, e riguarda l'Esposizione Universale di Londra del 1851: qui i prodotti presentati, in particolare quelli dell'industria inglese, vengono additati come significative esemplificazioni di scarsa attenzione alla qualità formale, soprattutto per quanto emerge dal raffronto con le produzioni francesi (di fatto, di tipo artigianale); com'è noto, ne scaturisce un dibattito sui processi di produzione meccanizzata, a cui si addebitano responsabilità di scarsa qualità formale, contrariamente a quanto avviene per le produzioni tradizionali di tipo artigianale, peraltro assunte come esemplificazione positiva di controllo a garanzia del gradimento degli esiti finali. Questa polemica, che storiograficamente viene riferita in termini rigidamente fattuali (ossia, senza alcun apprezzabile tentativo di interpretazione critica) potrebbe essere riscritta alla luce degli effettivi caratteri (per quanto qui interessa) dei prodotti esposti: industriali,

quelli inglesi, di tipo artigianale, quelli francesi, ecc. In effetti, sia i manufatti francesi che quelli inglesi esplicitano un decorativismo, oggi probabilmente giudicabile come improprio e discutibile, che può motivarsi con il *gusto* dell'epoca (o meglio, con la diffusione di determinati modelli culturali propri di quel periodo storico), *condizionato* dalla libera ripresa degli stili storici e così costitutivo (per tali aspetti) dei caratteri di *quei* mercati. In tal senso, sia la produzione artigiana (o tendenzialmente tale) che quella industriale mettono a punto offerte *di fatto* compatibili con le attese dei mercati. Così, le critiche di Henry Cole o di William Morris andrebbero piuttosto interpretate, anziché mediante stereotipate antitesi fra *industria* e *artigianato*, esplicitandone la loro chiara collocazione nell'ambito di logiche, modelli culturali, scenari futuribili a essi contestualmente possibili, e rapportandole alle tendenze di un mercato da interpretare e soddisfare, secondo gli stessi, con un approccio diverso: una rilettura di questo tipo costituirebbe inoltre, con molta probabilità, un nuovo *incipit* maggiormente utile a meglio comprendere gli eventi successivi. Ancora una maggiore attenzione al mercato permetterebbe per esempio una migliore lettura del *Werkbund* e del suo ruolo quale reale modello di qualificazione della produzione industriale tedesca, e riferimento per opzioni e/o esperienze operative perseguite negli anni fra le due guerre in vari paesi europei e negli Stati Uniti. Laddove inoltre si rapportasse idoneamente il mercato alla realtà manifatturiera delle diverse nazioni, ne conseguirebbero letture, chiarimenti e interpretazioni maggiormente attendibili circa le stesse scelte produttive effettuate. L'enfasi, tutta storiografica, rivolta in alcuni casi (o periodi particolari) verso determinati prodotti pur non particolarmente significativi in quanto a diffusione registrata, seppure (in linea di principio) potenzialmente giustificabile da un punto di vista eminentemente *ideativo* degli stessi, acquisirebbe un deciso ridimensionamento storico qualora se ne percepissero, pur scontando possibilità ottimali di una loro messa a punto con metodi industriali, le ragioni di fatto della non accettazione da parte del mercato, o le situazioni di effettiva carenza (seppure temporanea) di strutture in grado di realizzarli, oppure congiunture abbinate a strategie di impresa, politiche di marketing, o quant'altro, che per esempio motivano la non disponibilità di quelle aziende pur tecnologicamente attrezzate allo scopo ma consapevoli, *semplicemente*, del loro non gradimento: in questo modo, tali manufatti conserverebbero in certa misura un'enfasi giustificabile sotto altri aspetti (quali *antefatti* di prodotti messi a punto successivamente, o quali *anticipazioni* di atteggiamenti poetici di futura maturazione, ecc.), ma soprattutto potrebbero disvelarsi le ragioni di altre scelte produttive

premiare dai mercati dell'epoca, ancorché marginalizzati dalla storiografia corrente.

Se la consapevolezza di

[...] scardinare il continuum della storia è propria delle classi rivoluzionarie nell'attimo della loro azione [...] (Benjamin, 1940, trad. it. p. 47)

e dunque la sua negazione assume connotazione di dignità *fattuale* nel concreto dispiegamento dei fatti storici, è innegabile come la *comprensione* e l'*interpretazione* di quest'ultimo non possano obliterare quel flusso incessante di processi, dinamiche, *rottture* che pure talora sovvertono paradigmi consolidati (né procedere per sue improprie disarticolazioni), e che così appare prescindendo dall'*ineliminabile portata metafisica* circa la *complessità ultima del problema della storia*: all'*Angelus Novus*, dipinto da Paul Klee e rappresentativo della possente figura allegorica che sta al centro delle *Tesi sul concetto di storia* (Benjamin, 1940), è affidato

[...] il compito di alludere alla complessità ultima del problema della storia e di indicarne, segnalando la discrasia nella percezione dei fenomeni, l'ineliminabile portata metafisica. Infatti dove gli uomini vedono una successione di eventi, l'angelo non vede che un crescente ammasso di rovine. Occasionalmente si danno momenti [...] nei quali anche l'uomo è in grado di percepire la storia in questo suo aspetto terribile [...] Ma nell'intuizione di Benjamin l'angelo della storia vede rovine sempre, persino quando agli occhi umani si palesa solo la normalità del divenire storico. (Bonola e Ranchetti, 1997, XVII)

Ogni modificazione che contraddistingue il flusso *solitamente percepibile* degli eventi (Bonola e Ranchetti, 1997), da quelle più facilmente individuabili e/o prevedibili fino ai sovvertimenti maggiormente inattesi e radicali, non è priva in effetti, nei più svariati ambiti in cui può manifestarsi, nei rapporti sociali, in politica, nella scienza (Kuhn, 1962), di pulsioni anticipatrici che concretamente la *legittimano*, sul piano eminentemente storiografico, in termini motivazionali, contestuali, ecc.

Similmente ogni *storia dell'innovazione*, sia che questa si dipani attraverso fasi progressive di perfezionamenti, ottimizzazioni, ecc., che tramite *rottture* rilevanti (e mediante ricorsi, ossimori, contraddizioni, debole *linearità* di eventi o decisa *non linearità* di apporti, motivazioni, ecc.),

affonda le proprie radici in quella efficace connotazione del concetto di *confine*, da cui ne emerge un *insolito* significato (o quanto meno, non apprezzabilmente ricorrente). Si sostiene infatti, a proposito di una tale connotazione, come in ogni accezione non riduzionista di *confine* quest'ultimo debba piuttosto considerarsi contraddistinto da una duplice funzione

[...] e, in particolare, quella per cui essa si presenta non come linea di demarcazione, bensì come 'ponte sottile', fattore di contatto e di scambio tra domini differenti e di creazione, proprio in virtù di questo scambio, di un nuovo ambito trasversale che li attraversa e li coinvolge entrambi, ponendosi 'a cavallo' tra di essi. (Tagliagambe, 2008, 25-26)

In tal senso, e con opportuna trasposizione in ambiti di ricerca storiografica, è in quella *fascia di confine*, o *spazio di realtà intermedie* (Tagliagambe, 2008), in cui *convivono* e *si relazionano* peculiarità (anche significative) di differenti epoche, modi di produzione, modelli organizzativi, ecc., che va ricercato (e ben oltre determinismi cronologici) il senso degli eventi che segnano il passaggio verso modificazioni di scenario e sviluppi innovativi. Atteggiamenti coerentemente non deterministici (e soprattutto avulsi da stereotipi) nell'interpretazione dei processi che contraddistinguono la successione dei fatti storici convergono anche, pertanto, nelle capacità di snidare quegli antefatti, quelle esperienze, o quegli eventi episodici, pure cronologicamente ascrivibili a epoche precedenti (soprattutto a fronte della scarsa numerosità con cui si manifestano), ancorché *consuetudinariamente* sottovalutati nella loro portata e significanza, e che anticipano epoche successive (*produzione artigianale versus produzione industriale*, per esempio).

Fra le diverse *fasce di confine* che concernono il design, merita forse citare quella, tutta italiana, che coinvolge le imprese produttrici di arredi, attive nel corso degli anni Cinquanta, in un periodo che sancisce il passaggio sostanziale dai processi artigianali a quelli industrializzati, e annovera una presenza estremamente *vivace* e ancora entusiasta di architetti disposti a elaborare ipotesi e proposte, funzionali a individuare orientamenti per l'aggiornamento delle tipologie di produzione. È un periodo felice nel senso delle proposte e delle iniziative, il cui futuro, tutto da delineare, ispira comunque un clima diffuso di fiducia, è un periodo aperto alla sperimentazione di procedure e modelli anche perché, mancando ancora un senso del concetto di *impresa moderna*, una reale consapevolezza del

mercato, delle possibilità effettive di distribuzione dei prodotti, ecc., il *medium* dell'architetto-designer sembra in grado di accompagnare e spesso orientare la trasformazione della struttura produttiva: stagione positiva quindi, soprattutto in termini di iniziative e sperimentazioni, e in cui si avvia il posizionamento di aziende che poi la storiografia sottolineerà come *design driven*, e assolute autrici e protagoniste della fortuna del *made in Italy*. Le zone d'ombra che rimangono sono però quelle relative alla loro capacità di operare nel senso di un effettivo processo di trasformazione industriale, e in cui per alterne vicende (e valutazioni anche opinabili, o addirittura non avulse da logiche non pertinenti circa le problematiche in atto) si impone la scelta di privilegiare un mercato esclusivamente borghese, obliterando di fatto ogni possibilità di significativa propensione per cataloghi *aperti a molteplici* declinazioni sociali: in altre parole, quel messaggio di impegno verso la *casa popolare*, formulato da architetti e aziende e avviato con la Triennale del 1947, che indica comunque nell'area brianzola l'esistenza di imprese in grado di corrisponderlo, perde consistenza e interesse negli anni successivi, validando invece un percorso semplicistico e con meno rischi in termini di gradimento di mercato, *prudentemente* innovativo, e incapace di significative esperienze di differenziazione. Il dubbio che rimane è se tali scelte siano state causate dall'incapacità delle imprese di impegnarsi in concreti processi di industrializzazione, oppure se le responsabilità siano da addebitarsi al progressivo disimpegno degli architetti che dapprima ne suggerivano gli orientamenti, o se si tratti di altro ancora. Il caso della Meroni e Fossati, azienda particolarmente attiva durante gli anni Trenta (Tonelli Michail, 1987) e capace di intercettare, anche grazie alle opportunità offerte dalla dotazione di macchinari e tecnologie moderne, un mercato tanto elitario quanto economico, avrebbe potuto costituire un modello percorribile, magari creando linee produttive sostenute da strategie diversificate di marchio e di comunicazione. Se quanto descritto, e prescindendo da considerazioni o valutazioni circa gli esiti conseguiti, può comunque annoverarsi fra quelle esperienze da cui emerge con sufficiente chiarezza il ruolo di un *insieme* (e delle interazioni che in esso si producono) costituito da operatori (soprattutto), strategie, ecc., che, *a cavallo tra domini* (o fasi storiche) *differenti* (Tagliagambe, 2008), struttura quella zona di confine in cui si produce il passaggio fra modi di produzione diversi e cronologicamente caratterizzati, il caso che segue appare invece sintomatico di atteggiamenti di certa critica (e di successive applicazioni storiografiche) in cui si attua invece una tendenziale obliterazione circa il valore sinergico di una costellazione di eventi, iniziative, episodi, ecc., in quanto decisivo, in

termini di modalità attuative e risultati conseguiti, dei periodi di *passaggio* fra scenari (o elementi di scenario) differenti. Una *linea* di confine, più che una *fascia* in effetti, purtroppo declinata come *demarcazione* che non *fattore di contatto e di scambio tra domini differenti* (Tagliagambe, 2008), e che qui merita una puntualizzazione, è quella che interessa il ruolo del design italiano d'avanguardia. Negli ultimi anni Sessanta vengono editati una serie di arredi, frutto tanto della ricerca sulle possibilità applicative dei materiali plastici, quanto dell'ironia e della *voglia di sorpresa* propria della cultura del tempo, quella meno legata alle consuetudini, alle abitudini e alle convenzioni borghesi; una certa *critica militante* attribuisce a questa stagione valori e contenuti, sicuramente inoppugnabili, ma talmente *personalizzati*, in quanto riferiti solo all'impegno di alcuni progettisti rispetto ai molti che pure proponevano soluzioni parimenti significative, che tale lettura diviene un *golem* difficilmente disinnescabile dall'opinione pubblica corrente (e da quella degli stessi studiosi e specialisti) e foriero poi di successive enfattizzazioni e museificazioni dell'opera, fra tanti, degli stessi attori *deliberatamente* in causa: un primo (e a quanto risulta *unico*) tentativo di reale comprensione di quella stagione, scevra da condizionamenti e nell'alveo di un contesto più generale quale il design del periodo, viene condotto da Emilio Ambasz con l'organizzazione della Mostra del MoMA del 1972, senza però che si verifichi alcun seguito. Tale situazione, sostanzialmente priva di alcuna riflessione realmente oppositiva circa quel convenzionalismo instaurato dalla cosiddetta *critica militante* dell'epoca, diviene poi responsabile di incentivazioni e valorizzazioni esclusivamente appannaggio di contributi di definizione incerta fra ambiti artistici, artigianali, di produzione *elitaria* (Alchymia, Memphis), e così condizionando contesti e mercati; promuove poi, di fatto, alcuni dei *protagonisti* di una siffatta scena produttiva quali interpreti, nello stesso tempo, di ruoli plurimi, fra loro discordanti, e in tal maniera determinando vere e proprie imposizioni (soprattutto alle aziende produttrici del settore) di figure proterve di *designer*, promotrici e *sponsor* delle proprie produzioni.

Né le stesse componenti socio-tecniche (come in parte può evincersi da quanto già fin qui trattato), solitamente (e *formalmente*) invocate come *costitutive* di un corretto approccio al design e all'innovazione, sfuggono a rischi di riduzionismo qualora permangano ricognizioni lacunose, e/o stereotipate, di fatti storici. Sintomatico, per un ampio insieme di consuetudini di fatto *strutturanti* la storia della cultura, è quanto sostiene Benjamin nel saggio su Fuchs: il

[...] peculiare rilievo con cui la storia della cultura presenta i suoi contenuti è [...] un rilievo apparente e fondato da una falsa coscienza [...] Il materialista lo considera con diffidenza. A questa diffidenza egli sarebbe autorizzato già da una mera ispezione di ciò che è stato: tutto ciò che dell'arte e della scienza egli può controllare ha sempre un'origine che egli non può considerare se non con orrore. Perché tutto ciò deve la sua esistenza non soltanto alla fatica dei grandi genî che l'hanno creato, ma anche [...] all'anonima servitù dei loro contemporanei. Non è mai un documento di cultura senza essere insieme un documento di barbarie. (Benjamin, 1937, trad. it. p. 90-91)

La centralità di tali componenti può dunque emergere, e con evidenza decisamente fattuale, o *tanto più fattuale* quanto più ridefinizioni e interpretazioni storiografiche tendano a rimozioni di lacune, consuetudini cristallizzate, ecc., indagando e recuperando invece il reale *portato* che ruoli, funzioni, costellazioni di eventi, e quant'altro, svolgono (e hanno svolto) nei cambiamenti e nel complessivo flusso dei fatti storici. In questo modo, e in termini più generali, possono restituirsi accezioni *dinamicamente aggiornate*, e tendenzialmente non obliterative, di storia del design (e dell'innovazione). Con esse, infine, possono avviarsi strategie di tendenziale ricostruzione circa il senso (o gli aspetti *paradigmatici*?) delle ricorrenti connotazioni, sia pregresse che attuali, di queste ultime.

Riferimenti

- Argan, G.C. (1965) *Progetto e destino*. Milano: Il Saggiatore.
- Benjamin, W. (1937) *Eduard Fuchs, der Sammler und der Historiker*. Parigi: Librairie Félix Alcan.
- Benjamin, W. (1940) *Über den Begriff der Geschichte*. Los Angeles: Institute of Social Research.
- Bonola, G. e Ranchetti, M. (1997) *Introduzione*. In Benjamin, W., *Sul concetto di storia*. Torino: Einaudi.
- Kuhn, T.S. (1962) *The Structure of Scientific Revolutions*. Chicago: The University of Chicago Press.
- Pulos, A. J. (1983) *American Design Ethic*. Boston: MIT Press.
- Tagliagambe, S. (2008) *Lo spazio intermedio*. Milano: Università Bocconi Editore.
- Tonelli Michail, M.C. (1987) *Il Design in Italia 1925/43*. Bari: Laterza.



Valorizzazione, *fundraising*, design: un'innovazione sostenibile per il patrimonio culturale italiano

Gianluca GRIGATTI*
Università degli Studi di Genova

Con la metodologia del 'design per la valorizzazione del patrimonio culturale' si vogliono configurare scenari di progetto esplicitanti un'idea di valorizzazione non intesa come applicazione di una fattispecie normativa, ma assunta come una questione progettuale. In particolare, essa costruisce la cifra etica della propria azione ponendosi l'obiettivo di perseguire la ricerca d'equilibrio tra azioni di conservazione ed azioni di fruizione.

In ottemperanza alla progettazione di questi innovativi modelli poetici la configurazione di tali scenari viene a sostanzarsi in un campo fortemente inesplorato da parte del design, ma in cui esso potrà esplicitare la propria valenza (matter).

Per attuarsi, questo indirizzo metodologico necessita di un dispositivo teso verso la realizzazione di situazioni future più efficaci ed efficienti delle attuali, in virtù del coinvolgimento di risorse umane (people raising), materiali (partnership), economiche che si identifica con il fundraising.

Tradotto in italiano con l'espressione 'raccolta fondi', il fundraising non è una questua poiché il suo nucleo centrale non coincide, esclusivamente, con la richiesta di denaro, bensì con il percorso di sviluppo che un soggetto (pubblico o privato) intende compiere e che si manifesta in un progetto di valorizzazione sostenibile poiché destinato a promuovere la conoscenza del patrimonio culturale, salvaguardandolo nell'identità ed integrità.

Keywords: Patrimonio culturale; valorizzazione; design; fundraising

'Petrolio vs ossigeno': la nuova identità del patrimonio culturale italiano.

Nel 1980 venne scritto il libro *Verfassungslehre als Kulturwissenschaft* di Peter Haeberle. Pubblicato in italiano soltanto nel 2001 da parte dell'editore

* Corresponding author: Gianluca Grigatti | e-mail: ggrigatti@leonardo.arch.unige.it

Laterza con il titolo *Per una dottrina della Costituzione come scienza della cultura*, il libro non ha lasciato indifferenti gli studiosi di diritto, anzi ha concorso a catalizzarne una divisione in materia di costituzionalismo europeo tra quanti lo definirono 'l'ultima dottrina del secolo ventesimo' ed altri per i quali era 'la prima del ventunesimo'. In ogni caso l'opera ha rappresentato l'affermazione ed il consolidamento, lungo tutta l'attività scientifica dell'autore, di un autentico programma di ricerca, tanto che per confermarne l'importanza acquisita alcuni critici come il giurista tedesco Jorg Luther si sono spinti, addirittura, a coniare l'epiteto di 'scienza haberliana delle costituzioni' (Comanducci e Guastini, 2001).

Ma a causa di quali argomenti *Per una dottrina della Costituzione come scienza della cultura* si è contraddistinto in maniera così dirompente da divenire una sorta di spartiacque nella letteratura, e non soltanto di ambito prettamente giuridico?

La risposta è imputabile alla tematica intorno alla quale si articola la riflessione di Haeberle: l'idea di cultura. Secondo l'autore, infatti, 'Se dal punto di vista giuridico un popolo *ha* una Costituzione, dal più ampio punto di vista culturale un popolo *è* in una Costituzione': considerazioni chiare, sicure, dirette, e che se proiettate in un contesto come quello italiano concorrono a (ri)portare alla ribalta un vero e proprio carattere della nostra identità civica, sancito anche in uno dei principi fondamentali della Costituzione, l'articolo 9, in base al quale: 'La Repubblica promuove lo sviluppo della cultura e la ricerca scientifica e tecnica. Tutela il paesaggio e il patrimonio storico e artistico della Nazione'.

Encomiasticamente definito da Carlo Azeglio Ciampi 'l'articolo più originale della nostra Costituzione Repubblicana', esso esplicita un principio giuridico fortemente all'avanguardia nel Diritto Comparato delle Costituzioni Europee, e rintracciabile fino al 1948 (anno d'entrata in vigore della nostra Costituzione) in due sole Carte Fondamentali: quella della Repubblica di Weimar del 1919 (poi non confluito nella Costituzione della Repubblica Federale di Germania del 1949 attualmente in vigore), e in quella spagnola del 1931.

La modernità di questo principio consiste nel riconoscimento a categorie come cultura, ricerca e sviluppo di un'appartenenza comune ed inscindibile ad un'idea di tutela non intesa alla stregua di una mera 'cristallizzazione', bensì ad un concetto di Patrimonio Culturale della Nazione fruibile proprio in quanto tutelato, come indicato nel 1976 da Massimo Severo Giannini che dalle pagine della *Rivista Trimestrale di Diritto Pubblico* notava come un Bene Culturale possa definirsi pubblico non tanto poiché di appartenenza

pubblica quanto poiché soggetto a fruizione pubblica, da attuarsi in ottemperanza alla tutela (Giannini 1976).

Nel solco tracciato da queste riflessioni si pongono anche le parole di Dario Franceschini, Ministro dei Beni, delle Attività Culturali e del Turismo che il 15 Aprile 2014 nel corso della presentazione alla VII Commissione 'Cultura, Scienza, Istruzione' della Camera dei Deputati delle linee programmatiche del Dicastero, ha elogiato la lungimiranza dei Padri Costituenti i quali,

nell'articolo 9 della Costituzione - il faro per chi lavora in questo settore – hanno messo due concetti che non sono in alcun modo in contrasto: tutela e valorizzazione, usando la parola promozione. Si può e si deve assolutamente tutelare la bellezza e l'integrità del nostro Patrimonio storico, artistico, architettonico, archeologico e archivistico e insieme valorizzarlo ai fini di una crescita complessiva del Paese, non soltanto in termini di promozione turistica. E – ha aggiunto – Per questo motivo vorrei che alla parola petrolio, che ho usato anch'io a proposito dei Paesi che hanno come materia prima le risorse petrolifere (parola che però può indurre in inganno, perché si tratta di un bene che si consuma) sostituissimo la parola ossigeno, con la consapevolezza che i Beni Culturali e le politiche culturali possono essere l'ossigeno per la nostra economia del futuro.

Quanto fin qui espresso sembra stridere se posto in relazione con la contingenza delle circostanze, per la maggior parte negative, che quotidianamente purtroppo, continuano ad abbattersi sul patrimonio culturale italiano, il quale e sembra trovarsi a rischio infarto.

Posto nel cuore di un periodo travagliato come quello attuale, e per di più contraddistinto, per quanto concerne un settore come quello dei Beni, delle Attività Culturali e del Paesaggio, dal moloch della crisi, la 'provocazione' sul rischio d'infarto a cui sarebbe soggetto il patrimonio culturale italiano trae le mosse dalla pubblicazione della versione italiana di un vero e proprio caso editoriale in tema di valorizzazione e gestione culturale: *Der Kulturinfarkt. Von allem zu viel und überall das Gleiche*, (letteralmente *L'infarto della cultura. Troppo di tutto e ovunque le stesse cose*).

Scritto da Dieter Haselbach, docente di Sociologia presso la 'Philipps Universität' di Marburgo, direttore dell'ICG Kulturplan Unternehmensberatung, ed autore nel 2006 con Armin Klein, Pius Knusel, Stephan Opitz (co-autori anche del libro in oggetto) del rapporto

sull'Economia della Cultura nella Repubblica Federale di Germania per conto del Bundestag, con *Der Kulturinfarkt* si è posto l'obiettivo di focalizzare l'attenzione dell'opinione pubblica tedesca sulla situazione culturale nazionale con particolare riferimento all'ambito teatrale, mettendo in evidenza come quest'offerta culturale fosse ipertrofica numericamente, e sostanzialmente uguale in ogni Lander per quanto concerneva i titoli delle rappresentazioni.

Nell'edizione italiana, pubblicata per conto di Marsilio Editore, pur lasciando inalterato il titolo, *Kulturinfarkt*, si è voluto adeguare il sottotitolo alla realtà del nostro Paese trasformandolo in *Azzerare i fondi pubblici per far rinascere la cultura*, ma ciò ha reso l'interrogativo ancora più urgente: il patrimonio culturale italiano rischia davvero l'infarto?

Per rispondere con cognizione di causa alla domanda è necessario chiarire il significato dei termini in questione.

L'infarto corrisponde alla morte di alcune cellule per anossia, ovvero a causa di una prolungata mancanza di ossigeno. Per mezzo del sistema circolatorio arterioso il sangue irrori tutti gli organi del corpo umano portando nutrimento (ossigeno) alle cellule. Biologicamente identificato come un tessuto liquido il plasma contiene, in percentuali variabili, una quantità di grassi i quali, in alcuni casi, possono accumularsi alle pareti interne delle arterie fino a formare delle vere e proprie placche denominate ateroma. Questo fenomeno, definito aterosclerosi, si sviluppa molto più velocemente contestualmente alla presenza di fattori di rischio quali diabete, fumo, ipertensione arteriosa, obesità, stress: tutte cause facilitanti la rottura della placca aterosclerotica con conseguente intervento delle piastrine le quali, per riparare la lesione, si organizzano fino a formare un trombo ricco di fibrina che, a sua volta, si proietta nel lume interrompendo il passaggio del sangue e, quindi, dell'ossigeno. Da qui ne consegue la morte per anossia delle cellule rimaste senza nutrimento.

Nonostante una casistica fortemente variegata, poiché una persona può essere soggetta a più infarti che possono colpirla in tempi diversi e in diverse parti del corpo oltre al cuore: intestino (infarto mesenterico), polmoni (infarto polmonare), fegato (infarto epatico), milza (infarto splenico) ed anche il cervello (ictus); e la fondamentale importanza del fattore tempo (prima l'arteria occlusa viene riaperta più piccolo sarà il danno causato dall'infarto e, quindi, maggiori le possibilità di sopravvivenza e di buona qualità di vita del soggetto, analogamente qualsiasi ritardo nel soccorso potrebbe esporre il soggetto a lesioni irreversibili con conseguente peggioramento della qualità di vita e, addirittura, rischio di morte) la ricerca

medica non ha ancora identificato un metodo di prevenzione assoluta per questa patologia, se non quello di eliminare i fattori di rischio. E dato che essi sono ascrivibili alla presenza dei grassi nel sangue, potrebbero essere identificati con l'appellativo di 'mali dell'abbondanza', mutuando questa denominazione proprio dall'ambito culturale, con riferimento all'omonimo saggio scritto dall'archeologa Andreina Ricci (1996).

Ma nel settore culturale quali sono i fattori rischio da eliminare?

Come ha indicato Marco Eugenio Di Giandomenico, docente di 'Economia ed Organizzazione Aziendale' presso il Politecnico di Milano ed autorevole esperto di valorizzazione territoriale, nel corso del convegno 'Criticità e Valorizzazione del Patrimonio Culturale' svoltosi a Firenze nel 2012:

Analizzare il rischio con riferimento ai Beni Culturali vuol dire individuare quelle azioni da porre in essere, sia da parte degli esponenti della Pubblica Amministrazione sia da parte dei semplici cittadini, in una duplice direzione: affinché si minimizzino le possibilità di verifica di eventi dannosi di qualsivoglia derivazioni (l'uso smodato del bene culturale da parte dei turisti) e, nel contempo, affinché si ottimizzino situazioni che invece valorizzino i Beni Culturali e diano smalto alle enormi opportunità economiche, sociali, culturali, di sostenibilità conseguenti da tale valorizzazione.

Infatti, sebbene indiscutibili siano i benefici prodotti da azioni di salvataggio fondate sull'applicazione di procedure normative (esempio il vincolo), si deve anche sottolineare come tale strumento non sempre sia sufficiente a garantire che il bene vincolato (e quindi conservato e tutelato), venga fruito in maniera sostenibile per le proprie esigenze, senza generare quell'ossimoro tra tutela e valorizzazione ravvisato da Antonio Godoli (2006), Direttore del Dipartimento 'Architettura ed Allestimenti Museografici' presso la Galleria degli Uffizi di Firenze:

Se si compie azione di tutela per conservare al meglio una testimonianza d'arte e di storia, la valorizzazione, che ha lo scopo di far conoscere quei caratteri d'arte e di storia, se non opportunamente controllata, rischia di comprometterli portando alla loro perdita.

Con l'introduzione della metodologia del 'Design per la valorizzazione del Patrimonio Culturale' si sta tentando di affrontare e sciogliere l'ossimoro,

configurando non solo azioni progettuali indaganti gli aspetti legati all'esperienza di fruizione, bensì innovativi e poetici (da *poiesis*, ovvero in grado di generare nuove ipotesi di senso) scenari di progetto esplicitanti un'idea di valorizzazione non intesa come l'applicazione di una fattispecie normativa, bensì assumendola in qualità di questione progettuale.

In particolare essa si pone l'obiettivo di perseguire la ricerca di un equilibrio tra azioni di conservazione ed azioni di fruizione, nel contesto delle quali viene a costituirsi la cifra etica della azione di valorizzazione stessa.

Nel solco dell'indirizzo tracciato viene a sostanzarsi un campo ancora fortemente inesplorato da parte del design ma in cui esso può, e sempre più potrà in futuro, esplicitare la propria valenza (*matter*). Ma per attuarsi a pieno questa configurazione necessita di un dispositivo, teso verso la realizzazione di situazioni riconosciute da tutti come più efficaci ed efficienti delle attuali, in virtù del coinvolgimento di risorse umane (*people raising*), materiali (*partnership*), economiche: questo dispositivo si identifica con il *fundraising*.

Il termine *fundraising* viene tradizionalmente tradotto in italiano con l'espressione 'raccolta fondi', ma tale locuzione non riesce ad esprimere totalmente il significato originario contenuto nell'espressione inglese.

Il verbo 'to raise' non è soltanto sinonimo di raccogliere, ricevere o accettare (espressione che in tal caso avrebbe avuto un'introduzione più corretta con l'ausilio dei verbi 'to collect' o 'to receive') ma racchiude in sé anche il significato di accrescere, procurare, sollevare, far salire, elevare e addirittura far risorgere. Questa considerazione induce ad avvicinarsi al *fundraising* con lo stesso atteggiamento indicato da Martin Heidegger (1968) in *Sentieri Interrotti* quando sottolinea come il fatto che

una traduzione sia semplicemente letterale non significa per ciò stesso che sia anche più fedele a ciò che è detto. Una traduzione è fedele solo se le parole parlano il linguaggio della cosa in causa.

Il *fundraising* non è una questua poiché il suo nucleo centrale non coincide, esclusivamente, con la richiesta di denaro, bensì con il percorso di sviluppo che un soggetto (pubblico o privato) intende compiere, e che si manifesta attraverso azioni progettuali atte a promuovere la conoscenza del patrimonio culturale in oggetto perseguendo, nelle migliori condizioni di conservazione e fruizione, un progetto di valorizzazione sostenibile poiché compiuto salvaguardandone l'identità e l'integrità.

Ciò pone il *fundraising* nel novero di quelle metodologie le quali, se da un lato possono ascrivere nella casistica di un design più implicito che palese, secondo quanto indicato da Hansjorg Buldiger (1993), dall'altro si ritrovano a pieno titolo nel campo d'azione del design strategico: un design che per sua natura 'sa interpretare la complessità cogliendone strutture di senso, sa indicare una strada rendendola visibile, sa comunicare e gestire i processi di condivisione delle scelte dentro l'organizzazione', come evidenzia Francesco Zurlo alla voce 'design strategico' contenuta nella versione on-line dell'Enciclopedia Treccani.

Scenari *design driven* per progetti di valorizzazione *fundraising oriented*. Alcuni casi studio.

Piuttosto che interrogarsi su cosa sia, il design dovrebbe avviare un lavoro di ricostruzione dei modi e delle norme con cui, nelle varie fasi storiche, il concetto di design si è rappresentato, tenendo conto di come esso implichi anche il definirsi della figura del designer e del suo ruolo (Pasca e Trabucco, 1995).

Con queste parole, nel 1991, terminava l'*open lecture* presentata da Vanni Pasca al 1° Convegno internazionale di studi storici sul design incentrato sul tema 'Storia e storiografia'. Sebbene siano trascorsi quasi 25 anni da quella data, e nonostante la riflessione degli storici, dei designer e degli architetti invitati fosse indirizzata sulla natura e sulla situazione degli studi storici in Italia, quanto affermato da Pasca può contestualizzarsi anche ad un campo come quello in oggetto nel quale il design, parafrasando quanto affermato da Salvatore Settis nel corso del suo intervento al Convegno Nazionale del F.A.I.-Fondo Ambiente Italiano del 2006, si pone sulla stessa lunghezza d'onda di tutela, gestione e valorizzazione in quanto 'momenti intimamente connessi di un processo unico, [e] che hanno senso solo se ispirati da un'istanza unificante: la ricerca conoscitiva sui beni da tutelare e gestire'.

Nell'ottemperanza di tale indirizzo si pongono quindi i casi studio relativi all'anfiteatro Flavio di Roma (Colosseo) e agli scavi archeologici di Ercolano la cui configurazione di progetti di valorizzazione *fundraising oriented* sembra potersi innestare poetici scenari *design driven*.

Il progetto di restauro e valorizzazione del Colosseo si svolse in un primo atto nel 1994 quando il Gruppo Bancario Banca di Roma mise a disposizione

la cifra di 40 miliardi di lire per la pulitura dei 3 ordini di forniche che contraddistinguono l'intera altezza dell'Anfiteatro.

Successivamente a quell'esperienza, si è dovuto aspettare fino al 4 agosto del 2010 quando sulla Gazzetta Ufficiale e, contemporaneamente, su alcuni quotidiani nazionali, è stato pubblicato da parte del Commissario della Soprintendenza Speciale al Patrimonio Archeologico di Roma e di Ostia antica un avviso pubblico per la ricerca di sponsor per il finanziamento e la realizzazione dei lavori del piano di interventi messi a punto dal suddetto Ente responsabile della tutela. Il piano di interventi prevedeva: la sostituzione dell'attuale sistema di chiusura delle arcate perimetrali (forniche) con cancellate, il restauro dei prospetti settentrionale e meridionale, il restauro degli ambulacri, il restauro dei sotterranei (ipogei), la messa a norma e l'implementazione degli impianti, la realizzazione di un centro servizi nell'obiettivo di 'esternalizzare nella piazza del Colosseo' le attività di supporto alla visita (accoglienza, biglietteria, bookshop, servizi igienici) posti, attualmente, all'interno del monumento

Nonostante un primo notevole interesse da parte di vari soggetti (ben 19 avevano chiesto di accedere alle carte del bando) entro la data di scadenza per l'invio delle proposte (30.10.2010) avevano partecipato solo 2 gruppi: il Gruppo Tod's e Ryanair, ma dopo un attento esame nessuna delle 2 offerte avanzate venne ritenuta conforme ai requisiti richiesti.

A quel punto il Commissario della Soprintendenza Speciale al Patrimonio Archeologico di Roma e di Ostia antica aveva 4 possibilità: sospendere la procedura e astenersi dal procedere, in attesa di migliori condizioni di mercato; prorogare il termine per la presentazione delle offerte; rivedere i termini dell'avviso pubblico; e, infine, procedere a trattativa privata essendo assolto con la pubblicazione del bando nell'agosto 2010 l'onere pre-concorrenziale di trasparenza

Il Soggetto attuatore decise di intraprendere quest'ultima strada innescando una procedura negoziata con 3 soggetti: i due che avevano precedentemente concorso ovvero, il Gruppo Tod's e Ryanair, più un terzo soggetto: IDeA FIMIT SGR S.p.A, società italiana e uno tra i leader europei nella gestione di fondi comuni di investimento immobiliare.

Conclusasi il 21 gennaio 2011 la trattativa ha assegnato la vittoria della sponsorizzazione al gruppo Tod's a fronte di un'offerta di 25 milioni di Euro per i lavori.

Il caso del Colosseo avrebbe potuto rappresentare, non soltanto per l'importanza del monumento a livello internazionale, l'autentico ed archetipico caso di uno scenario *design driven* su un progetto di

valorizzazione *fundraising oriented* se, fin dalla composizione del Bando da parte della Soprintendenza Speciale per i Beni Archeologici di Roma ed Ostia Antica, si fosse perseguita proprio la ricerca di un progetto di fundraising rispetto ad uno di sponsorizzazione tradizionale, per di più identificata, in un primo tempo, come sponsorizzazione tecnica, ovvero in cui lo sponsor s'impegna, oltre che a erogare un contributo, a svolgere anche l'attività di progettazione e realizzazione dell'intervento, ma poi, a seguito del passaggio a trattativa privata tramutatasi in sponsorizzazione pura e risolta con l'esclusiva erogazione di un contributo in denaro in cambio dello sfruttamento degli spazi a fini commerciali, differentemente da ciò che, contemporaneamente stava avvenendo a poca distanza dall'Area Archeologica Centrale: al Quirinale e con la partecipazione del gruppo farmaceutico Bracco S.p.A. attraverso la propria Fondazione.

A partire dal 2001 e, successivamente, dal 2006 al 2011, è avvenuto ad opera della Fondazione Bracco il recupero e la valorizzazione del ciclo raffigurante le storie dell'Antico Testamento dipinte da Pietro da Cortona nel 1656.

Nel 2001, in occasione della messa a norma di alcuni impianti elettrici nella Sala degli Ambasciatori posta al piano nobile del Palazzo del Quirinale, furono eseguiti alcuni saggi sulle strutture murarie: una sorta di carotaggi esplorativi compiuti prima di ogni intervento al fine di verificare lo stato della situazione nell'area in oggetto. Grande fu l'emozione nello scoprire che sotto le superfetazioni napoleoniche vi erano tracce di decorazioni del Seicento perfettamente conservate ed appartenenti ad uno degli esempi più importanti a livello mondiale di barocco romano, noto fino a quel momento soltanto grazie ai disegni cortoneschi conservati alla Kunstbibliothek di Berlino. Si trattava, infatti, della Galleria di Papa Alessandro VII Chigi (come attestante dalla data '1656' dal nome del committente 'Alexander VII-Pontifex Optimus Maximus' ritrovata sotto la finestra dell'attigua Sala di Augusto): un salone lungo più di 60 mt intervallato da una serie di Sale (Sala degli Ambasciatori, Sala di Augusto o del Trono e la Sala Gialla) affrescate dal più importante esponente del barocco romano, Pietro da Cortona, e posto come cardine della cosiddetta ala Sista.

Conclusosi nel 2011, il recupero del ciclo cortonesco è stato reso possibile dall'intervento della Fondazione Bracco che qui ha intrapreso un percorso di *fundraising* contrassegnato dall'applicazione delle metodologie del progetto 'Art from inside', mutuante quelle già sviluppate e sperimentate dal Gruppo Bracco stesso nel campo della diagnostica medica con la denominazione di 'Life from inside' ed aventi l'obiettivo di portare il

fruitore ad entrare 'dentro' l'opera pittorica, secondo quanto compiuto dalla stessa fondazione in altri capolavori dell'arte italiana: come quelli di Fra Carnevale, Bellini, Giorgione e Tiziano.

Il caso della Fondazione Bracco non rappresenta un episodio isolato, ma uno tra quelli che hanno fatto scuola, anzi *storia* nel campo della tutela del patrimonio culturale italiano contestualmente al progetto del sito archeologico di Ercolano.

L'Herculaneum Conservation Project è un progetto pubblico-privato iniziato nel 2001 per la conservazione e la valorizzazione del sito archeologico di Ercolano.

Avviato da David W. Packard (Packard Humanities Institute) con Pietro Giovanni Guzzo (già Soprintendente Archeologo di Pompei), e redatto da Andrew Wallace-Hadrill (Direttore della British School at Rome) invitato ad assumerne la direzione sotto l'egida di un Comitato Scientifico di importanza internazionale, il progetto sta tracciando una nuova strada nell'obiettivo di dimostrare che, con il giusto peso dato alle qualità ed alle metodologie conservative più efficienti, contestualmente all'applicazione efficace delle normative in materia di Beni Culturali, il coinvolgimento dei soggetti privati può aprire nuove potenzialità nel campo della conservazione e della valorizzazione.

Nel caso di specie, in particolare la strategia di *fundraising* consiste nella definizione di azioni progettuali destinate ad assicurare, a lungo termine, la sopravvivenza della città antica intervenendo con operazioni di ricerca, restauro e messa in sicurezza delle strutture archeologiche combattendo il fenomeno del degrado molto rapido in questo tipo di situazioni. Tale azione si è estesa anche 'extra moenia' lungo tutta l'area dell'Ercolano moderna e contemporanea restituendo 'gli scavi alla città', migliorando l'esperienza di fruitiva dei visitatori che ogni anno fanno tappa nella città vesuviana.

Oltre a tratteggiare un possibile scenario futuro l'illustrazione di questi casi si pone anche l'obiettivo di sottolineare la necessità e l'urgenza di recuperare l'antica filosofia che l'ideatore del Ministero, Giovanni Spadolini, pose nel 1974 alla base dell'istituzione stessa del Dicastero, e che si trova scritto nelle carte personali del Professore conservate presso la Biblioteca della sua villa (ora Fondazione) a Pian dei Giullari: l'idea di creare non tanto un Dicastero dei Beni Culturali ed Ambientali quanto un *Ministero per i Beni Culturali ed Ambientali*: differenza che se a primo acchito può apparire alla stregua di un sofisma puramente grammaticale, esplicita invece la sua ferma ed autorevole caparbia nella creazione: 'Non [...] di un centro di potere, ma di un centro d'iniziativa intellettuale e politica, il più possibile

sburocratizzato, il più possibile tecnico. Quasi un'agenzia in senso anglosassone' (Ceccutti, 2012).

Ed è nel contesto di questa *futura factory* che il design potrà esplicitare tutta la propria valenza strategica (*matter*).

References

- Buldiger, H. (1993) *Sconosciuti e familiari: oggetti di design anonimo prodotti in Svizzera dal 1920*. Milano: Hoepli edizioni.
- Ceccutti, C. (2012) Giovanni Spadolini e la nascita del Ministero per i Beni Culturali. In Ragusa, A. (a cura di), *La Nazione allo specchio*. ManduriaBari-Roma: Piero Lacaita Editore.
- Comanducci, P. e Guastini, R. (2001) *Analisi e diritto: ricerche di giurisprudenza analitica*. Torino: Giappichelli.
- Giannini, M.S. (1976) I beni culturali. *Rivista Trimestrale di Diritto Pubblico*, 1/1976.
- Godoli, A. (2006) Beni Culturali e apporto del design. *Sistema Design Italia* (SDI | view 03_marzo 2006).
- Haerberle, P. (2001) *Per una dottrina della Costituzione come scienza della cultura*. Roma: Carocci.
- Haselbach, D., Klein, A., Knusel, P. and Opitz, S. (2012) *Kulturinfarkt. Azzerare i fondi pubblici per far rinascere la cultura*. Venezia: Marsilio 2012.
- Heidegger, M. (1968) *Sentieri interrotti*. Firenze: La Nuova Italia.
- Packard, D.W. (2013) Salvo Herculaneum assieme agli italiani. In *Il Sole 24 Ore*, 27/10/2013.
- Pasca, V. e Trabucco, F. (a cura di) (1995) *Design: storia e storiografia. Atti del 1° Convegno internazionale di studi storici sul design*. Bologna: Progetto Leonardo.
- Ricci, A. (1996) *I mali dell'abbondanza. Considerazioni impolitiche sui beni culturali*. Roma: Lithos.
- Settis, S. (2005) *Battaglie senza eroi. I beni culturali tra istituzioni e profitto*. Milano: Electa.



Identità visive generative. Programmare la corporate identity

Francesco E. Guida*
Politecnico di Milano

Nei processi progettuali nell'area disciplinare del design della comunicazione visiva l'utilizzo della programmazione informatica sta determinando interessanti cambiamenti. In particolare in questo paper si intende concentrare l'attenzione sul fenomeno del generative design applicato allo specifico ambito del progetto di identità visiva. In anni recenti infatti si sono moltiplicati i casi di identità visive, spesso definite come dinamiche o post-logo, in cui alla sedimentata e convenzionale applicazione ripetitiva di un elemento visivo di riconoscibilità come il marchio si preferisce l'adozione di linguaggi maggiormente fluidi ed espressivi, sempre più frequentemente mediante l'utilizzo di software programmati ad hoc.

Attraverso il ricorso a casi studio tratti da applicazioni professionali e dalla sperimentazione didattica si intende fornire un contributo alla riflessione su quella che si ritiene una direzione evolutiva del 'mestiere del grafico'.

Keywords: *Generative design; corporate identity; identità visiva; design della comunicazione*

Introduzione

Nei processi progettuali di designer, architetti e artisti visuali l'utilizzo dei computer e dei relativi *tool*, come potremmo definire i software, è ad oggi pratica estesa nella concezione e nella produzione di forme. Principalmente viene però utilizzato software proprietario, le cui possibilità sono limitate agli usi previsti dagli sviluppatori dei pacchetti e per l'utilizzo di metafore visive come il tavolo da disegno nei sistemi CAD. Queste limitazioni, che si riflettono ironicamente nell'espressione 'form follows software' (Télez e Bohórquez, 2011) hanno evidenziato la necessità di sperimentare nuovi utilizzi che sfruttino pienamente le possibilità offerte dalla programmazione

* Corresponding author: **Francesco E. Guida** | e-mail: francesco.guida@polimi.it

open source, ovvero nell'uso di codici sorgenti liberi da diritti. Reas (2010) esprime efficacemente questo concetto: 'Proprietary software products are general tools designed for the production of specific types of forms [...] To go beyond these limitations, it is necessary to customize existing applications through programming or to write your own software'. Una tensione che Galanter (2003) sintetizza così: 'It was seemingly inevitable that soon after the adoption of the computer by designers as a manual tool for CAD, there would follow the adoption of genetically inspired algorithms for the creation and selection of variations'.

In queste parole è indicata di fatto una direzione che si registra da una decina d'anni in molti ambiti del progetto e in particolare in quello di comunicazione visiva e che è propria di quella che si è definita come Generazione Y (ovvero dei nati tra il 1980 e il 1996) per i quali l'utilizzo della tecnologia è naturale se non ovvio (Wicht, 2011). L'intrigante scenario attuale vede quindi designer grafici utilizzare la programmazione nella definizione e nella costruzione di progetti di identità visiva i cui risultati sono caratterizzati da variabilità, flessibilità, dinamicità e molteplicità delle forme.

La peculiarità di tale fenomeno, oltre l'utilizzo della programmazione, è la definizione di un codice genetico formale, di un sistema di regole di base e di gestione delle forme stesse. Questi elementi permettono di associare a un simile fenomeno –come si vedrà a seguire– il termine di *generative design*.

Sulla definizione di *generative design*

Il fenomeno del *generative design*, il quale ha acquisito oramai una sua autonomia e autorevolezza negli ambiti progettuali e artistici in particolare, in realtà non è qualche cosa nato con il computer, per quanto l'utilizzo di strumenti informatici ne rende estremamente efficace in termini di risultati l'approccio metodologico. Secondo Galanter (2003) l'arte generativa (*generative art*) si riferisce a quelle pratiche in cui l'artista utilizza un sistema, un set di regole, come anche un programma informatico o una macchina, o comunque una qualsivoglia invenzione procedurale che permetta di avere un certo grado di autonomia nella costruzione o nella completa definizione di un'opera. Tale definizione enfatizza il ruolo proattivo dell'artista nella definizione di regole o linee-guida che consentono di produrre molteplici soluzioni coerenti con il *framework* (Wicht, 2011). Questo approccio è proprio delle pratiche del *generative design*. Quando questo è applicato ad esempio al contesto del progetto di

identità visiva il designer definisce un sistema più o meno articolato di regole sulla base di parametri in grado di produrre molteplici variazioni formali, talvolta non prevedibili in tutte le loro possibili varietà. Sempre Galanter (2012) sostiene che ‘generative art happens when the artist give some part of control to another system so as the result would differ from an art creation of spontaneous decisions of an artist’. Negli ambiti del *generative design* questo altro sistema è rappresentato dagli ambienti di programmazione informatici, che per definizione sono in grado di generare una molteplicità di soluzioni formali, di impostare processi di automazione e ripetizione, di scalabilità e variazione (Manovich, 2001). Sistemi che sono però da intendersi come strumenti di facilitazione del processo creativo, dal momento che consentono di dedicare più tempo alla sperimentazione, alla ricerca, che alla produzione, e il risultato finale può essere di maggiore soddisfazione per il designer e comunque coerente con le ambizioni e le richieste progettuali (Reas, 2010).

Il designer non è più solo utilizzatore di *tool* digitali prefabbricati ma diviene programmatore di *toolbox* digitali personalizzate (sviluppate ad esempio con *Processing* o *VVVV*, entrambi ambienti *open source*) (Bohnacker et al., 2012). Questo cambia se non il processo progettuale per lo meno il ruolo del designer stesso. Per quanto il ruolo della tecnologia appaia rilevante però le questioni tecniche restano sullo sfondo a favore dell’astrazione e della parametrizzazione di dati, quindi di un piano meta-progettuale. L’introduzione della programmazione nei processi creativi e progettuali, in particolare nell’ambito del design della comunicazione visiva, arricchisce le possibilità del designer, liberato dalle costrizioni di strumenti predefiniti e con una maggiore libertà creativa nella costruzione di metafore visive (Duro et al., 2012). Il ruolo del designer è quindi quello di chi definisce i parametri di generazione formale senza però perdere di vista, nell’ambito che ci riguarda, l’obiettivo principale di un sistema di identità visiva, ovvero la identificazione e la riconoscibilità di una organizzazione (Télliez e Bohórquez, 2011).

La corporate identity: tradizione vs innovazione

Nell’area disciplinare del design della comunicazione le principali applicazioni del *generative design* sono per la visualizzazione di dati (*information graphics*) o, è ed ciò che interessa maggiormente, per le identità visive flessibili. Proprio negli ultimi anni infatti si sono moltiplicati i casi di identità visive, spesso definite come ‘fluide’ (Lapentino, 2011),

dinamiche o *post-logo*, in cui alla sedimentata e convenzionale applicazione ripetitiva di un elemento visivo di riconoscibilità come il marchio si preferisce l'adozione di linguaggi maggiormente fluidi ed espressivi, caratterizzati da variabilità, riferimento al contesto, processualità, performabilità, non-linearità, coerenza e varietà (Felsing, 2010).

Si registrano quindi delle tendenze di pensiero e di atteggiamento progettuale che tendono all'innovazione: 'il brand non è più semplicemente un logo bello e pulito che si attacca nello stesso posto ogni volta. Il brand è una piattaforma, il brand è flessibile, il brand è un luogo di scambio, e non è fisso, per cui non vi è un unico marchio. Vi sono modalità che consentono di avere una forma, una comunicazione e dei comportamenti riconoscibili, ma non si tratta più di qualche cosa di costretto e fissato' (Shaughnessy, 2008).

La classica struttura della corporate identity, quindi della rappresentazione di un soggetto mediante una serie di elementi primari – primo fra tutti il marchio– e sussidiari la cui espressione normativa è nel manual (Henrion e Parkin, 1967; Anceschi, 1985), viene riattivata dall'adozione di strumenti e processi di costruzione formale più vicini a matrici meta-progettuali che segnano il passaggio da sistemi chiusi a sistemi aperti (Ciuccarelli, 2007).

Inoltre il progettista può programmare non solo le due o le tre dimensioni, ma anche la quarta, quella del tempo che modifica il manifestarsi di una image, non più in un modo semplicemente controllato ma, appunto, programmato. Secondo paradigmi, non nuovi per quanto estremamente attuali (già nella seconda metà degli anni Sessanta si registrano casi di identità visive flessibili: Chiappini e Cioffi, 2006), più vicini ai metodi divergenti 'interessati alla produzione di molteplicità, di varietà' e meno al pensiero convergente, operazionalista e pragmatista; più vicina all'approccio soft beherensiano, dell'house-style, in cui sovente il progettista diventa corresponsabile o almeno fiduciario del manager, e meno al manual inteso come 'strumento tecnico-burocratico' (Anceschi, 1981).

I logo-generator

Date queste premesse, osservando il panorama della produzione internazionale si possono individuare alcuni casi in cui il progetto del marchio o del sistema visivo interpreta in modo coerente questa idea di una multidimensionalità della *brand*. In particolare si registra una tendenza al progetto di *toolbox*, definite come *logo-generator*, che consentono di

impostare un numero più o meno finito di variazioni di un segno base da utilizzarsi come marchio di identificazione. La definizione delle variazioni viene gestita secondo un approccio marcatamente metaprogettuale, in cui si privilegia il progetto del processo al fine di garantire il controllo sull'identità complessiva, di quelle 'manopole di comando' che generano la varietà e che garantiscano le costanti dell'identità (Ciuccarelli, 2007).

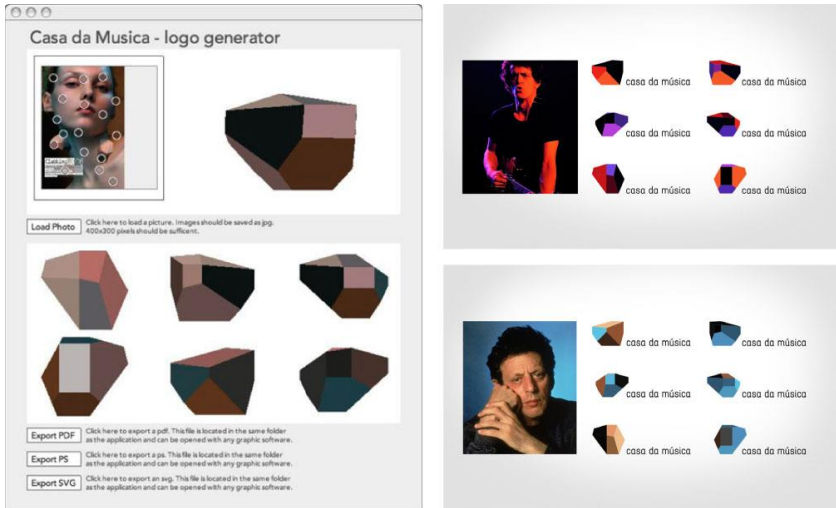


Figura 1 Logo generator –sviluppato in Processing– per la Casa da Música, design Sagmeister (2007).

Da un punto di vista cronologico uno dei primi è quello per la Casa da Música di Oporto (Portogallo) ideato da Stefan Sagmeister (2007) che consente di gestire il marchio – chiaramente ispirato alla forma dell'edificio progettato da Rem Koolhaas – da differenti prospettive (sei in totale).

Il marchio si trasforma nelle varie applicazioni, cambia da media a media e analogamente possono cambiare i colori (figure 1). Trattandosi di una istituzione il cui obiettivo è di ospitare differenti iniziative legate al mondo della musica (dal jazz, alla musica classica, alle espressioni più contemporanee), rivolte a pubblici differenti, l'identità visiva non può essere statica. Il sistema messo a punto da Sagmeister infatti consente di selezionare da immagini tematiche una palette di colori personalizzata per l'evento o l'iniziativa specifica. Analogamente vengono gestite alcune applicazioni istituzionali: per il personale interno, ad esempio, i biglietti da visita hanno come elemento di personalizzazione il marchio i cui colori sono

ripresi da una fotografia della singola persona. Il sistema quindi offre una varietà di soluzioni sia a chi l'identità la deve gestire nel quotidiano che a chi l'identità la fruisce.

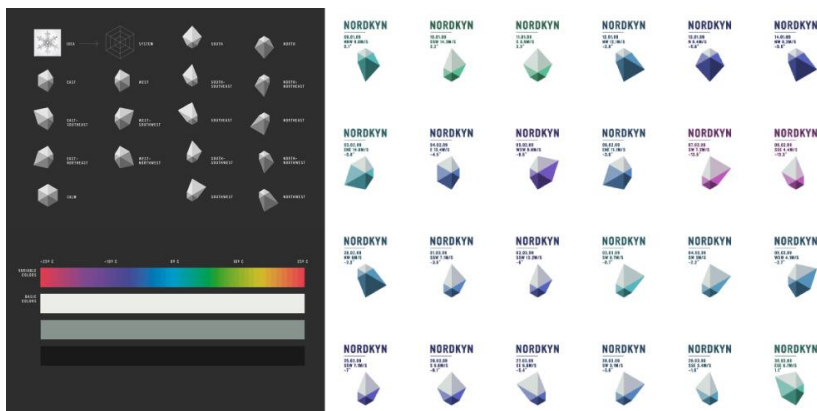


Figura 2 Il marchio variabile per Nordkyn, Neue Design (2009).

Un altro caso è quello dell'identità visiva per la penisola di Nordkyn, posta all'estremo nord della Norvegia, non lontano dal Circolo Polare Artico, e in cui vi si trovano due piccoli paesi (Gamvik e Lebesky). Le due municipalità hanno sviluppato una comune strategia per la promozione turistica.

Il paesaggio della penisola offre uno scenario straordinario in condizioni climatiche estreme. Lo studio di Oslo, Neue Design (2009), ha basato la sua proposta su due principali ingredienti: il payoff 'Where nature rules' e i dati meteorologici del Norwegian Meteorological Institute che modificano la forma del segno base del marchio in base alla direzione del vento e ai cambi di temperatura (figure 2). Sul sito web il marchio si aggiorna ogni cinque minuti, mentre per le altre applicazioni Neue Design ha sviluppato un logo generator attraverso cui l'ente gestore Visit Nordkyn può scaricare il marchio aggiornato in tempo reale alle condizioni climatiche. I parametri di riferimento che modificano il marchio e di conseguenza la retorica dell'identità visiva sono quelli non controllabili legati al clima, cosa che di fatto determina una difficilmente definibile in termini numerici varietà di forme, pur su una struttura piuttosto rigida di costruzione della forma base.

L'input al software arriva quindi da dati, informazioni, *real-time* e l'identità riflette il mondo circostante e si adatta ai suoi cambiamenti, il marchio diventa vivo (van Nes, 2012).

Probabilmente il più noto è quello per il Mit Media Lab (Thegreeneyl, 2011), il cui marchio è basato su un algoritmo che produce un marchio unico per ciascuna facoltà, per ogni membro dello staff e ogni studente (figure 3).

Per consentire a ciascuna persona di scegliere e utilizzare il proprio marchio (su biglietto da visita, carta da lettera, o pagina web personale) è stata creata una pagina web che consente di creare anche animazioni personalizzate. I caratteri unici del Media Lab sono sintetizzati nel marchio, in cui ciascuna delle tre forme sta a indicare i contributi individuali mentre la combinazione delle tre forme base visualizza metaforicamente i risultati del processo di ricerca in una costante ridefinizione di cosa significano oggi i media e la tecnologia (van Nes, 2012). In questo caso quindi sono valori intangibili a ispirare il segno e le variazioni dipendono da chi poi quel segno deve utilizzarlo in rappresentanza dell'istituzione.

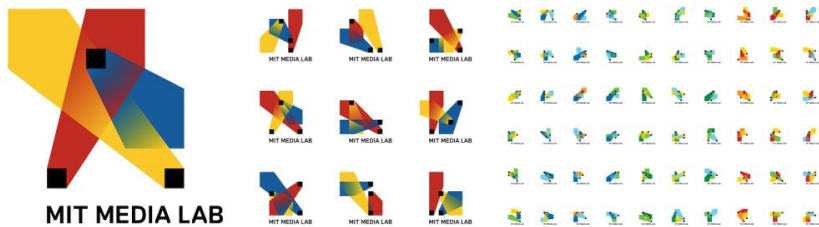


Figura 3 Le variazioni del marchio per il Mit Media Lab, design Thegreeneyl (2011).

Numerosi sono ancora i casi che si potrebbero citare. Ma per segnare su una ipotetica mappa anche la presenza dell'Italia se ne vogliono menzionare due. Il primo è Index Urbis dello studio pugliese FF3300 per la Festa dell'Architettura di Roma (figure 4), per il quale è stato predisposto un software in grado di 'tradurre in segno la complessità delle morfologie urbane, di restituire pezzi di epoche diverse che convivono nello stesso spazio, di raccontare la molteplicità e la continua variabilità dell'Urbe.

'Non vi è alcun risultato finale, solo una successione continua di fasi' (FF3300, 2010). Dove il segno che muta costantemente nelle varie applicazioni è tipografico, un logogramma variabile.



Figura 4 Il logogramma variabile per il Festival dell'Architettura di Roma, design FF3300 (2010).

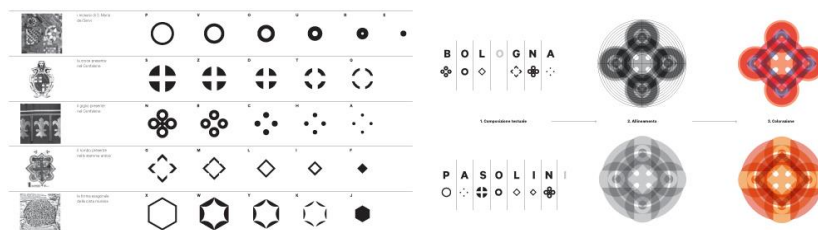


Figura 5 L'alfabeto visivo e alcune variazioni del programma di identità per 'è Bologna', design Bartoli e Pastore (2013).

Il secondo è relativo al recente progetto per la brand di promozione culturale e turistica di Bologna (2013), ad opera di Matteo Bartoli e Michele Pastore. La ricchezza di elementi e valori tangibili e intangibili, le infinite sfaccettature e le infinite percezioni della città, sono alla base di un sistema di scrittura che sostituisce ai grafemi dell'alfabeto latino dei segni astratti caratterizzanti riconducibili a un immaginario storico tipicamente italiano. Le forme infatti riprendono liberamente alcuni archetipi figurativi della città italiana e più specificatamente di Bologna (come la cinta muraria, il mattone mosaico, il giglio e la croce del gonfalone araldico cittadino, etc.).

Questo alfabeto di segni permette di scrivere, attraverso un software apposito (e disponibile in versione beta su <http://ebologna.it/>) a chiunque cosa 'è Bologna', facendosi parte attiva del processo di costruzione dell'identità visiva della città. Per dirla con le parole di uno dei due progettisti 'non si tratta solo un di sistema d'identità adattivo e flessibile, [...] ma anche partecipativo' (Bartoli, 2013).

Una sperimentazione progettuale

Coerentemente con l'ambito di applicazione e sperimentazione progettuale fin qui descritto, si è impostato il tema d'anno per un Laboratorio di Sintesi Finale del Corso di Laurea in Design della Comunicazione Visiva (a.a. 2013-2014). L'obiettivo dato era quello di progettare sistemi di identità visiva per luoghi, organizzazioni o eventi interpretandone visivamente la ricchezza, la pluridimensionalità, la molteplicità degli aspetti, l'eventuale riferimento al contesto. La classe è stata organizzata in una quindicina di gruppi, ciascuno dei quali aveva in carico un tema (dalla nazione all'evento sportivo, dall'esercito al sistema valutario, al partito politico) da sviluppare prima definendone l'articolazione, gli obiettivi, i valori, quindi concettualmente e poi progettualmente, lavorando sui canali e gli strumenti comunicativi.

Ciascun progetto doveva sviluppare gli elementi di base dell'identità visiva programmandone (mediante VVVV) le variazioni, quindi definendo *a priori* i criteri, le modalità e i parametri che avrebbero determinato tali variazioni.

A titolo esemplificativo se ne menzionano due a dimostrazione delle possibilità e della ricchezza di questo ambito di sperimentazione progettuale.



Figura 6 Il sistema di identità visiva per una micronazione e, a destra, alcune variazioni della bandiera generativa, design M. Posani, G. Ponzetta, E. Sciolto (2014).

Per il progetto dell'identità visiva per una ipotetica micronazione hacker localizzata in un gruppo di piccole isole scandinave (le Westman Islands, a sud dell'Islanda), il codice visivo si basa su due elementi: un alfabeto di segni ispirato ai *Vegvisir* (il talismano-bussola usato dai vichinghi che si mettevano in viaggio per mare) e un elemento grafico di coordinamento (ispirato al *glitch*, l'errore informatico che distorce la visualizzazione delle immagini *bitmap*). I simboli base del *Vegvisir* sono stati sviluppati come un alfabeto, in cui le lettere sono composte da variazioni riconoscibili dei simboli di partenza, che si può usare per comporre –dall'alto verso il basso giustificando i segni centralmente– parole o per rappresentare i singoli cittadini (in una sorta di codice fiscale segnico). L'elemento di coordinamento ispirato al *glitch* è stato sviluppato programmando un software che modifica le forme in base a input sonori: due rettangoli centrali variano in base al volume e al tono complessivo dell'audio, seguendo la voce di uno speaker vicino al microfono ricevente; i pixel di 'disturbo' aumentano di numero e concentrazione seguendo il rumore di fondo (ad esempio un ambiente che si riempie di persone), distribuendosi in maniera randomica (figure 6). Tale applicazione genera elementi visivi da utilizzarsi come bandiera digitale da proiettarsi in situazioni collettive – momenti di voto o di riunione pubblica– che si modifica in base al numero di persone e al rumore che producono. Una rappresentazione visiva e percepibile della partecipazione all'esercizio della democrazia.



Figura 7 Il marchio variabile e la sua applicazione a indicatori visivi da display per Nyvold, design M. Biasibetti, M. Cominardi, S. Corini, A. Croci (2014).

L'altro esempio riguarda invece un tema di tutt'altro genere: una organizzazione farmaceutica produttrice di farmaci ispirati alle pratiche

alchemiche medievali e denominata Nyvold (parola composta dai termini islandesi *ny* e *völd* e il cui significato è 'nuovi poteri'). La forma base del marchio prende spunto dalla pietra filosofale ed è rappresentato con un decaedro. Mediante una applicazione sviluppata appositamente il marchio assume tridimensionalità ricevendo e traducendo in forme geometriche di tre differenti colori che si sovrappongono tra di loro i dati relativi alla temperatura corporea, alla frequenza cardiaca, all'idratazione della pelle. Il marchio rappresenta visivamente i *feed* relativi ai cambiamenti di stato di chi utilizza i farmaci, visualizzando un temporaneo contatto tra chi comunica e produce (l'organizzazione) e chi riceve e usa i prodotti (gli interlocutori). Inoltre il segno di identificazione si modifica, pur mantenendosi riconoscibile, in base a dati variabili come una info-grafica da *display* (figure 7).

Conclusioni

Se in precedenza nel progetto di identità visiva –diciamo fino a tutti gli anni '90, fatte alcune eccezioni– il *modus operandi* era sostanzialmente invariato nel passaggio dall'analogico al digitale, in quella che è stata definita come 'epoca della transizione' (Baule, 2011), oggi si possono riscontrare alcuni cambiamenti. Ovvero tradizionalmente un progettista di comunicazione visiva (il 'grafico') nel progettare un marchio o una identità visiva articolata sintetizza visivamente contenuti e valori relativi a una organizzazione mediante l'utilizzo di segni, realizzati con gli strumenti propri del 'mestiere'. Se in precedenza erano matite, pellicole fotografiche, etc. e poi con i primi computer i software di elaborazione grafica oggi, dato il medesimo punto di partenza, i risultati non sono necessariamente degli *artefatti* visivi piuttosto dei *dispositivi* che producono artefatti visivi.

In questo si ritiene vi sia una prima innovazione: il progettista di comunicazione visiva interviene nel processo progettuale definendo non solo le regole (il set di regole, il *framework*) attraverso cui una identità visiva deve essere formalizzata, ma lo strumento stesso che consente tale formalizzazione. Non utilizza quindi 'passivamente', con margini relativi in termini di risultato, il software, lo strumento del mestiere, ma lo progetta piegandolo alle proprie necessità, in termini di risultato formale e di interpretazione dei contenuti / valori a cui dare un volto. Quindi vi è una innovazione del processo creativo di artefatti estetici e funzionali, quali possono essere definiti gli elementi di una identità visiva. Del resto ancora Galanter (2003, p. 6) sottolinea che 'Generative art refers to a way to create

art rather than an art style'. L'innovazione non è tanto nel risultato, quanto nel processo.

Da un punto di vista meramente formale, l'utilizzo dei software di elaborazione grafica non ha prodotto fino ad oggi artefatti molto differenti rispetto al passato. Le regole di istruzione di una identità visiva sono restatesi immutate –un marchio, definito in bianco e nero e a colori, in positivo e in negativo, un set di colori di base (generalmente due, talvolta qualcuno in più), due famiglie tipografiche di riferimento e così via–, quindi una organizzazione degli elementi visivi estremamente rigida, sulla base di un set di regole di combinazione e di utilizzo predefinite. Leggeri cambiamenti sono intervenuti in termini formali con l'utilizzo delle trasparenze, ad enfatizzare quella suggestione 'liquida', immateriale, dell'ambiente digitale (quel *multiply* che simula la sovrastampa offset), o la resa tridimensionale dei marchi mediante l'utilizzo di sfumature e gradienti di colori (un effetto né più né meno efficace di quanto si poteva ottenere con un aerografo utilizzato da mani sapienti). Il progettista è quindi 'costretto' da un punto di vista compositivo e formale in un recinto di possibili soluzioni suggerite dagli strumenti che ha a disposizione che simulano, riproducono con precisione e all'infinito sostanzialmente strumenti e modalità analogiche.

L'utilizzo della programmazione e comunque di un approccio di tipo generativo al progetto consente di definire lo strumento e formalmente si possono avere, stabilite le regole di partenza e di combinazione degli elementi, risultati inattesi, non previsti. Assumendo, nella pratica, un atteggiamento che Donald Schön ha definito di 'pratica riflessiva', quindi fortemente rivolto alla sperimentazione procedurale e formale. Dove per sperimentazione si intendere 'un modo per provare qualcosa, di giocare. Si tratta di innovazione ma non è sempre formalizzata né vi si trovano delle regole. [...] I risultati potranno fornire indicazioni di strategie o metodi attraverso cui designer [...] approcciano le loro attività' (Triggs, 2003).

È da sottolineare, infine, che vi è una prevalenza di ambito di applicazione di un approccio *generative oriented* al progetto di identità visiva, in particolare a quelli cui appartengono organizzazioni che necessitano di impostare differenti toni comunicativi verso pubblici differenti o comunque di rappresentare in modo evidente la pluridimensionalità della propria personalità come un valore da condividere.

Ed è per questo che molti casi mostrati nelle pagine precedenti fanno riferimento a organizzazioni culturali, di pubblico interesse e anche a territori o città.

Quanto emerge da queste considerazioni è che il designer di comunicazione visiva (il 'grafico' di un tempo) necessita l'acquisizione di una nuova conoscenza che determina una nuova competenza. Una figura professionale, la cui autorevolezza è stata messa in discussione dalla diffusione dei software di elaborazione grafica e dalla loro semplificazione, con un approccio trasversale dal punto di vista del metodo e della *technicality*, può acquisire un nuovo sapere. Ma per far questo deve rivestire i panni dell' 'artigiano' così come lo ha definito Sennett (2008).

Ringraziamenti

L'autore intende rivolgere un sentito ringraziamento ai proff. Andrea Braccaloni, Pietro Buffa, Alessandro Masserdotti (e quindi ai cultori Ambhika Samsen, Andrea Novali e Francesca Bozzia), docenti e colleghi del Laboratorio di Sintesi Finale del Corso di Laurea in Design della Comunicazione, Scuola del Design del Politecnico di Milano (a.a. 2013-2014), con i quali è stato possibile avviare e condividere una sperimentazione di metodo e di pratica progettuale attuale, non agevole e coraggiosa. Di conseguenza un pensiero va anche a tutti gli studenti che hanno avuto l'ardire di accettarne la sfida e seguirne, con passione e partecipazione, gli sviluppi.

Riferimenti bibliografici

- Anceschi, G. (1985) Image: il corpo mistico dell'organizzazione. *LineaGrafica*, 1, 34-39.
- Anceschi, G. (1985) Etologia dell' image. *LineaGrafica*, 2, 28-35.
- Anceschi, G. (1981) *Monogrammi e figure*. Firenze: Casa Usher.
- Bartoli, M. (2013) è *Bologna*. [Online]. Available from: <http://www.matteobartoli.com/portfolio/e-bologna/>. [ultimo accesso: 16 maggio 2014].
- Baule, G. (2007) *Lessico*. In Bucchetti, V. (a cura di), *Culture visive. Contributi per il design della comunicazione*. Milano: Edizioni Poli.design.
- Bohnacker, H., Gross, B., Laub, J. e Lazzeroni, C. (2012) *Generative Design*. New York: Princeton Architectural Press.
- Chiappini, C. e Cioffi, A. (2006) Identità cinetiche. *Progetto Grafico*, 9, 96-109.
- Ciuccarelli, P. (2007) La marca come sistema complesso e le ragioni del mataprogetto. *Sistema Design Italia Magazine*, 5.
- Duro, L., Machado, P. e Rebelo, A. (2012) *Graphic narratives: generative book covers*. Paper presentato in ACM Siggraph Proceedings.

- Felsing, U. (2010). *Dynamic identities in cultural and public contexts*. Baden: Lars Muller Publishers.
- FF3300 (2010). *Index Urbis*. [Online]. Available from: <http://www.ff3300.com/stage/indexurbis/>. [ultimo accesso: 16 maggio 2014].
- Galanter, P. (2012) Computational Aesthetic Evaluation: Past and Future. In McCormack, J. e d'Inverno, M. (a cura di), *Computers and creativity*, Berlin: Springer Verlag.
- Galanter, P. (2003). *What is Generative Art ? Complexity Theory as a Context for Art Theory*. Paper presentato alla 6th Generative Art Conference. [Online]. Available from: http://www.philipgalanter.com/downloads/ga2003_paper.pdf [ultimo accesso: 3 ottobre 2014].
- Henrion, F.H.K. e Parkin, A. (1967) *Design coordination and corporate image*. London-New York: Reinhold Publishing Corporation.
- Lapetino, T. (2011) *The Future is Fluid: Inside Dynamic Logos*. [Online]. Available from: su <http://www.hexanine.com/zeroside/the-future-is-fluid-inside-dynamic-logos/> [ultimo accesso: 16 maggio 2014].
- Manovich, L. (2001) *The Language of New Media*. Cambridge: Mit Press.
- van Nes, I. (2012). *Dynamic Identities. How to create a living brand*. Amsterdam: BIS Publishers.
- Neue Design Studio (2011) *VisitNordkyn*. [Online]. Available from: <http://www.neue.no/index.asp?id=27415> [ultimo accesso: 15 maggio 2014].
- Reas, C., McWilliams, C. e Barendse, J. (2010) *Form+code in design, art and architecture*. New York: Princeton Architectural Press.
- Sagmeister, S. (2007) *Casa da Musica Identity*. [Online]. Available from: <http://www.sagmeisterwalsh.com/work/project/casa-da-musica-identity/> [ultimo accesso: 15 maggio 2014].
- Shaughnessy, A. (2008) Wolff Olins' intuitive branding. *Business Week*. [Online]. Available from: <http://www.businessweek.com/stories/2008-02-06/wolff-olins-intuitive-brandingbusinessweek-business-news-stock-market-and-financial-advice> [ultimo accesso: 15 maggio 2014].
- Schön, D. A. (1993) *Il professionista riflessivo. Per una nuova epistemologia della pratica professionale*. Bari: edizioni Dedalo.
- Sennett, R. (2008) *L'uomo artigiano*. Milano: Feltrinelli.
- Triggs, T. (2003) *The typographic experiment: radical innovation in contemporary type design*. London: Thames e Hudson.

Téllez Bohórquez, A. (2011) *Computación e identidad visual corporativa*.

Paper presentato al XV Congreso Sigradi.

TheGreenEyl (2011). *MIT Media Lab Identity*. [Online]. Available from:

<http://www.thegreeneyl.com/mit-media-lab-identity-1> [ultimo accesso: 16 maggio 2014].

Wicht, P. (2011) *Generative Identity*. [Online]. Available from:

<http://enigmaprod.ch/en/where-we-stand-3/identite-generative/> [ultimo accesso: 15 maggio 2014].



Street Furniture and the Nation State: A Global Process

Eleanor Herring*
Glasgow School of Art

In the popular imagination, street furniture has traditionally been understood as evoking a sense of national or local identity. Objects like lampposts and telephone boxes contribute to the unique qualities of a place, providing a sense of visual coherency for neighbourhoods in need of new identities, strengthening their character and improving the public's relationship to them. In this way, street furniture is often employed as a cipher for the narrative of regeneration, in which - as a means of altering the identity of a space - it projects a new face upon the street. Increasingly however, multinational firms provide these objects to local authorities for free in return for advertising space. And as a consequence, international differences between street furniture are considerably less marked than they used to be.

Thus, by seeking to promote the unique identity of a city, many places often end up looking more alike. This paper will examine the process by which the street is furnished and the agents responsible. Drawing on examples from postwar Britain until the present day, it will look closely at the historic relationship between the nation-state and street furniture design, and the impact of privatization and globalization on the contemporary street.

Keywords: *Street Furniture; postwar Britain; nation-state; globalization; privatization*

1. Introduction

Street furniture is a category of object that every one of us engages with daily. Indeed, as objects within the public realm, street furniture is surely one of the most accessible forms of design, since it excludes no one.

Lampposts light our path, litterbins accept our waste, parking meters take our money. Such artefacts constitute the background to our everyday practices and give shape and expression to the public realm. They are

* Corresponding author: **Eleanor Herring** | e-mail: ellieherring@gmail.com

economic, cultural and even social artefacts that perform the role of props with which daily situations are performed.

In the popular imagination, street furniture has traditionally been understood as evoking a sense of national or local identity. From Paris' metro entrances, DDR lampposts in Berlin, New York's Helvetica signage system or the rows of red telephone boxes in London's Westminster, the designed environment contributes to the unique qualities of a place. While in some instances the relationship between street furniture and identity emerged accidentally, more often than not it has been used for deliberate effect. In the past as well as the present, cities across the world have used street furniture to provide a sense of visual coherency for neighbourhoods in need of new identities, strengthening their character and improving the public's relationship to them. In this way, street furniture has been employed as a cipher for the narrative of regeneration, because - as a means of altering the identity of a space - street furniture can project a new face upon the street.

And yet, the irony of regeneration today is that by seeking to promote the unique identity of a place, many cities across the developed world often end up looking more and more alike. There are several reasons for this, one of which includes the increased presence of multinational firms, which supply street furniture to cities for free in return for advertising space. As a consequence, international differences between such objects are considerably less marked than they used to be. But is this extraordinary aesthetic convergence merely linked to economies of scale - after all, just how many different kinds of bus stop can Europe afford to have? Or, does it reflect the challenges posed by globalization and the privatization of public space?

This paper will reflect upon these questions by focusing on how the street is furnished, and the various agents responsible. Drawing on examples from postwar Britain until the present day, the paper will trace the different ways that street furniture has been used to reflect the identity of the street, the city and indeed the nation-state. It will look closely at the historic relationship between the nation-state and street furniture design, and the impact of privatization and globalization on the contemporary street. By addressing these issues, this paper ultimately seeks to examine the shifting identity of the designed environment, and its relationship to the nation-state.

2. Street furniture and identity

Street furniture and identity have always been closely linked. Indeed throughout history, custodians of the street have sought to reflect their identities - and thus their control of the street - through the designed objects within it. The architectural historian Anthony Vidler gave an example of this in his 1986 essay 'Scenes of the Street', in which he described the 19th Century standardization of street furniture in Paris as being representative of the state's control over the city. According to Vidler, the justification for such an immense project – involving the standardization of benches, lamps, tree guards, railings, pavements and drains - was so that, 'even as the trace of the route united a hitherto parceled out city so did the objects of its use remind the citizen of one, uniformly governed Paris' (Vidler 1986, p. 95). In other words, by visually unifying Paris' street furniture, the 19th Century nation-state was imprinting its official identity upon the streets of the nation's capital.

3. Street furniture design in postwar Britain

Like Vidler, I am also interested in reading the banal built world to expand our knowledge of how political power works, though my research has focused upon postwar Britain. In Britain between the late 1940s and early 1970s, the design of street furniture reflected the ideals and tensions of a broader social, political and economic project. In the aftermath of the Second World War, the British state's commitment to improving the standard of people's daily lives manifested in the creation of the Welfare State and the National Health Service. Yet it was equally keen to give physical expression to this new social and cultural agenda. Many in official design circles considered modernism as capable of projecting the ideas about progress, change, fresh vision and invention that were compatible with changing postwar socio-political conditions. These ideals manifested through the design of housing, transport, domestic and consumer goods, and street furniture. One organization that was central to this project was the Council of Industrial Design. Established by Hugh Dalton, President of Board of Trade in 1944, the state-funded Council was driven by Dalton's belief that encouraging higher standards in design would improve the daily lives of 'ordinary men and women' (MacCarthy 1979, pp. 73-74). For the Council, equally ordinary objects like street furniture could contribute to these social ideals by providing an accessible platform to improve the taste of the general populace through modernism.

3.1 *Nationalistic arguments*

One of the ironies about postwar British design culture however, is that – despite modernism’s postwar adoption as an international style - the Council often appeared to measure the quality of modern street furniture on the basis of its national characteristics. Discussions about British-looking street furniture, or the effect of street furniture on the nation as a whole were typical. For instance, when justifying the organization’s interest in street furniture in the *Times* in 1950, Council director Gordon Russell asked whether Britain could ‘regard ourselves as civilized people if we ignore the design of the commonplace things which all of us use everywhere everyday?’ (Russell 1950, p. 5) Russell is making an implicit comparison between Britain and other countries, but his comment about ‘civilized people’ can also be understood in light of wartime propaganda. For many years after the war, the Council continued to employ themes like duty, battles, victory and patriotism as part of its campaign to improve design standards. It was an attitude shared across postwar design circles. For instance, in a 1952 feature on lettering on street furniture, the *Architectural Review* celebrated the design of a warning sign on currents, claiming that ‘its stentorian voice would reach the back row and beyond in the teeth of a 60 m.p.h. gale – a splendid example of straight-from-the-shoulder visual oratory and straight-from-the-shoulder English too’ (the *AR* 1952, p. 59).

Clearly, nationalistic arguments were never far from the surface in discussions of postwar design.

3.1.1 *Britain's export trade*

Another way of understanding why national design identity was so important in postwar Britain is through economics. Britain was in a very difficult economic position after the war and its export market was threatened from all sides. By trying to reinvigorate British industry, and simultaneously improve the public’s ability to ‘appreciate the need for good design’, the creation of the Council was intended as a means of helping rebuild Britain's export trade (the *CoID* 1946, p. 6). In this respect, the Council performed an important economic role for the Board of Trade. Yet it quickly encountered problems in fulfilling this objective. For a start, many British manufacturers held the view that ‘British Made’ was a marker of excellence in itself, and that design was superfluous, being a ‘perversity of foreigners’ (the *AR* 1946, p. 92) Modern design especially was widely considered as a perversity that had originated outside Britain (*Punch* 1946, p. 291). Such views were not only expressed in the popular press, but even

by the writer John Betjeman, whose criticism of the German historian Nikolaus Pevsner - one of the 20th Century's key supporters of modernism – was often suffused with xenophobia (Harries, 2011). Betjeman, incidentally, was also one of modern street furniture's loudest postwar critics (Betjeman, 1950). The example shows that in the aftermath of the war, national identity was commonly conflated with design styles.

4. American design standards

Yet the biggest threat to Britain's economy came from across the Atlantic. According to the Council in 1946, America's industrial progress 'has made many of our exports old-fashioned and less acceptable'; again underlining the need for manufacturers to embrace modern design (the CoID 1946, p. 6). Perhaps as part of its defense strategy, the style of American products was widely criticized in the British design press. For instance, in 1951 the *Architectural Review* observed that streamlining might satisfy American stylists, but doubted whether the 'serious modern designer' would feel the same in England (the *AR* 1951, p. 352). In 1954 *Design* magazine - which acted as the Council's mouthpiece – also criticized America's design standards. Reviewing an American parking meter – called the 'Park-o-Meter' - that was meant for British streets, *Design* reacted with scorn: 'this standard American design with its thick, insensitive 'jelly mould' contours and heavy handed lettering is to be made in this country by Venner Ltd. Alone it will not look pleasant, but seen in a row along a pavement or spaced at intervals around a London square its contribution to street furniture can only be deplored' (*Design* 1954, p. 6).

Such was the depth of feeling against the 'Park-o-Meter' that the Council commissioned the British industrial designer Kenneth Grange to make the design more acceptable in Britain's streets. In an interview with Grange, he noted that he only ever sought to make the banjo-shaped design simpler, rather than British (Grange, 2012). Nonetheless, national design identities did play a part. In fact, he conceded that like many other British designers from the period, he was inspired by 'upper-class European' design, especially that which emerged from Scandinavia (*ibid.*). By contrast, although American streamlined designs in chrome were often 'functionally excellent', their styling was considered to be very heavy-handed, and 'more overtly theatrical - just more Broadway - than it was here' (*ibid.*). For a successful industrial designer working in postwar Britain then, America and Scandinavia represented the poles of taste.

4.1 *Continental street furniture*

In the context of street furniture, it would appear that for many people, modern British designs compared poorly with the output of other countries. Writing for the *Architectural Review* in 1961, Derek Barton observed that ‘anyone who has been about on the Continent will probably have noticed in some places the exceptional grace, slimness and tallness of the street-lamps’ (the AR 1961, p. 134). He considered British lampposts, by contrast, to be far inferior, and attributed this fact to ‘the worst British habit of always expecting the worst, of making everything three times as thick and stout as need be, just in case a travelling circus piles up against a lamp-post once in twenty years’ (ibid.).

4.1.1 *A ‘British look’*

Discussions about the relationship between design and national identity continued throughout the 1950s and 60s, and the Council increasingly struggled against the notion that Britain had no unique modern style of her own. In 1962 the Council was reported in the *Guardian* as criticizing ‘an increasing tendency in some industries to copy foreign designs and employ foreign designers’ (the *Guardian*, 1962). According to the Council, a ‘British look’ would only emerge if ‘British designers are encouraged to do their natural best without looking over their shoulders at what other countries are creating’ (ibid.). The desired objective was the expansion of demand for British goods. However, even though Carnaby Street and swinging London were right around the corner, the Council warned that, ‘unless modern British design can be recognized not only as modern but also as British, foreign buyers will naturally turn for their modern purchases to those countries that have established a recognizable national character in their work’ (ibid.).

5. *‘Retrofitting’*

It would seem however that throughout the 1960s fewer people shared the Council’s interpretation of what constituted ‘good, modern designs’ (ibid.). Instead, as the Council itself acknowledged, the biggest demand, particularly from the foreign market, was for traditional wares that presented a far more familiar picture of Britain. Perhaps because of this – as well as a more general acceptance of pluralism in society - the postwar aspirations of the Council for modernity began to be replaced with a drive to preserve what was left of the past, and commemorate what had been lost.

By the 1970s and 80s, heritage-style street furniture had become extremely popular across Britain – and elsewhere – as a means of reinstating the past within the public realm, arguably as a way to invoke a lost national identity. In *Theatres of Memory*, historian Raphael Samuel discussed this phenomenon - which he regards as 'retrofitting' - in which an aestheticized version of Victorian street furniture found widespread application in civic spaces once dominated by postwar modernism.

Victorian-style litterbins, electrically powered street lamps complete with gas flicker, and the resetting of cobblestones over existing macadamised surfaces was used as 'a kind of talisman of historicity', and has been acknowledged by several writers as anachronistic and informed by feelings of nostalgia (Samuel 1994, p. 73). In Britain, heritage-style street furnishings can be placed within a context of the Conservative policies of Thatcher, whereby pitched roofs, neo-Victorian decoration, and other changes in the built environment reflected a change in political ideology.

5.1 Modernization in disguise

And yet, while the political climate of the 1980s demonstrated its willingness to commodify the past, Samuel points out that underneath this 'period dress' was actually modernization in disguise (*ibid.*, p.75). Indeed, the tension between political ideology and Britain's design identity remained constant. It manifested once again when the Thatcher government began selling off anything of value in the public realm, including the British telephone network. This resulted in the replacement of Gilbert Scott's classic red K2 design with an alternative British Telecom model bearing advertising on its metal back – 'a complete rejection', according to historian Gavin Stamp, 'of the civilized attitude towards public amenities which prevailed earlier this century' (Stamp 1989, pp. 25-26). For many people, the commercial sale of the telephone network and its subsequent impact on the nation's streets was not just a Conservative attack on nationalization and state-ownership - regardless of the long-term interests of the British people - but also an attack on the very fabric of British identity.

Ironically, the red box still acts as a cipher of British-ness in film sets and theme parks, and is commonly represented through a variety of objects for sale, such as biscuit tins, key rings and T-shirts.

6. The nation state and globalization

What took place in the designed environment in 1980s Britain is now a common enough phenomenon, which can broadly be attributed to financial deregulation, a contraction in the role of the nation state and globalization.

According to the late historian Eric Hobsbawm, these events are connected. For him, globalization has transformed the world into a single unit of interconnected activities unhampered by local boundaries (Hobsbawm 2007, p. 1). Our worlds are so integrated, our ordinary operations are so geared to one another, that the nation-state can no longer be considered the only means through which power is exercised.

Since the 1970s, transnational private firms have replaced many of the direct activities and services that governments of nation-states traditionally provided. As a result, the 'market' is increasingly perceived as able to provide services better and more efficiently and cheaply than public authorities (ibid., p. 103). This has meant that profit-making private firms are allowed to intervene and shape the political, cultural and economic landscape of nation-states, without being democratically elected, transparent in their decision-making processes or accountable to the public.

6.1 Street furniture and the market

Increasingly contemporary cities are in competition with each other, as the rise in place promotion and city branding testifies. In turn, furnishing the street has become a lucrative business opportunity. The designed landscape of the street is ever more reliant on the 'market', since advertising companies are increasingly responsible for designing the objects for the street, a process sanctioned by local authorities keen to reduce costs. Yet by offering this 'free' service - to design and supply our bus shelters, signage, benches and litterbins - multinational companies like Adshell, JC Decaux, Wall and Clear Channel not only fracture the state's active role in street furniture design, but they also homogenize the everyday designed environment of the street. While postwar Britain once believed that a nation could not call itself civilized if it ignored the design of commonplace things, now private interests have appropriated street furniture. This exchange from public to private is important because the street is a civic space, and is an important marker of where we are, and who we are.

7. Conclusion

Today it is hard to imagine having a conversation about the comparative merits of contemporary street furniture in Europe. The debates that prompted so much discussion in postwar Britain – about American parking meters, English signage and the slimness of Italian lampposts – would be difficult to sustain in the light of globalization and widespread privatization. International street furniture's excessive homogenization has made conversation about its relationship to the nation-state virtually redundant.

And yet the intensity of the debate in postwar Britain reveals a great deal about how we understand street furniture and its relationship to the economy, national identity and ideology. As banal as they might first appear, lampposts, benches and litterbins exemplify the way that different agents shape the street and its uses according to their own social, economic and political purposes. As a consequence, such objects reflect the broad range of tensions and conflicts that characterize the uses and appropriation of public space by different agents, and equally our anxieties about how public life is shaped. As this paper has demonstrated, such anxieties were particularly relevant in postwar Britain - a period in which design was brought under government control to a far greater degree than ever before, but which simultaneously witnessed an increase in voices participating in discussions about design, the role of the state, and power more generally. In such a context, the question of who has the authority to make design decisions on behalf of others, and the manner in which those decisions are made, becomes critical.

Illustrating how this historic debate on street furniture reflected these broader social, cultural and political themes provides a number of useful insights into the power balance within public space today. As this paper has shown, street furniture remains a deliberate means of projecting value and meaning into the street. Such objects continue to be used for economic purposes i.e. to regenerate cities and as vehicles for advertising, as well as social purposes i.e. to reduce crime and discourage anti-social behaviour. Its relationship to national identity has not disappeared either, and one only needs to consider Royal Mail's gold postboxes during the London 2012 Olympics (Topping, 2012) – as well as the debate it prompted - to see this relationship in action. Clearly, the entanglements between street furniture design, politics, the economy and national identities continue to be relevant more than fifty years on.

References

- Barton, D. (1961) Lamp-Posts: At Home and Abroad. *The Architectural Review*, 130 (774), 134.
- Betjeman, J. (1950) Ugly Lamp Posts. *The Times*.
- The Council of Industrial Design (1946) *1st Annual Report 1945-46*.
- The Council of Industrial Design (1962) *17th Annual Report 1961-62*.
- Editorial (1946) Industrial Design. *The Architectural Review*, 98 (648).
- Editorial (1951) CoID Progress Report. *The Architectural Review*, 110 (660), 349-352.
- Editorial (1952) Lettering. *The Architectural Review*, 111 (661), 59.
- Editorial (1954) In The Street. *Design*, 63, 6.
- Editorial (1962) Design Council wants a British look. *The Guardian*.
- Grange, K. (November 2012). Interview.
- Harries, S. (2011) *Nikolaus Pevsner: The Life*. London: Chatto & Windus.
- Hobsbawm, E. (2007) *Globalisation, Democracy and Terrorism*. London: Abacus.
- MacCarthy, F. (1979) *A History of British Design: 1830-1970*. London: George Allen and Unwin.
- Reynolds, F. (1946) Utility cartoon. *Punch*, 291.
- Russell, G. (1950) *The Times*.
- Samuel, R. (1994) *Theatres of Memory*. London: Verso.
- Stamp, G. (1989) *Telephone Boxes*. London: Chatto and Windus.
- Topping, A. (August 2012) Royal Mail Backs Down over Golden Postbox in Ben Ainslie's Home Town. *The Guardian*.
- Vidler, A. (1986) *Scenes of the Street in On Streets*. Cambridge: MIT Press.

Beyond social innovation: design as cultures active-action

Eleonora LUPO*
Politecnico di Milano

This essay aims at contributing at the theoretical debate on design and social innovation focusing the issue from a specific perspective, that is a social innovation based and centred on culture and cultural heritage. The cultural asset is a distributed heritage of values and knowledge embodied in people, rooted in activities and places, continuously shared and socialised, therefore, it has an eminent social dimension as ambit of design; in addition, according to the more contemporary design practice and processes, always more socially distributed, the field of cultural and local asset enhancement has a social dimension also for a design approach called ‘cultures active-action’. In this vision, design is an ‘activator’ of sustainable innovation and development of communities based on cultural assets, with an ‘open-ended’ approach that provides contexts for innovation rather than contents, given the cultural, social and knowledge values the already existing contents. The sustainability is based on an approach that mixes bottom-up and top-down strategies with factors like ownership, control and impact of the assets involved in the innovation process.

Keywords: Cultural based social innovation; design active-action

Introduction: ‘something is-still-missing’

‘Something is missing signifies that humanity is aware that the world is not perfect. And that the desire to imagine its transformation and its improvement until it reaches a state of perfection is a component of our culture, that cannot be removed’ (De Michelis, 2008, p. 41).

This statement seems to perfectly suits to what social innovation really is: the search for continuous and virtuous improvement as social human being. But here is also paraphrased in order to state that something is missing in our possible understanding of social innovation too.

* Corresponding author: Eleonora Lupo | e-mail: eleonora.lupo@polimi.it

This essay in fact aims at contributing at the theoretical debate on design and social innovation focusing the issue from a specific perspective, that is culturally driven: in this vision, design is an 'activator' of innovation based on cultural heritage, asset that has a social dimension, because is a formidable shared resource of knowledge and development of communities (local communities, communities of practices...) and territories, in a sustainable framework.

This contribution might open-up a deeper understanding of new opportunities of social innovation.

The reflections stem partially from social and cultural design cases studies focused on (local) cultures and communities active-action, that provide some theorisations helpful to discuss the topic. The first case is the International Summer School 'Design Connected Places', a 8 months 'territorial project for a cosmopolitan experience' (Manzini, 2009, p. 8) in seven thematic social communities working on local development, within the framework of World Design Capital, held in Turin, Italy, in 2008. The second case is the 2 years project 'Contemporary Authentic', a design platform of pilot actions for the development and valorisation of the craft knowledge and community of the city of Milano (Lupo, 2013).

Nevertheless, as every process where the human capital and cultural dimension are the qualitative levers of project, that make it an unique result, these case studies can be generalised only in part, abstracting from them replicable methodologies and approaches, but highlighting specificities and dependencies from the context and the situation. They therefore need to be complemented by a metadesign reflection, contextualising them in a framework of hypotheses suitable for the scientific debate and eventual validation. In doing this the essays mixes the discussion of case based evidences with the statements of some hypotheses or claims theoretically or scientifically led.

So it will primarily introduce the cultural based social innovation concept, then analyse critically the cases, discussing the issues raised in response to the more acknowledge social innovation framework, and point out the specificities generated by the interpretation of a social innovation cultural based and centred, in order to go 'beyond social innovation'.

Looking back at social innovation

There are many well-known and acquainted definitions of social innovation. Making a critical review of them is not the primary purpose of

this analysis. Nevertheless we need to briefly introduce the key concepts and qualities of social innovation in order to better explain what makes different a cultural driven social innovation.

According to Mulgan, social innovation is ‘new ideas that work to meet pressing unmet needs and improve people’s lives’ (Mulgan, 2007, p. 7). In this definition there is an implicit reference to a social goal (solving needs for improving life) that should be addressed by social innovation.

The social connotation of innovation as addressing an **objective or purpose** that has a social dimension is a commonly shared visions from many innovation theories, but there are other visions that refer to processes of innovation that are social just in **nature or process** (i.e. collaborative processes or participative methodologies) and ignore the question of purpose (that can be of every nature: i.e. economical, technical...). These positions anyway are not controversial or opposite, but often synergic.

Regarding the dimension of purpose in fact, ‘innovative activities and services that are motivated by the goal of meeting a social need and that are predominantly developed and diffused through organisations whose primary purposes are social’ (Mulgan, 2007, p. 8) are not in contradiction with a social process; regarding the dimension of process, the various stages in which social innovation has been framed can be of social nature and are suitable for social goals. From ideas generating to prototyping/piloting, scaling and learning (Mulgan, 2007 pp. 21-25) or across the six stages model from prompts, inspirations and diagnoses; to Proposals and ideas; Prototyping and pilots; Sustaining; Scaling and diffusion; and Systemic change (Murray et al., 2010, pp. 12-13), there is a noticeable shift from products and market centred strategies to human centred ones, where the human dimension is not any more individual, but collective and communitarian.

Concerning the social nature of the innovation processes, the synergic roles of the diverse actors is crucial: there are individual roles as well as hubs and platform and institutions that usually together promote and support social innovation.

This is, according to Mulgan, an approach that **mixes bottom-up initiatives with top-down strategies**: like bees that pollinates trees, the bottom-up initiatives cross fertilise and make more effective and spread the top-down strategies (Mulgan, 2007, p. 20).

While some actors perform bottom-up actions, being them individual roles like innovation scouts or champions, or teams, hubs, parks, networks, platforms (Murray et al., 2010 pp. 124 and following), the top-down support

should come by institutional actors, like the State, that promotes with legislation and regulation, a ‘grant economy’, or by the scaling and diffusing of a systemic change supported by other formal or informal organisation that try to establish a ‘household economy’ through collaborative services, neighbourhood prosumption, informal mutualism (Murray et al., 2010, pp. 149 and following).

This reciprocal collaboration is also encompassed by the concept of *Civic economy* combining the spirit of entrepreneurship with the aspiration of civic renewal: ‘The central point is that the civic economy is not the exclusive domain of any particular sector of the economy; instead, it bridges across the public, private and organised third sector as well as including the public at large’ (00:/, 2011, p. 8).

Ezio Manzini introduces also an idea of social innovation that, according to the categorisations that come from the field of technological innovation, can be qualified as **incremental or radical**: ‘Social innovation is a process of change emerging from the creative re-combination of existing assets (from social capital to historical heritage, from traditional craftsmanship to accessible advanced technology), the aim of which is to achieve socially recognized goals in a new way’ (Manzini, 2014 p. 57). The *incremental* characteristic is relative to the capacity of acting on existing asset, that is reconfigured eliciting potentialities otherwise invisible. While the objective remains a social goal, what makes interesting this definition is the introduction of the concept of a **source** for achieving the social innovation, that is the ‘(existing) asset’: this asset, noticeably for Manzini includes also forms of cultural heritage (historical heritage or traditional craftsmanship). Finally, the *radical* characteristic of social innovation is synthesized in the expression ‘*a new way* for achieving social goals’, that happens opening up this field to a peculiar discipline and qualified actor as distinctive **driving force** to achieve social innovation.

This framework, in fact, is shared and adopted by various disciplines and actors: economics, sociology, policymakers, organizations. Manzini instead refers specifically to design activities as catalyst of social resources in order to trigger and support sustainable changes: he calls these activities ‘design for social innovation’, which includes ‘design initiatives, characterized by a clear design approach and by the use of specific design devices (e.g., prototypes, mock-ups, design games, models, and sketches)’ ‘whatever design can do to start, boost, support, strengthen, and replicate social innovation’ (Manzini, 2014, p. 58). Manzini also identifies the possible various roles of designers, that are both facilitators and ‘triggers that start

new social conversations', behaving 'as design activists, proactively launching socially meaningful design initiatives' (Manzini, 2014, p. 66).

The question of the approach is intertwined with design framing the top-down social innovation as driven by strategic design, and the bottom-up social innovation as driven by local communities: both visions appear as design-led process even if the design and designers involved can be not explicit, but *de facto*: 'The 'designers' are very diverse social actors who, consciously or not, apply both skills and ways of thinking that in all respects are to be considered design activities' (Manzini, 2014, p. 62). While strategic design is addressed to recognise problems, the social resources that can be activated and to build a vision to connect local initiative, the design with/for communities means co-designing with other creative actors or transforming the insight that comes from *listening* the communities needs in real solutions.

The practice of listening is common to many researchers and practitioners: Ideo uses 'hear, create, deliver' as a Human Centred Design strategy able to overcome a vision focused only on anthropometric and ergonomics. This human dimension is intended by Anna Meroni as a 'shift from *user centred design*, to *community centred design*, where the accent is on understanding social behaviours and needs, to then collaborate with the most active social communities in conceiving solutions' (Meroni, 2008, p. 33). This definition clearly comprises the social nature of innovation as collective design process too.

Similar concepts of design for social innovation are 'transformation design' or 'next design': according to Burns et al., transformation design is 'design skills to address social and economic issues. It uses the design process as a means to enable a wide range of disciplines and stakeholders to collaborate. It develops solutions that are practical and desirable. It is an approach that places the individual at the heart of new solutions, and builds the capacity to innovate into organisations and institutions' (Burns et al., 2006, p. 6). Transformation design has a social dimension but the emphasis of the definition is not on the objective of addressing social desirable solutions, but on the evolution and transformation of the design process and approach in itself for creating this fundamental change. We could say it is giving more importance to the nature of the process than to the purpose. For instance transformation design goes beyond problem solving and traditional solutions, stresses the loss of personal creative authorship in favour of a collective subject, make collaborating various disciplines and shapes behaviours rather than forms (Burns et al., 2006, pp. 20-21 and 26).

From this review emerged some points that we would like to remark as qualities of the so called design for social innovation/transformation design:

1. Social innovation is often **related to sustainability**, in addressing social and economic issues that could promote more sustainable way of living and producing, able to answer to the multiple, growing challenges of the ongoing economic crisis. Manzini usually refers this sustainable approach to the SLOC scenario that stands for Small, open, local and connected, and are considered relevant indications for developing sustainable solutions: for Manzini this is a *visionary*, yet *comprehensible* and *viable* scenario (Manzini, 2010, p. 10). What we consider also interesting from this sustainable framework are the (following deepened) ideas of locality and openness;

2. Social innovation is very often a **situated action**: localities, territorialities and qualities of their communities are not only the context of the design action, but the specific asset and sources for achieving social innovation. In this they function as peculiar conditions that led to very specific design output with a strong context based approach;

3. Social innovation is a **relational and distributed action**: it makes collaborating various actors and stakeholders (new social relations, networking) and between disciplines (cross-disciplinarity);

4. Social innovation is always more often an **open-ended process**: in 'building capacity, not dependency' or in 'shaping behaviour rather than form', 'transformation design is never done' (Burns et al., 2006, p. 26), and design acts as a mean for discursive approach and strategic social conversations, leaving to the society, the community, the territory, the opportunity to represent themselves and the possibility to determine and co-create the design outputs and results.

5. Social innovation has moved **from the margins to mainstream** (Mulgan, 2007): from being an emerging and punctual approach, often adopted also with a counter-cultural attitude (from guerrilla to activism) is now multiplied and diffused by systematic scaling and sustaining, and by the recognition of its economic impact.

Toward a cultural based social innovation: activating heritage by design

The most spread view is that social innovation is a way of 'improving society to solve problems' mobilising ubiquitous intelligence. So the emphasis is on a direct social need and possibly social process. In this vision

culture is (just) a support, being one of the possible enabling conditions (Murray et al., 2010, p. 9).

Our hypothesis instead, going beyond the acknowledged social innovation, proposes a cultural heritage driven social innovation. This innovation process addresses an indirect social need, because is focused on cultural needs (like the one of maintaining alive and developing a heritage, a community knowledge, a specific cultural asset of a locality) that are an eminently social and collective good. The cultural asset is a distributed heritage of values and knowledge embodied in people, rooted in activities and places, continuously shared and socialised, therefore, it has an eminent social dimension as ambit of design. Culture and cultural heritage are a social asset because they are a product of social relations and collective memory and increase their meaning the more they are socialised, experienced, shared, appropriated and practiced by people.

In line with the indications of the European Community and UNESCO, the objective of *culture oriented* development models (Grefe, 2005) is therefore to generate, *activate* and improve the value of the cultural asset in its patrimonial, historical, civil, symbolic, social and developmental function. Such models are intended to develop platforms and connection systems capable of connecting territories and communities through culture and knowledge, simultaneously redesigning relations between the local and the global, tradition and innovation, the public and the private. Culture is a dimension of development of a territory and a community because is an occasion for identity building, integration and social cohesion and culture oriented policies for creativity and innovation (Grefe, 2005).

A cultural driven social innovation is a set of design actions in which culture is together the asset and the objective of intervention. So culture and cultural heritage are enabling condition (cultural awareness) but also the resources and result (new cultural values and heritage) of development and innovation. This implies that the focus on 'solving societal problems or unmet need' is not primary if not reframing it in 'considering culture and cultural heritage as a first necessity social good' for a sustainable development.

We call this set of design actions of heritage based development 'cultures active-action' process.

Table 1 Comparison between Social innovation and Cultural based social innovation.

	Social innovation	Cultural based social innovation
sources, resources (asset)	Any, social	Cultural
Objective/ purpose/result: object or content of design	Social ('improving society in solving unmet needs')	Cultural (i.e. new cultural values and heritage, like inter-culturality; trans-generationality,...)
Approach: (nature of) process, methodology, mean/tool/way of designing (enabling condition)	Mainly social	Mainly cultural and social: 'cultures active-action'
Driver/driving force (led by)	Many, i.e. design, but also development...	design

Cultures active-action is a design approach (and process) aimed at the cultural asset enhancement and exploitation, which is often also socially distributed and participated.

Active-action design processes in fact implies the re-contextualisation, actualisation, incorporation of cultural values and cultural heritage in new design, respectively in the space (the place or context of origin the asset and the one of its fruition), time (the shift from traditional to contemporary) and process (techniques, uses, meanings) dimensions of a society or community (local community or community of practices) in an innovative way (Lupo, 2001; 2008; 2013b). These are processes of *translation of a tradition* in which the use value of the cultural heritage is not intended as a simple experience, but rather enables the shared access, appropriation, comprehension and use of the asset by its community of reference, and which also creates the effective possibility for the reuse and transformation of the heritage by various stakeholders and final users, being them part of the owning community or not.

Activation is therefore an amplification of the term 'enhancement': the activation of the heritage asset recalls an *extended* concept of value enhancement which allows it to be enacted (conceptually or physically), to be transmitted and to evolve innovatively, in terms of exploitation of its

form (in the case of intangible heritage) or its meaning (in the case of tangible heritage).

Cultural heritage is considered in this innovation frame as an 'open ended knowledge system', an open repertoire of knowledge and cultural contents which can be used as instruments with which to build a collective memory (as traditionally occurs), but also and above all, as a resource for the collective production of innovative cultural forms and contents.

This process of cultural driven innovation anyway differs from the one of local and territorial development: in the last one the main objective is clearly development, while in the cultural driven innovation the development can be only an induced (yet expectable) indirect result, but the primary objectives are the ones connected with the heritage exploitation and innovation, that are in a way more indeterminate and context or situation based, as well as the 'unmet social needs': social acknowledgment, appropriation, understanding or better 'activation' of the heritage in new design solutions than can re-distribute the values to the territory or the owning community.

Given this framework to cultural heritage based social innovation we can now recall some of the key concepts of social innovation looking for analogies and differences. Cultural heritage activation follows social innovation with an additive logic: it has some of the qualities of social innovation but with more attributes and specification.

Similarly to design for social innovation, it is a social ***situated but open ended process***: design, as activator, mediator and translator of capabilities, acts as the empowerment of the cultural initiatives of a community of society, that are necessarily always localized, which means the result of specific local (natural, environmental, territorial and cultural) conditions which determined the form of the heritage, but with an 'open-ended' generative approach (Lupo, 2011a) that creatively provides to those societies or communities, rather than contents, *social and cultural contexts for innovation* (Lupo; 2009b), given the cultural, social and knowledge values of a territory and a community the already existing contents. We can talk of design actions that shift their logic from acting within a community and a culture, to acting for and with a community and a culture: actions that in themselves, create a community and a culture.

In this sense design is a '*descriptive approach*' (Dematteis, 1995) directed to *context providing* for innovation: it generate models of transformation that represent possibilities inherent a specific cultural context and builds interpretative representations of the potentialities

already inscribed in that context. The paradigms of interpretation, flexibility, adaptability, transformability become the main feature of such descriptive structures, that anyway produce permanent results. It is a replicable approach that will never lead to the same result, because this possibility of multiple interpretations leads to a set of opportunities where multi-vocality and diversity are the core values. As Yona Friedman says ‘intelligence starts with improvisation’. Therefore the repeatability is not in the forms, but in the rules and method adopted that coordinate and monitor results from time to time to time different, depending on the context, but inevitably bound together by the recognition of cultural design requisites, practices and goals.

This attitude of design can be framed as an ***integration between the opposites of a top-down and bottom-up approach***, the first using design anticipations, or meta-design visions for eliciting latent and not yet acknowledged potentialities of a cultural asset activation, the second one using the design sensibility of listening the society and relying and strengthening with cultural activation the more traditional, self confident and experienced cultural assets.

This mixed approach is also interrelated with a multiscalar vision able to mediate from very specific and punctual actions to general ones in a continuous focusing of the different design needs according to a zoom-in/zoom-out logic from concreteness to comprehensive vision (Lupo, 2009b).

Here in fact, we propose a ***cultural sustainability framework*** as possible response to the debate. In this framework, used to evaluate any cultural activation processes, three factors are conditions for a critical design engagement respectful to communities, being it top-down or bottom-up, site specific or strategic: *ownership*, *control* and *impact* of the social and cultural assets (i.e. community knowledge and heritage) involved in the innovation process (Lupo, 2008). The *ownership* factor defines how much the depositary of the heritage undergoing the exploitation is involved in the process; *control* estimates the capacity of the owner to manage and decide how and when to use his heritage; *impact* evaluates the amount of the benefits that the owner receive back (directly or indirectly) by the exploitation process.

Peculiar features of the cultural based social innovation are cultural related opportunities, which conceive openness and connectivity in term of tolerance of diversity and ***inter-culturality*** and ***trans-generationality***. As Appadurai points out, to design sustainable socialities, ‘forces us back to the

human requirement for stability and closure as counterbalances to volatility and flux' (Appadurai, 2010, p. 12-13). Talking about cultures (cultures as plural entity) activation and innovation means to design more convivial and encounter spaces that could help in growing the understanding and awareness of diversity and integrations among cultures and generations through the sharing of the same heritage (Lupo et al., 2014).

Case history

The two cases here following are described in order to give evidence to some of the hypotheses above presented. They are not fully emblematic for the whole framework of cultural based innovation but help in focusing some of their specific features.

The first case in particular even if is not directly addressing cultural based innovation, being similar to a typical local development process, implicitly uses local cultural resources and heritage in a situated and open-ended process that achieve a sustainable inter-cultural and inter-generational community engagement.

Designing Connected Places, was an International Summer School organized by Torino 2008 World Design Capital: it included over 200 students, more than 40 Italian and foreign designers and researchers from Italian design schools. All of these participants were reunited in the 7 communities of design practices – each dealing with themes concerning pressing current events and specific incidences in the territory of Piedmont: from agro-food resources to productive processes, from public spaces to transportation systems, from healthcare assistance to the representation of the territory. The project lasted 8 months: the final summer school (which took place from July 13 to 29) was preceded by a metadesign phase in which more than 40 researchers and experts from different Italian universities have compiled a consistent activity of survey on the territory and of interlocution with the local actors aimed at highlighting the potentialities and emergencies of the territory in order to articulate the design brief and document it with the production of a dossier of references, case studies, interviews. The final summer school has seen collaborating young designers coming from 41 different countries in a very multicultural environment and with a group of mature and qualified project leaders to ease inter-generational transmission and learning.

According to this, this project has a 'human' dimension, which is no longer conceived of as simply a referential point, but as an element capable

of informing sensibly and responsibly the system of connections which engages places, communities, practices and processes in a temporal perspective, and expresses identities and peculiarities in a society which is more and more globalized, but necessarily inclusive and democratic. The centrality of the community directly involved as prime ‘expert’ of the problem and its knowledge and possibility to contribute to the development processes has grown proportionately with the opportunity people had to express themselves, develop relationships and communicate with a multi-skilled and multi-perspective design team.

Finally timing played a crucial role in the project promoting a ‘vision of future’ that design can help to develop. The collective learning necessary for supporting change requires long and complex sedimentary times (as in any cultural process), which are usually of a longer duration than those of a community. Design therefore worked on the temporal dimension acting in overlapping phases, connecting short term actions, with an immediately perceivable result, to strategic long-term projects.

A detailed description of the project can be found in the final publication (Campagnaro and Lupo, 2009), while a deeper analysis focusing the key elements of this essay is in the table following.

Table 2 Case history analysis: Designing Connected places.

	Designing Connected places
source/asset	The local resources of the Piedmont territory were the asset on which the development and innovation process is based: they include mainly the distributed knowledge capital (mobility, wellbeing) but also cultural resources like food, agriculture and culinary culture, public spaces.
objective	Local development and local society empowerment in solving social problems: health and wellbeing, security of public spaces, mobility and quality of life, food chain and distribution.
nature of process& methods	The process has been eminently social, shared, distributed and participated by many different actors: the summer schools has been articulated as a devices for strategic conversations among stakeholders and exerts of the territory (owner of local and proximity values) and metadesign researchers, project leaders and young designers (owner of multicultural and multiple visions, or distance values). Visualizing the existing opportunities and visioning new possibilities has been the agreed methodology used.

approach (bottom-up and top-down)	The project mixes top-down approach (policies, visioning strategies) with bottom-up creativity
time (medium/long term)	The project mixes long term strategies (territorial demands analysis and interpretation with the local community) with medium/short term actions, from concept development to dissemination for awareness raising and people engagement.
scale (zoom-in/out)	The project works both at a scale of proximity and at a general scale
sustainability factors	Ownership: The local community (i.e. patients for well being, workers for mobility) and stakeholders were directly involved as experts in the project: their experience has been respected and taken in account; Control: They had the possibility to decide and negotiate effective solutions Impact: They have been the beneficiary of the concepts developed and result produced.
Openness and open- endness	The metadesign phase let to the final international project leaders and designers to negotiate the solutions and the concepts. The concept themselves were more plot to be discussed and verified with the local stakeholders than real finished prototypes. The summer school acted as a platform, a context for innovation.
situativity	Local resources and pattern were both asset and bonds of the project.
relationality (inter-culturality, trans-generationality, networking)	A 'Learning from diverse cultures' approach has been the most outstanding strategy to address innovatively local problems, in order to overcome the biggest barrier to innovation (Murray et al. 2010, p.148), learning from other sectors and other places. Culturally mixed teams adopted ideas from diverse sources.

The second project, Contemporary Authentic is a design driven strategy for exploiting the intangible heritage and craft knowledge in Milano, coordinated by Politecnico di Milano and involving an interdisciplinary team of international partners.

The project, that lasted two years (2011-2013), experimented an articulated design driven innovative system for exploiting the typical craft and performative knowledge of endangered masters still active in Milano, making visible and accessible their value in terms of knowledge and technical and productive skills and their procedural, relational, performative qualities, size and spatial impact, through the creation of a complex system

of promotion and dissemination. These masters and their knowledge were (and are still) considered an endangered intangible Heritage because their activity could disappear in short time, due to the lack of successor interested in continuing a such traditional niche market work or to new affordable production systems and technologies. Nevertheless, for their cultural value and subsistence potentialities, they needed to be activated (from documentation to transmission, from fruition to use) under the brand of 'Contemporary Authentic'. Numerous approaches operate on craft, concentrating only on a specific enhancement action, such as the documentation, reapplication or transmission. Contemporary Authentic, on the other hand, touched all the phases of the chain, designing a protocol and a system of quality of territorial craft-based territorial production, which included pilot actions finalised at the documentation, narration, and offer of fruition of the Milanese craft (the online repository, video documentaries, craft shows and events, cultural itineraries), and actions aimed at the structured transmission of knowledge and its innovation (design workshops, craft dialogues and meetings, and a final concept catalogue). Within this macro objective, many discussions were conducted and solutions have been adopted to respond, through strategies and design tools, to the need of effectively documenting the knowledge possessed by masters (especially in relation to its immaterial nature - i.e relational, performative and territorial qualities), and activating, transmitting, renewing, revitalizing and socializing it in a sustainable manner, in relation to authenticity, typicality and possibly intergenerational and intercultural exchanges. Therefore the project settled down a concept of knowledge activation based on 'human relations', which facilitated the sharing, transformation, re-production and incorporation of this traditional knowledge in contemporary forms and processes of cultural offer, essentially by establishing relations between the masters and the local community and the entrepreneurial system.

The CA project was more than a process of contemporary actualisation of traditional craftsmanship: it grouped the various pilot actions with a strong graphic identity, in which the shift between the two opposites (authentic and contemporary) emblematically represents the value of the brand/quality system. In addition, with a system of quality certifications based on parameters which, defining a percentage value of 'innovative excellence' or capacity to regenerate through an innovative tendency which respects the original values, made the different combinations of tradition

and innovation intelligible in various new product development that transferred their skill in other market settings.

A detailed description of the project can be found in the final publication (Lupo, 2013a), while a deeper analysis focusing the key elements of this essay is in the table following.

Table 3 Case history analysis: Contemporary Authentic.

	Contemporary Authentic
source/asset	Intangible heritage and typical craft knowledge were the asset of the exploitation and innovation initiatives.
objective	The main objective of the project was a innovative valorization (called active-action) of local cultural heritage, from conservation and documentation, to trasmission and innovative application of local knowledge. An indirect objective was a development of the craft production and the empowerment of the craft community.
nature of process& methods	The project is based on complementarity, interculturality and interdisciplinarity of competences and expertises and includes national and international partners. The master were made collaborating each other in small groups reinforcing mutual knowledge and the idea of Milanese community
approach (bottom-up and top-down)	The project started with a top down strategy that met the bottom-up needs and initiatives of local masters and craftsmanship.
time (medium/long term)	The project has been organized in various different chronological phases addressing long term objectives (increasing the awareness and knowledge of craft potentialities) and short term results (creation of promotional events and new products, or communication tools like web site and app)
scale (zoom-in/out)	The project worked mainly at a scale of proximity (single master) and at a general scale of the city promotion within expo 2015.
sustainability factors	Ownership: The craft masters have been involved in the process of documentation of their own knowledge, with photo-stock taking techniques; Control: The masters have been mentoring the creative process of new products development, in the frame of authenticity and respect for their skill Impact: The have beneficiated of the brand promotional

	events, and of the collaborating platform created by the project.
Openness and open- endness	The Contemporary Authentic brand and quality certification system is a platform that welcomed many different process and outputs, within the frame of authenticity and contemporariness.
situativity	Local craft skills and heritage were both asset and bonds of the project.
relationality (inter- culturality, trans- generationality, networking...)	The master were made collaborating with young designers and with other masters in a network of opportunities at very different stages: from self-promotions (events, communication, digital app) to product innovation

Conclusion

Though this essay we hope to have provided a seminal contribute for enriching the idea of social innovation with the one of cultural heritage based innovation. Cultural based innovation is not substitutive of social innovation, but complementary and synergic to it. This innovation is social because is focusing on the human individual or communitarian dimension of culture and heritage with an aesthetics quality of action (Lupo, 2011b; Colombi and Lupo, 2014) that addresses *soft* values, like the ones that are cultural and humanities driven (from valorization, to appropriation to transmission and innovation).

References

- Appadurai, A. (2010) Responses to Ezio Manzini. *Journal of Design Strategies*, 4 (1).
- Burns, C., Cottam, H., Vanstone, C. and Winhall, J. (2006) Transformation design. *RED paper*, 2. Design Council.
- Campagnaro, C. and Lupo, E. (eds.) (2009a) *International Summer School. Designing Connected Places 2009*. Milano: Editrice Compositori.
- Campagnaro, C. and Lupo, E. (2009b) Formare comunità, in-formare territori. Designing connected places: fare scuola di design per il territorio. *Tafter Journal. Esperienze e strumenti per la cultura e per il territorio*, 15 (luglio-agosto).
- Colombi, C. and Lupo, E. (2014) *Bridging innovation between Design and Humanities. New cognitive and relational processes*. Paper Presented at

- the Proceedings of the 4th International Forum of Design as a Process, Universidade do Estado de Minas Gerais, Belo Horizonte, Brasil.
- Dematteis, G. (1995) *Progetto implicito*. Milano: FrancoAngeli.
- De Micheli, M. (2008) *Something is missing*. In Cerizza, L. and Daneri, A. (eds.), *Yona Friedman*. Milano: Charta.
- Giunta, E. and Lupo, E. (2014) *Contemporary Authentic': a design driven strategy for activating intangible heritage and craft knowledge*. In Almekvik, G., Palmsköld, A. and Rosenqvist, J. (eds.), *Crafting Cultural heritage*. Gothenburg: Gothenburg Studies in Conservation.
- Grefe, X. (2005) *Cultura e sviluppo locale*. Trento: Nicolodi.
- Lupo, E. (2008) *Beyond localism, looking for sustainability. Designing 'typical knowledge' active-action*. In Cipolla, C. and Peruccio, P.P. (eds.), *Changing the change proceedings*. Torino: Allemandi.
- Lupo, E. (2009a) *Il design per i beni culturali. Pratiche e processi innovativi di valorizzazione*. Milano: FrancoAngeli.
- Lupo, E. (2009b) *Design per i beni culturali (glossa)*. In Lupo, E. and Parente, M. (eds), *Il sistema Design Italia e la valorizzazione dei beni culturali*. Milano: Polidesign.
- Lupo, E., Giunta, E. and Trocchianesi, R. (2011a) Design research and cultural heritage: activating the value of cultural assets as open-ended knowledge system. *Design Principles and Practices Journal*, 5. [Online] Available from: <http://ijg.cgpublisher.com/product/pub.154/prod.730>. [Accessed 30th December 2014].
- Lupo, E. (2011b) Design, Arts and Aesthetics of Innovation. *Strategic design Research Journal*, 4 (2), 40-53.
- Lupo, E. (eds.) (2013a) *Autentico Contemporaneo Milano. Design e attivazione dei saperi tipici e maestri artigiani milanesi*. Milano: Maggioli.
- Lupo, E. (2013b) *Percorsi e scenari dell'intangibile. Le filiere del progetto e il potenziale di innovazione del patrimonio immateriale come 'open-ended knowledge system'*. In Irace, F. (eds), *L'immateriale, il virtuale, l'interattivo*. Milano: Electa.
- Lupo, E., Parrino, L., Radice, S., Spallazzo, D. and Trocchianesi, R. (2014) *Migrations and multiculturalism. A design approach for cultural institutions*. In Innocenti, P. (eds.), *Migrating heritage: Experiences of cultural networks and cultural dialogue in Europe*. Surrey: Ashgate.
- Manzini, E. (2010) Small, Open, Local and Connected. Design for Social Innovation and Sustainability. *Journal of Design Strategies*, 4 (1).
- Manzini, E. (2014) Making things happen. Social innovation and design. *Design Issues*, 30 (1), 57-66.

- Meroni, A. (2008) Strategic Design: where are we now? Reflection around the foundations of a recent discipline. *Strategic Design Research Journal*, 1 (1), 31-38.
- Mulgan, G. (2007) *Social Innovation working paper*. Oxford: SAID Business School.
- Murray, R., Caulier-Grice, J. and Mulgan, G. (2010) *The open book of social innovation*. Nesta-The Young Foundation.
- 00:/ (2011) *Compendium for the civic economy*. Nesta & Design Council CABE. [Online] Available from: http://www.icsid.org/news/year/2008_news/articles472.htm [Accessed: 15th May 2014].

(Dis)placement of/by design: Social Construction of Pojang-macha (Re)Designing in Seoul

Soo-hong MIN*
Seoul National University

In recent decades, the term 'design' and its concept and applicative methods have become critical elements of assessing 'conditions of life'. As a result, the issue of institutional renewal of Seoul's identity, from the symbol of nation's successful industrialization to international cultural destination, can show the changing socio-cultural forms of street vendor pojang-macha through the technoscientific and/or political lens.

This paper demonstrates how the influence of 'design' has led to the concretization and/or generalization of this vernacular object as well as its regional and cultural conventions, a process which results in the acquisition of a new character for the object in question.

In 'design', the ongoing debate is (almost) always drawn from notions of science, technology and their 'facts'. Accordingly, by tracing this pojang-macha (re)designing case following questions could be implicated. Under the rules of artifacts that are effects of 'design', what place could today's science, technology and their aesthetics justify and secure for themselves in everyday life, in which many modern concepts and epistemologies are generalized?

How is the institutionalization of today's design and the methodologies realized? Which forms will eventually be defined as 'design' and how/what science and technology will (de)form those designs of today?

Keywords: *Pojang-macha; institutionalization and (il)legalization of plebeian artifacts; socially constructed design and its performativity*

Introduction

During the recent decades, the term 'design' and its concept and applicative methods have become critical elements of assessing 'conditions of life'. In evaluating the present-day conditions of living which are built

* Corresponding author: **Soo-hong Min** | e-mail: hugebijou@gmail.com

upon the support and criteria provided by various modern institutions and concepts such as public health, hygiene, material, standard, structure, system, comfort, development, the concept of ‘design’ seems to have gone beyond its original meaning of plan and scheme and acquired a new one, ‘indicating the realization of a somewhat more unique appearance and style (or the aspiration toward such an ideal)’ (Vial, 2010) in a ‘human-built world’ (Hughes, 2005) while guaranteeing a universal aesthetic value without much risk and need for thought. One impact of this phenomenon could be illustrated by the changing socio-cultural forms of the ubiquitous *pojang-macha* (布帳馬車; mobile/temporary street vendors serving food and alcohol, literally translated as ‘covered wagon’) through the technoscientific and/or political lens. This issue springs from the context of institutional renewal of Seoul’s new identity, changing from the symbol of the nation’s successful industrialization to an international cultural destination where one can enhance authentic experience of the traditions of East Asia, cutting-edge IT culture, and the illusion of ‘Korean Wave’ celebrities.

To do so, this paper would try to demonstrate how the influence of today’s global concept of ‘design’ has led to the concretization and/or generalization of the vernacular object as well as its regional and cultural conventions, a process which results in the acquisition of a new character for the object in question.

In addition, through such an approach, I seek to examine how design, as a particular institutional production and cultural standard, in the process of being mobilized and executed as a mechanism of governance, established the concept of ‘the other and minority in need of design’ to which it applied itself as ‘design(-as-problem-solving)’. In doing so, this paper hopes to provide reflections on the ways in which the pre-existing meaning of things become re-identified and its order reorganized through ‘design’—which purportedly pursues *the good* and *the better*—and how, through such a process, the initial ‘design’ that originated from the people (simultaneously) have become obscured (or vanished); furthermore, how design as a concept (that represents improvement and solution of problems, and above all, ‘something chic’) and its practice become constituted.

For this purpose, this research surveys media reports and other writings on the changing aspects of *pojang-machas* in Korea, and especially in Seoul. It will analyse how, in each different period, *pojang-machas* become involved in certain social, institutional, and sentimental changes. Moreover, it considers what kinds of scientific and technological knowledge are shared in this process of change among the public and at the institutional level, and

(Dis)Placement of/by design: social construction of *pojang-macha* (re)designing in Seoul

how the design of *pojang-machas*, which materializes the content of such knowledge, evolves over time.

Korean *pojang-machas* are, in short, vendors that serve alcohol along with simple Korean street fare (i.e. fish cakes, seaweed rolls, blood sausage, stir-fried rice cake, etc.). While the actual origins of the term itself are unclear, to this day *pojang-machas* are characterized by a two or three wheeled box-like ‘macha’ (馬車 or ‘wagon’) covered by a polyethylene tarpaulin ‘pojang’ (布帳 or ‘wrapping’/‘covering’) under which cooking and serving of customers can be carried out. Unlike more permanent establishments housed in buildings, *pojang-machas* allow their owners an opportunity to operate with moderate start-up costs and without concern for rent or other such expenses. As a means of subsistence for those with limited options, *pojang-machas* have long formed a facet of the complex image of the sprawling metropolis that is Seoul—a modern city whose conscious emphasis on that very modernity leads to the possibility of anything, at any time, being deemed ‘problematic’.

Pojang-machas, blurred history

In Seoul, *pojang-machas* that conform to the standard Korean definition of ‘a covered, mobile food and drink stall of a temporary nature’ (The National Institute of the Korean Language, 1991) are not easy to come by. In particular, ‘*pojang-macha* towns’ where *pojang-machas* are densely packed together, can now only be spotted in a few places such as Jong-ro, Dongdaemun Market, Yeouido, Sindorim, Sincheon, Sinchon, and the vicinity of Gangbyeon Station. For those who have been to one of Seoul’s *pojang-machas* in the 1970s and 80s, *pojang-macha* is still remembered as ‘a place where one can fill up the stomach with little money’, ‘a place to have a bottle of soju [a popular distilled beverage in Korea] just for a little while after work’. These scenes are now becoming a thing of the past (Kang, 2012).

Pojang-macha is a translated word that is presumed to have first appeared in Korea in the 1950s via newspapers and other media. Interestingly, in the news reports of the time, the term ‘*pojang-macha*’ was referring to the ‘covered wagons’ appearing in the American Western films that were then being introduced in Korea, not to ‘street pubs’ as the word is commonly used today (Entertainment Programs, 1954). Afterwards, through the 1960s and 70s, the word ‘*pojang-macha*’ continued to be used to indicate both of the meanings just noted. The *pojang-machas* as ‘temporary

night pubs in Seoul’ that are reported to have appeared in the 1950s were ‘selling broiled sparrows and soju inside a structure of which only the top was covered with a thick broadcloth’ (Song, 2003). The appearance and the structure of *pojang-macha*, which amounted to not much more than ‘a wheeled hut with broadcloth that just barely covered its frames’ when it first appeared, undergo a structural reinforcement and become transformed into something more decent, something that a quick look would suggest as unproblematic in its appearance from a commonsensical point of view. What drove this shift was a certain judgement on the proper appearance and structure of artificial objects that was likely furnished by the shared knowledge and experience of contemporary science and technology.

In the 1960s, *pojang-machas* were often depicted in the media as somewhat dim and dingy—e.g. ‘carbide lighting under canvas’—but, over the 1970s and 80s, they expand their interior and increase the number of items on their menus while simultaneously transforming themselves into more solid structures that incorporate comfort in the modern sense of the term.

Due to various needs—the need to light up the dark interior as it is ‘more active during the night’, the need to provide warmth to guests that visit the ‘business’ to seek relief from the cold during winter, and the need to keep ingredients (especially seafood) fresh and prevent them from spoiling in the summer—*pojang-machas* begin to incorporate a system and network of electricity, gas, and other infrastructures, arranged into certain standard notions and materials that embody them. The design components that compose *pojang-machas*, which have been devised through a compromise that arise from the competition and coexistence of ‘similar businesses’, reflect, as noted above, the judgements, sentiment, and consent of the ‘people’ rather than the seriousness of expert designers who emphasize ‘sufficient aesthetic consideration (with a view of overall harmony)’.



Figure 1 *Pojang-macha in the 1970s (left). Pojang-macha in the 1980s (middle). Pojang-macha in the 1990s (right). Yoon (1977); The Business Thriving in the Heat... Pojang-machas (1983); Jung and Park (1997).*

(Dis)Placement of/by design: social construction of *pojang-macha* (re)designing in Seoul

As shown in figure 1, the appearance of *pojang-machas* becomes modified in the period from the 1970s to the 1990s. In the picture on the left from the 1970s, one can see that a wooden post in the centre sustains the structure of the *pojang-macha*. By contrast, in the *pojang-macha* of the 1990s on the right, the post's material has changed to stainless steel, and the interior has become wider, in step with the resulting enhancement in structural firmness. The black and white picture in the middle displays a *pojang-macha* town in one summer night from the 1980s. The pictorial coconut palm trees that are printed as decoration for the plastic mesh awnings represent a pictorial vacation destination for the summer pedestrians (Kang, 2012). Such appearance and structure of *pojang-machas* or, in other words, the grammar and literacy of design were devised and improved by the anonymous at the level of the people and shared by 'looking sideways and imitating' in ways difficult to trace the specific origins.

Pojang-machas in its haphazard form materialized the 'sentiment of discontent and romantic ideals of the deprived and the worn-out'. The embodiments of such sentiment were founded on the culture of ordinary working-class people that distinguishes itself from the living culture of the middle class and its tidiness and certainty. In particular, the mobility entailed by *pojang-machas* functioning as businesses with unclear boundaries and in the form of 'wheeled, temporary pubs on the street' allowed *pojang-machas* to be clearly different from other types of places for drinking. The vitality of *pojang-machas* meshed together with the dynamism of Seoul as a 'growing city', and *pojang-machas* were often set up in the vicinities of subway stations and bus terminals that connected business districts with nearby residential areas.

Landscape of traditional zone

There had always been a sense of institutional ambiguity surrounding *pojang-machas'* form of existence. For example, *pojang-machas* stand halfway between a street and a demarcated space and simultaneously have the features of an open exterior and an enclosed interior. These qualities make *pojang-machas* drift, within the institutional framework, between the zone of illegality at times and the zone of implicit permission at others. In addition, they also allowed the *pojang-machas* to actively utilize the subtle boundary between illegality and legality (authorization). As Um and Kim (2010) point out, 'it is difficult to regulate street vendors under uniform criteria and principles, as they have taken root as practical markets in some

cases, and, at the same time, as there exists a partial contradiction between the legal justice regarding street vendors and the policy goal of protecting the livelihood of the low-income citizens.' Such 'contradictions surrounding street vending spaces' equally applied to *pojang-machas*.

At *pojang-machas* there were constant experiments and attempts concerning fun and taste as a way to soothe the sorrows of city life, based on the notion of equality. *Pojang-machas* firmly established themselves, both economically and culturally, as the 'barometer of ordinary people's economy', and re-emerges as a 'boundary object' (Star and Griesemer, 1989) as they continuously collide with the state that attempts institutionally to regulate and administer them. There are temporal variations in which goals become prioritized, but the criteria for the regulation, administration and control have always been related to the regulation of the risks perceived by the state and also the concept of urban aesthetics set by the state. Such state actions have been the primary factor in the efforts of *pojang-machas* to modify its identity and achieve the order of things that constructs and supports that identity. *Pojang-machas* have realized their borderline characteristics of 'being simultaneously legal and illegal' in the actual sites of their livelihood. That is, they have realized new 'illegal' existence in arbitrarily interpreting and reasonably applying the provisions of current regulations, and managed to satisfy 'legal' conditions in re-identifying themselves as objects that can be administered.

The concept of hygiene and the universalization of its practice were reflected by the operation of *pojang-machas* even before the state began to exert its influence on *pojang-machas'* form of existence. A newspaper editorial from 1983 allows one to observe the concept of hygiene under which the contemporary *pojang-machas* had to be run. In that piece, the author laments how 'the *pojang-machas* of Seoul' wipe 'tables' not with dishcloths but with 'rags,' and how the same rags were used to clean 'cutting boards' and 'knives', and then used again as 'dishcloths' when slicing fresh livers and chicken gizzards (Business Thriving in the Heat. *Pojang-machas*, 1983). In particular, the author points out that in comparison to the food carts in cities of 'San Francisco' and 'Taipei', *pojang-machas* of Seoul fall far behind with respect to hygiene. 'Seoul, from now on' had to elevate itself to the same level as San Francisco and Taipei by eliminating hygiene issues, and *pojang-machas*, as an important part of the scene in Seoul's streets at night, had to take part in this effort.

By the 1980s and 90s, the outbreak of diseases such as 'Vibrio Vulnificus infection' and 'cholera' of which the main conditions and reasons for

(Dis)Placement of/by design: social construction of *pojang-macha* (re)designing in Seoul

occurrence and their mechanisms of social control and treatment were confirmed, provided a boost in launching an official crackdown on *pojang-machas*. The levels of 'general bacteria' and 'E. Coli' that were found in *pojang-machas* raised doubts among the public about the quality of sanitation in *pojang-machas* even when standard levels for relative comparison were not presented (*Pojang-macha Food Swarming with Bacteria*, 1989).

The Korean government, which hosted a number of major international events such as the Annual Meeting of the IMF (1985), the Seoul Asian Games (1986), and the Seoul Olympics (1988), embarked on a major regulatory effort regarding *pojang-machas* (*Hygiene Map of Pojang-machas*, 1986). The stated purpose of this effort as announced by the administration were based on 'the principles of the state' which included, in addition to the issue of public hygiene, 'establishing public order in the streets' and 'maintenance of urban aesthetics'. The Korean government had high expectations about not just the direct economic benefits but also the cultural PR effect that major international events were purported to bring. International sports events such as the Asian Games and the Olympic Games were seen as the opportunity to artificially arrange and officially publicize the Korean achievements of 'miraculous development' to the foreign cultural realm. For this reason, it was necessary to showcase and manage a 'modern-western landscape that does not elicit disgust' in line with the advanced cultural standards set and pursued by Korea (Kang, 2012). The crackdown against *pojang-machas* around the Seoul Olympic Games in 1988 was met with an especially fierce resistance by the owners. The *pojang-macha* town of Seokchon Lake where 'athletes from various countries streamed in to enjoy their last night in Seoul' (*Pojang-machas Near Seokchon Lake Bustled with Foreigners Last Night*, 1988) on the day of the closing ceremony of the Olympics, was subject to a 'surprise demolition' a few months after the end of the Olympic Games (*Pojang-macha Food Swarming with Bacteria*, 1989). The *pojang-machas*, which had been summoned by the state after being recognized for their utility as a medium through which the foreigners/outsideers from the 'advanced Western world' could pleasantly experience Korean culture, were forced to re-enter the territory of problem. The *pojang-macha* vendors who lost their economic foundations took to the streets, demanding 'the guarantee of livelihood' (*All-Night Sit-In by Eighty Seokchon Lake Street Vendors in Protest of Demolition*, 1989).



Figure 2 Protest against overzealous crackdown on street vendors. Kwak (1989).

Figure 2 is a picture of a street vendors' protest where the vendors claimed their 'right to livelihood', stating that 'nothing is more urgent than making ends meet for the people'. Their fight against crackdowns on street vending (including *pojang-machas*) became more pronounced and drawn-out after the Seoul Olympic Games. *Pojang-macha* vendors, in their continuing conflict with the state, defined themselves as the grass roots or the 'working-class citizens who have the right to decent human life' and asked of the state whether 'the discipline of the state' should have precedence over 'the people's right to livelihood (people's right)', or vice versa.

In the ensuing years, *pojang-machas* progressively broke away from its self-identity which had oscillated between legality and illegality with respect to the principles and criteria of risk management (which appears to be more directly related to the contents of science and technology) and urban aesthetics (which seems more directly related to the contents of design). In 1985, ultramodern (by contemporary standards) *pojang-macha* 'with even electricity and water pipes' began to appear in and around Seoul's Gangnam area (Kim, 1985), which the K-Pop hit 'Gangnam Style' happens to have promoted 17 years later. A little after, in 1987, 'luxury *pojang-machas*' with neater exterior and interior equipped with television and refrigerators, 'bustled with people' in Seoul's Gangdong, where the Olympic stadiums were located, and Gangnam, which was not far from that area (Super Luxury Summer *Pojang-machas*, 1987). At 'the people's level', the modernization of *pojang-machas* or the competition of design among the *pojang-machas* further intensified in the early to mid-1990s when Korean consumerism hit its post-Korean War peak.

(Dis)Placement of/by design: social construction of *pojang-macha* (re)designing in Seoul



Figure 3 *Pojang-machas* now accepting credit cards. Indefinite Crackdown on *Pojang-machas* (1991).

The Asian financial crisis that began in 1997 (also commonly referred to as the IMF crisis or foreign exchange crisis in Korea) exerted its impact on *pojang-machas* as well, once again prompting their change. Many among the ‘salarymen that were laid off by firms’, who were once the ‘guests’ of *pojang-machas*, now became the ‘owners’ of *pojang-machas*. Encouraged by the myth that everyone can easily open a *pojang-macha* business due to its low entry barrier, ‘orders for *pojang-macha* structures’ flooded in, and ‘nearly all the people who received severance pays considered opening *pojang-macha* business at one time or another’ (Song, 2003). In fact, according to a 2001 report by the Seoul Development Institute, those who began street vending after the financial crisis were younger and better educated than those who were already in the business (Kim, 2011).

Nonetheless, this does not mean that the unique character of *pojang-machas* or the form of their existence has changed. When Seoul’s streets were restructured for the management and maintenance of ‘urban aesthetics’ or resurfaced in accordance with the institutional practice of ‘crackdown on squatting’, *pojang-machas* were always also ‘put under maintenance and renovated’. Prepared foods that could endanger ‘public health’ had been banned (Prepared Food Such as Topokki, Grilled Eel, Fish Cake Can No Longer Be Sold in *Pojang-machas*, 1992), and some highlighted the danger and immorality of *pojang-machas* citing that they could encourage juvenile delinquency (*Pojang-machas* Banished from Daehak-ro, 1995).

(Re)Designing of *pojang-macha*

In February of 2007 (under mayor Oh, Se-hoon), Seoul Metropolitan Government announced the introduction of a ‘Special Administrative Measure’ regarding vendors. *Pojang-machas* in particular were re-identified

as causing discomfort to citizens at large in the course of their daily lives as well as having a negative impact on the street environment and its *landscape*. As such, the *pojang-macha* became the candidate object for 'rational and aesthetic modification' *again*. While this was by no means the first time the city as *governor* experienced rumblings with regard to the 'problematic' nature of *pojang-machas* (be it the arena of aesthetics, health and hygiene, or difficulties of administration/accountability), the approach and goals of the 2007 project were markedly different; *pojang-machas* were clearly being considered as potential objects of cultural administration. Indeed, it is in the process of putting this consideration into action that the concept and role of 'design' take real effect.

This attempt to analyse institutionally the existing *pojang-machas* and redesign them in ways that conform to regulations, with the goal of enhancing the cultural life of Seoul's streets was pushed forward as part of the 'public design' project of the then Mayor Oh, Se-hoon. Through this attempt, *pojang-machas* were transformed into one of the public facilities of which the purpose should be to 'render the street landscape more pleasant and make citizens safer and happier' (DesignSeoul Headquarters of Seoul Metropolitan Government, 2008). In accordance with the administrative approach to redesign them, *Pojang-machas* were given a new 'role', 'responsibility' and, in addition, 'legibility' (Scott, 1998).

Under the auspices of this 'Special Administrative Measure,' the streets became populated with *pojang-machas* produced according to the fixed standards and regulations of Seoul Metropolitan Government. These standards and regulations, in turn, were the product of near-scientific analysis of long-standing independent *pojang-macha* use-patterns, reflecting considerations such as: the (in)formal institutional negotiation between a vernacular object and resources of urban infrastructure that are both quantifiable and regulated (i.e. electricity, gas, water); the concretization of and adherence to the concept of hygiene, as well as rationality and efficiency, on the part of clinical medicine; the aesthetics of cultural interpretation/dramatic production of 'design for design's sake' policy; and, most of all, the awareness and adoption of the need for 'design' in the makeover of the city of Seoul. After this facelift, the previous interface of *pojang-machas* was no longer to be found within Seoul but rather found outside of it. This shift reached its apex when Seoul was chosen as 2010's World Design Capital by UNESCO— a shift that reflects the city's own shift in self-identification from the symbol of the nation's successful industrialization to an international cultural destination.



Figure 4 Official logo of '2010 Seoul, UNESCO City of Design' (left). Promotional picture by the city of Seoul capturing the celebration after the city was selected as the '2010 World Design Capital' (middle). Former mayor Oh, Se-hoon, who bulldozed the urban aesthetics project appealing to 'design' as the guiding theme (right). Seoul Design Foundation (2010); Seoul Metropolitan Government (2010); NEWSis (2010).

However, the new design of *pojang-machas* that were suggested/fostered as a standard that can exist within the zone of legality, were not sufficiently utilized and/or did not survive as expected, in its original environment—the various streets of Seoul. The proposed designs for *pojang-machas*, which were polished in design studios that functioned in the same manner as laboratories, also failed to consider the actors and the agencies already involved in *pojang-machas* or newcomers and the realization of the whole business. Furthermore, they failed to capture and tame the ways in which they would interact. The new 'design' of *pojang-machas*, which was proposed as the pursued ideal, was concretized through an administrative process, aiming to reflect—through 'sufficient simulation'—the structural efficiency and rationality that science and technology have identified, but the real environment in which *pojang-machas* had been constructed turned out to be much more dynamic and complex.



Figure 5 (Re)Design suggestions for *pojang-macha* proffered by Seoul Metropolitan Government (left). Vendors pushing out the *pojang-macha* provided by Seoul Metropolitan Government immediately after its installation (middle). Picture of a legal *pojang-macha* managed by Mapo-gu Office (right). As it is installed at a permitted location, it does not need to be removed during the

day. *NEWSis* (2010); *NoCutNews* (2010); *Photo by Kim* (2013) with permission (personal communication).

At the end, as of 2014, the new *pojang-machas* which were the object of hope for acquiring an administratively sound and healthy identity, are being neglected and disregarded, perhaps due to the loss of its 'wild charm' at the hands of 'design' that represents *the good* and *the better*. As a result of this, the existing *pojang-machas* that were not seized or could not be seized by 'design' have gained the upper hand in the survival competition based on otherness and in-betweenness.

Conclusion

The case of *pojang-macha* redesigning, performed from an institutional approach, illustrates that the 'structural efficiency and rationality that science and technology have identified' are mobilized and applied when existing (problematic) artifacts are put under pressure to adjust or update themselves to a more sound and wholesome level, due to institutional demands and the need for socio-cultural display.

In light of the initial expectations, the newly designed *pojang-machas* are certainly insufficiently active/functional. This, however, does not mean the failure of 'design'. Rather, the (ideal) authority of expert design that transcends administrative procedures might have been further bolstered instead of being diminished. It is because the (expected) 'design' was not achieved (once again). Thanks to this resulting characteristic of 'design' (as plan and scheme), design is turned into a pure ideal (or chimera) of aspiration. It is because a door will open up for 'the (need for) pursuit of what is better'. We can also note that the actor who captures and utilizes this operational mechanism of design will be able to wield power as a result.

If so, tracing the administrative (re)treatment case of street vendors in Seoul could lead us to the following questions. Under the rules of artifacts that are effects of 'design', what place could today's science, technology and their aesthetics justify and secure for themselves in everyday life, in which many modern concepts and epistemologies are generalized? And then, there could be other questions, regarding the institutionalized nature of today's design and the methodologies of its cultural and economic realization. (Because, in 'design', the ongoing debate is usually—almost always— drawn from science and technology, from notions of rationality, efficiency and their (constructed) 'facts'.) Accordingly, we could ask: which

(Dis)Placement of/by design: social construction of *pojang-macha* (re)designing in Seoul
forms will eventually be defined as 'design' and how/what science and
technology will (de)form those designs of today?

References

- DesignSeoul Headquarters of Seoul Metropolitan Government (2008) *DesignSeoul Guidelines*. Seoul: Seoul Metropolitan Government.
- Hughes, T.P. (2005) *Human-Built World: How to Think about Technology and Culture*. Chicago: University Of Chicago Press.
- Jung, J. and Park, J. (1997) Exhausting Life, 'Living for Tomorrow' [in Korean]. *The Hankyoreh*, 12/27/1997, 9.
- Kang, B. (2012) The Cultural-Historical Landscape of Korean Bar Tent, Pojang-ma-cha. *Journal of Leisure Studies*, 10 (2), 23-54.
- Kim, G. (1983) A Wanting Feeling amid *Pojang-machas* [in Korean]. *The Dong-A Ilbo*, 11/30/1983, 3.
- Kim, J. (2011) A Study on the Use of City Space and the Rights of Street Vendors: Focused on the Formation of Street Vendors Movement in 1980s. *Space & Environment*, 36, 66-101.
- Kim, Y. (1985) Ultramodern *Pojang-machas* of Sinsa-dong with Electricity and Water Pipes [in Korean]. *The Kyunghyang Shinmun*, 12/24/1985, 6.
- Kwak, Y. (1989) Protest against Overzealous Crackdown on *Pojang-machas* [in Korean]. *The Hankyoreh*, 7/5/1989, 10.
- Lee, S. (1999) *Pojang-machas* now accepting credit card [in Korean]. *The Kyunghyang Shinmun*, 10/29/1999, 11.
- N.A. (1989) All-Night Sit-In by Eighty Seokchon Lake Street Vendors in Protest of Demolition [in Korean]. *The Dong-A Ilbo*, 7/13/1989, 14.
- N.A. (1983) Business Thriving in the Heat... *Pojang-machas* [in Korean]. *The Dong-A Ilbo*, 8/3/1983, 7.
- N.A. (1985) Case of *Vibrio Vulnificus* Infection Sends Shockwaves... Sales of Sashimi Restaurants and *Pojang-machas* Plummet [in Korean]. *The Dong-A Ilbo*, 7/17/1985, 7.
- N.A. (1954) Entertainment Programs [in Korean]. *The Dong-A Ilbo*, 4/18/1954, 17.
- N.A. (1986) Hygiene Map of *Pojang-machas* [in Korean]. *The Dong-A Ilbo* 5/2/1986, 11.
- N.A. (1991) Indefinite Crackdown on *Pojang-machas* [in Korean]. *The Kyunghyang Shinmun*, 8/23/1991, 13.
- N.A. (1995) *Pojang-machas* Banished from Daehak-ro [in Korean]. *Maeil Business Newspaper*, 8/30/1995, 36.

- N.A. (1989) *Pojang-macha* Food Swarming with Bacteria [in Korean]. *The Kyunghyang Shinmun*, 7/8/1989, 13.
- N.A. (1988) *Pojang-machas* Near Seokchon Lake Bustled with Foreigners Last Night [in Korean]. *The Kyunghyang Shinmun*, 10/3/1988, 15.
- N.A. (1992) Prepared Food Such as Topokki, Grilled Eel, Fish Cake Can No Longer Be Sold in *Pojang-machas* [in Korean]. *The Kyunghyang Shinmun*, 6/7/1992, 16.
- N.A. (1987) Super Luxury Summer *Pojang-machas* [in Korean]. *The Kyunghyang Shinmun*, 6/30/1987, 12 .
- The National Institute of the Korean Language (1991) *Unabridged Standard Korean Dictionary* [in Korean]. [Online] Available from: <http://stdweb2.korean.go.kr/main.jsp> [Accessed: 8th Nov 2014].
- Scott, J.C. (1999) *Seeing like a State: How Certain Schemes to Improve the Human Condition Have Failed*. New Haven: Yale University Press.
- Seoul Design Foundation (2010) *Seoul Became a Member of UNESCO Creative Cites for Design*. [Online] 20th July. Available from: http://www.seouldesign.or.kr/eng/program/unesco_biz.jsp [Accessed: 8th Nov 2014].
- Song, H. (2003) Dozing Off Tonight with a Drink at '*Pojang-macha*' [in Korean]. *Weekly Dong-A*, 12/18/2003, 20-21.
- Star, S.L. and Griesemer, J.R. (1989). Institutional Ecology, 'Translations' and Boundary Objects: Amateurs and Professionals in Berkley's Museum of Vertebrate Zoology, 1907-39. *Social Studies of Science*, 19 (3), 387-420.
- Um, J. and Kim, S. (2010) A Study on Perception of Journalism on Space Shown in the Reports Related to Stall Vendors. *Korean Journal of Journalism & Communication Studies*, 54 (3), 255-275.
- Vial, S. (2010) *Court Traité du Design*. Paris: Presses Universitaires de France.
- Yoon, G. (1989) Seokchon Lake *Pojang-machas* Torn Down in Surprise [in Korean]. *The Kyunghyang Shinmun*, 7/8/1989, 14.
- Yoon, O. (1977) Broiled Sparrows Reappear after Five Years Absence [in Korean]. *The Kyunghyang Shinmun*, 11/23/1977, 6.

Cities transformations, social innovation and service design

Alessandro Deserti^a and Francesca Rizzo^{b*}

^a Politecnico di Milano; ^b University of Bologna

Cities are nowadays facing disruptive challenges calling for smarter solutions and creating pressure for the public and the private sectors to deliver innovative services better responding to the needs of citizens. Great expectations are put in the Smart City paradigm, but most of the solutions just rely on technologies and are thus far from the urban functioning, people and their daily life. In this framework design is orienting its theories and practices towards a different paradigm, putting people at the centre of the smartness of cities by recognizing the need of developing micro and contextualized solutions that can be subsequently scaled up to achieve larger social impacts (Murray, Caulier-Grice and Mulgan, 2010). The Human Smart City paradigm (Concilio, Deserti and Rizzo, 2014) relies on the capability of the city to realize and scale up intangible infrastructures based on new typologies of partnerships for the development of services. The paper presents this vision by discussing the first results of MyNeighborhood, a European project that is experimenting the HSC paradigm in the development of collaborative services in 4 different European neighbourhoods.

Keywords: Human smart city; service design; complex participatory design; social Innovation

The Human Smart City Paradigm

The world's urban population is expected to double by 2050. By 2030, six out of every ten people will live in a city and by 2050 this figure will run to seven out of ten (World Health Organization, 2014). In real terms, the number of urban residents is growing by nearly 60 million people every year. As the planet becomes more urban, cities need to become smarter and major urbanisation requires new ways of managing the growing complexity of urban living.

* Corresponding author: **Francesca Rizzo** | e-mail: f.rizzo@unibo.it

In this context the concept of Smart City (SC) emerged as an innovative modus operandi for the future urban living and as a key strategy to tackle wicked everyday problems and challenges for citizens. Despite the current wave of discussion and debate on the value, function and future of SC, as a concept it resists easy definition. At its core, the idea of SC is rooted in the creation and connection of human capital, social capital and Information and Communication Technology (ICT) infrastructure in order to generate greater and more sustainable economic development and a better quality of life (Directorate General for Internal Policies, 2014). In truth, there are many perspectives on SC: some focus on ICT as a driver and enabler, while broader definitions include socio-economic, governance and multi-stakeholder aspects, such as the use of social participation to enhance sustainability, quality of life and urban welfare. This paper embraces the concept of Human Smart City (HSC), developed in the context of the European Projects *Periphèria* (www.periphèria.eu) and *MyNeighbourhood* (www.my-neighbourhood.eu). A HSC is a city that seeks to address public and societal issues (or wicked and unmet people problems) via ICT-based solutions on the basis of complex multi-stakeholder partnerships, including the same municipalities (Concilio, Deserti and Rizzo, 2014). These solutions are developed and refined through public and collaborative services, or else services that are co-designed and co-produced between citizens and public and private stakeholders.

The HSC approach relies on two main pillars: (i) ICT is only a component of the solutions; (ii) solutions can be seen as forms of social innovation. In relation to the first pillar the HSC approach suggests to overturn the design process of the SC solutions from the dominant paradigm that moves from technology to solutions to the emerging one that moves from problems to solutions considering all the available resources (design thinking approach).

In relation to the second pillar, an overview of the social innovation phenomenon suggests that it primarily takes the form of a constellation of small initiatives generated by creative communities and collaborative organisations (Meroni, 2007). The proposition behind HSC is that these small, local social innovations and their working prototypes can be scaled-up, consolidated, replicated, and integrated with larger programmes to generate large-scale sustainable transformation for which favourable conditions might be created by some strategic actors.

In the following the paper will illustrate the development of this paradigm and the experimentation of the service design methods within the *MyNeighbourhood* project.

The MyNeighbourhood Project

MyNeighbourhood is a EU-funded research project started in January 2013 with the goal of applying service design methods and tools in 4 different European neighbourhoods (in Lisbon, Milano, Aalborg and Birmingham) to identify and support the establishment and the upscale of grassroots and community-based initiatives, through the adoption of a web-based service platform. The project is operating in a typical ICT research area, introducing the idea that advanced participatory design methods can make the difference in the level of innovation of the proposed solutions, since the development process starts from people and not from the available technological paradigm.

MyNeighbourhood is trying to further develop the HSC paradigm by amplifying and connecting existing grassroots social initiatives the 4 different neighbourhoods to show the potentials of connection and collaboration in designing, experimenting, assessing and upscaling smart services. In particular, *MyNeighbourhood* is experimenting the Participatory Design (PD) approach as the most suitable to develop public and collaborative services in 4 different European neighbourhoods, with the aim of building complex partnerships of actors who can co-produce the services (and keep them alive after the project). In this paper the authors will: (i) develop the relation between the *MyNeighbourhood* design framework and the concept of public and collaborative services; (ii) present the *MyNeighbourhood* aims, context of application and process and (iii) describe some of the *MyNeighbourhood* first solutions and discuss them in the light of the above-described HSC paradigm.

***MyNeighbourhood* Design Framework**

MyNeighbourhood design framework can be described by identifying (i) the objects to be designed; (ii) the design approach and (iii) the methodologies adopted to support the design process.

MyNeighbourhood focuses on the experimentation of public and collaborative services. These services are characterised by: (i) a new productive model based on the co-design and co-production of the services through new partnerships; (ii) a series of tangible and intangible artefacts through which the services are conceived, delivered, perceived and used (services blue prints, actors' maps, business models, service touch-points).

With respect to the methodology, *MyNeighbourhood* embraces the Participatory Design approach, supported by service design methods for the

design of the tools and artefacts supporting the service conception and delivery.

Public and Collaborative Services

Public and collaborative services (Baek, Manzini and Rizzo, 2010; Pueri et al., 2013) are the first asset of the *MyNeighbourhood* design framework. They have been defined as new valuable services resulting from a process of co-design and co-production that can take place through new forms of partnership involving citizens, municipalities, as well as other public and private stakeholders, which directly address the challenges that they face in their cities. Collaborative services possess a set of characteristics that the Study on Collaborative Production in eGovernment smart 2010-0075 (European Commission, 2012) has clearly described and analysed through 150 cases from across Europe: *'Not purely bottom up (...); not all about government data (...); applied across all services'*.

Complex Participatory Design

PD is the second asset of *MyNeighbourhood* design framework: the project introduces the idea of PD as the most suitable approach to create the conditions to set up and generate innovation ecosystems where citizens and networks of stakeholders can co-produce solutions in partnership with the public bodies (Binder et al., 2011; Bjorgvinsson, Ehn and Hillgren, 2010; Ehn, 2008; Halse et al., 2010; Hillgren, Serravalle and Emilson, 2011; Ho and Lee, 2012; Light, 2012).

Researchers in the design field (Bjorgvinsson, Ehn and Hillgren, 2010; Brandt and Binder, 2011; Concilio, Deserti and Rizzo, 2014; Rizzo and Deserti, 2014; Deserti and Rizzo, 2011) have argued that when contexts are complex and end-users are not the only stakeholders to be considered, PD is the most suitable approach. In these contexts it can be thus introduced as a way of envisioning possible future solutions by creating strong connections with the network of stakeholders belonging to a place, establishing a long-term engagement with local communities leading to the emergence of new practices and new opportunities for design.

To introduce this notion of PD we refer to Ehn (2008) and Bjorgvinsson, Ehn and Hillgren (2010). Both articles represent a significant contribution to the debate on participatory design since they propose a radical shift in its conceptualization: from the traditional view that considers the object to be designed as a well-defined product or service, and where final users become co-designers (Rizzo, 2010), to a new definition that sees the participation as

the design process for the realization of new long-term partnerships for the sustainability of the collaborative services. In fact what is new in this vision is the object of design from a product to a process of co-design and co-production that transform the social context (a city, a street, a neighbourhood, a square) by facing unmet social challenges. From this point of view the news that participatory design introduces with respect to the tradition of participatory design in planning and urban studies (Sclavi, 2000) are twofold: from one end the notion of participatory design here introduced refers to the construction of partnerships and new business models for innovative services that operate (here the second different) at the micro scale of the city instead of governing decision making processes on infrastructures, policy making, regulations, citizens participation to the political debate.

On the basis of this new notion, we adopt the idea that PD has become a highly dynamic process (Manzini and Rizzo, 2011). Therefore, PD can be something that also includes linear co-design processes and consensus building methodologies (i.e., the most traditional view of participatory design), but goes far beyond them, becoming a complex, articulated and often contradictory process, or else what we call Complex Participatory Design (CPD). Figure 1 (Rizzo and Cantù, 2013) exemplifies the role of design in complex participatory processes: 1) Community building, consisting in the identification of the first network of actors that will take part in the co-design process: the community moves from the recognition of a common problem and seeks to collaborate together to find a solution; 2) Encouraging usage, consisting in the real coproduction of the envisioned solution: in this phase the solution meets the context and PD acts as a continuous open innovation strategy supporting further elaboration in favour of the goodness of the solution; 3) Expanding and adapting, consisting in making the initial partnership larger and stronger by implementing a process of continuous alignment of the different interests of the actors around the solution in order to offer it in a stable way (sustainably of the solution).

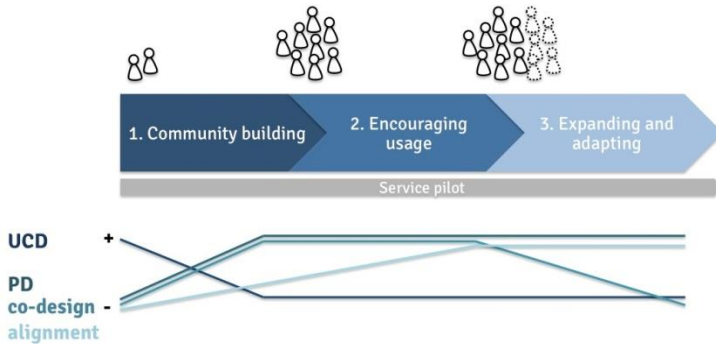


Figure 1. The figure shows that PD works better when, in the development of a collaborative service project, the process moves from the establishment of the first community to the foundation of the final stakeholders' network that will co-produce the service.

PD in *MyNeighbourhood* becomes a complex design process whose object is the realisation of an intangible infrastructure, i.e. a partnership, with local stakeholders to co-produce solutions that address situated challenges. Designers work with stakeholders to identify the emerging needs and to create digital and physical platforms that will enable participation and coproduction, being open to different project development directions and perusing the sustainability of the designed solutions.

MyNeighbourhood build on the peculiar conditions and resources of the local communities engaged in the pilot experiments, providing a platform for engagement that transcends traditional models of co-design. The challenge for is to provide evidence of what can be done beyond the co-design, with a twofold aim: (i) addressing problems of the context; (ii) establishing a long-lasting strategy of innovation for that context. The expected outputs of the experimentation of CPD are:

- The methodologies for the municipalities to manage complex participatory processes, putting together citizens, private and public stakeholders in new typologies of partnership;
- The partnerships focused on collaborative services in the 4 piloting contexts;
- A strategy of continuous open innovation to support the scaling up of the envisioned solutions.

Service Design Methods

Service design is the third asset of the *MyNeighbourhood* design framework. It focuses on (re)designing service processes and service experience, today recognised as relevant drivers of innovation. This new approach – people-centred, design-led and based on projects – is expected to bring to users and providers new expectations of quality of delivery, new business opportunities, new methods and tools to deal with innovation, both in European enterprises and in the public sector (European Commission – Design Leadership Board, 2012).

MyNeighbourhood explores the potential of service design tools to support the generation of ideas and the process of focusing entrepreneurial opportunities based on SC-enabled solutions in the pilots' contexts.

The assumption underpinning *MyNeighbourhood* is that service design routinely deal with many of the same issues that new ventures face: involving a wide variety of actors and stakeholders, creating a network of partners, building intangible experiences and outcomes and prototyping and assessing immaterial ideas before any further resources are committed to implementation.

Users orientation and contextualization are at the core of service design, which has recently emerged as the way to introduce a human-centred approach in the frame of SC (Rizzo et al., 2013). If we look at how services are designed and implemented, service design may be defined as a user-centred process meant to understand both the customers' needs and the needs of the other stakeholders involved in the service processes, exploiting this knowledge to design the service interactions (Kolko, 2011).

In *MyNeighbourhood* the Service Design contribution seeks to identify the social and functional relationships that aim to generate prosperous complementarities inside a context and to develop services able to generate social sustainability. This approach led *MyNeighbourhood* to identify the inter-relationships that may improve the quality of life inside the contexts of the project and to develop services able to generate social and relational qualities. The outcomes of this process have been a series of service projects to be piloted in the four neighbourhoods engaging local resources and actors.

MyNeighbourhood Service Design Phases

The development and the experimentation of the services were structured in 5 phases: exploration, sense making, idea generation, service design and piloting.

Exploration

Exploration deals with understanding the contexts where the design action must take place. The context analysis in *MyNeighbourhood* started with explorative activities aimed at identifying local resources. In this phase everything that could help designers to set the starting conditions for the projects was mapped: socio-economic context characteristics, points of strengths and weaknesses of the neighbourhood, entry points, active people and associations, gatekeepers, infrastructures, projects and initiatives.

Sense making

Exploration was slowly transformed into a sense making work, where the rich information collected in the exploration phase was analyzed and interpreted, in order to work out facts, uninspected elements, needs and challenges supporting design phase. The design teams formalized some semi-worked elements: maps of the stakeholders, resources maps, personas, video and pictures from the contexts, people and stakeholders WINS (wishes, interests, needs). In this phase a first hierarchy of priorities was pointed out: issues and challenges to be addressed were extracted and prioritized with respect to the stakeholders' feelings and opinions.

Idea generation

This phase was the first design activity that was conducted in collaboration between designers, citizens, stakeholders and municipalities. It was mainly devoted to working out together and sharing provisional ideas – new activities, processes, systems or touch-points – that could be turned into effective solutions to the challenges listed during the sense making activity. In each of the pilots this phase ended with a set of ideas that were analyzed and selected applying different criteria: the feasibility with respect to the available resources and to the *MyNeighbourhood* larger objectives; presence of a first group of stakeholders interested in entering the phase of service design and in experimenting with the envisioned solutions; potentiality of the idea to be scaled and to have a market; presence of a robust digital dimension with which to experiment FI solutions.

Service design

This phase moved forward the design selected design concepts to what they could become in reality. This phase included co-design activities conducted in strong collaboration with non-professionals from the context and from the municipality. The mixed team developed for each service a set of detailed design elements: the user experience, the service blueprint for front and the back end; the map of the stakeholders that would support the service implementation and delivery, the business model. With these elements the pilots started the service implementation phase.

Piloting

In the pilot phase the developed solution really enters its context to be experimented. Here local players are asked to try and test the solution to report feedbacks and feasibility hints. This phase corresponds to the activation of a prototype, in the form of a real in-place service, meant to test technical, functional and experiential features.

For the sake of brevity in the following we will report the experience conducted in the Milano pilot experimentation until the phase of service design. This article does not report information on the piloting phase, which will start at the end of May 2014.

An Example of the Envisioned Solutions: the Milano Pilot Case

The Milano pilot experiment is taking place in the Quarto Oggiaro neighbourhood, located in the northwest area of Milano, not far from where the 2015 Expo will be located. Here the entire service design process has been conducted thanks to a strong collaboration between the Politecnico di Milano (holding a long tradition in design and in urban planning research) and the Municipality. This mixed design team performed all the activities in the contexts and managed the interactions with the local communities and stakeholders to engage them in the co-design process and in the service experimentation. The First months have been dedicated to exploring and approaching the neighbourhood: the design team started understanding physical aspects of the neighbourhood, the characteristics of its population, its socio-economic dimensions, the main actors operating in the context, the relation between the neighbourhood and the rest of the city and the characteristics of the urban services already offered in the neighbourhood.

After that a period of intensive co-design meetings started. In this phase the design team established 4 different design tables, involving designers, urban planners, people from the Municipality of Milano, representatives of the local associations and people from the neighbourhood. Each table started from a complex discussion on the relevant neighbourhood issues, ending with a list of main challenges:

- regenerating disused and derelict public areas;
- improving social life and inclusion of elderly people;
- preventing school drop-outs and creating job opportunities for young people;
- exploring and testing new potential entrepreneurial opportunities and business models for start-up companies.

Starting from these challenges, the design tables then worked to elaborate four possible service ideas as smart solutions for the framed problems. Out of four, two ideas were selected for the whole development and testing process. In the following we will shortly introduce them.

The Quarto Food service

Quarto Food Club addresses the relevant needs of the quite large community of elderly people living in Quarto Oggiaro.

It is a service that combines the need to deliver food to vulnerable single elderly citizens with that of improving their social life, enjoying a meal prepared with special care and consumed in a sociable condition to relieve their sense of loneliness.

At the same time, the service aims at responding to the second neighbourhood issue of the young people unemployment, exploiting the involvement of the students from the local hoteling schools, who can receive credits for the practical training having the possibility to enter in a real food preparation and catering experience.

Specifically, the service involves two high schools in Quarto Oggiaro where students prepare every week some meals as part of their training for catering and food preparation.

Starting from this resource, the service idea is to deliver these meals to a group of elders living in the Neighbourhood, preparing for the occasion a kind of social space in the schools, where elderly can enjoy the meal together, getting in touch with each other and with the students.

The students will also have benefits from this interaction, as they will receive academic credits while their work will become visible and recognized by real end-users (figure 2).

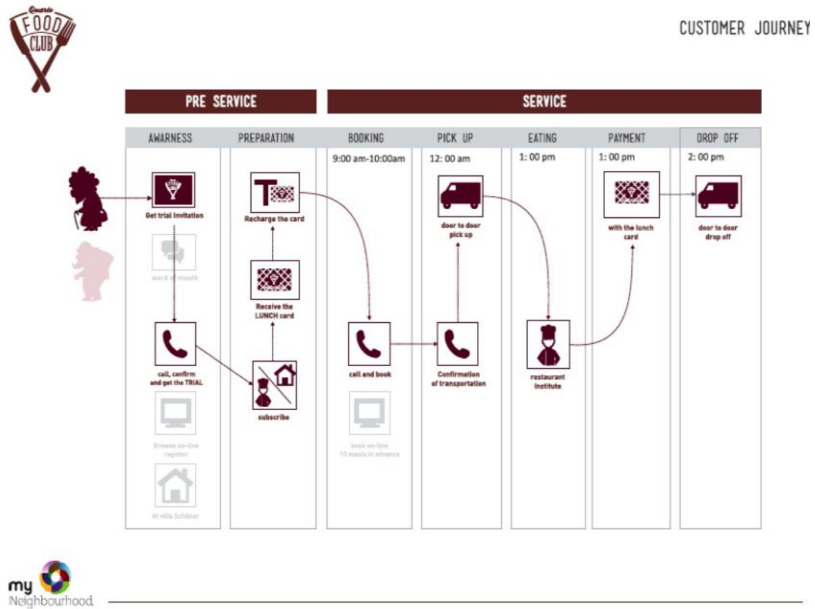


Figure 2 The Quarto Food customer journey.

The implementation of the service required the development of a formal partnership: it will be thus really delivered thanks to the agreement between the professional hoteling schools (providing the food preparation and the venue) and some local associations (providing the contact with elderly people and a van for the transportation from the private places to the school and vice versa).

Through ordinary activities of food processing, students will prepare – from 1 to 3 days per week – meals for the target group. An IT platform will support the process of the booking of the meal and the trip, and a personal rechargeable lunch card will be provided to the users to partially cover the costs of the meal and the service.

The Quarto Gardening Service

Quarto Gardening is based on the same structure of Quarto Food, and consists in a co-designed service that provides the possibility for the

Municipality of exploiting the competences of the students of the Quarto Oggiaro agricultural school to take care of some the green areas in the neighbourhood.

The service is made possible thanks to the agreement between the management of collective green areas (Municipality of Milano and the public institute for Social Housing in Milano) and the local agricultural high school. Through practical training activities, where teaching credits are acknowledged, students will take care of some green spaces in the neighbourhood. A focal point for the experimentation of the service could be Piazza Capuana, the crucial place in Quarto Oggiaro, where the service is planned to start. This choice was made in order to make the impact of the service and the action of the *MyNeighbourhood* project highly visible in the local community (figure 3).

The service goal is to contribute to reducing the expenditure for the maintenance of public green areas, regenerating public spaces and experimenting new opportunities for young people by testing a new business model. The beneficiaries would be both public like the municipality and private, for example the building managers, resident citizens.

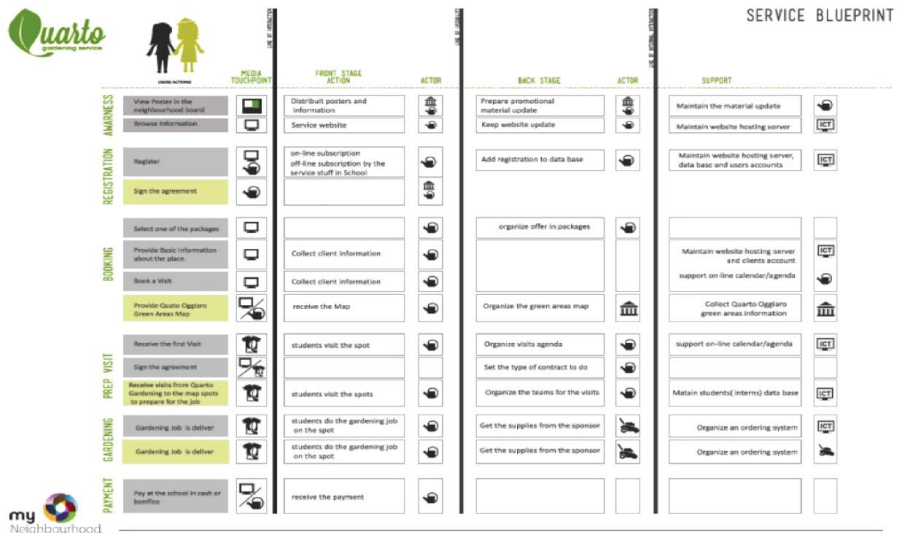


Figure 3 The Quarto Gardening service blue print.

Conclusion

The approach presented in this paper focuses on the construction of a design framework for the development of public and collaborative services in the frame of the HSC paradigm. This paradigm is based on the idea of involving local players in the design process, generating local solutions that can be subsequently transferred and scaled up. The experimentation of this approach is still on-going, but we can draw a few conclusions from the service design phase, taking into account the processes, the tools and the interaction among the subjects that took part in the experimentation.

The bottom-up nature of the people-centred services made clear that in their design and implementation in cities it is fundamental to consider a range of questions bound to their relation with a more strategic level. Are the objectives of the local services relevant, appropriate and aligned with the broader city development objectives? Does the initiative address problems of importance to the city in question? Is the mix of funding, participation, components and characteristics likely to produce the expected outcomes? If possible, it is important to consider larger impacts than just the local ones.

If we want the HSC vision to deserve consideration from the municipalities across Europe and worldwide, as well as from the SC research community, as a way to foster a new more sustainable urban development by developing better services, the experimentation conducted in *MyNeighbourhood* help us drawing a few general conclusions:

1. Complex Participatory Design, as defined above, needs to become an institutional point of view and to be adopted by the municipalities that recognise the need to build new service infrastructures through innovative productive partnerships;
2. Even if the core value of the public and collaborative services resides in the meaningfulness that they can offer with respect to the solution of wicked problems, up to societal challenges not met by the standard offering of public services, to be implemented they first have to deliver value for the partners taking part in the network;
3. Innovative solutions can be built starting from a specific context, but we must find ways to reconnect them to a wider frame to create general urban value. A context-dependent model of urban development appears to offer a structure within which to shape new dynamics between top-down policy

development in the whole cities and bottom-up experiments in the local contexts.

The last point is at the core of the lesson learnt from *MyNeighbourhood*: design-driven experiments with public services become social innovation when they are reconnected to a larger frame, and when the experimented solutions are synergized with others and scaled up. This means that the traditional top-down perspective of the public bodies can be usefully integrated with the capacity of being close to the real needs of citizens that comes from the PD practices, recognizing 'weak signals' and turning them in solutions to be tested, assessed and amplified in connection with a larger vision.

Acknowledgements

The results presented in this paper were developed by the authors within the EU-funded project MyNeighbourhood (Grant agreement N. 325227).

References

- Baek, J., Manzini, E. and Rizzo F. (2010) *Sustainable Collaborative Services on the Digital Platform*. Paper presented at the Proceedings of the Design Research Society Conference, Université de Montréal.
- Bjorgvinsson, E., Ehn, P. and Hillgren, P.A. (2010) *Participatory Design and Democratizing Innovation*. Paper presented at Proceedings of the 11th Biennial Participatory Design Conference. New York: ACM.
- Brandt, E. and Binder, T. (2011) *Six Views in a Box. Dialogues on Everyday Life with Alzheimer's*. Copenhagen: The Danish Design School Press.
- Concilio, G., Deserti, A. and Rizzo, F. (2014) *The Human Approach to Smart Cities: The Periphèria Project as a Case of Complex Participatory Design*. Paper presented at the Proceedings of Fourth International Forum of Design as a Process, Conselho Sales. Barbacena: EdUEMG.
- Deserti, A. and Rizzo, F. (2014) Design and the Cultures of Enterprises. *Design Issues*, 30 (1), 36-56.
- European Commission (2012) *Study on Collaborative Production in eGovernment (smart 2010-0075). Part 1. Practice and Implications*.
- European Commission - Design Leadership Board (2012), *Design for Growth and Prosperity*.

- Ehn, P. (2008) *Participation in Design Things*. Paper presented at Proceedings of the 10th Biennial Participatory Design Conference. New York: ACM.
- Halse, J., Brandt, E., Clark, B. and Binder, T. (2010) *Rehearsing the Future*. Copenhagen: Danish Design School Press.
- Hillgren, P.A., Seravalli, A. and Emilson, A. (2011) Prototyping and Infrastructuring in Design for Social Innovation. *CoDesign International Journal of CoCreation in Design and the Arts*, 7 (3-4), 169-183.
- Ho, D.K.L. and Lee, Y. (2012) *New Roles of Designers in Democratic Innovation: a Case Study in the Ingenuity of Ageing*. Paper presented at the Proceedings of the Participatory Design Conference, Volume 2. New York: ACM.
- Kolko, J. (2011) *Thoughts on Interaction Design*. Burlington: Morgan Kaufmann.
- Light, A. (2011) *Democratising Technology: Making Transformation using Designing, Performance and Props*. Paper presented at the proceedings of Conference on Human Factors in Computing Systems Conference. New York: ACM.
- Manzini, E. and Rizzo, F. (2011) Small projects/large changes: Participatory design as an open participated process. *CoDesign International Journal of CoCreation in Design and the Arts*, 7 (3-4), 199-215.
- Manzini, E. and Rizzo, F. (2012) *The SEE Project: a Cases-Based Study to Investigate the Role of Design in Social Innovation Initiatives for Smart Cities*. Paper presented at the Proceedings of INPUT 2012 Seventh International Conference on Informatics and Urban and Regional Planning. Milano: Franco Angeli.
- Meroni, A. (2007) *Creative Communities. People Inventing Sustainable Ways of Living*. Milano: Polidesign.
- Meroni, A. and Sangiorgi, D. (2011) *Design for Services*. Farnham: Gower.
- Murray, R., Caulier-Grice, J. and Mulgan, G. (2010) *The Open Book of Social Innovation*. Report published by NESTA and The Young Foundation.
- Pueri, E., Concilio, G., Longo, A. and Rizzo, F. (2013) *Innovating Public Services in Urban Environments: SOC Inspired Strategy Proposal*. Paper presented at the Proceeding of 8th International Forum on Knowledge Asset Dynamics. Segreb, Croatia.
- Rizzo, F. (2010) *Co-design versus User Centred Design: Framing the Differences*. In Guerrini, L. (eds.), *Notes on Design Doctoral Research*. Milano: Franco Angeli.

ALESSANDRO DESERTI, FRANCESCA RIZZO

- Rizzo, F. and Cantù, D. (2013) *From Designing in Protected Environment to Designing in Real Contexts*. Paper presented at the Proceedings of the 5th International IASDR Conference. Tokyo, Japan.
- Rizzo, F., Concilio, G., Marsh, J. and Molinari, F. (2013) *The Living Lab Approach to Codesign*. Paper presented at the Proceedings of Co-create Conference, Aalto University.
- Rizzo, F. and Deserti, A. (2014) *Small Scale Collaborative Services: The Role of Design in the Development of the Human Smart City Paradigm*. In Streitz, N. and Markopoulos, P. (eds.), *Proceedings of DAPI 2014: LNCS 8530*. New York: Springer.
- Sclavi, M. (2000) *Arte di ascoltare e mondi possibili: come si esce dalle cornici di cui siamo parte*. Pescara: Le vespe.

Temporal merging of actantial models of space

Gunnar SANDIN*
Lund University

Actantial analysis of space allows recognition of the circumstantial impact of for instance negotiability, materiality, resistance and accessibility.

The actant/actor-approach represents however not one congruent theoretical and methodological universe. In current spatial semiotics we find not only different, but seemingly incompatible actantial approaches, used to model the co-operative effect of corporeal, material and value-based production of space. Some approaches use categorical or predefined actantial roles, others are more open to actors and actants that spontaneously emerge as the study goes on. The first type could be seen as more true to the structuralist origin of Greimas' actantial approach, whereas the other, still recognising the Greimasian heritage, denounces any structuralist trait. In this paper it is suggested that an understanding of space could be reached through a merging of such otherwise incompatible theoretic origins, if they are seen as a methodological succession, a step-wise analytical-temporal procedure, rather than a coherent logics of spatial agency. Such a successive analytic procedure (here suggested and labelled SMAMS: Sequential Merging of Actantial Models of Space) would open for found actors that show themselves to have influence on space formation, as well as for recurrent and schematically defined spatial actor types. A SMAMS-approach would also recognise the fact that not only actors, but actor types, may change as the investigation goes on.

Keywords: Space; actant; architecture

Background: The Role of Agency in Philosophical and Semiotic Notions of Space.

A lot of modern theorization on space can, roughly, be traced down to a main line of divide and dispute: space as a container, given for things and

* Corresponding author: Gunnar Sandin | e-mail: gunnar.sandin@arkitektur.lth.se

living beings to exist in, versus space as produced, enacted/created by subjects or actors.

This logical difference, between what we roughly could label geometric space and social space, has in a semiotic discourse been given numerous elaborated descriptions. Semiotics is ordinarily thought of as denoting a field concerned with the meaning that space brings along, and only to a subordinate extent with how it is physically, mathematically or linguistically construed: 'Space is relative and absolute [...], a principle of exclusion as much as of inclusion [...], continuous and discontinuous. Modern semiotics, having inherited this philosophical debate, has pronounced itself on space as a form of production of meaning' (Pellegrino, 1998).

Algirdas J. Greimas proposed, in order to find a basic concept for an agency-based semiotic analysis of space, the preliminary term 'extent' as a continuous, not yet formed, pre-spatial entity. Greimas defines extent as that 'substance' which 'becomes space [...and...] by reason of its articulations, may be of use with a view to meaning' (Greimas, 1989). This attempt to theoretically merge space, action and meaning, despite being conceptualised by Greimas in a structuralist vein attempting to capture general semiotic categories applicable to several disciplines, came to be of great importance for the development of later, more discursive and more situated, agency-based modes of analysing space, one of them later to be known as Actor Network Theory. It was not so much the notion of 'extent' that lived on as a strong concept, but rather the fact that this 'substance' was treated by Greimas as a state not yet defined, open for the impact of how physical and narrative trajectories influenced, or 'acted,' its meaning. It was a dynamical space as it were. Before returning to the heritage of Greimas, a couple of other semiotic branches will, for the sake of situating 'space' in a semiotic context, be briefly mentioned, branches that have been dealing with spatial phenomena while also involving aspects of social and communicational importance.

Jurij Lotman invented the 'semiosphere' as a model able to capture in a spatial understanding the exchange of culturally produced meaning (or 'text,' as Lotman labelled it). Since the notion of 'semiosphere' attempts to capture the dynamic transformation of information and meaning in cultural exchange, it concerns also space in the sense what happens with semiotic objects when they move from one place to another, i.e. translation as part of cultural exchange. The general notion of 'semiosphere' basically represents the fact that any epistemological and cultural content has boundaries, and that those boundaries are constantly violated (or more

mildly: altered) in semiotic (i.e. cultural, textual, translational) activity (Lotman, 1990). A consequence of this model, and later extended versions of it (Sonesson, 2000), is that a culture (represented by nations, groups, disciplines, etc.) is defined by how it itself defines other cultures.

The idea that our spatial and cultural universe, including the universes of others, is shaped in the eyes of the beholder, i.e. by us ourselves, is not precisely new. The physical space, the lived space, or as it were, the environment, has at least since Kant been considered to be deeply intertwined with our own comprehension of it. Space and our awareness of it has been seen as a mutual subject-object dependence, especially as formulated in the phenomenological vein originally posed by Husserl as a bracketing practice of intuition then acknowledged as a more contextual matter by Aron Gurwitsch (1985), corporally experienced by Maurice Merleau-Ponty (1989) and lately understood more specifically as an intersubjective situation by Sara Ahmed (2006). If phenomenology is concerned with the consciousness of what we perceive, the theory of perceiving space emanating from James J. Gibson (1977) is more looking at us as animals in an environment, emphasising that not only perception, but action, is immediately linked with what the world and its material and spatial objects 'affords,' or offers in terms of action-potential. These views could in a blunt take and in relief of a more austere philosophical logic be said to support the basic idea that space is unconceivable without it also being corporeally dependent and embodied by the subject. The general presupposition in philosophy (since Kant) of an interpreting subject present as soon as a comprehension of the world is at stake – a presupposition implying a correlation between thinking and perceived objects, and that this correlation essentially leaves the world of the objects themselves out of philosophical interest – has lately been contended (Meillassoux, 2008). In this recent philosophical view of the role of matter, by some labelled speculative realism or object-oriented ontology, objects are recognised as being in their own right, 'released' from this correlation and instead comprehended as entities with their own agency (Harman, 2010). Such an understanding of objects share an idea developed already in actantial (Greimasian and post-Greimasian) semiotics, where the meaning of space is a result from conjoining actors, only some of which are human. Such a comprehension of space, networked and without one human comprehension of it in the centre, detaches from correlationism and gives an instant meaning to objects. It also by default takes on a temporal aspect,

because actors in reality are never stable, even if they can be logically seen as stabilising a situation.

In recent philosophy and cognitive theory, space has in several ways been linked to time and concepts of time. Husserl's theory of time consciousness builds on the presence of 'retention' and 'protention', thus depicting the intertwined principles of 'an immediate before', 'a now' and 'an immediate after' that forms our grasping of what just happened and our predicting what will happen next. This theory operates in the time-space of consciousness itself, of our sensing our own awareness as it were. Recent attempts have been made to conjoin this phenomenological modelling of time-space comprehension with more biologically rooted ones – such as that of Varela (1999), where the basic mechanisms of cognition is seen as divided into principal time-scales, depending on what is required from different types of conceptual connections when they are formed. This neuro-oriented time-space modelling is part of an on-going tendency to bring the philosophical notion of consciousness in more explicit clinch with cognitive theory and theories of evolutionary development. Comprehension of space as a matter of ontogenetic evolution has been studied for instance in relation to semiotic aspects of children's development, evoking questions like in what age, or in what situation, it is possible for a child to recognise a remote room in a photograph, and being able to locate and transport itself to that room. As implied already by Charles S. Peirce, recognition in its basic form (i.e. that upon which iconicity – or similarity – rests), involve visual as well as spatial cognitive semiotic resources, i.e. in order to see what something looks like we have also to be able to make correspondences between different worlds. In fact, our comprehension of any sign depends on our capacity to cognitively connect two disparate entities while also keeping them apart. In this perspective, spatial ordering concern not only correspondence and difference between objects in the world, or between objects and subjects, but is fundamental for thinking itself.

This brief account of some philosophical and semiotic notions of space serves here as a background to how actantial notions of space (and architecture) may appear as specifically semiotically stated. In a more complete rendering of this, we would have to mention the semiotic issues at stake in the specifically place oriented, geographical or anthropological theories that would have us separate more distinctly between space, place and site (Casey, 2001), and the place discourse which is directly devoted to issues of spatial ownership as a societal issue, more explicitly politically stated – such as that by Henri Lefebvre (1996), David Harvey (2001) and

Saskia Sassen (1991), to mention just three important contributors with many followers. The importance for a spatial understanding of society, in terms of 'appropriation,' 'delegation,' and 'authorization,' are in this discourse theorised in relation to the issue of just and oppressive forces of spatial divide. Recently, a socially and more circumstantially engaged theory has more operatively expressed itself in terms of agency (Bennet, 2010), and recognition of agency theories appear also in explicitly political and identity-oriented theorization (Butler, 2011).

Since the main topic of this paper concerns how different conceptions of agency informs theories about the production of space in general and architectural space in particular, political aspects of space in its social context is unavoidable, considering the principal fact that places reflect the societal rules by which they are created, as well as the other places to which they relate. This reflecting principle is what Foucault called 'heterotopia', stating that certain places have the ability to reflect their surroundings in such a way as to 'represent, challenge, and overturn all (other) real emplacements' (Foucault, 1998). Despite his tendency to generalise the heterotopian character as a structure defining all places in society, or, as Michel de Certeau (1984) noted, being 'more occupied with how power is arranged and less with how to deal with it practically,' Foucault's notion of heterotopia has the ability to show that what we ordinarily think of as strictly separated spatial functions in society are in fact places defining each other. The heterotopia concept thus also actualizes the fact that places are temporarily constituted by spatial rule-owners as well as by occasional occupiers. Such is the case for instance with all those so called semi-private, and semi-public places that still in for instance planning documents often are typified as either public or private, despite the fact that it is through our actions that we privatize the public, as well as make a private domain more public.

Modes of Theories of Agency

I will in the following mainly refer to a domain of space theory that could roughly be described as 'socio-semiotic', but in order not to be confused with traditional schools of sociology, this domain of interest is perhaps better labelled 'actantial'. Theoretical attempts to recapture the agency and agency-potential of not only human but also non-human actors, have become a significant part of 'material culture studies', 'actor-network theory', and 'niche-construction' as ways of modelling space. Despite a

common interest in semiotic, or meaning-producing, aspects of socio-spatial activities and objects, there are also theoretical incongruences between different views. Nevertheless, they represent a contemporary attempt to take the somewhat technical notions of actors, actants and agency one step ahead for the understanding of space and socio-spatial activity.

In agency-oriented theories, space is defined as continuously produced by a set of actors (sometimes categorized as actants). This allow us to say for instance that an individual's apartment is not in the hands of its possessor/tenant, but the ownership is rather a modality of various possible stabilisations of actantial relations, including those that involve for instance landlords, house owners, governmental principles, the wills of neighbours, city planning documents, walls, locks, keys, social policies, social movements, wars, natural disasters, and so on, depending on the ideological focus or investigatory limitations. How, then, are we to distinguish between different urgencies here, how are we to make investigations of actantial space where not every detectable actor is equally important, and where not every actor is even detectable from the observer's or intervener's point of view? In order to answer such questions two main principal approaches could be discerned as follows: one that uses recurrent actant types, and one that methodologically follow how actors articulate themselves or their corresponding actants. In order to reflect these two approaches we will look into the space semiotics of Manar Hammad (2002), a rather close follower to Greimas' (1987) structuralist (but nevertheless dynamical) approach, and compare it with a more reluctant (anti-structuralist) follower, namely Bruno Latour. While Hammad, as we shall see in more detail, operates the notion of actant on a systematic semiotic level, as a constrained typology of actor-types (such as owners, visitors, authorization and partitioning), Latour (2005) uses the notion of actant first of all in order to make philosophical room in sociology for the non-human agency of spatial production, such as physical matter, technological tools, prescriptions, behaviour or law. This approach of Latour's is also, as we shall see, part of an ambition to differentiate between actors' varying degree of intensity and transformability. Latour has at times (2005) positioned himself as outside, sometimes as part of, the specific position in contemporary actantial theory known as Actor-Network-Theory or ANT (Law and Mol, 2001). In ANT, various spatial ordering principles, or types of actantial connections, or network stabilisations, are emphasised – such as region (similar to Euclidian spatial extension, based on metric regularities), network (agglomerations of fixed or pre-existing entities (forces) that hold a materialised situation

together), fluid (defined as a spatial composition that includes continuous reconstruction and dynamic alteration of the constituting actors), and finally fire (defined as patterns of discontinuity, where absence of one or more actors is a prerequisite for spatial stabilisation). While 'networks' compose 'immutable mobiles', i.e. spatial compositions that hold together with their own rules of freedom in relation to metric space, the 'fluid' presents a more mutable system that includes unpredicted strengths and weaknesses as regards the binding forces. A maintenance can be the force needed for the fluid to hold together, producing 'an object continuity that precisely demands gradual change' (Law and Mol, 2001). Through the metaphor 'fire', absent actors are given precedence, such as those un-built parts of a city that could be needed in order to enable other establishments, or in order to support movement between different parts, or absent functions or individuals in an organisation that enables the organisation to work (cfr. Law and Singleton, 2005). ANT thus introduces – metaphorically and situated rather than systemically manifest – a set of 'object versions' that could relevantly cover such diverse spatially conditioned phenomena as Portuguese vessels during European colonial domination, a bush pump for water in Zimbabwe, and the progress and management of liver disease.

The position of Actor-Network-Theory is clarifying as regards distinctions and connections between a geometric and a socially constructed space, but from a general semiotic point of view also problematic, in the sense that the three latter 'object versions', or types of spatial merging, i.e. network, fluid and fire, could logically be viewed as of the same type (distinguished only to fit specific empirical situations). This figural 'freedom' allows in principal also other stabilising figures, apart from ANT's four principal ones, and may be needed to fit further situations or description of space. One such attempt is the figure of 'sort,' based in family resemblance between otherwise physically separate objects, for instance as functions in a city (Kärrholm, 2008; Kärrholm and Sandin, 2011).

In research about space, the capturing of dynamical spatial processes is for the sake of norms of dissemination usually tied to the logic of written text or static diagrams. Lately however, the craft of socio-spatial modelling has gained possibilities and used media allowing a dynamical change in the models. In a recent attempt to model the developing controversies surrounding the architectural becoming of the Olympic Stadium in London, Albena Yaneva (2012) has taken the notions of actors and actants into a new visual mode of presentation and interpretation. In a parametric description of the number and content of controversies in mass media reports, a

moving image can be seen of the emergence, development and decline of actors. Actors appear through, as well as show their decline in, controversies. 'Controversies' in this context need not necessarily be only fierce or politicised disputes, but are defined by Yaneva as 'shared uncertainties' in 'not yet stabilised states of the urban and the social' (Yaneva, 2012), thus obtain the general role in the analysis that also Latour (2005) and Hammad (2002) has forwarded. In Yaneva's analysis such diverse data as protesters' demonstrations (against climate change caused by extended airport services), designer's proposals and opinions, communities' protocols, existing environment, existing architectural types, the role of the predecessor Beijing Olympics, etc., were incorporated into one diagrammatic moving image. Thus, an animated and time-reflecting presentation appears of clusters such as legacy, cost, sustainability and design bids. The informational abundance and wider theoretical and methodological consequence of this type of actantial spatial representation remains to be evaluated, one factor being time and at what occasions new data is transferred to the model.

One aspect that comes to its fore in ANT as well as in the dynamical renderings of Yaneva, is methodological and concerns the openness for alternative interpretation when data is put in relation to what parameters for investigation are chosen from the analytical beginning. This kind of choice of outset parameters are also what distinguishes the two major approaches to agency that will be addressed next, and which also constitute the main topic of this paper. The first one concerns a way to study the social sharing and division of space.

Actantial Categories and the Negotiation of Access to Space

An important contribution to the semiotics of space can be found in an experimental setting in 1984 by Hammad, a setting designed to highlight the issue of access to space, thus also to the division between private and public partitions of particular places. Hammad staged his experiment in La Tourette, the architectonic classic designed by Le Corbusier. Once a monastery with room for prayer, meals, living, gathering, management, transportation, etcetera, the building later acquired the function of a conference hotel, but still with a small amount of monastic representation (a prior and a few monks) in the running of some of the daily operations. In secret collaboration with a group of selected companions taking part in a

conference in this location, Hammad (2002) initiated a series of rule-breaking behaviour such as 1) occupying the 'most important' table in the refectory (room for meals) usually advised for a group of leaders including the prior, or 2) knocking at the door of a guest room and ask the guest for access to the room, or 3) telling a guest to leave the room and move to another one for reasons of making room for other (more important) guests, etc. It was vital to Hammad that the experiments concerned implicit (or tacit) rules, more like etiquette, implicating that a violation of them was initially perhaps only vaguely experienced, without the possibility to consult any written regulations. In his analysis, Hammad (2002) suggests a set of spatial 'modalities' based on the linguistic modal auxiliaries 'wanting to', 'having to', 'be able to' and 'knowing (how) to' make an action. The actions made in the experiment concerned the spatial relations between different types of actors: between people; between people and concrete architectural elements like windows; between people and authorisation (or law); between activities and time; etc. In the analysis, a range of actual actors were grouped into four principal actant types: owners, visitors, authorizers and extentions, following Greimas' semiotic schema (inspired by Vladimir Propp's analysis of narrative agency in folk tales in the 1920s). A set of 'actantial roles,' or combinations, thus appeared, such as: 'the temporary owner of a place', 'the spatial partition controlled by this owner', 'the authoriser (or legaliser) deciding the ownership', 'the visitor', 'the spatial extent external to the visitor inside the place of the owner', and so on. They all concern modes of possession of space, i.e. how it is prohibited from access, how it is possible to access, how it is de-accessed, how it is conjoined with other spaces, etc.

The experiments in La Tourette show that spatial access, and the privatisation of space that may follow, is a matter of time, or more precisely of the segmentation, succession and duration of time. One example is the daily routines of the convent that allow (for the experimenters to make) alteration of spatial ownership, precisely because ownership itself is not constantly protected. This change of ownership is hence due precisely to the institutional intention to divide time (Hammad, 2002). The importance of a temporal division of space is made clear for instance when the refectory in the monastery is used only certain hours per day, a fact that provides the possibility to disturb that particular spatial system by off-regulation actions (such as occupying chairs) at the immediate beginning of active hours. This limited time-space then constitutes a spatial appropriation possibility. Another important time-related mechanism operated in this experiment

was the ability to negotiate access to a room, depending on the amount of time at hand for an intruder to spend spontaneously in the room.

Hammad's experiment, partly constructed so as to create, but also reveal, spatial controversies, shows that access to space, as well as the line of division between private and public, is a matter of decisively designated moments of social construction, aggression and negotiation. And the experiment design also shows that the spatial choices made in the outset, such as what functional aspects the rooms had, mattered for the result: one choice of parameters could have been replaced by other perspectives that could hypothetically generate other actors and other actantial combinations (of the four basic types), revealing other mechanisms of privatisation.

Uncategorising the Actants: Unexpected Humans and Matter

As we have seen, controversies are specifically good points of analytical departure, as was pointed to also by Bruno Latour (2005). While Hammad's range of actants followed a typologized set of operators in the 'struggles' about spatial access, the notion of actant is understood differently in the hands of Latour, who is from the outset provoked by the semiotic tendency to categorize while making the categories perfectly repeatable and operative on an equalized and non-affected level. This is reflected also in his critique (2005) of sociologists' tendency to use readymade categories that preclude and stay intact through analysis after analysis. He prefers a more open-ended and unprecedented possibility for actors and actants to emerge and define each studied situation, and even let the actors themselves play a more active part for the investigator. Latour, paying tribute not only to Greimas (for bringing up the paired notion of actor/actant), but above all to the non-structuralist ethnomethodology of Harold Garfinkel and the non-categorist sociology of Gabriel Tarde, emphasizes that actors cannot be pre-conceived, they can not be 'placeholders' in a pre-established system, especially if they are seen in their capacity to make a social and analytical change. Actors, for Latour, are actually 'able to propose their own theories of action to explain how agencies' effects are carried over'. They even have the capacity to (thus should methodologically be let to) 'propose their own theories of action' (Latour, 2005). A consequence of Latours' view is that actors create their own actantiality, i.e. that it is not for the analysing agent to determine what is an actant or not, perhaps only to detect actantiality (in the sense principle forms of agency) whenever it appears.

By analytical openness towards actors and their autonomous abilities, he suggests a less determinable space of reference to represent his actors than Hammad does, but in congruence with Hammad he advocates a view that human enactment can be – in fact in most situations in reality – delegated to non-human objects. In Latour's case this delegation of 'allowing', 'stopping', 'suggesting', etc., is frequently exemplified through technological features of designed objects, such as the doors, keys, hinges, automatic door openers and shutters (grooms) that have replaced the human activity needed to enter a house without having to bother too much with opening and closure difficulties (Latour, 1992). The degree of 'excorporation' of intra-somatic skills (like lifting, pushing, hindering, opening, etc.) into machines, as well as, reversely, the 'incorporation' of extra-somatic functions into our daily handling of matter-dependent situations, like when a trained driver just 'know' how to drive a new car without having to read the instruction manual first, are emphasized by Latour. These kinds of assimilation need the notion of actant in order to include in one situation, or one networked object, the things, procedures and decisions made in the histories of technology that led to their realisation. But not only does Latour's approach to actor-network theory emphasize what a situation might reveal in terms of obscured controversies in histories/sociologies of matter; he also sees the need to consider the material transformation, the destruction and the actual labour needed for a communication vehicle, like a high-speed train, to work. He calls such (sometimes hidden) transformative agency 'mediators.' He states this in contrast to the kind of perfect semiotization, 'the intermediary', where all appearing categories stay intact, or remain not noticeable. Whereas 'mediators' bear resistance to the mediation process and are transformed, 'intermediaries' are perfectly transportable and unchanged. The emphasis on processes is furthermore expressed in Latour's suggestion that timing, spacing, and acting, used instead of time, space, and actors, marks the fact that these entities exist separately, that they influence each other, and that they are in a constant mode of alteration (Latour, 1998).

A Merging of Differing Actantial Approaches

Two principally different actantial views, here roughly rendered respectively as typological categorisation versus open-ended detection, have been discussed in their capacity to render socio-spatial, or as it were, placial situations. In interventionist spatial experiments, such as those made

by Hammad in La Tourette, a possibility to address the violation and negotiability of space was made clear. In comparison, Latour's view made it possible to acknowledge unpredicted actors and actor types. Together, they would make possible the variation of the actors that collectively make a spatial situation, and thus reach beyond the philosophical concept of heterotopia, that was seen here as confined to its (strong but rough) ability to describe overall spatial (or rather placial) divisions and societal functions, but not their generative trajectories. A description more true to the dynamic forces of spatial production would be possible by locating the controversies in connection to a studied activity, in the way that both Hammad and Latour proclaims, one mode of which Yaneva technically pursues in relation to the becoming of architecture. Hence, in a combination of categorical and open-ended actantial roles, we will be able to locate possible conjunctions and disjunctions of actants, and see how clusters rise and expire, grow and diminish, transform or stay intact as sociological and spatial worlds go on. A successive, or co-productive methodological pattern emerges, concerning how to investigate the agencies of urban/rural space production. Such a successive path may start for instance in an initial overall judgement of the reflective capacity of the studied situation at hand, through general spatial figures, such as Foucault's notion of heterotopia, capturing socio-spatial differences; or through Lotman's notion of semiosphere, focusing on cultural exchange mechanisms. An initial object of study so found, could thereafter, for the sake of discovery of a more profound pattern of negotiating and producing actors, benefit from a reflection by way of Hammads typology (owner, visitor, authorizer, extent), as well as by following Latour's self-instructive actor. These categorical and non-categorical actantial approaches may in principle be repeatedly used, as a 'check' on each other. Such a succession would amount to a de-structuralised, but still to some extent typology-driven universe of study, reminiscent of the typologisation (or figuralisation) of space made in ANTs discursive metaphors, but with an explicit ambition to extend the typological repertoire in each study, while maintaining a base that reflects the mechanisms of spatial existence.

In reference to a case of urban densification

The type of multifaceted consideration of actors accounted for in this article, may be pursued in concrete urban or architectural spatial affairs, with or without explication of the methodological process. In a study

(Sandin, 2013) of a renewal of a city square in Malmö, Sweden, this alternating actantial thinking supported the analysis of the (lack of) democratic principles in the preparatory phase of the building of a high-rise architecture. Focusing in particular on the public consultation process, but also the way that the city government materially protected the area under construction, the analysis could include the general issue of rights to civic space, as well as the more particular question of participation in planning processes. In this study it was shown that the governmental delegation of authorization to material actors like blocks of stone, fencing, sign-posts hung at fences, were added to governmental actions like removal of homeless people, neglect of official and private opinions, etc. Some of the actors in this case were for instance shown to bear various roles in relation to authorization: authorised, authorisers, de-authorisers and unauthorised.

This study could not have been pursued had a strictly structuralised analysis, with pre-given actant types, been done, nor would probably the modes of authorization in relation to city planning been acknowledged without the more categorical account. A conclusion could be made (Sandin, 2013) that suggested re-negotiation of several roles of delegated authorization in city renewal, not least those of civil servants and architects, both of whom could take on more intermediate tasks, instead of as in most cases, maintain their roles as pursuers of an idealised architectonic vision.

Conclusion: Suggesting a Methodological Sequence

An explication of the combined actantial analysis argued for above, and initially here historicized in terms of its philosophical and semiotic ground, can be made in terms of a strategy for the combination of methods.

A methodological suggestion for the description of the alteration of spatial, and more specifically urban and architectural situations, namely a Sequential Merging of Actantial Models of Space (SMAMS), may then unfold as follows:

1. Initial sensing of the capacity of a situation to reflect matters of urgency while showing and hiding a possible variety of actors.
2. Detection of unexpected actors.
3. Looking for/applying recurrent actor types (like owners, visitors, authorisers and material extents).
4. Do 2 and 3 show overlapping or mutually exclusive actors?

5. Can spatial object versions (representing modes of stabilisation) stimulate further discovery/conclusion of actors?
6. Can a visualised dynamic rendering of intensities of actors add to the understanding of the situation?
7. Re-open the study for detection of new-coming unexpected actors.

This methodological succession is here sketched as seven steps, with a possible loop (7) implicating possible reiterations. Any iterative search for actors should preferably await its own stabilisation as long as possible in an analytical process, not to lose its true applicability to unexpected situations, and for capturing those influences on spatial formation that takes time to discern.

References

- Ahmed, S. (2006) *Queer phenomenology: Orientations, objects, others*. Durham: Duke University Press.
- Bennet, J. (2010) *Vibrant Matter: A Political Ecology of Things*. Durham: Duke University Press.
- Butler, J. (2011) *Bodies in Alliance and the Politics of the Street*. In McLagan, M. and McKee, Y. (eds.) *Sensible Politics: The Visual Culture of Nongovernmental Activism Transversal*. New York: Zone Books.
- de Certeau, M. (1984) *The Practice of Everyday Life*. Berkeley: University of California Press.
- Foucault, M. (1998) *Essential Works of Foucault 1954-1984. Aesthetics, Method, and Epistemology*. London: Fabion.
- Gibson, J.J. (1977) *The Theory of Affordances*. In Shaw, R. and Bransford, J. (eds.), *Perceiving, Acting, and Knowing: Toward an Ecological Psychology*. Hillsdale: Lawrence Erlbaum.
- Greimas, A.J. (1989) *The Social Sciences. A Semiotic View*. Minneapolis: University of Minnesota Press.
- Greimas, A.J. (1987) *On Meaning: Selected Writings in Semiotic Theory*. London: Frances Pinter.
- Gurwitsch, A. (1985) *Marginal consciousness*. Athens: Ohio University Press.
- Hammad, M. (2002) *The Privatisation of Space*. Lund: School of Architecture.
- Harman, G. (2010) Time, Space, Essence and Eidos in Cosmos and History. *The Journal of National and Social Philosophy*, 6 (1), 1-17.
- Harvey, D. (2001) *Spaces of Capital: Towards a Critical Geography*. New York: Routledge.

- Kärrholm, M. (2008) The Territorialization of a Pedestrian Precinct in Malmö: Materialities in the Commercialisation of Public Space. *Urban Studies*, 45 (9), 1903-1924.
- Kärrholm, M. and Gunnar, S. (2011) Waiting Places as Temporal Interstices and Agents of Change. [online] *TRANS, Internet-Zeitschrift für Kulturwissenschaften*, 18. Available at www.inst.at/trans/18Nr/II-1/kaerrholm_sandin18.htm [Accessed: 8th May 2014].
- Latour, B. (1992) *Where are the missing masses? The sociology of a few mundane artifacts*. In Bijker, W. and Law, J. (eds), *Shaping Technology/Building Society*. Cambridge: MIT Press.
- Latour, B. (1998) Trains of Thought, Piaget, Formalism and the Fifth Dimension. *Common Knowledge*, 6 (3), 170-191.
- Latour, B. (2005) *Reassembling the social*. Oxford: Oxford University Press.
- Law, J. and A. Mol (2001) Situating Technoscience: An Enquiry into Spatialities. *Society and Space*, 19 (5), 609-621.
- Lefebvre, H. (1996) *The Production of Space*. Oxford: Blackwell.
- Lotman, J. (1990) *Universe of the Mind: a semiotic theory of culture*. London: Tauris & Co.
- Meillassoux, Q. (2008) *After Finitude, An essay on the necessity of contingency*. New York: Continuum.
- Merleau-Ponty, M. (1989) *Phenomenology of Perception*. London: Routledge.
- Pellegrino, P. (1998) Spaces of Relevance, Times of Constancy. *Semiotica* 122 (3/4), 369-385.
- Sandin, G. (1993) *Modalities of Place: On Polarisation and Exclusion in Concepts of Place and in Site-specific Art*. Dissertation, Lund University.
- Sandin, G. (2013) Democracy on the Margin: Architectural Means of Appropriation in Governmental Alteration of Space. *Architectural Theory Review*, 18 (2), 234-250.
- Sassen, S. (1991) *The Global City: New York, London, Tokyo*. Princeton: Princeton University Press.
- Sonesson, G. (2000) Ego meets Alter. The meaning of otherness in cultural semiotics. *Semiotica* 128 3/4, pp. 537-559.
- Sonesson, G. (2007) *From the meaning of embodiment to the embodiment of meaning: A study in phenomenological semiotics*. In Ziemke, T., Zlatev, J. and Roslyn, F. (eds.), *Body, Language and Mind*. Berlin: Mouton de Gruyter.
- Varela, F. (1999) *The Specious Present: A Neurophenomenology of Time Consciousness*. In Petitot, J., Varela, F., Pachoud, B. and Roy, J.M. (eds.),

GUNAR SANDIN

Naturalizing Phenomenology: Contemporary Issues in Phenomenology and Cognitive Science. Stanford: Stanford University Press.
Yaneva, A. (2012) *Mapping Controversies.* London: Ashgate.

Narrare il Territorio: Dispositivi e Strategie d'Innovazione per gli Spazi Percepiti

Giovanni BAULE, Daniela Anna CALABI and Sabrina SCURI*
Politecnico di Milano

Osserviamo due importanti cambiamenti che coinvolgono molte realtà territoriali. Da una parte la loro identità è in costante trasformazione; un cambiamento che si traduce nella progressiva perdita del senso di appartenenza al luogo. Contemporaneamente, l'industria turistica registra un aumentato interesse verso le mete minori e il turismo motivazionale, alla ricerca di un'esplorazione culturale e esperienziale dei luoghi. Per affrontare le sfide che l'attuale scenario propone, il design della comunicazione per lo spazio urbano necessita di nuovi paradigmi. Il degrado delle identità territoriali è proporzionale alla caducità dei significati e alla rapidità con cui tutto si trasforma. Rappresentare i luoghi è un'operazione concettuale prima che estetica. Occorre sempre di più un design che funzioni da 'dispositivo di decodifica' e rilettura, capace di mostrare punti di vista e memorie ancora esistenti anche se invisibili. In questo paper saranno trattati i temi dell' 'accesso comunicativo', inteso come strumento per tradurre e rappresentare lo spazio urbano, le sue molteplici identità e alterità. Il design della comunicazione si avvia così a diventare un punto d'incontro tra comunicazione funzionale (di orientamento) e il progetto di contenuti di approfondimento – dalla rappresentazione cartografica allo 'spazio percepito' -, al fine di creare una connessione tra cultura, turismo e territorio.

Keywords: Communication design; aesthetics of innovation; perception

1. Scenari Contemporanei

I territori sono, per loro natura, realtà dinamiche e in continua trasformazione; un processo questo che nel contesto attuale è diventato ancora più rapido. L'effetto di tale accelerazione si traduce nella difficoltà a metabolizzare i cambiamenti in atto e quindi nella progressiva perdita del senso di appartenenza al luogo. Ne risulta che molte realtà territoriali si

* Corresponding author: **Sabrina Scuri** | e-mail: sabrina.scuri@polimi.it

trovano oggi ad affrontare una profonda crisi di identità, riducendosi spesso a meri spazi di transito e mancata appropriazione.

Contemporaneamente, anche l'industria turistica registra importanti cambiamenti quali l'aumentato interesse verso le mete minori e il turismo motivazionale, alla ricerca di esperienze autentiche (MacCannell, 1976). Gli attori di questo complesso sistema sono oggi più attenti alle realtà locali, all'esplorazione dei territori diffusi e a quelle esperienze che contemplano contemporaneamente gli aspetti naturali e sociali del territorio. Il cosiddetto 'turismo culturale' si sta diffondendo, determinando la crescita della domanda (Martelloni, 2007).

In questo contesto diventano fondamentali le identità inedite che potremmo definire di transizione perché descrivono il processo evolutivo di un luogo; sono gli 'habitus' che nel tempo lo hanno modellato. Descriverle significa favorire la comprensione della realtà profonda del territorio, portando le comunità locali alle radici della memoria condivisa. Per ricucire questo legame bisogna rendere visibile il 'paesaggio' - inteso come una determinata parte di territorio 'il cui carattere risulta dall'azione di fattori naturali e/o umani e dalle loro interrelazioni' (Council of Europe, 2000, p. 9) - e quindi soddisfare i turisti motivati a entrare in contatto con gli aspetti naturali, culturali e sociali di un territorio. L'assunto è che il paesaggio è un fenomeno percettivo e pertanto rientra nell'ambito delle esperienze estetiche (D'Angelo, 2003).

Il design della comunicazione per lo spazio urbano necessita di nuovi strumenti e format per l'interfacciamento comunicativo con i luoghi. Interfacciarsi con il territorio significa prima di tutto interpretarne il significato, passando dallo spazio percepito allo spazio praticato e esperito: è una questione estetica - intesa come conoscenza derivante dall'esperienza sensibile - e quindi percettiva. Le strategie d'innovazione qui suggerite risiedono perciò nelle dinamiche estetico-percettive attraverso cui narrare le identità dei luoghi.

Esistono già diverse interessanti sperimentazioni, spesso a cavallo tra arte e design, che costituiscono un possibile corpus d'analisi utile ad una ricerca fenomenologica finalizzata ad individuare modelli progettuali per una comunicazione del territorio inteso come spazio percepito. Di seguito sono presentati tre casi studio che differiscono rispettivamente tra loro per il peso dato alla componente immersiva, emozionale e interattiva della narrazione.

1.1. Meditazioni Mediterraneo

Meditazioni Mediterraneo è uno degli ambienti sensibili progettati da Studio Azzurro, allestito nel 2002 a Castel Sant'Elmo (Napoli). Si tratta di un percorso espositivo realizzato mediante video-installazioni che riproducono cinque paesaggi emblematici di un 'itinerario nei sensi e nei luoghi del Mediterraneo' (Studio Azzurro, n.d.). L'esperienza del territorio qui rappresentato è interattiva, emozionale e fortemente immersiva, ma è proprio in quest'ultimo aspetto che risiede l'elemento di maggior interesse del progetto. L'ambiente di Studio Azzurro è uno spazio dialogico all'interno del quale ha luogo la percezione e l'esperienza del paesaggio. La dinamica estetica che guida l'innovazione risiede nel processo relazionale e di mutuo scambio che si instaura tra spazio espositivo e fruitore. Tale dinamica produce un effetto immersivo grazie anche al supporto di tecnologie e linguaggi espressivi specifici.

L'identità culturale e il paesaggio che caratterizzano l'area del Mediterraneo sono resi visibili e sintetizzati nelle loro componenti più evocative: gesti, materie, suoni e colori. La componente tecnologica, che permette all'ambiente di essere 'sensibile', è lo strumento per produrre un coinvolgimento attivo. Lo spazio, attraverso l'uso di sensori, reagisce alla presenza dello spettatore. I paesaggi si aprono alla sua vista, gli vanno incontro; si fanno sentire, toccare, esplorare.

1.2. Smellmap Milan

La *Smellmap* di Milano è una delle sensory maps realizzate da Kate McLean, designer e appassionata di cartografia. Il concept alla base di questa sperimentazione progettuale è 'from Preconception to Perception' (McLean, n.d.). Sulla mappa di Milano poggiano dei modelli che riproducono gli edifici e le architetture simbolo della città. Da questi, per mezzo di diffusori, vengono sprigionati gli odori che li caratterizzano - il profumo di pomodoro e basilico esce da un ristorante, l'aroma dell'incenso circonda il Teatro alla Scala mentre quello dell'erba si diffonde nei pressi dell'Arco della Pace (McLean, n.d.). Qui la mappa non è il semplice piano della raffigurazione, ma il terreno da cui sorge la città e sul quale si sviluppa l'esperienza sensibile, resa possibile mediante l'impiego di soluzioni di tipo tecnologico - che permettono di diffondere fragranze - e grazie al comportamento attivo degli utenti, invitati a spostarsi, interagire ed esplorare lo spazio cartografico in tutta la sua fisicità.

In questo caso l'esperienza risiede prima di tutto nell'emozione. L'innovazione è guidata da una dinamica di tipo simbolico e l'azione estetica

riguarda la sfera del linguaggio espressivo. L'osservatore diventa esploratore, individua i volumi, li può toccare con mano; ma è soprattutto grazie alla stimolazione del senso dell'olfatto che la McLean riesce a trasformare l'esperienza in emozione. Il dato olfattivo ha la caratteristica di essere tra tutti il più memorabile; accompagnato da un'elevata carica emotiva, è capace di evocare immagini e ricordi e stimolare gli altri sensi. L'odore è un 'particolare immenso' (Bachelard, 1973); è lo strumento che ci porta fino al cuore delle cose, alla scoperta dell'intimo della città.

1.3. *Pulse Front*

Pulse Front è un'installazione realizzata nel 2007 dall'artista Rafael Lozano Hemmer presso l'Harbourfront di Toronto. L'opera consiste nella proiezione ad intermittenza di dieci fasci luminosi che si perdono nel cielo della città. Ciascun proiettore è governato da una installazione in metallo che, attraverso un sistema integrato di sensori, misura le pulsazioni dei passanti che si fermano ad interagire con essa. La frequenza cardiaca del soggetto e le sue variazioni vengono registrate e convertite in impulsi luminosi, tramite un sistema computerizzato che orienta i proiettori e li attiva. Ne risulta una visualizzazione su scala urbana, scenografica ed emozionale, dei ritmi vitali di un'intera città. Questo progetto ha un carattere fortemente interattivo. L'innovazione è guidata dalla componente tecnologica che, attraverso i linguaggi espressivi impiegati e i comportamenti messi in atto dagli utenti, dà luogo all'esperienza. I soggetti coinvolti sono allo stesso tempo osservatori e creatori di uno spazio da percepire e praticare; uno spazio dinamico, mutevole e umorale. La presenza dell'utente è l'elemento che connota il paesaggio che, a sua volta, restituisce l'immagine dei suoi abitanti.

Quelle descritte sono solo alcune delle numerose sperimentazioni artistico progettuali in cui la dimensione percettiva si fa strumento per la narrazione del territorio. Interazione, emozione ed immersione sono tutti aspetti dell'esperienza sensibile, che ritroviamo, con pesi diversi, all'interno di ciascuno dei progetti presentati. Nel caso di *Meditazioni Mediterraneo*, è prevalente il carattere immersivo supportato dalla componente emozionale (data dall'uso di linguaggi evocativi) e da quella interattiva (ottenuta grazie all'impiego di specifiche tecnologie). Qualunque sia l'aspetto che più di tutti caratterizza l'esperienza vi è una costante: la presenza di un corpo impegnato nella percezione dell'ambiente, sia esso reale o rappresentato. A livello progettuale questo si traduce nella necessità di adottare strategie di innovazione basate sull'azione estetica – intesa come 'puro concetto

Narrare il Territorio: Dispositivi e Strategie d'Innovazione per gli Spazi Percepiti razionale della bellezza' (Schiller, 1998, p. 103) -, capaci di svelare e rendere percepibili i segni del legame profondo e intangibile che esiste tra uomo e territorio.

2. Estetica dell'Accesso

L'accentuato degrado degli assetti territoriali, dei vincoli di appartenenza e di autoriconoscimento e, dunque, la generalizzata perdita di quelle che vengono generalmente individuate come identità dei territori, vanno rapportate ai 'processi di scomposizione degli assetti spaziali esistenti e alla loro ricomposizione territoriale secondo le esigenze funzionali e i modelli organizzativi propri delle nuove realtà economiche, sociali, culturali, urbanistiche' (Scaramellini, 2012).

Va dunque ipotizzato un complessivo ripensamento dei modi e delle culture che stanno alla base della comunicazione del territorio in tutte le sue forme, nei contenuti di narrazione e nei formati comunicativi.

La condizione di riconfigurazione dei codici spazio-territoriali induce, infatti, a tipologie di innovazione anche sul piano comunicativo: a una radicale riconfigurazione dei modi e dei dispositivi della comunicazione che a loro volta, quasi specularmente, possano agire in termini di una 'ricomposizione comunicativa' e di una riabilitazione di senso a fronte della frammentazione e della perdita semantica degli assetti territoriali.

Assumiamo, tra i molti possibili, alcuni riferimenti atti a circoscrivere i paradigmi di innovazione relativi che interessano la narrazione dei territori.

In primo luogo, va tenuto in conto l'ampio dibattito suscitato dalle tesi di Carlson (1979) e i tre modelli di 'apprezzamento estetico dell'ambiente' ('object model', 'landscape model', 'enviromental model' - quest'ultimo da lui patrocinato -) che hanno posto in evidenza, da una parte, i limiti delle categorie che assimilano l'apprezzamento estetico dei luoghi a quello delle opere d'arte - il modello formalista -, dall'altra, i limiti dei modelli basati sul puro cognitivismo scientifico, non ultimo il principio dell'order appreciation (Carlson, 2000) che instaura rigide relazioni tra categorie scientifiche e esperienza estetica, così come tutte le varianti scientiste a partire dall' 'habitat theory' in Appleton (1996).

In secondo luogo va considerata la necessità di una costante critica alle teorie della riduzione del paesaggio a veduta che coinvolgono strumentalmente la stessa duplicità semantica del termine paesaggio presente negli idiomi europei (Franceschi, 1997); così come va considerata la divaricazione terminologica declinata secondo altre accezioni ('territoriale'

per i geografi, 'ambientale' per gli ecologi). Nel loro insieme, hanno ridotto la ricchezza e la convergenza di connotazioni del principio unitario di geosistema.

Inoltre non va sottovalutata a riguardo la generalizzata produzione di culture-spettacolo, e conseguentemente di cittadini spettatori, che ha oggi un'indiscutibile incidenza sui modelli della cultura diffusa. La spettacolarizzazione del quotidiano, la mediatizzazione degli oggetti e degli scenari di vita, l'estetizzazione del landscape urbano e del paesaggio appaiono come processi inarrestabili e carichi di conseguenze. Installano punti di vista, modificano modi della percezione, favoriscono tutti quegli atteggiamenti che costruiscono quell' 'uomo-spettatore' che ne è il principale prodotto collaterale. La costruzione dello sguardo come 'sguardo dello spettatore' è l'elemento predominante nella storia presente e nel sistema dei media che l'avvolge; in evidente, paradossale contraddizione con le mitologie correnti della democrazia in rete e delle comunità partecipanti.

Anche la comunicazione del territorio, e qualunque progetto per dispositivi comunicativi che riguardino quest'ambito, sottintende dunque due possibili e differenti concezioni alle quali poter fare riferimento: da una parte, un 'territorio-paesaggio-spettacolo' di fronte al quale lo sguardo si dispone passivamente; dall'altra, un paesaggio praticato, dove uno sguardo attivo può penetrare quanto gli sta davanti in forma partecipata, con un intento performativo.

È tenendo presente questi antitetici approcci che, tramite la comunicazione e i suoi artefatti, si può riprodurre uno sguardo disposto per il 'già configurato' o, all'opposto, uno sguardo predisposto alla continua riconfigurazione di ciò che ci sta davanti e intorno. Nel primo caso si opera nel senso della produzione, o della conferma, di stereotipi; nel secondo caso ci si apre ad un paesaggio mobile, carico di possibili mutazioni di senso, di feconde risemantizzazioni' (Baule, 2013, p. 8).

Di conseguenza, si conferma l'ipotesi che la percezione estetica di un luogo/paesaggio si pone sempre come organizzazione di dati percettivi e al tempo stesso di dati di altro ordine: proiezioni immaginative, conoscenze storiche, suggestioni letterarie e figurative, valori ecologico ambientali.

Si tenga presente, sul piano critico, quanto oggi l'immaginario tenda a prevalere, il regime delle immagini a esondare fino a istituire quel regime confuso di realtà e finzione che caratterizza il nuovo statuto dell'immaginario e dunque, nel nostro caso, il nuovo statuto dell'immaginario paesaggistico-territoriale. Ed è quanto, già secondo Morin

(1982) con il suo 'homme imaginaire' - l'individuo metà reale e metà immaginario -, la cultura di massa alimenterebbe, oggi più che in altre epoche, il compromesso tra reale e immaginario. È all'interno di questo 'compromesso' che operano i dispositivi di comunicazione alla ricerca di un equilibrio basato sulla connessione con il territorio praticato che escluda gli effetti illusionistici di realtà sostitutive.

Si afferma così un generale principio di continuità sul piano comunicativo che superi la separazione tra percezione ambientale e contenuti culturali restituendo dimensione di complessità all'identità estetica dei luoghi; e in particolare in favore dei luoghi 'non convenzionali', cioè non riconosciuti dalle suggestioni della cultura di massa ed estranei agli stereotipi comunicativi.

È conseguente il riconoscimento, sul piano generale, che tutti i luoghi hanno una valenza estetica e che è questa valenza a costituirne l'identità e l'individualità. Ne conseguono anche: a) il superamento dell'eccezionalismo, dell'extra-ordinario nell'attribuzione di valore, che comporta un ribaltamento della tradizionale nozione di 'emergenze territoriali' (fondata sulla tradizione dei 'mirabilia' e, poi, dei 'landmark') e delle relative gerarchie che selezionano ed escludono a discapito dei contesti e dei luoghi genericamente classificati come 'minori'; b) una critica di fondo al modello turistico di massa, nonché dello stesso turismo culturale di consumo, già propugnata nell'ambito dei Cultural Tourism Studies.

In questo quadro si conferma il 'design dell'accesso' come parte fondante del design della comunicazione; il progetto della comunicazione ne determina, infatti, le modalità, mette in figura le forme di accesso al contenuto, al messaggio. Riferirsi al design dell'accesso significa concentrare l'attenzione sull'ingresso, sul momento di passaggio che conduce all'obiettivo, che rende concreti la possibilità e il diritto di accedere a un contenuto. È il baricentro in cui si focalizza l'essenza di un atto comunicativo, ma anche il passaggio che ne decreta l'esito. Assume una funzione strategica nel progetto di comunicazione per il territorio.

Il design della comunicazione assume in questo senso un ruolo di facilitatore e rende possibile, grazie al suo ruolo registico e di mediazione, l'accesso a contenuti comunicativo-informativi da un punto di vista funzionale e simbolico, permettendo alle diverse fasce di utenza di agire in contesti in continua evoluzione e per questo sempre più complessi: consente di interagire con diverse tipologie di dispositivi (analogici/digitali); aiuta a comprendere e relazionarsi con oggetti tridimensionali, spazi fisici e

spazi virtuali; facilita l'organizzazione, la diffusione, la condivisione del sapere; favorisce nuovi modelli di apprendimento.

Il design della comunicazione svolge, sul piano generale, un'attività di tipo trasformativo e, attraverso gli artefatti e i sistemi progettati, è in grado di guidare le scelte e i comportamenti dei destinatari, modificando la percezione che essi hanno della realtà in cui operano, una funzione di sensibilizzazione verso problemi ed emergenze di natura sociale, ambientale, in un contesto che presenta rilevanti criticità a livello sia locale, sia globale e che rende necessarie condotte sostenibili e responsabili.

Nel nostro caso, l'obiettivo perseguito nell'ambito del design della comunicazione è l'individuazione di dispositivi di accesso comunicativo basata su narrazioni di inedite forme-significato, nuovi linguaggi e contenuti 'di profondità'.

La strategie di narrazione propongono la risultante diegetica come piattaforma di convergenza in grado di unificare componenti simboliche, valoriali, comportamentali tali da ricondurre la natura e la storia all'identità estetica dei luoghi.

Selezionati linguaggi di traduzione multimediale sono in grado di declinare, unificare e orientare i livelli comunicativi di sistemi di narrazione profondi.

L'esperienza di 'abitanti' e 'viaggiatori' (figure di 'turismi' ampiamente rivisitate) - può contare su nuovi dispositivi di decodifica all'interno di una 'rimediazione' della comunicazione dei territori.

3. Percezione e Comunicazione

Il design della comunicazione può avviare un processo attivo di interventi con lo scopo di rinnovare, valorizzare e restituire senso: un cambiamento estetico, inteso come la modifica percettiva che si genera dall'effetto della pratica del territorio e dall'esplorazione guidata. L'ipotesi è quella di un approccio progettuale capace di considerare il valore indotto da un'estetica generata dall'esplorazione, quindi dal corpo in movimento e dall'immersione in contenuti multimediali. Un'estetica dal basso, fondata sul concetto di percezione ingenua o di 'prima impressione' (Griffero, 2010).

L'approccio del design della comunicazione al territorio si riferisce cioè a una conoscenza sensibile, non solo logica; un sapere che riflette sulla presenza corporea e sulla pratica immersiva nel territorio, che assume seriamente il compito di comprendere la realtà di ciò che si mostra, prendendo a parametro il sentire nel corpo, per elevare la conoscenza.

L'esplorazione e la contemplazione dei paesaggi funziona da cerniera tra le identità e le culture, soprattutto perché implica nuove modalità di fruizione dei territori. A mutare è il concetto di viaggio: esso si orienta ad assumere le forme di un'esplorazione finalizzata all'emozione, non per forza rivolta alle memorie, piuttosto alle trasformazioni.

La risposta progettuale del design nasce da queste considerazioni e sviluppa una comunicazione strategica, che integra la promozione dei beni, delle attività e delle tradizioni culturali in una esperienza estetica della pratica territoriale, del paesaggio e degli ambienti urbani. Il fine è un legame rinnovato tra le identità, le culture, il territorio.

Il paesaggio italiano è ricco di frammenti di identità, stratificate e non sempre visibili, di cui restano 'tracce' (segni minimi). La loro concentrazione nell'ambiente connota tali tracce come segni immagine, in quanto permettono di risalire a fatti, storie e avvenimenti, a loro volta rappresentati da immagini e narrazioni di varia natura.

L'interpretazione di queste tracce sul territorio, anche minime, e il progetto della loro associazione all'insieme documentale (multimediale e multimodale) di riferimenti storici, sociali, antropici, naturali, ecc., rappresenta la strategia d'innovazione di un processo comunicativo coerente e coinvolgente degli spazi percepiti, rivolto ad un moderno esploratore dell'urbano. Le tecnologie si prestano alla sincronizzazione dei documenti e alla loro geo-localizzazione, ancorandoli ai luoghi ai quali sono riferibili; ma l'architettura dei contenuti e i paesaggi non possono essere semplicemente 'sovrapposti' (come in parte tentano le attuali realtà aumentate) per diventare effettiva esperienza estetica.

Assunto che comunicare le identità compresenti in un luogo è un'operazione concettuale, prima che estetica, è necessaria piuttosto una complessa operazione editoriale.

Si tratta, in sostanza, di rendere accessibile il 'paesaggio emozionale' (inteso connaturato al rapporto dialogico tra esseri umani e paesaggi) affinché sia restituita quella traduzione sensibile (estetica) di contenuti, in origine con linguaggi e forme di scrittura diversi e slegati, su di un'unica base cartografica.

Il design della comunicazione assume il ruolo di strumento di traduzione, sui piani della 'raffigurazione' (rappresentazione) e della 'trasfigurazione' (piano dell'espressione).

Entrambi tali piani comunicativi trasmettono immagini. Il primo offre informazioni sulla realtà esterna percepita (che rappresenta); il secondo

offre informazioni sulla realtà interiore ed è frutto dei sentimenti, della cultura e delle proiezioni personali nel mondo (Calabi, 2013).

La fenomenologia della comunicazione di fatto non è espressa soltanto dal contenuto trasmesso, ma anche e soprattutto da quello che accade con chi riceve. Il design si fa interprete di questa duplicità nell'interazione comunicativa, perché i processi della rappresentazione e dell'espressione richiedono una traduzione in sintesi percettive comprensibili, capaci di allestire un'esperienza partecipata.

L'indagine filosofica offre molteplici interpretazioni sulla percezione dello spazio, nel tentativo di chiarire come avviene la comune comprensione dei dati che provengono dal mondo sensibile esterno. Di certo si può fare riferimento ai modelli di *spatium* e *topos* di matrici cartesiana e aristotelica, come agli approfondimenti di 'estetica atmosferica' di Gernot Böhme (2010).

Parte dello sviluppo della ricerca teoretica e scientifica, dal Novecento fino agli ultimi anni (Gallese, 2010), pone sempre più attenzione all'essere umano 'fisico' e a ciò che percepisce quando si trova in un ambiente. L'attenzione, cioè, si sposta dal concetto di spazio cartesiano, misurabile, a quello determinato dalla presenza corporea, fino a definire il concetto di 'spazio atmosferico'. In questo senso è significativo il discorso di Gernot Böhme sull'atmosfera, che evolve dalle riflessioni di Alexander Gottlieb Baumgarten.

Attraverso la costruzione di *moodboard*, il designer esplicita l'umore, il tono, il sentimento, o, ancora, l' 'estetica dei contenuti' come somma di elementi evocativi; se si tratta di un paesaggio questa immagine riassume gli aspetti 'meta-turistici' con un approccio mirato e più 'intimo', adatto per una comunicazione mirata al coinvolgimento e all'esperienza.

Il design della comunicazione per il territorio si avvia a costituire un punto d'incontro tra la progettazione di una comunicazione funzionale (di orientamento) e l'approfondimento dei contenuti a diversi livelli (estetico in primis); dalla raffigurazione cartografica allo 'spazio percepito' (Calabi, 2013).

Il presupposto, per nulla semplice, è una questione di interfaccia.

Interfacciarsi con il territorio significa 'mettersi nella condizione per cui quel paesaggio possa svelarsi, fare ancora uno sforzo con il nostro corpo: bisogna andarci, camminarci, immergersi senza preconcetti culturali, farne un'esperienza diretta' (Careri, 2006).

L'interazione con il contesto presuppone la capacità e l'implicita possibilità di entrare in contatto con il luogo per interpretarne il senso, con uno spostamento percettivo dall'ottico all'aptico (Panofsky, 1984), cioè dalla

visione all'esplorazione tridimensionale attraverso il corpo. Questa capacità interpretativa può essere progettata, per permettere la formazione dell'esperienza, la produzione di senso e l'emozione della scoperta.

Eric J. Leed (2007) ricorda che alla radice indoeuropea della parola 'esperienza' si legano significati relativi al movimento e al viaggio, quest'ultimo inteso come percorso di accrescimento personale tramite l'ambiente.

Alcune di queste riflessioni sono state applicate a un progetto di ricerca applicata al territorio della Lomellina, a sud di Milano.

Il territorio presenta caratteristiche rurali e naturali interessanti, con puntuali presenze architettoniche storiche anche notevoli. Non è considerabile un territorio con carattere turistico; nonostante abbia identità culturali decise, non presenta un assetto territoriale leggibile, apparendo piuttosto diffuso e omogeneo, incomunicante valori e memorie.

L'indagine dei documenti riferiti al territorio in esame ha rivelato la scarsità di contenuti attrattivi artistici, naturalistici o storici in senso tradizionale per il profilo turistico medio, tali da incentivare la pratica territoriale e portare a esplorare fisicamente i luoghi (ricerca dell'esperienza estetica). Dall'analisi preliminare è stato osservato che il contesto comunicativo del territorio campione, e le attuali strategie di promozione, riguardano quasi esclusivamente la produzione editoriale cartacea.

Intervenire sulle tracce minime, non solo fisiche (dalle leggende alle rovine di antichi mulini), si è rivelato quindi essenziale; 'agendo sulle identità esistenti, compresenti e 'celate', il progetto di design della comunicazione vuole restituire identità riconoscibili e leggibili' (Calabi, 2013, p. 24).

Per la Lomellina sono stati quindi sperimentati formati e strategie atti a coordinare i contenuti sia in forma predittiva (durante l'approfondimento prima dell'immersione nel territorio), sia in forma geo-localizzata in prossimità dei luoghi, per ancorarli e localizzarli sul territorio anche laddove non esiste molto di visibile, mentre può esistere immaginazione.

Lo scopo della ricerca è verificare come progettare l'esperienza dei luoghi e dei contenuti senza sovrapposizione, piuttosto interazione, lasciando spazio al *moodboard*, all'atmosfera e all'esperienza estetica.

Affinché il progetto editoriale dei contenuti sia organizzato, la rappresentazione degli stessi su base cartografica è il fondamento di un sistema codificato per l'orientamento e l'interfacciamento con il territorio.

La base cartografica non è una componente funzionale (strumentale) del progetto di comunicazione del territorio: è il punto di incontro, lo 'spazio' sul quale convergono funzione e significato (Calabi et al., 2013).

Nel progetto per la Lomellina la rappresentazione cartografica del territorio diventa l'interfaccia del sistema, lo strumento principale che consente all'utente di orientarsi e accedere ai contenuti (le tracce significative), navigando a diversi livelli di approfondimento e di effetto immersivo.

Essendo il territorio un organismo dinamico, stratificato e frammentato, la componente comunicativa di approfondimento deve essere necessariamente strutturata a diversi livelli; si deve cioè innanzitutto compiere un processo (estesico) di ascolto e interpretazione dei diversi linguaggi (e codici), per poi procedere con la creazione di contenuti attuali e comprensibili da tutti (processo poetico). In pratica, le tracce (materiali e immateriali), raccolte e tradotte in contenuti, devono essere presentate attraverso modalità ogni volta specifiche. Il fine progettuale è implementare una modalità di racconto nella quale la realtà dei luoghi viene vissuta continuamente come 'aumentata', perché nella percezione degli spazi convergono contenuti specifici e comunicazioni coerenti.

Nel progetto di ricerca applicata alla Lomellina, sono stati quindi indagati e selezionati alcuni modelli (format di linguaggi) per produrre sintesi percettive e il più possibile 'immersive'; a partire dalle tradizionali gallerie fotografiche, per arrivare a immagini ad effetto tridimensionale, si ricostruiscono i contenuti in un insieme di format coordinati e legati alla base cartografica.

4. Conclusioni

Le realtà territoriali europee sono soggette a un'evidente e costante stratificazione di identità sociali che mescolano memorie e culture; contemporaneamente abbiamo osservato essere in atto un profondo mutamento che coinvolge il settore del turismo. Si tratta di un processo di trasformazione profondo, che coinvolge il significato stesso di territorio, lo amplia avvicinandolo sempre di più al concetto astratto di paesaggio (che contempla contemporaneamente aspetti naturali, culturali e sociali del territorio).

Cosa ci incanta di fronte a un paesaggio? Questa è la domanda che si pone Ugo Morelli (2010).

Alla identità unica e totalizzante, obiettivo della tradizionale immagine di marca, non competono più le polifoniche identità contemporanee dei territori moderni. Da molti anni il design della comunicazione sperimenta paradigmi multimediali e multimodali, rinnovando i caratteri espressivi e i canoni estetici, per orientare nell'esplorazione dei paesaggi attuali.

La vocazione archetipa del design della comunicazione riguarda il tema dell' 'accesso comunicativo': tema fondativo, la cui vocazione alla traduzione in linguaggi comprensibili ben si presta alla decodifica delle memorie dell'urbano. Quindi, a fronte della difficile interpretazione delle nuove identità, il design della comunicazione si concentra sulla definizione degli strumenti per la risemantizzazione dei luoghi, promuovendo la pratica di percorsi che privilegiano punti di vista coinvolgenti.

La strategia progettuale si sposta così sull'organizzazione delle informazioni e dei linguaggi, per aumentare la percezione degli spazi fisici; il design si articola tra la progettazione di una comunicazione funzionale (di orientamento) e l'approfondimento dei contenuti, dalla raffigurazione cartografica, allo spazio fisicamente percepito, alla dimensione estetica.

Se il paesaggio è un'esperienza estetica, fare design della comunicazione per il territorio significa tradurre, interpretare e rendere accessibili le parti e il tutto, gli elementi che lo compongono (spesso difficili da rappresentare) e il sentimento d'insieme; l'estetica diventa processo di innovazione comunicativa, in una rappresentazione compiuta che si fa identità.

Questo orientamento del design della comunicazione per il territorio si concentra sull'accesso comunicativo alla ricerca di nuovi legami empatici con gli spazi fisici; oltre a essere terreno di sintesi comunicative, finalizza l'esperienza partecipata dei luoghi intorno a percorsi che privilegiano punti di vista non convenzionali.

Attribuzione dei paragrafi

Il presente lavoro deriva dalla collegiale condivisione degli autori: il paragrafo 1 è di Sabrina Scuri, il paragrafo 2 è di Giovanni Baule, il paragrafo 3 è di Daniela Calabi, il paragrafo 4 di tutti gli autori.

References

- Appleton, J. (1996) *The Experience of Landscape*. New York: Wiley.
Bachelard, G. (1973) *La poetica della rêverie*. Bari: Dedalo.
Baule, G. (2013) *Narrazioni predittive*. In Scuri, S. (eds.), *Territori Empirici*. Roma: Aracne.

- Böhme, G. (2010) *Atmosfera, estasi, messe in scena. L'estetica come teoria generale della percezione*. Milano: Christian Marinotti.
- Calabi, D.A., Chiodo, E. and Scuri, S. (2013) *Communication Design for Urban Space: Educational Models and Examples of Didactical Applications*. Paper Presented at the Proceedings of the 7th International Technology, Education and Development Conference. Valencia.
- Calabi, D.A. (2013) *Design della comunicazione per i territori*. In Scuri, S. (eds.), *Territori Empirici*. Roma: Aracne.
- Careri, F. (2006) *Walkscapes: Camminare come pratica estetica*. Torino: Einaudi.
- Carlson, A. (1979) Appreciation and the Natural Environment. *The Journal of Aesthetics and Art Criticism*, 37 (3), 267-275.
- Carlson, A. (2000) *Aesthetics and the Environment: The Appreciation of Nature, Art and Architecture*. London: Routledge.
- Council Of Europe (2000) *European Landscape Convention*. [Online]. Available from:
http://www.coe.int/t/dg4/cultureheritage/heritage/Landscape/Publications/Convention-Txt-Ref_en.pdf. [Accessed: 04th January 2014].
- D'Angelo, P. (2003) *Estetica della natura: Bellezza naturale, paesaggio, arte ambientale*. Roma: Laterza.
- Franceschi, C. (1997) *Du mot paysage et de ses équivalents dans cinq langues européennes*. In Collot, M. (eds.) *Les Enjeux du paysage*. Bruxelles: Editions Ousia.
- Gallese, V. (2010) *Postfazione*. In Morelli, U. (eds.) *Mente e Bellezza: Arte, creatività e innovazione*. Torino: Umberto Allemandi.
- Griffero, T. (2010) *Atmosferologia: Estetica degli spazi emozionali*. Bari-Roma: Laterza.
- Gunn, C.A. (1989) *Vacationscape: Designing Tourist Regions*. New York: Van Nostrand Reinhold Publishers.
- Leed, E.J. (2007) *La mente del viaggiatore: Dall'Odissea al turismo globale*. Bologna: Il Mulino.
- Lupo, E. (2011). Design, arts and 'aesthetics of innovation'. *Strategic Design Research Journal*, 4 (2), 40-53.
- MacCannell, D. (1973) Staged Authenticity: Arrangements of Social Space in Tourist Settings. *American Journal of Sociology*. 79 (3), 589-603.
- MacCannell, D. (1976) *The Tourist: a New theory of the Leisure Class*. London: Macmillan.
- Martelloni, R. (2007) *Nuovi territori: Riflessioni e azioni per lo sviluppo e la comunicazione del turismo culturale*. Milano: Franco Angeli.

- McLean, K. (n.d.) *Smellmap: Milan*. [Online] Available from:
<http://sensorymaps.com/portfolio/smellmap-milan/> [Accessed: 20 April 2014].
- Morelli, U. (2010) *Mente e Bellezza: Arte, creatività e innovazione*. Torino: Umberto Allemandi.
- Morin, E. (1982) *Il cinema o l'uomo immaginario*. Milano: Feltrinelli.
- Panofsky, E. (1984) *La prospettiva come 'forma simbolica'*. Milano: Feltrinelli.
- Scaramellini, G. (2012) *Valori del paesaggio nelle scienze umane e sociali: approcci, metodi e prospettive*. In Gavinelli, D. e Morazzoni, M. (eds), *La Lombardia occidentale: Laboratorio di scomposizione e ricomposizione territoriale*. Milano: Mimesis.
- Schiller, F. (1998) *L'educazione estetica dell'uomo: Una serie di lettere*. Milano: Rusconi.
- Studio Azzurro (n.d.) *Meditazioni Mediterraneo. In viaggio attraverso cinque paesaggi instabili*. [Online] Available from:
http://www.studioazzurro.com/index.php?option=com_works&view=detail&work_id=10&Itemid=3&lang=it [Accessed: 20 April 2014].



Social Design for whom and what purpose? Community network knowledge, conversation-as-commoning and design research

Kaye SHUMACK*

University of Western Sydney, Australia

This paper proposes a role for design research through engagement with conversational learning as a form of knowledge commons. The practice of commoning provides a cohesive framework that links participants through something that is shared, and co-produced. Conversation-as-commoning is proposed as a co-design methodology about social learning for shaping possibilities for future and current social change, working at a local level.

Conversations can be understood as a form of knowledge commons - that is, they are shared by those that produce it, and not owned by any one in particular. The role of the designer in these contexts can be to work iteratively and collaboratively with community knowledge networks to identify creative phases and new ideas about social practices emerging through conversational learning. Designers must play a pivotal role in commitment to ethical actions that acknowledge the complex social, cultural and material interconnections between people, things and places. The agency provided by conversational learning can help inform new understandings about interconnected knowledge. This approach is explored through a case study of community gardens research, where research generated from an initial top-down brief is re-evaluated to reveal the workings of knowledge commons. These conversations are explored as instances of commoning where new knowledge is generated through dialogue between design researchers and participants.

Keywords: *Conversation as commoning; community gardens; co-design*

* Corresponding author: **Kaye Shumack** | e-mail: k.shumack@uws.edu.au

1. Introduction

If design is to play a role in shaping and influencing the development of more sustainable techno-social systems, a focus on the significant and active role of participants in co-producing change is critical. For social design, finding a way to prioritise the experience of diverse participants through approaches such as co-design is already well advanced. Sanders and Stappers describe user-oriented participatory design and co-designing as ‘creating new domains of collective creativity’ (2008, p. 5), where participants are not always experts, but bring with them a range of everyday perspectives to inform and shape a design context. Similarly, Action Research (Kemmis and McTaggart, 1988) offers a methodology for learning through doing, where iterative and cyclical stages of development are noted as key research findings. Catney et al. (2013) also argue for the need to include situated knowledge, as information understood in particular contexts (Nonaka, 1994) working on projects that seeking to change behaviours. Whilst Catney et al’s work seeks to shift the behaviours and practices of energy consumption, their emphasis on the role of situated knowledge working at a local level can be adapted more generally for other sustainability agendas.

Social design is largely understood as an engagement with local communities towards sustainability, working with diverse stakeholder interests and practices. Social design projects however, are often problematic, especially when framed as top-down directives or project briefs that can foreclose participatory involvement or creativity. Whilst individuals, groups and institutions may be positive and well-meaning in proposing top-down approaches that seek to improve social situations, or change behaviours, habits and values, these approaches can be restrictive and constraining, raising questions about the value or purpose of the project itself. Within such projects, the role of the designer as a leader, researcher, or collaborator, can be problematic – with often competing priorities and perspectives, the designer might merely service what was expected by the ‘client’, or perhaps impose their own values or beliefs onto a community context. In some cases, the ‘brief’ is open to interpretation, and the success of the project assessed on factors that may not be of great significance to the community group themselves.

An alternative approach for design research and practice is proposed here as a standing aside from top-down approaches, towards engagement with participants in conversational learning, to identify shared social contexts and practices leading to new insights. Through structured and

informal conversations and dialogues with participants that foreground situated knowledge of the local and everyday, design researchers can work creatively and productively towards better understandings of social practices.

This paper explores the above issues through reference to a case study about suburban community gardens (CG's). The complexities and interplay of organisational relations, community interactions, expectations and the role of the designer, are discussed as complex political forces that influence and shape the initial direction of the project. The initial research produced design prototype outcomes that were not taken up by the client. The researchers then re-visited the research data gathered into an alternate project, where evaluations of images and participant conversations were able to reveal a much richer body of knowledge about the social practices and community knowledge networking taking place at each CG site. These approaches are shown to play a meaningful role in contributing to community debates and discussion, using creative communications to foreground the construction of meaning in the minds and hearts of participants. As Gibson-Graham et al comment:

'The times call for ethical action. This means thinking and acting in the economy with concern for others along with ourselves. It means thinking in terms of 'we', 'us', and 'our'. It means not putting an end to personal choice, responsibility, or freedom but rather acknowledging that our individual decisions affect others, just as their decisions and actions affect us. As much as anything else, ethical action is a practice of adopting new habits – habits of reflecting on our interconnections with others, approaching the new with an inquiring mind and an appreciative stance, trusting others as we jointly encounter a future of unknowns and uncertainties, and learning to allay our fears and conjure creativity.. by thinking ethically we can expand our capacity to act.' (Gibson-Graham et al. 2013, p. 18)

2. Commoning as an ethical framework for building social practices

Whilst a singular paradigm about the meaning of the 'commons' is still being contested (Jeffrey et al. 2012, p. 10), the underlying principles of the commons, and commoning, provide critical and challenging perspectives about public and private dimensions of our social, cultural and biophysical planet. Commons literature offers a critique of global economy, and

commoning practices suggest that change can be informed by, and through, participant conversations about situated knowledge, that introduce shared understandings of shared social, cultural and biophysical knowledge global practices (O'Connell, 2012). Whilst the commons movement offers a broad ranging theoretical framework for social analysis and future action, one aspect that is of key importance for design research is the rationale it offers for the interconnection of elements and relations between human and non-human, material, physical, emotional and social phenomenon, similar to Reckwitz's (2002) description of practice theory:

'A practice – a way of cooking, of consuming, of working, of investigating, of taking care of oneself or of others, etc. – forms so to speak a 'block' whose existence necessarily depends on the existence and specific interconnectedness of these elements, and which cannot be reduced to any one of these single elements.. A practice is thus a routinized way in which bodies are moved, objects are handled, subjects are treated, things are described and the world is understood.' (Reckwitz, 2002, p. 250)

Catney et al. (2012) discuss local and personal knowledge as situated in what they describe as a 'community knowledge network' (CKN). These are existing communities of people who live and trust each other, grounded in contexts and personal relationships. Catney et al discuss the complexities of understanding different modes of knowledge in CKN research, drawing on theories about the differences between procedural and tacit knowledge (Ryle, 1949) and the differences outlined by Polyani (1966) between tacit and explicit knowledge. Whilst it is not possible in this paper to fully explore these concepts, I argue that the theoretical frameworks offered by Practice Theory and CKN have much to offer design research and practice wishing to engage with social and community contexts. With their focus on identifying social relations and everyday actions as practices within situated knowledge contexts, they provide a critique of interconnections between human and non-human elements that can be useful for design research seeking to initiate social change. As part of this approach, the role of the designer as active participant in the conversation is critical – the designer is actively engaged through the process of conversation:

'Engaging in conversation in the field context allows these dynamics to take shape in relation to a tangible location. As we shall see, the process of articulation itself helps participants to form ideas about the meaning of their experiences, and situate these in a broader historical and social context. The design researchers are also involved in the conversation; they relate their own experiences and generate their own theories about what is

being discussed, which are shared with the participants. In this way, the learning of the design researchers occurs on the ground, within the situation, rather than being imposed from above or (re) constructed from scratch (Findeli, 2001). The conversation, as Baker et al (2002) describe it, aspires to holism – it draws others in and lights the environment up in particular ways, as a distinctively bounded, qualitatively situated place' (Mellick Lopes and Shumack, 2012, p. 122).

3. Understanding community garden sites as situated knowledge producing social capital

Literature on community gardens highlights the importance of informal social activities that take place as forms of social capital, but little is known about the ways this happens over time and in place – as the development of situated knowledge. In their study of a Melbourne CG, Kingsley and Townsend (2006) note the range of social cohesions taking shape in the CG setting that do not however, always extend beyond the CG setting in the early stages of development. They comment:

‘This raises a question about the time required to develop high levels of social capital, and points to the need for further research into ‘time’ and ‘space’ aspects of community gardens’ (p. 525).

Putnam (2000) and Woolcock (2001) refer to the most commonly used distinctions between forms of social capital as bonding, bridging, and linking. Each of these describes a network of relationships from the personal and local, to wider spheres of public connection and networking in public life. Bonding describes dense formations of interconnections and relationships; bridging spans across existing divides of class, and ethnicity, and linking is a more external interaction with the wider social and civic fabric. These relationships are seen as often complex and intangible webs of meaning that take place within and over time, place and space, connecting people with environments and contexts that can be difficult to capture in research. Glover, Shinew and Parry (2005) term ‘leisure episodes’ – the social time spent with others in the garden setting itself is the determining factor for production of social cohesion, regardless of food productivity or other factors. The significance of the local situated context, and the need to include a wide range of factors when considering best practice policy in community capacity building supports the need to engage with a diversity of stakeholders and participants.

3.1 Background to the community garden (CG) case study

The CG case study started out as a research consultancy with a local Council. The approach was effectively a 'top down' intervention from Council that was to be carried out by a research team that included designers and urban geographers, with expertise and interest in producing research that could contribute to innovation in social co-management, and in the production of future scenarios specifically for the local CG context. The project was commissioned with broad and ambitious objectives that sought better understand the current state of relationships between Council and five selected community gardens in the local area. The brief asked the team to research the ways in which communications might be improved between the Council and the CG communities. The brief also asked for the findings to be presented as a written report and a prototype for a web site design that would support an existing, but informal Community Garden Network (CGN). The aim of the web site, if made active, would have been to further build a stronger and more viable local community gardens network.

The research scope was agreed to focus on five very different CG sites – each having a recognizable local community, and some with links to already established and council supported, Community Centres. Through the research process, each of the CG sites revealed a rich and vibrant community where small groups and individuals worked together, in a variety of ways that were not always productive or positive, but had at the core an interest and investment in a local CG site. Each site had its own history and ongoing problems, alongside different management structures and internal politics that often involved dominating personalities or conflicting agendas about how things should be done in the CG.

The researchers became personally involved and supportive of the CG communities, and were constantly aware of the expectations that were building around what the project could deliver to the CG communities, as better or more resources from council, or improved access to existing facilities. As the project progressed, discussions and briefings with Council became somewhat problematic due to changes in staff managing the project from the Council, and a sense of shifting ground around what the project could deliver that might be of value to Council. Discussions with different Council groupings gave different perspectives about the difficulties in working with the institutional and regulatory environment. As a result, the research team became increasingly concerned about the viability of any meaningful outcome from the project, and in maintaining a sense of integrity with the Community Centre managers, as well as the CG groups

and individuals, who had given their time and energy to meet with the researchers, and made them welcome into the CG communities.

The final report included a comprehensive summary of CG policy both nationally and internationally, as well as a focus on the issues and concerns of each of the five local CG sites as general points for what could be done to improve the communication systems. Final recommendations in the report included specific policy amendments about how CG sites could be better managed by Council as an institutional governance – for example, to locate the CG portfolio into the ‘Parks’ section, linking it with support for public open spaces and facilities. The recommendations also included a suggestion that Council develop a transparent process and specific support activities for the initiation of new CG sites that are clear and usable for new and emerging groups.

It is not clear what of the recommendations or research findings were adapted or considered by Council at the end of the consultancy. From a design perspective, the outcome was a future-oriented scenario, and took into account a wide and diverse range of Council, and CG community stakeholder views and practices. The implementation of the recommendations would have required Council to make changes to their policy frameworks, and also to begin to work more closely with other organisations in the CG sector. The shifts being recommended were relatively minor ones, but within the scope of the institutional setting and the solidity and immovability of processes and policies, they appear much larger and more difficult. In the interim, the CG sites continue to work as fairly isolated and mostly poorly resourced groups, dependent upon the commitment and largesse of local community for their success.

At the end of the project, the design team was unhappy with the outcomes produced for the Council and felt that the value of the project had not been fully realized. After weeks of working with the CG participants, and spending time at the CG sites, the researchers had become aware of particular issues and problems at each of the sites. In some ways, the researchers felt that they had let down the CG participants, as their role had in some ways raised expectations of greater Council support that was not forthcoming. As a result, some CG participants were now even more suspicious and cynical about outside support and the role of Council in supporting the CG community.

The very fact that these CG sites exist, however dysfunctional they may be, and that local participants interact there, offers a way to think about the

nature of the social practices and how these could inform or shape future change or innovation, at a local level. Putting aside the problems with the Council brief, the politics of the project, and the expectations of what was to be achieved, further reflection and evaluation of the commentary, personal stories and images gathered as research data provided an opportunity to re-conceptualise the project, through placing importance on the conversations that took place during the research. These findings provide possibilities for new approaches, and for proposing ways in which the CG knowledge network could be supported to become more self-reliant and sustaining.

3.2 Evaluating four conversational dialogues to reveal new knowledge

The methodology used to evaluate the conversational dialogues is adapted from Baker, Jensen and Kolb's five learning constructs. These are conceptual framings for nuances of conversational dialogue, as it develops between participants. The authors describe the pairings as how learning takes place, through the tension of the interplay of opposites and contradictions:

Apprehension/Comprehension: emotional intuitive knowledge-apprehension, and abstract concepts of information/knowledge – comprehension.

Reflection/Action: transforming experience through reflection into an action.

Doing/Being: with reference to time, discursive processes of thinking are guided by linear time - events and actions that take place in real time, and recursive processes are guided by cyclical time – ideas and concepts that keep recurring and which the individuals keep returning to.

Inside Out/Outside In: The self-in-relation to others as a way of linking individuality and connection with others in shared understandings.

Ranking/Linking: The structure of the reference group, the dynamics of participation and one's place within it.' (Baker, Jensen and Kolb, 2002, p. 52).

These five learning constructs are useful tools for conversational analysis, as they offer a set of frames for locating the development, and emergence, of new ideas, as well as the potential links between elements that are described. The aim of these learning conversations is to generate a wide range of views, to open up dialogues, and find new ways of thinking about particular situations and contexts.

In applying this method of conversational analysis, the five frames are used to identify stages of ideation, that don't take place in a linear way. Rather, each conversation meanders and jumps across and through the stages and also may focus on one or other of the learning pairing frame. For example, with 'apprehension/comprehension' – a dialogue may explore what is known (comprehension) alongside what problems may be perceived with that knowledge ('apprehension'). The frame 'ranking/linking' is useful as it provides a way for a conversant to locate their own personal identity placed within a wider social context. Similarly, the pairing 'inside out/outside in' provides a means of contrasting and comparing internal and external world systems and worldviews. The pairing 'doing/being' relates to an ontological space of being in the world, feeling empowered or not, with consideration of liveability and the value of experiential knowledge. The pairing 'reflection/action' provides a means of making sense of things – of linking a reflective mode with an ensuing action that may inform or shape a particular problem.

The process of mapping the conversational dialogues involves breaking down each transcript and loosely noting the instances of where each learning pairing occurs. Given the complexity and diversity of conversational dialogues there is no set pattern for this. However, in the context of this particular project a set of questions are a useful starting point for each conversation. These provided a jumping-off point, for the development of each dialogue as a unique instance of the development of commonality through dialogue. The breaking down of conversational themes into these five pairings provides a way of reading the texts as emergent forms of design thinking, as instances of co-designing. What can emerge from this analysis is an understanding of emergent themes across a set of conversations around specific issues. As well as noting the big picture themes being explored, the small details that arise through the dialogue can be significant. These can be sparks for new thinking, and shift the conversational flow as it develops.

The following table shows the breaking down of four conversations into the learning pairings. This demonstrates the flexibility and fluidity of the pairings as frames for locating different modes of thought, action and reflection. The four interview subjects include a Council employee, two volunteer CG members, and one Mandarin interpreter speaking for the volunteer CG members.

Table 1 Summary of 4 participant learning conversations.

Conversational excerpt #1 with Council project worker	
<p>Researcher: Can you give a brief overview of your role with the Council and the CG’s?</p> <p>Participant: My role is as an interpreter and liaison with council processes and barriers. I often help meet with different sections of council and help sort out their problems and blockages. Mostly council are concerned about governance and insurance issues, and a lot of that can be sorted out through the garden group being linked to a community centre.</p>	<p>Ranking/ linking</p>
<p>Researcher: Can you give an example of how the community centre links can help in day to day running of the gardens?</p> <p>Participant: It’s important to have a lead agency when you are setting up a new garden, as there is somewhere to meet and a way to manage how things are going. It is a designated park, a recreational use of public land. So it should be under parks. Water is being used like you would water a football field really, what’s the difference? There is not actual membership fee, but a \$30 key deposit.</p> <p>I had a discussion with them about a payment system of time spent in the garden, not cash, but that wasn’t seen as a good idea. Anyhow, you can always pick up a key from the Community Centre to get in. Council insisted on the fence around that garden, and the residents also wanted it. Yes it does look like now it’s a private place, but everyone knows how to get access if they need to. The problem is that it’s a quiet street, and people get here by car or public transport.</p>	<p>Apprehension/ comprehension</p> <p>Reflection/ action</p>
<p>Researcher: So have the garden groups received grant funding from different sources?</p> <p>Participant: The gardeners have received money for the project from different funding sources including the government, and also from industry. That’s another benefit from being linked to a Community Group. The problem is that the community gardens aren’t in anyone’s actual portfolio – it could easily slip off the agenda. It’s not in my portfolio as such, but I support them to get established. It should be in Open Parks portfolio, their background is in landscape and environment, but they don’t have environmental education. The way things get done at Council is based a lot on personalities. They’re very busy, but the current coordinator was keen to get that garden started so helped set it up. They do have a common liaison officer who looks after meetings but they wouldn’t really have the skills to help much.</p>	<p>Ranking/ linking</p> <p>Doing/ being</p>
<p>Researcher: What happens when conflicts arise with the Community Centres and the gardeners? Who helps out with that? And what was the role of Council in setting up this garden network idea?</p> <p>Participant: I was called in to help out by the manager of the Community Centre to resolve a conflict. I could do it as I have the skills, but not everyone knows how to do this. At the end of the day, so much comes down to personalities. I initiated this garden network idea to get people talking together, to show off their gardens. The idea for the community network is that they meet four times a year – once for each season. They have the chance to apply for funding from different sources. I arranged to get some funding for the bus trip, and it was a great success! A fantastic community spirit! After the</p>	<p>Reflection/ Action</p> <p>Apprehension/ comprehension</p>

*Social Design for whom and what purpose? Community network knowledge, conversation-
as-commoning and design research*

<p>bus tour, you could actually see their passion to support each other. It worked so well as it was relational.</p>	
<p>There is so much that they could do if they worked together. For example, we could be bulk purchasing soil, seedlings, and fertilizer. We could buy 200 seedlings for \$20 – we could go and get 6 different types and divide them up between the gardens. One of the things I was keen to see for the network was Gardener of the Month – sort of like a profile of someone that gave a sense of their history, what they grow, how they like to garden and things like that. We could also have a calendar of events, so people would know what’s coming up.</p>	<p>Reflection/ action</p>
<p>Conversation excerpt #2 with local gardener</p>	
<p>Researcher: So how long have you been involved in community gardening? Participant: I’ve been growing organic fruit and veggies for over 20 years now. I used to grow 40 acres of it up on the north coast. A lot of that was sold down to Sydney. Nowadays I grow at least 80% of what I eat still, so that’s still pretty good going. We’re at a crossroads now with the way things are going. Look at how we get most of our food now – from the supermarket! We could be doing so much more growing our own food – well not all of it, but at least giving it a go and sharing what we grow. Of course, we also need to think about the problems of growing food on roads and in places where the soil is poor quality. Look at all those houses with large yards where it’s all concreted – to dig that up would be a big job. You also have many places where there is so much DDT sprayed – none should be growing food there. But over time, the soil could be improved.</p>	<p>Doing/ Being</p> <p>Reflection/ Action</p> <p>Ranking/ Linking</p> <p>Reflection/ Action</p>
<p>Researcher: What kinds of things could be done more as a garden network do you think? Participant: If we were bulk purchasing say, of lucerne, we could be working on remediating areas of poor soil, and gradually things would improve. We should be talking to council about how they could make corridors for green waste collection – all the grass clippings they have each week, could be used for a community composting system. People could go there and bring their own grass clippings and home composts. This would be a fantastic way to start to change people’s attitudes – for a start they would start to understand how good soil is made! We should be thinking about a good rich soil as a river of gold! We could be exporting our compost and good soil to other councils. It could become a really good small industry to support small-scale local gardening.</p>	<p>Reflection/ Action</p> <p>Inside out/ outside in</p>
<p>Researcher: So how does the garden impact on the local suburb – can you see a connection between the garden site and other parks sites around here? Participant: We should be growing low maintenance fruit trees to attract birds and other wildlife to the area, using the parks as a green belt rather than seeing them as individual spaces. We should be seeing the city, and this suburb, as part of a much bigger urban environment.</p>	<p>Inside out/ outside in</p>
<p>Conversation excerpt # 3 with local gardener</p>	
<p>Researcher: So tell us about your work here with the school garden, and how long you’ve been involved.</p>	

<p>Participant: Actually, I'm a retired truck driver, and I just live across there. Our garden land is actually owned by the school there. Each time there's a new principal things change. The kids are actually by law only allowed to come here if they are being supervised by a teacher that is usually fine. We grow a lot of herbs and veggies, mostly we give it away to the kids and their families. Lots of the kids have their own small plot for plants. Sometimes they just don't know what to plant, or don't have anything to plant. Well one kid, he just went and planted one of everything he could find – one onion, one tomato, one parsley. He didn't care it was just so he had his own little garden. He loved watering them and coming to see how they were going.</p>	<p>Doing/ Being</p> <p>Apprehension/ comprehension</p>
<p>Researcher: I guess the kids are learning about failures as well as when things grow well..</p> <p>Participant: Pumpkins are always easy to grow, and they can get so big. One year we had the idea for the kids to enter their pumpkins in the Royal Easter Show. The kids grew them, but they got some kind of fungus and were ruined, maybe they didn't really know how to look after them. Well I had taken some of the smaller pumpkins to my place and had them under the house. I got them out and they were fine – well the kids had grown them all, so I thought let's enter these ones. Well anyway, we didn't get the paperwork done in time, and the kids were really disappointed. On the day I just drove the pumpkins into the Show, and I was going to speak to the organisers about how the kids had grown them and we were so proud of them, but we didn't get our paperwork done, well anyway, the paperwork somehow got done, and they took our pumpkins. We had no chance of winning of anything, but boy the kids got a big thrill from seeing their pumpkins in the exhibition!</p>	<p>Reflection/ Action</p> <p>Doing/ Being</p>
<p>Researcher: So does the school encourage others in the community to come along and volunteer? Is that a good support as well?</p> <p>Participant: One year the school arranged for some corporate group to come and do volunteer work here. Well they all arrived in their new t-shirts and with their lunches all laid on. They made a huge mess and didn't ask us what needed doing. They pulled out some of our seedlings, and left all their rubbish stacked up in the compost bins. It took us ages to clear them out. Another time the council were digging up the street for something, and there was a whole lot of soil left over. We went and asked them if they could dump it over where we could get it. Now we have a good compost system going with lots of fresh worms and its lovely.</p>	<p>Ranking/ linking</p>
<p>Conversation excerpt #4 with Chinese interpreter and gardeners</p>	
<p>Researcher: What do the gardens mostly grow, and how often do they come down to the garden - it looks as though they are here fairly often</p> <p>Participant: They mostly grow Chinese vegetables like choy-sum, and lettuce. They come here twice a day, in the morning for watering, and then before dinner they come back. They are all immigrants; they have been here for over 10 years, living in the blocks around here. There aren't many chairs, but that's ok – they want more garden beds! They have had their beds for a long time. There is a rule – if someone doesn't plant for 3 months, they lose their bed. Every season is different for planting things. The biggest problem is with the soil, they don't know how to make it better. They bring their own food scraps</p>	<p>Apprehension/ comprehension</p>

down, and have some fertilizer. But it would be good if there could be some workshops or training about how to do better composting. Sometimes they don't grow much, but its great just coming down and being here.	Reflection/ Action
---	-----------------------

Using this method of conversation analysis provides a way to succinctly capture key moments of insight that emerge as a result of the conversational flow of dialogue. The kinds of reflection, the detailing of personal histories and knowledge, and the suggestions about future possibilities for the Council to consider are key emerging themes. This is a body of new knowledge that has been created as a result of the interactions of the design researchers with the community participants. Figure 1 shows the process of interactions as a social space at the CG sites, where a level of informality and a shared interest in the processes of community gardening contribute to a common interest.



Figure 1 community garden as social learning commons.

4. Conclusion

The four conversational excerpts described above provide a variety of suggestions and reflections for future action, and change as knowledge that is shared and co-produced by the design researchers and CG participants.

These include suggestions for how to do things more effectively, problems at specific garden locations, as well as suggestions about ways things could be better organised through careful and considered relational planning in the future. From the perspective of design research, the insights provided by the conversations provide a rich starting point for further potential work with the CG community, as possible initiatives that could be developed in informal ways. For example, the idea of bulk purchasing of soil, seedlings and lucerne, for sharing amongst the CG sites and gardeners, through facilitating links with nurseries and garden suppliers. Another

activity could be facilitating workshops about composting and soil maintenance practices. The role of the designer here could be to work as a creative driver of future activities based on conversational learning with the participants and stakeholders. These exchanges are shared and co-owned forms of knowledge commons, that are based on engagements with the interconnectedness of people, places and things in the world.

References

- Baker, A.C., Jensen, P.J. and Kolb, D.A (2002) *Conversation as Experiential Learning Conversational learning: An Experiential approach to knowledge creation*. London: Quorum Books.
- Catney, P., Dobson, A., Hall, S.M., Hards, S., MacGregor, S., Robinson, Z., Ormerod, M. and Ross, S. (2013) Community Knowledge Networks: an action oriented approach to energy research. *Local Environment*, 18 (4), 506-520.
- Findeli, A. (2001) Rethinking Design Education for the 21st century: theoretical, methodological and ethical discussion. *Design Issues*, 17 (1), 5-17.
- Gibson-Graham, J.K., Cameron, J. and Healy, S. (2013) *Take Back the Economy: An Ethical Guide for Transforming our Communities*. Minneapolis: University of Minnesota Press.
- Glover, T.D., Shinew, K.J. and Parry, D.C. (2005) Association, Sociability, and Civic Culture: the Democratic effect of Community Gardening. *Leisure Sciences*, 27 (1), 75-92.
- Jeffrey, A., McFarlane, C. and Vasudevan, A. (2012) Rethinking enclosure: space, subjectivity and the commons. *Antipode*, 44 (4), 1247-1267.
- Kemmis, S. and McTaggart, R. (1988) *The action research planner*. Geelong: Deakin University Press.
- Kingsley, J.Y. and Townsend, M. (2006) 'Dig In' to social capital: community gardens as mechanisms for growing urban social connectedness. *Urban Policy and Research*, 24 (4), 525-537.
- Labonte, R. and Laverack, G. (2001) capacity Building in health promotion Part 2: Whose use? And with what measure? *Critical Public Health*, 11 (2), 129-138.
- Verity, F. (2007) *Community capacity Building: A Review of the Literature*. Department of Health, Government of South Australia.
- Putnam, R.D. (2000) *Bowling Alone: the Collapse and Revival of American Community*. New York: Simon and Schuster.

Social Design for whom and what purpose? Community network knowledge, conversation-as-commoning and design research

- Sanders, E.B.N and Stappers, P.J. (2008) Co-creation and the new landscapes of design CoDesign. *International Journal of CoCreation in Design and the Arts*, 4 (1), 5-18.
- Lopes, A.M. and Shumack, K. (2012) 'Please Ask Us' Conversation Mapping as Design Research: Social Learning in a Verge Garden Site. *Design Philosophy Papers*, 10 (2), 119-132.
- Nonaka, I. (1994) A dynamic theory of organizational knowledge creation. *Organization Science*, 5 (1), 14-37.
- O'Connell, T. (2012) This land is our land: the fight to reclaim the commons, media education foundation. *Community Development Journal*, 47 (1), 156-158.
- Polyani, M. (1966) *The tacit dimension*. New York: Doubleday.
- Reckwitz, A. (2002) Toward a Theory of Social Practices: A Development in Culturalist Theorizing. *European Journal of Social Theory*, 5 (2), 243-263.
- Ryle, G. (1949) *The concept of mind*. London: Hutchinson.
- Woolcock, M. (2001) The place of social capital in understanding social and economic outcomes. *Isuma: Canadian Journal of Policy Research* 2 (1), 11-17.



Otherwise Engaged: designing a post-digital Space of Appearance in Auckland, New Zealand

Charles WALKER^{*a} and Dermott McMEEL^b

^a Auckland University of Technology; ^b University of Auckland

This paper revisits Hannah Arendt's (1958) notion of a 'Space of Appearance' as the foundation of a public realm within which citizens identify, debate and create civic values. However, in the six decades since Arendt's work first appeared, it has been repeatedly asserted that emerging information and communication technologies (ICT) will render physical public or civic space obsolete. By re-reading Arendt's space of appearance in light of the development of mobile ICT, this paper will propose new possibilities for a new understanding of the space of appearance, capable of fostering new forms of civic engagement for our post-digital age.

We present four design projects that explore the practical, trans-disciplinary implications, disruptions and potentials afforded by pervasive ICT for distributed, micro-level, decision-making (citizenship) in Auckland, New Zealand.

Keywords: *Space of appearance; digital citizenship; citizens' values*

Introduction

In *The Human Condition* (1958), Hannah Arendt maintained that our very sense of reality is dependent upon the presence and mutual apprehension of others. For her, the creation of citizens' values is conceived in relation to the Greek notion of the polis, where citizens gather or appear to one another, face-to-face. However, this polis is not just a physical space per se, but rather is simultaneously the locus of political speech and action as well as the expression of the ethos or values of the public realm that emerge as the result of human interaction. It is, thus, 'the space of appearance in the widest sense of the word' (Arendt, 1958, p. 198), constituted by both people

* Corresponding author: Charles Walker | e-mail: charles.walker@aut.ac.nz

and place. However, Arendt was also aware of the difficulties of adapting this classical model to the societies of the 20th century;

‘The public realm, as the common realm, gathers us together and yet prevents us from falling over each other, so to speak. What makes mass society so difficult to bear is not the number of people involved, or at least not primarily, but the fact that the world between them has lost its power to gather them together, to relate and to separate them.’ (ibid, p. 52-53)

While Arendt, a philosopher and political theorist, did not address the design or spatial characteristics of this public realm in which citizens were to be gathered together, she was nevertheless acutely aware of the necessity for this conceptual space also to be made concrete, or ‘tangible’.

‘The whole factual world of human affairs depends for its reality and continued existence, first, upon the presence of others who have seen and heard and will remember, and, second, on the transformation of the intangible into the tangibility of things’. (ibid, p. 95)

By recognizing this interdependence of people, place and things, Arendt draws our attention to the critical importance of both technology and design in the creation of civic values.

Since Arendt’s time, social change and the rapid development of ubiquitous ICT has transformed traditional typologies and tenets of civic space. As Arendt’s ‘mass society’ has become ever more diverse and fragmented, relations of people and place have been progressively challenged, subsumed or replaced by abstract, technologically-mediated forms of immaterial cultural production and consumption.

In this paper we argue that this shift is most apparent in the urban public realm, where exposure to diverse social and cultural values has historically been a marked feature of daily life. If we accept, for now, the notion that the city has historically provided a model of the gathering function of the public realm, then what might characterise the legitimate model for our emerging post-ICT space of appearance? It also has historically been charged with creating both virtual (conceptual) and physical (as built material) expression of the values of civic institutions, states or corporate bodies. Arendt’s metaphors of space and structure suggest an architectonic conceptual framing. Architecture, as a discipline, deals with complex and nuanced boundaries and thresholds, particularly between public and private. For us, an understanding of urban architecture as ‘built metaphysics’ offers considerable scope to explore the notion of collective values through spatial design metaphors. More specifically, we also ask whether it is now possible to create a new, post-digital space of appearance

that affords historically unavailable levels of participation and decision-making for all individuals, via distributed, micro-level public platforms.

The dematerialization and re-materialization of civic space

In writing about the structural transformation of the public sphere from the 18th century into the 20th, Jurgen Habermas (1962; 1988) has already challenged the currency of Arendt's metaphor of the public realm as a visual phenomenon that requires citizens to see and be seen in order to be heard. Habermas argues that, since the Enlightenment and particularly with the advent of modernity, the public realm is already disembodied as citizens have evolved into a virtual community of authors, readers and writers, who do not need to be present to one another physically.

More recent commentators have argued that ICT now creates another level of disembodiment, resulting in a further dematerialization or even disappearance of public space. Hampton (2010), suggests that contemporary mobile wireless devices have significantly altered the dynamics and possibilities of presence or interaction in public spaces, 'where the reduced attention to surroundings, in the form of people-watching, a focus on private, head-down activities, and limited response to stimuli from the environment suggest that wireless Internet users are exposed to significantly less social diversity in urban public spaces...' (Hampton, 2010; p. 713). At first glance, this increased focus on the individual experience at the expense of wider environmental or human interaction seems to create a privatised 'space of distraction' (Benjamin, 1969), extending the sensory dislocation beyond the visual, further compromising Arendt's public space of appearance.

Other products of digital culture are also predicated on cognitive, typological and topological shifts from physical to virtual modes of connectivity and presence. Examples range from *Neuromancer* (Gibson, 1984), a novel that popularized the notion of an immersive 'cyberspace' as a de-facto term for the world-wide web, to the film *Her* (Jonze, 2013), portraying affective relationships between humans and artificial intelligence operating systems.

Yet such products also challenge earlier discourses of 'de-materialization' of space and place, by suggesting that the effects of pervasive ICT need not be predicated on often naive utopian /dystopian distinctions between public and private domains. In this paper, we acknowledge this altered, yet still very 'material' quality of ICT and digital

media. Recent events unfolding in different cultural territories serve to deepen this understanding of more subtly mediated concepts of materiality, values and citizenship. In New York's Zuccotti Park, the Occupy Wall Street movement created a hybrid local/global forum for a debate civic values, as did the recent protests in Gezi Park in Istanbul, Turkey. In both these situations physical place and digital media became entangled, and the binary polarisation of private and public by which we routinely describe our engagement through digital media has been found wanting. The relationship between public space and digital media is thus in urgent need of revalidation. Design is a useful lens through which to gain perspective on more nuanced concepts of public and private and the liminal thresholds between the two.

Digital citizenship, values and participation in Auckland, New Zealand.

Located on the edge of the globe, Auckland, the 'First City of the Pacific' is governed by the largest council in Australasia, with NZ \$29 billion of assets, a NZ \$3 billion annual budget, and approximately 8,000 employees.¹ Demographic and economic projections suggest that the population will reach 2.5 million by 2040. Whilst modest by global standards, this represents 40% of the total NZ population and the majority of indigenous Maori, Pacific/Polynesian and 'new settler' citizens, 50% of whom are under 25. What is at stake in this 'Pacific City' discourse is not only the long-term equity and sustainability of any political, cultural, environmental or economic values of citizenship, but also the speculative/anticipatory potential of design to create a pluralistic civic space of appearance and participation.

The city, increasingly understood as a complex, emerging 'system of systems' (Batty, 2013) simultaneously hosts, creates and reflects the values of diverse, overlapping, political, social, techno-scientific, economic, artistic and cultural communities. Yet city-making – as a civic, multi-disciplinary, multi-professional endeavour employing both material and metaphor - has

¹ In November 2010, Auckland merged the functions of an existing regional council and seven previous city and district councils into one "super-city" governed by a mayor, 20 members of the governing body and 148 members of 21 local boards.

struggled to come to grips with this idea of a disembodied public realm and its complex networks of interlocking conversations and events.

Public: The value of place

We have already noted that polis refers to both the state and citizens, deliberately blurring the distinction between legitimizing ideals and material presence. The political events in Zuccotti and Gezi Parks attest to the persistence of this blur, even while the state seeks to reinforce the distinction between public and private. For spatial designers, it remains critical that spaces remain at the centre of these digital occupations and protests. Zuccotti Park is a privately owned public park (POP), chosen by the Occupy Wall Street movement because it must remain open 24 hours per day, a legal requirement of a POP, and not subject to public part curfews. As a consequence it was difficult to remove protestors partly because the responsibility for doing so fell upon the owners and not the police. This draws attention to the relationship between the citizen and the state, or space of occupancy. In spatial terms, the citizen has reasonably robust rights with regards to physical space that are somewhat feeble in digital space. This invites further questions of citizens' values in digital space.

Private: The problematic values of the technology rich home

The contemporary home provides an excellent metaphor for the increasingly complex layering of public/private boundaries and values. In New Zealand, the common colonial architectural typologies of veranda and porch provide a material reading of social expectations of public and private, and access to the thresholds between the two.

In terms of the digital ICT world however, the thresholds of virtual access to the domestic sphere are materialized as text, appearing on computer screens framed in long-format, small-font and difficult to comprehend legal 'Terms and Conditions'. Access here is facilitated by a seductively easy-to-click 'Agree' or 'Accept' button that, once activated, quickly dissolves the digital privacy boundary.

Common Values

Perhaps somewhere between the two illusory concepts of public and private is a third notion of space, more amenable to plurality, paradox and the networks of contradictory values that contemporary citizens must now routinely surf.

In Roman times, the 'commons' existed alongside public and private space, as a third category relating to natural resources. Rather than being structured around ownership, the space of the commons is defined by the rights that people have within it rather than by the restrictions that are placed upon them. Contemporary commentators such as Laurence Lessig (2006; 2012) and Peter Barnes (2003) conceive the commons as a 'coded' set of cultural or technologically mediated assets that have two characteristics: they are all gifts, and they are all shared.

Without resorting either to a *faux* nostalgia or to Robbins (1993) notion of the 'phantom public sphere', the idea of siting design work in the commons seems to us to afford more productive possibilities for anticipating and responding to the crises of citizens' value than siting it within some now problematic notion of public space. We seek to position design work in spatial locations that are explicitly defined by the rights that are conferred upon people – difficult though such locations may be to find – and to enable a wider concept of the ways that people of all kinds might engage with such work. It is premised on the notion that all our design acts are political and that we operate in a social context.

In this sense, the concept of the commons allows us to address the critiques of Arendt's space of appearance by speculating on the nature of the 'network commons' (Lessig, 2006) or the overlap of production and distribution characteristic of the 'hacker' movement. Such notions of openness begin to address the challenge of creating shared values within some tangible, yet hybrid, new space of appearance.

Blurred Lines: City Hacking and Urban Prototyping

This brings us to our own presentation of four projects that explore the boundaries between digital and physical spaces of appearance in Auckland.

City Hack

In the first project we 'banned' a group of architecture students from the university for one week. During that time, they were required to 'hack' the city of Auckland, by finding or appropriating the spaces necessary for their work, meetings and discussions. This took students from cafés to art galleries, from open buildings to parking lots. By utilising different spaces, students frequently drew attention to the politics and value of space and to their own values and citizens' rights within those spaces. Conversely, students also came to appreciate some of the limits and opportunities of the

more generic spaces, computer or open access labs and digital tools provided by the university for their architecture education.

By appropriating the city, students and teachers were able to select specific public/private locations that were conducive to specific activities, and that were able to support affective relationships in ways that the university's generic facilities could not. Participation in discussions in a café with free wifi was notably more informal, yet also more inclusive and more productive than in the generic university building. These locations also altered the politics of interactions. Facebook was used to arrange meeting locations and time, opening access to course material and challenging the value and necessity for such information to be secured behind the university firewall.

A project review at the end of the week within an art exhibition space was also very conducive to group involvement and critique. It also changed the perceived value of the work they pinned up – as it was now made visible to the public. In this case, students were also able to draw on the walls, something that typically does not happen when reviewing design projects. This too caused a different level of interaction around the work than would typically happen, including the documentation of key themes that students could see emerging in this public space of appearance and critique.

We also suggest that the choices of spaces were in themselves design choices. A café 'redesigns' the meeting interaction. Choosing Facebook changes the politics of faculty/student communication. A gallery setting alters the value of the work and the events that unfold within its walls. That is to say such spaces, not unlike Zuccotti Park, have embedded within them freedoms or rights that render them conducive to specific activities in ways that generic institutional spaces do not.

Auckland Transport Civic Hack

The second project critically engaged with Auckland City Council's ambitious goal to become the world's most livable city. The Auckland Transport authority and its services are seen as key enablers of this goal. Whilst Auckland Transport has a clear set of infrastructure projects and service improvements underway, it also realises that the physical experience and emotional connection between users and system will drive patronage and growth of the services. The project explored citizens' values through an open invitation to designers, software developers, architects, activists, innovators or anyone who wanted to be involved, to participate in

a weekend of 'hacking for good'. Core to this civic hacking is the availability of open government data. Some four hundred people joined the two-day project. The project thus addressed five broad goals: enabling innovation for greater good; creating a new self-governing community of citizens; supporting the evolution and democratisation of open government data; providing an opportunity for self development and personal network building, and; supporting the New Zealand government's agenda to increase knowledge and participation in Science, Technology, Engineering and Maths (STEM) fields.

The Virtual Urban Village (VUV)

The VUV is a blended real/virtual game-space that seeks to empower Auckland citizens to create a new space of appearance for collective design and decision-making around notions of livability, while also providing a forum for critique the authorities' version of their city. The project was conceived and developed by the authors and a larger team at a two-day Smart Cities 'ideation' workshop in February 2014. It addressed the dualism that large cities are often perceived as problematic, alienating, unmanageable or in some other way unlivable due to their scale, while simultaneously also capable of being understood as clusters of 'villages' with definable characteristics, atmospheres, cultures or 'vibes' that impart a particular identity or sense of belonging. The project proposed new spatial, temporal and digital platforms, products and services that allow citizens to engage or identify in more direct ways with their neighbourhoods and communities. The project does not make clear distinctions between, say, virtual or real environments but blends these domains to create more subtle or nuanced experiences of urbanity. It explored spatial metaphors: the 'Town Hall' (participation, voting and decision-making), the 'Village Green' (a space of open data/free software), the 'School' (lifelong education), 'Workplace' (emerging career paths in the new digital economy), 'Clinic' (e-health & wellbeing), 'Warehouse' (the global Internet of Things) etc. The strategy began by creating a free mobile game platform, to build brand awareness, audiences and revenue. The next phase, currently underway, develops longer-term strategies for civic, cultural and commercial platforms for the urban space of appearance.

Mesh Cities: Space, Network, Memory

This project resulted from a collaboration with the Atearoa Digital Arts (ADA) network and the Mobile Innovation Network Atearoa (MINA) to

develop research, provocations, panel participation and presentations of work engaging with the broad range of practices and approaches necessary for rethinking the contemporary city, the networks that surround and emerge from it, and the memories and futures it holds. This event was run in conjunction with the annual Auckland Architecture Week, and addressed theoretical, social, technical and philosophical issues for the future of the city. The project asked - what roles do digital networks play in framing how the various 'layers' of the city are revealed and understood? How does this affect contemporary attempts to create new forms of civic space in the fields of art, architecture, urban planning, infrastructure, software design and related fields?

Summary

This paper has presented projects that set out to design and realize a contemporary iteration of Arendt's civic realm for our own age – a post-digital *data-space* of appearance within which citizens' values might be articulated and represented. We have shown examples of hybrid post-digital spaces that are not simply public or private, but afford multifarious occupation, porous boundaries, portals or thresholds between different forms of engagement. We have also noted that while there are myriad privacy settings on social media and mobile devices, they are not yet as intuitive as they appear to be in physical space. Yet, the new vibrant space of citizenship depends upon our ability to understand and negotiate these boundaries, and to speak and act accordingly. Moreover, the projects serve to open up further areas of research and construct new understanding of an emerging 'digital materiality' of the space of appearance.

References

- Arendt, H. (1958) *The Human Condition*. Chicago: University of Chicago Press.
- Benjamin, W. (1969) *The Work of Art in the Age of Mechanical Reproduction*. In Arendt, H. (eds.), *Illuminations*. New York: Schocken Books.
- Bratton, B. (2012) *On the Nomos of the Cloud: The Stack, Deep Address, Integral Geography*. [online] Available from: <http://bratton.info/projects/talks/on-the-nomos-of-the-cloud-the-stack-deep-address-integral-geography/>. [Accessed 10th February, 2014].

CHARLES WALKER, DERMOTT MCMEEL

- Coyne, R. and Snodgrass, A. (2006) *Interpretation in Architecture: Design as Way of Thinking*. New York: Taylor & Francis.
- Gibson, W. (1984) *Neuromancer*. New Jersey: Ace Books.
- Hampton, K.N., Oren, L. and Goulet, L.S. (2010) The Social Life of Wireless Urban Spaces: Internet Use, Social Networks, and the Public Realm. *Journal of Communication*, 60 (4), 701-722.
- Habermas, J. (1962/1988) *The Structural Transformation of the Public Sphere: An Inquiry into a Category of Bourgeois Society*. Cambridge: MIT Press.
- Robbins, B. (eds.) (1993) *The Phantom Public Sphere*. Minneapolis: University of Minnesota Press.

SECTION II

Design, Creativity, and Processes



A Manifesto of Change or Design Imperialism? A Look at the Purpose of the Social Design Practice

Danah ABDULLA*
Goldsmiths University of London

Social design and design activism are some of the buzzwords being used amongst designers to describe a form of design that seeks to investigate the designer's role in society by tackling community, political, and social issues.

Social design is meant to pave the way for design to move away from a Eurocentric discourse, engage communities, spark local innovation, and help increase collaboration between communities, policy makers, and institutions to bring about social change and ideas through design. But there are a number of issues and questions that arise: Where is the context? Why do we continue to design at rather than design with? What are the true intentions of these projects? How can we measure results? Where are the designers from the non-Western world? What does community participation mean? This paper critiques the discipline of social design by highlighting issues through case studies and discourse, and offers solutions on how social design projects can truly begin to engage in debates and shift the discourse to be more inclusive and sensitive.

Keywords: *Social design; design activism*

Introduction

Recently, terms like social design and design activism – often summarised as ‘design that changes the world’ (Markussen, 2013, p. 38) and are inclusive of all design rather than being restricted to one– have been springing up in debates, articles, client briefs, and academia. Tired of being part of the problem rather than the solution, designers have shifted their priorities, and have now become interested in investigating the designer's role in society by tackling community, political, and social issues, and concerned with issues such as ‘[c]limate change, materials shortages, the

* Corresponding authors: **Danah Abdulla** | e-mail: dtp02da@gold.ac.uk

inequitable distribution of resources...political instability, and globalization...’ (Lees-Maffei, 2012, p. 90).

As social design redirects the discipline and rethinks the design practice, the shift brings with it a sense of responsibility and accountability to communities where the work is taking place, to the design community, and to the role of design and the designer in society. In this paper, I question the intent of design projects branded with the above-mentioned buzzwords and its effects on the communities it seeks to address by examining the methodologies and intentions. I argue that said projects are guilty of ‘design imperialism’ where, rather than helping increase collaboration between communities, policy makers, and institutions to bring about social change and ideas through design, projects exploit the communities in which they pursue the work. Using two concepts from Irani et al. (2010) – engagement and articulation – I conclude with proposed solutions and methodologies that can be implemented in independent projects and higher education design curricula to address this shift in the design practice.

The Shift towards Social Design

The idea of values in design was most highlighted in 1964 when Ken Garland presented his First Things First Manifesto – revived in 2000 by culture jamming magazine *Adbusters*. Since design is a field largely serving industries and corporations, associated with mass production and consumption, First Things First questioned this unquestioned service to clients. The question is: should designers actively engage their societies by concerning themselves with political and social issues? This constant debate in design has recently become more significant. Ou Ning claims, nowadays most artists and designers are quite aware that their creations need to have social relevance – critical implementation has become the trend of current art and design...’ (Ericson, 2011b, p. 190). Institutions across the USA and Europe are catching on as various universities have started engaging in community-centred design projects in the past few years. Although a number of independent organisations and individuals have been initiating workshops and projects worldwide, more recently, schools across the USA have developed graduate programmes dedicated entirely to ‘design for the greater good.’ As the discipline establishes itself within academia, there are three main critiques that should be addressed by the institutions:

1) Tuition

Most private art colleges in the USA, some of which have launched social design programmes, cost over \$30,000 USD per year. This is a huge barrier to most, attracting wealthy, middle and upper class students. What's more, these programmes seek to work with disfranchised, poverty-stricken areas, at times developing new campuses based in those neighbourhoods. This brings up a number of problems for the community, mainly forcing an institution into an area, and lack of access to members of the community to such high priced education. This means that no representative is able to participate in the programmes as students but rather as 'projects.' In my first hand experience studying in a Social Design Masters, I quickly realised that most of the time the community is rarely involved in decision making and they are *planned at* rather than *planned with*. If these programmes set out to work within the communities where they are based, shouldn't the community be more than just a project?

2) Separate discipline or an extension?

It is often the case that the heads of social design programmes come from more traditional design backgrounds, and it's common to attempt to cater projects towards familiar territory. So what does the word 'interdisciplinary' mean in this case? Pines (2011) argues that social design – although filled with good intentions – is redirecting attention from designers who can redefine this profession and making design, rather than social design, as something without value. He suggests that the term itself 'suggests that design isn't social to begin with [...implying] that design for the greater good is more important than traditional uses of design' (Pines, 2011). Pines' statement illustrates the confusion over social design's placement. His essay categorises social design within the confines of graphic design (his training). I would argue that the development of social design does not aim to undermine all the sub-fields of design, rather it is a field of its own – a general, interdisciplinary stream of design focusing on social issues and entails a designer taking on the role of researcher, ethnographer, project manager, author, producer and maker, developing everything from services, processes, and strategies to products.

It is important to bring ideas pushed by social design into design generally, but unfortunately, Pines' confusion over the term is common, even though social design programme language does not place it as a sub-discipline of another form of design (see figure 1).

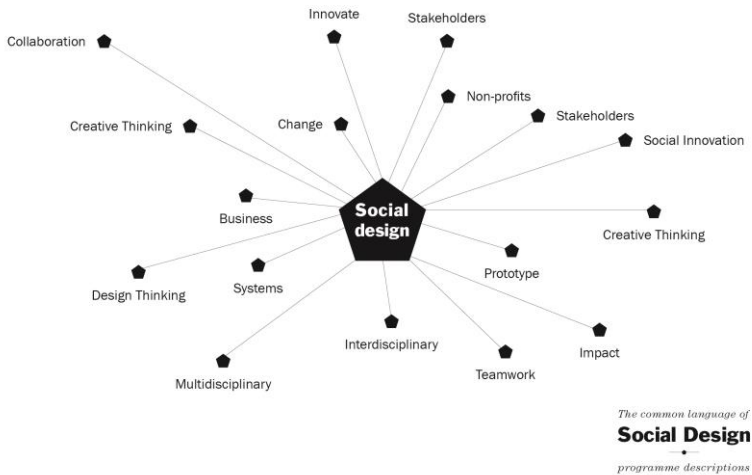


Figure 1 The common language of Social Design programme descriptions.

A solidified definition of what social design is required; this will lead not only to more collaboration with other fields, but help in the understanding of its purpose and goals.

3) On a Deadline

The life of projects is another concern with social design projects, particularly with graduate programmes as they are structured around visits by guest lecturers, who come in to pursue projects that are 7-14 days in length, which is not nearly enough time to get fully immersed in the experience. This critique extends to independent projects, which usually last for two weeks annually at most, and every year brings a fresh group of participants. Within graduate programmes, students participate in a few community projects, focus on their thesis, and most likely leave once the programme is complete. What happens to the projects when designers graduate? This renders social design projects as ephemeral, and that defeats the purpose as it prevents measurement. In discussing a project she initiated, Doina Petrescu claims that self-management is an important tactic. When her team wanted to leave the project, they needed to make sure that groups were able to self-manage. Their methodology was to encourage people 'to

progressively learn and take responsibility for different small devices. Rather than one person, there were groups dealing with the kitchen, the library, etc.' (Mazé, 2011, p. 96). A sustained commitment is essential.

Centre/Periphery

Design thinking is everywhere lately, and its popularity has led to the development of 'social' branches of global firms. Furthermore, projects that started off as yearly social design retreats have developed into larger organisations. A perusal of the list of partners, employees, advisors, board members, and collaborators of agencies such as Future Partners (whose projects include several initiatives in largely African-American areas in the USA) and Catapult Design (whose projects have spanned Indonesia, Uganda, Kenya, India, Tanzania, and Navajo, Arizona working with a Native American population) is alarming: everyone on the list is not from or related to the stakeholder, in terms of background, socioeconomic status, or ethnicity.

Although the world '...can no longer be structured in terms of the center/periphery relation' but rather 'defined in terms of a set of interacting centers, which are both different from and related to one another...' (Hall, 2001, p. 21), social design projects continue to place

'...Western design companies ... as active agents who guide, serve, embed, build, pay, and staff (the design processes). On the other hand, [non-Western] institutions are represented as those to be passively guided and directed or to serve as sabbatical hosts, sites for capacity building, philanthropic tourist destinations, and support staff for projects' (Tunstall, 2013, p. 236).

Even within projects centred across the USA by US-based organisations, they '...invoke the idea of ... 'here' and 'there', where 'there' is other, apart, and disconnected, stably distanced from 'here' (Irani et al., 2010, p. 1313). Implying an 'otherness', they enact uneven power relations (Irani et al., 2010), framing a privileged (centre) helping the minority (periphery).

Project M

To illustrate this, I would like to discuss Project M, a US based initiative that encourages young creatives to 'think wrong'. Thinking wrong is based on Edward de Bono's idea of lateral thinking, which turns complex situations into what seems like simple solutions. The problem with methods like

thinking wrong is that it focuses on the ideas rather than the validity of such ideas.

Every year, Project M holds a two-week session in Greensboro, Alabama ‘a mental gymnastics camp for young creatives who are already inspired to contribute to the greater good, but are looking for a platform to collaborate and generate ideas and projects bigger than themselves’ (Holden Baker, n.d.). Greensboro, nicknamed the ‘third world of Alabama’ by *the Birmingham News* (Edge, 2010), is a rural, poverty-stricken, African-American town, and perfect for designers interested in ‘doing good’. The programme is open by application, and young creatives are asked to supply a brief explanation of why they are interested in Project M, a 60-second video which should be ‘legendary’, and a portfolio featuring a body of work similar to Project M’s mission (Project M South, 2014). Here, we see that the application focuses entirely on the implementation of ideas rather than their validity. The programme costs \$2,000 USD excluding travel. Judging by the price tag, doing good is a very privileged affair.

The chosen group is invited to spend two weeks immersing themselves in a place – they are advised to meet 10 people, collect 10 stories, photograph, develop a project, and implement it. These ‘blitzes’ – intensive workshops ‘...for prototyping, researching, doing, designing, and exploring that, while thinking wrong, produces a project or service that uses design thinking for the greater good’ (Blitzes & Workshops, n.d.) – are treated like project briefs: reinforcing the idea of a client-based relationship, which forces students to think quickly. This is not a bad thing, but in order to solve larger problems – which are not solved through a ‘blitz’ – it is. Ethnography that is longer than a few hours (and outside a certain radius) just does not fit within the timeline.

Project M has developed a large portfolio since 2003, but by analysing their past activities and advertising material, one has a sense that it is a series of projects that the students themselves want to see including interactive street art projects such as murals, and outdoor chalk boards. The projects, documented via photographs, zines, and videos, express a sense of self-glorification, and having fun at camp.

The 10-minute ethnography

While I was a graduate student in a Social Design programme, we had to develop a project for a 48-hour ‘blitz’ organised by Project M. We were advised to go out and meet 10 people, collect 10 stories, develop a project, and implement it within 48 hours. We were divided into groups, asked to

choose a number between one and 300 and a number between one and ten, then turn to the page of the chosen number in a dictionary and look up the second word down. We then had to take that word and spend 30 minutes free-associating with it, creating a mind map. One project developed by my colleagues for this 'blitz' was a picnic table on wheels painted orange. The table was meant to promote dialogue and positive change by inviting people to have a cup of coffee. There was one problem however: no one in the neighbourhood came to the table because no one really drank coffee.

'Blitzes' are not short-term projects but experiences that satisfy the participants rather than the community. Project M does not necessarily focus on projects that have an afterlife, although they have created a few, which have developed into larger initiatives such as PieLab. As Fry (2007, p. 67) states '...good intentions do not necessarily lead to beneficial consequences. The immediate results of design actions are often not a good indicator of longer-term world-formative consequences'.

PieLab

PieLab, an initiative developed by Project M, has been successful through the creation of jobs and providing a space in Greensboro, although the project itself never had firm business plans or future goals – which according to Bielenberg, was intentional (Edge, 2010). He believed that setting something in motion and leaving the rest to momentum was the way to go (Edge, 2010). Places like Greensboro however do not need interventions, but concrete ideas with feasible plans to help the town grow.

PieLab became a community initiative run by local stakeholders only after an insensitive situation sparked the community to intervene. The incident in question is an example of how participants were completely unaware of their surroundings, designing things relevant only to them and for their amusement. While Project M participants were putting final touches on the new PieLab space, some of the participants created a poster with '...the words: 'Eat pie'', and beneath it, in smaller type, was 'Fuck Cake, Eat Pie' (Edge, 2010).

The community was not amused by the sloganeering, and so Project M's involvement in PieLab slowly dwindled, as the governmental programmes that funded the original members was not renewed, and changes to be more locally sensitive (including services and menu) were made.

Lacking Local

The lack of locality is another issue – particularly with independent projects. Design students and organisations are eager to look outside for socially engaged work, exploring opportunities in India or Kenya rather than in their own backyard. A look at past winners of the Design Ignites Change awards, an organisation that ‘supports creative professionals ... and students who use design thinking...to improve the lives of individuals and communities’ (About Design Ignites Change, 2014), shows an overwhelming number of projects targeting communities in Asia, Africa, and South America. Furthermore, even when designers look closer to home, they tend to focus on communities with the following criteria: run down, poor, and the furthest away from their own personal experience.

Urban LaunchPad (ULP) – whose focus is on smarter cities through data-driven field experiments – launched a project to create a map for Dhaka's bus system. While explicit transportation systems are helpful, and encouraging people to use buses has many benefits, each locality demands a specific approach. ULP's ideas are more commonly found in Western cities, where rapid public transportation networks are older and more established, and whose brands (e.g. London and New York) have become iconic. Cities like Doha and Cairo for example have a network of official buses, which are implicit: those who ride them know exactly where they are going, and are surprised by anyone questioning how they navigate the system. A more explicit transportation system might benefit a city like Doha, where expats represent 85 per cent of the population (Kinnimont, 2013), and it could be argued that many, if they knew how to navigate the system, would likely ride the bus. The same might not be true for Cairo however, where the buses are often associated with a certain social class and cases of sexual harassment (UN Women and the Demographic Center, 2013), and where the idea of making the system more explicit might not be the first issue to tackle. The question that should be posed is does the community need/want this?

A criticism of the Dhaka bus project is the methodology and the method used to raise funds for implementation. On the project's Kickstarter page, ULP wrote that the fieldwork in Dhaka is one of the risks, and that they are fortunate enough to be working ‘...with a local team that is familiar with these trials from a lifetime of experience and flexible enough to adapt as necessary’ (First Bus Map, 2013). The local team is gathering all the data and the necessary information, however, the American company is taking care of the overall project and implementation, i.e. the final result. This reduces the

local team's participation as just that: people on the ground rather than as equal partners in the process.

Furthermore, the project used Kickstarter for funding, which is currently open only to residents of the USA, Australia, United Kingdom, Canada, New Zealand, and the Netherlands. The team in Dhaka does not have access to the platform, keeping the funds solidly into the hands of the US design company. As Tunstall (2013, p. 238) states, such initiatives

'...transfer the resources of philanthropic foundations and local NGOs to Western design companies. The extent to which this places the initiative in direct competition with local design companies means that while its intentions may be good, its outcomes are likely imperialistic. It resembles what Linda Smith refers to as the new wave of imperialist processes that 'enter with goodwill in their front pocket and patents in their back pocket' (1999, p. 24). Thus ... [such] initiative[s] demonstrat[e] how even a design innovation project with good intentions can be implicated in continuing practices of imperialism'.

Corporate design thinking/doing good

The global creative saving the world has become a brand: who says that you can't shop and do good at the same time? Organisations like COMMON want 'to catalyze a global creative community with the tools, resources and opportunities to design positive social change; all done through the shared values of a collaborative brand' (COMMON, n.d.).

COMMON is attempting to prototype a new form of capitalism by connecting entrepreneurs, designers and creatives to accelerate socially beneficial businesses and ideas using the same power of rule-breaking innovation and thinking differently (such as one-for-one and donation of proceeds models). Unsettling about organisations like COMMON is how aware everyone else has to be about the act of 'doing good'. On their marketplace, visitors can buy a t-shirt that says 'Do shit that matters' which tells others this person is doing good, and that they should to.

The prevalence of 'design thinking' makes designers think society is gaining more respect for design, but in reality it has reduced design's contribution, since design thinking has become a process anyone can do. As design thinking becomes *de rigueur* in business and MBA programmes, design and designers become irrelevant to the process. At times, the 'design

thinker' is a businessman, armed with an MBA, and leading the process (Dupont, 2014).

With increased discussion of accountability, global corporations suddenly have social design branches, seamlessly flowing beside services like strategy, interactive, and branding. Corporations are adopting similar language to social design programmes, highlighting terms like 'collaboration', 'innovation', and providing fellowships. On his blog 'Design4Impact', Vice-President of Frog Robert Fabricant (2010) claims that Frog's work 'avoids the pitfalls of imperialism', declares that local partners are the 'lifeblood of collaborations' and that Frog counts on them to build trust within local communities. A multinational corporation with offices covering the 'global' market in Western Europe, the US, and China, Frog's social wing takes over from the local partners, imposing their 'expertise' and its hefty price tag.

This invasion of design thinking and 'doing good' by corporations has reduced knowledge in design thinking – and the social design discipline – to get rich quick like scheme, as demonstrated by the title of a blog post by Tim Brown, CEO and President of IDEO: 'How to Become a Social Innovator in 7 weeks'. The opening line of the post, just below a photograph of an IDEO employee showing smiling children in traditional clothing and dirty knees something on his tablet, reads:

'We say we practice human-centered design at IDEO, but what does that really mean? Our friends at +Acumen and IDEO.org have designed a free online course to answer that question. Open to anyone anywhere in the world—no prior design experience needed—the class is called 'Human-Centered Design for Social Innovation.' The goal is to teach budding social entrepreneurs how to develop solutions for those who live in such dire circumstances, they may not know where their next meal will come from' (Brown, 2014).

The seven-week team-based curriculum '...brought together over 13,000 people from 134 countries' (Brown, 2014). He continues, 'In about the time it takes to get a passport, you, too, can be introduced to a whole new way to approach the world's toughest challenges' (Brown, 2014). Unfortunately design thinking has become an exploration of opportunities for personal gain, and it's giving design a bad reputation. The word 'change' is thrown around loosely, defined by problems solved with a click of a button, walls covered with a rainbow of post-it notes, and by carrying a notebook. 'The motives of designers of good intent 'in the field' who act without having a

theoretically informed critique of development ... are not challenged' (Fry 2007, 67) – apparent in the Project M and IDEO model which bypasses crucial elements such as informed research and ethnography. Organisations such as COMMON, IDEO, and Project M – who all may be well intentioned and have produced some important projects and prototypes – trivialise design, making it appear merely as style to '...almost all other disciplinary fields of inquiry...' (Fry, 2008, p. 89).

Conclusion

Since social design is in its infancy, addressing the issues described in this paper is realisable in the short-term. I would like to conclude with a few proposals I feel are important for the growth of the field by drawing on the ideas of engagement and articulation from Irani et al. (2010) in their paper on postcolonial computing. Engagement is the idea of '...connecting with users or an application domain in order to understand relevant work or activity' (Irani et al., 2010, p. 1317), while articulation is the manner in which situations are seen and framed by designers (Irani et al., 2010). Although their paper addresses issues in human-computer interaction for development, it is focused on how designers interact with users in both academic and corporate contexts.

A definition/a job description

Like design, social design is not easily defined – '[d]oes the term denote activism in pursuit of social change, conducted through the medium of design? Or does it refer to activism intended to reform design itself? Or both?' (Lees-Maffei, 2012, p. 92). This confusion over the definition reduces social design to an extension of sub design fields. Designers working in the space need to acknowledge that interdisciplinarity and inviting non-designers into the equation means that in order for design to be '...recognised and taken as seriously as it should be' designers need to stop talking only amongst themselves (Fry, 2008, p. 89).

A clearer definition will help establish the field – particularly as more students graduate with degrees in social design and begin the job search. Social design has the opportunity to involve designers in the decision process. Currently, designers are called in for finishing touches, rather than being considered to participate in major decisions. Without further knowledge in fields that are directly implicated in the work they produce, this will continue to take place. Urban planning, education, migration, public

health, and affordable housing are some of the areas where social designers can be valuable assets. Governments, NGOs, policymakers, and decision-makers need to create roles for social designers that goes beyond aesthetics, but these opportunities will not be created unless social designers encourage a culture of criticism, validity, and examination, and an understanding of the issues and contexts they are immersed in.

Stress the Local

Locality and the translocal are, according to Petrescu, important because it isolates you and minimises your task (Mazé, 2011). Some institutions are committed to local initiatives and the community where they are based, but often organisations look outward. In discussing the difficulties of being socially engaged, Mattsson and Zetterlund claim it requires 'a great knowledge plus massive and very long-term commitment. Otherwise, it is easy for this engagement to have an 'us' and a 'them', in which 'they' are more or less invisible in the process, which is defined by 'us'' (Ericson, 2011, p. 54).

Insights from postcolonial studies and STS studies are encouraged as they speak to local practices, '...while at the same time recognizing the ways that those localisms are conditioned and embedded within global and historical flows of material, people, capital, knowledge, and technology' (Irani et al., 2010, p. 1316).

In being more locally-centric, Irani et al.'s (2010) 'engagement' is applicable. Engagement encourages design research, feedback, deployment, and maintenance. It reframes the project to one that is mutual – '...acknowledg[ing] users as active participants and partners rather than as passive repositories of 'lore' to be mined' (Irani et al., 2010, p. 1318). Mutual engagement can remove the 'us' and 'them' factor if designers make the effort to understand various social, economic, and political issues relevant to the place, exhibit an attention to research, a knowledge of local values and customs, and most importantly to stop thinking of the community in which they are working in as passive recipients but rather as collaborators.

Publishing Findings and Research

Social design projects should not have the aim of winning prizes and awards. Due to the lack of critique in design, they go on to collect their awards without being questioned. What's more, zines used to document social design projects are an exercise in self-congratulation: acting more as minuscule monographs that prioritise photographs of people having a good

time and slogans over publishing findings from the project. Without proper findings and research, particularly in a field that is user centred, we are unable to determine the value of such projects, nor are we able to measure its impact and what lessons can be taken from it. As social design settles within academia, projects need to be more than just about having a good time helping people – ‘Design is both a social process, with implications for others who are participants to that process, and also brings something new into the world that may have social force’ (Polaine, 2013).

Do not make social design trendy

‘It is not about being hip or cool, nor is it about being seen as creative or being a problem-solver. It is not about the objects and images associated with one’s name nor about having articles written about oneself in glossy magazines. Rather it is about something profoundly unfashionable. It’s about being serious’ (Fry, 2008, p. 12).

The direction which social design is taking is turning it into something trendy. Designers should not think of what they personally would like to see in that community or of the awards, but by articulating the requirements of the individuals or community they are working in based on their needs, opportunities, wants, constraints, and desires (Irani et al., p. 2010), an the life of the project.

References

- Anon (2014) About [online]. Available from:
<http://designigniteschange.org/pages/2-about> [Accessed 29 April 2014].
- Anon (n.d.) Blitzes & Workshops [online]. Available from:
<http://www.projectmlab.com/Blitzes-Workshops> [Accessed 17 May 2014].
- Anon (n.d.) Common [online]. Available from:
<http://fearlessrevolution.com/common> [Accessed 4 May 2014].
- Anon (n.d.) Project M [online]. Available from:
<http://www.projectmlab.com/Project-M> [Accessed 5 May 2014].
- Anon (2013) Study on Ways and Methods to Eliminate Sexual Harassment in Egypt. [online]. Available from:
http://www.dgvn.de/fileadmin/user_upload/DOKUMENTE/English_Documents/Sexual-Harassment-Study-Egypt-Final-EN.pdf [Accessed 26 March 2014].

- Brown, T. (2014) How to Become a Social Innovator in 7 Weeks. Design Thinking: Thoughts by Tim Brown [online]. Available from: <http://designthinking.ideo.com/?p=1324> [Accessed 4 May 2014].
- Dupont, M. (2014) Design Thinking is not Design. Design Research Portal – #DRP [online]. Available from: <http://designresearchportal.wordpress.com/2014/05/01/design-thinking-is-not-design-2/> [Accessed 3 May 2014].
- Edge, J. (2010) Pie + Design = Change. *The New York Times Magazine*, October 8, 2010, p. MM58.
- Ericson, M. (2011a) *Historical Perspectives, an interview with Helena Mattsson and Christina Zetterlund*. In Mazé, R. and Ericson, M. (eds.), *Design Act: Socially and Politically Engaged Design Today: Critical Roles and Emerging Tactics*. Stockholm: Iaspis.
- Ericson, M. (2011b) *Interview with Ou Ning*. In Mazé, R. and Ericson, M. (eds.), *Design Act: Socially and Politically Engaged Design Today: Critical Roles and Emerging Tactics*. Stockholm: Iaspis.
- Fabricant, R. (2014) In Defense of Design Imperialism. Design4Impact: Creativity and the business of social innovation. [online]. Available from: <http://designmind.frogdesign.com/blog/in-defense-of-design-imperialism.html> [Accessed 3 May 2014].
- Fry, T. (2007) Design, development and questions of direction. *Design Philosophy Papers*, 3(4), 66-79.
- Fry, T. (2008) *Design, Ethics and Identity*. In Willis, A.M. (eds.), *Design Philosophy Papers Collection*. Ravensbourne, Australia: Team D/E/S Publications.
- Hall, S. (2001) *Museums of Modern Art and the End of History*. In Hall, S. and Maharaj, S. (eds.), *Annotations: Modernity and Difference No. 6*. London: Institute of International Visual Arts.
- Holden Baker, C. (n.d.) Thinking Wrong. Maine [online]. Available from: <http://themainemag.com/people/features/1202-thinking-wrong.html> (Accessed 17 May 2014). [online].
- Irani, L., Vertesi, J., Dourish, P., Kavita, P., and Grinter, R. (2010) *Postcolonial computing: a lens on design and development*. Paper presented at the CHI '10 SIGCHI Conference on Human Factors in Computing Systems, Atlanta, Georgia.
- Kinninmont, J. (2013) Qatar's delicate balancing act. *BBC News*. [Online]. Available from: <http://www.bbc.co.uk/news/world-middle-east-21029018>. [Accessed: 20th April 2014].

- Lees-Maffei, G. (2012) Reflections on Design Activism and Social Change: Design History Society Annual Conference, September 7–10, 2011, Barcelona. *Design Issues*. 28 (2), 90–92.
- Markussen, T. (2013) The Disruptive Aesthetics of Design Activism: Enacting Design Between Art and Politics. *Design Issues*, 29 (1), 38-50.
- Mazé, R. (2011) *Reflections on Practice, an interview with Doina Petrescu*. In Mazé, R. and Ericson, M. (eds.), *Design Act: Socially and Politically Engaged Design Today: Critical Roles and Emerging Tactics*. Stockholm: Iaspis.
- Pines, A. (2011) *All Design is Social Design*. Unpublished essay.
- Polaine, A. (2011) Design Research and Education: A Failure of Imagination? *Core77*. [online]. Available from: http://www.core77.com/blog/columns/design_research_and_education_a_failure_of_imagination_20623.asp [Accessed: 30th March 2013].
- Project M (2014) *Project M South 2014*. [online]. Available from: http://files.projectmlab.com/ProjectM_South2014_App.pdf [Accessed 5 May 2014].
- Staples, L. (2002) *On FTF*. In Bierut, M., Drenttel, W. and Heller S. (eds.), *Looking Closer Four: Critical Writings on Graphic Design*. 4th edition. New York, NY: Allworth Press.
- Tunstall, E. (2013) *Decolonizing Design Innovation: Design Anthropology, Critical Anthropology, and Indigenous Knowledge*. In Gunn, W., Ton, O. and Smith, R. C. (eds.) *Design Anthropology: Theory and Practice*. London: Berg.
- Urban LaunchPad (2013) *First Bus Map of Dhaka*. [online]. Available from: <https://www.kickstarter.com/projects/urbanlaunchpad/first-bus-map-of-dhaka> [Accessed 4 May 2014].



Exploring Model Making: Translating Intuitive Aspects Of Conceptual Models Into Digital Realm

Elif AKTAŞ*

Istanbul Technical University

In recent years, digital design tools have expanded the overall vision of design with uses such as digital manufacturing, modeling, animating, rendering and programming. Still, they are insufficient in assisting designers during the early phases of the design process. Conventional methods such as sketching and physical modeling are still the most effective and commonly used tools for conceptual design both in education and practice. It is mostly due to the challenges designers and tool developers face in attempts to digitally represent intuitive movements of the physical processes. Concerning that, this paper addresses the problems that are revealed while trying to translate the dynamic and intuitive features of the physical conceptual models to the digital platform. In order to identify the key features that are required to transfer to the digital media, both digital and physical model-making processes are explored through various experiments. The physical processes are investigated as dynamic representations where the modeled object is constantly evolving via instant and quick handmade models, namely, conceptual draft models. The potential advantages and deficiencies of current digital tools that are used for representing these models are analyzed through digital experiments. In consequence of the experiments, a general framework, which will lead to construct a methodology for the representation of conceptual draft models in digital medium, is proposed.

Keywords: *Conceptual thinking; conceptual draft models; abstraction; physical modeling; digital modeling*

Introduction

Any design process in architecture is lead by the architect with the help of several tools, which are composed of representational techniques such as

* Corresponding authors: Elif Aktaş | e-mail: aktaaselif@gmail.com

drawing, painting, collage, photography, and modeling. These tools are significant because they are the media that externalizes the designer's intent, idea, and thought process. Each architect prefers to design with different tools, those that they are more comfortable with. The representational techniques expose the dominant movements in architecture. According to Carpo (2001) transmission of the architectural knowledge and the mode of architectural thinking are directly related to the representational media, which is used in any given historical period. Today, highly developed digital technologies promote digital representational techniques. The designer is pushed to work more and more in the digital media, which is now a competitive factor. It is a fact that the digital media have brought many opportunities and possibilities to design theory and practice. Notwithstanding, they are still not effective in the conceptual phase of the design process where the initial idea originates and gets developed.

Two-dimensional representations, especially architectural drawing and sketching, have conventionally been of great interest in the conceptual design development of early phases. In contrast, even though 'models have been used for over 500 years as an important method of communication in the understanding of architecture' (Dunn, 2010, p. 18), there is a minor focus on the architectural model making process for the same purposes. As Knoll and Hechinger state 'Just like a drawing, a model is an expression of the thought behind a design' (1992, p. 8). Within the context of this research, conceptual models are explored as a mode of thinking tool rather than as a representational medium that functions to represent a finalized design work.

In the early phases of the design process, conceptual models function as three-dimensional sketches. Porter and Neale (2000) describe conceptual models as an 'embryonic sketch in three dimensions which is used to examine 'newly forming ideas directly in the space of the idea'(p. 21). Gürsoy and Ozkar (2010) recently investigated the model making process as a form of sketching and its contribution to the early design process. Dunn (2010) points out that experimentation with materials, especially at early stages of the design process helps to develop design ideas. Studies that are conducted among practicing product and engineering designers reveal that a notable amount of projects start with sketches and physical models (Wiegers and Vergeest, 2001; Scali et al., 2002). Yet, today there is a strong shift towards digital modeling instead. However, current digital tools used in architecture are inadequate to represent conceptual processes. With

regards to this problem, this paper investigates the conceptual model making process and addresses the problems that are revealed while translating the dynamic and intuitive features of conceptual models into the digital platform.

Conceptual Thinking and Intuition in Design

When dealing with concrete problems in design, digital space might help us alter, simulate, integrate or connect data from the physical world in various ways, thus providing a more efficient environment for conceptualizing ideas. In *The Sciences of the Artificial* Simon (1996, p. 6) defines artificial as an interface where 'the inner environment of the substance and organization of the artifact itself' and the 'outer environment, the surroundings in which artifact operates' intersect. 'Whether a clock will in fact tell time depends on its internal construction and where it is placed' (Simon, 1996, p. 6). Similarly, architecture is a superimposition of extrinsic and intrinsic parameters. The occurrence of an artifact depends on the environment where it is placed and who designs it. For architecture, extrinsic parameters are related to site, landscape, social and cultural data as long as these are calculable in some way. However, compared to extrinsic parameters, intrinsic parameters have incommensurable values such as designer's own experiences, cognitive capacities and design skills. These parameters, incidentally, mostly shape the early design process.

Essentially, intrinsic parameters are linked to intuitive processes. Intuition plays an important role in the early phase of the design. Harbort (1997) asserts that in the practice-oriented disciplines, intuitive thinking focuses on the general aspect of the problem and do not investigate the problem in a detailed manner. Similarly, in the conceptual phase of the design, the designer focuses on the basic problems of the design and relies on his/her intuitions. Intuitively guided motions such as hand gestures, mimics and manipulations are mostly derived from intentions and experiences of the designer (Boucoulalas, 1997). Quickly produced physical draft models help to link designer's thoughts with actions and allow making instant decisions. During the model making process, the designer constructs a direct relationship between his/her thoughts and the modeled object. Therefore, in the early phase of the design process these models can be considered as the representation of the architect's inner environment. As regards, the research is carried through conceptual draft models, which is

basically refers to quick handmade abstract models that are produced in the early phase of the design process.

Investigating Conceptual Draft Models

In order to explore different aspects of conceptual model-making process that designers utilize for developing their design ideas, a pilot study was conducted with three interior designers. Conceptual models are examined as dynamic representation within a specific context and named conceptual draft models. Essentially, within the context of this research, conceptual draft model refers to early abstract models that are quickly made to embody and develop designer's initial ideas with easily accessible materials. The pilot study presents an empirical research about the different aspects of conceptual model-making process through conceptual draft models.

Method

As pilot study three protocols are performed by three interior designers who study double major in architecture. A short interview is made with participants in order to figure out their interest for the subject. These participants are chosen because they regularly use physical models as an effective design tool in their own projects. Experiments are recorded by a video camera and participants are asked to verbalize their thoughts while designing. The same design task is given to all participants. They are asked to design an exhibition unit for the entrance of the faculty of architecture. Same materials are provided to all participants such as cardboard, colored papers, transparent papers, mesh materials, needles, glue, and rulers. The experiments are held in a studio environment, where the participants take their regular design courses.

Limitations











It should be noted that there are many limitations of the protocol analysis that inhibits to make a general inference for the conceptual model-making process. Firstly, experiments were conducted with a limited number of participants within a limited period of time. Additionally, participants were restricted with certain environment and materials. If the experiment were performed by using different materials in a different environment, the result could be different. Lastly, protocol studies are criticized for being unnatural due to the fact that participants are forced to design and verbalize

their thoughts while they are filmed (Gürsoy and Ozkar, 2010). It is observed that during the protocols occasionally participants hesitated to explain each thought and action. Accordingly, being aware of its limitations, the pilot study presents these protocol studies as an example of how designer benefits from conceptual draft models as an early design tool for developing their design ideas.

The Protocol Studies

Each of the three participants developed a design idea for the same design task through conceptual draft models and using similar materials. Participants will be named respectively D1, D2 and D3 throughout the report of the protocols. In total 8 different models are built in the protocols. The duration of protocols varies for each participant between 15 and 20 minutes. Table 1 shows the design protocols of the participants including process, actions, duration and final design models that are produced.

Table 1 *Design Protocols.*

Designer	Design Protocols		
	Model 1	Model 2	Model 3
D1			
Sections of process			
Duration	7 min	5 min.	3 min.
Actions	Bending - Twisting - Cutting Rotating - Pining - Pasting	Bending - Cutting - Rotating Pining	Bending - Folding - Cutting Rotating - Pining
D2			/
Sections from the process			
Duration	5 min.	13 min.	
Actions	Bending - Twisting - Cutting Rotating - Pining - Pasting	Bending - Twisting- Folding Cutting -Rotating - Pining -Pasting	
D3			
Sections of process			
Duration	5 min	4 min.	10 min.
Actions	Cutting - Rotating- Squeezing Pining	Cutting - Rotating- Twisting Pining	Drawing - Cutting - Rotating- Twisting - Pining

Observations and Discussion of Protocol Studies

In the protocols, all participants conceptualized their ideas via quickly produced early conceptual models. During the protocols the designers used conceptual draft models as a mode of thinking tool to construct and develop their initial design ideas. In the beginning their design ideas were more ambiguous. After a while, they started to express their thoughts more clearly.

The protocols show that all the participants benefited from the different aspect of the model making process. D1 produced three different models to explore different compositions and design alternatives for the same design idea. D2 produced two different models and detailed the initial design idea through them. D3 used models for expressing her design idea with different methods and materials so to explore how the design differentiates accordingly. D2 and D3 spent approximately twofold more time to build their second model than the initial one. However, D1 spent less time for the following two models than the initial one. Table 2 summarizes the different aspects of model making that participants were utilized during the protocols.

Table 2 Design Protocols.

Intended Purpose of Model-Making	D1	D2	D3
To embody design idea	●	●	●
To develop design idea	●	●	●
To communicate	●	●	●
To explore design alternatives	●		
To elaborate design idea		●	
To explore different materials			●
To explore structural problems		●	●
To perceive space and scale			●

The pilot study shows that there is a dynamic relationship between the models. For example in D1's protocol the arc shaped form in the left side of three models represent an entrance for the visitors of the exhibition. It can be observed that the form of the entrance differentiates in each model while its function remains stable (figure 1).

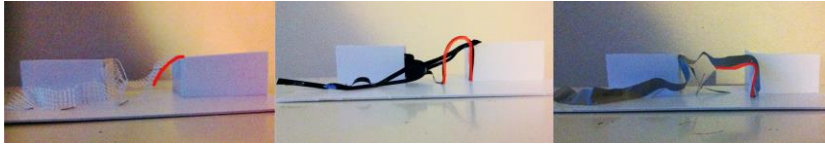


Figure 1 Dynamic relationship between models. Red lines indicate how the shapes transform constantly.

This dynamic relationship between models resembles the sketching process. During the model making process, lateral transformation occurs beside the vertical transformations. Later transformations refer to movement where the idea shifted towards a different one and vertical transformations indicates more detailed version of the same idea (Goel, 1996). For example, the function of the exhibition surface differentiates in parallel to changes in its form in the protocol of D1 (figure 2).

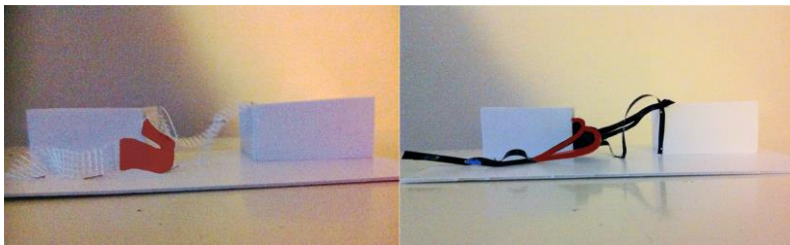


Figure 2 lateral transformations between models.

To sum up, conceptual draft models are abstract representations, which reduce the complexity of the problem. Being ambiguous is one of the strongest parts of conceptual draft models that enhance creativity. Another strong aspect of conceptual draft model is that they represent diverse ideas with simple forms and materials. They generally convey multiple meaning with a simple representation. In general, they convey deeper implications for its maker than its observer. They do not imply one clear meaning.

Therefore, they are open to different possibilities and enrich the design process.

Consequently, based on the observations of the pilot study, it can be claimed that in the early phase of the design process conceptual draft models operate as an effective design tool, which assist designers.

Exploring the Translation Process From Physical To Digital

The core analysis of the study is carried out through the author's own design practice. In order to identify the key features that are required to transfer into digital media, both digital and physical model-making processes are explored through various experiments by the author. The method applied is Practice-Led research in literature (Frayling, 1993; Rust et al., 2007; Pedgley, 2007; Mäkelä and Nimkulrat, 2011). The main motivation of the research is to develop the knowledge that is acquired from both the digital and physical experiments.

The physical processes are investigated as dynamic representations where the modeled object is constantly evolving via conceptual draft models. Each model-making process is regenerated in a digital environment in order to analyze potential advantages and deficiencies of current digital tools for representing conceptual processes. As a digital medium, Rhinoceros was chosen for its modeling capability over nonlinear forms.

The Practice-Led Design Research

Design problems are always controversial. Rowe (1987) identifies design problems as *wicked*, which means they have no definite formulation and solution. In design practice, results do not need to be repeated or copied as it happens in science (Cross, 2001). Thus, in most cases, the process is more important than the result. According to Cross 'underlying patterns of how designers think and act' or in other words 'designerly ways of knowing' lies in the process of making artifacts. Cross claims that, in order to develop design as an independent discipline, rather than a subcategory of science, these underlying patterns - namely intrinsic values of design - should be a valid study subject.

This study investigates one of the intrinsic values of design through model-making practice. In order to explore translation process of intuitive aspects of conceptual model making process, the author investigated her own design practice and documented it. The exploration method is known as 'practice-led' design research or 'research through design' which fundamentally involves capturing and analyzing researcher own design activity to achieve the stated research aims and objectives (Pedgley, 2007). Based on Herbert Read's education model, in 1993 Frayling distinguished *research through practice* from *research for practice* and *research into practice*. According to Frayling (1993) the practice itself as a research method allow the result/artifact to be communicable rather than being a

visual documentary. Commonly, it is preferred in the design and art based studies where the new research culture is being developed (Pedgley, 2007).

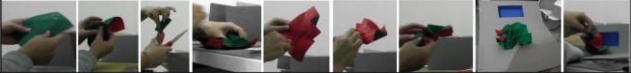
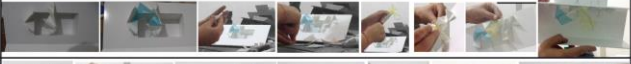


One of the defining characteristics of practice-led research is that one could discover unusual territories by self-documenting and analyzing his/her own design process. Mäkelä and Nimkulrat (2011) assert that exploration of the knowledge through the documentation, interpretation and contextualization of process of making artifacts has brought a new dimension to the design research. The main motivation of the practice-led research is acquiring new knowledge about the nature of the practice and search for the solution to improve it.

Data collection was made by video-recordings. In order to capture intentions and intuitive action during the process, the designer also explained her thoughts verbally. The process is also documented by written reports and diagrams. Since the method is based on a self-analyzing process, the transparency of the documentation is prioritized. The author, who conducts both the research and experiments, will be referred as the designer throughout the report of the experimental inquiry.

Physical Experiments

In the first phase of the exploration, physical model making process is examined through experiments. The designer used basic modeling materials similar to pilot study in each experiment. As a design task, a lightening installation for a gallery entrance is chosen. Four conceptual draft models were produced by the designer for the given task. The duration of each experiment varies between 12 and 40 minutes. Experiments are respectively named pE1, pE2, pE3 and pE4 regarding the construction sequence. Table 3 demonstrates the duration of each experiment along with particular sections from the design process.

Table 3

Experiments	Process	Duration
pE1		12 min
pE2		30 min
pE3		20 min
pE4		40 min

The physical experiments are analyzed on the base of their modeling approach and of the main actions that are used during the model making process. Modeling approaches are examined under two groups named top-down and bottom-up modeling. Top-down refers to processes where the design generates from whole to part. Top-down processes evolve with the manipulation of the whole surfaces or objects. For example, the model of pE1 shows a planar object (paper) being transformed into a continuous three-dimensional object (figure 3). Bottom-up refers to the opposite process, where the design generates from part to whole. Bottom-up processes evolve with the composition of smaller design components. For instance, the model of pE2 is created with bottom-up modelling approach (figure 4).



Figure 3 Final conceptual draft model of pE1.



Figure 4 Final conceptual draft model of pE2.

Actions that are constantly applied to materials during the modeling process are also examined into three groups regarding the dominant action in each process. Folding, bending and twisting actions, which lead the experiments are grouped as main actions. Actions such as cutting, rotating and pasting, which are used in all experiments are considered as general actions. Table 4 demonstrates the modeling approach and main actions that are used in each experiment. During the translation process of physical experiments into the digital, the modeling approaches and the actions will be respected. Digital experiments will be evaluated accordingly.

Table 4 Modelling approaches and main actions of physical experiments.

		Main Actions	pE1	pE2	pE3	pE4
Modeling Approach	Top Down	Folding	●			●
		Bending			●	●
		Twisting			●	
	Bottom Up	Folding		●		
		Bending				
		Twisting				

Digital Experiments

The physical experiments were tried to regenerate in the digital media in order to observe main differences between the digital and physical modeling process. The experiments are respectively digital attempts of physical experiments and named as dE1, dE2, dE3 and dE4.

Since the study focus on the model-making process, the digital models were regenerated using the same modeling approaches and actions that were practiced in the physical experiments. Therefore, each experiment is evaluated with respect to the properties defined in Table 4. The difficulties emerged during the translation process are reported in the paragraph describing each main actions, which are folding, bending and twisting. Digital equivalences of physical actions are also demonstrated in Table 5.

Table 5 Digital equivalences of physical actions in Rhino.

Physical Actions	Physical Experiments				Digital Experiments				Digital Actions
	pE1	pE2	pE3	pE4	dE1	dE2	dE3	dE4	
Fold	•	•		•	•	•			Foldface
					•	•		•	Manipulating Control Points
Rotate	•	•	•	•	•	•	•	•	Rotate
Paste	•	•	•	•	•	•	•	•	Move/Join
Cut	•	•	•	•		•	•	•	Extract Surface
					•				Split Face/Surface
Bending			•	•			•	•	Bend
Twisting			•				•		Twist
Squeezing				•					None

Folding

Folding action was the main action of pE1, pE2, and pE4. The designer tried two different methods to simulate folding action. In the first method, the surface was created with mesh parallelograms. Each parallelogram was created individually and manipulated through its control points (figure 5). However, due to the fact that the edges of the surfaces and control points are not attached to each other with certain parameters, the boundaries of the surface were calculated manually, besides the manipulation done by mouse click for each control point. Therefore, it was a time-consuming

process and did not give the desired result. As a result, the method was able to fold the surface but ineffective in simulating the folding action in pE1.

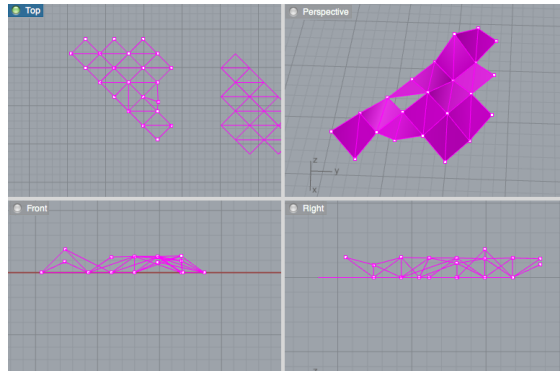


Figure 5 Folding actions by manipulating the control points in pE1.

In the second method, the designer directly benefit from the foldface command in Rhino. The command basically rotates selected polysurface face around an axis line. It includes three steps: selecting the face to be fold, defining the folding axis and angle. It is possible to fold a surface with the given direction and angle using this command (figure 6). However after each folding action, the folded surface is defined mathematically by the program as a new surface. Accordingly, the surface loses its integrity and the program does not allow folding the initial surface again on a different axis. Consequently, the folding action in the physical environment is modelled digitally at a certain degree using foldface command.

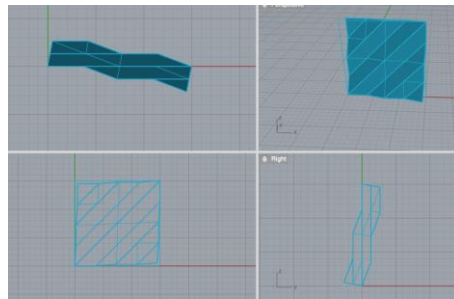


Figure 6 Folding actions by foldface command in pE1.

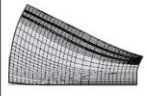










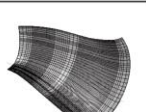


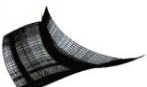


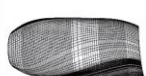
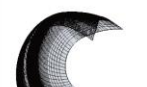
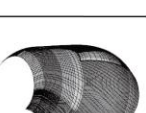
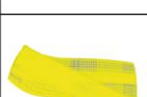

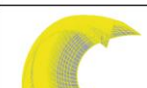

In the experiments dE1 and dE3, folding action is simulated by control points while in dE2 both methods were used. However, both manipulating control points and using foldface command was inadequate in fully representing folding actions in the physical experiments.

Bending

Bending action was one of the main actions in pE3 and pE4. The designer benefited from the *bend* command in Rhino in order to simulate bending action digitally. The command allows bending the surface towards the chosen direction, around the given axis. The bending axis and its direction are defined by the user. The boundaries are geometrically redefined over a circle according to the bending degree. The command simulates the physical bending under two circumstances. First one is that bending direction should be given within the surface boundaries. Secondly, the *ortho* command, which restricts the marker movement to points at multiples of a specified angle, should be on. Otherwise, the shape loses its initial size and unwanted deformations occur.

Since the command is easy to control within the limitations of given descriptions the model-making process of pE3, regenerated at a particular degree by the designer via bend command. Table 5 shows the bending process of dE3 via bend command.

Table 5 *Bending process in Rhino.*

Bending steps	Top View	Front View	Side View	Perspective
1st				
2nd				
3rd				
4th				
5th				
6th				

The bend command is also applied in dE4 to create structural span model. First the digital surface was positioned by the control points manually considering how they are positioned in the hand model, and after the bend command is applied. Figure 7 demonstrates the bending action in dE4.

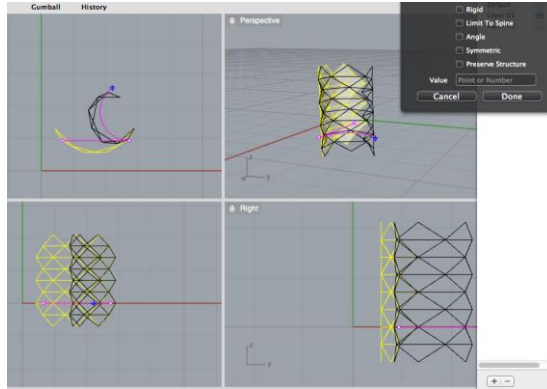


Figure 7 Bending actions by bend command in dE4.

Twisting

Twisting action is explored digitally in dE3, since it is the main action of only pE3. Even though the digital bending process was successful in dE3, the command was not able to create continuous curvature in different directions at the same time. Thus, twist command was applied to surface in the next step to get results that represent the physical process of pE3 in a more straightforward manner.

Twist command deforms objects by rotating them around the given axis. The axis and rotation angle are assigned by the user. The rotation axis is defined between two selected points. According to draw order the shape deforms differently. While the closest part to the first selected point is fully twisted, the farthest part from it keeps its original orientation.

Consequently, the result was not identical but similar to the physical process after several application of the twist command.

Discussions

Despite the fact that very similar results are achieved in digital experiments, the physical process could not be represented exactly due to several reasons. Firstly, even if the rules are well defined, it was still hard to control the processes. For example, unlike the *foldface* command, bend and twist commands identify the surface as a whole after each manipulation.

Even though bending and rotating axes define the area that will be affected, both the commands deform the whole surface at a certain degree.

Therefore, some specific curvatures could not be modeled. Indeed, in the physical modeling process, the bending process of the surface was

controlled more effectively by hand movements. For example, while bending some part of the mesh with one hand, it is possible to keep another part fixed with the other hand or bend it in another direction. Forces affect the surfaces within the limitation of command in the digital processes. It is not possible to control forces over the surface as deemed without setting a different parametric model.

Another restriction of the medium is that the coordination between the commands and mouse click is not easy to control. The reflection is very low compared to the physical process. Even the simplest rotating action, changing the position of the components recurrently take notable time. For instance, in the bending process the bending curves decreases the radius of the circle, which determines the increase of the bending degree, and after a certain point it does not fit into the screen. Even if the user zooms out and repeats the process, this does not provide a proper view to observe the changes over the form. That restriction leads the user to make another try with more curved axis. At that point, the user is excluded from the process by being restricted with the capability of the program. The more the user encounters this kind of restrictions during the modeling process, the more the decision-maker role of him/her shifts to 'decision-made-r'. Ultimately, the interaction between medium and user is important as much as the software's capability of applying commands.

Conclusions and Further Discussion

The digital medium comes with its own technique, culture and way of thinking. Therefore, while working in the digital realm unconsciously or consciously, we operate within its limitations. It is an undeniable fact that there is a rapid shift towards digitalization in architecture. It is believed that this rapidly increasing tendency towards digital affects the conceptual thinking in architecture due to the fact that digital tools are still not suited to architecture as an efficient design tool. Concerning the importance of the conceptual models in the design process and the rapid shift into digitalization, this paper denotes the dearth of such a digital design tool and seeks for the solution.

As a conclusion of the experiments, four different challenges are identified.

The first challenge is the modeling approach of the digital medium. Physical processes always start with a given material. It is up to the designer to decide whether to construct models with the 'bottom up' or 'top down'

approach. However, digital medium imposes modeling with components. Instead of opening with an empty screen, conceptual digital model should propose alternative modeling space to user. The interface of the medium needs to be designed in a specific way that helps to promote different ideas.

The second challenge is related to the description of the shape. Since Rhino is designed for parametric design and digital manufacturing purposes, the shape definitions are accordingly based on mathematical descriptions. However, real definition of shape in the physical world is different from its mathematical description. For example, a physical shape is never infinite in the space like the digital representation of it. A decent shape definition is crucial in order to represent physical actions and deformation of the shapes in the digital platform.

The third challenge is the representation of the material properties. Even though most of them are made with very basic materials such as cardboard, acetate, and styrofoam, material properties have an essential role in the conceptual model-making process. For example, if in the pE3 the designer had chosen a different material (modeling clay instead of metal mesh), the result would have been completely different. However, digital processes are not affected by the material properties. As it is observed from both protocol studies and author's own experiences, intrinsic properties such as elasticity, hardness and smoothness affect the design process while working with physical models. Besides, extrinsic properties such as transparency, color and texture have an effect on the conceptual model-making process. Different compositions and visualizations provoke different thinking and strongly impulsive creativity (Dunn, 2010). Consequently, rather than representing the actual properties of the material, a digital conceptual model is expected to reflect certain material properties that consists of fundamental intrinsic and extrinsic properties of the material.

The last and most challenging aspect of the physical modelling that need to be transferred into the digital platform is actual tangibility. Handling the material connects the designer with the actual world and augments the visual perception. Although digital models enable three-dimensional working space, they are literally bound in two-dimensional flat computer screens. The digital modelling media provide only indirect relation with the modelled object via mouse or touchscreen. On the other hand, actual tangibility provides more control over the form. Thus, physical models are manipulated easier and enable instant decision-making. As regards, integration of the more developed interactive systems such as touch screens, tangible smart surfaces, motion and capturing cameras to the

current digital models is significant to bridge the gap between the physical and digital existence.

For the future of this study, experiments can be done with different participants specifying well-defined set of constraints for the definition of the shape. Moreover, it would be possible to test the integration of the interactive systems to the current digital tool by a participatory workshop. The technological developments in the augmented graphical interface, smart objects and similar research that are related to the subject ought to be analyzed thoroughly for the adaptation. An integrated approach with technology and design cognition can solve the problematic aspect of the digital representation of conceptual processes in design.

References

- Boucoulvas, M. (1995) *The Concept and the Experiment*. In Goel, V. (eds.), *Sketches of Thought*. Cambridge: MIT Press.
- Carmo, M. (2001) *Architecture in the Age of Printing: Orality, Writing, Typography, and Printed Images in the History of Architectural Theory*. Cambridge: MIT Press.
- Cross, N. (2001) Designerly ways of knowing: design discipline versus design science. *Design Issues*, 17 (3), 49–55.
- Dunn, N. (2010) *Architectural Model Making*. London: Laurence King Publishing.
- Frayling, C. (1993) Research in Art and Design. *Royal College of Art Research Papers*, 1 (1), 1-5.
- Goel, V. (1995) *Sketches of Thought*. Cambridge: MIT Press.
- Gürsoy, B. and ve Özkur, M. (2010) *Is Model-Making Sketching in Design?*. Paper presented at the Proceedings Of the International Conference Design & Complexity 2010, Design Research Society, Université de Montréal.
- Harbort, B. (1995) *Thought, Action, and Intuition in Practice-Oriented Disciplines*. In Goel, V. (eds.), *Sketches of Thought*. Cambridge: MIT Press.
- Knoll, W. and Hechinger, M. (1992) *Architectural Models: Construction Techniques*. J. Ross Publishing: USA.
- Mäkelä, M. and Nimkulrat, N. (2011) *Reflection And Documentation in Practice-Led Design Research*. Paper presented at the Proceedings Of Making Design Matter Conference, Aalto University.
- Porter, T. and Neale, J. (2000) *Architectural Supermodels: Physical Design Simulation*. Oxford: Architectural Press.

- Scali, S., Shillito, A.M. and Wright, M. (2002) Thinking in space: concept physical models and the call for new digital tools. *Crafts in the 20th Century*. Tacitus Research Project: Edinburgh College of Art
- Pedgley, O. (2007) Capturing And Analysing Own Design Activity. *Design Studies*, 28 (5), pp. 463-483.
- Rowe, P.G. (1987) *Design Thinking*. Cambridge: MIT Press.
- Rust, C., Mottram, J. and Till, J. (2007) *Review of practice-led research in art, design & architecture*. Arts and Humanities Research Council: UK.
- Simon, H.A. (1969) *The Sciences of the Artificial*. Cambridge: MIT Press.

L'immaginazione ludica, un sapere incarnato nella materia

Francesca ANTONACCI*

Università degli studi di Milano-Bicocca

Il paper si propone di connettere la produzione artistica e il design alla dimensione immaginativa. Quest'ultima però non deve essere intesa solo come fantasia, ma dovrebbe essere accolta come facoltà di comprendere la realtà attraverso le immagini. Bachelard ha insegnato che non è solo l'uomo a produrre immagini, ma che esse scaturiscono dalla materia e dalle sue forze. In questo modo si postula un doppio movimento: del mondo verso l'uomo, quando la materia penetra nell'organicità immaginativa umana e dell'uomo verso il mondo, quando egli trasforma la materia in arte. Nel paper introduco il concetto di immaginazione ludica, una funzione che consente di vedere oltre la letteralità degli oggetti per riconoscerne le possibilità inesprese. Tale facoltà è appannaggio del giocatore, che valorizza la tensione tra regola e libertà, la vertigine dell'aleatorietà, l'ebbrezza della competizione. L'immaginazione ludica deve essere educata perché possa esprimersi con padronanza, a tal fine è necessario comprendere come si possano coniugare la creatività e la tecnica per esercitare nel mondo una tensione rivoluzionaria. Essa consente di cambiare il valore d'uso degli oggetti, di trasformare il senso delle dinamiche e delle relazioni, grazie alla potenza trasformatrice e al tempo stesso giocosa del linguaggio simbolico e dello sguardo poetico.

Keywords: Immaginazione; gioco; arti performative; educazione; linguaggio simbolico

Introduzione

L'obiettivo di questo paper è di connettere il design alle pratiche immaginative. L'immaginazione tuttavia non deve essere intesa solo come creatività e fantasia, non deve essere ridotta a una sola delle sue forme, forse la più superficiale, ma dovrebbe essere accolta come facoltà di ricevere e trasformare le immagini e di comprendere attraverso le immagini.

* Corresponding authors: **Francesca Antonacci** | e-mail: francesca.antonacci@unimib.it

Avvertendo la possibilità di educare questa facoltà umana poco considerata, ho approfondito il pensiero di autori che intorno alla capacità immaginante hanno articolato un sapere organico e complesso, capace di conferire valore e dignità scientifica al pensiero poetante e immaginativo, al pari di quello che si esercita nelle scienze naturali e cognitive. In questa direzione uno studio della produzione immaginante, quale capacità cui il designer attinge per la sua creazione, può definirsi e può orientarsi in modo più rispondente che facendo riferimento a un vago concetto di creatività, in modo analogo a quanto avviene per l'artista. Seguendo il processo di immaginazione materiale, attiva, creatrice (così viene nominata dagli autori di riferimento: Bachelard, Jung, Corbin), l'artista, il designer, il poeta, sono attori in un processo di ricezione e continua trasformazione delle immagini.

In questo senso non si tratta di comprendere come avvenga il processo creativo e quali siano le condizioni per favorirlo, bensì di comprendere come sia decisiva nel processo immaginante la capacità di osservare e ricevere le immagini grazie a una propensione di ascolto meditativo e di dare loro una forma grazie a una capacità trasmutatrice, a una disposizione simbolizzante (Wunenburger, 2007) atta a trovare nella materia e nelle cose le loro potenzialità inesprese. Queste capacità possono essere educate, nutrite e coltivate facendo riferimento al sapere che proviene dal mondo del gioco. Per questo, a partire da una provocazione di Wunenburger (2007, pp. 115-123), ho coniato il termine immaginazione ludica, e nel paper mi propongo di giustificare questo nuovo concetto, perché attraverso un sapere sul gioco e il giocare come attività libera, sganciata dalle necessità e orientata al piacere e alla bellezza, l'immaginazione può essere pensata come attività di superamento della letteralità dell'esperienza e come apertura al possibile.

'L'immaginario autentico dev'essere rischiarato alla luce del gioco delle forme oggettive che fanno prendere visione dei possibili del mondo. Poiché le variazioni morfogenetiche della natura e le torsioni immaginative delle nostre fabulazioni obbediscono probabilmente ad una medesima linea generativa' (Wunenburger, 2007, p. 120).

Immaginazione come organo di conoscenza

Una riflessione sull'immaginazione deve elaborare in primo luogo un posizionamento scientifico dal momento che tale facoltà è stata oggetto di studio di diversi ambiti disciplinari e di diverse posture culturali.

Inizio a collocarmi dalla parte di quei pensatori che hanno considerato l'immaginazione una facoltà conoscitiva peculiare, radicata in un contesto transculturale e transtorico e l'hanno nominata come immaginazione

creatrice (Corbin, 2005), immaginazione attiva (Jung, 1992; 2000; 2002), immaginazione materiale e dinamica (Bachelard, 1989; 1992; 1994; 1997; 2010), fantastica trascendentale (Durand, 1972), per descriverla come facoltà agente e operante nel mondo e connessa allo sguardo artistico o poetico.

In particolare Gaston Bachelard, che ha dedicato grande parte della sua riflessione filosofica allo studio dell'immaginazione simbolica, è un filosofo dal profilo culturale insolito e straordinario. Partendo da una iniziale formazione di matematico, prende una seconda laurea in filosofia e compie studi di epistemologia diventando professore alla Sorbona di storia e filosofia della scienza, ma a partire dagli anni 30 del secolo scorso compie parallelamente un percorso di studio con una ricca e raffinata linea di ricerca sull'immaginazione, nel suo legame con la produzione poetica (Bachelard, 1989; 1992; 1993; 1994; 1996; 1997; 2006; 2008; 2010).

Il mio percorso di studio e di ricerca deve molto al Bachelard filosofo dell'immaginazione e delle immagini poetiche, al sognatore, al cantore della felicità e del riposo. Se da un lato Bachelard riconosce che 'nel pensiero scientifico il concetto funziona tanto meglio quanto più è stato liberato da ogni immagine' (Bachelard, 1993, p. 60), dall'altro lato pubblica diversi volumi sullo studio dell'immaginazione, come espressione di un sapere che redime i limiti della ragione, amplificando il potere della conoscenza. Bachelard descrive un sapere delle immagini che si mostra attraverso le immagini; un sapere paradossale, incarnato nella materia e al contempo fluttuante e difficile da inquadrare nei codici dei protocolli scientifici.

Bachelard comincia così uno studio del pensiero poetico organizzato in base alle immagini della struttura elementale: il fuoco, l'acqua, l'aria e la terra (Bachelard, 1989; 1992; 1994; 1997; 2010). La metodologia che utilizza è inizialmente mutuata ed elaborata da due fonti autorevoli: da un lato la psicanalisi junghiana, che tratta gli oggetti psichici come fenomeni empirici, quindi degni di uno studio scientifico, e dall'altro lato la fenomenologia, utilizzata come scuola di ingenuità e come contatto con l'intenzionalità dell'immaginazione poetica. Ma le immagini e le forze esondanti dalle fonti poetiche che ha utilizzato nelle sue ricerche hanno consentito a Bachelard di liberarsi del laccio della psicoanalisi e della fenomenologia per far sorgere, nel corso dello sviluppo delle opere, una metodologia originalissima e penetrante.

Scardinando un principio incontrovertibile e comune a ogni epistemologia, Bachelard riposiziona la genesi dell'immaginazione fuori dall'uomo, nella materia e nelle sue forze, sostenendo che 'esistono, come

dimosteremo immagini della materia, immagini dirette della materia' (Bachelard, 1992, p. 11). Non è – solo - l'uomo a produrre immagini, ma queste provengono dalle cose, da un mondo sensibile e pulsante, colmo di vitalità e di energia. La materia si incontra con l'uomo grazie all'immaginazione, una facoltà che appartiene a entrambi e grazie alla quale entrano in mutua e reciproca risonanza.

L'immaginazione da una parte si sostanzia in immaginazione formale, più superficiale, che è anche la forma più consueta nel nostro linguaggio nel quale la intercambiamo con il termine fantasia, cioè la capacità di inventare forme nuove, originali e bizzarre, e dall'altra più raramente, e anche più profondamente, prende sostanza nella forma dell'immaginazione materiale e dinamica.

La materia possiede e coltiva una sua facoltà immaginante, che riesce a essere colta dal poeta. Quest'ultimo diventa così colui che sa dare alle secrezioni immaginative un nome e una forma consona, utilizzando immagini poetiche. In questo modo si postula un doppio movimento: del mondo verso l'uomo, quando la materia penetra nell'uomo e nella sua corporeità e organicità immaginativa e dell'uomo verso il mondo, quando egli entra in risonanza con gli elementi, trasformando la materia in sostanza immaginante, nell'arte, nei sogni.

Gli elementi per Bachelard, bel lungi dall'essere sostanze inanimate, strumenti per le sue operazioni produttive, ambiente per il suo sostentamento, sono invece materia, espressione, forza ed energia della stessa sostanza immaginante, elementi di rispecchiamento e riconoscimento che risuonano con l'animo umano.

Il fuoco si presenta a Bachelard come desiderio bruciante di conoscenza, come tensione di annientamento e di fusione, come desiderio sessuale, di una calda intimità; l'acqua si presenta come chiara e primaverile, o dormiente e morta, materna e femminile, e ancora dolce o violenta: tutte espressioni di una immaginazione materiale, cioè della materia.

Per Bachelard all'immaginazione materiale si affianca l'immaginazione dinamica, un'immaginazione della volontà, della tensione e delle forze. Così per esempio è l'aria a produrre immagini che rispondono a una materia in tensione, sotto sforzo, colma di volontà, immagini di forze di elevazione, di caduta, di volo, di guizzo, di ascensione: sono immagini vettoriali e direzionate, immagini dinamiche al servizio della leggerezza.

Lo studio sulle immagini della terra viene invece organizzato in base alla distinzione tra immagini dell'intimità (la casa, la grotta, il labirinto) e della

volontà (la durezza, la mollezza, la pesantezza, l'impasto, il vischioso, le gemme).

Non si tratta di una psicologizzazione della materia, di un antropomorfismo esacerbato, al contrario è l'uomo che nomina e dà forma alla sua sostanza, energia e dinamica imparando dagli elementi la caratura materiale e la dinamica delle forze.

Queste qualità definiscono un vantaggio sul pensiero, come un anticipo rispetto alla prospettiva funzionale e richiamano a una dimensione originaria, che viene prima dell'emozione, del sentimento, della cognizione, della progettualità.

Non si tratta neppure di una disposizione che asservisce la materia alle facoltà umane, come se essa debba essere compresa a partire dalle funzioni antropiche del bisogno e di una organizzazione pragmatica. Al contrario viene riconosciuta la povertà della ragione pratica che si ostina a voler spiegare la relazione dell'uomo con gli elementi ordinandoli, a ritroso, alla luce di una spiegazione strumentale, come se essi fossero riconosciuti dall'uomo, sin dal principio, come strumenti al nostro servizio, pronti per essere veicolo di cottura, di energia, di pulizia, di sostentamento, di volo.

Bachelard ci riporta a un'immersione nella sostanza elementale attraverso l'immaginazione come organo di conoscenza, a un riconoscimento di un contatto più antico e profondo con il mondo. Un contatto che è stato oscurato e ammantato dalla conoscenza pragmatica, oggi riconosciuta come unico veicolo di conoscenza dignitosa. Egli intuisce che la conoscenza immaginativa è più antica, più profonda e capace di rendere ragione di una connessione tra l'uomo e il mondo più intima e convincente.

Reversibilità e transitività delle immagini

I poeti e in senso ampio gli artisti sono gli eredi di una tale disposizione nei confronti del mondo e delle cose, una modalità rispondente e transitiva, capace, grazie all'organo immaginativo e a un linguaggio poetico o simbolico, di risuonare come un canto e un controcanto con il mondo.

L'immaginazione materiale, infatti, oggetto dello studio di Bachelard, è una 'immaginazione materiale innestata', incarnata nella produzione artistica poiché 'l'arte è un innesto nella natura' (Bachelard, 1992, p. 21).

Allo stesso modo in cui la natura per essere compresa nella sua produzione immaginativa dall'uomo necessita della produttività artistica, così l'arte necessita del contatto con la dimensione materiale, e in particolare con quella elementale, fonte di ogni afflato poetico.

L'espressione immaginazione materiale innestata suggerisce come l'immaginazione non sia una capacità che l'uomo possa padroneggiare e maneggiare con facilità, ma sia qualcosa da conquistare con fatica e esercizio, da disciplinare con un sapere tecnico, da raggiungere con una particolare postura di ascolto arretrata, in ritardo sulle cose, non rapace o prensiva.

Si tratta di una potenza immaginativa, posta fuori dell'uomo che si sfoga nell'opera, che trova un innesto nella materia grazie alla immaginazione poetica. Il poeta diventa vettore, canale dell'immaginazione che si scarica infine in opera.

‘Si può fare un passo avanti e porre l'immagine non solo prima del pensiero, prima del racconto, ma prima di qualsiasi emozione. È l'immaginazione che pensa, l'immaginazione che soffre. E agisce. Si scarica direttamente nei poemi. Il concetto di simbolo è troppo intellettuale, il concetto di esperienza poetica troppo sperimentale. Pensiero ed esperienza raminghi non bastano per arrivare alla primitività dell'immaginario. L'immagine dinamica è una realtà primaria’ (Bachelard, 1997, p. 103).

Bachelard parla espressamente di una rispondenza reciproca o transitività tra le forme dell'immaginazione, da più punti di vista. Da un lato perché le immagini nascono nella carne, negli organi: Bachelard infatti rivendica ante litteram una fenomenologia incarnata (si pensi che *Phénoménologie de la perception* di Merleau-Ponty esce nel 1945, tre anni dopo *L'eau et les Rêves*) e uno studio della psiche connesso a una corporeità integra e istintiva, non ridotta alla dimensione freudiana della libido sessualizzata. Dall'altro lato perché è la stessa materia a produrre immagini, a secernele costantemente e dinamicamente.

Esiste dunque una relazione di reciprocità, di transitività, di reversibilità delle immagini archetipiche, una convergenza archetipica delle immagini che si rispecchia nella relazione di reciprocità, di transitività, di reversibilità tra immaginazione poetica e immaginazione materiale e dinamica, tra soggetto immaginante e mondo immaginato.

‘Davanti all'antro profondo, all'imboccatura della caverna, il sognatore esita. Osserva dapprima il buco nero. La caverna, a sua volta, sguardo per sguardo, fissa il sognatore con il suo occhio nero. [...] bisogna sottolineare che questo stesso gioco di inversione costituisce la dinamica dell'immaginazione. Grazie ad esso, il nostro psichismo si anima e crea una sorta di metafora totale che traspone i due termini filosofici del soggetto e dell'universo’ (Bachelard, 1994, p. 173).

Questa intuizione torna, come eco di corrispondenze, nelle diverse opere sull'immaginazione, la consapevolezza ispirata di una relazione metaforica, cioè una relazione che pertiene al linguaggio poetico, che collega l'universo e l'uomo.

‘Pensiamo di vedere un cielo azzurro. All'improvviso, è il cielo azzurro che ci guarda’ (Bachelard, 1997, p. 177).

Tale corrispondenza non deve essere intesa in senso psicologistico, come sprofondamento e introspezione nell'inconscio individuale, quanto piuttosto come sfondamento e sbrecciatura della dimensione individuale, l'attraversamento della sottile membrana di separazione tra il soggetto e il mondo.

‘Se si vorrà [...] rendere le immagini letterarie dinamiche e materiali, non esisteranno più metafore nel senso tradizionale del termine. Ogni metafora porta dentro di sé un potere di reversibilità; i due poli di una metafora possono a turno fare la parte del reale o dell'ideale’ (Bachelard, 1997, p. 48).

Si tratta piuttosto di un riconoscimento, di un affratellamento, di una sintonia rispecchiante e riverberante. Il connettore immaginativo, che connette lo psichismo umano e la dimensione materiale rende biunivoca e percorribile anche a ritroso la relazione tra le immagini, per Bachelard questo avviene in particolare grazie al medium del linguaggio poetico, grazie alla metafora, all'antifrasi, alla metonimia, all'iperbole.

L'immaginazione ludica

La descrizione di compartecipazione e commistione tra anima e materia mi ha condotto a comprendere il processo di immaginazione come un doppio movimento, nel quale è la materia a produrre immagini dotate di una propria sostanzialità che sono trasformate in opera dall'uomo. Nel suo testo sull'immaginazione creatrice Corbin ha descritto come possa avvenire questo processo grazie alla mediazione di un mondo intermediario, un mundus imaginalis ‘sul quale ha propriamente potenza l'Immaginazione’, una forza che produce effetti reali tali da modellare il soggetto immaginante e la sua produzione immaginativa (Corbin, 2005, p. 160).

Il paragone tra esperienza mistica e esperienza artistica è legittimo, se non fosse che per Bachelard l'esperienza immaginativa è completamente e definitivamente immanente. Non vi sono tracce di spiritualismo e ogni movimento si situa incarnato nella materia, nell'uomo. È l'anima dell'uomo a connettersi all'anima mundi, e l'organo dell'anima è l'immaginazione, non vi sono spazi per la trascendenza.

Esiste una familiarità, un sodalizio reticolare tra le immagini e una corrispondenza tra il soggetto e la materia, espressione della forza immaginante. La medesima familiarità intuita da Caillois che ha a più riprese insistito sulla trama analogica che connette uomo, animali, natura e cosmo abitati dalle medesime leggi universali. Nell'ultima intervista rilasciata poco prima di morire Caillois disse che l'immagine che voleva lasciare di sé era 'forse, ed esclusivamente, quella di un poeta' (Caillois, 1998a, p. 116).

In questa prospettiva nei processi conoscitivi di natura immaginativa acquista un ruolo chiave la capacità dell'artista di connettersi al mondo, contemplandolo, amandolo e cantandolo. Ma questa capacità non è semplicemente un dono dell'artista, quanto una complessa competenza che va ricercata, temprata e educata e che consente di trovare, e non creare, connessioni inedite tra le cose e di riconoscere le loro potenzialità ancora inesprese, perchè latenti. Chiamo questa funzione immaginazione ludica (Antonacci, 2012a), perchè ho trovato in essa profondi legami con la sfera del gioco.

Già Huizinga ci ha rinfrancati nel riconoscere al gioco una funzione primaria e originaria, generatrice dei complessi fenomeni ramificati nella storia della cultura umana. 'La cultura non nasce dal gioco come frutto vivo che si svincoli dal corpo materno, ma si sviluppa nel gioco e come gioco' (Huizinga, 2001, p. 204).

Il gioco sembra essere la modalità con la quale l'uomo comprende la relazione con il mondo attraverso un processo di deletteralizzazione del reale, di dislocazione cognitiva, di spostamento dal senso letterale, modalità presenti nel linguaggio poetico come la metafora, la sineddoche, l'antifresi, la metonimia, l'ironia, l'iperbole. Modalità simboliche, poetiche, ma che potremmo definire eminentemente ludiche poichè prendono la forma della competizione, del rovesciamento del destino nell'alternanza di vittoria e sconfitta, prendono la forma del travestimento, del nascondimento, dello scherzo, dell'esagerazione. Sono colme di agon, alea, ilinx, mimicry, se le leggiamo attraverso la tassonomia di Caillois (2000), figura nota dagli studiosi del gioco, poichè il suo saggio 'I giochi e gli uomini' è un precursore dei recenti Game Studies. In questo contesto è interessante notare che la sua passione per il gioco emerge non solo dal volume ad esso dedicato, ma in modo più sottile, dalla funzione ludica della sua epistemologia, dalla morfologia della sua ricerca, eclettica, eccentrica e appassionata dalle connessioni, dalle trasversalità, diagonalità, a favore di un sapere che è riduttivo definire interdisciplinare, il sapere di uno spostato. Nei suoi scritti sulla connessione tra il mimetismo animale e il mascheramento umano

come L'occhio di Medusa, o ancora più profondamente nei testi dedicati alle pietre (tra i quali 1986 e 1998a) testimonia l'intuizione della relazione transitiva tra uomo e cosmo, dell'affratellamento immaginativo tra materia e pensiero.

‘Quando guardo attentamente le pietre, mi sforzo talvolta, non senza ingenuità, di indovinarne i segreti. Mi abbandono a immaginare come abbiano potuto formarsi tante enigmatiche meraviglie, nate da leggi che non di rado esse sembrano violare, come fossero l'esito di un tumulto [...]. Mi sforzo di afferrarle col pensiero nell'ardente istante della loro genesi. Allora vengo colto da una specie molto particolare di eccitazione. Mi sembra di assumere, almeno in parte, la natura delle pietre. [...] La metafora spalleggia (o corrompe) il sillogismo, la visione nutre (o fuorvia) il rigore. Tra la fissità della pietra e l'effervescenza mentale si stabilisce una specie di corrente in cui trovo, per un solo ma memorabile istante, saggezza e conforto. Quasi quasi ci vedrei il germe possibile di una specie inedita e paradossale di mistica’ (Caillois, 1998a, p. 63).

Ciò che accomuna gioco e poesia è la disposizione simbolizzante e la postura conoscitiva di una immaginazione ludica. È necessario insistere sul fatto che tale modalità è originaria e profondamente radicata nell'uomo, non si apprende, ma al massimo si ricorda. Se non appartiene all'uomo adulto è perché non gli appartiene più, poiché è stata dimenticata e abbandonata. Infatti l'uomo viene a comprendere il mondo dapprima immaginativamente, cioè poeticamente grazie al gioco d'infanzia e solo successivamente trasforma il suo legame con il mondo in modo strumentale, utilitaristico, pragmatico, oggettivante. Se a un certo punto nell'età adulta tale connessione viene scoperta, con ‘una specie molto particolare di eccitazione’ è perché essa viene rievocata, ripresa, rammemorata e torna alla luce come consapevolezza di un modo di legarsi al mondo giocando, un modo che si è sperimentato nell'infanzia.

Una antecedenza temporale che non è solo un emblema di temporalità storica della specie umana, dal momento che il pensiero mitico simbolico immaginativo precede il dominio del razionalismo, ma anche una temporalità originaria di ogni singolo, una sostanza propria del cominciamento, uno stato aurorale di ‘infanzia cosmica’ (Bachelard, 1993). Per questo il gioco è connesso all'infanzia in modo indissolubile, non solo perché il modo d'essere dell'uomo inizia in gioco, non solo perché sono soprattutto i bambini a giocare, quanto perché è il bambino simbolico, è il puer ludens (Antonacci, 2012a) a incarnare la modalità ludica di relazione con il mondo. Una modalità che può permanere nelle diverse età della vita o

riemergere in età adulta come ispirazione o scoperta, dopo una latenza assopita.

L'immaginazione ludica è la tensione che consente di innovare e inventare, come quando un bambino riconosce in una sedia un'astronave da far guizzare, restituendo alle cose le loro forme implicite e potenziali. Tale forma di riconoscimento è ben descritta da Huizinga che la presenta come l'oscillazione tra il credere e il non credere.

'[...] proprio nel concetto stesso di gioco è espressa meglio che ovunque l'unità e l'indivisibilità del credere e non credere, l'unione di sacrosanta serietà con ostentazione e scherzo' (Huizinga, 2001, p. 31).

Nel gioco si sperimenta la commistione e l'oscillazione tra l'accettazione della realtà presente e il suo raddoppiamento, per mezzo di una azione ermeneutica. Attribuendo significato alla realtà se ne arricchiscono e amplificano le prospettive. Questo è il senso di un pensiero simbolico, che non tenta di ridurre la comprensione, facendo della conoscenza uno strumento limitante e semplificatore, ma al contrario moltiplica le possibilità interpretative, e accoglie la complessità satura di antitesi e contraddizioni (Wunenburger, 2007).

Facendo eco alla filosofia utopica di Bloch dovremmo dire 'ciò che è non può essere vero' (Bloch, 2009), nel senso che non può essere vero solamente ciò che è presente ai nostri occhi, non può essere vero solo il mondo nella sua letteralità. E potremmo sognare dicendo 'ciò che non è (o non sembra essere) poteva, può e potrà essere vero', così da rimarcare la possibilità di intravedere nella realtà i germi delle sue metamorfosi possibilitanti.

Crede nella realtà presente e al tempo stesso intravederne le trasformazioni, credere nel cerchio magico (Huizinga, 2001), è il potere del giocatore che riconosce e valorizza del mondo le qualità di un campo da gioco: la tensione tra regola e la libertà, la vertigine dell'aleatorietà, l'ebbrezza della competizione, il puro divertimento, poiché si muove sospinto dal desiderio, invece che dal bisogno. Si tratta della facoltà di vedere negli oggetti non già la loro mera dattità e il loro valore d'uso, ma di rivelare la loro ambivalente bellezza nascosta, mostrandoli come compagni (e non strumenti) di piacere.

In questo senso l'immaginazione ludica lega il giocatore all'artista, al poeta, al bambino, per i quali la vergogna è impensabile, la dislocazione cognitiva avviene spontaneamente, il pensiero simbolico è consueto e connaturato, anche nella forma di pensiero magico.

Tale facoltà può permanere nella vita, se accudita e protetta, viva e pulsante oppure può essere rivitalizzata e insufflata perchè il suo potere trasformativo prenda nuovamente forma e espressione.

Ho trovato una descrizione che aiuta a comprendere la qualità dello stato di presenza dell'adulto immerso in un processo di immaginazione ludica nella teoria del flusso come l'esperienza ottimale, descritta da Csikszentmihalyi. Egli ha studiato la condizione di persone coinvolte in attività gratificanti e altamente immersive, come le performance artistiche (musicali, coreutiche, teatrali) o sportive, la produzione poetica, la realizzazione di una prova o di un compito lavorativo complesso e affascinante da parte di scienziati o ricercatori.

‘Nelle rare occasioni in cui questo accade, sentiamo un senso di euforia, un senso profondo di piacere a lungo desiderato e che diventa un punto di riferimento nella memoria rispetto a come dovrebbe essere la vita’ (Csikszentmihalyi, 1990, p. 3).

Tale esperienza si prova quando si è completamente coinvolti in una attività, in uno stato di estrema concentrazione che ricorda maggiormente una condizione estatica, nel senso di separazione dalle attività ordinarie per saltare in una realtà alternativa, intensificata. Il flusso è stato definito come un senso di profonda comprensione e chiarezza interiore, poiché in esso si ha padronanza di ciò che si sta facendo e non si è assillati dalle preoccupazioni quotidiane, poiché lo svolgimento di quell'attività è più importante della soddisfazione dei propri bisogni e delle esigenze del proprio ego. Quando si è immersi nel flusso si dimora in uno stato atemporale di coinvolgimento colmo di significato, infatti tale attività è supportata da una motivazione intrinseca, poiché si sta facendo qualcosa per il piacere di farlo e non per ottenere qualche vantaggio o premio estrinseco, che al massimo rappresenta un sovrappiù (Csikszentmihalyi, 2004).

Un giocatore impegnato in una attività ludica, un esperto impegnato nella pratica di discipline performative (teatro, danza) o di discipline di perfezionamento orientali (arti marziali, meditazione, yoga) sa bene quanto sia necessario coniugare un ascolto e una ricettività sensibile e appassionata con l'apprendimento di tecniche e una padronanza del proprio corpo, della propria mente, della propria volontà, della propria memoria, della propria percezione, grazie a una pratica costante e rigorosa (Antonacci, 2012b).

Conclusioni

Con questo lavoro intendo compiere un piccolo passo per comprendere il nesso profondo che lega il design, come l'operatività artistica, al gioco attraverso il connettore immaginativo. Il designer e l'artista possono apprendere dal giocatore le qualità di una conoscenza immaginativa per esercitare una capacità sensibile e trasformatrice della realtà. Tale propensione non si dovrebbe ridurre all'estro e alla capacità di inventare forme superficiali e bizzarre, ma dovrebbe essere incanalata e disciplinata grazie a uno studio rigoroso, per sviluppare la padronanza tecnica in una disciplina. L'esercizio nelle diverse discipline artistiche, costante e ripetuto, aiuta a porsi in un atteggiamento di ascolto e ricezione della materia e delle sue forze, al fine di forgiare un'opera d'ingegno significativa e simbolica, cioè portatrice di un significato complesso, comprensibile e condivisibile. Questo non vuol dire creare qualcosa di scontato o facilmente apprezzabile, ma qualcosa che comunica significato, anche quando si pone nella forma della provocazione. Dalla disposizione giocosa, dallo sguardo ludico e dalle energie di competizione, casualità, travestimento, ebbrezza, scontro e armonia, l'artista e il designer possono imparare una differente modalità di comprensione: una immaginazione ludica, che sembra essere in sintonia con la modalità necessaria per immergersi nel flusso, come esperienza ottimale.

L'intensificazione dell'esperienza e la postura recettiva di ascolto del soggetto aiutano a riconoscere e trasformare la materia e le sue forze, in un gioco di reciprocità. Tale trasformazione transitiva può avvenire grazie al linguaggio simbolico, che non si sottomette a una logica di rispondenza letterale, ma prende le forme poetiche dell'iperbole, della metafora, dell'antifrasi, forme che trasposte nel mondo del gioco sono l'esagerazione, il travestimento, la competizione. L'esercizio, la tecnica e la preparazione si possono innestare all'immaginazione ludica, cioè a una disposizione simbolizzante che, grazie a una pratica di osservazione, ascolto e ricezione da un lato, e di trasmutazione attiva dall'altro, riesce a intravedere le possibilità implicite nella realtà, per dar loro una forma visibile e comprensibile. Tali forme di immaginazione ludica sono volte all'amplificazione e alla trasmissione della cultura umana come sapere incarnato nella materia.

References

Antonacci, F. (ed.) (2012a) *Puer Ludens, Antimanuale per poeti, funamboli, guerrieri*. Milano: Angeli.

- Antonacci, F. (2012b) *Corpi radiosi, segnati, sottili. Ultimatum a una pedagogia dal 'culo di pietra'*. Milano: Angeli.
- Bachelard G. (1989) *La terra e le forze*. Como: Red.
- Bachelard, G. (1992) *Psicoanalisi delle acque. Purificazione, morte e rinascita*. Como: Red.
- Bachelard, G. (1993) *La poetica della rêverie*. Bari: Dedalo.
- Bachelard, G. (1994) *La terra e il riposo. Le immagini dell'intimità*. Como: Red.
- Bachelard, G. (1996) *La fiamma di una candela*. Milano: SE.
- Bachelard, G. (1997) *Psicanalisi dell'aria. Sognare di volare. L'ascesa e la caduta*. Como: Red.
- Bachelard, G. (2006) *La poetica dello spazio*. Bari: Dedalo.
- Bachelard, G. (2008) *Il diritto di sognare*. Bari: Dedalo.
- Bachelard, G. (2010) *L'intuizione dell'istante. La psicanalisi del fuoco*. Bari: Dedalo.
- Bertolo, M. e Mariani, I. (2014) *Game Design. Gioco e giocare tra teoria e progetto*. Milano: Pearson.
- Bloch, H. (2009) *Lo spirito dell'utopia*. Milano: Rizzoli.
- Caillois, R. (1986) *La scrittura delle Pietre*. Genova: Marietti.
- Caillois, R. (1998a) *Pietre*. Genova: Graphos.
- Caillois, R. (1998b) *L'occhio di Medusa. L'uomo, l'animale, la maschera*. Milano: Cortina.
- Caillois, R. (2000) *I giochi e gli uomini. La maschera e la vertigine*. Milano: Bompiani.
- Corbin, H. (2005) *L'immaginazione creatrice. Le radici del sufismo*. Roma-Bari: Laterza.
- Csikszentmihalyi, M. (1990) *Flow. The Psychology of Optimal Experience*. New York City: HarperCollins.
- Csikszentmihalyi, M. (2004) *Flow, the secret to happiness*. TED2004 [Online Video]. Available from: http://www.ted.com/talks/mihaly_csikszentmihalyi_on_flow#t-3673 [Accessed: December 2014].
- Durand, G. (1972) *Le strutture antropologiche dell'immaginario. Introduzione all'archetipologia generale*. Bari: Dedalo.
- Huizinga, J. (2001) *Homo ludens*. Torino: Einaudi.
- Jung, C. G. (1992) *Ricordi, sogni, riflessioni*. Milano: Rizzoli.
- Jung, C.G. (2000) *La dinamica dell'inconscio. Opere, vol. VIII*. Torino: Bollati Boringhieri.

FRANCESCA ANTONACCI

- Jung, C. G. (2002) *Mysterium Coniunctionis. Opere, vol. XIV*. Torino: Bollati Boringhieri.
- Mottana P. (2002) *L'opera dello sguardo. Braci di pedagogia immaginale*. Bergamo: Moretti&Vitali.
- Mottana, P. (2010) *L'arte che non muore. L'immaginale contemporaneo*. Milano: Mimesis.
- Suits, B. (1978) *The Grasshopper: Games, Life and Utopia*. Peterborough: Broadview.
- Turner, V. (1982) *From ritual to theatre. The Human Seriousness of Play*. New York City: Performing Arts Journal Publications.
- Wunenburger, J.J. (2007) *La vita delle immagini*. Milano: Mimesis.

Doing Stuff with Stuff: Designing for the Everyday Metamorphosis of Collaborative Work Environments

Chris BERTHELSEN* and Charles WALKER
Auckland University of Technology

This paper unpicks a thread in the everyday logic of the novelty-seeking motives of emerging collaborative environments. Through a discussion of metamorphosis and mess, and boundaries of stuff we propose an understanding of the dynamic view of knowledge and the in-formation of design (viewed as the ambiguous and inarticulate 'doing stuff with stuff') as 'everyday metamorphosis' - a framework for appreciating how working with, rather than solving mess can play a role in collaborative work environments. The paper concludes by presenting an emerging experiment in everyday metamorphosis and briefly speculating how this might contribute to thinking about new socio-material collaborative models.

Keywords: Creativity; mess; everyday metamorphosis; collaboration

1. Introduction

This paper presents early investigations of a longer-term research project to examine the stuff (inclusively as people, relationships, non-humans, objects, physical phenomena, software, spaces, and processes, for example) with which we work, interact, experiment or play in socio-material environments (e.g. Franck and Stevens, 2006; Galloway, 2007; Nicholson, 1972).

Broadly, the project asks:

What role does all the 'stuff' around us play in generating or inhibiting new ideas, relationships, progress, change and/or unexpected directions in our collaborative work?

This discussion is founded in an interest in the ways in which objects and practices co-evolve (Shove et al., 2007), the rhythmic, temporal and story-

* Corresponding author: **Chris Berthelsen** | e-mail: chris@a-small-lab.com

like nature of stuff which positions it 'at the confluence of actions and responses' (Ingold, 2011, p. 154), and the improvisatory capacity of people in their everyday environments (Brandes et. al., 2009). The purpose of this paper is to begin to unpick a thread in the everyday logic that can be derived from the novelty-seeking motives of emerging collaborative environments (spaces starting with 'co') such as co-work spaces, transdisciplinary laboratories and everyday 'working together'. Through a discussion of metamorphosis and mess, and boundaries of stuff we propose an understanding of the dynamic view of knowledge and the in-formation of design (viewed as the ambiguous and inarticulate 'doing stuff with stuff') as 'everyday metamorphosis' - a framework for appreciating how working with, rather than solving mess can play a role in collaborative work environments. Further, we present one of our emerging experiments in everyday metamorphosis and tease out three threads (simple alchemies; stigmergy; trance-like states) that can contribute to a developing model of collaboration.

2. Metamorphosis, Mess

2.1 The Magic of 'Co' (= Metamorphosis)

The value of inventiveness, creativity and the possibility of discovery is the inherent motive in emerging collaborative environments. The plurality and diversity of such environments are known to promote divergent processes, which are important characteristics of creativity (Basset-Jones, 2005). Further, a componential theory of creativity holds the environment as one key influence on creative output and the components of individual creativity (intrinsic motivation, domain-relevant knowledge, and creativity relevant processes) (Amabile, 1996). Thus, when concerned with increasing creativity of multiple individuals through collaboration the environment where they come together is important (e.g. Hamano, 2012). Research on the environment for creativity spans the social-psychological (e.g. Amabile et al., 2006), urban (e.g. Stevens, 2007), and spatial (Sailer, 2011), for example. Such literature seeks to articulate aspects of the environment in the pursuit of understanding and increasing creative outcomes but attempts at working with (as opposed to solving) the inarticulate intermediate aspects of the processes at work in these environments are still rare. Media reports and everyday accounts of spaces starting with 'co' also show a lack of reflection on such aspects (not to deny that the success of many of these places illustrates an understanding of these issues) - for example;

‘...put smart people around other smart people in collaborative spaces ‘where magic can happen’. ‘A developer ends up sharing an idea with a marketer. They decide to start up an enterprise, and bam, you have another great collaboration built naturally around relationships.’ (Ken Erskine, quoted in *The New Zealand Herald*, 2014 - on Auckland’s new Wynyard Quarter innovation precinct).

Similar to a From-To Poetics (Guggenheim, 2011) that describe a kind of magic in the built environment where the start and end states (absent process) account for changes in use – these invocations of the magic of ‘co’ take us from co-presence to innovative collaboration with a lack of analysis of the fine-grained aspects at work on an everyday level. This is a metamorphic representation of collaboration which views environments in distinct and discrete forms, each of which are substantially perfect from the beginning – for example, the birth of a butterfly, the opening of a new urban development, a productive meeting with a stranger, or the birth of a new business venture (see e.g. Baumann, 2000; Wiener, 1954 on metamorphosis). Change presented in this way is a radical (magical) transformation which in fact has ‘no intrinsic capability of growth’ because it leaves little room for memory (Wiener, 1954, p. 54).

The loss of memory is a loss of knowledge (Stiegler, 2010) and as knowledge and skills are a necessary part of an individual’s capacity for creativity (Amabile, 1996; Amabile et al., 1996; Boden, 1994) memory loss impedes the ability to dig deep and venture forth into the unfamiliar in the pursuit of experiments with the elusive and the uncertain (e.g. Sennett, 2006; Tuan, 1977). Lacking the ability to explore the unknown, we can make the mistake of believing that we reside in a situation with no unknowns (Yoshikawa’s metamorphic ‘ideal knowledge design situation’) where we have perfect knowledge about functions, attributes and how to put them together. In such a case, design and designers disappear, our work goal becomes pure optimization (Hatchuel and Weil, 2003) and as a result the potential for unexpected and valuable outcomes diminish. In contrast, a Concept-Knowledge Theory (CKT) approach to design defines the unknown (a Concept in CKT terminology) as essential and thus views the knowledge expansion process (the generative interplay between known and unknown) as central (Hatchuel and Weil, 2003; Kimbell, 2009).

In working with novelty-seeking collaborative environments then, it is necessary to move away from a metamorphic view which posits perfect knowledge within definite moults (stages) and move towards a dynamic, incomplete and messy view of knowledge.

2.2 Mess

'Everything we design and make is an improvisation, a lash-up, something inept and provisional' (Pye, 1978, p. 14). We encounter, create, and dwell in mess, making 'wrong moves, false starts, dead ends' (Sennet, 2008:161), while working with the existing in acts of 'modification, conversion, and adaptation' to give form to ideas (de Freitas, 2008, p. 7). Working with incompleteness is a form of bricolage (e.g. Levi-Strauss, 1966), where goals are pursued through arrangement and rearrangement, negotiation and renegotiation, in a 'collaborative venture' or 'conversation' with the materials which is contemplative and considers missteps as part of producing new ideas (Turkle and Papert, 1991, p. 169). All knowledge involves some degree of bricolage (Scalbert, 2011). People do not draw solely on existing individual knowledge (explicit and tacit) when engaging in activities, they draw upon collective knowledge (whether they are aware of it or not) (Tsoukas, 1996) and have a capacity to create new knowledge (Nonaka, 1994). It is when knowledge is constantly undergoing change that it possesses the greatest power (Nonaka, 1994). In this view knowledge is 'essentially active' (Piaget, 1968). Flusser's example of the evolution of the pot (from cupped hand to fired ceramic) illustrates this dynamic view of knowledge in an intimate way, showing how human knowledge shaped by tacit knowledge and codified into explicit (or structured) knowledge 'must on occasion be up-ended to expand our knowledge base' (Henry, 2007, p. 2).

2.2.1 Doing Stuff with Stuff

To talk in this way is to recognise the dynamic aspect of knowing - the verb rather than the noun. It is to focus on the act of creating (poiesis) which can be learned, rather than the object, which cannot (Carse, 1986), and to turn an eye towards concrete modes of thought where the mind uses objects to think with in a 'dynamic relationship' (Turkle, 2007, p. 9). Doing stuff with stuff is thinking that we can touch, take apart and leave around. This kind of knowing involves more than just thinking and reasoning, it involves ways of doing, acting, communicating, interacting and negotiating (Lawson, 2004). Humans are *Homo Ludens* (at play, e.g. Huizinger, 1955) and *Homo Faber* (at making, e.g. Gatt and Ingold, 2013). Playing through ideas and thinking through making (Philpott, 2013) shows that what the maker pursues is 'sufficiently clear to be perceived but sufficiently unclear... to deserve to be pursued...' (Tin, 2013, p. 5) (i.e. incompleteness and the unknown). In short, to do stuff with stuff is to know it, and to know stuff is to continue to do stuff with it.

3. Boundaries of Stuff

‘Machines, products, tools... prosthetics... applications, programs, interconnections, energy and information flows... laws of circulation, boundaries, necessities, designs, logics... accidents, mechanisms, exertions...’ (Preciado, quoted in Eckert, 2011, p. 61). ‘Cat Hair, Beetles, Brillo Pads... Viagra, Jelly Beans, Pubic Hair, Curry Powder, Metal Screws...’ (Bardini, 2011, p. 8). There is a lot of stuff to ‘appreciate’ (Mol’s 2010 term) in the expansion the knowledge space, which is not surprising given that mess invites ‘a wider set of relationships into the collaborative ring’ (de Freitas, 2008, p. 6).

To begin to make sense of all this stuff an understanding of boundaries is helpful (Galloway, 2007). We take from Gibson (1979) the viewpoint that substances are physical foundations for life that can’t be moved through and that surfaces (the interface, what bodies touch) that separate them are where ‘most of the action is’ (Gibson, 1979, p. 23). From American metaphysician Paul Weiss we see that ‘[t]he key to understanding space lies in [the] mutual resistance between diverse individuals [and that] shared public existence, and any of its parts, can be thought of as a kind of boundary, a union and a division’ (Miller, 1987, p. 84). All boundaries have a certain thickness, but every part of the stuff we experience melts into its neighbours, resulting in a ‘continuum of filter-like boundaries’ (Miller, 1987, p. 85).

We can view this situation in terms of conjunction and connection.

Conjunction is ‘the meeting and fusion of rounded and irregular forms that infuse in a manner that is imprecise, unrepeatable, imperfect and continuous’ (mess) and connection is ‘the punctual and repeatable interaction of algorithmic functions, straight lines and points that juxtapose perfectly and are inserted and removed in discrete modes of interaction’ (metamorphosis) (Berardi, 2009, p. 131). The conjunction-connection distinction resonates with Anusas and Ingold’s (2013) analysis of a Western industrialized design that increasingly separates the myriad workings of things (infrastices) from surfaces, which must then be breached in order to connect and be used with other things. Similarly, Ingold (2009) perceives this dichotomy in terms of lines versus dots; a view of knowledge derived through a journey or practice rather than abstracted from discrete data points.

In a world trending towards the seamless (in e.g. product design and collaboration), connections do not produce seams or scars (see e.g. Galloway, 2007), meaning that a tendency towards the connective and

seamless is a tendency towards '*a design*' as an isolated material thing that obscures complexity and interrelatedness through the metamorphic 'plugin'.

On the other hand, '*design as a practice*' that can enable richer dialogue between people, materials and surroundings (Anusas and Ingold, 2013) displays a more conjunctive tendency. Here, the process may be illegible, inarticulate and unpredictable but has the potential to possess qualities which may foster knowledge expansion through their at-ease-ness with the unknown. This distinction does not deny that connective modes 'work' or posit that conjunctive modes might work better in the context of current success metrics. Appreciating the conjunctive mode does however help us to move focus from the author (as connector agent) to the environment (as generative architecture) (e.g. Hamano, 2012). Secondly, making the linkage between the surface characteristics of stuff and the qualities of design and knowledge that they imply highlights the importance of appreciating the intertwining of the various stuff that we do stuff with (e.g. Ingold, 2011).

4. (Everyday) Metamorphosis and the Collaborative Work Environment

We have followed a thread that started by noting that novelty-seeking motive of spaces for collaboration can be viewed as the motive to design, which in turn necessitates knowledge generation. As opposed to consecutively perfect metamorphosis the model we scratch out is a messy and fluid (but navigable) environment where memory and learning are founded on a degree of continuity. We call this an everyday metamorphosis (in a nod to Brandes, Stitch and Wender, 2009's inspiring work on creative reuse, stuff, and design).

'Everyday' points to the rhythms of the human worklife. We use it to emphasise the non-goal oriented aspects of the 'bringing forth' of production setting the 'verb 'to produce' alongside other intransitive verbs such as to hope, to grow and to dwell, as against such transitive verbs as to plan, to make and to build' (Ingold, 2011, p. 6). In short, by setting the overarching goals of work in the background we hope to bring the fluid aspects of the everyday to the fore.

We retain the word metamorphosis to highlight that we can in fact perceive changes and parts in the 'entangled mesh of materials in energetic movement, out of which the forms of things are continually emerging' (Anusas and Ingold, 2013, p. 66). Recognizing degrees of privacy enables us to distinguish between the table and its subatomic constituents (Miller,

1987), the website, the myriad hyperlinks, and the source code, or the mud pie and the grain of sand, for example (note that the degrees that we can perceive and act with depend on our knowledge expansions). This viewpoint helps us retrieve the interassociations of stuff (including us) from a sea/compost that we dwell in, in the hope that we can reoperationalise them for theoretical and practical uses.

4.1 An Experiment in Everyday Metamorphosis in a Collaborative Work Environment

In the following empirical account we outline a recent experiment by Auckland-based artist/researcher Xin Cheng and a co-author of this paper, Chris Berthelsen. This was an attempt to savour the simple pleasures of practical experimentation with resources at hand and the environment as given, and consider circumstances and eddies, niches and leftovers, material intrigue, spontaneous constructions and rearrangements, sustenance and pleasures of the senses. We briefly outline the work/environment and then discuss aspects of everyday metamorphosis that it highlights, teasing out future directions for investigating new socio-material collaborative models. Following Kilbourn (2013) we focus on the experience of carrying out the activities. Rather than descriptive, in this section our purpose is generative - to imagine design opportunities.

4.1.1 making-do¹

As part of the public programme for Artspace - the 'leading non-collecting, non-commercial organisation for contemporary art in New Zealand' (Artspace, 2014) - making-do is a series of four 4-5 hour walks, a 3 hour workshop, and an ongoing publication/installation.

The project description explains:

'Having a conversation with the junk of a City of Riches feels surprisingly cosy. And inspires intense concentration.

With a makeshift trolley of tools and resources in tow, Xin Cheng, Chris Berthelsen and companions become hypnotized by the fine-grain of Auckland's native wetlands, urban industrial zones and sub/urban deathtraps. Over a series of walks they begin to work out how to come to terms with the Super City in a pragmatic, generative, and non-goal-oriented manner.' (Cheng and Berthelsen, 2014)

¹ The following sections include text written by and/or in conjunction with Xin Cheng (<http://xin-cheng.info>) but the responsibility for any errors remains the author's.

With various companions (we prefer the term to participants as it evokes a closer, more convivial relationship) we embarked on half-day walks where we were not afraid to 'see what happens' (non-goal oriented) and enter into material dialogue with our tools, resources and the environment as given. Rather than an exercise in guerrilla, or tactical urbanism we viewed this as an opportunity for experiencing how unknown and incomplete stuff at hand can be perceived, form and be worked with, and to explore what we can learn about ourselves and others (Galloway, 2007) in the process. An online sketchbook of the walks (<http://md.making-doing.info>) helped us and companions share sensemaking and speculation about aspects of the walks in an asynchronous and fragmented way, creating a shared yet ambiguous starting point for the workshop. The workshop consisted of (1) a one hour session attempting to make various mobile storage devices from various stuff we had collected over the walking tours, and (2) a two hour walking tour throughout the Auckland CBD. Willing companions were (1) Advised to bring a plastic bag and wear comfortable clothes and (2) Invited to bring a light item of junk from home and some simple snacks to share, but were given no other prior directions. Companions (in person and those who joined in asynchronously throughout the work) contributed to an ongoing publication which was launched at a local zinefest and is a DIY bookbinding installation at the Artspace reading room.

4.2 Aspects for Everyday Metamorphosis

Reflecting on the above activity we identify three conjunctive characteristics that help us clarify the everyday metamorphosis of the collaborative work environment (Figure 1): (a) simple alchemies (engrams), (b) stigmergy, and (c) a viscous fluid (trance-like states). They offer directions and pose questions for practitioners seeking to appreciate the everyday metamorphosis of collaborative work environments.

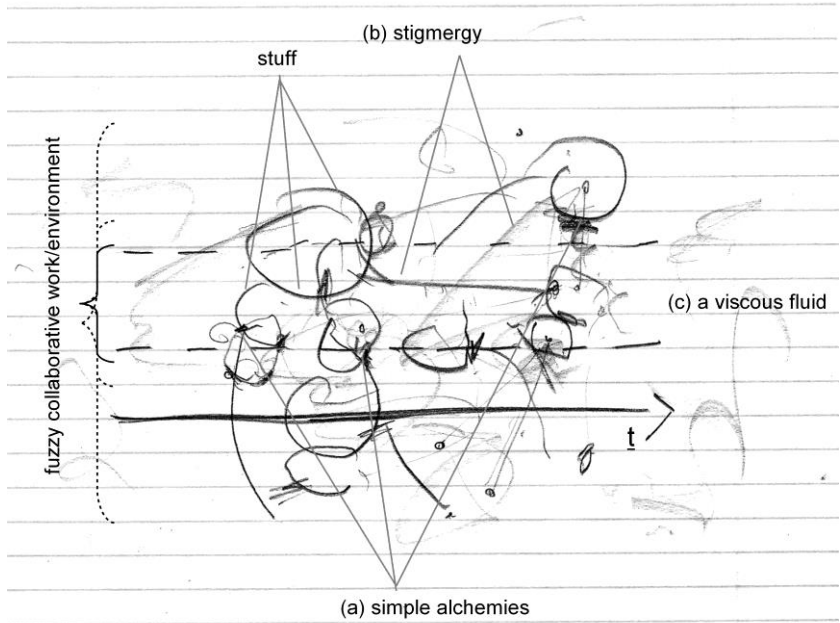


Figure 1 *Everyday Metamorphosis*.

4.2.1 Simple Alchemies (Engrams)

Seaweed, a self-seeded loquat tree and a backpacker from Chile combine for a memorial to a recently deceased father; Sticks become footholds and hammers; Puddles are painting palettes; Vines and inner tubes are fashioned into playthings. These are our simple, cheap and disposable stuff (our 'loose parts' – Nicholson, 1972), and their mis/reuse is a localized swelling (node) of combination (the knots of Ingold's (2009, 2011) meshwork). They constitute engrams (traces and fragments of action left in the environment) that can influence (in ways from practical ideas, to conflict and feelings of permission) the actions of ourselves and others and contribute to the continuing transformation of the environment through a process of stigmergy (see below) (e.g. Camazine et al., 2001).

We like playing with trash, but simple alchemies are not restricted to the household variety noted above. Knowledge relativity and degrees of privacy imply that simplicity is dependent on both our domain-specific knowledge of it and at what degree we can (or wish to) perceive it at. Skilled practice (Ingold, 2008) and the context dependence of creativity/ technology

(Resnick, 2006) mean that the category of simple can include all open systems. For example, the programming of computers involves a more concrete and personal relationship with materials than its social construction would have us believe (Turkle and Papert, 1991) and as complex machines make some skills obsolete they concurrently become grounds for new communities of practice (Ingold, 2011). Simple and effective alchemies prove to be generative and ad-hoc experiments in diverse interactions of open stuff.

4.2.2 *Stigmergy*

Realising that an effective broom can be fashioned from cable ties leads to discussion of gentrification and the precarity of local government employment; Potholes and cracked stormwater drains provide jump-off points for an investigation of public safety structures; a mutual interest in tyres spawns a productive partnership. Here, we experience how knowledge transforms through letting effects emerge (see e.g. Turkle and Papert, 1991) to mold both reflexes (discrete action) and behaviours (learning) (see Wiener's (1954) discussion of feedback). The simple nature of our alchemies enables fast feedback which relates to immediate use-pleasure and flows and stocks of knowledge. Both the materials and environment, and the skills and repertoire of our companions develop. The question is not how to create new stuff that is easier to work with. It is up to (and the pleasure of) the companions to discover new ways of fruitful interaction with materials-at-hand. This is a view of creativity that favours improvisation as opposed to innovation (see e.g. Gatt and Ingold, 2013). It is a stigmergic perspective where copresence nurtures a process of collaboration when individuals communicate (not necessarily knowingly) with one another by modifying their local environment (Elliot, 2006). Galloway (2007) encourages us to view these modifications as sources of knowledge about how we live with the stuff in our world. Like Certeau's footsteps - '[t]hey are myriad, but do not compose a series... [t]heir intertwined paths give shape to spaces. They weave places together' (1984, p. 97) in lines of knowledge expansion (e.g. Ingold, 2009). Understood this way the generative function of the environment can be perceived. Our doings with stuff become decreasingly discernible in their original form over time and are of varying permanence as scars form and cracks rupture. Legibility runs a spectrum from finished product to fragments, remnants, traces, and raw materials. This process shunts authorship from observable through a spectrum of memory that ends in the author being forgotten or indiscernible. When no definite

records remain, questions of privacy and surveillance become muted and archiving depends on the individual memories, and care and preservation (see, e.g. Hui, 2013) in loose understandings with stuff.

4.2.3 A Viscous Fluid (Trance-Like States)

Walking all day through industrial estates in the rain; Napping on a berm to the cackling of weed smokers in a nearby house; Zoning out in front of a stew of beans. These trance-like states are the viscous fluid which greases our everyday. They quieten the chatter in our heads, make space for unexpected connections and fuzzy digressions that we have seen reappear in our subsequent work and collaborations.

To value such trance-like states is to be open to the 'generative and provocative' reframing power of the experiential (e.g. Kilbourn, 2013, p. 70) and to follow Oretton's example and '...revel in our fieldwork as an activity saturated with sensory, corporeal experiences...' (Oretton quoted in Bain and Nash, 2006, p. 100). In light of the psycho-cognitive mutations and mental suffering that Berardi (2009) delineates this aspect may be one of the most important. It opens a crack in our worklives for deceleration, demobilizing productive energy, and thus savouring the pleasure and meaning in work experience. A viscous fluid cannot connect. Rather it is a caress and envelopment that seeps into cracks and seams, providing a mucus terrain for the uncertain conjunction and thus collaboration of stuff.

5. Conclusion

The longer-term objective of this research project is to experiment with the material and becoming aspects of everyday metamorphosis in continual knowledge expansion in collaborative environments. We have outlined a perspective which values the conjunctiveness of the stuff around us as an important part of the design process in terms of the way it allows for mess and the dynamism of knowledge. In the context of this paper we have noted three aspects for further consideration. Some things that we now pursue in design experiments (including public park design, site-specific installations, and community-based learning collaboration) include: How might we operationalise the simple alchemies of stuff in a coherent way for developers, managers and inhabitants of spaces starting with 'co'? In an increasingly mobile and computery work environment how can the concept of stigmergy be leveraged in virtual and physical ways in the support of knowledge expansion? Are trance-like states of the sort we mention only

accessible to the unemployed, students, artists and parasites? And will we be able to convince middle managers of value that we perceive in them?

Notes

In the spirit of this paper we are always open to suggestion. Please do not hesitate to email us.

References

- Amabile, T.M. (1996) *Creativity in context*. Boulder: Westview Press.
- Amabile, T.M., Conti, R., Coon, H., Lazenby, J. and Herron M. (1996) Assessing the work environment for creativity. *Academy of Management Journal*, 39 (5), 1154-1184.
- Anusas, M. and Ingold, T. (2013) Designing environmental relations: from opacity to textility. *Design Issues*, 29 (4), 58-69.
- Artspace. (2014) [Website] Available from: <http://artspace.org.nz> [Accessed: 18 May 2014]
- Bain, A.L. and Nash, C.J. (2006) Undressing the researcher: feminism, embodiment and sexuality at a queer bathhouse event. *Area*, 38 (1), 99-106.
- Bardini, T. (2011) *Junkware*. Minneapolis: University of Minnesota Press.
- Basset-Jones, N. (2005) The paradox of diversity management, creativity and innovation. *Creativity and Innovation Management*, 14 (2), 169-175.
- Bauman, Z. (2004) *Liquid Modernity*. Cambridge: Polity.
- Berardi, F. (2009) *Precarious Rhapsody: Semiocapitalism and the pathologies of post-alpha generation*. London: Minor Compositions.
- Boden, M.A. (1994) *Introduction*. In Boden, M.A. (eds.) *Dimensions of Creativity*. Cambridge: The MIT Press.
- Brandes, U., Stich, S. and Wender, M. (2009) *Design by Use: The Everyday Metamorphosis of Things*. Basel/Boston/Berlin: Birkhauser.
- Camazine, S., Deneubourg, J.L., Franks, N.R., Sneyd, J., Theraulaz, G. and Bonabeau E. (2001) *Self-Organization in Biological Systems*. Princeton: Princeton University Press.
- Carse, J. P. (1986) *Finite and Infinite Games: A Vision of Life as Play and Possibility*. London: Penguin Books.
- Certeau, M. (1984). *The Practice of Everyday Life*. Berkley/Los Angeles/London: University of California Press.
- Cheng, X. and Berthelsen, C. 2014. [Website] Available from: <http://making-do.tumblr.com/> [Accessed: 18 May 2014].

- Eckert, L. (2011) *Post(-)anarchism and the contrasexual practices of cyborgs in dildotopia: Or, 'the war on the phallus'*. In Heckert, J. and Cleminson, R. (eds.) *Anarchism & Sexuality: Ethics, Relationships and Power*. New York: Routledge.
- Elliot, M. (2006) Stigmergic collaboration: The evolution of group work. *M/C Journal*, 9 (2). Available from: <http://journal.media-culture.org.au/0605/03-elliott.php>. [Accessed: 18 May 2014].
- Franck, K.A. and Stevens, Q. (2008) *Loose Space: Possibility and Diversity in Urban Life*. Oxon: Routledge.
- de Freitas, N. (2008) Imperfect in-formation: The prospect of material thinking. *Studies in Material Thinking*, 1 (2), 1-12.
- Gatt, C. and Ingold, T. (2013) *From description to correspondence: anthropology in real time*. In Gunn, W., Otto, T. and Smith, R.C. (eds.), *Design Anthropology: Theory and Practice*. New York and London: Bloomsbury.
- Galloway, A. (2007) *Seams and Scars, Or How to Locate Accountability in Collaborative Work*. In Brickwood, C., Ferran, B., Garcia, D., and Putnam, T. (eds.), *Uncommon Ground*. Amsterdam: BIS Publishers.
- Gibson, J. J. (1979) *The Ecological Approach to Visual Perception*. Boston, MA: Houghton Mifflin.
- Guggenheim, M. (2011) Formless discourse: the impossible knowledge of change of use. *Candide*, 4, 9-36.
- Hamano, S. (2012) The generativity of Nico Nico Douga: the new type of creativity enabled by metadata. *Genron: Portal for Critical Discourse in Japan*. [Online] Available from: <http://global.genron.co.jp/2012/05/14/the-generativity-of-nico-nico-douga/>. [Accessed: 18 May 2014].
- Hatchuel, A. and Weil, B. (2003) A new approach of innovation design: an introduction to C-K theory. *International Conference on Engineering Design*. ICED 03 Stockholm, August 19-21. Available from: http://www.designsociety.org/download-publication/24204/a_new_approach_of_innovative_design_an_introduction_to_c-k_theory [Accessed: 18 May 2014].
- Henry, K. (2007) The shape of things: Vilém Flusser and the open challenges of form. *MX Design Conference 2007 Form + Desire: <Linked Projects> potencial*. *International Design Conference*. October 29th, 30th, 31st, 2007. Universidad Iberoamericana, Santa Fe, Mexico City, Mexico. Available from:

- http://www.dis.uia.mx/conference/2007/ponencias/kevin_Henry_Shape.pdf . [Accessed: 18 May 2014].
- Hui, Y. (2013) Archivist manifesto. Metamute [Online]. Available from: <http://www.metamute.org/editorial/lab/archivist-manifesto>. [Accessed: 18 May 2014].
- Huizinga, J. (1955) *Homo Ludens: A Study of the Play-Element in Culture*. Boston: Beacon Press.
- Ingold, T. (2008) *When ANT meets SPIDER: Social theory for arthropods*. In Knappett, C. and Malafouris, L. (eds.), *Material Agency Towards a Non-Anthropocentric Approach*. New York: Springer.
- Ingold, T. (2009) *Against space: Place, Movement, Knowledge*. In Wynn Kirky, P. (eds.) *Boundless Worlds: An Anthropological Approach to Movement*. New York and Oxford: Berghahn
- Ingold, T. (2011) *Being Alive: Essays on Movement, Knowledge and Description*. London and New York: Routledge.
- Kilbourn, K. (2013) *Tools and movements of engagement: design anthropology's style of knowing*. In Gunn, W., Otto, T., and Smith, R.C. (eds.), *Design Anthropology: Theory and Practice*. New York/London: Bloomsbury.
- Kimbell, L. (2009) Beyond design thinking: Design-as-practice and designs-in-practice. Paper presented at the CRESC Conference, Manchester, September 2009. Available from: http://www.inovacaoedesign.com.br/artigos_cientificos/beyond_design_thinking.pdf . [Accessed: 18 May 2014]
- Lawson, B. (2004) *What Designers Know*. London and New York: Routledge.
- Levi-Strauss, C. (1966) *The Savage Mind*, trans John Weightman and Doreen Weightman. Chicago: University of Chicago Press.
- Miller, P. (1987) *Substantial process philosophy*. In Krettek, T. (eds.), *Creativity and Common Sense: Essays in Honor of Paul Weiss*. New York: SUNY Press
- Mol, A. (2010) Actor-network theory: sensitive terms and enduring tensions. *Kölner Zeitschrift für Soziologie und Sozialpsychologie*, 50 (1), 253-269.
- The New Zealand Herald, (2014) *Wynyard precinct: a space where magic can happen*. May 4, 2014. Available from: http://www.nzherald.co.nz/business/news/article.cfm?c_id=3&objectid=11212881 [Accessed: 18 May 2014]
- Nicholson, S. (1972) The theory of loose parts: an important principle for design methodology. *Studies in Design Education Craft and Technology*, 4 (2), 5-14.

- Nonaka, I. (1994) A dynamic theory of organizational knowledge creation. *Organization Science*, 5 (1), 14-37.
- Philpott, R. (2013) Engineering opportunities for originality and invention: The importance of playful making as developmental method in practice-led design research. *Studies in Material Thinking*, 9.
- Piaget, J. (1968) *Genetic epistemology: A series of lectures delivered by Piaget at Columbia University*. New York: Columbia University Press.
- Pye, D. (1978) *The Nature and Aesthetics of Design*. London: Barrie and Jenkins Ltd.
- Resnick, M. (2006) *Computer as Paintbrush: Technology, Play, and the Creative Society*. In Singer, D., Golikoff, R. and Hirsh-Pasek, K. (eds.), *Play = Learning: How play motivates and enhances children's cognitive and social-emotional growth*. Oxford: Oxford University Press.
- Sailer, K. (2011) Creativity as social and spatial process. *Facilities*, 29 (1/2) 6-18. <http://dx.doi.org/10.1108/02632771111101296>
- Scalbert, I. (2011) The architect as bricoleur. *Candide*, 4, 69-88.
- Sennet, R. (2006) *The Culture of the New Capitalism*. New Haven/London: Yale University Press.
- Sennet, R. (2008) *The Craftsman*. New Haven/London: Yale University Press.
- Shove, E. Watson, M., Hand, M. and Ingram, J. (2007) *The Design of Everyday Life*. Oxford and New York: Berg.
- Stevens, Q. (2007) *The Ludic City: Exploring the Potential of Public spaces*. London and New York: Routledge.
- Stiegler, B. (2010) *For a New Critique of Political Economy*. Cambridge: Polity Press.
- Tin, M.B. (2013) Making and the sense it makes. *Studies in Material Thinking*, 9.
- Tsoukas, H. (1996) The firm as a distributed knowledge system: a constructionist approach. *Strategic Management Journal*, 17 (2), 11-25.
- Tuan, Y. (1977) *Space and Place: The Perspective of Experience*. Minneapolis/London: University of Minnesota Press.
- Turkle, S. (2007) *Introduction: The things that matter*. In Turkle, S. (eds.), *Evocative Objects*. Cambridge and London: The MIT Press.
- Turkle, S. and Papert, S. (1991) Epistemological Pluralism and the Revaluation of the Concrete. In Papert, S. and Harel, I. (eds.), *Constructionism*. New Jersey: Ablex Publishing Corporation.
- Wiener, N. (1954) *The Human Use of Human Beings: Cybernetics and Society*. Second Edition. London: Free Association Books.



Designing the Body of Architecture Through Biological Analogies

Jean-Pierre CHUPIN^{*a} and Carmela CUCUZZELLA^b

^a Université de Montréal; ^b Concordia University

Whether seeking out forms, ideas, principles, concepts or images, biology appears as a model and an inexhaustible source for designers at various scales. What do designers strive for when they wave the flag of life and what do they think they will find in the sciences that make it an object of knowledge? Conversely, may we say that biologists demonstrate an equivalent and reciprocal appetite for contemporary architecture? A comparison of the contrasting points of view of three historians namely, Peter Collins, Philip Steadman and George Hersey, whose works span from 1960 to 2000, permits us in the first instance to illustrate the different positions provoked by the influence of biology on ideas in architecture, be that with regards to adhering to, or opposing the phenomenon, or in terms of propagating it in all forms of construction. From the simple formal reference to animal or vegetable kingdoms, all the way to the more unusual transfers of biological and genetic models, the practical and theoretical consequences of these interdisciplinary movements are numerous and particularly poorly understood on a historical level.

Keywords: *Biological analogy; architecture; design; history*

Introduction

The phenomenon of 'biological analogies' in the design disciplines does not fit into the usual categories of art history, especially since the notions of periodization and historical evolution themselves make clear the impact of biological theories on many realms of knowledge: that which Michel Foucault was able to treat with remarkable perceptiveness in his archaeology of the human sciences (Foucault, 1971). In this regard, a comparison of the contrasting points of view of three historians namely, Peter Collins, Philip Steadman and George Hersey, whose works span from

* Corresponding author: Jean-Pierre Chupin | e-mail: jean-pierre.chupin@umontreal.ca

1960 to 2000, permits us in the first instance to illustrate the different positions provoked by the influence of biology on ideas in architecture, be that with regards to adhering to, or opposing the phenomenon, or in terms of propagating it in all forms of construction.

The juxtaposition of these three positions, which are difficult to reconcile, must begin with a critical history of analogy as taken up in the pioneering work of Peter Collins (1965). A reading of his argument, from the perspective of contemporary theories of analogy, reveals that his comments on the 'fallacious' character of the modern biological analogy rests on a quasi-judicial interpretation of aesthetic judgment in which analogy, summarily defined, plays the role of scapegoat for a critique of modernity. A concise definition of analogy also cuts across the morphological evolutionism advocated by the design theorist, Philip Steadman (1979). Here it plays the role of interdisciplinary catch-all, sometimes finding itself confused with biology, sometimes left to its own theoretical misfortune without real epistemological recognition. By contrast, the work of art historian George Hersey (1999) offers a quasi-symmetrical counterpoint to the positions held by Collins and Steadman. With regards to that which he calls 'the biological roots of architecture,' Hersey does not hesitate to render biology the universal key of all analogies. If Collins charges analogical thinking with the ills of modernity, and if Steadman takes biology as a natural source of inspiration for approaches to architectural design, Hersey over-values biology in an argument on 'animal builders' that draws from evolutionary biologist Richard Dawkins' concept of the 'extended phenotype.' For Hersey, spreading the principle precisely to the entire generic sphere of built environments, biology is no longer a simple repertoire of ideas and forms: it becomes the scientific paradigm for all historical and aesthetic interpretations of architecture. To state that this last position could only inspire controversy would be a euphemism.

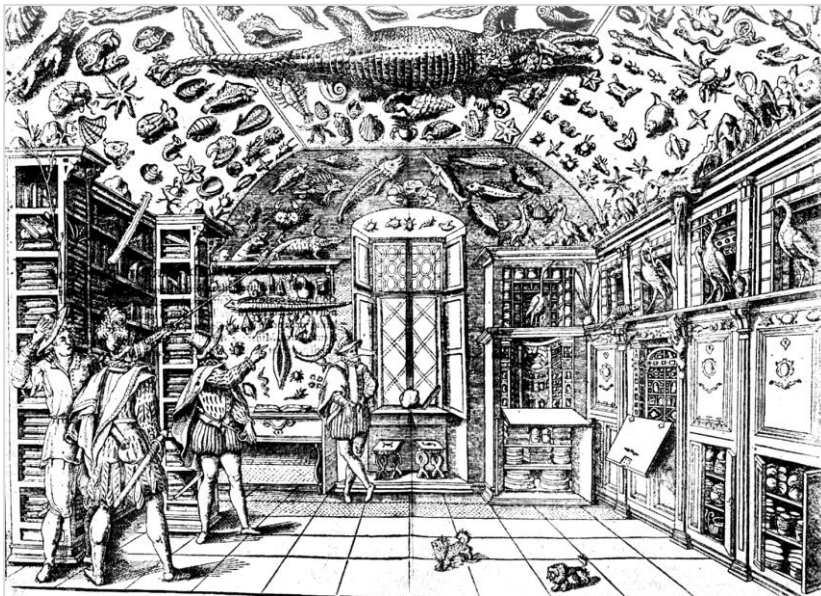


Figure 1 *The Museum of Ole Worm* (1655).

Peter Collins And The Biological Analogy

In *Changing Ideals in Modern Architecture, 1750-1950*, published for the first time in 1965, Peter Collins exposes not merely a history of built works but a history of architectural ideas deployed over a period spanning from the Enlightenment to the end of the Second World War. In his own words, Collins attempted to relate the ideals of modernity – functionalism in particular – to their analogical correspondences within a variety of fields described tellingly, as ‘foreign’ to architecture. The four chapters that are of interest here are entitled:

14. The Biological Analogy
15. The Mechanical Analogy
16. The Gastronomomic Analogy
17. The Linguistic Analogy

For Collins, Modern architects, having taken note of the dead end of ‘revivalism’, found that to channel their need for originality there was nothing left for them but to follow the path of ‘functional analogies’. The historian orders these analogies according to four registers: 1) living

organisms; 2) machines; 3) bodily functions and taste; and 4) speech. He clarifies:

'It is clear that these analogies were not an ideal in themselves; but Functionalism was, and this eventually became the most important ideal of modern architecture.' (Collins, 1965, p. 146)

Insistent on their instrumental role and their potential to serve as justification of the functionalist ideal, Collins bases his historical and critical argument on one conviction: the analogical approach, whatever may be the field of reference on which it operates, would be a source of errors and fallacious reasoning. This declaration appears to be exaggerated and only a close examination of his argument enables us to identify the guiding principles and origins of his criticism of the analogical process. This hypothesis is first developed in 1959 in an article published in *The Architectural Review* that coined the expression, 'Biological Analogy'. The subject of this initial publication became a key chapter in *Changing Ideals* in 1965. In hindsight, it now appears that this text was constructed to serve as an accusation in a case against the modern reasons governing form. It is also clear that of the four sources of functionalism thus qualified (biology, mechanics, linguistics and gastronomy), the analogies termed mechanical seemed to him, properly speaking, to be improper and impertinent, outside of the field of disciplinary knowledge. A close reading, however, confirms, that his relationship to biology remained tinted with ambivalence. When we compare what he describes as the positive and negative points of each of these domains for architecture, biology comes in equal to gastronomy, which is presented as promising but as lacking in architectural examples. The biological analogy, however, would contribute to a tendency on the part of historians to focus on periodization:

'[...] the great harm done by the biological analogy was that it substituted the criteria of evolution for the criteria of aesthetic judgement, whereby architectural historians were no longer concerned with whether a building was good or bad, but simply how it was to be classified chronologically.' (Collins, 1965, p. 157)

On the whole, Collins shows himself to be more nuanced with regards to the influence of the life sciences. The reason for this leniency is provided in the first sentences of Chapter 14 'Biological Analogy', because it is precisely the emergence of biological functionalism in architecture that he aligns with

the genesis of modernity around 1750, according to a theory that is presented as an original contribution on his part. In support of this interpretation, we remark that he never fails to emphasize the inappropriateness of architects who anachronistically adopt concepts and methods of biology, still in its infancy. As the centrepiece of his accusations, Collins brings forth the theses of Herbert Spencer, who compared the growth of crystals to that of living organisms. These ideas will no longer have a scientific basis when they come to mark, in an irreparable way, the imagination of Louis Sullivan (figure 2) and that of his student, Frank Lloyd Wright, whose organic architecture rests on transfers between incongruous sets of knowledge. If this comment makes sense from the point of view of the history of science, it is however insufficient to take account of the place occupied by these two great American figures in the history of architecture.

But Collins ventures forth on a different front, namely, that of the construction of a system of judgment. An implicit process cuts across the chapter on biology and advances, in essence, that in their casual uses of biological knowledge, architects would be at best late, and at worst, in error.

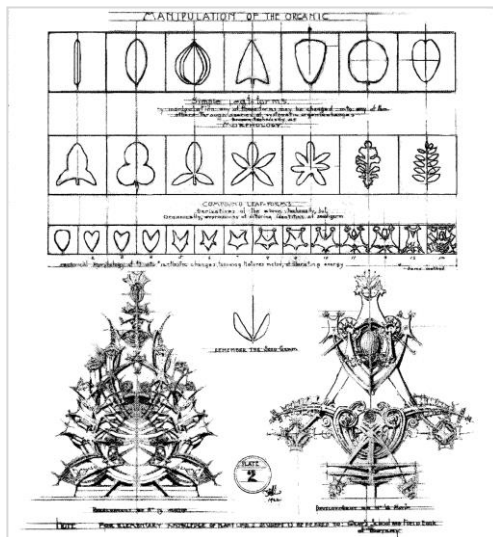


Figure 2 A plate summarizing the principles of the manipulation of forms in plane geometry. Louis H. Sullivan, A System of Architectural Ornament According with a Philosophy of Man's Powers (1924).

In this unequivocal rejection of the process of bringing resemblances into relation with one another, we will not fail to recognize many characteristics

of positivism. On the whole, the bulk of his argument seeks to prove that on numerous occasions, modern functionalism would be recognized in concepts *a posteriori* through analogical justifications. In legal-sounding language – Collins' confessed passion – we should moreover, speak of 'defenses' more than causes. It is a form of guilt coupled with dubious association in which certain references are permitted while others are not, analogy here shares the blame with biology. To grasp the degree of the internal contradiction of such an understanding of analogy, we will appreciate the end of his chapter on the mechanical analogy where, within an even more virulent critical movement he offers unexpected praise:

'One great advantage of the biological analogy was that it laid particular emphasis on the importance of environment, since clearly all living organisms depend on environments for their existence, and constitute in themselves environments, which influence other organisms nearby.' (Collins, 1965, p. 166)

In this very possibility of a correlation between invention, intention and inventory, in which architectural discourse may be constitutive and not merely explicative, Collins will put into practice his own mode of analogical reasoning in a performative fashion, while, on the whole, refusing to grant it the aesthetic judgments of modern architects, with the sole, but understandable, exception of Auguste Perret.

In other words, Collins' argument is representative of a certain positivism refusing, in a contradictory fashion, the heuristic role of analogy within the framework of architectural knowledge, while readily conceding that it is part of scientific knowledge. We would understand too, that his interpretation of architectural intentions presents all the characteristics of a sophism: 1) the analogies of functionalism are nothing but *a posteriori* justifications, meant to legitimate ideals; where 2) functionalism did not attain its ideals; therefore 3) analogies are dangerous procedures.

Philip Steadman And The Evolutive Design Of Artifacts

Ironically, in the same way that the works of Louis Sullivan and of Frank Lloyd Wright continue to influence the history of architecture, in spite of the fact that they also drew from some erroneous theories formulated by Spencer, the critical success of Collins' arguments on the biological analogy persist, in spite of the axiological biases and the epistemological

inconsistencies that should have limited their impact. We can measure the widely known influence in a work dating from 1979 and republished in 2008 thanks to a renewed interest among architects for the wonders of biology. In recognizing the importance of the work of Collins, the book by Philip Steadman entitled *The Evolution of Designs* does not however, make analogy a scapegoat for a critique of modernity, but rather establishes it as key to the evolution of built forms, whether these belong to architecture or not. Given the generic character of the word 'design' which denotes simultaneously, concepts of ideation and formalization within various disciplines of creation, the author sketches out a general theory of artificial forms, based largely on principles in use in the domain of natural forms. If the meaning of the subtitle, 'biological analogy in architecture and the applied arts' is unambiguous, understanding the title is more vague since the concept of evolution is at this point so embedded into common language that we easily forget its biological background. Certainly there are countless books on art history that seek to transfer the principle of evolution to fields dependent on human and not natural creation, and from this point of view the designation 'applied arts' certainly displays a didactic interest in the study of nineteenth-century art. But Steadman's real preoccupation lies elsewhere. As he states in his Introduction: 'My purpose [...] is to show what I believe to be useful and valuable in such analogies, and to show what I believe to be dangerous and pernicious.' (Steadman, 1979, p. 1).

The question of the organic nature of architectural forms exemplifies the influence of the new biological science on the theory and practice of architecture since the beginning of the nineteenth century. In a judicious manner, Steadman devotes his first chapter to what seems to him to be a historic development necessary to distinguish the biological analogy from the ancient organicism inherited from Aristotle. Yet, in a way that is surprising for a work that is so well researched, Steadman never provides us with a definition of the term. Even as he reviews the Aristotelian and organicist principles between nature and the arts, the notion of analogy remains generic. Moreover, although he does not fail to comment at some length on the effects of the theories of Geoffroy Saint-Hilaire and those of Cuvier concerning the doctrines of architecture and the applied arts, it is surprising to see him neglect a major point of this famous opposition, that being the distinction between analogy and homology. The theoretical divergences between Saint-Hilaire and Cuvier, concerning which we know to what extent they animated learned circles in the middle of the nineteenth

century, correspond in effect to two definitions having major implications in biology. It is worthwhile to remember the issues at stake.



Figure 3 A comparison of the wings of the pterodactyl, the bat and the bird. For Cuvier, these three wings are analogues not homologues. The figure shows the radical differences in their structures. Taken from G.R. Taylor, The Science of Life (1963), p.142.

For Geoffrey Saint-Hilaire (1772-1844), analogy defines the relationship between two organs that in different beings have the same placement and above all, the same connections. The canonical example invoked is that of the analogy between the arm of man and the wing of a bird. For Saint-Hilaire, the analogues may have different functions. For Cuvier (1769-1832) and the majority of nineteenth-century biologists, however, analogy defines first and foremost the character of organs having the same function. In this regard, the arm of a man and the wing of a bird are not analogues, but rather homologues. That is to say, that they actually have the same origin, but as a result of divergent evolution, their exterior form is different. Against homological discrepancies would be opposed the convergence of analogical evolution. Analogous organs may have a similar exterior form, like the wings of birds and those of insects. They may exercise the same function but do not have the same embryonic origin (figure 3). By contrast, the homologue characterizes the function of elements belonging to different systems or to

different parts of the same structure, and in this way, we understand that its correspondences are much more measured and restrained than those forged by analogy.

If the notion of homology, as defined and defended by Etienne Geoffrey Saint-Hilaire, will allow for new movements between embryology and comparative anatomy, and if it leads him to defend the transformism of Chevalier de Lamarck against the fixity of Cuvier, it remains the case however, that the theories of Cuvier will exercise more influence on architects and artists. Beyond the particular case of biology, the problem of the levels of intervention of analogical thinking was in fact already at issue at the time of Cuvier and Saint-Hilaire. For there, where a modern biologist will not see an analogy between an arm and a wing, even the least talented of poets or architects could always see in that a correspondence that satisfies them and, more importantly still, that would seem to them relevant to design or to explain their project. It is this in a way that will fascinate Goethe from the end of the eighteenth century, and which will inspire in him the morphological theories that played a decisive role, even if they were not always scientifically based.

Philip Steadman's marked interest in the question of morphology leads him to make repeated use of D'Arcy Thompson's book of 1917, *On Growth and Form*, particularly in terms of its visual demonstrations. This concerns another crucial reference that was overlooked by Collins and, in this specific case is an unforgivable omission, since, as Steadman justly remarks, the work of D'Arcy Thompson exercised a considerable influence on many generations of architects. If certain theorists were inspired by anatomy to draw analogies for problems of construction, Thompson is known for having performed stunning parallels between mechanical structures and vegetal fibres as well as animal skeletons. Famous didactic plates establish relationships between bone structure and lattice beams. Others show the fossil of a bison skeleton and diagrams of cantilever bridges. D'Arcy Thompson said he used these analogies so that anatomists could, in exchange, learn certain engineering lessons from the Forth Bridge. This is a disciplinary reversal that starts from engineering and architecture in order to better inform biology through a complimentary movement, that assumes a particular interest from the point of view of an investigation into the analogical reciprocity of forms of knowledge.

Steadman's study inserts itself naturally, therefore, in a series of works on the history of the biological analogy, as much for its documentation and analysis as its adherence to certain fundamental concepts in the life sciences.

Contrary to Collins, who scarcely ventures into twentieth-century biology, Steadman follows the latest developments in evolutionary science, convinced yet fearing – with full knowledge of the facts – the dangers of involution.

George Hersey And The Biological Roots Of Architecture

Published in 1999, the book *The Monumental Impulse: Architecture's Biological Roots*, by the American art historian George Hersey, completes our trilogy of works on the biological analogy. It is a trilogy, not an isosceles triangle, because Hersey's argument distinguishes itself from the preceding two in that it does not consider biology as a source of metaphors but rather, as the basis itself of a history of architectural form, which he elaborates according to a process akin to a socio-biology or, in this case, a 'biohistory'. In contrast to Collins and Steadman, the analogical process for Hersey is not the object of accusations or questions, but rather is constituted as a mechanism of scientific proof in which visual comparison plays a paramount role.

Abundantly illustrating the hypothesis of an instinct for building that humans share with certain animals, Hersey develops the claim that:

'[...] the shapes of our monumental shelters, whether bicycle sheds or cathedrals, reflect and often derive from the shapes first created by these other species – species that, like us, are subject to the monumental impulse.' (Hersey, 1999, p. xviii)

By integrating architecture into all major natural functions, the book crosses a line that neither of the previously examined authors dared to do. Hersey weaves together connections between the bio-architectural analogy on the one hand, and the notion of the 'extended phenotype' on the other.

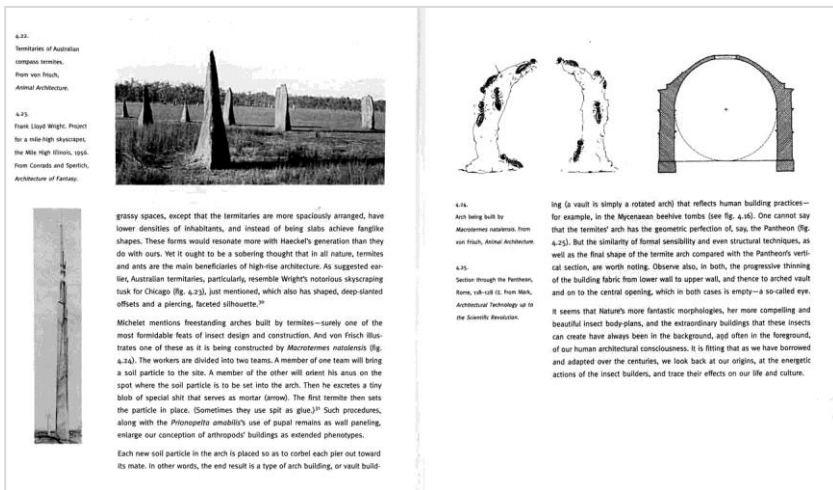


Figure 4 As the Mile High Skyscraper by Frank Lloyd Wright (1956) is to a vertical Australian termitary, so is the vaulted structure of the *Macrotermes natalensis* to the schematic section of Hadrian's Pantheon in Rome (c.125 CE). A visual argument and page layout taken from George Hersey, *The Monumental Impulse* (1999), pp. 76-77.

Let us begin with the bio-architectural analogy, which as it so happens, is a more precise expression than the 'biological analogy'. It is no longer relevant to regret the absence of a definition of analogy, for Hersey mobilizes first and foremost, the intrinsic logic of homology, developed to the point of it containing the originality of his comments:

'Though many people have written about animal architecture, no one, so far as I know, has broached the question of homologous evolution in the sense given above. Nor have others gone into the related question of architectural reproduction and evolution. Nor, finally, has anyone investigated other similarities with human architecture – homologies, convergences, or parallels – that can be traced from molecules to landscape and on to the cosmos.' (Hersey, 1999, p. xviii)

Here, the intellectual project is no longer about collecting, let alone criticizing, some of the sources of architectural imagination, but rather about imagining and arguing for an organic connection. It is truly the

'biological roots of architecture' that this book seeks to highlight, according to a table of contents that would fit in nicely in a museum of natural history or in a family encyclopaedia:

- 1 – Molecules, Viruses, and Cells
- 2 – Leaves and Flowers
- 3 – Shells
- 4 – Insects
- 5 – Birds
- 6 – Mammals: Territory and Reproductive Rights
- 7 – Penis Paradigms
- 8 – The Female Genital Palace
- 9 – The Biology of Architectural Reproduction

To successfully support his argument, Hersey chooses to saturate it with exemplary cases, mobilizing an impressive repertoire of parallels operating at different visual and textual registers (figure 4). It is an elaboration, which he acknowledges, does not fall within scientific proof, all while underscoring that undeniably, humans possess an impressive instinct for building, whether it be genetic, learned or both, and that this instinct is shared with other species. If Hersey takes moderate recourse to the term analogy, nevertheless, he makes systematic use – even abuse, depending on the reader's level of tolerance – of the possibilities of invention, of illustration and of reasoning that analogical thinking authorizes at the various levels of knowledge. In fact, in Hersey's argument, analogy finds itself assimilated into a great principle of life, at the basis of the monumental impulse itself. That which surfaces in Steadman, here serves as the rule.

As well, in the chapter on shells, we are not surprised to encounter the now inevitable reference to the so-called organic architecture of Antoni Gaudí (1852-1926). Taking as an example the slender towers of the *Sagrada Família*, adorned with multiple vegetal and animal figures, the questioning sows doubt: do these forms issue from the Catalan genius? Would they not be borrowed initially from the ingenuity of a shell, the *Terebra maculata*, the superb black-spotted cone? Without much hesitation, Hersey endorses the organic interpretation, taking as proof a famous photograph taken by Juan Matamala, a personal friend of Gaudí, showing a vertical set of shells, in which the composition evokes the architecture of the project for the Franciscan Mission in Tangier (1893) to the extent that it is hard to tell them apart, and of course, that of the *Sagrada Família* and its eighteen towers projecting towards the sky (figure 5).

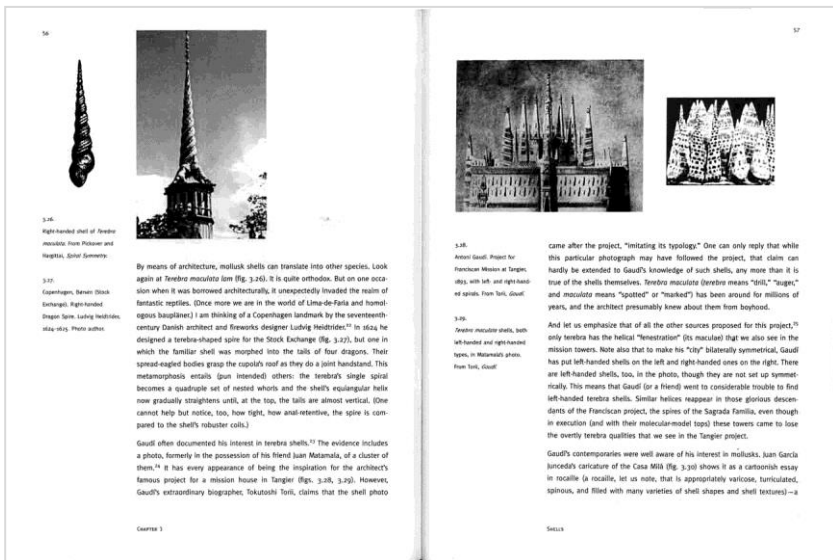


Figure 5 When shells invent church steeples. The right-handed shell of *Terebra maculata* is to the right-handed spiral tower of Copenhagen's Stock Exchange by Heidehøj (1624-1625) as the left-handed and right-handed *Terebra maculata* shells are to the left- and right-handed spirals of the project for the Franciscan Mission at Tangier by Gaudí (1893). A visual argument and page layout taken from George Hersey, *The Monumental Impulse* (1999), p. 56.

Ought we to attach any importance to this kind of reasoning? In Gaudí's time, comedians were already using it as their material of choice and the caricatures of the *Casa Milà* prove that if the fantastic forms of molluscs excite the imagination, their organic character is not necessarily a guarantee of consensus. We may however admit that an organicist interpretation would be satisfied by the formal resemblance between the shells' oblong spirals and the towers of Gaudí's project at Tangier, especially since the windows seem to echo the spots that wind around the spiral of the *Terebra maculata*. It is indeed tempting to make this the model of reference for the morphology of the imposing, vertically growing arrows of the cathedral of Barcelona.



Figure 6 A general view of the church of the Sagrada Família in Barcelona.
Photograph by Izabel Amaral (2008).

But for Hersey, the issue would not be a question of vague similarities because he deems the shells to be the true biological roots of Gaudí's architecture. Against his argument, we can already oppose the possibility of understanding analogy in its equivocality and not only in the straight line of a kind of univocality. For it is clear that the strength of analogical thinking resides in its capacity to integrate a multitude of inevitably heterogeneous references, making them converge into the same project. What ought we to make, for example, of this reference to shells attested to by a photograph, when certain references evoke more readily the figure generated by the athletic prowess of the Catalan 'Xiquets', the human 'castles' built up by stacking six levels of acrobats who defy the laws of gravity at least as much as the vertiginous towers of the *Sagrada Família*? A diagram, superimposed onto the photograph of these acrobatics reveals the upward striving of the towers of Gaudí's project, especially since the original scheme included eighteen towers, one for each of the twelve apostles, four for the evangelists, one for Mary and one for Jesus. Leaving aside the reference to marine animals, it is indeed the way that Salvador Dalí, commenting on this

specific case in an affirmative and atypically realistic manner speaks of a specific dimension of Catalan spirituality that has expressed itself for a long time in the performances and the incredible feats that punctuate these major religious festivals (figure 7). For the Catalan surrealist, these exalted performances would in fact constitute the most profound mystical references of the *Sagrada Familia*.



Figure 7 The human tower of the Catalan Xiquets in Tarragone. Photograph by Luciana Carvalho Gomes (2004).

Therefore, is it the shell or the human tower that is the most incongruous and consequently, the most pertinent of the two references? Should priority be given to the naturalist or to the culturalist interpretation? The answer to this dilemma, anticipated by Hersey but quickly swept aside rhetorically, is based primarily on the photograph of the shells. The fact that it was taken after the project was designed, according to the argument of one of Gaudí's biographers, Tokotoshi Torii (1983), does nothing to deter the art historian: on the one hand, the architect knew of the shells since his childhood, and on the other, these shells have existed for millions of years, long before so much as the idea of the Catalan master's architecture. In short, the animal clearly preceded the architect!

Life Cycles Of Biological Analogies

What lessons can we draw from the difficulties encountered by the approaches analyzed in this first study? With Collins, we have taken stock of the (theoretical) damage occasioned by the abrupt passage from the historical inventory of analogies to the systematic rejection of the process of analogical thinking. In particular we have seen how confusion is generated covertly between the identification of a theme (i.e., mechanics, gastronomy, biology, etc.) and historical periodization. Furthermore, it is primarily the relevance itself of invention by analogy that is called into question, although done in an indirect fashion within the framework of a general critique of modernity. This will be a theoretical constant in the work of Collins: in the 1960s he contended that modern architecture had strayed into 'foreign realms' such as biology; in the 1980s he opined that postmodern architecture had gotten lost in linguistics. Thus for Collins, analogy was a major cause of disciplinary degeneracy, the instrument of rejection of the historic legacy of architectural forms: the sign, in other words, of a lack of learnedness.

With Steadman, on the contrary, we are immersed in a favourable receptivity to borrowings of all kinds. The progress of art rests on an abundance of analogies, a principle sign of disciplinary vitality. We note in this regard, that the inventory initiated by Steadman in 1978 is found fully updated in the 2008 edition, proof, according to him, of a proliferation in constant renewal. Therefore, it comes as no surprise that each new application of the biological analogy is examined with relative detachment, according to a distribution faithful to the initial Table of Contents, as if it were beyond all criticism, left to a sort of natural selection. Always dominant, evolutionism is from now on more diversified than it was in 1978, while the importance of morphology is seen confirmed by the introduction of new computer technologies (genetic algorithms, cellular automata, biomimicry, etc.). If, in Steadman's vision, one analogy replaces another and time does its work, it is a very different relation to time that troubles Hersey. His is a 'biohistory' through which the design of architectural forms, as with monumental structures, find themselves pushed to the obscurity of time, to the most distant beginnings of a kind of creative Big Bang.

After this historical overview we are perhaps better prepared to face the contemporary period, because the turn of the twenty-first century is rich in signs announcing a revival in borrowings from the life sciences. Whether with respect to seeking out forms, ideas, or principles, or whether having to do with an operative vocabulary, concepts or images, biology appears as a

model and an inexhaustible source. It is certainly one of the main sources of reference for many architects and designers, and as a result, deserves a prominent place in a critical history of analogy in the design disciplines.

References

- Collins, P. (1965) *Changing Ideals in Modern Architecture, 1750-1950*. Montreal: McGill-Queen's University Press.
- Collins, P. (1971) *Architectural Judgement*. Montreal: McGill-Queen's University Press.
- Descharnes, R. and Prévost, C. (1971) *Gaudí: The Visionary*, ed. George Collins. New York: The Viking Press.
- Foucault, M. (1971) *Les mots et les choses: une archéologie des sciences humaines*. Paris: Gallimard.
- Hersey, G. L. (1999) *The Monumental Impulse: Architecture's Biological Roots*. Cambridge, MA: The MIT Press.
- Steadman, P (1979) *The Evolution of Designs: Biological Analogy in Architecture and the Applied Arts*. Cambridge: Cambridge University Press.
- Thompson, D. W. (1917) *On Growth and Form*. Cambridge: Cambridge University Press.
- Torii, T. (1983) *El Mundo enigmático de Gaudí: cómo creó Gaudí su arquitectura*. Madrid: Instituto de España.



Are Open Innovation processes structured for disturbance?

Jan ECKERT^{*a}, Lukas SCHEIBER^b and Peter SCHWEHR^a

^a Lucerne University; ^b Kocher & Scheiber GmbH

The paper enters into the question, whether Open Innovation is stable enough to withstand disturbance caused by continuously changing contexts in technologies, behavior and institutional aspects. Open Innovation, which by its spread across different domains such as new technologies, software engineering or design, has become a disruptive element amongst different approaches in innovation and now faces giant networks and markets which all become potential competitors one to another. Thus the question rises whether Open Innovation will withstand this competition compared to classical innovation frameworks. In order to determine which could be strategies for Open Innovation Platforms within this competition, the paper examines two aspects of these systems: firstly their openness or 'unfinishedness' in terms of their output and secondly the way they deal with deal with disturbance. The first aspect will be met by making a comparison with Umberto Eco's definition of 'unfinishedness' stated in his Opera Aperta. The second one will be discussed by attempting a transfer of Nicholas Thaleb's concept of 'The Antifragile' – an examination of how different systems deal with its stressors and disturbance.

Keywords: Open Innovation; disturbance; opera aperta; antifragility

Introduction

Whilst in the past innovation processes mostly had their origin in the urgent need of an industry or organization to be more advanced than its competitors were, after the Open Innovation turn we find approaches to innovation which could be described as a collective's attitude towards the creation of new knowledge allowing its members to convert this knowledge into new products and services. Especially in the design domain - as a rather young one - Innovation processes have shifted from being industry-driven and product-oriented towards frameworks which are afforded by „open

^{*} Corresponding author: Jan Eckert | e-mail: jan.eckert@hslu.ch

communities' dedicating themselves to the creation of (open) platforms by involving a vast collective of actors. These platforms are structured to contain all necessary products and services in order to *enable people to create value according to their individual needs*, as Nicola Morelli states in his paper on Social Innovation (Morelli, 2007)

At the same time the roles of the actors which are involved into Open Innovation processes are about to change drastically after the shift from a top-down approach towards a bottom-up one. Innovation is becoming less and less an author- or owner-driven process and is changing much more towards a collective one, based upon the knowledge and ability of an 'innovative community'. While the former product has turned into an open platform, the role of producers has shifted towards co-producers aiming at the development of their individual solutions. The future task of companies and organizations becomes the *organization of the overall value* of such platforms (Morelli, 2007).

Nevertheless the evolution innovation processes are undergoing doesn't end here. And neither is it the first time applied sciences or arts - just as design - are facing such a mutation regarding their way and processes to generate outputs within a wider context of technological, behavioral and institutional change. If we think of what transformation art has gone through during past century or the many variations of creating music have evolved, the question rises whether design or other young domains are about to meet similar changes and transformations that art, literature and music have already done some decades before. Therefore a comparison will be made between Open Innovation processes and some characteristics of the *Opera Aperta*, an examination of artworks and arts published by Umberto Eco in 1962.

By opening up, innovation processes also became easy targets for disturbance which might be caused by various stressors. And just because of their low hierarchy structure, for companies or organisations it has become much harder to keep control over the actual output of these processes and platforms (von Hippel, 2005). Therefore many companies still try to stick to the former top-down approach or try to turn their existing processes into hybrid forms of classical and Open Innovation processes (Manzini, 2014). By examining the example of two different approaches in motorcycle manufacturing, we will further discuss these different approaches.

The question, how Open Innovation platforms deal with the stressors they are exposed to is probably one of the central concerns next to the questions about ownership and value. Many companies might still hesitate

to open up their innovation processes because of their doubt whether something open is robust or resilient enough to fit the companies' quality and process management. Nassim Nicholas Taleb, whose reflection on unpredictable events became famous through his book 'The Black Swan' (Taleb, 2007), further examined the way different systems meet stressors by applying strategies of robustness or resilience. In his last publication 'The Antifragile: Things That Gain from Disorder' (Taleb, 2012) he outlines the very opposite of meeting fragility with robustness by defining the term *Antifragility*. The paper reaches out to transfer Talebs concept of the *Antifragile* in order to raise the discussion whether it might generate new strategies for Open Innovation processes.

Openness - Opera Aperta – the 'unfinished work'

The first hypothesis considers that Open Innovation Platforms tend to generate outputs which are characterized by a certain degree of unfinishedness. This unfinishedness turns into a quality at the point when it starts offering a higher potential of being modified and re-interpreted by the future co-producers than finished products. Consequently unfinishedness should imply a higher potential for improvement and innovation. At the same time the main quality of a product shifts from its final definition towards its openness for configuration, interpretation and modification.

Umberto Eco's concept of the *Opera Aperta* (Eco, 1962) embraces human artifacts or creations (such as artworks, musical compositions, performances ect.) which are qualified by their 'unfinishedness'. The fact that these creations are not finally defined, gives them an additional openness towards the beholders perception, interpretation or use. Compared to the classic defined artefact or product, the *Opera Aperta* has the capacity of being 're-created' each time a new beholder or user starts interacting with. The momentary aspect of Eco's *Opera Aperta* which emanates from the fact that it aims at future 'recreations' not only opens up the entire process of creating 'open works' towards future co-creators (Morelli, 2007) but also to the aspect of time.

Another dimension which gets added to the creation of artefacts or works by the aspect of 'unfinishedness' is the author's or initiator's possibility to integrate or intentionally design an 'invitation' for future interaction or better 'participation of the user' into the work itself. And other than the well-known concept of affordances (Gibson, 1977), this 'call for participation' does not specifically define the interpretation of a work in

terms of function or meaning, it leaves it truly open to the user. In point of fact it is the *Opera Aperta's* 'unfinishedness' which articulates this 'invitation'.

At this point also the initial creator, the author, takes a step back from his or her creation – the work becomes much more a 'creature of its own' which evolves by each and every future interpretation or modification. By doing so the author also exposes the work to a certain risk of being misinterpreted or even ruptured by the future development of the work. An aspect which compares to the risk, Open Innovation is exposed too.

Compared to Open Innovation, the three aspects of Eco's *Opera Aperta* which have been described, might be exactly what happens to concern most companies while talking about Open Innovation Processes. The first one, 'Unfinishedness', is certainly nothing a company wants to stand for when talking about its products. Secondly, momentariness, or the fact that a product might work only for a certain amount of time cuts back the companies' potential to create value. And thirdly the exposure of a product to future interpretation or even misinterpretation consequently results in a loss of control over the products future quality (von Hippel, 2005).

So according to the first hypothesis made, Open Innovation might offer a higher potential for future innovation when providing a level of unfinishedness regarding its outcomes. At the same time by doing so, the products generated get exposed to a higher potential of changing or losing their initial quality.

Dealing with disturbance – the Antifragile

Closed Innovation tends towards meeting disturbance with a high level of robustness in order to preserve their original form and output generated. Open Innovation has the possibility to meet disturbances with an ability to adopt, modify and transform. Each disturbance might lead to an evolution of the product when learning by the clash caused by the disturbance. The second hypothesis states that Open Innovation Platforms have the potential to become real antifragile systems which acquire more qualities with every disturbance of the system itself. By doing so also their potential for further innovation increases.

Antifragility is beyond resilience or robustness, The resilient resists shocks and stays the same; the antifragile gets better. (Taleb, 2012)

While most systems try to become more resistant against external disturbance, they also take the risk to get stuck in the procedure of maintaining a high level of closeness and control. In the case of Innovation Processes this also might lead to a decrease of the potential to generate innovative output. The reason why many companies tend towards doing so is that first and foremost disturbance is defined as something negative. In his definition of the *Antifragile*, Taleb states that *the antifragile loves randomness and uncertainty, which also means – crucially – a love of errors, a certain class of errors* (Taleb, 2012). This positive attitude towards failing is something that at the first glance might appear contradictory and counterproductive when talking about generating innovative outputs.

While talking about ‘Innovation Triggers’, in his paper ‘Design Thinking and the Experience of Innovation’, Barry Wylant examines Teresa Amabile’s framework for creativity described in her ‘The social Psychology of Creativity’ (Amabile, 1983). One of the aspects described within the group of skills which are defined as relevant for creativity, is the willingness to take risks’ (Wylant, 2008). This willingness or ‘preparedness’ to meet the unknown and uncertain relates very well to the way Taleb describes one of the advantages of *The Antifragile*. It further also relates to the concept of ‘unfinishedness’ discussed earlier by examining Eco’s *Opera Aperta*. Consequently both, the uncertain and the unfinished might work as triggers for Innovation when embedded into a process with the appropriate openness towards this sort of disturbance.

The second and most important aspect which might improve the way, Open Innovation Processes could be structured in the future, is Taleb’s examination of systems while meeting disturbances on a long term scale. Robustness (as resilience as well) calibrates a system by taking into consideration the most likely and most frequent disturbances. Irregular events which are very unlike to happen are mostly not considered when creating robust or resilient systems. Taleb calls these improbable events or disturbances *Black Swans* since they compare to something we would never think of, that we would never expect. Consequently our capability to deal with these extraordinary events is rather low compared to frequent stressors we are exposed to. Now Taleb’s key to meet even such unlikeable events such as *Black Swans* is the antifragile systems’ ability to evolve and get better every time when clashing with a problem or disturbance. Just as the immune system which gets stronger by building up antibodies when getting stimulated by a virus or a germ.

By transferring Talebs concept to Open Innovation processes it's the readiness to accept the unknown and the unfinished as a challenge as well as acquire the ability to learn from these disturbances in order to reduce the impact of future disturbances. Or in Taleb's word's 'How do you Innovate? First, try get into trouble!' (Taleb, 2012).

The difference between German and Italian motorcycles

Much more than most cars, motorcycles provide users the possibility to modify a large number of the bike's various components. For instance you can improve the performance of the engine by modifying certain parts of it or in the meantime you can even modify the motorcycle's software to do so. Further you can add or substitute many different parts of the bike which would add or change certain other aspects such as, comfort, security, the ability to carry luggage etc. Compared to Umberto Eco's *Opera Aperta* and it's aspect of unfinishedness, we could state, that motorcycles are 'Open Works' or open systems which provide a large number of possibilities for future modification.

In certain cases the bike manufacturers deal with the 'unfinishedness' of their product by offering a variety of optional parts which perfectly fit the original bike and customers may add them directly by configuring their motorcycle before buying it or add them later on. Often a bike manufacturer would team up with other companies too, in order to assure any of the other company's parts would perfectly fit the original bike. At first this procedure appears to offer a certain openness to the customers but in fact by taking control over the availability and quality of the single parts, the company creates a closed system after all. And consequently customers have to buy either the original company's parts or those produced by the authorized suppliers. All this happens because the original manufacturer wants to assure any of the parts, such as the entire motorbike work in a perfect manner. By opening this system the company would lose this control over the quality of their product (comp. von Hippel, 2005) and expose it to disturbance. The described situation is actually what happens, when a German manufacturer decides to produce a motorbike.

The German company's strategy aims at a minimum chance of clashing with stressors or disturbances of their system. Consequently the openness of their system is limited to a certain level (figure 1).

Regular stressors excluded by the German's system could be e.g. safety regulations harmed by an additional part which is not exclusively produced by themselves or one of their contractors. It further could be also a malfunction of the motorbike caused by a modification of the bike by adding low quality parts. By applying Taleb's theory of the *Black Swan* though, any other disturbance which is not taken into consideration by the manufacturer's quality management would have quite a deep impact onto the products entire system. At the same time any improvement of the motorbike or it's parts has to be developed or approved by the company itself. The overall potential for spontaneous and new innovation is rather low in this context since all knowledge and resources remain inside the system.

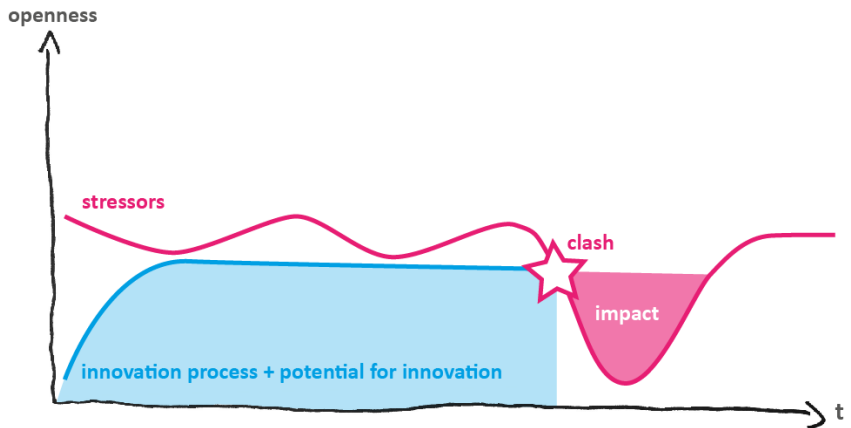


Figure 1 The company driven and controlled process of the German manufacturer.

Since one of the authors is passionate about Italian motorcycles, we will now take a look at an Italian motorcycle manufacturer. A couple of months ago it happened to the author to buy a motorbike manufactured by a very small Italian brand. Consequently the offer of perfectly fitting parts on the market is remarkably small compared to the one described in the German case. And each time he wants (or needs) to change a part of his motorbike, it becomes quite a struggle to find the perfect one. At the first glance the Italian bike must appear as quite a 'Closed System' and the product or offer doesn't seem to be perfect at all. But for once perfection doesn't matter that much, when you're passionate about something. (especially when talking about an italian 1.2 litre V2 engine). Further according to Eco's

'Opera Aperta' the 'unfinishedness' of this product might also stimulate the interaction between this product and its user.

And in fact even though the offer of different bike parts is rather small on the one hand and the problems and malfunctions the author has experienced with his bike are rather frequent on the other one, the level of interaction between him and the motorbike increases with each quest for the solution of a problem.

Within this enduring quest, every time a similar or same defect appears, which has been resolved before, the author instantly knows how to deal with it. Consequently the more problems and defects are offered by the system of his bike, the more he becomes an expert to deal with these problems. Or in Thaleb's words: his attitude of using, getting frustrated, then fixing and modifying his bike makes the entire experience become more and more antifragile. And by doing so, future defects or stressors are less and less likely to have dramatic impacts onto the system (figure 2).

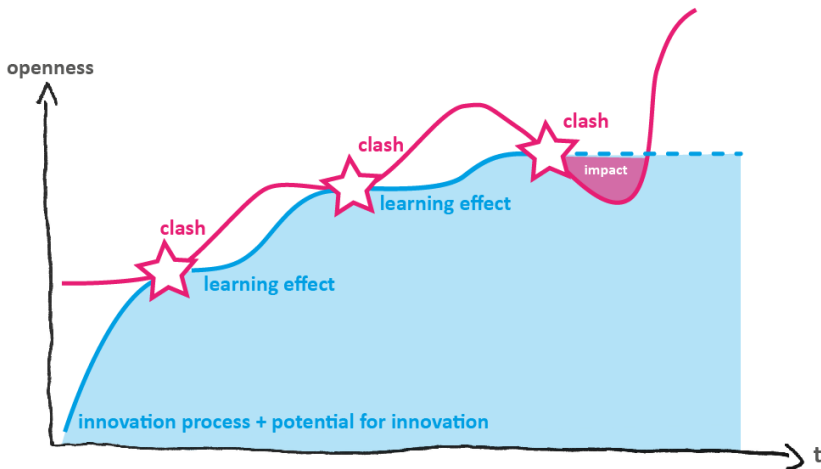


Figure 2 The antifragile process of the 'Italian users'.

But the case gets even more interesting. Even though it is a quite small motorcycle company, besides the author there is a large number of other customers dealing with same bike's problems. And since all of them share the same passion about the same product, they all try to act in the same antifragile way to deal with the situation. The more customers ride their motorcycles produced by the same brand, the more each and everyone of them acquires a lot of knowledge about the motorbike. Now since the small

company hasn't set up a large enough service network yet, its customers decided to put up an internet forum to share their knowledge. And by doing so, suddenly the entire system opens up and becomes a real Open Innovation platform. For instance some experts in welding developed entirely new frames for the bike. Others acquired knowledge about the bike's electronics and provide instructions how to improve the motorcycle's lighting. Others again by being experts in programming wrote a series of new software for the bike's electronic injection system. And suddenly users have the choice between software which would contribute to a low consumption or others that would improve the power and performance of the motorbike.

All in all, a vast number of improvements all together evolved from the simple fact that caused by a rather 'unfinished' product, it's users decided to act in a collective and antifragile way. Obviously, there is a lot of internet forums about German motorbikes too, but the stimulus to develop new solutions on top of a perfect (and closed) system is rather low compared to one which is quite open, unfinished and exposed to stressors caused by its originally fragile system.

Conclusions - Learning from Motorbikes

The first hypothesis which has been stated in the paper was, that unfinishedness turns into potential for innovation at the point when it starts offering a higher level of interaction and participation for co-producers in a process or system. By examining the 'Italian motorcycle case' the initially 'unfinished' product became a trigger for its users to get involved into the motorbike's modification and development. And by doing so in a collective way they even managed to increase the amount of knowledge and solutions generated by their platform.

The second hypothesis made, transfers Nicholas Taleb's concept of antifragility to Open Innovation Processes and states that they acquire more capability to deal with disturbances by learning from each clash with a potential stressor. And while doing so, they build up a higher potential for innovation as well. The platform established amongst the Italian customers as a whole could be described as an antifragile system since each documentation of problems and solutions is shared across the community and makes its participants' way to meet future problems become more antifragile. Further 'Black Swans' or improbable and extreme events with a high potential for disturbance become more unlikely to create deep impacts

onto the entire process. At the same time some of the solutions developed might even contribute to a future innovation of the motorbike.

The crucial part missing in that case is the step forward to a larger audience and use which would turn the single improvements shared across the platform into real innovation according to Joseph Schumpeter's definition which requires the *entrepreneur's ability to implement and introduce the new idea into a form of widespread use* (Schumpeter, 1989). Since the user community of the Italian bike might not have the intention or means to turn its knowledge into other value than the one shared amongst them, the original bike manufacturer of the Italian part is missing a huge opportunity at this point. As the missing 'entrepreneur' the company could team up with the community by opening up its own innovation process and develop some of the user community's solutions to become real innovations spread on the market. At the same time they might also be able to bridge the gap between their internal knowledge or resources and the one which obviously seem to *reside outside the organizations control* (Lakhani and Panetta, 2007). This also would scale up and advance their business by *commercializing from both, their own and external Ideas* (Chesbrough, 2003).

By using other words, the former top-down approach of the Italian motorbike manufacturer could be combined with their customers' bottom-up one towards creating a 'hybrid' approach such as described by Ezio Manzini in his article 'Making things happen: Social Innovation and Design' (Manzini, 2014). Within the area of conflict between top-down and bottom-up or closed and open approaches or the different ways to meet disturbances within Innovation processes, there still lies a huge potential for both, future research and improvement of the various Innovation frameworks themselves.

In this paper we tried to discuss some current evolutions of such frameworks by proposing a different point of view onto the openness or unfinishedness of Open Innovation Platforms such as onto the way these platforms might better deal with external stressors and disturbances. Still it is to find out in which specific cases hybrid forms of Innovation such as the combination of both, open and closed might provide advantages over the current and classic approaches.

From a designer's or producers point of view, especially the future integration of unfinishedness into products and the entire design process of these products represents an interesting field for investigation. In his concept of *Handlungsspielraum* (or in English: *the latitude of possible*

Are Open Innovation processes structured for disruption? actions performed on a product or platform), Jan Eckert will further discuss and develop the question about the right blend between the definition and unfinishedness of future products.

References

- Amabile, T. (1983) *The social Psychology of Creativity*. New York: Springer Verlag.
- Chesbrough, H.W. (2003) *The Era of Open Innovation*. *Sloan Management Review*. [online]. Available from: sloanreview.mit.edu/article/the-era-of-open-innovation/. [Accessed: 23rd December 2014].
- Eco, U. (1962) *Opera Aperta*. Milano: Bompiani.
- Gibson, J.J. (1977) *The Theory of Affordances*. In Shaw, R. and Bransford, J. (eds.), *Perceiving, Acting, and Knowing: Toward an Ecological Psychology*. New Jersey: Lawrence Erlbaum Associates Publishers.
- Von Hippel, E. (2005) *Democratizing Innovation*. Cambridge: MIT Press.
- Lakhani, K. and Panetta, J. (2007) The Principles of Distributed Innovation. *Innovations*, 2 (3), 97-112.
- Manzini, E. (2014) Making Things Happen: Social Innovation and Design. *Design Issues*, 30 (1), 57-66.
- Morelli, N. (2007) Social Innovation and New Industrial Contexts: Can Designers «Industrialize» Socially Responsible Solutions. *Design Issues*, 23 (4), 3-21.
- Schumpeter, J. (1989) *Essays: On Entrepreneurs, Innovations, Business Cycles, and the Evolution of Capitalism*. New Jersey: Transaction Publishers
- Taleb, N.N. (2007) *The Black Swan: The Impact of the Highly Improbable*. New York: Random House.
- Taleb, N.N. (2012) *Antifragile, Things That Gain From Disorder*. New York: Random House.
- Wylant, B. (2008) Design Thinking and the Experience of Innovation. *Design Issues*, 24 (2), 3-14.



Innovative processes for jewellery production

Paola GARBAGNOLI*, Maria Vittoria DIAMANTI, Barbara DEL CURTO, Valeria MASCONALE and Maria Pia PEDEFERRI
Politecnico di Milano

The objective of the present work is the investigation and analysis of innovative materials and technologies for applications in jewellery field. In recent years, large improvements have been made in those fields of jewellery that use either non-noble or semi-noble materials. Among semi-noble materials, titanium surely stands out thanks to its lightness, high mechanical resistance and excellent physicochemical characteristics, which give the perception of a technical, advanced, and therefore precious material. In addition to materials, also innovative processing techniques, such as additive layer manufacturing, are under experimentation for jewels, as well as for several other applications. Starting from these considerations, the present work studied titanium and Selective Laser Melting (SLM) for applications in jewellery. The analysis consisted in an experimental part, focused on titanium workability and surface treatments. Promising results were obtained. After that, evaluations about the aesthetic and technical aspects were done, in order to understand advantages and limits of titanium and SLM in the considered application.

Keywords: Titanium; selecting laser melting; anodization; jewellery design

Introduction

During the human evolution, social developments were often related with the introduction of new materials and technologies in the society. This is proved by the fact that each historical era is named using the name of a material, like the Stone Age, the Copper Age, the Bronze Age, or the Iron Age.

* Corresponding author: Paola Garbagnoli | e-mail: paola.garbagnoli@polimi.it

The field of jewellery, as human artefacts, is connected with materials and technologies evolution, and it represents a case study of the affirmation of materials and technologies in the society.

Until a few years ago, jewels were considered valuables due to the precious materials they were made, and precious stone they were adorned with (diamonds, pearls, gems). Recently, the jewellery field, which is in continuous evolving, has experimented innovative materials and technologies in order to obtain original shape and appearance. It is possible to observe jewels made with non-noble or semi-noble materials, such as stainless steel (Figure 1a), copper, titanium, zirconium, or moreover plastic (Figure 1b), paper (Figure 1c), textiles.

At the same time, traditional processing technologies for jewellery, usually handmade, are increasingly supported by industrial technologies (Carcano et al., 2002; De Salvia Baldini, 1994).

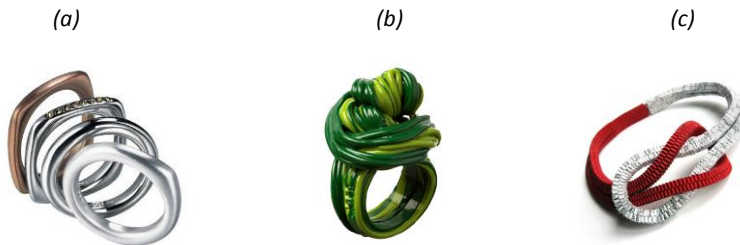


Figure 1 (a) Stainless steel rings by Breil; (b) Resin ring by Gaetano Pesce; (c) Paper jewel by Francesca Vital (FRUCCIDESIGN).

The objective of the present work is the investigation of the use of an untraditional material in jewellery design, and the evaluation of emerging and innovative processing technologies for the manufacturing and finishing phases. As untraditional material, titanium was selected because it results suitable for many reasons.

Titanium is widely used in the biomedical and aerospace industry, due to its biocompatibility, lightness and high mechanical resistance (Leyens and Peters, 2003). Its brightness and surface finishing make it suitable and interesting also for application in design and architecture. Thanks to the possibility to obtain iridescent colours on its surface by anodization, titanium is an attractive material for design and in particular for fashion and jewellery design (Del Curto et al., 2004; Diamanti et al., 2011).

Indeed, titanium anodic oxidation can lead to the formation of a nanostructured oxide film on the surface which confers iridescent and attractive colours to the metal produced by interference phenomena. The use of anodization technique as artistic applications has already been experimented in the research activity of Professor Pietro Pedefferri. Figure 2 shows examples of Pedefferri's scientific and artistic works on titanium.

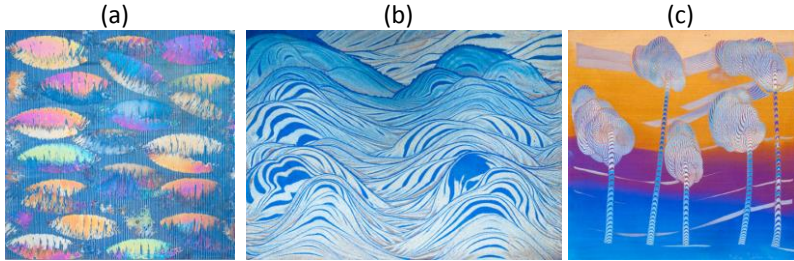


Figure 2 Pedefferri artworks on titanium: (a) 'Pesci'; (b) 'Onde giapponesi'; (c) 'Fiori'.

Anyhow, titanium is characterized by a poor workability: hence, in this research activity, the use of innovative forming techniques was considered. In detail, rapid prototyping techniques resulted interesting for titanium manufacturing in jewellery.

One of the most used rapid prototyping techniques is additive layer manufacturing.

Additive layer manufacturing is a general term used to refer to a range of processes that make solid objects from 3D computer models. In most cases this is achieved by printing thin layers of material on top of one another; sometimes layers are printed out separately and assembled afterwards. The starting material might be a powder or a liquid and the 'printing process' works by transforming this powder or liquid into a solid only where the design dictates, just like a printer draws lines of tiny dots one after each other to build up an image or page of text.

In the additive layer manufacturing techniques, selective laser melting (SLM) is a solid freeform fabrication process whereby a three-dimensional part is built layer by layer, through laser scanning a powder bed.

The successful fabrication of dense iron-based parts by SLM is still limited to a narrow range of materials, among others titanium.

Currently, laser processes are mostly used in mechanical and biomedical fields (examples are shown in figure 3); however, these techniques have an outstanding potential, since extremely complex shapes can be achieved with high precision. In particular, selective laser melting (SLM) allows the

designers to obtain complex objects through a Computer-Aided Design (CAD) three-dimensional model, without any additional equipment. This innovative technology does not require the use of moulds; therefore, it is particularly suitable for the creation of unique pieces and its application in jewellery design can be interesting (Chuna et al., 2003; Leyens and Peters, 2003).



Figure 3 Part of an aircraft wing and part of an orthopaedic implant, respectively. Both realized through additive layer manufacturing.

Materials and methods

As already mentioned, titanium results suitable to be processed through SLM. Therefore, during the experimental phase, SLM, as advanced engineering process, was tested in order to realize titanium jewels prototypes. After that, traditional finishing techniques were tested in order to extend and optimize the aesthetic and sensorial aspects.

A sampling of jewels was selected for experimental tests. The design of each jewel was very different from each other, in size and shape, and presented complex structures.

Preliminary studies of each jewel design allowed to choose the best parameters to proceed with SLM forming technique. All the jewels were designed using computer aided design systems (CAD). Starting from the 3D models, jewels were realized through SLM. During this process, titanium powder was added layer by layer and the 3D shape was obtained on a support, fixing powder through the laser beam. The entire forming process was easily realized using only the 3D model.

After SLM processing and support removal, the jewels underwent a finishing procedure. Finishing techniques tested were been electropolishing, tumbling, sandblasting or peening. They were done on the surface without any other treatment before. Each finishing is commonly used to create a particular texture on metals surfaces.

After the production, jewels were coloured by anodic oxidation. This process had already been investigated by the authors.

Anodizing can confer interference colours to titanium surfaces thanks to the achievement of interference conditions between the light reflected at the oxide–air interface and the portion of incident light which is refracted by the oxide and then reflected by the metal-oxide interface. The optic path of the latter light beam covers a longer distance with respect to that reflected by the oxide external surface, being the difference between the two paths equal to a double oxide crossing; if the two light beams exiting the surface happen to be in phase, their colour will be strengthened, while in the opposite case the colour will be weakened.

To obtain interference colours with suitable intensity, the procedure to be followed includes different steps. First of all the chemical pickling of the metal surface in a hydrofluoric acid and nitric acid mixture (5% and 20%, respectively) has been done, to preparing a homogeneous surface. After that, the metal is anodised in a diluted phosphoric acid electrolyte. The feeding voltage of this step will define the hue of the interference colour, since it determines the final thickness of the anodic oxide (Diamanti et al., 2010).

In addition to the iridescent colours realized by anodic oxidation, an almost black finishing was done on the surface of some jewels. This colour was obtained working under specific parameters during the anodization phase, specifically it was realized through high voltage anodization. This process is called TiHard and it is able to create a thicker film with improved properties of anti-scratch.

After the experimental phase, it was asked 30 designers to create a jewel, starting from a 3D model, combining the possibilities of SLM with surface finishing techniques, in order to realize an innovative titanium jewels collection.

Results

Innovative and traditional engineering techniques (selective laser melting, finishing and anodization) were experimented in the realization of a collection of titanium jewels.

During the research activity, SLM was tested successfully for the manufacturing phase.

The unique design of each jewel would have been impossible to be realized by common forming techniques. At the same time it would have

been difficult to be done by handmade techniques, because of the problematic workability of titanium.

Using SLM, the final shape of each jewel was easily obtained without any welding, starting from the 3D model.

The surface obtained through SLM presents a rough texture, due to the material structure formed by fixed powder grains. In some jewels the surface was kept as it was after SLM, without any additional finishing (Figure 4a), because it resulted original and attractive.

The four finishing technologies tested, electropolishing (Figure 4b), tumbling (Figure 4c), sandblasting (Figure 4d) and peening (Figure 4e), permitted to obtain various textures on the surface of each jewel. In particular, using electropolishing the surface resulted very smooth and reflective, but this technique reduced the thickness of the material and due to this reason, in rare cases, it can damage the object. Through tumbling, the jewel surface resulted smooth, but not reflective. Sandblasting allowed to obtain a regular little rough surface, less rough than the surface obtained with SLM. Using peening the surface resulted irregular, quite smooth and reflective, with unlimited faces.

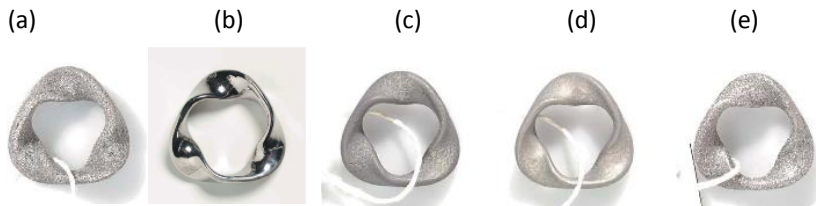


Figure 4 Samples of jewels realized through SLM process, and finished with (a) SLM finishing, (b) electropolishing, (c) tumbling, (d) sandblasting and (e) peening, respectively.

Iridescent colours were obtained on the jewels surface by anodic oxidation. The parameters of the process were set in order to obtain the thickness of the oxide related to the specific hue chosen by designers. Finally, in order to confer to jewels a unique value, in some cases they were anodized with a non-uniform method, using artistic handmade techniques, developed in the past by Pietro Pedeferra. In these cases, result is a non-homogeneous colour surface. Examples can be seen below in Figure 5. It is possible to assert that the output of the colour is related with the finishing used on titanium surface.

A collection of more than 30 titanium jewels was realized and promoted.



Figure 5 Jewels realized by SLM, coloured by anodic oxidation, and presented at the 'Titani preziosi' exhibition (Triennale di Milano, 2010); (a) Design by Michela Nosè; (b) Design by Stefania Lucchetta; (c) Design by Valeria Masconale and Caterina Passaro.

Discussion and conclusions

The aim of the work, that was the research of new materials and technologies for jewels applications, was reached with good results.

The research was based on the transfer of materials and technologies, from other fields of applications, to jewellery.

A collection of titanium jewels was realized and selective laser melting technology was successfully applied in order to create prototypes with original design, starting from a computer aided design model.

Moreover, finishing techniques, typically used in engineering applications, were transferred to jewellery design with interesting results.

In conclusion, materials and technological transfer reached positive results, encouraging additional future projects.

SLM technology is already used in other applications and with other materials. Considering the applications, SLM is currently employed especially in medical field: typical examples of application are hip implants or surgical instruments as well as dental restorations.

Considering the nature of the powder in SLM processes, the most common materials used are steel, aluminium, and titanium alloy.

The peculiarity of this technology is the possibility to easily obtain complex shape and unique pieces.

The first innovative point of the work is the idea to extend the use of SLM to a new field of application, which is jewellery. That is an advantage from two different points of view: first, it opens the way to new possibilities of application for SLM technology, which still have limited employment;

second, it brings new possibilities in jewellery field that still be tied to traditional materials and techniques.

The use of titanium for the jewels realization is justified by many reasons: it is a biocompatible material, adapt to stay in touch with skin; its lightness can guarantee usability also considering voluminous jewels; it gives the perception of an high value material; it can be coloured, by anodization, obtaining iridescent colours with aesthetic value, and finally, titanium powder is suitable for SLM.

Limits of the work are related with costs, time of production, and repeatability, even if, considering the jewellery field, they are acceptable.

From a general point of view, the present work has built an innovative production chain that connects very different experts and manufacturers, from SLM process to the electrochemical anodization.

In the present work, the design approach includes not only the study of materials and technologies for jewellery, but moreover it connects different fields and experts in order to offer new possibilities for products development.

References

- Bralla, J.G. (1999) *Design for manufacturability handbook*. New York: McGraw Hill.
- Carcano, L., Corbellini, E., Lojacono, G. and Varacca Capello, P. (2002) *Il mondo orafo tra tradizione e innovazione*. Milano: Etas.
- Chuna, C.K., Leong, K.F. and Lim, C.S. (2003). *Rapid prototyping: principles and applications*. 2nd Edn. Singapore: World Scientific.
- De Salvia Baldini, M.S. (1994) *Dizionario del gioiello*. Milano: A Vallardi.
- Del Curto, B., Pedefferri, MP. and Rognoli, V. (2004). *Titaniocromie: il titanio e i suoi colori*. Milano: Epitesto.
- Diamanti, M.V., Del Curto, B., Masconale, V. and Pedefferri MP. (2010) *Production and anodic colouring of newly-designed titanium jewels. Colour: Design & Creativity*, 16 (5), 1-9.
- Diamanti, M.V., Del Curto, B., Masconale, V. and Pedefferri, M.P. (2011) *Titani Preziosi: tecniche di produzione e lavorazione innovative per gioielli in titanio. Quaderni di Cultura e Progetto del Colore*, 70, 28-30.
- Leyens, C. and Peters, M. (2003) *Titanium and titanium alloys*. Weinheim: Wiley-VCH.
- Pedefferri, P. (1984) *Movimenti su titanio*. Milano: Clup.

Vanderbroucke, B. and Kruth, J.P. (2007) Selective laser melting of biocompatible metals for rapid manufacturing of medical parts. *Rapid Prototyping Journal*, 13 (4), 196-203.



Procedures for Community Based Parametric Design and Making

Jason S. JOHNSON*, Alyssa HAAS and Guy GARDNER
University of Calgary

The expanding interest in parametric models of design in both academic and professional circles has led to an explosion of innovation in production methods geared towards engaging these emerging ways of conceiving projects. Simultaneously there has been intensification in the development of tools to facilitate the growth of an on-demand maker culture. From low cost 3D printers and laser cutters to large scale versions of the same, there is a growing technological infrastructure to support the 'seamless' flow of information from its digital to form to a material one. What are in many cases lacking are methods to engage non-experts interested in participating in this milieu. How does one without experience in best practices for digital production, begin to engage in this design process or at least begin to be exposed to its potentials? This paper documents a number of projects engaging this question in the form of community based design build projects. Each of these projects follows the methodology of a component based system in which individual components are informed by localized conditions to produce larger aggregate physical prototypes assembled and manipulated by non-expert 'designers/makers'.

Keywords: Digital fabrication; parametric design; digital design; design education; design build; emergent fabrication tools; metadesign

Introduction: Metadesign and the Hive

The emergence of digitally mediated collaborative design build projects in the field of architectural education builds on a long history of prototyping and community engagement as vehicles for learning how to embed technical expertise, responsiveness to programmatic and client demands into the design space of the studio. This history which once relied on the

* Corresponding author: Jason S. Johnson | e-mail: minusarchitecture@gmail.com

design 'charrette' as the primary mode of community engagement and visual and physical representation as the primary modes of communication, has been challenged through the introduction of digital tools that allow for collaborative procedures to transition directly from the generative (design) procedures to the physical (making) outputs. Design charrettes have typically relied on invited experts analysing a given context and set of problems, often framed by the commissioning party, and proposing a set of quickly produced speculative solutions. The processes described here see the end users as collaborators in the design proposal through the introduction of a procedure designed to leverage the expertise of trained designers and the understanding of the local site conditions held by the community participants. These processes take advantage of contemporary modes of communication, via shared knowledge of digital design and fabrication techniques, to treat the design team as a hive-like organism as opposed to a sequentially segregated set of actors. As Brett Steele noted in his article on the evolution of the design studio towards a digitally immersive collaborative environment, the architect has been reconfigured from a solitary 'creative' into a 'virtual, constantly adapting organisation' (Steele, 2003). This points, not so much to the reality of the design profession which has long been understood as a collaborative one, but to the structure of the design process which has often relied on discrete roles within the project delivery sequence that is additive or evaluative rather than collaborative in real time. This mode of working for designers has become increasingly enabled by the commonality between the digital interfaces and processes that allow for rapid exchange. Less common has been the integration of non-expert community groups into these design projects in ways that influence the design outcomes. Over the last several years the Laboratory for Integrative Design, based at the University of Calgary, has attempted look for ways in which to engage non-expert communities into the design and making process.

The change in the tools available to designers for generative and productive processes has coincided with a growing maker culture that has leveraged the availability of low cost machines for fabrication of a wide variety of objects. The objectives of a design curriculum support the development of expertise within the realm of the generative processes at play, while the larger culture is more obsessed with the ability to adapt, individualize and quickly make products. Within this context we set out to develop a series of projects that would combine design expertise with an engaged but non-expert community in a process of co-creation. These

projects are in some ways influenced by Giaccardi's description of 'Metadesign' as a cultural shift from 'design as planning to design as seeding'. Giaccardi describes this process as one that promotes more open and evolving systems of interaction that could begin to integrate diverse domains of expertise and enhance creative processes through convergence (Giaccardi, 2005). While we used this framework as a way to situate and develop a series of projects, we were of course limited by the constraints of physical production. Physical production of prototypes requires that a level of expertise in the processes of making be embedded into these projects in a way that is less accessible to the end users and community participants than might be the case for designed artefacts like websites or even works of art. The proposed method for dealing with the reality of building prototypes that would occupy public space, was to develop a set of design protocols that would enable constructability and adaptation by novices, while being embedded with robustness and a constrained range of design outcomes by the project designers. This hybridized approach recognizes the likelihood that designers and users bring some overlapping skills to any given problem and that this overlap allows for a productive working methodology.

A Hybrid Approach – Designer Biased

We first present two projects in which the design outcomes were driven by a more top down approach, but which involved the mobilization of non expert communities in their production. We invited emerging architects with a developed expertise in digitally driven generative processes that translated directly to digital fabrication outputs. These projects relied on a more traditional atelier model in which the expert passed on expertise to workshop participants through a series of hands on lectures and critiques.

These design based exercises were paired with fabrication and assembly tasks. In this model the students in the workshop digitally fabricated and assembled a project developed in advance by the visiting lecturer. They were given lectures describing the generative logics underlying the projects and given opportunities to manipulate the source code and tools developed by the designers for their own purposes. These workshops relied on the use of modification as a tool for learning.

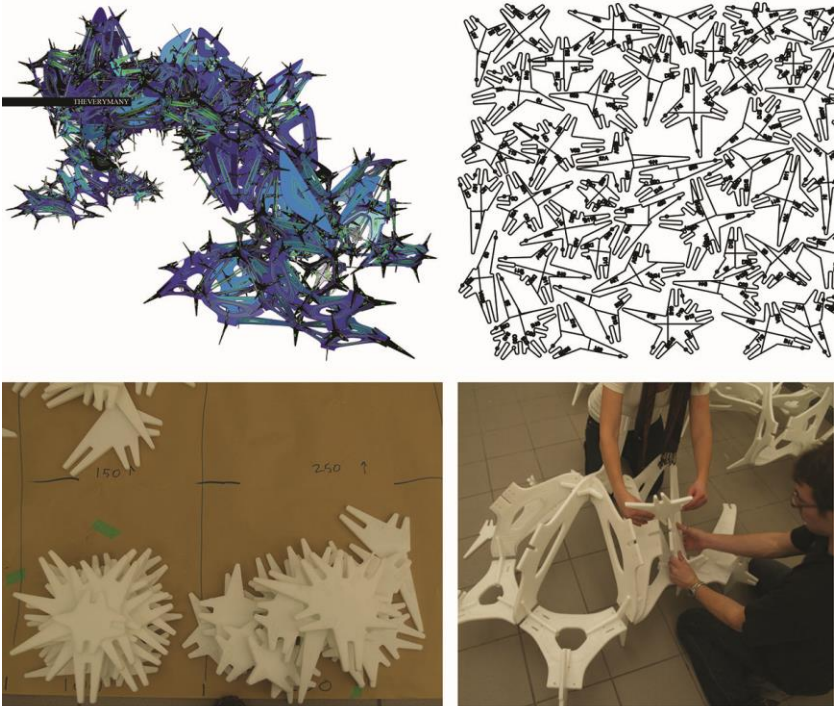


Figure 1 *Aperiodic Symmetries*, Marc Fornes w/Skylar Tibbets, 2009. Students use digital files to sort and locate prototype components in relation to one another.



Figure 2 Aperiodic Symmetries, Marc Fornes w/Skylar Tibbits, 2009. Final assembly in Kasian Gallery, Calgary, Canada.

In 2009 Marc Fornes and Skylar Tibbits led a workshop with students at the University of Calgary in the subject of designing through code. Students were led through a series of iterative exercises in which they expanded upon pieces of code given to them by the instructors. Starting with a simple arch the students were tasked with breaking down the geometry into smaller subdivisions that were populated with the various parts that made up the assembly. Aperiodic Symmetries was the project developed in advance by the instructors as a hands-on project by which the students would understand the implications of the different script routines they modified during the course. After milling and processing the parts the students used the digital model of the project to sort and locate the parts within the final assembly (figure 1). There were no paper documents and the model functioned as the representational device to aid in assembly of the project. Though the forms were complex the assembly mechanisms

JASON JOHNSON, ALYSSA HAAS, GUY GARDNER

where kept simple so that students unfamiliar with construction techniques could quickly learn how to assemble to project. The final project was exhibited in the Kasian Gallery in Calgary, and the exhibit included documentation of the process.

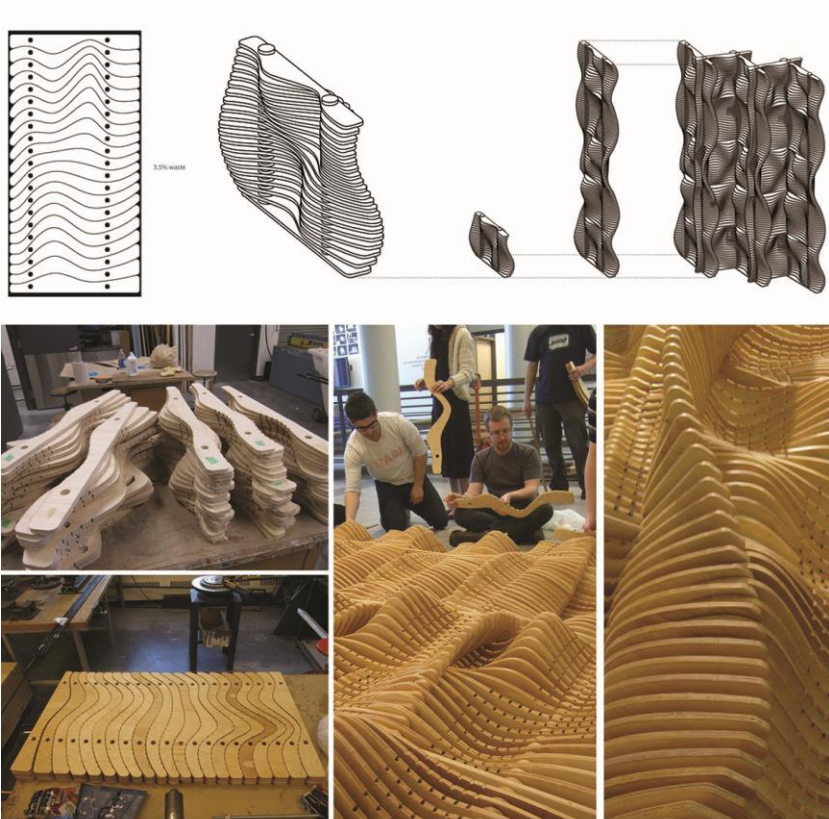


Figure 3 *Zero Fold Screen*, Andrew Kudless, 2010. Using *Grasshopper*, Kudless developed a parametric model that translated a minimal waste pattern of two-dimensional cutting into a three-dimensional screen.

In 2010 Andrew Kudless led University of Calgary students in the second iteration of the digital fabrication workshop. Students were again given tutorials in parametrically driven design techniques, but this time were asked to more fully develop their own projects by adapting the given code and giving it a different site within the building. As in the previous example

students worked with the instructor to fabricate, assemble and install the project in a gallery (figures 3 and 4). The project relied on a series of repeating elements aggregated in a varied sequence to create a highly articulated screen wall for the gallery. Students were introduced to parametric techniques for reducing material waste through the manipulation of machining paths (Kudless, 2011). The final screen was installed permanently in a public space along with a description of the project goals (material efficiency, light filtration and novel digital tooling techniques) and serves as a learning tool for the present and future students.



Figure 4 Zero Fold Screen, Andrew Kudless, 2010. Screen is permanently installed in the Faculty of Environmental Design for use as a learning tool.

Sequences of Production: Massively Customized Inefficiency

Subsequent workshops have built on the hands on modification approach of these two workshops both in the generative and production processes and more recently through the introduction of interactive

elements that allow for real time manipulation of the final projects as a method of engaging the public in the 'design' of the space in which the installations were situated. In anticipation of engaging non-designers in similar opportunities for immersive design build projects, we evaluated the shortcomings of the processes deployed in the previous projects. Two main issues presented themselves as obstacles to engaging novice designers and makers into the process that worked well with trained design students.

The first was the issue of precision. As is common with many parametric/scripted design projects, the projects developed for these workshops relied on a large number of unique pieces, each of which had to be installed in the proper sequence in order for the final project to be assembled properly. Missing pieces or incorrectly machined pieces led to huge delays in the assembly of the project. The specificity of both the sequence of assembly and the relationships between parts meant that nearly all design decisions were taken in advance of the collaborative assembly effort. While this structure allowed for a high degree of predictability in the final design outcome and taught students to develop organizational and construction sequencing strategies, they served as a barrier to engagement for non-designers whom we wanted to engage in a process of both design and assembly.

The second issue was one of time. While design students are used to putting in long hours in order to complete projects to high level of precision and quality, we were hoping to create workshop opportunities for the community that could be completed in 4 hours or less. This meant that less time could be spent in identifying, sorting and assembling pieces. Whereas the workshops for our students were carried out over the course of 5 days, with access to a fabrication shop, various tools and climate controlled environments, the community workshops needed to be much more flexible and less dependent on a controlled environment.

Prototyping Methodology

In response to the limitations of the previous projects and in support of a more adaptive design process that engages both designers and end users in the act of design we proposed a set of principles that would guide the design and production of the project we present here. These rules are as follows:

- Projects must allow for manipulation of final design outcomes by untrained designers.

- Final project material components should require minimal ‘finishing’ by participants.
- Assembly should take fewer than 4 hours.
- Instructions for design manipulation and assembly should be simple and able to be rapidly communicated.
- Design outcomes should allow for some level of user engagement that extends the design implications beyond the initial generative and production processes.

This last criteria recognizes a problem with attempting to engage metadesign as process for the production of static ‘architectural’ artefacts. The problem is that while increasingly architects are designing kinetic or ‘responsive’ environments, they are rarely doing so in collaboration with end users. Rather they are taking on board information related to the program or function of the project and designing the interfaces and protocols by which end users can manipulate the end product. In this instance we were trying to produce a process and protocol that limited the outcomes in productive ways (consistent aesthetics, durability and safety) but delimited them in others (function, ergonomics and aesthetic tuning).

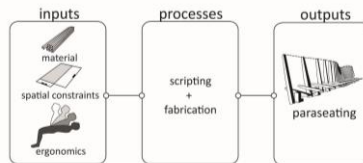


Figure 5 Paraseating, Jason Johnson and Guy Gardner, 2012. Protocols for parametric seating structures.

Paraseating

The project selected for this test was called Paraseating. Paraseating was a project to design six public benches for a small park. The brief called for rapid assembly by community volunteers and students who would also presumably make up the end users of the park. We proposed a strategy that involved the aggregation of a series of components made of cedar dimensional lumber which could each be adjusted within a certain range before being fixed into place, creating the potential for variation and customization by the volunteers (figure 6). The relationships of the parts to one another were managed by designing a modular system for producing profiles. This system had to be kinetic (moveable in section) so as to allow

the community volunteers to adjust the profiles towards desired performance criteria (angle of declination) before fixing them in place.

In addition to this variability the system had to be able to constrain the parts so that they remained connected to one another structurally and managed so that each module would have a relationship to its adjacent modules in order to avoid producing uneven seat backs.

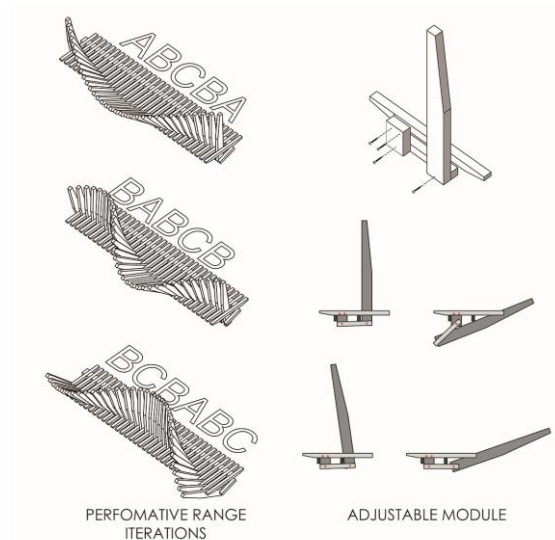


Figure 6 Paraseating, Jason Johnson and Guy Gardner, 2012. Modules are installed sequentially by participants who choose the ergonomic positioning of each segment of the bench.

The initial planning stages of the project involved using parametric tools to test the design, and creating a physical prototype to optimize the components. Through this process we were able to determine the parameters which would influence the final product, including the range of variation, the necessary tools and types of fasteners, and the location of pinned connections. This testing and prototyping led to the development of the prefabricated components and the logic which would guide the assembly. Several prototypes were developed to test the structural and ergonomic properties of the proposed structure.

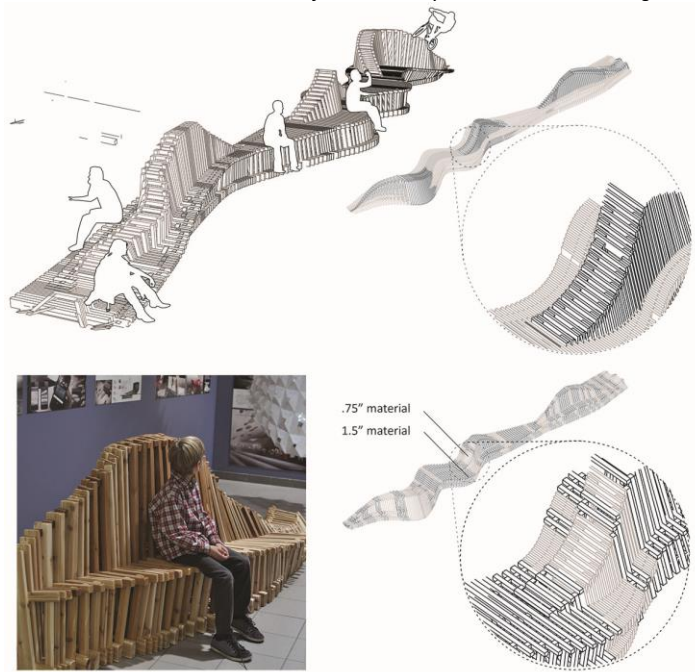


Figure 7 Paraseating Prototype 01, Jason Johnson and Guy Gardner, 2012. Assembly of highly variable components to respond to a number of functional and aesthetic criteria.

This first set of prototypes called for a high level of variability within the individual components in both thickness and dimensions of the lumber used (figure 7). This approach required time consuming sorting of pieces which had to be assembled in the proper sequence in order to produce a functional bench. While the results of this test were compelling in regards to the formal and surface qualities of the bench, the level of knowledge of the project that would be required to deploy a large group of volunteers to install a similar structure in a public park in a matter of hours made this version untenable. There are a number of projects that have used the approach of ‘shifting craft upstream’ as a way of using the visualization afforded by the computational environment to make preliminary evaluations of the success of a given design or assembly logic (Wilkins et al., 2011).

This model works well when participants in the design process are being tasked with becoming experts in the tools of design and fabrication. In this case we were attempting to embed within the design and assembly process of the project a way for interested novices to engage in a parametrically enabled/constrained design project.

The second iteration of the project reduced the number of parts that would make up a module and introduced variation through the manipulation of the relationship between the parts with a pin connection (figure 6). This allowed for a hybridized metadesign model that shifted the area of collective design intervention from the overall formal qualities of the object to the specific attributes of the bench. The volunteer designers were able to test design outputs in physical space and in relation to the positioning of the body on the bench. In a sense they were producing a variable ergonomic field across the design object that become fixed at the point they deemed it to meet their criteria for what a bench in that specific location in the park might need to accommodate.

We were cognizant that only a limited number of end users of the park would also be involved in the production of the benches and that the variation within the benches should provide for a range of performance in aggregate that would not be possible in a single fixed position bench. The instructions alluded to this variability as a desired outcome to be pursued by the participant/designers.



Figure 8 Paraseating, Jason Johnson and Guy Gardner, 2012. Student and community volunteers simultaneously assemble and design park benches.

On the construction day pre-cut pieces of cedar, prefabricated steel support frames, jigs for the initial assembly of the components, fasteners, and tools were delivered to the site. We provided each team with a demonstration of the assembly logic and the range of declination possible between modules. The steel frames were attached to the planter boxes to help transfer loads. The components were pinned together using jigs to locate the connection points, individually adjusted to the desired position, locked into place and fixed to the frame. The teams quickly assembled their unique benches and most were completed in less than 4 hours (figure 8).

The process typically involved very quickly building the modules, followed by a process of negotiation among team members as to the angles the bench might take and how the angle might change across the length of the bench. The participants often measured the comfort of the bench after each module was fixed in place and adjusted accordingly to feedback from team members.

As all the benches were being built simultaneously and without prescribed designs, it became clear that groups were responding to the

designs of the adjacent benches by making changes to ensure that no two benches were alike.



Figure 9 Paraseating, Jason Johnson and Guy Gardner, 2012. Six unique benches produced by the participants over the course of 4-6 hours.

Through this process we were able to establish a framework which empowered the teams of makers to take a greater level of authorship in the fabrication process. Rather than simply following a set of instructions to assemble a pre-determined object, they were able to collectively determine how they wanted to customize their own bench in relation to criteria developed by each team. In the end six unique benches were produced (figure 9). The exercise provided an opportunity for the participants to achieve a greater level of understanding of design processes through collaborative iteration. It also demonstrated the potential for digital fabrication techniques to facilitate the rapid deployment of a component based system constructed of readily available materials within a limited budget by relatively inexperienced volunteers. Finally, it engaged the

broader community by contributing a robust and unique design object to the public realm.

Conclusions

This project attempts to engage parametric design in both the digital and physical realms across levels of expertise. Increasingly tools for collaborative design are being developed with the goal of engaging design and making communities in an integrative process (Manack and Jacobus, 2013). As design and manufacturing tools continue to evolve towards more widely distributed models, the potential for engaging diverse groups of collaborators in the production of shared projects is bound to increase. In order for these processes to become open to larger constituencies, tools for engaging non experts must be developed that leverage the expertise of designers in the production of aesthetic, functional and structural constraints while allowing for varying levels of emergence in design outcomes. This ability to balance digital and analog moments of design agency within the process for untrained designers with the highly developed expertise that architects and designers bring to the equation will ultimately determine the success of crowd-sourcing models of design and making.

The process used by the Paraseating project provides a useful precedent for developing design and making processes that can involve both designers and end users in a limited design process. In order for this process to fully engage the notion of an open ended continuously iterative design process it would be necessary to develop a much more robust process that would allow for evaluation, disassembly and reiteration by the users, while maintaining the built in design parameters that ensure structural stability, safe operation and if desired limitations on the visual characteristics of the final built artefacts. Working towards reconfigurable design systems that allow for user input at various points in the design process could be a valuable strategy for extending the life cycle of public infrastructure within our urban environments.

References

- Giaccardi, E. (2005) Metadesign as an emergent design culture. *Leonardo*, 38 (4), 342-349.
- Kudless, A. (2011) *Zero/Fold Screen*. In Johnson, B., Taron, J.S., Parlac, J.M. and Kolarevic, V. (eds.), *ACADIA 2011 Integration Through Computation* :

Project Catalogue of the 31st Annual Conference of the Association for Computer Aided Design in Architecture (ACADIA). Calgary: ACADIA.

Manack, M. and Jacobus, F. (2013) Out of Control: Parametrics + Metadesign as a model for Mass-Customization. *International Journal of Interior Architecture + Spatial Design*, 1, 56-61.

Steele, B. (2003) *Disappearance and Distribution: The Architect as Machinic Interface*. Hunch: the Berlage Institute Report.

Wilkins, G., Zilka, L. and Cherrey, J. (2011) *Scripted Materials*. In Johnson, B., Taron, J. S., Parlac, J. M. and Kolarevic, V. (eds.), *ACADIA 2011 Integration Through Computation : Proceedings of the 31st Annual Conference of the Association for Computer Aided Design in Architecture (ACADIA)*. Calgary: ACADIA.

Smart materials: development of new sensory experiences through stimuli responsive materials

Esther Lefebvre^{*ab}, Agnese Piselli^a, Jenny Faucheu^b, David Delafosse^b and Barbara Del Curto^a

^a Politecnico di Milano; ^b Ecole des Mines de Saint-Etienne

Smart materials are materials that change properties according to stimuli, adapting to their environment. This makes them particularly interesting, to increase the performance of a product, and to enable new functionalities and new ways to interact with users. Some smart materials can affect the perception we have of objects. Existing smart materials have an action mostly on the visual and the tactile aspects. The most popular variations are based on colour changing materials, such as thermo/photo-chromic materials or thermo/photo-luminescent ones, and shape changing materials, such as shape memory alloys. These new materials will allow designers to introduce new sensory experiences in their products. For that, they need to know what differentiate these materials from common ones, which kinds of smart material exist, and to have some guidelines about how they can be used. This paper presents a tentative classification of smart material that relates to the way they can be used in product design. This is illustrated through some application examples of colour and shape changing materials.

Keywords: Smart materials; sensory experience; stimuli-responsive; industrial design

Introduction

To create innovation in product design, it is necessary to link the available technical knowledge, the actual industrial context and the cultures considered all together, in order to design object that are thinkable, feasible and accepted. 'Matter becomes capable of being integrated into design and in the end becomes part of a product' through supplying 'cognitive tools and

* Corresponding author: **Esther Lefebvre** | e-mail: esther.lefebvre@polimi.it

cultural reference' (Manzini, 1989). However difficult with the expansion of synthetic materials and the rapid evolution of manufacturing processes, maintaining such a shared cultural, technical and industrial background was made possible after World War II through intensive collaboration across design and engineering in industries such as car manufacturing (Tovey, 1997) and the emergence of design as an academic discipline (Cross, 2001). With the emergence of nano-technologies and nano-functional materials, we are facing a particularly challenging situation, in which innovations developed in physics laboratories are being adopted and implemented in prototypes by designers before a proper engineering practice and 'design culture' (Cross, 2001) related to these materials has the time to be developed in industry. To create meaningful innovation, we need more than ever a strong knowledge transfer between the technical artifacts produced by physicists, their use in product offers by designers and their implementation in industry by engineers.

This is especially true when it comes to materials that show unusual behaviour, as it is the case with smart materials, for which the basic need for practical guidelines on how to use and implement them is particularly prevalent. This paper reports on an attempt to categorize and organize information on smart materials in a way comparable to what was achieved in engineering design for traditional materials twenty years ago (Cebon and Ashby, 1992).

Smart materials have the unique ability to respond to stimuli and adapt to their environment. Through this particularity, they offer new possibilities for designers, especially when it comes to the interaction between users and products. Though, there is a wide variety of behaviour among these smart materials: only separating these materials by type of input and output, there are already many different basic types of behaviours presented in this paper, with many possible behaviours for each type. Therefore, smart materials can be as difficult to apprehend in their whole as they are interesting for product design. To be able to take advantage of their unique properties and create new experiences for the user, knowing which smart materials exist and how they work is really important.

To try and represent effectively materials information on these materials, we have to reflect on the pioneering works of Ezio Manzini on the one hand (Manzini, 1989) and Mike Ashby (Cebon and Ashby, 1992; Ashby and Johnson, 2009). Starting from a different point of view, both converged towards the same outcome: to be meaningful to design or engineering, the

information on materials has to be expressed (and quantified whenever possible) in terms of functionality instead of just elementary physical properties.

In the case of smart materials, one important functionality that need to be identified and described is their stimuli responsive behaviour and the fact that they can connect different sub-spaces of the user experience that are normally disconnected with 'inert' materials (for example, with thermochromic materials, a thermal stimulus props a visual response, see figure 1).



Figure 1 Thermochromic ball: when heated by putting the hand on it, the ball changes colour, LRCHallcrest, source: <http://lcrhallcrest.com>.

This allows creating vivid multi-sensory user experiences, but will be difficult to represent using conventional 'Ashby-type' property charts. New ways of organizing, coding and representing materials data are needed to convey information on smart materials in a way which will be meaningful to designers.

The aim of this paper is to give an overview of existing smart materials, first through a proposition of classification that has been made as a first tentative of visualization of smart materials, and through different examples that would allow designers to have an idea of the possibilities given by smart materials. Especially, we have chosen to focus on materials that affect the user senses and their applications, since a user tends to evaluate the products relying on his emotions and perceptions, and will be more likely to appreciate a product that appeals to his senses (Passaro et al., 2013).

According to Desmet and Hekkert (2007), eliciting delight of one or more of our sensory modalities leads to a positive aesthetic experience which in turn favours a positive emotional response and generates affect toward the product.

What are smart materials?

General description

Smart materials are materials that change properties according to stimuli: under a certain input, they produce a predictable and repeatable response, or output (figure 2).

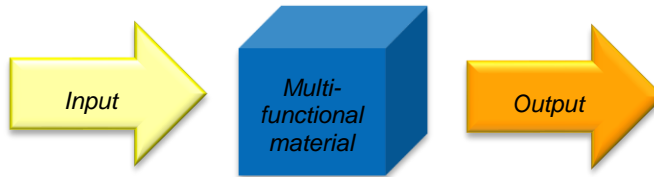


Figure 2 Basic functioning of smart materials.

The input can be either specific wavelengths of light, temperature changes, movement, deformation, pressure, chemical concentration, electric field or magnetic field, while the output produced can be changes in colour, light, temperature, deformation, stress, stiffness or viscosity, electric field, magnetic field or electrical resistance.

According to Addington and Schodek (Addington and Schodek, 2005), most of these smart materials have five characteristics in common: *immediacy*, *transiency*, *self-actuation*, *directness* and *selectivity*. The *immediacy* means these materials react as soon as the stimuli appear, i.e. they have an immediate response. The *transiency* is related to the fact that they react to more than one environmental state, and have different properties depending on these various environmental states. *Self-actuation* means the special properties are internal of the materials, and are not produced by some external actions on the materials. *Directness* represent the fact the response of the material is local, and the output is produced at the point the input was given. Last of all, *selectivity* qualifies the predictable and repeatable characteristic of the response, so a single environmental state can only lead to a unique and constant response of the material. (Addington and Schodek, 2005).

Classification

Although they have these common characteristics, there are many types of smart materials, and each type will have a different interest for designers

Smart materials: development of new sensory experiences through stimuli responsive materials

and users. To better understand the range of potential uses, a classification is needed.

A possible way to sort these materials is to separate them by input and output, which represents their main functionality, in terms of materials selection criteria (Ashby et al., 2002). This is illustrated by the graph in figure 3, which links the input, on the left hand side, with the output on the right hand side for each type of functional materials.

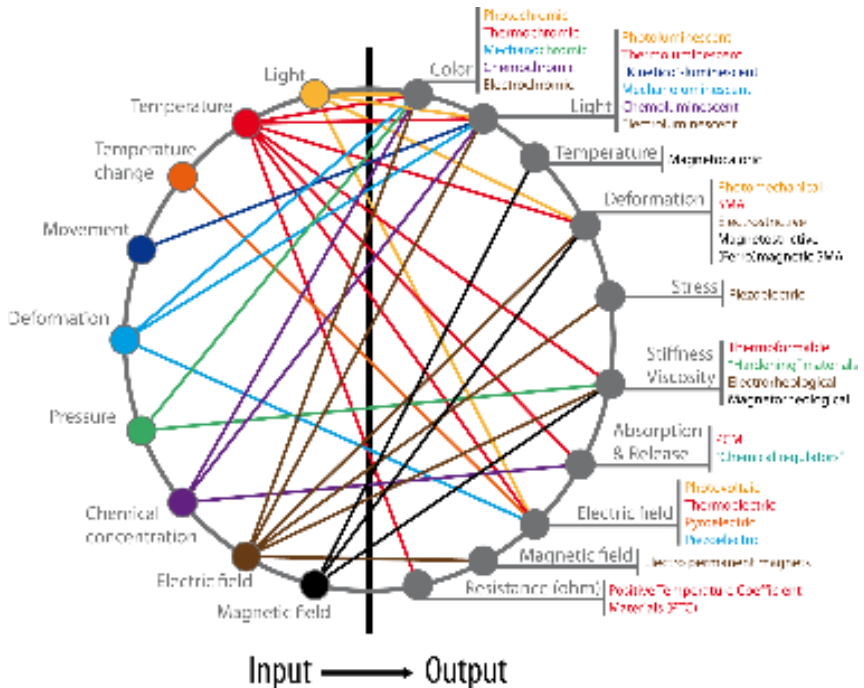


Figure 3 One possible classification of smart materials.

The different types of materials are represented by a link between the input and output associated to them. For example, photochromic materials are represented by the link between the input 'Light' and the output 'Colour'.

The graph can be useful to explore the possibilities offered by smart materials: as they show numerous different behaviours, it can be difficult to envision all the possibilities offered by these materials, and such a map can






provide first guidelines. One can look at the materials that correspond at a given input he wants to use to switch on the object or add an additional functionality, or he can see which materials are able to produce the desired response, and which type of input they need to be activated. Finally, one can simply use the map to get basic information about what kinds of smart materials exist, as a source of inspiration.

Such a graph could also be used to know which classes of smart materials can be adapted for an application in a given project.

Another way to use such a graph is to pick up the most appropriated type of material given the interaction one wants the object to have with the user. For example, if a designer wants an object to react to surrounding temperature by changing shape, a possible way is to use Shape Memory Materials (SMM). Several options are available to achieve this effect, and practical constrains such as, e.g.: shape, size, required production rate, ... will decide on the final choice (e.g.: Ni-Ti shape memory alloys).

Additionally, some of these materials exhibit a bi-directional response: they can react to an input creating an output, but also react to the former output and have an effect on the input. For example, piezoelectric materials respond to an electric potential by generating a deformation, and respond to a deformation by producing an electric tension. Therefore, these bi-directional smart materials can be used in a different way than the other ones, whose response is mono-directional. A list of such reversible smart materials is listed in Table 1.

Table 1 Smart materials having a bi-directional effect.

Type	Input		Output
Piezoelectric	Deformation		Electric field
Pyroelectric	Temperature difference		Electric field
Thermoelectric	Temperature difference		Electric field
Electrostrictive	Electric field		Deformation
Magnetostrictive	Magnetic field		Deformation

Smart materials: development of new sensory experiences through stimuli responsive materials

Although it is important to know what kinds of smart materials exist to understand the possibilities they offer, it might not be totally sufficient to know how to use them. It can be useful to know why and how the material exhibits its particular behaviour. Another way to envision the possibilities is to look at already existing applications. These two points will be the topic of the second and third parts of this paper, focusing on materials that directly affect the user's senses.

Smart materials vs. common materials

The varying properties of smart materials make them fundamentally different from common materials. Indeed, common materials are most often used as a medium to give fixed properties to an object and a change of properties or behaviour with their environment is often seen as a difficulty that has to be dealt with, rather than an opportunity to provide additional functionality. In the case of smart materials, these properties become variable: the material will respond by itself to a particular event in its environment, and at the same time give information, interact with and/or entertain the user. By taking advantage of the versatility of these materials, designers can imagine a new relation between the user and the object. As stated by Passaro et al. (2013), the sensory properties of a product are essential in the user's evaluation and attachment toward it. Therefore, making the product's sensory properties reactive present a great advantage to amplify the interactions between the user and a product.

Another advantage of smart materials over common ones is that their response is immediate and simple, while through common materials a complex system or interface would be required to give the same response, often with a larger delay. This opens the possibility to a new way of conveying 'material immateriality', as recently defined by Arnall (Arnall, 2014).

However, smart materials are not yet commonly implemented in industrial products. There are different reasons for that: the first one is that these materials can be complex to process and produce because there is no shared expertise on how to use them efficiently in industry. Thus smart materials have to be considered separately from other materials, but still need to be compared with and put into perspective with conventional solutions when considering design options. Indeed, on the strict ground of feasibility, it is not straightforward to decide which solution between an innovative smart material and a system of conventional materials will be more relevant and efficient for a given application. This again highlights the

need to express their characteristics in terms of *functionality* instead of just *properties*.

Another point that can prevent their widespread use and development in the industry is the perceived risk of using very new materials. For example, it can be difficult to check or estimate the durability properties for new materials, and if it matches with the life expectancy of the product. Finally, some of the functional effects exhibited by smart materials can decrease in intensity throughout their lifetime, but this evolution is rarely documented in a useful (quantitative) way.

Smart materials that directly affect senses

If we focus on making the sensory properties of an object variable and interactive, several classes of materials become more interesting than others. It is especially the case for colour changing, light-emitting and shape changing materials, which variations affect directly the perceptions of the user.

Colour changing and light-emitting materials

These materials have a direct effect on the visual appearance of an object, and present a large variety of possible inputs, therefore they can be used in a wide variety of applications. For both colour changing and light-emitting materials, possible inputs are light (photochromic, photoluminescent), change in temperature (thermochromic and thermoluminescent), deformation or pressure (mechanochromic and mechanoluminescent), chemical concentration (chemochromic and chemoluminescent) and electric field (electrochromic, electroluminescent and LEDs). Some materials also change colour when they are submitted to a pressure change.

Shape changing materials

As for colour changing materials, there are several types of existing shape changing materials. The most well-known are shape memory alloys and polymers that recover their initial shape when heated. Other shape memory materials exists that regain their shape under a magnetic field, pressure, a chemical concentration or light (Del Curto, 2008).

In shape memory alloys (SMA), the shape memory effect is due to a change of phase inside of the material: the material is in a phase, or form, called martensitic when cold, and in an austenitic phase when heated at a

certain temperature. Since these phases have different atomic structures, the material is rearranging itself when heated and recovers its initial shape. Depending on the SMA, the temperature of phase change is different. As illustrated in the figure 4, this effect can be either one- or two-ways: in the one-way version, the SMA can be deformed by the user in its cold state and will recover its initial shape when heated; in the two-way version, it will have two preset shapes, one when cold and one when heated, and will switch to one form to the other depending on the temperature (Van Humbeeck, 2008).

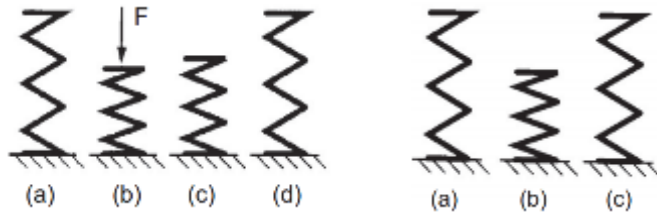


Figure 4 Shape memory alloy (Van Humbeeck, 2008). Left: One-way configuration – when submitted to a deformation in its cold state, the material will stay deformed (a \rightarrow b \rightarrow c). Then, when heated, it will recover its initial shape (c \rightarrow d); Right: Two-ways configuration – the material change shape spontaneously when cooling down from one preset form to another (a \rightarrow b), and return back to the previous form when heated (b \rightarrow c).

Apart from this shape memory effect, other materials exhibit a reversible deformation when submitted to specific stimuli. It is the case for photomechanical materials, that change shape under light or UV light, electrostrictive and piezoelectric materials that deform in reaction of electricity, and magnetostrictive materials, that react to magnetic field. Among these, the piezoelectric, electrostrictive and magnetostrictive effects are bi-directional.

How to use smart materials to create new interactions between products and users

As there are many existing types of smart materials, there are also many ways to use them. Starting from the knowledge of the different available effects, a designer can imagine new features for his product, which would not be possible to achieve otherwise. These new features can be purely aesthetic, and aimed at creating surprise for the user, but they can also be

functional, allowing the object to adapt by itself to the environment, either to give messages to the user or to provide him or her with more convenience.

Applications of thermochromic materials

A popular type of smart materials that has already been used in large scale production for some times is the thermochromic class. These materials are commonly used for entertaining applications as furniture, clothes, hidden messages and so on, and for functional uses to give information to the user, as a warning for example. The thermochromic effect can be added to a large range of support materials as dyes, paints or pigments (Ritter, 2007). Depending on the chosen thermochromic element, the change of colour can be either a continuous gradient of colour or a unique and rapid change at a precise temperature, as shown in figure 5.

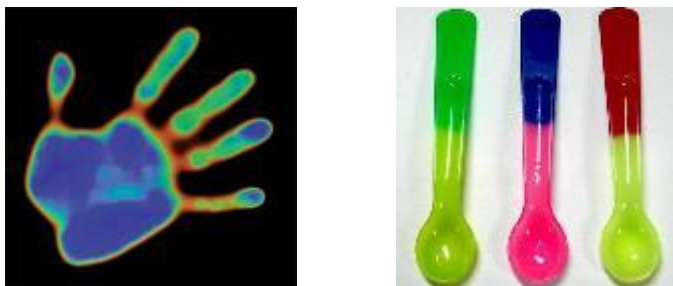


Figure 5 Thermochromic materials. Colour gradient or sudden change at a given temperature. Left: Liquid crystal ink that changes colour between 25 and 30°C, passing through all the visible spectrum, H.W. Sands Corp, source: www.hwsands.com/; Right: Thermochromic spoons, Master Batch, source: www.newcolorchem.com.

The colour gradient versions can be easily used as thermometers. It has been often used to quickly measure body temperature with more comfort than usual thermometers, and measure a room temperature in an alternative way. Some more playful applications, such as the mood rings and mood tests that use the change of colour induced by the body temperature variation to supposedly indicate a person's mood have also been proposed.

For the one-off colour change version, the object changes its colour at a given temperature that is different for each thermochromic material. This allows programming the final object to give a signal when a temperature is

reached, either to give a warning or to indicate that a product is ready to be consumed or used. For example, the spoons presented on figure 5 change colour to indicate the food is too hot to feed a baby; other uses can be to indicate to show on the kettle that the water inside is boiling, or that a drink inside a can is cold enough. Like in the colour gradient case, other uses of this colour changing properties can make an object more directly interacting with the user: especially, when the change in colour is scaled at body temperature, artefacts become sensible to touch and respond at the contact of the user. For example, thermochromic paints and inks can be used on tables and seats to indicate that someone has been there, a flu mask that indicates the user has a fever (Figure 6):



Figure 6 Left: Thermochromic table, 'Linger A Little Longer' by Jay Watson design, source: www.jaywatsondesign.com/; Right: Thermochromic flu mask, Kooroshnia Marjan, University of Borås. Swedish School of Textiles, source: <http://hdl.handle.net/2320/10207>.

Applications of photochromic materials

Photochromic effect is another example to illustrate the versatility of smart materials and the variety of their applications. A widespread use is for glasses which darken when exposed to the sunlight, protecting the user when it is necessary and turning back to its transparent state when ambient light decreases. It can also be used as an indicator of the intensity of UV radiation: in the form of bracelets, tattoos or clothes, they can indicate to the user which protection is adequate for the day. More sensitive versions of photochromic materials can also be used simply as colour changing jewellery, furniture and others, and will change colour as soon as they are exposed to natural light. Some examples are shown in the following figure (figure 7):



Figure 7: Some applications of photochromic materials. From left to right: Adapting sun glasses, Reversacol, source: www.jamesrobinson.eu.com UV bracelets, Smartsun, source: <http://wristbands-lovers.blogspot.it/>. Colour changing t-shirt, www.solaractiveintl.com.

Applications of shape memory materials

When considering materials able to change shape, shape memory materials are the ones with the widest range of applications. These materials are able to recover their original shape when heated after a deformation. Other types of materials change their shape when submitted to a magnetic field, a chemical concentration, pressure or light.

This ability to recover their initial shape has led shape memory materials to be used in many technical applications, in particular in medical field, where they are tuned to recover their shape at body temperature. In this case, they are deformed before being applied, and then perform their functions when recovering their preset shape. They are also extensively used as actuators for mechanical systems or as joints in manufacturing processes (Talbot, 2003).

Beside these technical uses, some more visible applications that interact directly with users have been developed. For example, lighting furniture can take advantage of the heat produced by lamps to change shape when switched on; shirts containing shape memory threads can roll up its sleeves by itself when the user's body temperature increases.

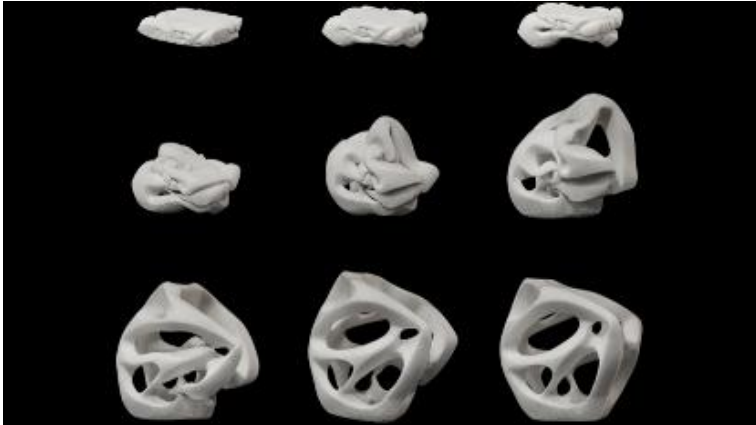


Figure 8: Shape memory chair, *Noumenon* by Carl de Smet, source: www.noumenon.eu.

Figure 8 present an experimental chair, which is stored is a flat shape representing 5% of its open shape. When heated above 70°C, it takes back its original shape. It can be compressed again and re-open.

Smart materials: discussion and prospects

As shown in the previous examples, their unique properties give each class of smart materials a wide range of applications. These applications can be either extremely technical or directly used to interact in a spontaneous way with the end users. These two different ways to use smart materials, in highly technical fields or for interaction with the end user, might seem really different, but in many cases, the very same effect can be used for both. For this reason, a link between technical and non-technical uses should be formalized, taking advantage of cross-fertilization and of aesthetic exploration to reinforce innovation in all potential fields of applications of smart materials.

A good way to improve the design practice related to smart materials will be to adapt information about smart materials in a way which can be directly used by designers. For that, it is first necessary to collect this information from material science publications and to put it all together. As demonstrated by the above examples, expressing the *functionality* of smart materials is more relevant to the design activity than conventional classifications by materials *families* or *properties*. Such an information

system should however allow the comparison between solutions using smart materials with more conventional ones using structural materials. As such, the functional information contained in the system should be efficiently linked to conventional properties, in order to give a proper perspective to the designer.

Conclusion

In order to favour innovation in industry, it is necessary to strengthen the link between technical knowledge and design practices. There are nowadays a great number of materials that can be implemented in design projects, and it is necessary to have an idea of what exists to take advantage of all the possibilities of the materials world. It is especially true with materials that exhibit unusual behaviour, such as smart materials. Indeed, these materials are able to sense stimuli from their environment and to give an output depending on the incoming stimulus. If implemented in an efficient way, these materials can greatly enhance the interactions between a product and a user.

There are many different smart materials, and each of them exhibits a different behaviour. A first step to understand what can be done with these materials is to have an overview of the different types of available behaviours. An attempt to represent these types of behaviour has been presented in this paper, in the shape of a graph categorizing the materials by possible inputs and outputs, i.e., in terms of the added *functionality* brought forward by smart materials, instead of conventional *properties* or *structural* information such as given chemical classes. This classification allows to gather basic knowledge about the existing types of smart materials, and to identify which ones can be suited to a given project. In addition, precise information and examples of applications of the targeted smart material will be needed to successfully implement these it in a design project. Following this idea, we have presented some examples of applications of smart materials. We focused on applications that directly affect users' senses, since creating new user experiences is a main advantage of smart materials over common ones. Through these examples, we can notice that among a single class of materials, there are already different behaviours exhibited, differing for example by the continuous or sudden nature of their change in properties, or by the time needed for the change to occur. Smart materials can be used either for their functional

features, or for the enhanced user experience they can provide, which is related to the general framework of interaction design.

Since smart materials differ radically from common materials by being active instead of inert, they cannot be directly included in existing material selection tools, such as Granta Design's CES. Though, it would often be useful to compare smart and common materials when working on new projects. In this way, smart materials can be considered more systematically, without restricting the project to them when it is not relevant. To allow that comparison, further work will be needed to create a selection tool that includes both smart and common materials. Further information will be needed to select a precise material and use it properly and presenting this information in an efficient way will be the aim of further research.

References

- Addington, M. and Schodek, D. (2005) *Smart Materials and Technologies for the Architecture and Design Professions*. Amsterdam: Elsevier.
- Arnall, T. (2014) Exploring 'Immaterials': Mediating Design's Invisible Materials. *International Journal of Design*, 8 (2), 101-117.
- Ashby, M., Bréchet, Y., Cebon, D., and Salvo, L. (2002) Selection Strategies for Materials and Processes. *Materials and Design*, 25 (1), 51-67.
- Ashby, M. and Johnson, K. (2009) *Materials and Design*. Oxford: Elsevier.
- Cebon, D. and Ashby, M. (1992) Computer Aided Materials Selection for Mechanical Design. *Metals and Materials*, 8 (1), 25-30.
- Cross, N. (2001) Designerly Ways of Knowing: Design Discipline Versus Design Science. *Design Issues*, 17 (3), 49-55.
- Del Curto, B. (2008) *Nanotecnologie e materiali funzionali. Strumenti per una nuova progettualità*. Milano: Epitesto.
- Desmet, P. and Hekkert, P. (2007) Framework of Product Experience. *The International Journal of Design*, 1 (1), 57-66.
- Manzini, E. (1989) *The Material of Invention*. Milano: Arcadia.
- Passaro, C., Fiorani, E., Pedferri, M. and Del Curto, B. (2013) Design the sensory: How Technologies and Materials Affect Sensations. *The International Journal of Design Education*, 6 (1), 63-76.
- Ritter, A. (2007) *Smart Materials in Architecture, Interior Architecture and Design*. Basel: Birkhäuser.
- Talbot, D. (2003) *Smart materials*. London: Institute of Materials, Minerals and Mining.

ESTHER LEFEBVRE, AGNESE PISELLI, JENNY FAUCHEU, DAVID DELAFOSSE, BARBARA DEL
CURTO

Tovey, M. (1997) Styling and Design: Intuition and Analysis in Industrial
Design. *Design Studies*, 18 (1), 5-31.

Van Humbeeck, J. (2008) *Shape Memory Alloys. Smart Materials*. CRC Press.

Participating in infrastructuring. The active role of visitors and curators in museums

Teresa MACCHIA^{*a}, Lily DIAZ-KOMMONEN^b and Vincenzo D'ANDREA^a
^a University of Trento; ^b Aalto University

Infrastructures do not exist by themselves. They are the result of converging forces actions and interactions. Different actors support and are supported by the infrastructure, in a form of interdependency between agents and artifacts. Museum as cultural infrastructure involves nonetheless practices, memberships and activities. And, the interdependence of elements in infrastructuring museum is improved and modified by the current increased introduction of various forms of technologies that changes the morphology of the museum itself, and of the role of curators and visitors. In this context, museum needs a suggestive (re)interpretation about the figure of curators in participating and infrastructuring museum.

Keywords: Cultural Infrastructure; sustainable infrastructuring; participation

Introduction

This article reflects on the interdependence between the museums, considered as cultural infrastructures, and the agents of museums, like visitors and curators. This article emphasizes the mutual influence that visitors, curators and the institution play in maintaining, replicating and innovating the infrastructure itself. In the essay, we stress the role of museum in encouraging and preserving, while enhancing, culture and knowledge, and the role of agents in stimulating memory institution. These are institutions that have been bestowed with the task of preserving the physical as well as intangible heritage of *society*, cultural identity and an educating network within the community (Bennett, 1995; Hooper-Greenhill, 1995). Most recently, as a result of the convergence of technologies and new digital practices, these institutions have been re-named as GLAMS - Galleries, Libraries, Archives, and Museum. The label seems to date back to 2001-2003 when the thrust for Creative Commons was being generated.

* Corresponding author: **Teresa Macchia** | e-mail: teresa.macchia@me.com

Currently, the use of the acronym GLAM is used in different contexts to refer to the cultural and archival environment.

The interrelationship between the museum's infrastructure and agents has a central position in replicating and reproducing those practices that allow visitors and curators to invisibly interact through the museum environment. This relationship, the one between curators and visitors, is mediated and shaped by the museum itself, and can also be said to result from social construction (re-construction), practices, and activities. In this sense, we consider the museum as an infrastructure because of the materiality, the practices and the social implication involved. Thus in this paper we focus on the production of interchanges on the process of designing for *museum*.

Considering the museum as an infrastructure indicates attention to artifacts embedded in the context, including the meaning and the (constructed) features. Nonetheless, we implicitly recognize museums as part of the background, as a *ready-to-hand* (Star, 1999) concept related to organized practices with the specific property of preserve and transmit cultural property (Marcotte and Bernier, 2011).

In this paper, we explore and discuss the role of curators in maintaining and replicating the meaning of museum, related to the affordances it provides: that means, *our way of seeing* it and discussing it.

The current notion of museum as an open instrument for instruction, invites and stimulates to represent and recognize this as an institution that is dedicated to displaying the singularity of objects, offering an environment in which reordering the structure of social life, providing a '*new grid for daily life*' (Bennett, 1995). Thus, the curatorial activity interprets and designs topics of probable social interest.

Focusing on the curatorial activity, we want to emphasize the fact that the museum, as infrastructure, endures because of the correlation and integration among the society and the culture (Pinch, 2010). Thus, this discussion focuses on the academic interest on the introduction of Information Communication Technologies (ICT) under the light of sustainability. In this context we propose to consider the museum as a cultural infrastructure (CI) in order to insert the activities and practices around the curatorial process in a specific cultural platform.

In this paper we interweave an ongoing project between the University of Aalto and the Finnish National Gallery for an exhibition on Sibelius, which opens in the 16th October 2014, with theoretical reflections related to the current museum situation. This project is about the creation of an

introductory video that has the aim to propose Sibelius' life under a contemporary light.

The next session describes the design experience at the Ateneum museum, focusing on the concept of cultural infrastructure and on the curatorial activity that endures the meaning and the scope of museum. Following the *Sibelius project*, we reflect on the contribution of digital artifacts for structuring the museum environment. Then, the following sections describe the role of the cultural infrastructure as an embedded and active result of practices that emerge by the relation between curators and visitors, who contribute in drawing the set of networks able to maintain the infrastructure, by supporting it.

Curating Jean Sibelius' life at the Ateneum museum

We participated in developing a concept for a video that will be showcased at the Finnish National Gallery as part of the upcoming exhibition for the 150th anniversary of the birth of the Finnish composer Jean Sibelius. The video focuses on the concept of synesthesia and is the outcome of a MA course at the School of Arts, Design and Architecture at the Aalto University. The synesthesia occurs where a certain experience creates independent sensory association (Rich et al., 2005). It is widely believed that the composer experienced this condition, writing music that *'agitates the human soul simply though forms that resemble nothing familiar'* (Mäkelä, 2011).

In the process of producing the concept, with curators and other specialists, we participated in discussions about the meaning, the intentionality and the expectations of the exhibition. Thus, approaching and exploring the notion of crossing senses and understanding the curatorial process behind the concept of synesthesia, we observed a convergence between different factors. On one hand the curatorial process of defining the artwork and key elements to describe and celebrate Sibelius, on the other hand the accessibility to the curatorial process through the materiality of the exhibition. In addition, the introductory video knits the curatorial activity and the accessibility to the concept of synesthesia.

The exhibition environment, the analysis of the curatorial activity, and the design process of the video invite for reflections on the role of the exhibition in communicating the intention and the concepts that curators aim to transfer on visitors. The exhibition and the artifacts related to

Sibelius are configured for the purpose to express the sophisticate and intense life and art of the composer. Specifically, the introductory video aims to especially approach young visitors through an eclectic performance.

The Sibelius' representation

With the collaboration of three students, who are expert on graphic, video and music production, we produced a video as an introductory tool about Sibelius's life. The video proposes Sibelius under a contemporary light: we re-interpreted his compositions following the principles of electronic music and we re-proposed the composer as if he would have been one of the current pop stars.

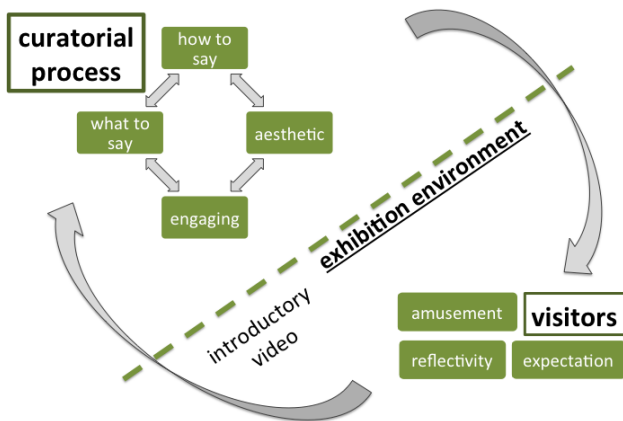


Figure 2 Cultural Infrastructuring in the Sibelius' exhibition.

The design and the production process express some of the principal elements and dynamics that make an exhibition alive. As the figure 1 represents, the introduction of this video, in the context of the exhibition, interweaves with the dynamics of production and reproduction of culture in which both, curators and visitors, take part. As part of the exhibition, the video reflects the four requires that recur in the curatorial activities - i.e. the meaning, the form, the aesthetic and the format of an artifact. The four requires of the curatorial process are replicated in the visitors experience through personal and social features. Thus, the exhibition itself and other collateral elements embed the same features and requirements that correspond to the curatorial and visiting process. During the production of the introductory video, the curatorial activity clearly emerged as a process for representing the theme of the exhibit under an engaging light,

highlighting some subjects over the other. So far, we realized that the intentions and the scopes of the curators are meant to stimulate and inspire the visitors. In the meanwhile, the visitors through their actions and their (imperceptible) outcomes influence the activities of curators. In addition, future potential visitors and the actions of past visitors influence the curatorial activities over the all process and during the exhibition as well. In fact, the curators underlined the potential and the possible interest that one choice or another could have had in hypothetical visitors.

Following and partly participating to the design of the exhibition gave us the opportunity to reflect on two main factors. First, we reflect on the introduction of interactive and non-interactive artifacts in the exhibitions. For example, the video has the double meaning to introduce the exhibition and to engage visitors through an aesthetical visual performance, without being interactive. Second, we reflect on the arrangement of museum and of the exhibition as a set of practices, representations and interactions.

In the following sections we illustrate the current meaning and the features of museum, and then we reflect on the way to consider the museum as a Cultural Infrastructure.

The evolution of the museum environment

The interest towards museum arises from the persistent and increased use of digital and interactive artifacts. Generally, the aim of these artifacts is to improve the communicative and interactive possibilities of the institution. Nevertheless it could be argued that in the course of achieving this end, they also influence how people participate to the construction of the institution itself. Because of the spreading interest on museum environment and because of the delicate role of museums in our society we draw here those aspects that, in our opinion, influence the construction of museums.

Technologies for improving and changing museum exhibition

Since cultural environments are about what they can stimulate and not what they show (Carr, 2011), the meaning of a museum, embodied in exhibition design, is to communicate to visitors at a personal level and to relate to their knowledge through a learning experience. In this direction, the introduction of Information Communication Technologies (ICT) extends and accentuates the educational and amusing scope of museums. While increasing the level of engagement and participation of visitors (Ferris et al., 2004; Fosh, 2013), the design and the introduction of ICT also extend and

accentuate the educational and entertaining scope of museum. Thus, the purpose of museum that result from the interconnection and contribution of different dynamics is amplified by the introduction of new digital artifacts, such as digital tabletops or interactive projections. For example, these technologies allow visitors to simultaneously participate in activities meant to provide alternative views of the exhibition (Geller, 2006).

The mutual impact between technologies and human activities in the museum, suggests an ecological interpretation to analyze museums. In line with the ecological perspective, Nardi and O'Day (1999) describe the environment as a system where *'human activities are served by technologies'*. Accordingly with the authors, the metaphor of ecology sets a cluster of properties that define the environments in which technologies and artifacts are used.

Talking about museum, at the same time, we talk about a complexity of relationships and of practices and routines that evolve and align with the introduction of new technologies. Consequently, the environment of museum is an active space where people's actions can be supported by diverse forms of technologies. And, technologies and interactive artifacts play an essential role for mediating interaction and for improving the relation between the visitors and the museum. In fact, recent literature describes visitors as core subject and as the beneficiary of a greater part of research projects about museums (Simon, 2010; Kaptelinin, 2011). In the meanwhile the role of curator and of exhibition designer is on the background even implicitly recognized and discussed by professionals (Macdonald, 2006).

Technologies and curators: new perspectives

As previously emerged, the interest on visitors increased since increased the introduction of various technologies in the museum environment, while the discussion on curators is still on the border. An example that highlight the importance and the need to discuss about the role of curators is a conference entitled *'Event Culture: The Museum and Its Staging of Contemporary Art'*. The conference by the Arken Museum of Modern Art, the Louisiana Museum of Modern Art, and the Copenhagen Doctoral School of Cultural Studies, and discussed the changed figure of curators and the related influence of technologies. During the event emerged that un-permanent curators' profile and the introduction of technologies influence the design of the exhibition and the role of institution as a whole. Since the conference took place in 2009, some steps have been done to consider the

roles of curators and visitors. For example, Kaptelinin (2011) underlines the complexity of museum activity and of the circumstances where museum artifacts and technologies are taking place among visitors and curators. Simon (2010) highlights a controversial paradox in the act of including visitors in museum processes, like the curatorial activity. The museum staff stands in the middle of the traditional relation among curators and visitors, and the new forms of collaboration. Moreover, with the growing accessibility to smartphones and other mobile devices, museums provide visitors with different technologies to share and show outside of the physical museum walls the content of the exhibition. Visitors can use several social platforms, and can influence the way to live and to design the infrastructure. Some other research trends focus on the curatorial work and on the related activities; for example, Wolff and Mulholland (2013) underline the significance of research to build the narration of the exhibition. Hence, the role of curators in infrastructuring museum and setting the sustainability of culture is nonetheless related to the introduction of technologies that directly interweave the curatorial activity, with the infrastructure and with visitors.

The circularity of the museum in maintaining the institution is sustained and also a part of the society, suggests to us the relevance of a new perspective that highlights the role of cultural infrastructures (CIs).

The CIs have an important role to play in preserving ways of social interaction thus in the transmission of our notion of cultural property. We contend that they seek to support our ability to express and preserve concrete representations of culture. The circular aspect of infrastructure stresses the mutual influence between the design and use of contents and the set of rules, policies, meaning and concepts of a CI. Talking about sustainability, we aim to stress the continuing capability to reproduce and reconfigure the Infrastructure and the action environment with the use of standard resources for a long period.

Infrastructuring for the sustainability of culture

In this section, we delineate the museum as a Cultural Infrastructure, which is an active and interactive component for the production, reproduction and transmission of culture, and for stimulating creativity and participation of people to the cultural life (Brugg Bawaden, 2002). Because of the interdependence of different features, elements and practices, we use the concept of CI since the museums support and are supported by the

activity of different actors and agents. In this sense, museums influence and construct culture, as social facts based on intellect and on the way to think (Sarangi, 2009). *Culture* implies a shared way to think, interpret and act, view and behave; nonetheless, this concept refers to the creation of forms of participations and meaning making and reflection (Binder et al., 2011). Thus, museum is a fragile infrastructure (Star, 1999) that depends by the integration to the situated circumstances.

Meaning of infrastructure

Considering museum as an infrastructure, we emphasize those elements that illustrates in a manner or in another the way museum is considered and organized. Therefore we describe museum through standards features that allow us to implicitly recognize elements of museums referring to the context, norms, customs, processes, members (who is *in* and who is *out*), and language (Busch, 2011). In this frame we adopt a phenomenological approach to consider the museum: how this infrastructure is used, how is it spoken or designed? Which kind of practices can we observe? This way to approach infrastructure highlights the enormous range of elements and features of the museum that can be practically experienced and commonly recognized. Humans need a common and standard format to be informed about the infrastructures, to use and/or to design them. Thus, the concept of CI displays some aspects and keeps from others elements of the museum institution.

Paraphrasing Bowkers and Star (1999) who refer to hypertext, infrastructures reflect a process of association, estimation, and judgment about the elements that characterized the infrastructures themselves and the circumstance. In respect to the process of recognize and estimate an infrastructure we, nonetheless, follow some concepts and previous idea about 'what is a museum?' or 'which are the meanings of this institution?'. In this perspective, Heidegger (Scharff and Dusek, 2014) reflects on practice and theory referring to *present-at-hand* (Vorhandensein) and *ready-to-hand* (Zuhandensein). Whereas *present-at-hand* refers to theoretical anxiety of a world made by objects, *ready-to-hand* refers to practical relations that are previous of the theoretical perspective. Having in mind the notion of standards and of ready-to-hand notion, we reflect on the process of curating and designing for museum, to reproduce the meaning of the institution. The practice of curate and design exhibition implies the embedded features of infrastructure. As Bowker and Star (1999) describe, an infrastructure is more then 'social, political and economic work as it is

theoretical'. Infrastructures are embedded in the environment and are transparent, as immediate on their use. They support their meaning and are part of a specific community of practices that shape the infrastructure itself. In the end, infrastructures support multiple functions; in the case of museum the basic function of education and of amusement can be related to the function of socialization. Thus, the construction of infrastructure embraces relationships located in specific environment, and characterized by work practices and standards mutually and implicitly recognized by members of the community.

Infrastructuring exhibitions

The common sense suggests that the infrastructures operate on the background and are available for being used. Nevertheless it is not as easy as it seems, in fact Stars and Ruhleder (1996) emphasize the contingency of practices and relationships and transparency of infrastructures embedded in the environment. Besides, Binder et al. (2011) remark the contextual property of infrastructures, which can never be decontextualized, neither reduced to a mere platform, since they result from practices and relationships.

In this frame, CI refers to practices and relations of transmit cultural property, and to the ability express and preserve visual and concrete representations of culture (Marcotte, 2011). In this context, we can divide infrastructures between those, which actually produce and spread the material, and those, which communicate the cultures themselves. Following the classification proposed by Marcotte (2011), we consider the museum as both a material and a communicative CI. Therefore, infrastructuring museum means design to configure and (re)propose the environment, as spatial and as set of interactions. The configuration of environment depends on the way the elements are arranged in the space and as well on the way that the infrastructure is planned and designed in respect to the context. In fact, infrastructuring concerns a platform of actions, practices, activities and people. In this framework, the museum is part of the invisible double-direction relationship between curators and visitors, who participate in infrastructuring, maintaining and replaying of the museum itself. Thus, the connection between curators and visitors is a form of mediated relationship, while the cultural infrastructure is a tangible channel that connects visitor's experience and curators' design process of the exhibition.

Curators are called to design points of access to the culture, creating basis and element to understand and identify practices and activities that

endures the museum. Nevertheless the curatorial activity has a collective dimension that interact the material and the conceptual environment, and an 'individual' dimension, as well. We consider as individual dimension the practice of narrating and represent culture throughout the use and assemblage of artifacts 'ready-to-tell'.

Reflections on museum: convergences between practices, community and context

Design, create, and understand museum infrastructure; the challenge of infrastructuring museum stands on the ability to consider the multiple features and elements that characterize museums.

Reflections on the meaning of the introductory video for the exhibition about Sibelius evoke thoughts about the embedded position of museums among the interconnection between the agents who act in the environment. The approach to produce the video for the exhibition is a representation of infrastructuring museum. What is the scope of the video that represents the concept of synesthesia? And, how the museum, as a memory institution, is supporting visitors in understanding and reproducing culture through this exhibit?

Infrastructuring museum is related to a set of factors that are mutually involved in the cycle of producing and reproducing culture. And, the current wide possibility to use numerous forms of digital media to communicate (with) and to *seduce* visitors needs additional theoretical understanding about the context and about meaning and practices involved. Through the observations in this article, we foster new perspective for infrastructuring museum, which means to design and to think through and for museum. Thus, this work aims to suggest an inclusive interpretation about this field of research, which is correlated to enhancing technologically that improves the context of museum itself.

References

- Bennett, T. (1995) *The Birth of the Museum. History, theory, politics*. London: Routledge.
- Binder, T., De Michelis, G., Ehn, P., Jacucci, G., Linde, P. and Wagner, I. (2011) *Design Things*. Cambridge: The MIT Press.
- Bowker, G. and Star, S.L. (1999) *Sorting things out: Classifications and its Consequences*. London: The MIT Press.

- Brugg Bawden, A. (2002) *Access and the cultural infrastructure*. Issue Paper, Art, Culture and the National Agenda, Washington, D.C., Center for Arts and Culture.
- Busch, L. (2011) *Standards: Recipes for Reality*. Cambridge: The MIT Press.
- Carr, D. (2011) *Open Conversations: Public Learning in Libraries and Museums*. California: Libraries Unlimited.
- Ferris, K., Bannon, L., Ciolfi, I., Gallagher, P., Hall, T. and Lennon, M. (2004) *Shaping experiences in the hunt museum: A design case study*. Paper Presented at the Proceedings of the 5th conference on Designing interactive systems: processes, practices, methods, and techniques, New York.
- Fosh, L., Benford, S., Reeves, S., Koleva, B. and Brundell, P. (2013) *'See me, feel me, touch me, hear me': Trajectories and interpretation in a sculpture garden*. Paper presented at the CHI 2013 Conference, Changing Perspectives, Paris, France.
- Geller, T. (2006) Interactive tabletop exhibits in museum and galleries. *IEEE Computer Graphics and Application*, 26 (5), 6-11.
- Hooper-Greenhill, E. (1995) *Museum and the shaping of knowledge*. London: Routledge.
- Kaptelinin, V. (2011) *Designing technological support for meaning making in museum learning: an activity-theoretical framework*. Paper Presented at the IEEE Proceedings of the 44th Hawaii International Conference on System Sciences, Hawaii.
- Marcotte, P. and Bernier, S. (2011) Les infrastructures du secteur culturel: une proposition de définition. *Loisir et Société / Society and Leisure*, 34 (2), 95-119.
- Macdonald, S. (2006) *Expanding museum studies: An introduction*. In Macdonald, S. (eds.) *A companion to museum studies*. Oxford: Blackwell Publishing.
- Mäkelä, T. (2011) *Jean Sibelius*. Woodbridge: The Boydell Press.
- Nardi, B. and O'Day, V. (1999) *Information ecologies: using technology with heart*. Cambridge: The MIT Press.
- Pinch, T. (2010) On making infrastructure visible. *Cambridge Journal of Economics*, 34 (1), 77-89.
- Proctor, N. (2010) Digital: Museum as platform, curator as champion, in the age of social media. *Curator: The museum Journal*, 53 (1), 35-43.
- Rich, A.N., Bradshaw, J.L. and Mattingley, J.B. (2005) A systematic, large scale study of synesthesia: implications for the role of early experience in lexical-colour associations. *Cognition*, 98 (1), 53-84.

- Simon, N. (2010) *The participatory museum*. LaVergne: Lightning Source.
- Scharff, R.C. and Dusek, V. (2014) *Philosophy of technology: The Technological Condition: An Anthology*. Oxford: Wiley Blackwell.
- Star, S.L. and Ruhleder, K. (1996) Steps toward an ecology of infrastructure design and access for large information spaces. *Information systems research*, 7 (1), 111-134.
- Stars, S.L. (1999) The ethnography of infrastructure. *American Behavioral Scientist*, 53 (3), 377-391.
- Stogner, M.B. (2009) The media-enhanced museum experience: Debating the use of media technology in cultural exhibitions. *Curator: The Museum Journal*, 52 (4), 385-397.
- Wolff, A. and Mulholland, P. (2013) *Curation, curation, curation*. Paper Presented at the Proceedings of the 3rd Narrative and Hypertext Workshop, New York.

The Human Creator as an Interface

Sandra PLONTKE*

Ruhr-University Bochum

In this paper, the author applies a posthumanistic perspective on the development of graphic designs by using the creation of digital trading card motifs (TCM) for a computer game as an example. Drawing upon some key perspectives from Actor Network Theory (ANT) and Science and Technology Studies (STS) she aims to show how fruitful these approaches can be by presenting and discussing empirical data collected in the field of computer game development. Based on the data, it is illustrated how a specific graphic task is tackled and solved and what kind of factors play a decisive role within this process in which humans, tools and other things constitute together what we usually call 'human creativity'. Finally, attention is drawn to how this perspective not only changes our traditional understanding of the role of humans as creators but also our understanding of creativity.

Keywords: *Graphic design practice; video game development; heterogeneous engineering, creativity; ANT; STS*

Introduction

In my following remarks I will apply a posthumanistically informed perspective on design and design processes in video game development. Thereby I will focus on the principle of symmetry, one of the key aspects of ANT (Callon and Law, 1997; Latour, 1999) which places 'the human not above materials (as the creator or user) but among materials' (Sørensen, 2009, p. 2).

Taking this analytical perspective, I would like to conceive the designer as an interface. This understanding aims at two complementary goals: First, decentralizing the subject by dislocating it from the center of its environment where traditional humanistic thinking used to place it and put it in the midst of things instead; second, paying much more attention to the 'patterns of relation' (Sørensen, 2009) between humans and technology,

* Corresponding author: **Sandra Plontke** | e-mail: Sandra.Plontke@ruhr-uni-bochum.de

including the relations between humans and things. Humans engaging in practices of production, e.g., of a particular graphical content for a video game, should therefore not be seen as the commando center, but rather as an interface where things are connected with other things which results in the emergence of dynamic socio-material relationships that involve the user as well. As Grint and Woolgar (1997, p. 92) put it, the 'user's character, capacity and possible future actions are structured and defined in relation to the machine', or with other words: they are configured by technology and things. Since against this background, '*any thing* that does modify a state of affairs by making a difference is an actor' (Latour, 2005, p. 71) and things do not just serve 'as a backdrop for human action' (Latour, 2005, p. 72), the perspective I am going to propose will also affect our traditional understanding of creativity, its place and its constituents.

A concrete example from the field of graphic design in game development will help illustrate some key characteristics of socio-material assemblages and the decisive role that interactions between human and non-human actors play in their creation. Thus, the attention will not be on the classical assumption of stable ontologies but on patterns of relation. In some regards, this point of view corresponds to Whitehead's process philosophy and its methodological consequences: '[...] how an actual entity becomes constitutes what that actual entity is [...] Its 'being' is constituted by its 'becoming' (Whitehead, 1978, p. 23).

Taking the above mentioned considerations, mainly those from ANT and STS, as a point of departure, I will focus on analyzing graphic designs in their becoming by drawing upon Law's (1989) concept of heterogeneous engineering.

Heterogeneous engineering

In his often quoted essay on heterogeneous engineering, Law raises two central questions: 'How do objects, artifacts, and technical practices come to be stabilized? And why do they take the shape or form that they do?' (Law, 1989, p. 111).

To answer these questions, he uses the example of Portugal's commercial and naval dominance on the Indian Ocean in the 15th/16th century which he portrays as a process of heterogeneous combination of diverse social and material components. Analyzing the 'conditions and the tactics of system building' (Law, 1989, p. 113) he describes, among other things, how the Portuguese ships were trimmed in a way that responded to

the needs in a hostile environment: In order to traverse the seaway to India safely, the ships had to withstand the raging waters of the Atlantic Ocean, Cape Bojador, the African littoral and hostile Muslim traders. Law emphasizes that he does not want to over determine the social, like social constructivism does, i.e., he does not want 'to add the social as an explanatory afterthought' but rather understand it as 'a purely contingent matter' (Law, 1989, p. 113), emerging from the interplay of a variety of human and non-human variables.

In my description and analysis of the development of specific graphics for a computer game, I will employ Law's key expositions when asking how a graphical artefact or asset for a computer game is being stabilized, how it takes shape and how it ends up having the appearance it finally has. Therefore, I will take a closer look at how material and social components are being enrolled in design practice and what kind of resources, discourses, 'viscourses' (a concept coined by Knorr-Cetina, 1999) and other factors developers of computer game graphics need to relate to when engaging in the process of game development.

For this purpose, I will describe how in design practice different components are trimmed and shaped in a way that allows them to become part of a stable association with other elements, an association of otherwise disparate parts. In the same vein, I will pay attention to the question in how far the becoming of an artefact, e.g. a graphic design, is exposed to so-called 'trials of strength' (Law, 1989) that will or might influence their final appearance.

Against the background of these questions and analyses, the answer to the question what creativity means will largely be left to the practices themselves, i.e., I will avoid giving an a-priori-definition of creativity but have the practices themselves define what an adequate understanding of creativity is or might be within the field of my observations. Methodological justification for this approach is provided in the idea of 'bracketing' which Garfinkel and Sacks proposed to control for precipitate assessments and conclusions in scientific research (Garfinkel and Sacks, 1970).

Graphic design as heterogeneous engineering

The following ethnographic descriptions are based on participant observations I conducted in a field of so-called creative industry, more precisely in video game development. In this paper I will concentrate on observations regarding a very specific practice within this complex field: the graphic design. In particular I will refer to observations on the development

of playing card designs for a mobile game, a so-called Trading Card Game (TCG) or Collectible Card Game (CCG). Of course, it is impossible to provide a complete picture of a graphical artefact's genesis, but I will try to convey at least an insight into the relations and interplay of some important aspects and practices that constitute some of the sub-plots of the larger story. Thus, I hope to contribute to a better understanding of the logics and dynamics in the practice of digital image production.

The heterogeneity of a graphical artefact: The interplay of different materialities and socio-material components in Trading Card Motifs (TCM)

Equivalent to traditional paper-made collectible card games (e.g., *Magic: The Gathering*, *Pokémon* or *Yu-Gi-Oh!*), digital cards can also be bought, collected, exchanged, traded, won or lost in playful competitions on a worldwide virtual market place. A graphical artefact like a single collectible card is therefore connected to social and economic interests and activities that create and foster new socio-material relations and connects a growing number of different actors and factors. It is this kind of interplay that creates the game with its market, the buyers, winners, losers, etc. Thus, the TCG is quite similar to Law's galley, 'an emergent phenomenon, that is, it has attributes possessed by none of its individual components' (Law, 1989, p. 115).

A first look at the different materials shows, that besides rendered 3D models which the game developer buys from professional providers and amateur tinkerers on the internet, it is especially photo elements found or bought on the internet as well as self-recorded and digitally drawn elements that find their way into the card motif. I want to illustrate how these components come together and which additional elements associate with them in the practice of card image development by telling a sub-story about the creation of realism (i.e., realizing) in the motif.

Realizing a TCM: The creation of 'real world effects' as socio-material association

On this day, the graphic designer works from home and I have the opportunity to observe him for a few hours. I am sitting on a sofa behind him, my notebook at my side. A video camera which will record the activities of the next few hours is placed at an angle behind the designer and his desk. In addition, a screen-capture program records the individual steps as they appear on the left of two screens in front of the graphic designer.

The right screen is the image viewer which he continuously engages with during his work. It provides components which are relevant for the TC motifs, in particular photographs, 3D models, textures, tryouts, private photographs (e.g., holiday pictures) that might once be helpful, and footage from previous research on the designer's current project. The materials stored in the files of the image viewer also contain visual artefacts like tables, charts, slides and sketches that were partially produced in cooperation with colleagues and help planning and communicating certain steps that need to be taken within a project. Many of these items might carry and document 'viscourses' (Knorr-Cetina, 1999). The screen of the image viewer is connected to the other screen by an infrared interface.

Polygons for reality: lowbudget - lowpoly

Let us continue with a comment made by the graphic designer (G.D.) while he was working on one of the trading card motifs:

G.D.: 'So we have purchased these models, which can be easily done on the internet; we then rendered the stuff the way we had agreed on. And the last step now is actually to let these things look a little bit more real. Absolutely real is not what you want since you cannot achieve that kind of one hundred percent photo reality in low budget range anyway.'

The targeted realistic style of the card design is a 'hybrid style' (to borrow a term the graphic designer will use himself late on). This style, which will make the later appearance of the card motifs look more realistic, is to be understood as a result, not as a cause of heterogeneous components and factors involved in the manufacturing process. Among other factors, it is economic conditions that help explain the shape and appearance of the motifs since they are developed in a low budget range. 'It is a task', so another comment by the designer, 'to create photo-realistic images within a low budget framework'.

This economic factor becomes a technical one when it comes to the purchasing of 3D models which - as in this case - form the basis for the whole project, for example because they are cheaper than photo motifs that you could also buy. Therefore, the developer must do with fewer monetary resources and correspondingly cheaper 3D models which are characterized by a lower polygon count. With regard to their form and surface structure, such 'lowpoly models' appear less realistic. The relationship between polygons and realistic appearance sounds almost trivial: If the polygon count is too low, forms that are supposed to be round appear edged which

challenges a certain idea of reality. Watching the designer work on the TC motifs, I can see how he is repeatedly challenged by what he calls 'the classic problem of lowpoly edges': Things that show up at the surface, borders and edges that he calls 'ugly', 'square' or 'edgy' need to be smoothed to make them appear more realistic and fit into the overall picture. I will return to this observation below. Here, we can just state that it is - inter alia - economic and related technical factors that provide us with a partial explanation for the shape and appearance of a graphical artifact.

'We need mud, mud and dirt' – 'Real word effects' for rendered 3D models

Another aspect is that many of the rendered 3D models that are used for the TCG have very well-evenly textured surfaces, poor of details. The models appear brand new, almost sterile, without a credible narrative that could help connect them to the real world. To create a 'real-world effect' on the side of the viewer, the designer has to modify the textures by adding dirt, scratches, rust and other details. A clean and sterile image element prompts the designer repeatedly to change it and thus to create a semblance of realism. He points at a section within the motif in front of him and comments as follows:

GD.: 'In order to increase realism, all of this is still too clean. Here I should add some dirt. The way it looks now, it actually is too dull to seriously meet the demands of photorealism.'

The designer solves this problem by digitally drawing the modifications into the image himself (using Photoshop) or by drawing upon photographic elements that are transferred from the original source into the TC motif.

In the example I am giving, the designer is concerned with making the appearance of a military vehicle look more realistic:

GD.: 'Now we need mud, mud and dirt. I can take that from other photographs.'

The designer turns to the right monitor and sifts through the files of the so-called image viewer, looking for materials that are relevant for the tuning of the card motifs. Besides the rendered 3D models, here is also a whole collection of different photos and photographic elements. Out of a vast variety of different designs that the image viewer offers him, he chooses a

photo element reminiscent of an old green painted metal piece, drizzled with mud and similar to a metallic joint of an old heavy door. Using his mouse, he draws the graphic from the image viewer directly to the left computer screen where the image now appears in the foreground of the TC motif which he is working on in Photoshop:

GD.: 'Again, the same principle: Actually, you cannot use the whole image for anything, but a certain color section, this one here, that is interesting; it is this rusty section and I can take it out along with all the other eroded sections and start to soil the vehicle.'

The designer selects only those elements that he considers 'interesting': the brown, mud-like splashes and rusty looking elements. He strips them from the surface of the photo and then pulls them into his TC motif. He pushes them back and forth over the front tire and the ground-level of the rendered car-model's body. After some back and forth movements the appropriate position is found. The densest area of the transferred texture is now on the front tire, isolated elements or mud splashes end up on the body of the car. Then the designer corrects the color of the transferred elements and adapts them to the other ground color of the motif. Part of the transferred elements still tower over the tires and the vehicle's body out into other areas of the picture. The designer 'cleans' the image by removing the supernatant elements.

These descriptions of a certain practice show how a graphical artifact recovers shape. They show how human and non-human actors enter into a relationship and how heterogeneous materials interact while forming an association of photo elements and a rendered 3D model. Moreover, they illustrate the ability of the individual actors to initiate actions on the side of other actors or to delegate tasks within the network of actors. This all is about the question how all the actors are '*associated* in such a way, that they *make others do things*' (Latour, 2005, p. 107) and thereby help something new to arise, for example a digital picture.

Notice that initially the 'photograph itself' is not of interest for the designer. The photograph and the designer are 'disinterested' (Latour, 1987), they do not have a relation to each other. In order to produce interest, another actor is needed, in our case that is the model of the vehicle which is far too clean and thus initiates action by the designer who needs to soil the car in order to make it appear more realistic. It is the rendered model, so to speak, that awakes interest in the designer to search the files

of the image viewer for suitable photographic material. Further, it is only a very specific area in the chosen photography which the designer is interested in, an area composed of colors that the rendered 3D model of the vehicle demands: a rusty spot that reminds of dirt and mud stains. So the picture offered by the image viewer does not enter the TC motif as a whole; it is only a small section which is transferred to the card motif and which thereby is transformed to dirty and rusty spots on the tire and the body of a vehicle. In this process, the vehicle itself also changes, it becomes part of a new narration: now it is old and used, it drove through mush and mud, it has experienced reality. And what about G.D.? When G.D. draws and pushes the elements around, when he throws dirt onto the TC motif, when he adapts colors and arranges shadows, etc., he becomes a graphic designer, an author, a tinkerer who narrates a story which began before he started telling it and which is not narrated by him alone. Seen under a certain perspective, all actors involved in this story (including me) are story tellers, engaging in a process which is at the same time closely related to 'translation', an endeavor 'to connect, to displace, to move, to shift from one place, one modality, one form, to another while retaining something. Only something. Not everything. While therefore losing something' (Law, 2002, p. 95).

The association of disparate parts and trials of strength

Designers can be seen as system builders who like all 'system builders seek to create a network of heterogeneous but mutually sustaining elements. They seek to dissociate hostile forces and to associate them with their enterprise by transforming them' (Law, 1989, p. 121).

I already described how heterogeneous elements are not just brought together but need to be changed and adapted in order to enter into a relationship and help building a graphical artifact like a TC motif. The soil added to the rendered 3D model must first be detached from its original place, before it finds its way into the card motif as a texture element. This does not only serve a more realistic appearance of the rendered 3D model, but also the association of disparate elements that then can interact with each other in a stable compound. When the designer finally adapts the color of the transferred texture (dirt/mud splashes) to other image components, namely the colors of the ground, then a coherence of different image components (mud/soil/ground) is generated which shows in the (betraying)

message to the viewer that the dirt and mud on the vehicle stems from the very same ground that can be seen on the card image. Here, we can see that associating the components in a way that brings about the graphical artifact is 'contingent but not arbitrary' (Sørensen, 2009, p. 35).

Another problem that needs to be dealt with is the already mentioned difficulty in working with lowpoly edges of comparatively inexpensive 3D models. G.D., the designer, calls this difficulty a 'classic technical' and 'render related' problem. When rendering the model, the low quota of polygons results in 'unendearing sharp edges' that somehow show how the 3D model offers resistance against its transformation and transplantation. The trial of strength is not yet won and the opponent has not yet become a component of the digital image.

GD.: 'Here are some more things that are very typical for render-elements. You always have such edge-effects and in most cases I render them away because this gets on my nerves, especially if I want to do something photorealistic [...]'

Since the designer wants to build something that 'feels homogenous' (see below), the 'edge effects' need to be retouched. Otherwise the render elements would not merge with the other levels of the image but instead separate themselves from the rest of the picture. These edge effects 'get on the nerves' of the designer who performs as a producer and recipient at the same time. They irritate and distract him, they threaten to destroy a photo-realistic impression and the 'real world effects' he is aiming at. It seems that there is a dissociation impending, brought by the gaze of the viewer. Picture and gaze appear as opponents.

Internal conflict and the struggling gaze

The visual coherence and consistency of the whole technical image or visual artifact is an essential aspect in generating the TC motifs. They protect the image against dissociation, on the one hand (as I will show below) through the eye of the beholder - the gamer or user -, on the other hand through individual card designs within the entire TCG which will consist of more than 100 cards when completed. However, both trials of strength are related. Let us start the analysis with a short interview sequence where I start by asking the designer to comment on one of his earlier statements:

I.: 'Why is it that one avoids too much reality?'

G.D.: 'It needs to be consistent. If you pursue utmost reality all the time and there are some motifs that are not convincing, they will tear down the whole project. That's not what you actually want; rather you try to find a hybrid style so that all the things feel homogenous.'

The card motifs - not seen as individual components but in their collective appearance and interplay in the TCG – have quite an impact on the success of the whole project and on the survival of individual card motifs as well. Card motifs that could harm the whole project because they do not match the degree of reality in the other cards would bring inconsistency into the game. Therefore, they are sorted out. Interestingly, they threaten to dissociate the whole game, which means that the 'hostile environment' (Law, 1989) the cards have to cope with is created by the cards themselves. The system builds its own environment. One strategy to protect the system against its own weaknesses and against self-destruction is the pursuit of a 'hybrid style' that helps to keep the attack surface as small as possible.

The TC motif, however, is more than a network composed of inter- and intra-actions. It is not hermetic. Therefore, we must take the interactions with the external sphere of the technical image into consideration and we must oscillate between image and viewer (cf. Akrich, 1992, p. 206). It is not only the developer of the TC motifs who interests us, it is also the viewer of the motifs, the user or the gamer, as well as the question how he is associated with the TC motif. The user's view can dissociate the card motif and simultaneously the whole game because the creation of realism and real world effects is always closely related to effects of reception. Although the use of a 'hybrid style' aims at disarming the viewer's dissociating gaze, the card game stays vulnerable. How can you know if the graphics will please the user? Can you really argue about taste? How do you associate the user and the TC motif? Remember that the galley in Law's story had to master the way to Cape Bojador before it lost against the powers of the Atlantic Ocean (Law, 1998).

In game development, you will not throw your product into the waters of the market and watch if it will swim or drown. The risk to waste resources, human power and material and to lose money would be too high. In order to secure against such risks, there is an internal Quality Assurance (QA), composed of test gamers who simulate and configure (cf. Grint and Woolgar, 1997) the user by giving feedback regarding different aspects of the game, including aesthetics and functionality. In addition, there are trial

balloons and softlaunches. In a softlaunch, for example, the game is put at the disposal of a selected group of users without advance marketing.

G.D.: 'We have about 120 card motifs and for the softlaunch we would need about 75 to 80. Then we can see if the game has a chance to survive on the market and how the aesthetics is evaluated. At that point the financial investment is not that high so that we could still say: "You know, our idea concerning the aesthetics does not really work. I think we should bring in more photorealism.'

Designers have ideas about various aspects of the world, 'they make hypotheses about the entities that make up the world into which the object is to be inserted. Designers thus define actors with specific tastes, competences, motives, aspirations, political prejudices, and the rest' (Akrich, 1992: 208). Via 'usability trials' (Grint and Woolgar, 1997, p. 78), they test the adequacy of their ideas and use the interaction with test gamers in order to update and generate knowledge about the users and their preferences which is then translated into the TC motif, its form and appearance. Thus, they 'inscribe' their 'vision of (or prediction about) the world' into the visual artifact (Akrich, 1992, p. 208). The user's vision as well as his taste enter the design which adds to the realism the designer is aiming at and helps to understand the TC motif as a heterogeneous, socio-material entanglement.

Concluding remarks on creators and creativity

In this paper, I focused on understanding the role and the place of the creator in the process of creation, illustrating my arguments with empirical data gathered in a specific field of graphic design in game development. Although not explicitly mentioned, the perspectives taken in this paper, do not solely concern the concepts of creator and creation but also the related concept of creativity. Since the latter in particular has played a considerable role in philosophical and social scientific thinking for some time now, in these concluding remarks I will summarize the results of my investigation and simultaneously give an idea in how far they serve providing an alternative perspective on creativity.

Approaching creativity in a humanistic perspective has a long tradition. Just think of the characterization of artistic genius in the aesthetics of the second half of the 18th century, where the artist's autonomy within his act of creation was celebrated. In the field of creativity research, different levels

of analysis are distinguished which leads to an artificial separation: the creative personality (Guilford, 1950), the creative product (Arnold, 1959) and the creative process (Anderson, 1959). In fact, the perspective on creativity as a personality trait takes the persons environment and interactions into consideration but sees them as determinants without providing a suitable perspective to analyze the phenomena involved in a relational way. The human remains the sole and almost lonely center of creation. This is one possibility to tackle creativity. Our story about creativity is different.

I described the graphic design practice and the work on a TCG in a posthumanistic perspective by emphasizing the ‘patterns of relation’ (Sørensen, 2009) of human and non-human components. If the practices have to define what creativity is, then we have to understand creativity as a part of these practices. I showed how different materialities and heterogeneous – humans and nonhuman – components are transformed in various interactions and how these components found their way into the design of a TC motif. Within this heterogeneous interplay, creativity cannot be understood as a merely human property or ability but is performed as part of an ongoing process of change. Within this network of changes a stable definition of creativity cannot exist. Creativity has to be detected relationally, i.e. by analyzing the relations out of which it emerges. When we think that creativity shows (e.g., as a new idea or solution to a problem) than it has to be seen as a performative effect of a socio-material assemblage, as an interaction of technology, materialities, knowledge, human and non-human agents. Bringing an artifact into shape, creating something does not depend solely on humans. In this paper, solving problems and associating disparate parts was described as socio-material practice in which the graphic designer was not placed above but among technology and materials. This leads us back to understanding the designer as an interface. The notion of the interface conceived of as a user interface or man-machine interface suggests an one-sidedness and hierarchy: the user and the tool, the controller and the controlled object. The potential for action, however, is distributed among humans and non-humans so that there is no one-sided or hierarchical interaction. As part of a network, the interface serves the communication and interaction with other entities whereby the notion of the interface cannot be assigned meaningfully *either* to things *or* humans. Rather, the interface is an unlocated location or a place in between.

References

- Akrich, M. (1992) *The De-Description of Technical Objects*. In Bijker, W.E. and Law, J. (eds.), *Shaping Technology / Building Society. Studies in Sociotechnical Change*. Cambridge: The MIT Press.
- Anderson, H.H. (1959) *Creativity in Perspective*. In Anderson, H.H. (eds.), *Creativity and its Cultivation*. New York: Harper & Rowe.
- Arnold, J.E. (1959) *Creativity in Engineering*. In Smith, P. (eds.), *Creativity an Examination of the Creative Process*. New York: Hastings House.
- Callon, M. and Law, J. (1997) After the Individual in Society. Lessons on Collectivity from Science, Technology and Society. *Canadian Journal of Sociology*, 22 (2), 165-182.
- Garfinkel, H. and Sacks, H. (1970) *On formal Structures of Practical Actions*. In McKinney, J.C. and Tiryakian, E.A. (eds.), *Theoretical Sociology. Perspectives and Developments*. New York: Appleton Century Crofts.
- Gibson, J.G. (1986) *The Ecological Approach to Visual Perception*. London: Lawrence Erlbaum Associates.
- Grint, K. and Woolgar, S. (1979) *The Machine at Work. Technology, Work and Organization*. Cambridge: Polity Press.
- Guilford, J.P. (1950) Creativity. *American Psychologist*, 5 (9), 444-454.
- Knorr Cetina, K. (1999) *Viskurse der Physik. Wie visuellen Darstellungen ein Wissenschaftsgebiet ordnen*. In Huber, J. and Heller, M. (eds.), *Konstruktionen Sichtbarkeiten*. Wien, New York: Springer.
- Law, J. (1989) *Technology and Heterogeneous Engineering. The Case of Portuguese Expansion*. In Bijker, W.E., Hughes, T.P. and Pinch, T. (eds.), *The Social Construction of Technological Systems. New Directions in the Sociology and History of Technology*. Cambridge: The MIT Press.
- Law, J. (2002) *Aircraft Stories. Decentering the Object in Technoscience*. Durham: Duke University Press.
- Latour, B. (2005) *Reassembling the Social. An Introduction to Actor-Network-Theory*. New York: Oxford University Press.
- Latour, B. (1987) *Science in Action*. Cambridge: Harvard University Press.
- Latour, B. (1999) *Pandora's Hope. Essays on the Reality of Science Studies*. Cambridge: Harvard University Press.
- Latour, B. (1990) *Drawing Things Together*. In Lynch, M. and Woolgar, S. (eds.), *Representation in Scientific Practice*. Cambridge: MIT Press.



Research Through Design: What Does it Mean for a Design Artefact to be Developed in the Scientific Context?

Selena SAVIC^{ab*} and Jeffrey HUANG^b

^a Instituto Superior Técnico, Lisbon; ^b École Polytechnique Fédérale de Lausanne

The use of design artefacts in research is a debatable topic which raises important questions about the different approaches to design research and legitimate ways of knowledge production. Research through design normally involves construction of a design artefact, which is at the core of the research process. This paper will outline some characteristics of artefacts that come out of such research practices, seeking to form a base for understanding the nature of research design artefacts and their evaluation. We will examine the process of translation from the research question into the design brief, into the prototype, back to the question, back to the prototype; until the design artefact is fit as a tool for research; or is (temporarily) discarded. The artefacts produced in this way do not necessarily serve a utilitarian purpose, but provide an explicit feedback about their use and the experience they invoke. In terms of design, they are like code with a lot of debugging print statements. They possibly never leave the studio and when they do, different levels of independence from the studio setting can be identified.

Keywords: Design research; prototype; artefact; evaluation

How does design generate (design) knowledge?

Design research extends onto several distinct research practices, whose common thread is the interest in and the use of design thinking to achieve scientific results. From design history and theory, through the research in advancement of practice, to the use of design artefacts as source of data, these different approaches outline a growing field under the general name of design research.

We can trace the beginnings of design research to the post World War II reconstruction period and particularly the boom of mass production and

* Corresponding author: **Selena Savic** | e-mail: selena.savic@epfl.ch

mass markets. From standardisation to diversification, design practice was increasingly coupled with research. This research was, at first, aimed at optimisation of design processes and results but it gradually unfolded in different directions. The results of these directions contributed to different intellectual niches. Initially the focus was on knowledge in the area of design problems, methods and processes relevant to improvement of the practice. More recently, design research turned towards perception of our environment and general acting-in-the-world. Thus design research does not necessarily generate knowledge which is useful only in terms of design practice. While the focus of historical, theoretical and procedural research is indeed on the practice of (commercial) design; there is a growing body of research which addresses more general problems of experience and social interaction. Concerned with questions critical for politics and society at large, this movement has the potential to engender 'new forms of knowledge' (Rendell, 2005) using non-reductionist design principles to arrive at unexpected insights. We could conclude that the further away research scope is from the practice of design, the more contribution it makes to general knowledge.

Origins and approaches

When speaking of 'design research' it is generally unclear whether it implies research *into* design, research *through*, research *by* or research *for* design. These categories, borrowed from Christopher Frayling's discussion on research in design and art (Frayling, 1993) are not mutually exclusive, but look for legitimacy in different fields.

While we are familiar with historical and theoretical research about design, the practice has had a more complicated relationship with research. In the 1960's Herbert Simon argued for a scientific legitimacy of design research by introducing a distinction on two types of sciences - the natural sciences (science as we knew it) and the sciences of the artificial (research activity centred around man-made artefacts) (Simon, 1996). While natural sciences kept an objective view of natural phenomena which they treated analytically, sciences of the artificial are characterised by synthesis and the ambition to intervene in the way things are, changing existing situations into preferred ones (Simon, 1996, p. 111). By separating artificial from natural sciences Simon creates space for a hierarchical interpretation of 'scientificity' in these approaches while setting the outcomes of design research close to the practice.

Frayling's view is a little different. He argues for recognition of design research as a professional practice, or as he puts it 'research with big R'. Nevertheless, something in his typology leaves us with a taste of hierarchy of importance or contemporaneity which favours cognitive tradition in fine art as an under-explored strategy that deserves attention. Frayling identifies research *through* design with the degree by studio project (awarded for example at RCA), characterised by research (results) obtained *through* the activities of art, craft or design. On the other hand, he tries to distinguish Research *for* arts and design from research written with a small 'r', leading simply to the production of an artwork or design piece. Frayling's writing is more of a call for a debate than a set of guidelines for research *for* design. Nevertheless, researches have picked up on Frayling's discussion and a certain meaning of his initial call established over time. Note a shift in meanings - what for Frayling was research *for* design is considered research *through* design (Koskinen et al., 2011), and vice versa.

The purpose of design research

The lack of concrete framework and evaluation criteria remains. There is a general agreement on the importance of this type of research amongst design research professionals. For example, a study conducted by Zimmerman and colleagues showed research *into* design as the most commonly mentioned type of design research, but it was 'this other approach' that is considered the most true to the nature of design practice (Zimmerman et al., 2010). The compatibility with design practice is a valuable incentive for dedicating more work to explicating the role of artefacts in design research.

In the beginnings of design research studies, we find in Simon's writings a well established idea that the purpose of design research is to improve design practice, with the focus on design process. Simon describes contemporary design knowledge as intellectually soft, intuitive, informal, and cook-booky (Simon 1996, p. 112). He distinguishes scientific from what he calls 'professional knowledge' (knowledge of *doing* something, as opposed to knowledge *about* something) and states that engineering disciplines (design is to be found amongst them) have mainly focused on sharing practical skills. Thus the need to make design theory explicit in order to teach a science of design (Simon 1996, p. 114).

Nigel Cross saw the opportunity to employ design research in the area of practice too. According to him, design research focuses on the study of

principles, practices and procedures of design in order to contribute to the improvement of design practice (Cross, 1984).

In their recent publications, Kroes and Dorst also agree on the utilitarian function of design research for design practice. Kroes describes design research as normative and process oriented (Kroes, 2002). He makes a clear cut between scientific and design research, the former driven by logical positivism and product oriented (with empirical claims, laws, theories and explanations as their outcome, typically). Conversely, the centring on the process conforms to the improvement of design practice as the set outcome of research. The focus of design research is on the design process itself, thus the outcome is knowledge in the area of this process.

Zimmerman offers a more open interpretation of the way design research can lead to design theory (Zimmerman et al., 2010). He recognises two types of theory that can come out of design research: theory *on* design and theory *for* design.

A multitude of literature in design studies repeatedly confirms the idea that designers' research is a doctrine about the design process and design process only. Rarely does it talk about a design practice that can be employed together with critical thinking in order to generate new knowledge outside of the discipline.

Both research *for* and *through* design are based on practice and both produce design artefacts for research, but they need to be distinguished. When making the distinction, the first thing to consider is the purpose or the desired outcome of the research. According to Zimmerman, theory is rarely the main focus of design research and it comes out of it as a by-product (Zimmerman et al., 2010); it is implicit or emergent from reflection. However, theory that comes out of research *for* design is focused on improving the design practice, thus its focus resides in the field it explores. Research *through* design is suitable to explore more general societal or philosophical problems which cannot be easily reduced. Thus research *through* design has potentially a more general theoretical outreach.

With reference to the two types of theory, research *for* design produces theory *for* design; research *into* design produces theory *on* design; research *through* design can contribute to both. According to Frayling, part of the problem lies in the perception of research as an activity. Research with a big 'R' has a pre-defined research question, whose subject or object exists outside of the person doing the research, leading to discussable, shareable knowledge. As opposed to the research with a small 'r', which is a part of (art-)making process, research with big 'R' is a profession, a professional

practice. The view expressed here is an attempt to distinguish design research from research normally undertaken in the first steps of designing process. This should not imply that making is incompatible with research but it helps identify the two distinct objectives for research to be undertaken: design knowledge and theory or insights into phenomena that could hardly be discussed otherwise.

Largely because of a lack of strong theory to guide practice but also the confusion around the purposes of research *through* and research *for* design, a new term was defined by Koskinen et al, in a book titled 'Design Research Through Practice' (Koskinen et al., 2011). Constructive design research is a type of contemporary design research, aimed particularly at framing the experience of integrating the fields of design and research. Practically, constructive design approach means something was built within the research process and put to use for research purposes. The approach is impure, experimental and based on contemporary theoretical frameworks that involve phenomenology, pragmatic psychology, research of emotions and experience.

We will refer to a research practice that uses design artefacts and or theoretical observations to come up with guidelines or frameworks which improve the practice as 'research *for* design'. On the other side, 'research *through* design' is an umbrella term encompassing approaches where the production of artefacts is explicitly driven by a research question.

The role of design artefacts in research process

With the difference in approaches demonstrated above, the discussion on function and character of the artefact coming out of research activities will take similar directions. When the purpose is generating guidelines and the focus is on the process of design (research *for* design), the artefact produced can be a found design object, as well as an object created over the course of research. '*Given* an airplane, or *given* a bird, we can analyse them by the methods of natural science without any particular attention to purpose or adaptation' (Simon, 1996, p. 6) However, when the process of design is an integral part of research, the artefact is not *given*. It is primarily conceived in accordance to the research scope and question. In this approach, the design artefact is used as a *source of data* for analysis and generalisation, and not as an external object to theorise about. If process and design object are inextricably linked (Kroes, 2002), then the design

artefact created within research *through* design or constructive design research, is understood in the light of its subject.

The (r)evolving role of design artefacts

Before going into more detail about the nature of design artefacts produced in the context of research, let us look once more into the different views of design artefacts in design research literature.

From the distinction on 'natural' and 'artificial' as mutually exclusive metaphysical categories, Simon develops his argument of equally valid research subjects - nature and artefact (Simon, 1996). Artefact is an 'interface' between the inner and the outer environments, the former defined as its inner organisation and substance, the latter as the surroundings in which it operates. Following on this, Kroes investigates 'the dual nature of design artefacts', considering their functional (input) and structural (output) properties (Kroes, 2002). It implies a dual conceptualisation in design practice. Designers are professionally trained to bridge this gap and to address both aspects.

Hooker and Farrell argue that design and science do not produce metaphysically distinct types of things (Farrell and Hooker, 2012). They criticise the interpretation of the Simon-Kroes model which implies a significant difference in the way design and science come up with artefacts. It is true that scientists do not produce natural world with their investigations, while designers do produce artificial objects, which is at root of this disjunctive discourse. However, both designers and scientists produce artificial things - while the former 'synthesise' design solutions, the latter come up with e.g. technology.

Following Simon's notion of the 'interface' we can look at design research artefacts as interfaces between the research question (outer environment) and the mechanisms it uses to give insights into phenomena (inner environment). Nevertheless, the separation on 'analytic' and 'synthetic' sciences does not help understand either of them, as both mental processes are part of research *through* design. If we keep the division on the 'analytic' and 'synthetic' in the discussion on research artefacts, we are facing the same problem identified above - there are either two distinctive sciences, or there is science and design practice, at two ends of professionalism. Either way, they belong to intellectually distant paradigms and are unable to communicate. What we propose instead is to recognize a tradition of an integrative approach to research which includes

producing design artefacts as part of research activity. How can we design 'analytically'?

From research question to design artefact

The process of developing and presenting experiments in the field of design for the purpose of scientific research is characterised by several distinctive qualities. It is less utilitarian and more conceptual; it usually involves several phases of refinement; it is aimed at a particular audience, interested in research process rather than the artefact's usability.

In order to better understand this process, we will look into examples of design artefacts that were produced in the context and for the purpose of research. How are research questions translated into design briefs? Furthermore, how are these translated into tangible design products? We will particularly focus on a research project that came out of an inquiry into perception of shifting infrastructures, developed in the framework of SINLAB research laboratory.

SINLAB was an experimental laboratory based at EPFL (École Polytechnique Fédérale de Lausanne), physically residing in La Manufacture, HETSR (Haute École de théâtre de Suisse romande). It was situated at the intersection of performing arts, architecture, science, engineering and philosophy. It was conceived as a place for collaboration of doctoral and post-doctoral researchers with stage designers, theatre directors and choreographers who came in as artists in residence.

The following discussion will detail one research process in the laboratory, or the transformation from a research question into the design brief and then into different prototypes. We will cover design and research decisions made along the way. Finally, we will evaluate this process from a research and from a design perspective. The research project described was chosen because of a clear yet changing research question it addressed; the diversity of prototypes and levels of 'finishedness' involved; and because of personal familiarity with the project development that came from involvement in all of its phases.

The research context

SINLAB's intellectual tradition is to be found closer to philosophy and performance studies than to design. The successive iterations of work were meant to feed into the common knowledge base, while attempting to answer three main research questions which revolved around time and

space perception, man-machine relations and *intermediality* in the stage context.

In order to address the first research question on transformation of perception and experience of time and space, a project titled 'Moving wall' was devised. The project was imagined as a reflection on the idea of reconfigurable spaces. It was to serve as an *experience catalyst* (Badura, 2013), hinting at new types of constellations in relation between humans and (cultural) infrastructures. These infrastructures are seen as shifting and changing, reflecting the perceived instability of contemporary life. As opposed to them, walls are seen as a symbolic order representing the concept of the solid as such and standing for stability, permanence and safety. But walls do at the same time signify shelter and prison; while they provide safety they also inhibit and isolate movement, perception, connection. The idea of the moving wall was thus devised to 'attack' this opposition of permanent vs. temporary, stable vs. changeable, passive vs. (inter)active.

The design development was focused on the intersection of aesthetics and technological development. We envisioned producing a complex interactive installation made of brick-like units that seemingly belong to a flat wall surface but are able to move and respond to external impulses.

An early stage prototype was built and tested in the lab environment. It demonstrated basic interaction principles using scrap materials and simple controls. The prototype performed sufficiently well as a demonstration of a tectonic effect of estranging our surroundings with unexpected interaction. However, it didn't go much further at that than the work already done in this field (Huang and Waldvogel, 2005).

With this in mind, some of us set on exploring other paths towards a tangible experience of instable infrastructures and reconfigurable spaces. The work that followed concentrated on the experience of activity within the wireless network infrastructural layer. It focused particularly on answering the question: 'How does the awareness of insensible infrastructures affect our experience of space?'

For this project, three prototypes were produced and presented to the public in different settings. The presentations were points of collecting data from observations on user behaviour, channelled discussion and quantitative data on network usage.

The first prototype was a cubical structure that reacted to the activity of one wireless network by changing its height. Visitors could cause the space to slightly 'shrink' or 'grow' by using more or less Internet traffic. The

second prototype introduced more complexity, offering interaction with four wireless networks that were the most active in the space. The shape was also more complex, having four peak-deformations on a flat surface of stretchable fabric. Two variations of this prototype were tested: a scaled model with peaks coming up with activity; a full-scale installation with the peaks coming down and oppressing the users, when they generated traffic. Both were tested in the lab space and in a public setting, at a research symposium (the scaled model) and with a general audience (real-life installation).

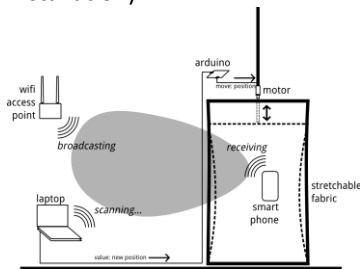


Figure 1 RKNFG interaction scheme. Laptop scanning the activity of the wireless network and controlling the height of the cubicle.

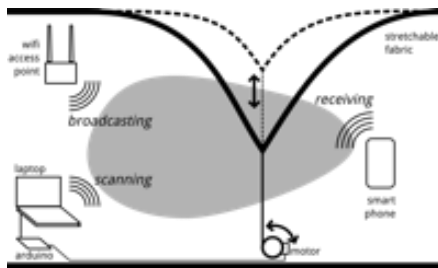


Figure 2 Quadricone interaction scheme. The peaks stretch with an increase in traffic; the users can interact directly with the space.

With open wireless networks available in the space, there was a clear feedback between the use of a network and the intensity of deformation of the stretchable fabric. However, when networks were not available, users could not make much sense of (inter)actions. They were not able to interact with the installation on an intuitive level, and kept perceiving it as a visualisation instead of a dynamically changing entity they could play with. The question of 'data arbitrary art' was also raised as the translation of wireless network traffic into four peaks (without a geo-spatial reference)

seemed arbitrary. The discussion often drifted onto particular design decisions instead of focusing on the experience. Nevertheless, these prototypes gave insight into new participatory possibilities: an interaction between digital data, physical structures and human actions.

Further design research involved a development of more complex language of reactions and a more realistic image of the activity within the wireless layer. On the structural side the setup was made lighter and more universal. RGB LED lights were chosen to perform changes in the activity with colour and movement. The colour of the light was perceived on the bodies of two performers who were at the same time interacting with the system. Data acquisition was also improved - a mobile application was used to acquire data on both EDGE/3G and Wi-Fi traffic.

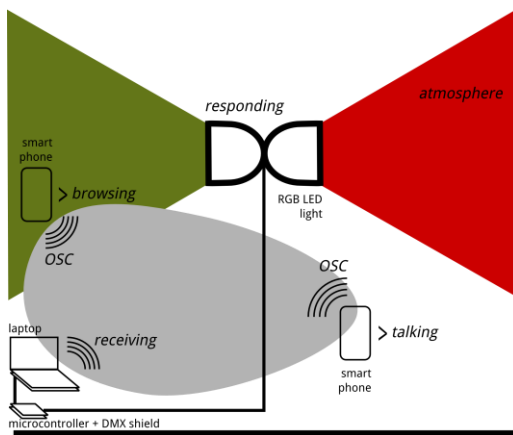


Figure 3 *Connect or Not* Interaction scheme. Lights respond to the activity of wireless networks created by the users (using an Android application).

The third prototype 'Connect or Not' offered an atmospheric experience of wireless communication, rendering the presence and the intensity of traffic (both GSM and WiFi) into an *interactant*. The interaction is manifested in the dynamic behaviour of lights (change of position, colour, flickering). It was closer to a performative tool, its design more contained. However, interaction with it was rather consuming as one had to focus on normally peripheral activities to a social event (sending SMSs, calling people or uploading images to social networks) to cause a reaction of the system, and then was too busy interacting to be able to enjoy it.

Evaluation of design artefacts

In their research into culturally embedded computing, a group at Cornell University concluded that the perceived context of an artefact (in this case an interactive display) strongly determines its experience. 'When people approached the display as a tool for improving awareness of affect, they were somewhat frustrated with not being able to match input to output. However, when people approached the display as art, they were more comfortable' (Sengers et al. 2004, p. 18). The interpretation of displayed interaction was ambiguous and frustrating when understanding the output was the goal; when simply playing with it, people were more comfortable with the openness to interpretation they encountered. Thus expectations play an important role in the experience and evaluation of research artefacts.

Zimmerman reflects on projects that come out of research through design 'not in terms of outcome, but instead in terms of characteristics of each project that made them ripe for knowledge development' (Zimmerman et al., 2010). How do we evaluate this 'ripeness'? To which extent does the artefact need to 'work' or satisfy its functional, aesthetic and ethical preconditions in order to be considered successful? Or to be useful for research? Research designs have to allow for interesting behaviours and unexpected features to become prominent research topics, like in the case of the robot Kismet developed by Chyntia Breazeal or Sengers' Influencing machine (Sengers et al., 2004). We have seen in the example of the Moving Wall that transformed into the Quadricone research, how such approach makes it hard to write up a 'design brief' which will fit the research and leave enough space for failures to become features. As Höök and colleagues found out in a series of design studies, 'to be seduced by the interaction required a very tightly designed, flawless loop' (Höök, 2008). This was not the case with SINLAB prototypes as they required a lot of assistance from researchers' side to achieve interaction. The unsmooth feedback loop made the discussion always centre on the way it works and not on the experience.

Design artefacts produced in the context of research, particularly in the case of SINLAB prototypes, are addressing a particular research question and contributing to understanding of the phenomenon under observation. It is therefore not always appropriate to evaluate them through usability standards. They are developed into tangible objects or systems, which cannot hide behind theoretical abstractions. When they are successful, they reveal relationships, provoke reactions and criticise the incontestable.

Koskinen, Zimmerman, Binder, Redstrom and Wensveen find that 'Research sets some requirements for prototypes at odds with doing good design'(Koskinen et al. 2011, p. 61). For them, a successful research design artefact helps clear up most important competing explanations.

The objective of the work described in this text was not improvement of design practice, though it could have been one of its results. Instead, as demonstrated above, research conducted within the SINLAB framework is inclined to allowing new insights in the constitution and perception of environments. It does so through construction of settings which foster tangible experience and facilitate discussion about the phenomenon under observation (Sempere and Savic, 2013). These settings serve as *experience catalysts* (Badura, 2012; 2013), seeking to catalyse a particular sensation or experience which can be discussed in the realm of design and architecture studies.

With the experience from the abovementioned and many more projects developed in research context, we could conclude that the success of a design artefact can be measured by the level of ambiguity and the focus on experience instead of design itself. When the discussion moves from design decisions onto the experience of the artefact, we can consider it 'ripe' enough to answer some of the research questions.

Conclusion

We have covered some general notions of design research, setting the ground for a study of design artefacts in research context. We saw what are the differences between three prominent approaches to design research; namely research *about* design, research *for* and research *through* design. Although there is no general consensus in literature about the precise meaning of these terms, there is a developing practice which contributes to establishment of a more solid meaning of research *for* and research *through* design. There is more room for reflection on the broader nature of design, and its relation to other disciplines than when Buchanan wrote his text on design thinking (Buchanan, 1992) and there are numerous articles and books written on the subject.

Design artefacts produced in research context are also more numerous. We can find such diverse examples ranging from explorations into a Japanese technique of fusing metal (Seago and Dunne, 1999), mixed media cultural probes (Gaver et al., 1999), to interactive visual interfaces (Sengers et al., 2004; Huang and Waldvogel, 2005; Fatah et al., 2008), tangible

interfaces and objects (Dunne and Raby, 2001; Sengers et al., 2004; Arnall et al., 2013). From this it is evident that artefacts produced in research context do not necessarily serve an utilitarian purpose, but provide an explicit feedback about their use and the experience they provide. In terms of design, they are like code with a lot of debugging print statements. The process of design is the furthest from linear and is usually characterised by decisions changing along the way.

Research *through* design is giving agency to artefacts. Researchers are not the only ones who influence the analysis process; their artefacts open unexpected doors too. More examples are needed in order for researchers to be able to compare each other's' approaches and results. This is not done with the expectation that results from prior efforts would be exactly replicated, as is the case in natural sciences (Zimmerman et al., 2010). It is rather to establish a rational base for evaluation of design artefacts in research context.

Research *through* design implies a certain type of interdisciplinarity. The research itself typically takes place at institutions which bring together researchers of different backgrounds and which designers have little control over (Koskinen et al., 2011). This does not infer that there needs to be a strong 'single-disciplinarity' amongst its protagonists. Rather, they are likely to possess interdisciplinary skills themselves, bringing their 'world views' closer and allowing for a collaboration which facilitates mutual inspiration. As Koskinen and colleagues conclude, 'constructive design researchers need methodological and theoretical flexibility' in order to be successful in such environments.

The outcome of research design practice does not appear as a final product, if it ever does, before it has been repeatedly demonstrated to different expert audiences. We could say that it gets many opportunities to attain its purpose for research, more than a commercially designed product would. Design research artefacts are rather understandable and open to interpretations by the non-design audience (Sengers et al., 2004). This opens the door to both practice of designing them and the research itself to be shared with larger audiences.

Can research give birth to independently valid, stand-alone design artefacts? From the examples we have seen and numerous articles on similar artefacts (particularly the fact general audience has not heard of most of them) we could conclude that the different aesthetic and usability expectations allow design research artefacts more freedom in both directions. With this freedom comes an opposite trend of acceptance by the

general audience. Besides a few notable examples of research design artefacts that blur the results with a high quality of design (Koskinen et al., 2011), it is evident that research design artefacts rarely become commercial products. They are both unaffordable by corporations and nonessential to general audience. However, their reproducibility cannot be used as an argument against their validity for research, as they offer a unique way of dealing with complex and unorthodox research questions.

References

- Arnall, T., Knutsen, J. and Martinussen, E.S. (2013) Immaterials: Light painting WiFi. *Significance*, 10 (4), 38-39.
- Badura, J. (2012) *Explorative practices in dialogue. Art-based research at the interface of arts, sciences and design*. In Imhof, B. and Gruber, P. (eds.), *Biornametics*. New York: Springer.
- Badura, J. (2013) *Experience Catalyst Research*. Unpublished.
- Buchanan, R. (1992) Wicked Problems in Design Thinking. *Design Issues*, 8 (2), 5-21.
- Cross, N. (eds.) (1984) *Developments in design methodology*. New York: Wiley.
- Dunne, A. and Raby, F. (2001) *Design Noir: The Secret Life of Electronic Objects*. Basel: Birkhäuser.
- Farrell, R. and Hooker, C. (2012) The Simon–Kroes model of technical artifacts and the distinction between science and design. *Design Studies*, 33 (5), 480-495.
- Fatah, A., Briones, C. and Chiron, M. (2008) *The Urban Screen as a Socialising Platform : Exploring the Role of Place within the Urban Space*. In Eckardt, F., Geelhaar, J., Colini, L., Willis, K.S., Chorianopoulos, K. and Hennig, R. (eds.), *MEDIACITY: Situations, Practices and Encounters*. Berlin: Frank & Timme GmbH.
- Frayling, C. (1993) *Research in art and design*. London: Royal College of Art.
- Gaver, B., Dunne, T., and Pacenti, E. (1999) Design: Cultural Probes. *Interactions*, 6 (1), 21-29.
- Höök, K. (2008) *Affective Loop Experiences - What Are They?* Paper Presented at the PERSUASIVE 2008 - Persuasive Technology, Third International Conference, Oulu, Finland.
- Huang, J. and Waldvogel, M. (2005) *Interactive wallpaper*. Paper Presented at the The 32nd International Conference on Computer Graphics and Interactive Techniques.

- Koskinen, I., Zimmerman, J., Binder, T., Redstrom, J. and Wensveen, S. (2011) *Design research through practice: from the lab, field, and showroom*. Waltham: Morgan Kaufmann.
- Kroes, P. (2002) Design methodology and the nature of technical artefacts. *Design Studies*, 23 (3), 287-302.
- Rendell, J. (2005) Architectural research and disciplinarity. *Architectural Research Quarterly*, 8 (2), 141-147.
- Seago, A. and Dunne, A. (1999) New Methodologies in Art and Design Research: The Object as Discourse. *Design Issues*, 15 (2), pp. 11-17.
- Sempere, A. and Savic, S. (2013) *Experience Catalyst and Architecture: Towards a New Tradition*. In Sousa, J.P. and Xavier, J.P. (eds.), *Presented at the Future traditions: rethinking traditions and envisioning the future in architecture through the use of digital technologies*. Porto: FAUP Publicações.
- Sengers, P., Kaye, J., Boehner, K., Fairbank, J., Gay, G., Medynskiy, Y. and Wyche, S. (2004) Art, design & entertainment - Culturally embedded computing. *IEEE Pervasive Computing*, 3 (1), 14-21.
- Simon, H.A. (1996) *The sciences of the artificial*. Cambridge: MIT Press.
- Zimmerman, J., Stolterman, E. and Forlizzi, J. (2010) *An Analysis and Critique of Research through Design: towards a formalization of a research approach*. Paper Presented at the Proceedings of the 8th ACM Conference on Designing Interactive Systems, Aarhus, Denmark.



D-STEM: a Design led approach to STEM innovation

Anne TOOMEY* and Veronika KAPSALI
Northumbria University

Advances in the Science, Technology, Engineering and Maths (STEM) disciplines offer opportunities for designers to propose and make products with advanced, enhanced and engineered properties and functionalities. In turn, these advanced characteristics are becoming increasingly necessary as resources become ever more strained through 21st century demands, such as ageing populations, connected communities, depleting raw materials, waste management and energy supply. We need to make things that are smarter, make our lives easier, better and simpler. The products of tomorrow need to do more with less. It is recognised that STEM subjects need Design to translate and realise their full value to the economy and that Design's role is greater than being a creator of objects. The issue is how to maximize the potential for exploiting opportunities offered by STEM developments and how best to enable designers to strengthen their position within the innovation ecosystem as active agents of change. As a society, we need designers able to navigate emerging developments from the STEM community to a level that enables understanding and knowledge of the new material properties, the skill set to facilitate absorption into the design 'toolbox' and the agility to identify, manage, contextualise and influence innovation opportunities emerging from STEM developments. This paper proposes the blueprint for a new design led approach to STEM innovation that begins to redefine studio culture for the 21st Century.

Keywords: Design process; STEM; design education; smart materials; mmerging technologies

Introduction

We imagine our man-made environment of the future as a fluid, intuitive, human centred ecosystem that will sense and react to conditions both inside and outside the space in order to provide experiences and

* Corresponding author: **Anne Toomey** | e-mail: anne.toomey@northumbria.ac.uk

ANNE TOOMEY, VERONIKA KAPSALI

services that will elevate quality of human life while coexisting seamlessly with the natural environment. The indicators that suggest this as a future eventuality we find to be within the explosion of material technologies that are entering the realms of commercial processes. A new class of stimuli responsive materials able to alter their properties in the presence of triggers such as pressure, light, temperature, moisture, electrical current, magnetic force or microbes enable designers to create products that are bio-responsive, can sense, harvest energy, alter appearance, generate light, etc. The possibilities presented by these new materials shatter the boundaries of our current understanding of the 'object' as inanimate and usher us into a new era of 'intelligent/animated' products, surfaces and systems. The increasing activities around the world that explore ways of using these materials in, on and around the body is transforming science fiction into science fact; the field of wearable electronics, for example, resided mainly in sci-fi narrative and exclusive technology driven labs that strapped clunky electrical components to the body 20 years ago, today, is becoming a commercial reality.

The authors have extensive knowledge in textiles and fashion at the boundaries of Design and STEM from the perspectives of both higher education and industry funded research. This experience combined with industry driven discourse has led to the identification of a gap in designers' capabilities and training that prevents the seamless transfer of information between the STEM and design communities both in academic and industry sectors. This paper sets out to articulate the gaps in design training and begin to identify possible solutions.

Discussion

Design practice has evolved from the craft-based model of the pre-industrial age to the professionalised disciplines of the 20th century. Alexander (1964) argues that the change from the unself-conscious pre-industrial approach to the self-conscious professionalisation of design is an inevitable response to a society that is subjected to a sudden and rapid change that is culturally irreversible.

Lawson (1980) suggests that the changes in materials and technologies during Britain's Industrial Revolution between 1760 and 1840 became too rapid for the craftsman's evolutionary process to cope and that this gave rise to design practice as we know it today.

As Designers and agents of change entering a post-digital, new materials age we need to question our current practice as the rapid rate of change

driven by advances from within the STEM communities challenge our understanding and knowledge of the artificial or man-made world.

Designers in the UK have strong creative skills, but are often ill equipped to engage with the technical challenges and opportunities presented by general advances in material science. As such, this risks positioning the designer more as a passive user of new materials and technologies rather than an active influencer. The vast majority of artefacts unveiled annually at both interim and final degree shows at leading design graduate and post-graduate institutions, in the UK, reveal creative, yet relatively unexplored articulations of the potential of new materials that are limited to provocation or points of discussion and fall short of exploring potential for product innovation. This is evident in but not limited to the areas of textiles and fashion.

Textiles and textile-type materials make up a huge portion of our man-made environments, from aeroplanes to implants; textile technology is omnipresent in our current world and, inevitably, our future environment.

The significant STEM advances in soft materials coupled with the pervasive nature of textiles could be a reason why this knowledge and skills gap is so evident within the discipline as the rapid rate of change in STEM is not reflected within the discipline's design practice. Textiles, as a discipline, still has craft-based knowledge at its heart. In order to maintain its currency in the 21st century this must be balanced and supported with knowledge of advanced materials and fabrication methods. However, in the UK there has been a gradual (last fifteen years) decline in the technical training at undergraduate and postgraduate level that echoes the demise of the UK's textile industry. A key factor is the high cost to the institution of running and retaining practical workshops populated with skilled technicians and availability of raw materials to experiment with coupled with inadequate public funding. This inevitably has had an impact on the knowledge and skill-set of young professional designers concerned with design and materials innovations. The desire and ambition of new designers to operate as fluently with these new classes of stimuli responsive materials as they have demonstrated with more traditional and familiar materials is evident in exhibitions of work, as is their ability to conceptually frame emerging technologies and create scenarios that examine the societal and cultural implications of these advances. However, we suggest that we need to shift from the externalised and potentially isolated position of responding to advances in STEM disciplines to one of active influence and effect from within this arena enabled by a more robust knowledge and experience of

the characteristics and affordances of new classes of stimuli responsive materials.

Art, Design and STEM collaboration

There is no doubt regarding the adjacency, relevancy and interdependency of design and technology with regard to innovation. Bringing design and technology together is not a new idea. Buechley et al. (2007) propose the introduction of E-Textiles (electronic/ conductive textiles) into the American school curriculum at k-12 stage to widen participation in learning electronics and programming, and promote innovation. The UK's Technology Strategy Board's 'Investing in innovation in the creative industries' programme (TSB, 2012) and the Materials Knowledge Transfer Network's Materials and Design Exchange, 'MaDE', initiative (recently closed) (KTN, 2012) are two of many recent examples that strengthen the interconnections between these domains.

There have also been many examples of Science / Art initiatives involving collaborations and the creation of work that responds and comments on our emerging world. The 1951 exhibition inspired many creative responses and influenced design aesthetic for some years. More recently is Rhode Island School of Design's 'STEM to STEAM' initiative that places Art within the STEM communities (Robelen, 2011).

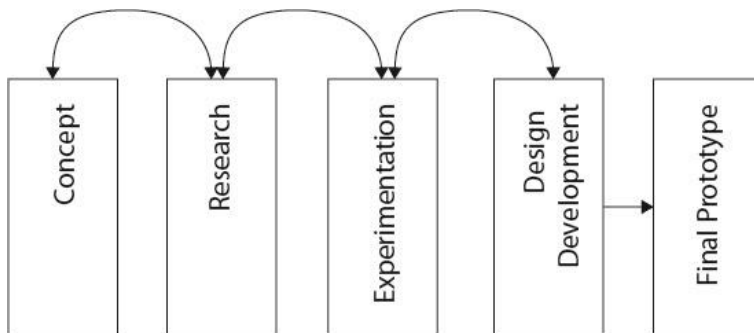


Figure 1 Image of general creative design and development process in fashion and textiles as taught at higher education institutions, the image represents an indicative system and is by no means exhaustive (source V. Kapsali).

Many 'ideas' and scenarios of how our future lives will be affected by socio-economic changes and advances in science and technology have been explored in a conceptual way. These examples are powerful 'Agent Provocateurs' and stimulate debate, inspire and offer the opportunity to

explore emerging science and technology advances in a theoretical and conceptual way. However, they stop with the idea, the intangible and the conceptual. There is an emerging space filled, primarily, with designers who are hungry to deal with the evolution of these design fictions into design facts.

In an attempt to bridge this gap, independent groups of design-tech hybrids have begun to populate the space between design and STEM. Fuelled by the recent explosion of Open Source, these individuals have adopted an alchemic, almost 'guerrilla' approach to relatively exclusive types of technology such as synthetic biology, computing hard and software and advanced materials. Today, numerous 'hacking' communities around the globe inhabited by designer-scientists-engineers, experiment with anything from DNA to programming to create artefacts such as bioluminescent plants or grown garments. The emergence of these communities is testimony that curiosity is a driver common across the art/design and STEM communities but some examples and demonstrators lack the rigor and discipline of an academic framework and can limit occupancy of this emerging space to creative hobbyists.

D-STEM, an acronym for Design-Science, Technology, Engineering, Maths, is the nomenclature we have given to our holistic, interdisciplinary approach to addressing 21st century needs through materials interrogation. We see this as different to commenting on the advances in STEM and goes beyond the knowledge transfer of Design and STEM interdisciplinary collaboration. This is an adaptation of the conventional design process and aims to merge the creative, opportunity seeking aspects of design with the systematic, experimental, knowledge seeking aspects of STEM areas. A D-STEM designer can understand enough STEM to not only exploit a novel or emerging material but is also able to absorb it into their toolbox and has the agility to manage and contextualise innovation emerging from STEM communities and vice versa.



Figure 2 Examples of garment (left) with printed detail and jacket with structural details made exclusively from cellulose material produced by bacteria in the Biocouture studio (Source S. Lee).

D-STEM is not to be confused with what Cross (1975) refers to as a desire to ‘scientise’ design, nor is it about the science of design. It is closest to what Cross calls scientific design, and refers to modern, industrialised design – as distinct from pre-industrial, craft-orientated design, and is based on scientific knowledge but utilising a mix of both intuitive and non-intuitive design methods. He suggests that this is merely a reflection of the reality of modern design practice. It is perhaps too early to decide if D-STEM is a new design paradigm or merely a shift in response to the advancement towards intelligent material systems.

D- STEM: a new approach to postgraduate design education

If we are going to realise this D-STEM vision, it is critical that we have a design community who can navigate these emerging spaces of material technology and direct the developments that will enable a product landscape with genuine impact in the quality of peoples’ lives. Given the speed of material innovation, we believe that designers of the future need to be Design- STEM hybrids, capable of understanding, exploiting and, most importantly, influencing STEM developments. We propose that a shift in design education is needed to develop designers that can address the challenges of 21st century society through material based investigation and practice.



Figure 3 ‘Loom to hanger’ project developed by V.Kapsali and J. Stephenson at Middlesex University in 2008. The shrinking effects of wool in hot water were studied in combination with effects of weave and yarn structure. A 2D layered textile was engineered (left) that when exposed to hot water, transformed into a fully fashioned vest with design details without the need for further processing i.e. cutting and sewing (source V.Kapsali).

Figure 1 illustrates the conventional design development process specific to fashion and textile design. This process is presented as linear for purposes of simplicity and is indicative and by no means exhaustive of creative stages as taught at higher education institutions in the UK, it does not include industry cycles such as buying and manufacture nor is it exhaustive of the complexities of the creative process. Designers, during their training, develop their own styles and patterns of work.

Designers are trained to develop a conceptual framework to underpin a design project usually influenced by trends, art and/or abstract notions. Design students are trained in creating a narrative to describe their concepts and fuel the design process. This stage involves research into the topics relevant to the concept, it could be historical, observational etc. The work at this stage is usually visual and includes images/ references to colour, mood and texture. Students carry out work in sketchbooks that document this part of the process and create mood-boards that convey the concept visually.

During the research stage, design students also begin to gather information on materials and techniques relevant to their concept. Activities will involve sourcing specific materials, components that will be used during the practical work and/or techniques that will inform the practice.

The experimentation stage involves initial practical activity that seeks to test out the combination of materials and methods the designer has selected. This comprises a trial and error period during which the individual will acquire knowledge and hone skills specific to the handling of the chosen materials in the context of the creative concept, in other words towards the development of a 'toolbox'. Materials and techniques are often discarded and new must be sought out; research activity is key to the support of this stage in the process.

The design development stage is the most creative practice based activity in the process and is inextricably linked to experimentation. The knowledge and skills developed through the previous stage forming the 'toolbox' are applied to articulate the concept as textile or garment manifestations. Many ideas are explored and the outcomes of the experimental stages are examined through 'filters' such as scale and proportion. Once complete, design students are trained to evaluate the outcomes of this stage and plan the final prototypes. Once these decisions have been made, students proceed to the production of a final collection of artefacts.

Generally speaking, the design student and/or practitioner's materials knowledge bank is limited to what they already know, have experienced or

ANNE TOOMEY, VERONIKA KAPSALI

have access to. The same applies to fabrication methods. If these aspects are limited in terms of raw materials, characterisation and fabrication methods the designer is disadvantaged when faced with the challenges of 21st century materials advancements, and society is disadvantaged as it cannot benefit fully from Design's potential contribution.

D-STEM Principles

D-STEM uses existing craft and design practice as a point of departure to articulate the merger of established design principles with recent STEM innovations in areas such as biotechnology, electronics, material science and engineering. Initial observations suggest that as an approach it has, at its core, one or more of the following:

- Design using advanced fabrication
- Designing advanced material systems
- Designing with advanced materials
- Designing products with advanced functionalities

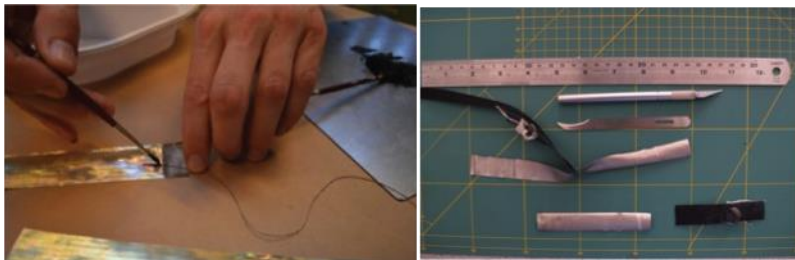


Figure 4 Dielectric electroactive polymer (DEAP) thoracic sensors project developed by A.Toomey, N.O'Connor and P. Stevenson-Keating in 2012. The industry standard sensors were taken apart and fabricated in-house to enable bespoke specification and integration into the sensing vest.

Design with advanced Fabrication

Pioneers of this approach are practitioners such as Suzanne Lee, director of BioCouture; a consultancy that explores the application of grown materials in the fashion industry. Lee, originally trained as a fashion designer, wanted to explore ways of growing materials for garments as an alternative, more sustainable approach to the conventional materials and processes. Lee sought to address global challenge regarding waste materials during the manufacture specific to the apparel industry through pushing the boundaries of the territories conventionally occupied by this area of practice by combining creative thinking with the fabrication concepts from

biotechnology. Lee achieved this by introducing specific knowledge and skills from biology into the concept and research stages of the design processes. In doing so she broke out of the conventional research topics in fashion design and began to investigate ancient methods used to produce kombucha and collaborated with a biologist in order to get a deeper understanding of the processes involved and produce her own material. Following an intense experimental stage, Lee developed a unique fabrication 'tool box' that enabled her to produce grown cellulose and through further design led experimentation developed the ability to manipulate to enable the creation of experimental garments (figure 2) comprised of distinct design features.



Figure 5 Dielectric electroactive polymer (DEAP) thoracic sensors project developed by A.Toomey, N.O'Connor and P. Stevenson-Keating in 2012. The thoracic muscles and anchor points were mapped onto the vest toile and used as the blueprint for the integration of the bespoke sensors.

Design advanced material systems

Advanced knit technology has enabled viable 3D knitted, seamless garments, however this had not been achieved using woven systems. Kapsali (2013) wanted to explore the possibility of a deeper understanding of the material properties and performance of merino wool gained by adopting the analytical processes from material science to create an advanced material system that truncated the traditional manufacturing processes and techniques in order to move towards notions of self assembly.

The factors effecting structural changes caused by exposure to hot water of the textile were studied during the research and experimental stages of the design process; these were fibre, yarn and weave type. Knowledge and

ANNE TOOMEY, VERONIKA KAPSALI

skills emerging from this process informed the design of a textile that when cut off the loom resembled a 2D flat, rectangular piece of cloth, yet when exposed to hot water, the material was transformed into a fully fashioned vest with design details without the need for further processing i.e. cutting and sewing. This simple project we call 'Loom to Hanger' demonstrates that a shift in thinking about materials can deliver structures with that self assemble when exposed to certain conditions shifting from 2D design to 4D spatial and temporal engineered structures (Kapsali et al., 2013).

Designing with advanced materials

Toomey initiated a design-led study exploring the potential use of dielectric electroactive polymer (DEAP) sensors for human centred applications in interactive products and assistive healthcare. Inspired by the similarities of both the sensor and human skin and muscle, Toomey applied concept, research and experimental design methodologies to identify applications for the DEAP sensor, the concept of a-real time breathing, monitoring vest was selected for development.

During experimentation, Toomey concluded that in its current format, the DEAP sensor presented limitations for this specific application, in house modification of the sensor was required. This involved the combination of principles from stretchable electronics with design making methodologies to handcraft bespoke sensors that map critically relevant areas of the thorax. Initial findings suggest that DEAP sensors are a promising technology for direct body mapping and that it is possible to identify different activities based on the patterns of data created, i.e. laughing, eating, breathing.

Designing products with advanced functionalities

Fashion textile designer, Kapsali embarked on a doctoral project in Biomimetic Engineering at Bath University's Mechanical Engineering department in 2005. The purpose of the work was to engineer a textile system that applies the mechanical principles responsible for the moisture induced opening and closing of pinecones and other hygroscopic seed dispersal mechanisms, that would demonstrate counterintuitive behaviour in the presence of moisture in that it would become more permeable in damp conditions and less in dry. Conventional hygroscopic materials such as cotton, wool and rayon behave in the opposite way and are linked to physiological discomfort caused by build-up of moisture in the microclimate.

Kapsali's concept involved researching the hierarchical principles of hygroscopic shape change in wood type fibres and combined this knowledge to her experience in textiles to develop a 'toolbox' of new fibre and yarn

technologies that when introduced into a textile context generated counterintuitive properties that enable the management of airflow through the textile system. This work was consequently patented, absorbed by the private sector and branded INOTEK TM. INOTEK TM is the first biomimetic shape change technology to reach pre-commercial stage.

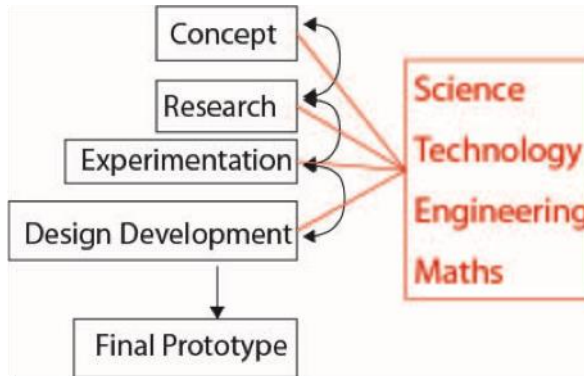


Figure 6 D:STEM approach, the image suggests how and when STEM and Design methodologies merge, based on examples of existing design practice, to create the D:STEM process (Source Kapsali and Toomey).

Conclusions

All four examples of D-STEM innovation, mentioned previously, challenge the existing hierarchy where the designer is introduced at the end of the innovation chain, once the technology is cemented. Figure 6 suggests a framework for D-STEM that shows how STEM and Design can merge however the realisation of this approach requires a significant shift in current practise as demonstrated in the examples discussed previously. Interestingly it is in the early stages of the design process where there is most impact, this suggest that when Design is placed as a core stakeholder from the inception of an idea, there is a significant shift in the resulting innovation.

Conventional design inhabits studio spaces and largely draws upon conventional design knowledge and skill. The D-STEM approach requires a new hybrid environment, a studio-lab that integrates design, science and technology from the outset with both the Design and the STEM domains working in unison on interrogating human centred needs, such as assistive

healthcare, energized architecture and performance products, to design and develop products and services for Future Ways of Living.

The D-STEM approach also requires new knowledge and skills from practitioners, this brings into question the equipment, tools and training currently available and largely based on the typical 20th century studio, with perhaps, the exception of 3D printers. We suggest that more advanced fabrication tools and methods alongside adequate characterisation equipment are necessary for the D-STEM studio-lab of the 21st century.

In addition to this the design and material science communities need to build on models designed to strengthen connections between the two communities such as the UK's Technology Strategy Board's 'Investing in innovation in the creative industries' programme and the Materials KTN's MaDE, to create advance platforms for meaningful connections. Knowledge transfer between communities is necessary at early stage of material science innovations rather at pre-commercial stages, which is current practice.

There are many examples of successful interdisciplinary ventures where these challenges have been overcome but they are predominately contained within specific interdisciplinary partnerships and groups who, having once overcome the challenge of shared communications, continue working within those architectures of expertise. In order to grow and develop the essential trans-disciplinary approaches of the twenty-first-century it follows that trans-disciplinary communication must be more fluid.

With the examples that we have started, including grown materials, wearable DEAPs and biomimetic textiles, it is beginning to emerge that this holistic approach makes sense and has potential to go beyond established technology transfer, share and exchange initiatives as a route for innovation.

We propose that elements of this approach, if examined and challenged thoroughly, could potentially be of use to others as a methodology for integrating Design and Technology for innovation. We believe a D-STEM approach would fill the current gap between the rapid STEM developments and the slower design advances evident today. We also need to identify from industry what qualities, knowledge and skills they need from graduate designers to establish how they can contribute more holistically within the innovation ecosystem by bridging the gap between design and technology in a more authoritative manner, to show strategic leadership and direction with an ability to cross discipline cultures.

References

- Alexander, C. (1964) *Notes on the synthesis of form*. New York: McGraw Hill.
- Buechley, L. Eisenberg, M. and Elumeze, N. (2007) Towards a curriculum for electronic textiles in the high school classroom. *SIGCSE Bull*, 39 (3), 28-32
- Chamorro-Koc, M., Adkins, B.A. and Bucolo, S. (2012) Using scenarios to explore the social aspects of design led innovations. *Projecting Design 2012: Global Design Bridge 1* (1), 186-191.
- Cross, N. (1975) *Design and Technology*. Milton Keynes: Open University Press.
- Dunne, A. and Raby, F. (2013) *Speculative Everything: Design, Fiction, and Social Dreaming*. Cambridge: MIT Press.
- Hu, J., Funk, M., Zhang, Y. and Wang, F. (2014) *Designing Interactive Public Art Installations: New Material Therefore New Challenges*. In Pisan, Y., Sgouros, N.M. and Marsh, T. (eds.), *Entertainment Computing–ICEC 2014. Lecture Notes in Computer Science*. New York: Springer.
- Kapsali, V., Toomey, O.R. and Tandler, L. (2013) *Biomimetic Spatial and Temporal (4D) Design and Fabrication*. Paper Presented at the Proceedings of the Second international conference on Biomimetic and Biohybrid Systems.
- Lawson, B. (1980) *How Designers Think*. London: Architectural Press.
- Robelen, E.W. (2011) STEAM: Experts make case for adding arts to STEM. *Education week*, 31 (13), 8.



The ‘Makers contradiction’. The shift from a counterculture-driven DIY production to a new form of DIY consumption

Alessandro CARELLI*, Massimo BIANCHINI and Venanzio ARQUILLA
Politecnico di Milano

The Makers, born in 2005 with the founding of the MAKE magazine, are recognised as the pioneers of the so-called ‘Third Industrial Revolution’ (Anderson, 2012, 2012; Rifkin, 2012; Marsh, 2013; Lipson, Kurman, 2013) as well as the proponents of a ‘Movement’ stemming from Do-It-Yourself (DIY) practices. Such a movement, whilst proposing a socio-technical revolution based on personal use of production technologies, tends to be taking a non-conflictual position towards those global economic players against whom it claims to offer an alternative model. This tendency, observed among some Makers communities, contributed to the shifting of DIY practices from production to consumption activities. In order to highlight this phenomenon, we devised three stages of analysis: i) The understanding of the Makers phenomenon within a social sciences theoretical view, to frame the emergence of Makers as consumer figures; ii) investigation of the role played by Maker Media in disseminating the concept of Makers and influencing the Maker Movement; iii) the analysis of the Makers’ activities within the Makerbot-Thingiverse communities, undertaken with theoretical and conceptual tools derived from ‘Practice Theory’.

Keywords: Makers ecosystem; practice theory; DIY; digital platforms; maker movement

1. A short premise on the Makers phenomenon

Several studies, especially those from a social sciences perspective, have focussed on the relationship between ‘production and consumption activities within the dynamics of web collaboration’.

Phenomena such as: i) the personalization of commodities in more ‘humanized’ products by users (Campbell, 2005); ii) the growing diffusion of

* Corresponding author: **Alessandro Carelli** | e-mail: alessandro.carelli@polimi.it

web customization tools and file sharing platforms; iii) the process of ‘consumerisation’ of hacking practices (Magaudda, 2012) have highlighted a connection among production and consumption practices as pointed out in the concept of *prosumption* (Ritzer and Jurgenson, 2010). Such studies, whilst referring to the phenomena lately appearing on the web, do not take into account the Makers as a global community dedicated to the practices of Do-it-Yourselfe (DIY), due to the publishing activities of the Make Magazine founded in 2005. Often described as the anticipators of the so called ‘Third Industrial Revolution’ (Rifkin, 2012; Marsh, 2012), Makers are generally associated with the concept of *personal fabrication*, the spreading of communities related to open hardware and open source physical computing systems.

Makers, thanks to their relationship with technology, have been described in a variety of ways, with technology evangelists and ‘startupper’ being the most prominent titles.

From a scientific point of view, in recent years there has been increased literature on the theme of Makers from a phenomenological point of view, extending but not limiting the area of interest to the design field.

Despite the fact that these studies focus mainly on ‘makers as producers’, various signals, including the involvement of large international groups¹, suggest that the dynamics of production-consumption addressed in social sciences can provide an alternative point of view on the Makers phenomenon.

The hypothesis that some of the Makers are shifting from being producers to being consumers² thanks to the same economic actors that contributed to the emergence of the ‘Makers culture’, is at the basis of what we addressed as the ‘maker contradiction’. In order to verify the truth of the above statement, the first part of the present paper will focus on the relationship between the community of makers, the role played by Maker Media as the leader of the maker movement, and the ‘market of making’ in which these economic actors operate. In the second part, will be analyzed the evolution of tools employed by the MakerBot-Thingiverse platform, the best-known online community for sharing 3D files that over the years has become the core of the business strategy of the start-up that founded it.

1 For instance in the sector of CAD software and additive manufacturing such as Autodesk e Stratasys.

2 Makers could also be seen as also *prosumers* as pointed out by Ritzer in several articles on his blog available at <http://georgeritzer.com/>.

2. The Makers Ecosystem: community, market and movement

The data on the growth of the Makers phenomenon reconstructed through a *desk analysis* performed on multiple sources – official reports published by the subjects investigated, articles on scientific journals, online newspapers, specialised magazines and blogs – support the existence of a socioeconomic system of *making* (table 1) or of a Maker Ecosystem (a term coined by Maker Media). The numbers and the presence of a high level of interactions between many economic actors active in this field support this hypothesis³.

Table 1 Analysis of the growth of the Makers phenomenon.

Subject	Launch	Status 2012-2014	Notes
FabLab	2003	294 Fab Lab available	Neil Gershenfeld states that the number of Fab Labs doubles every 18 months
Make Magazine	2005	300.000 readers	
Arduino	2005	About 5.000 Arduino units manufactured every day	
Fab@Home	2005	The 3D printers Fab@Home have been built in 43 Fab@home labs in the world	IThe project was concluded in 2012 as it reached its goal: The number of domestic 3D printers has outnumbered industrial 3D printers
Etsy	2005	500 employees and 30 million buyers and sellers	Profits for 2011: \$500 million Profits for 2010: \$314 million Profits for 2009: \$180 million
Raspberry Pi	2006	2,5 million units sold in 2012	(400.000 of which are presumably used by children)
Maker Faire	2006	100 Faires in 2013 with 530.000 visitors	61 Faires in 2012 (+64%) 24 Faires in 2011 (+335%)
TechShop	2006	7 TechShops open and 11 more scheduled to open in the US	
Ponoko	2007	15 making hubs in the world and	

³ There are several cases of collaboration in order to organise events, to open promotional and commercial channels, and to sustain activities of various nature.

		200.000 products created	
Rep@Rap	2008	Around 200 models created in 2012	The <i>Family tree</i> RepRap published on Wikipedia goes up to 2012
MakerBot	2009	More than 35.000 printers sold. Between 35.000 to 100.000 objects uploaded on Thingiverse in 2013, 21.1 millions downloads	Bought by Stratasy in 2013 for \$400 million

Within this system it is possible to distinguish two groups of subjects presenting different kind of relationships with the Makers and the ‘market of making’, and a divergent approach in the design and development of technologies and design:

1. Subjects seeing Makers as a community (of practice).

These are mainly not for profit entities operating to promote the (culture of the) democratization of production through the open source philosophy.

Subjects such as the Fab Labs⁴ or experiences such as RepRap⁵ do not consider makers as a movement but as members of a wider community of practice to work with in a symbiotic and mutual way⁶.

In order for this relationship to be sustained it requires a mix of alternative mechanisms that rely mainly on volunteering, collaborative consumption, on donations and crowd funding even if there is no resistance to the market logics.

In particular, the network of Fab Labs, which has grown rapidly whilst maintaining its original model,⁷ is today undergoing a phase of institutionalisation (FabFoundation), which aims to harmonise the development of FabLabs. These spaces are now looking for formulas that could balance economic sustainability with the coexistence of free and paid

4 The Fab Labs are a global network of manufacturing laboratories born as a result of the researches of the Centre for Bits and Atoms about the self-reproducibility of digital fabrication technologies.

5 Rep Rap is the name of the community that created that first open source 3D printer project to which we owe the widespread development of low-cost printer models.

6 In many Fab Labs the equipment is free to use, one need to pay only far the raw materials.

7 Up to April 2014 there are officially 294 laboratories globally (source: FabFoundation, www.fabfoundation.org/).

services⁸ and push to increase both their autonomy in the development of manufacturing technologies (by saving on the purchase and maintenance of equipment)⁹ and their ability to generate projects, innovation and entrepreneurship.

2. Subjects seeing Makers as a market-community.

In this category we can distinguish two types of enterprises:

- To the first type belong companies such as *Arduino*, *RaspberryPi*, *Ultimaker* e *MakerBot*, defined by the development of *open source* projects-products, around which grow a large community that becomes also the companies' main market. The concept of 'market-community' (Bianchini and Maffei, 2012) derives from the overlapping between the production and consumption communities. These companies are, on one hand, increasing their market share by successfully using the strategic levers of globalisation and, on the other hand, developing a structured relationship with the hardware and software industrial system¹⁰. These subjects, in relation to the market, are also working to spread the philosophy of making by selling 'starter kits' and investing in educational projects such as *MakerBot Academy*¹¹.
- To the second type belong companies such as *Maker Media*, *TechShop* and *Etsy*, focussed mainly on building communication, promotion and commercial platforms that enable Makers to learn, share and promote projects and purchase technologies and products. These companies do not embrace the philosophy of the *open source* but are based on the principle of *open access* in order to expand the

8 The majority of Fab Labs have been created thanks to the support of public organisations and institutions. Many of these, out of financial support, now are going through a stage where they need to ensure their economic sustainability.

9 The self-construction is one of the development points of Fab Labs.

10 In a few years *Arduino* evolved from an open source project unknown outside of specific areas of use to a global open hardware company. *MakerBot*, a start-up operating in the consumer sector of 3D printers and recently acquired by *Stratasys*, industry giant, has focussed its strategy in the consolidation and expansion of its market-community through the *Thingiverse* platform.

11 Further information on the *MakerBot Academy* project is available on this address: <https://makerbot.com/academy/>. The official website of the *Makerspace* project and the repository of the affiliate laboratory is available through this link: <http://space.com/>

community of Makers as much as possible, offering several services at affordable costs¹², many of which follow the logic of *freemium*. Enterprises such as Maker Media and TechShop have significantly contributed to the birth and growth of the Maker Movement also thanks to the political support of the U.S, which is developing a set of actions for the regeneration of the new manufacturing culture in their country.

The data on the rapidly growing market of goods and services for making within a short amount of time provides food for thought about the evolution of the Maker figure.

It in fact needs to be clarified whether the Maker Ecosystem is proportionally abilitating the growth of a community of Makers entrepreneur and innovators (MakerMedia defines them as *Leading Edge Makers*¹³) or it instead favours the growth of Makers more interested in replication or personalisation of existing projects.

3. ‘Making Makers’: the triple role of Maker Media in the Maker ecosystem

There is no doubt that the worldwide spreading of the concept of ‘makers’ among others, such as crafters or hackers, resides principally in the successful Maker Media’s communication strategy based upon the rising awareness campaign about the Makers culture.

Maker Media has spin out from O’Reilly Media as a separate Company on January 2014, following the “[...] opportunity to extend and expand our popular brands beyond our current, engaged and devoted community”¹⁴. Maker Media is also the publisher of Make Magazine, “[...] the first magazine and media brand devoted entirely to the maker movement and the powerful combination of open source hardware + personal fabrication

12 The entrance ticket for MakerFaire costs between 10-35\$, one year membership to Make costs \$19.90.

13 The report on Maker Market underlines a data about ‘Leading Edge Makers’: 17% of the interviewed people identifying themselves as ‘Leading Edge’ makers, defined for the survey as makers who describe themselves as an entrepreneur, innovator, or influencer.

14 ‘MAKE Division Spins Out From O’Reilly Media as Separate Company.’ *Marketwire*. Accessed April 14, 2014. <http://www.marketwired.com/press-release/make-division-spins-out-from-oreilly-media-as-separate-company-1749632.htm>.

*tools + connected makers, to generate sweeping changes from the classroom to the boardroom.*¹⁵

There is a plurality of opinions related to the maker community and the public figure of Makers. According to Dale Dougherty, the founder and CEO of Maker Media, Inc. '... Makers are enthusiasts; they're amateurs; they're people who love doing what they do. They don't always even know why they're doing it. [...] They want to figure out how things work; they want to get access to it; and they want to control it. They want to use it to their own purpose...'¹⁶. For Chris Anderson '... basically, the Maker movement is what happens when the Web meets the real world...'¹⁷. Maker Media's vision is shared also by scholars such as Hod Lipson, who tends to see a cultural movement behind Makers (Lipson, 2012).

Since the key role played by Maker Media to shape the meaning and the favourable cultural environment for the quickly world-spreading of Makers seems to remain crucial and undisputed, the present paper recognises at least three roles played by Maker Media in order to spread the maker culture.

First role: Cultural intermediary and gatekeeper of the 'official' Maker culture.

As Maker Media is a for-profit organization aimed to take 'DIY geek culture mainstream'¹⁸ such communication activities also represent its core business. The role of Maker Media could be analyzed within the framework of the critical cultural studies of marketing¹⁹, taking into account both brand management and meme engineering, as it has been outlined by scholars and critics such as Arvidsson and Morozov.

15 'MAKE Kicks Off 'A Summer of Making' With Its 3D 'School's Out!' Special Issue.' *Marketwire*. Accessed April 17, 2014. <http://www.marketwired.com/press-release/make-kicks-off-a-summer-of-making-with-its-3d-schools-out-special-issue-1666841.htm>.

16 Dougherty, D. *We Are Makers*. Accessed April 3, 2014. http://www.ted.com/talks/dale_dougherty_we_are_makers.

17 Anderson, Chris. 'The Long View | Chris Anderson Says the 'Maker' Movement Is the Next Industrial Revolution.' *BoF - The Business of Fashion*. Accessed April 8, 2014. <http://www.businessoffashion.com/2012/11/the-long-view-chris-anderson-says-the-maker-movement-is-the-next-industrial-revolution.html>.

18 'Former Pixar, Disney Technology & Operations Head, Greg Brandeau, Joins Maker Media as President and COO.' *Marketwire*. Accessed April 14, 2014. <http://www.marketwired.com/press-release/Former-Pixar-Disney-Technology-Operations-Head-Greg-Brandeau-Joins-Maker-Media-as-1830327.htm>.

19 The definition of 'critical cultural studies of marketing' used here refers to Zwick's definition in 'Utopias of Ethical Economy: A Response to Adam Arvidsson' (2013).

In his essay about the influence of Silicon Valley's technocratic thinking, Morozov pointed out how the Tim O'Really' *meme engineering*²⁰, a particular process that enables the organization and shaping of ideas in order to be transmitted more effectively, and have the desired effect to reframe the mining of a particular concept once it has been transmitted (Morozov, 2013). As argued by Morozov, meme engineering allows connections among social, technological and economical topics, even if they seem apparently distant from each other²¹.

Such mechanism is also recognizable in the spreading of Makers culture. It has worked discursively to build an inclusive environment to connect together different visions: the one in which people enjoy making things for pleasure, with a more ideological one where by embracing open hardware technologies, they aimed to spread the open culture to the physical world.

As a result, those different positions have become blurred within the Maker Media rhetoric. Once both countercultural and commercial meanings have been melted together, the result is similarly to what Arvidsson, in his critical perspective of brand management, refers to as 'the context of consumption'. From this stand point, the role of Maker Media consists in the construction of a common ground of shared meanings, allowing different actors to interact with each other: makers by providing the contest for building social relations on one hand; sponsors and investors interested in capitalizing such a rich meaningful environment on the other hand. As Arvidsson argued, some of the products of the brand management in the contemporary cognitive capitalism are branded communities to encourage the production of ethical surplus, the combination of social relation, shared meaning, emotional involvement and sense of belonging (Arvidsson, 2005), which result in a kind of natural resource for brand managers. Similarly, the maker meme has oriented a worldwide audience, formed by hobbyists and professionals towards shared values, by convincing them that they are

20 According to Morozov, an example of the function of *meme engineering* is the role played by O'Really Media in turning the mining of *free software* in open source, reframing such concept from the social perspective of the individual freedom as it was originally thought within the free software movement, to one related to the ambiguity of the terms 'openness' and 'open access' as 'internet-enabled collaboration' and a tool to lower the barriers to entry into market (Morozov, 2013).

21 As argued by Morozov '... The exact nature of these connections is rarely explained in full, but this is all for the better, as the reader might eventually interpret connections with their own agendas in mind. This is why the name of the meme must be as inclusive as possible: you never know who your eventual allies might be...' (Morozov, 2013).

makers. The construction of the social identity works into the life-world in order to drive makers to build social relations and ethical surplus. Makers communities also look like a particular form of branded community that could support and create values for a bunch of selected brands, rather than a single one. By doing so, Maker Media could affirm its role as cultural intermediary within the maker community, conditioning the direction for the production of ethical surplus in order to value sponsors and selected brands by unfolding them to the 'official' Makers culture.

Second role: Global platform for Makers

The intent of Maker Media to be the intermediary among different actors, and their related interests, is even clearer when it describes itself in terms of a 'Global platform for connecting makers with each other, with products and services, and with our partners'²². As argued by Gillespie, the meaning of 'platform' within the information society's public discourse has shifted from 'technical', rooted into computational dictionary to 'cultural', obtaining the more figurative meaning 'platforms of opportunity'. Such a shift in meaning has been drawn by stakeholders working both politically and discursively to elide the tensions inherent in their service: 'between user-generated and commercially produced content, between cultivating community and serving up advertising, between intervening in the delivery of content and remaining neutral'²³ (Gillespie, 2008). The role covered by Maker Media as global platform and cultural intermediary, seems to assume a more crucial role once Makers have acquired public relevance by being recognized as a movement 'which is transforming innovation, culture and education'²⁴.

Third role: Leaders of the Maker Movement

The idea that Makers are not only a growing heterogeneous global community of people involved in doing things, but a movement, as Maker

22 'Maker Movement.' *Maker Faire*. Accessed April 8, 2014. <http://makerfaire.com/maker-movement/>.

23 Framing his observation to service providers such as YouTube, Gillespie argue that the role of such platforms are increasingly becoming prominent in the distribution of information online and for the whole movement of digital culture. Once they became the keepers of the cultural discussion on the Internet, a clarification about their public role and responsibility related 'to their users, to key constituencies who depend on the public discourse they host, and to broader notions of the public interest' is needed (Gillespie, 2008).

24 'Maker Media | Leading the Maker Movement.' Accessed May 11, 2014. <http://makermedia.com/>.

ALESSANDRO CARELLI, MASSIMO BIANCHINI, VENANZIO ARQUILLA

Media declares, comes with no surprise since Makers are universally involved in 'bringing a DIY mindset to technology'²⁵.

The 'DIY movement can be characterized by a rejection of the consumption of objects produced by dominant culture in favor of creating the items one needs and desires on one's own' (Abrahams, 2008), it means that such a political vision is rooted into an anti-consumerism, anti-capitalistic and anti-establishment mindset²⁶. Based on this view Makers have developed their own Bill of Rights: a manifesto that recommends the use of accessible, extensible, and repairable hardware - 'If you can't open it, you don't own it'²⁷, as well as to push Makers to embrace and share hardware open source. But, differently from the hacker communities²⁸, in which 'there is a dialectical relationship between particular technocultural forms and more general cultural structures, which leads hackers to variably implement, reformulate and critique liberal social institutions, legal formulations and ethical precepts even as hacker practice' (Coleman and Golub, 2008), Makers 'are not necessarily troublemakers' (Morozov, 2014).

They come from a cultural system related to information technologies that is not struggling against the 'system'. The Maker movement is sponsored by global corporations as well as publicly supported by governments for its economical and educational potential²⁹. This phenomenon raises questions about the freedom of speech of the movement within profit-seeking entities such as file sharing platforms when they also play the role of culture providers (Gillespie, 2008). As Tim O'Reilly spoke about Maker Movement as '*a movement that began with enthusiasts*

26 Both DIY approach and Punk Culture have also been the inspiration for others related underground socio-cultural movements, such as the indie crafters and Riot Grrrl who are seeking 'to empower individuals (predominantly women) through the creative act' (Abrahams, 2008). There are other movements related to the Makers, such as *craftivism*, people that decide to abandon their profession to dedicate their time to craft work (Crawford, 2011).

27 Jalopy, Mister. 'A Maker's Bill of Rights to Accessible, Extensible, and Repairable Hardware.' *Make Magazine*, n.d.

28 A first proof of the difference between maker and hacker communities is rooted into the conflict within maker movement's declaration of intents, in which the defense of free access to knowledge rights within the Maker Movement is far to seem a priority when even the Maker Media official store sells some selected closed-source hardware products as well. A second conflict coming from the growing numbers of closed-source platforms involving makers in order to engage each others and sharing projects within sponsored environment.

29 Consider, for example, the growing interest in the Makers community by DARPA and the Chinese Government.

has turned into an entrepreneurial revolution'³⁰, such an entrepreneurial predisposition is drastically emphasized within the movement. In such a scenario that mixes together entrepreneurship and social movement, the role that Maker Media created for itself in terms of 'synonymous with the Maker movement' and 'the recognized leader of this growing community of makers'³¹, is far to be marginal.

Finally, the three roles played by Maker Media as *cultural intermediary* and *gatekeeper* of the 'official' maker culture, *global platform* for makers as well as *leader* of the maker movement, looks to be highly complementary. By covering such a triple role, Maker Media has the power to stretch the boundaries of the 'official' maker culture in order to strengthen the brand value of selected sponsors to elide the tensions inherent in the community between sponsors and investors.

By doing so, in the construction of the concept of maker, even maintaining the focus on sharing knowledge and collaborative process within the community, Maker Media has also lowered the importance of topics such as the defense of privacy rights and free access to knowledge (as intended from the open source communities point of view) putting a radical entrepreneurial vision into place.

Such a mechanism seems to suggest that there is an ongoing shift in the real role of makers from producers, as it has been artificially built and publicly communicated to a consumer. In order to provide supporting evidence for this intuition, the next chapter will focus on the relationship between makers and the Makerbot-Thingiverse platform.

4. DIY Consumption: the case of Thingiverse

MakerBot is one of the most well known producers of 3D printers and, according to *Maker Media*, one of the most representative case of the Maker Ecosystem. Founded in 2008, at a time when Makers were still a marginal phenomenon, *MakerBot* operates in the consumer segment, with a strategy focussed on building and involving an online community of Makers. There is an obvious connection between *MakerBot* and *Maker Media*, traceable in the continuous media coverage offered by the latter

30 'MAKE Division Spins Out From O'Reilly Media as Separate Company.' Marketwire. Accessed April 14, 2014. <http://www.marketwired.com/press-release/make-division-spins-out-from-oreilly-media-as-separate-company-1749632.htm>.

31 'Maker Movement.' *Maker Faire*. Accessed April 8, 2014. <http://makerfaire.com/maker-movement/>.

ALESSANDRO CARELLI, MASSIMO BIANCHINI, VENANZIO ARQUILLA

about the activities of the producer, and by the fact that *MakerBot* printers are distributed by *Maker Media* through its digital store (Make Shed).

Thingiverse is a file-sharing platform for 3D printing, designed by one of the co-founders *MakerBot*, one of the most used among those in the Maker Ecosystem (see figure 1):

'... Thingiverse Community was built from the ground up as a place for people to freely share their digital designs for physical objects. We built it to be as inclusive as possible. It will accept almost any digital file, so long as it a design for a real, physical object'³².

Companies driving the Maker Ecosystem

Source: Riedited from the original map by Ponoko_MediaKit.pdf

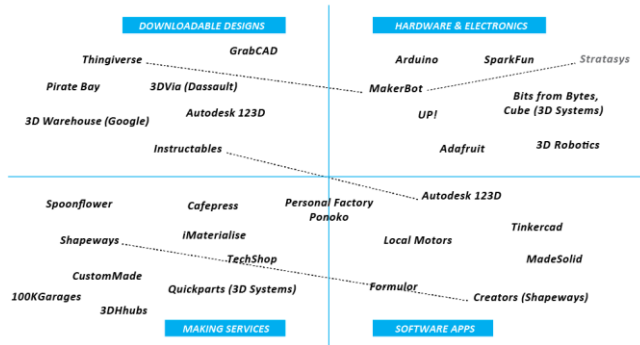


Figure 1 *MakerBot-Thingiverse within the Maker Ecosystem (source: edited map from Ponoko Media Kit.)*

Today the *Thingiverse* community is the backbone of the commercial strategy of *MakerBot*, based on sharing projects by its members and open licenses.

The most significant changes made to the platform, prior to the obtainment of the first funding from *MakerBot* announced in August 2011, have affected the relationship between *Thingiverse* and the user community. Two events are examples of the transformation of the *Thingiverse* community in a *branded community*: the announcement of a

32 Remko. 'THINGIVERSE / ZACH SMITH | Open Design Now.' Accessed May 11, 2014. <http://opendesignnow.org/index.php/case/thingiverse-zach-smith/>.

name change into 'Makerbot Thingiverse' in January 2012 and the changes in Terms Of Service in September 2012.

In particular, this affected the less expert users, being provided with 'ready-to-print' content and tools that simplify and automate the customisation of designs. By doing so, *MakerBot* affects the modality of interaction to the community of *Thingiverse*, by changing the Architecture Information (AI) and the *User Interface* (UI) of the platform. Practice Theory is a theoretical framework related to socio-technical studies based on the idea that, in order to better understand social phenomena, 'practice' should be taken as the main unit of analysis (Magaudda, 2012).

Through Practice Theory we want to show how the original intent of making *Thingiverse* 'to be as inclusive as possible' should be checked against the commercial strategy of *MakerBot* (table 2).

Table 2 Chronological reconstruction of the relationship between *Makerbot* – *Thingiverse*.

Year	Month	Thingiverse	Makerbot	Link
2008	October	Launch of the online platform		http://opendesignnow.org/index.php/case/thingiverse-zach-smith/
2009	March		Launch of Cupcake CNC.	
2010	September		Launch of Thing-O-Matic.	
2011	August		Makerbot announces \$10million fundings.	http://www.makerbot.com/blog/2011/08/23/all-star-lineup-invests-in-makerbot/
2012	January	First update of the platform interface, introducing the 'featured items' and the first tools for the personalisation of the user profile. The two best improvements relate to the introduction of two new functions to share derivative designs. The introduction of two new functions: 'I Made a Derivative' then transformed in 'remix' and 'I Made One' to share the results of the cretion of an object shared by another user.		http://www.makerbot.com/blog/2012/01/09/new-and-improved-thingiverse/
			Launch of Replicator.	
			'Thingiverse' becomes 'Makerbot Thingiverse'.	http://makezine.com/2013/01/12/makerbot-changes-the-name-of-thingiverse-to-makerbot-thingiverse/
	June	Introduction of project 'categories' (3D printing, art, fashion, gadgets, hobby, household, learning, models, tools, toys and games).		http://www.makerbot.com/blog/2012/06/12/thingiverse-categories/
	August		Makerbot publishes the files 'Black Dynamite Bust' on the Thingiverse portal during the marketing campaign of the film carrying the same name.	http://www.thingiverse.com/thing:27832
	September	Changes to the Terms of Service (TOS)		As a response to the Terms of Service, Joseph Prusa starts the campaign Occupy Thingiverse (http://www.thingiverse.com/thing:30808)

		Launch of Replicator 2 and Replicator 2X	This version was sold exclusively pre-assembled. The design of the printer is definitely closed-source.
	November	Launch of the new Dashboard including tools for the customisation of user profiles and the introduction of new features such as the button 'like', 'follow' and the notification feed system .	http://www.makerbot.com/blog/2012/11/07/introducing-makerbot-thingiverse-dashboard-and-follow-features/
		Launch of the 'Makerbot Academy'	http://www.makerbot.com/blog/2014/03/21/makerbot-desktop-education-part-1-perfect-pair/
2013	January	Makerbot releases the web application 'customizer' and the features for the platform	http://www.makerbot.com/blog/2013/01/18/design-unique-things-easily-with-makerbot-customizer/
		Makerbot releases the file: Nokia Lumia 820 MakerBot Shell on Thingiverse	http://www.thingiverse.com/thing:43163
	August	Improvements of the UI for mobile devices and further tools for the customisation of profiles.	http://www.makerbot.com/blog/2013/08/08/thingiverse-a-fresh-new-look-on-thingiverse/
		Launch of the Makerbot Customizer Challenge	http://www.makerbot.com/blog/2013/01/23/win-a-makerbot-replicator-2x-experimental-3d-printer/
		Makerbot announces the collaboration with Microsoft and the sale of their printers in selected Microsoft stores.	http://www.makerbot.com/blog/2013/08/07/the-makerbot-experience-at-a-microsoft-store-near-you/
		Makerbot announces merger with Stratasys.	http://www.businesswire.com/news/home/20130815006088/en/Stratasys-MakerBot-Complete-Merger
		Launch of the Digitizer Desktop 3D Scanner	
	October	Implementation of the 'featured items'.	http://www.thingiverse.com/featured
		Implementation of 'verified items'	http://www.makerbot.com/blog/2013/11/08/stylecolor000thingiverse-featured-things/ http://www.thingiverse.com/thingiverse/collections/verified/page:1 http://www.makerbot.com/blog/2013/10/16/thingiverse-verified-prints/
	November	Launch of the contest 'Math Manipulative Challenge'	http://www.makerbot.com/blog/2013/11/12/thingiverse-makerbot-academy-math-manipulative-challenge/
2014	January	Makerbot announces the opening of their Digital Store for the sale of printable toys on-demand.	http://www.makerbot.com/blog/2014/01/06/makerbot-digital-store-new-online-shop-for-unique-3d-models/
		Launch of the Replicator Desktop 3D Printer (Fifth generation).	
		Launch of the Makerbot 3D Ecosystem*	http://www.makerbot.com/blog/tag/3d-ecosystem/
	March	Introduction of the 'Makerbot Desktop' software : to manage printing files, use cloud computing service, access Makerbot digital store and integrate the profiles of the Thingiverse platform.	http://www.makerbot.com/blog/2014/03/21/makerbot-desktop-education-part-1-perfect-pair/

In order to show that the strategy of *MakerBot-Thingiverse* is based on the shifting of the making practices from production to consumption, we will consider two emblematic examples:

1. the introduction of the *customizer*, a web application that simplifies the customization of parametric geometries;

2. the introduction of *verified items*, whose files, optimised to be printed with *MakerBot* products, are directly distributed by *MakerBot* onto Thingiverse.

These applications have been analysed in relation to the changes of the AI and the UI of *Thingiverse*³³, chronologically reconstructed through the official press releases by *MakerBot* on its blog³⁴.

In January 2013 *MakerBot* announced the launch of 'Customizer', a web application for the customization of 3D designs based on OpenSCAD. It is a tool that allows customisation of parametric files through simple visual commands. Customizer makes it easier for users to modify designs without prior knowledge in 3D modelling.

A good case study is the 'Customized iPhone Case'³⁵ (Figure 2) a project for the customization of an iPhone case shared through the official *MakerBot* account. According to a research conducted on 117.450 objects published on *Thingiverse*³⁶, this is also the project that has been 'remixed' the most by users – that is customised and re-shared on the platform – although printed only 11 times. The interventions that specifically affected the platform are the following:

- the implementation of the category 'customized things' to make it easier for users to find customizable files;
- the addition of the button 'open in customizer' on the web interface.

In addition, it is interesting to note how the strategy adopted by *MakerBot*, further to the interventions on UI and AI of the platform, includes the organisation of thematic challenges to engage the community (table 3). In this case, the implementation of the *Customizer* was followed by the launch of a *contest* for the creation of parametric designs customisable with the web application.

By simplifying and automating the customisation of 3D geometries, customizer had drastically increased the 'derivative projects' (ie remixed),

33 As summarised on Table 1.1.

34 The changes in the information architecture of Thingiverse have almost always been followed by significant improvements to the user interface. From this point of view, in the history of the platform we can find four main moments summarised in Table 1.1 (January, June and November 2012, August 2013).

35 'Customizable iPhone Case by MakerBot - Thingiverse.' Accessed May 11, 2014. <http://www.thingiverse.com/thing:40703>.

36 The analysis is based on metadata available via website, not API and contains things collected from Jan 2009 to Aug 2013, and is available at the following link: <http://ossoil.com/thingiverse/>

ALESSANDRO CARELLI, MASSIMO BIANCHINI, VENANZIO ARQUILLA
 although without eliciting learning and spreading of significant knowledge,
 since all steps have been automated and optimised to be implemented with
 MakerBot products.

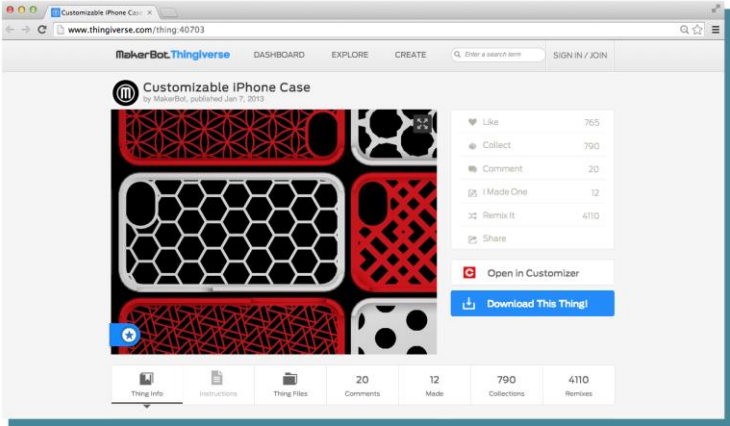


Figure 2 A sample of customizable thing: the iPhone Case.

Table 3 Description of the tools to share files on Thingiverse.

Tool name	Description	Implementation date
Comments	Main area dedicated to users.	Since the first version
Made	It is a tool for sharing photos showing the creation of a project shared by another user. All projects created in this way are collected under the specific item "I Made One" on the page of the original project.	January 2012
	'Screwless Cube Gears' ³⁷ , a gadget lacking any specific function, is the most 'reproduced' project among the community of Thingiverse.	

37 The project is available on the following link: <http://www.thingiverse.com/thing:38712>

<i>Remix</i>	This feature allows the identification of a project as the derivative of another. In the jargon of the hacker community activity the implementation of a new project derived from an open source project is called "fork". In this case, the choice of referring to 'remix' seems more inspired by the phenomenon of the creation of derivative projects on the network as the "mashup" found in the digital culture. This provides the combination, visualization, and aggregation of content available online, originally produced for other purposes	
	'Customized iPhone Case' ³⁸ , The project for the customisation of an iPhone case shared through the official Makerbot account, is the most 'remixed' project although printed only 11 times, according to the data on the project page.	
<i>Categories</i>	For each project shared on Thingiverse it can be applied a category between those allowed by the platform, in addition to the possibility of adding a series of tags through the folksonomy system.	June 2012
<i>Like</i>	Provides the opportunity to express appreciation of projects shared by other users.	November 2012
	'Gear Bearing' ³⁹ , the equivalent of a prototype of a ball bearing designed to be printed in 3D with plastic material turns out to be the object with the greatest number of 'likes' as well as 'collected'.	
<i>Follow</i>	It allows the creation of a list of users of whom it is possible to receive updates on their activities on the platform. It is currently not possible to organise lists of users by theme.	
<i>Updates/feed</i>	The notification feature on users that are being followed.	

Verified items

These are optimised geometries 'ready to print' distributed on *Thingiverse* (October 2013) through the official *MakerBot* account. Their introduction represents a further step towards the simplification and

38 The project is available on the following link. <http://www.thingiverse.com/thing:40703>

39 The project is available on the following link. <http://www.thingiverse.com/thing:53451>

automation of the processes that generate digital design. In fact, thanks to *verified items*, *MakerBot* has on one hand reduced the technical skills necessary to the users and, on the other hand, pushed users to use their product.

As in the case of the customiser, also the *verified items* are part of the strategy called 'Makerbot 3D Ecosystem', that includes a new set of digital applications integrated and across devices. Among these is the 'Makerbot 3D Printshop', an application for tablets that will soon be released and will allow to browse the list of tested geometries, view and make simple changes, and optimise the printing process of the printer model that will soon be released.

MakerBot has therefore affected the development of *Thingiverse* by favouring their own products and reducing the gap between the online community and the marketplace. This latter aspect of the strategy clearly appears in the application *Makerbot Desktop*, the equivalent of iTunes for 3D geometries, in which many cloud computing services coexist for the synchronisation of devices, of the digital library, the *Thingiverse* community and the marketplace.

In the light of this reconstruction it is possible to observe how the changes made to *Thingiverse* for the past four years have been determined by strategic choices, even at the expenses of the first user community, as shown by the reaction of community members after *MakerBot's* decision to abandon open hardware and changes in the TOS.

MakerBot, in order to reposition its brand from a niche to a market capable of attracting less expert users, it has introduced in *Thingiverse* a series of tools to simplify, automatise and optimise the design phases.

The tangible result of this strategy, similar to that observed by Magaudda (2008) in hacking practices, is the process of 'consumerisation of the making activity'. In certain areas, such as the ones analysed in the *Thingiverse* community, *MakerBot's* market strategy has shifted Makers from being producers to consumers, in which the 'practice of making' is gradually accompanied by their 'experience'. The latter acts in two complimentary ways: on one hand it lowers the level of expertise necessary to realise the design – often reduced to small customisations – on the other hand it encourages users to employ systems bound to the functions provided by the producer.

The combination of these aspects, turning Makers into consumers of a service, and including them in *MakerBot's* commercial strategy aimed to

direct Makers towards non open source tools, all contribute to define what we called the 'Makers contradiction'.

5. The 'Makers contradiction': conclusions, limitations and potential for further analysis

The global spreading of the Makers phenomenon is leading to the emergence of a new socioeconomic system of *making*, in which DIY practices are shifting from a pure production to a consumption experience, with the addition of services and simplified tools for self-production.

Our analysis has pinpointed two main kind of relationships between Makers and market. One focussing on the 'market-community' and on the study of subjects that consider Makers as 'consumers of making', where *Maker Media* plays a vital role.

A second interpretation comes from the study of the literature on 'critical cultural studies of marketing' (Zwick, 2013), analysing the activities of *Maker Media* in relation to critical theories on brand management and the shaping of branded communities (Arvidsson, 2005), and by investigating the mechanisms supporting the viral spreading of the maker.

In this second scenario we highlighted the transformation of some DIY practices, shifting from production to 'consumption of production' and, consequently, the emergence of a new kind of Maker, for whom DIY and personal fabrication become the expression of a sophisticated form of consumption.

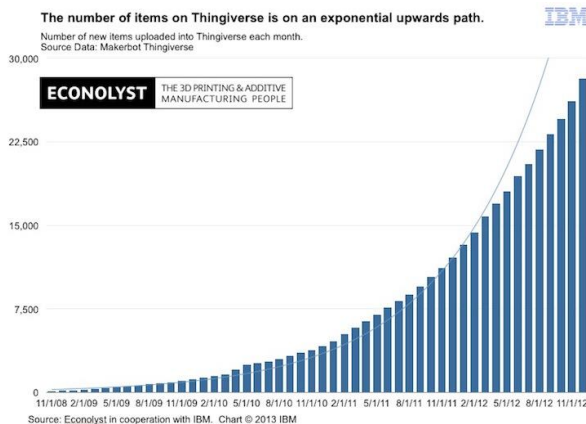


Figure 4 The exponential growth of the uploaded items on Thingiverse.

For a better understanding of this passage, we analysed the branding process undertaken by the *Thingiverse* community, showing how this then affected the development of the commercial strategy of *MakerBot*.

The changes made to the *Thingiverse* platform fall within *MakerBot*'s strategy of expanding their consumer segment within the 3D printers market. The analysis has shown the course of action of *MakerBot* towards the community: it favoured users with less technological expertise by adding digital tools to the platform aimed to simplify and automatise the design process. However, the analysis reported in the present paper has some limitations:

1. The 'Makers contradiction', the influence of the economic actors on the development of the Makers community and the public figure of the Maker have not been extensively analysed in relation to the role of economic forces within the processes of social negotiation (Latour, 2005);
2. The analysis was limited to the *Thingiverse* platform, which did not allow comparison with other communities dedicated to making.

A follow up analysis on the transformation of the Maker figure could, as well as incorporating the two points reported above, use the critical theory of technology perspective in order to look at the mechanisms underpinning the construction of the 'making experience'.

If it is proven that the actors investigated and their commercial strategies are aimed to expand the Makers community (or expand to those experiencing making), it still needs to be demonstrated whether this benefited the quality of knowledge created within the maker community and the material culture of our society in general.

The present paper does not want to diminish the social and economic importance of the Makers phenomenon, but wants to contribute to fuel the public debate outside the rhetoric adopted by the economic actors, who seem now to prevail within this context. This raises several questions on the social and economic role of Makers, now that making practices are seen as possible sources of development and that 3D printers will soon appear in schools.

Finally, with an increasing worldwide community of makers and the increase of promoted initiatives aimed to such community, it seems necessary to address some crucial themes related to the development of such Movement. For example, what instances of social, economic and technological innovations could develop within a movement created, sustained and guided by global economic actors that aim to capitalise on the

fundamental values of this rising culture? How is it possible to promote the aspects genuinely most innovative? How will the Maker Movement (and its ideals) evolve following the consolidation of the 'maker contradiction'?

References

- Abrahams, S. (2008) *Handmade Online: The Crafting of Commerce, Aesthetics and Community on Etsy.com*. University of North Carolina: Electronic Theses and Dissertations.
- Dean A. and Dean A. (2012) The DIY 'Maker Movement' Meets the VCs. [online] *BusinessWeek: Small_business*. Available at: <http://www.businessweek.com/articles/2012-02-16/the-diy-maker-movement-meets-the-vcs>. [Accessed: 2014, May 12th].
- Arvidsson, A. (2005) Brands: A Critical Perspective. *Journal of Consumer Culture*, 5 (2), 235-258.
- Burgess, J. and Green, J.B. (2008) *Agency and Controversy in the YouTube Community*. Paper Presented at the Association of Internet Researchers (AoIR) conference, University of Copenhagen, Denmark.
- Campbell, C. (2005) The Craft Consumer : Culture, Craft and Consumption in a Postmodern Society. *Journal of Consumer Culture*, 5 (1), 23-42.
- Coleman, G. and Golub, A. (2008) Hacker Practice: Moral Genres and the Cultural Articulation of Liberalism. *Anthropological Theory*, 8 (3), 255-277.
- David, S. (2008) *Open Systems in Practice and Theory*. Dissertation Presented to the Faculty of the Graduate School of Cornell University.
- De Bruijn, E. (2010) *On the Viability of the Open Source Development Model for the Design of Physical Objects*. Thesis for the degree of Master of Science, University of Tilburg.
- Dean, J. (2010) *Blog Theory. Feedback and Capture in the Circuits of Drive*. Cambridge: Polity.
- Delfanti, A. (2014) *Biohackers: The Politics of Open Science*. London: Pluto Press.
- Delfanti, A. (2013) Geni ribelli. La scienza aperta nell'immagine pubblica di due biologi. *Tecnoscienza. Italian Journal of Science & Technology Studies*, 4 (2), 27-49.
- Feenberg, A. (2005) Critical Theory of Technology: An Overview. *TAILORING BIOTECHNOLOGIES*, 1 (1), 47-64.
- Gillespie, T. (2008) The Politics of Platforms. *New Media & Society*, 12 (3), 347-364.
- Harvey, D.A. (2005) *Brief History of Neoliberalism*. Oxford: Oxford University Press.

ALESSANDRO CARELLI, MASSIMO BIANCHINI, VENANZIO ARQUILLA

- KelTy, C.M. (2008) *The Cultural Significance of Free Software*. Durham: Duke University Press.
- Latour, B. (2005) *Reassembling the Social. An Introduction to Actor-Network-Theory*. Oxford: Oxford University Press.
- Lessig, L. (2004) *Free Culture: How Big Media Uses Technology and the Law to Lock Down Culture and Control Creativity*. London: Penguin Press.
- Lipson, H., Kurman, M. (2013) *Fabricated*. Hoboken: John Wiley & Sons.
- Magaudda, P. (2012) How to Make a Hackintosh. A Journey into the 'consumeri- Zation' of Hacking Practices and Culture. *Journal of Peer Production*, 2, 1-8.
- Marsh, P. (2012) *The New Industrial Revolution: Consumers, Globalization and the End of Mass Production*. Yale: Yale University Press.
- Morozov, E. (2013) The Meme Hustler - Tim O'Reilly's Crazy Talk. *The Baffler*, 22, 66-67.
- Reckwitz, A. (2002) Toward a Theory of Social Practices A Development in Culturalist Theorizing. *European Journal of Social Theory*, 5 (2), 243-263.
- Rifkin, J. (2013) *The Third Industrial Revolution: How Lateral Power Is Transforming Energy, The Economy, and The World*. New York: Palgrave Macmillan.
- Ritzer, G. and Nathan, J. (2010) Production, Consumption, Prosumption : The Nature of Capitalism in the Age of the Digital 'Prosumer'. *Journal of Consumer Culture*, 10 (1), 13-36.
- Zwick, D. (2013) Utopias of Ethical Economy: A Response to Adam Arvidsson. *Ephemera. Theory and politics in organization*, 13(2), 393-405.

Foretelling and Shaping the Future of Technology: the Role of Communication Designers in the Design of Innovation

Margherita PILLAN^{*}, Marco SPADAFORA and Annamaria Andrea VITALI

Politecnico di Milano

This paper explores the role of communication designers in a multidisciplinary project team aimed to the development of smart systems (internet of things and digital solutions for public spaces), and it is based on a two year long experience during which the authors cooperated with researchers from academic and industrial institutions. In this experience, we faced the challenge of designing innovative solutions working with researchers characterized by different backgrounds, different expectations, values, priorities and design methodologies. To cope with this complex design context, and to exploit the potentials of the multicultural contributions, we experimented the early adoption of communication design tools and we demonstrated that the early production of video-scenarios illustrating meaningful aspects of the user experience, can be effectively employed to build a common ground in multicultural design teams, and to orient the development of innovative solutions toward a design driven process even in technology oriented project teams. We believe that, in order to produce desirable innovative solutions, the invention of metaphors, meanings and languages defining the aesthetic attributes of a digital product or system should be afforded before the definitions of the functional characteristics so to inspire and guide the following project steps.

Keywords: Smart systems; communication design; interaction design; design driven innovation; co-design; user experience

Introduction

The design of digital interactive artefacts based on innovative technologies requires the cooperation of different actors – designers,

^{*} Corresponding author: **Margherita Pillan** | e-mail: margherita.pillan@polimi.it

engineers, marketing experts – to create suitable solutions, and a specific design action to communicate the product itself and to prepare the ground for innovation. Nevertheless, the efforts required to create successful innovative solutions (products or services), is still huge and the failure rate very high.

Recently, some authors have presented new approaches for interaction design, in which communication designers are involved from the real beginning of a project to simplify the dialogue between the actors of the design process (Erwin, 2014). The basic idea, that has been previously investigated in other domains of design (Stumpf, 2001; Tang, 1998), is that, in order to develop complex projects requiring the cooperation between different actors, it is mandatory to support the communication inside the project team, and to facilitate the co-creating process through the development of artefacts by providing a reference frame.

Our paper explores the role of communication designers in a multidisciplinary project team working on the design of interactive solutions, and it is based on a two year long experience in the JOL - Joint Open Lab 'S-Cube' at Politecnico di Milano. In the Lab, we are working at the development of innovative smart products and environments in collaboration with researchers belonging to the industry and academic worlds. We recognize as an important goal the development of effective and efficient design tools to inspire the contributions of the team members and facilitate the discussion in the project team.

While scenario-based approaches for project have been already investigated in literature (Kruger, 2006; Brown, 2009), we report here the influence of communication tools in real team work – mainly composed of technology oriented researchers- and we analyse their utility to manage complex project goals and constraints, to focus efforts toward users' needs and to foster creative and critical contributions toward the search of best solutions.

The main contribution of designers in the design of innovative solutions is expected in terms of languages (physical attributes, symbolic interaction, metaphors). In the design of digital solutions, that are significantly innovative also from the technological point of view, the cooperation between designers (in charge of the factors influencing the final user experience), and technologists (aimed at the development of suitable digital solutions), is not trivial, since the different actors in the project team are characterized by different languages, mental schemes, expectations, priorities, methodologies.

In our opinion, in order to be effective, the design of innovative solutions should be guided by preliminary design activities aimed to prefigure metaphors and communication main frames driving the development of technological solutions so to lead them toward the implementation of acceptable and desirable proposals, not requiring overexertion from the final users to be understood and appreciated. The design driven method we adopted is based on an aimless ethnographic research as first step to explore users relation with technologies in everyday life, showing undisclosed needs and motivations, and on the generation of video-scenarios illustrating the qualitative elements of the user experience, to be employed as guidelines for the further project phases. In our conviction, the only innovation that is worth developing, is the one you can well communicate.

In interaction design projects, communication designers are usually asked to give a contribution in terms of graphic interfaces, and of metaphors and communication artefacts to support the understanding of innovative products and services (Pillan, 2001; Benyon, 2005; Saffer, 2007; Buxton, 2007). Our experience supports us to believe that the invention of languages and metaphors should anticipate and lead the development of innovative solutions based on digital technologies. Inspiration elicited by ethnographic analysis can be represented and shared through communication artefacts fertilizing co-creation in multidisciplinary project teams. Communication design knowledge can be employed to recognize and clarify the aesthetic and formal attributes of different acts of use supported by technologies, and to understand the rhetoric load of actions, gestures and interactive procedures.

Acting as designers in a technology-oriented research team

The expressions 'smart objects' and 'smart spaces' collect a very ample variety of solutions aimed to support human activities through the exploitation of digital technologies: mobility and transportation, health care, optimization of energy consumption, ubiquitous information, innovative domestic environments, services for shopping are the main fields of application. The development of this kind of solutions is hard to manage for several reasons: we deal with radical innovation requiring collaborative co-creation and therefore effective and suitable communication between the actors involved in the project process. In most cases, digital solutions have a

complex nature from the technical and material point of view: they appear as mix of non-tangible functionalities and of material enabling solutions, and the final result is better described in terms of user experience. Since smart products and systems are meant to support users in their daily activities, they require full understanding and acceptance, not limited to usability factors but also with respect to emotional and cognitive involvement and gratification. As in the design of material objects, the functional characteristics of the digital solutions must be optimized together with the formal elements influencing the desirability of the interactive processes involving the users and affecting the modalities of fruition.

In a multicultural project team aimed to the development of a smart solution, the construction of an effective collaborative context is never a trivial task: when we cope with radical innovation, the first project phases are made hard by a huge number of possible directions toward which the researchers should address their efforts. The proposition of innovative ideas is an emotion rich experience, engaging team members and calling in their values, expectations, motivations and more.

Innovation can be pursued from several perspectives: from the technological point of view, it consists of making possible (or improve) a process or an activity that was not feasible before; from the user experience point of view, the goal is to provide value in terms of functions, meanings and overall users satisfaction. The co-creation of innovation by different actors requires the construction of a shared language and of system of references eliciting creative contributions prior the definition of the detailed project goals. This is a communication task.

In our experience at the JOL 'S-Cube', acting as designers, we faced the challenge of building a common ground with technology experts through the construction of a shared imaginary to take as a reference in the development of innovative solutions. As designers, our focus is on acceptability and desirability of new systems; therefore, our first goal is to detach mental references from science-fiction like representations of technology-based future scenarios and to define more realistic imaginaries, corresponding to a more human centred aesthetics of innovation.

As a part of our research, we experimented the creation of video-scenarios based on ethnographic research performed as a preliminary activity in the design of innovative smart solutions; our focus was on the description of the qualitative characteristics of the user experience with respect to a given activity (such as mobility by the public transportation, or information in public spaces). The objective of the ethnographic research is

to provide inspirations for the designers but also to make a preliminary qualitative research to collect phenomena, identify users attitudes, behaviours, moods and tacit needs. On-field observation and data gathering also provide documentation useful as reference in the generation of new concepts of products and services.

In our experience, the development of video-scenarios is very effective and efficient to envision real behaviours, and to sketch realistic but innovative contexts; it allows also the investigation of the dynamic elements of users activities supported by digital systems even when the physical and systemic features of the technological solutions are still non yet well described and detailed.

When video-scenarios are realized on the base of knowledge about real behaviours and needs, they have the power to detach the attention from the 'ideal' (but not-existing) world of perfectly working technologies where people will experience a life with no frustration and no efforts thanks to the wonders of the new discoveries. It is therefore possible to substitute this imaginary with the perspective of a more realistic and desirable future, so to elicit the collaborative contributions of the team members toward a shared goal.

The role of ethnography analysis in the definition of aesthetic issues for digital systems

By browsing the web, it is easy to find video-scenarios related to technological innovation, which have the goal to envision how the world will look like in the next years.

Very often, these videos are considered a reference point for researchers and innovators and orient their actions toward the vision represented in them. This process has a strong relevance in the research community, and it is particularly significant for those companies that do not invest in the envisioning of the innovation strategies and that acquire their assets from other entities and the market trends.

Analysing the position of our industrial partner in the innovation process, we understood that a deep analysis of this medium would help us to create useful knowledge about the co-creation, and that it has relevant role with respect to the goal of improving the common understanding and the strategic addressing of the innovation process (Mackay, Ratzer and Janecek, 2000).

As an instance, we can consider the video scenario produced to envision the ideal user experience in a high technological environment during the visit in Milan for the Expo 2015 (link: https://www.youtube.com/watch?v=_5elq77BhUE). It was realized to provide a reference for companies who intended give a contribution to the implementation of high tech solution to support the visitors experience at the next EXPO 2015, and was analysed by Telecom Italia and our research group to understand expectations and plans of the event's organization from a technological point of view.

The analysis of the video within a group composed by designers and engineers, brought to evidence some positive and negative aspects of it; for sake of conciseness, we describe here tautly which where the opportunities of improvement we found.

With respect to the technological point of view, the video revealed the importance of a structured experience on a systemic base; indeed it brings to evidence how the implementation of a smart service requires the connection of every technological element to a main system. From the engineering perspective this is a very important indication, pointing out the relevance of systemic design with respect to the optimization of single elements.

Analysing the video from the user experience point of view, we point out that it appears to be very detached from real world contexts; to appreciate the user experience described in the video, we should accept behaviours, emotions and attitudes shown by the characters impersonating the users, that are indeed far from credible. This is not only a question of scarce storytelling, is a relevant lack with respect to the importance of taking into account real people needs and behaviours in the design of interactive solutions.

In our opinion, if we intend to use videos as form of effective representation technique, much more robust then the Personas by Alan Cooper, a video-scenario trying to picture the future should be based on a reasonable set of observation of real people and contexts so to depict plausible dynamics and address the project toward a projection of what will be that is feasible from the technical point of view and acceptable from the human perspective. This is even more important if the video-scenario deals with a vision regarding a future within the 2 or 3 years, as it was for the cited one.

The video-scenario we refer to, appears to be reasonable from the technological point of view, but not from the point of view of the interaction

between people and the technological products; it doesn't consider how people relate nowadays with the smart objects around them; it doesn't describe the emotional factors in the relationship between people and smart objects; it doesn't show a sufficient understanding of the metaphors that support the interactions with digital solutions (figure 1). Gestural interaction, augmented reality, etc., are used more to show the technological power of the innovative solution, and the enthusiastic description of the functional advantages for people using the smart devices have the same credibility of some commercials showing how a product can solve all life's problems. Of course, the video we refer to was not meant as a project tool; the problems rises since it is employed as if it was a design tool and if the unrealistic character described in it is taken as a reference of users expectations and needs.

	A LOT OF DATA, HOW CAN I CHOOSE THE ONE RELEVANT FOR ME?	EMPATY	SURPRISE
	WHY DO I WANT TO BE GUIDED?	TRUST	SHARED VALUE
	WHY SHOULD I WANT TO PROJECT PERSONAL INFORMATION ON A PUBLIC WALL?	PERSONALISED EXPERIENCE	QUALITY VS QUANTITY
	ALONE! A LOT OF VIRTUAL INTERACTION NO REAL INTERACTION	TANGIBLE INTERACTION	AUGMENTED INTIMATE SPACE

Figure 1 One of the schemes used to collect the feedbacks on the video about Expo2015 and enlightening questions and issues related to interaction design choices.

Videos are quite effecting in describing the dynamic features of interactive solutions; furthermore, they allow the representation of cognitive and emotional elements of the users experience and, being visual, include a great amount of information that cannot be expressed through verbal communication. In order to produce effective representations of technical and human factors of the interactive systems, videos must be realized with a specific language, avoiding stereotyped characters and the schemes of commercial communication.

In order to structure our research on a solid common understanding of people real needs and attitudes, and to address the project efforts toward the development of human centred smart technologies, we decided to go through an ethnographic research process with four main goals:

- to create a an imaginary but realistic context to be used as a reference for the different components of our research group, technologists and designers, industry and academia members;
- to understand the emotional and cognitive dynamics elicited by the interaction with smart technologies, and the implicit and tacit drivers of the use of technological solutions;
- to investigate how these interactive processes change according to the different environments. As an instance, we wonder how the use of a smart device can change in a private space from a public one;
- to simulate and to evaluate realistic dynamics of interaction between people and smart systems.

We employed this design approach in a number of design experiences in cooperation with JOL 'S-Cube', aimed to the design of innovative products and services. In the following we will report and discuss some results obtained through the above described methodology, that were produced in a studio project lab involving the students of the master degree course of the School of Design at Politecnico di Milano. The use of a design methodology in an education project lab is a test of its effectiveness and provides a large amount of outcomes that can be used to refine the approach. The project course was named 'Interaction Chiromancy' since the goal assigned to students was the outline of future scenarios based on digital technologies. Ethnographic research was the initial activity of the design process assigned to students. Below (figure 2) you can find a set of images that were part of the meaningful insights collected by students.



Figure 2 Ethnographic Research: a) a woman tries to use a display screen as a touch screen; b) an intimate moment created by a shared screen; c) public space becomes private space thanks to technology.

As result of the ethnographic process we can say that students outlined a clear description of relevant and common phenomena related to the relationship between people and smart systems. They highlighted people behaviours and needs, and realistic environments and phenomena, producing a meaningful description language, very different from the one often used in videos created to inspire technological solutions. The concepts and the videos generated by students were very important in the relationship with Telecom Italia, because they amply demonstrated the effectiveness of our approach, solving doubts and concerns expressed previously, and building a shared set of information to work on.

Design driven development of technological solutions

In this paragraph, we will present the main features of the design approach adopted with the students of the 'Interaction Chiromancy' project lab.

The projects brief assigned to the students (final year of the master level) required to envision innovative concepts of products and services based on innovative smart technologies presented by our partner experts. We decided to not indicate a specific context or an application domain for the solution to be designed and, instead, we asked to scout for fertile contexts and to produce indications about them as a fruits outcome of the ethnographic research. The design process was divided into three main phases: 1) ethnographic research; 2) initial concept generation of the possible solutions visualized through video-scenarios; 3) redefinition of the concept and production of final video-scenarios. After each of these three phases, the outcomes and the work in progress were shared with researchers from JOL 'S-Cube', through dedicated revision sessions in order to grant co-design process between the two parts, and the discussion about values and meanings through different communication tools.

In the first phase (lasting one month), students observed people using technology in everyday situations, without focusing on a specific topic or context. They collected photos, thoughts and inspiration, and observed what people do while they are travelling, eating, reading, communicating,... and the observations were carried on in any kind of public and private spaces.

We asked the students to identify people needs, attitudes, emotions and difficulties, to collect documentation and to analyse it with a critical

perspective. This activity produced meaningful insights and the technology experts from our industrial partner discovered the potentialities of aimless ethnographic research to discover undisclosed behaviours of people. At this point students selected their area of interest and defined the critical functional and emotional needs to satisfy through the design of innovative products.

In the second phase (one month), starting from the area and the needs identified, each group of students designed at least two different concepts based on different technological solutions, and envisioned them through a preliminary video-scenario. Different concepts of smart solutions explored, as an example, the relationship between analogue and digital experiences in activities such as reading; others focused on shopping, transportation and mobility.

In this phase, the concepts were still vague and not well defined from the technological point of view; nevertheless, the video-scenarios were a tool to support the imagination of the 'fuzzy new' (Erwin, 2014) between the different parts involved, and also a way to 'sketch' the supposed solutions, depicting the overall aesthetics of the acts of use, and the emotional and cognitive factors involved in the interactive process. By realizing different video-scenarios, as an architect does different sketches, advantages and disadvantages, weakness or positive aspects are enlightened: both designers, and technicians can chose the best solution to prototype, having clearly imagined the potential user experience.

Video-scenarios are usually employed to visualize the processes of interaction with a technology from a functional point of view, and they are aimed to demonstrate that technologies work to facilitate users in a specific task. On the other hand, in a design driven context for innovation, we employed video-scenarios to represent the desirability of the solutions proposed in realistic contexts, based on previous ethnographic research. Despite the technological ambiguity of this preliminary phase, there is the space for critical reflections and co-design activities. Through video-scenarios the communication designers become able to frame the design objectives of the team, and to envision interactive concepts through metaphors, so to optimize their efforts to create and communicate new meanings.

In the last phase (two months), students selected the most feasible solutions and worked on prototypes: systems of functionalities, mock-ups of interfaces and technologies were defined, and new revisited scenarios were created.

As an example, we compare here some student's results underlining the differences between the video-scenarios realized in the two phases.

Tam Tam Letterario

One team of students explored how smart interactive solutions can be introduced into traditional environments without endanger the emotional qualities of the 'analogue' world. They observed people engaged in reading books in literature cafés; the focus was on desirable mix between digital technologies and the needs of 'physicality' in everyday life. Acts of use and interactions with smart objects are changing the quality of experience between analogue and digital world; designers should focus on integration between physical and digital more than on substitution.

In the early stage, this team proposed two different concepts, in which the relationship between analogue and digital was stressed in the user experience. With the concept 'Smooze', they proposed a system through which customers of a cafés can communicate between each others, sending messages through smartphone and little printers placed on tables. Besides purely screen-based conversations, received messages can be printed on little pieces of paper. This scenario presented the story of a fuzzy smart technology facilitating a new behaviour between people, and mixing digital and analogue tools; the presentation explored the emotional part of these design choices: the possibility to conserve the paper message.

The second concept, 'Tam Tam Letterario', reinforces an existing habit of customers of literature cafés, i.e. people sharing quotes and thoughts from books they are reading, leaving messages on pieces of paper on the table. 'Tam Tam Letterario' envisions a future scenario in which, through digital technologies, people read books on tablets, share quotes on digital tables of the cafés and can conserve their preferred quotes printed on the bills. (figure 3).

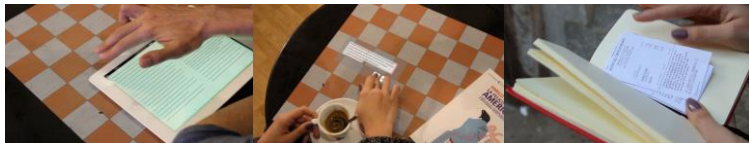


Figure 3 'Tam Tam Letterario': functionalities of the application in the preliminary video scenarios.

In this phase the technological details were not defined, nor the application or specific procedures of interaction. However, the video-scenario inspired designers and technicians telling the story of a place

where existing behaviours documented by ethnographic research, could be facilitated by smart technologies, eliciting and underlining the emotional aspects of book reading and sharing act.

In the end phase of the course, students together with industrial researchers decided to work on 'Tam Tam Letterario'. They defined in details the system of the service, technologies and devices involved in the process, interfaces and functionalities of the application (figure 4).



Figure 4 'Tam Tam Letterario': functionalities described in the final video scenario.

One interesting outcome was the fact that some interactions and acts of use were revised according to a more feasible solution for users (figure 5).

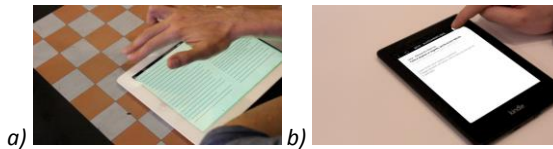


Figure 5 'Tam Tam Letterario': the act of sharing favourite quotes on the table, in the preliminary video scenario 'moving' citations from the device, to the table (a) and in the final version (b) through a 'share' button on the application interface.

Movely

Working in the context of mobility and transportation, another team of students identified the need of a 'smart ticket' to allow a fluid travel experience through different transportation services. The first video-scenarios depicted a typical traveller's situation in which the use of smart technologies – as a smart band – support rapid and easy access to transportation services (figure 6).

Before the prototyping phase, students revised their idea of the technological device enabling the smart ticket service, asking themselves if the use of a smart band is appealing and acceptable for users. In the final video-scenario – 'Movely' - they opted for the smartphone instead of the smart band, designing the interfaces of the app and all the functionalities of the services (travel information, suggestions, places to see and things to do, alert function etcetera.)(figure 7).



Figure 6 'Movely': preliminary video scenario and smart band as smart ticket.



Figure 7 'Movely': final video scenario and smartphone interface.

'Movely' is an example of how the use of video-scenario can be employed to represent a realistic context of use, where technology can improve the transportation services also supporting users in finding alternative solutions.

Conclusion and discussion

The development of innovative solutions, such as smart objects and digital services, requires the cooperation between engineers and designers, and the ability to develop a collaborative context so to facilitate co-creation and to orient the creative efforts toward a common direction; this task is not trivial but the effort is mandatory and worthwhile. Working in the JOL 'S-Cube' at Politecnico di Milano, we are experimenting the use of communication design project tools to the purpose of supporting the collaboration inside project teams. Our present focus is on representation techniques to be used in the design of smart services and systems to describe the main features of the users experience and the main cognitive and emotional phenomena.

We experimented the use of video-scenarios as a tool to synthesize the results of preliminary ethnographic research on field, to support the investigation of users needs, motivation and attitudes; furthermore we employed video-scenarios to define the main features of innovative products and services *ex ante*, so producing reference scenarios to guide the following project phases aimed to the physical design of the technical and material characteristics of the final solutions. To test and refine our methodology, we applied it in a project studio with students of a master

degree project lab; the experiment was successful since the methodology demonstrated to be effective in supporting the generation of concepts of products and systems that were innovative in several ways: from the functional point of view but also for the nature of the experience elicited by the interactive solutions. The video scenarios realized by the students at the end of the course were the communication products through which the parts involved, Polimi researchers, design students and Telecom experts, shared meanings and vision about different technological solutions.

Technology experts discovered the importance of orienting technologies toward practical and emotional needs they are intended to, instead of focusing only on pure functionalities. Designers' capabilities to extract emerging phenomena in realistic contexts and to represent future and convincing scenarios with respect to the use of innovative technologies was fundamental to support the imagination and co-design of future solutions; the approach resulted effective in orienting the design process before the realization of prototypes and interfaces.

The possibility to clearly imagine and to 'foresee' future interactive systems allows all the members of the team to share common objectives and visions necessary to the development of innovative products and their effective communication. As a result, Telecom experts have started to adopt video-scenarios as a tool to describe, communicate and analyse their industrial projects, before prototyping the entire solutions in order to validate concepts and ideas.

Acknowledgement

This work was partially supported by the Joint Open Lab 'S-Cube' - Telecom Italia S.p.A. – Innovation division, Italy. Prof. Marco Maiocchi, Irina Suteu and Fulvio Faraci were in the teaching staff of the course 'Interaction Chiromancy' together with Margherita Pillan; Marco Spadafora, Annamaria Andrea Vitali, Francesco Galli e Pietro Righi Riva tutored the course. The project 'Movely' was realized by the students Guglielmo Civardi, Davide Falasconi, Davide Pizzi, Andrea Villa, and 'Tama-Tam Letterario' was realized by the students Isabella Conticello, Eliana Dedda, Jiawei Li and Federica Sutera. A number of researchers from Telecom Italia gave a relevant contribution to the course lecturing the class about the most recent digital technologies that can be employed in smart solutions.

References

- Benyon, D., Turner, P. and Turner, S. (2005) *Designing Interactive systems. People, Activities, Contexts, Technologies*. Edimburgh: Addison Weasley.
- Brown, T. (2009) *Change by Design. How Design Thinking Transforms Organizations and Inspires Innovation*. New York: HarperCollins Publishers.
- Buxton, B. (2007) *Sketching user experience*. Burlington: Morgan Kaufmann.
- Erwin, K. (2014) *Communicating the New: Methods to Shape and Accelerate Innovation*. New Jersey: John Wiley & Sons.
- Kruger, C. and Cross, N. (2006) Solution driven versus problem driven design: strategies and outcomes. *Design Studies*. 22 (5), 527-548.
- Pillan, M. and Sancassani, S. (2001) *Costruire servizi digitali*. Milano: Apogeo.
- Saffer, D. (2007) *Designing for Interaction. Creating Smart Application and Clever Devices*. Berkeley: AIGA Design Press.
- Stumpf, S.C. and McDonnell, J.T. (2002) Talking about team framing: using argumentation to analyse and support experiential learning in early design episodes. *Design Studies*. 23 (1), 5-23.
- Tang, J.C. and Leifer, L.J. (1988) *A Framework For Understanding The Workspace Activities Of The Design Teams*. Paper Presented at the Proceedings of the 1988 ACM conference on Computer-supported cooperative work, New York.
- Mackay, W.E., Ratzner, A.V. and Janecek, P. (2000) *Video artifacts for design: bridging the Gap between abstraction and detail*. Paper Presented at the Proceedings of the 3rd conference on Designing interactive systems: processes, practices, methods, and techniques, New York.



Break-it, hack-it, make-it: the ‘Hack-a-Thing’ workshop series as a showcase for the integration of creative thinking processes into FabLab Genk

Katrien DREESSEN^{*a}, Selina SCHEPERS^a, Danny LEEN^a, Kris LUYTEN^b and Tom DE WEYER^b

^a KHLim / LUCA, KU Leuven; ^b Hasselt University

FabLabs are mostly known for their problem-solving approach since they allow people to develop and perfect a prototype of ‘almost any product’, using the available infrastructure, facilities and knowhow (Mandavilli, 2006). Since 2012, FabLab Genk too has become a hotbed for problem-solving activities. FabLab Genk is situated in a creative context and is used by many media, arts and design students, researchers, designers and artists, for creating a wide variety of physical objects that they could otherwise only imagine. However, we noticed that the creative thinking processes that occur before the actual problem-solving do not take place within the environment of FabLab Genk. As a way of including these creative thinking processes into its environment, FabLab Genk organised a series of workshops called ‘Hack-a-Thing’. This paper shows how ‘Hack-a-Thing’ proved to be a setup that facilitates new ways of learning and creative thinking in the environment of FabLab Genk. First, this paper illustrates that the ‘Hack-a-Thing’ workshop series allowed FabLab Genk to become an environment that fosters a new, more informal and creative form of learning. Second, this paper shows how ‘Hack-a-Thing’ stimulated a more creative way of using and thinking, particularly about alternative relationships with technological objects.

Keywords: *FabLab; workshops; creative thinking processes; learning; thinking*

* Corresponding author: **Katrien Dreessen** | e-mail: katrien.dreessen@khlime.be

Introduction: personal fabrication, FabLab Genk and creative processes outside of the FabLab

According to Neil Gershenfeld (2005), the digital revolution lies behind us and we have entered an era of personal fabrication. Personal fabrication means that we can download or develop digital product descriptions and designs, and supply these to the fabricator with the raw materials to process them. Personal fabrication indicates that we can make (almost) everything (Gershenfeld, 2005; Mikhak, Lyon, Gorton, Gershenfeld, McEnnis and Taylor, 2002). In this line of thought, Gershenfeld launched a project to create so-called 'FabLabs': Fabrication (or Fabulous) Laboratories that are globally dispersed open workplaces aiming to explore the implications and applications of personal fabrication. Personal fabrication creates the opportunity for mass production, a scenario where one could design and produce his/her own objects (Seravalli, 2011). Gershenfeld defines a FabLab as *'a collection of commercially available machines and parts link by software and processes we developed for making things'* (2005, p. 12). A FabLab allows people to develop and perfect a prototype of almost any imaginable product. Therefore, FabLabs are mostly known for their problem-solving approach since they allow people to develop and perfect a prototype of almost any imaginable product, using the available infrastructure, facilities and knowhow (Mandavilli, 2006). Access to the lab and its cutting edge equipment is absolutely free, including the training one can follow to get acquainted with the hard- and software (Milanese, 2006), provided that the FabLab user shares his/her designs (via the internet) with others in the form of 'fabmoments'. Documentation and digitally sharing designs places FabLabs in the context of open source: a philosophy, but also a pragmatic method of creation, via which organisations or individuals provide free access to source materials of a thing to a distributed network of people (Bauwens, 2007; Tribe and Jana, 2006; Open source initiative, 2010).

Inspired by Gershenfeld's initiative, the Euregional project 'Fablabs in the border region' (including Dutch and Belgian partners) sets as one of its primary goals to stimulate the collaboration between students and researchers with local industry and social economy. Furthermore, it aims to support innovation and encourage entrepreneurship among young people by giving them a chance in realising a first small series of products. FabLab Genk (www.fablagenk.be) is a local FabLab that has been set up as part of this project. It is currently fully operational and open for everyone.

FabLab Genk is situated at C-mine, a creative site in the city of Genk (BE) on which education, artistic creation and presentation, creative economy

and creative recreation are represented through many creative organisations, cultural centres, recreation facilities and academic institutions that are housed on the site. Because of this creative environment where the FabLab is situated in, the visitors of FabLab Genk are mainly students, teachers, researchers, designers, artists and people from the creative industries.

In contrast to its expectations, throughout the years we experienced that - although it is situated in an environment designed to stimulate artistic and creative activities - the artistic and creative processes do not take place within the environment of the FabLab itself. Instead, it became clear that FabLab Genk - its infrastructure, spaces and knowhow - is mainly used for the final phase of a process or project. This means that, corresponding to the FabLab philosophy as envisioned by Gershenfeld (2005), the visitors use FabLab Genk in a problem-solving way. For instance, as a part of a research project into low-tech designs and tools that assist a person with dementia to live longer and in a qualitative manner in the home environment, the art and design researchers of MAD-faculty used FabLab Genk in order to create a prototype of a rolling walker (<http://www.fablabgenk.be/node/2719>).

However, the artistic and creative thinking processes that took place in the earlier phase of the research project and that preceded the development of the rolling walker, took place elsewhere. Before developing the prototype, the art and design researchers involved in the project organised participatory design sessions with potential end-users and workshops with designers. These brainstorming activities took place in the daily environment of the potential end-users (usually, care centres) or in the research institution of the researchers themselves. We noticed that this is the case for most of the research- and education-related activities that take place in the environment of FabLab Genk.

However, over the years, we have constantly strived for including the artistic and creative thinking processes that take place in the early phases of a process or project into the environment of the FabLab. We believe that, by doing so, we can stimulate exploration of different possible solutions and the generation of additional design alternatives that contribute to better results. As Obrenović (2011) explains, this turns the activity of making into Design Research, leading to solutions of a higher quality since *'though we cannot explain such [design and problem-solving] knowledge and skills, we can demonstrate them by being engaged in a particular activity'*. As an attempt to include the artistic and creative thinking processes into the environment of FabLab Genk, we organised a series of workshops - called

KATRIEN DREESSEN, SELINA SCHEPERS, DANNY LEEN, KRIS LUYTEN, TOM DE WEYER

'Hack-a-Thing', as a part of the exhibition 'The Machine - Designing A New Industrial Revolution' (<http://www.the-machine.be/>).

In the following part, we discuss the 'Hack-a-Thing' workshops and explore how **the 'Hack-a-Thing' workshops facilitated the artistic and creative thinking processes to take place in the FabLab itself**. We first further explain the above-mentioned series of workshops. Subsequently, we discuss how the 'Hack-a-Thing' workshops were developed and based on pedagogical principles in combination with existing approaches, such as the 'Do-It-Yourself movement', 'Repair Cafés' and theories on constructionism and interdisciplinarity. We illustrate how this resulted in (1) new, more informal and creative forms of learning and (2) more creative ways of using and thinking about materials. Finally, we draw some conclusions and opt several suggestions (for the future).

In order to analyse the 'Hack-a-Thing' workshop we used the following methodology: based upon participant observations (DeWalt and DeWalt, 2010) and unstructured interviews with the participants of the Hack-a-Thing workshops, we formulated 'thick descriptions' (Geertz, 1973) that allowed us to relate our theoretical concepts to what was discussed and conducted during the workshops. In this way, not only the mere facts, but also interpretations of the workshop, the use of technology, results and comments were taken into account.

Break-it, hack-it, make-it: FabLab Genk and the 'Hack-a-Thing' series of workshops

The 'Hack-a-Thing' workshops started from the premise that people generally own a lot of old home appliances that are broken or not used anymore. As stated by Jackson and Kang (2014, p. 2): *'artifacts get designed, purchased, and adopted, but they also get fixed, discarded, and (sometimes) reused. Values get built into technology, but they still take work to maintain – and additional, sometimes alternative values may be introduced through ongoing acts of repurposing and reuse that humans routinely perform vis-à-vis the world of objects around them.'* Therefore, the goal of 'Hack-a-Thing' was to create new, creative objects from parts of these old appliances, by enhancing them and finding new ways to operate and program them (De Weyer, Taelman, Luyten, Leen, Schepers and Dreessen, 2013).

In the first workshop (which took place on the 7th and 8th of July 2012) (local) youth (16-20 years old) from the city of Genk was targeted. All participants were invited to bring old, used and broken appliances or objects

(a vacuum cleaner, a mobile phone, a printer, etc.) that they had lying around at home to FabLab Genk. Furthermore, prior to the workshop we also collected different objects and appliances that were broken or no longer used and electronics (sensors, LED lights, switches and other Arduino-components) as starting kits for the workshop. The goal of this first workshop was to create new devices from these old ones, which had another function than originally intended. The workshop started with an introduction to the soft- and hardware that was present in FabLab Genk (i.e. Arduino, a laser cutter, a 3D-Printer, a CNC mill, etc.) and enabled the workshop participants (approximately twenty youngsters) to make objects in a short period of time. After agreeing on a plan for repurposing a specific object, the groups of participants had the remainder of the weekend to effectively work out and realize their ideas. The second workshop (which took place on the 15th and 16th of September 2012) made use of an open call for participation in order to invite expert programmers, hackers and designers. The youngsters who participated in the first workshop series were - again - invited to work together with these experts or continue their work on the objects they had created during the first workshop. The setup used for this second workshop was significantly different from the first one. Potential participants were asked to submit a project plan and list the materials they would need to work out that plan (which were then provided by FabLab Genk). Because the participants in the second workshop already knew how to use the machines and electronics present in the Fablab, there was no need for an introductory workshop or crash course. Therefore, the second workshop was more hands-on.

The 'Hack-a-Thing' workshops resulted in several interesting outcomes, such as the 'Persistence of Vision Robot', 'The Toaster JukeBox' and 'The Etch-a-Sketch Robot' (all depicted in fig 1). One group of participants used an old, broken 'Roomba' (i.e. the autonomously, automatic vacuum cleaner robot sold by 'iRobot') as a starting point for their 'Persistence of Vision Robot'. They hacked the chassis and connected the vacuum cleaner's motors to a Motor Drive Shield. This Shield, connected to an Arduino, allowed the participants to control the robot's movements. Moreover, the participants attached a row of thirteen small, LED lights to a custom, laser cut wooden plate, which - subsequently - was placed on top of the robot.

The LED lights were connected to another Arduino, which determined whether or not and how fast the LED lights flickered. When the robot was photographed and a long shutter-time was used for taking the picture, the 'Persistence of Vision Robot' was seen writing 'FabLab Genk' in light. By

KATRIEN DREESSEN, SELINA SCHEPERS, DANNY LEEN, KRIS LUYTEN, TOM DE WEYER

adjusting the speed and sequence of the blinking of the LED lights, the robot was able to write any (short) fragment of text and even draw small graphical elements (in loop). Another group worked around 'The Toaster JukeBox': an oven that makes music. Their concept included a musical instrument that automatically appears out of the oven when it is turned on. The youngsters connected an old oven and a control panel of a used household appliance to an Arduino, changing the analogue signals into digital ones. The last group of participants hacked a printer and used open hardware (Arduino and a motorshield) to work out their concept of an 'Etch-a-Sketch' drawing robot. By doing so, they created a robot that holds a pen and draws figures on the ground as it is driven across the room.

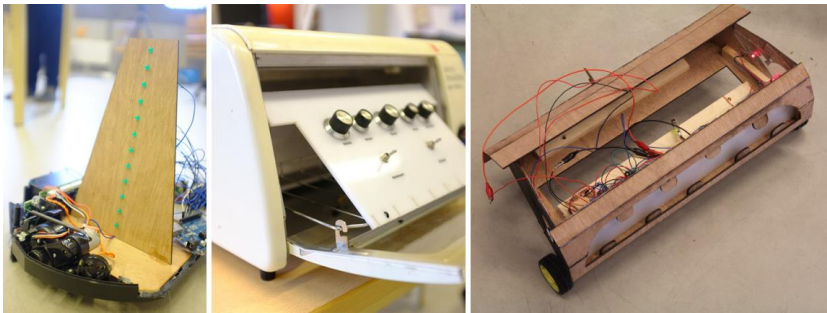


Figure 1 The 'Persistence of Vision Robot', 'The Toaster JukeBox' and 'The Etch-a-Sketch Robot'.

For setting up and organising the 'Hack-a-Thing' workshops in FabLab Genk, we were inspired by Blikstein (2013) who states that the philosophy of digital fabrication is based on several theoretical and pedagogical principles. Similarly, several principles and ideas formed the building blocks for the 'Hack-a-Thing' workshops in FabLab Genk:

(1) For exploring new and creative ways of thinking about materials, we investigated the 'Do-It-Yourself movement' and 'Repair Cafés'. However, instead of creating something out of unprocessed, (semi-)raw materials (as is the case in typical Do-It-Yourself activities) or repairing broken home appliances (as is the case in repair activities) (König, 2013), we wanted to encourage the participants to start from (components of) an existing tool, appliance or infrastructure. This appeared to require a certain degree of 'creative' thinking, particularly about alternative relationships with technological objects.

Break-it, hack-it, make-it: the 'Hack-a-Thing' workshop series as a showcase for the integration of creative thinking processes into FabLab Genk

(2) Inspired by Papert's theory of constructionism (1987), the 'Hack-a-Thing' workshops made use of a 'learning-by-doing' approach and departed from the idea that technology allows for new directions for learning. Finally, the participants in the workshop series collaborated in interdisciplinary teams.

We will now further clarify the abovementioned principles and ideas, illustrate how they took form in the 'Hack-a-Thing' workshops and show how they allowed us to include the creative thinking processes that take place before the actual problem-solving into the environment of FabLab Genk.

'Hack-a-Thing': DIY, Repair Cafés and creative ways of thinking

For the organisation and setup of the 'Hack-a-Thing' workshop series, we explored the 'Do-It-Yourself movement' and 'Repair Cafés' in order to enable new and creative ways of thinking. To illustrate this, we point out that it is widely acknowledged that people are driven to customize, modify and build things. According to Kuznetsov and Paulos (2010), the DIY movement *'predates recorded history as human survival itself often relied on the ability to repair and repurpose tools and materials. For hundreds of years, people have been fixing water leaks, remodelling their homes and decorating their clothes without hiring professional plumbers, architects or designers'* (2010, p. 295). In this sense, we define DIY as involving *'an array of creative activities in which people use, repurpose and modify existing materials to produce something'* (Buechley, Rosner, Paulos and Williams, 2009, p. 4823). Recently, through easy accessibility and affordability of tools and new sharing mechanisms facilitated by the emergence of - among other things - social computing and online sharing tools, the DIY movement has regained interest and wider adoption (Buechley, Rosner, Paulos and Williams, 2009). As a part of this DIY tradition, the origin of the Repair Café (<http://repaircafe.org/>) movement lies in the Netherlands, where Martine Postma - as a reaction to Europe's contemporary throw-away culture - organized a social event in 2012 during which people could come by with defunct or broken items and have them fixed by experts for free (Sharpe, 2012; König, 2013). According to Sharpe (2012), a part of the mission of Repair Cafés *'is teaching repair skills, which are lost quickly, so people who bring in broken items are asked to be active participants in their repair'*.

However, we felt that there is still a gap between the typical FabLab activities and the Do-It-Yourself activities. Namely, a FabLab starts from (mostly) unprocessed materials and not an existing tool, appliance or infrastructure. The ‘Hack-a-Thing’ workshops presented an opportunity to reflect on this. Therefore, instead of creating something out of unprocessed, (semi-)raw materials or repairing broken home appliances (König, 2013), we explicitly encouraged the participants to start from (components of) an existing tool, appliance or infrastructure (figure 2). This means that, although they all share the same starting point, the ‘Hack-a-Thing’ workshops differ from the traditional DIY and Repair Café movements in goal and realization.

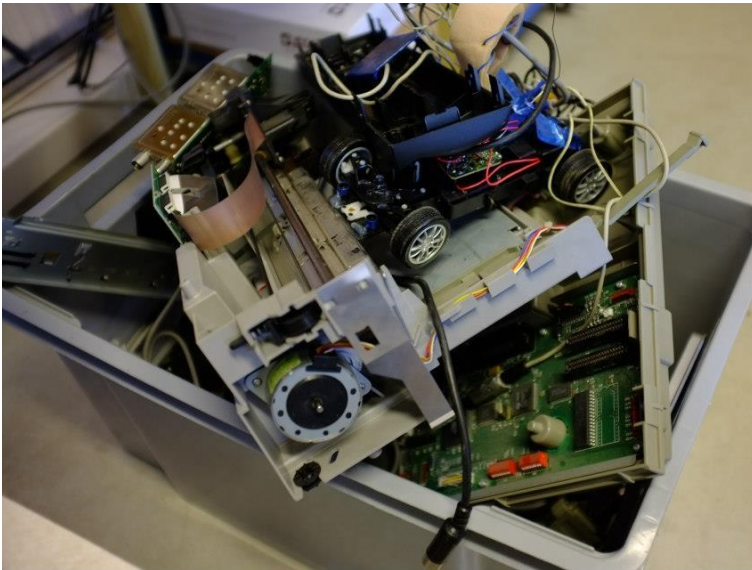


Figure 2 The ‘Hack-a-Thing’ workshop series departed from (components of) existing tools, appliances and infrastructure.

For instance, in contrast to the Repair Café, the ‘Hack-a-Thing’ workshops suggest alternative relationships with technological objects. Normally, technologies are designed to function and we want them to. But this also locks ‘objects into a world of necessary dependencies that limits the kinds of relations we may imagine with them’ (Jackson and Kang, 2014, p. 9).

With the ‘Hack-a-Thing’ workshops, we explicitly not limited ourselves to repairing objects to their predefined lives. Instead, the ‘Hack-a-Thing’ workshops wanted to stimulate processes of creative breakdown and reuse

Break-it, hack-it, make-it: the 'Hack-a-Thing' workshop series as a showcase for the integration of creative thinking processes into FabLab Genk

that can unleash the other lives of technologies: i.e. the lives that go further than the ones they were designed for (Jackson and Kang, 2014). This means that starting with an existing item that fulfils a certain purpose often makes it even harder to imagine how it can be transformed to serve another purpose. As Jackson and Kang (2014, p. 6) state, such repurposing processes *'require forms of imagination and creativeness'* that reflect each participant's ideas of aesthetic and visions. Therefore, in contrast to traditional Do-It-Yourself activities and Repair Cafés, 'Hack-a-Thing' required an even higher degree of 'creative' thinking to come up with other uses than the objects original purpose.

'Hack-a-Thing': constructionism, interdisciplinarity and new ways of learning in a FabLab

In order to foster a creative thinking process, FabLab Genk found the principle of constructionism to be especially relevant for organising the 'Hack-a-Thing' workshop series. Constructionism - particularly attributed to Papert (1987) - is a learning theory that centralizes the construction of mental models by learners in order to understand the world around them. Inspired by this theory, the 'Hack-a-Thing' workshops made use of a 'learning-by-doing' approach and departed from the idea that technology allows for new directions for learning. Finally, the participants in the workshop series collaborated in interdisciplinary teams. We explain these three aspects and illustrate how they resulted in a new, informal and creative form of learning in the environment of FabLab Genk.

First, a 'learning-by-doing' (or 'learning-by-making') approach is a central notion in constructionism. As Papert states: 'one of my central mathetic tenets is that the construction that takes place 'in the head' often happens especially felicitously when it is supported by construction of a more public son 'in the world'. (...) Part of what I mean by 'in the world' is that the product can be shown, discussed, examined, probed, and admired' (Papert, 1993, p. 142). According to Blikstein (2013), Papert's constructionism dictates that the construction of knowledge happens remarkably well when students build and make things. Papert (1999) claims, 'we all learn better when learning is part of doing something we find really interesting. We learn best of all when we use what we learn to make something we really want'. Inspired by this notion, the 'Hack-a-Thing' workshops stimulated a learning-by-doing approach. Although the making processes of the

participants was preceded by an introduction in the soft- and hardware in the FabLab and a brainstorm for agreeing on a common project plan, we noticed that the participants learned more by actually using the soft- and hardware and by effectively working out their plans. Naturally, this involved an amount of trial-and-error during which the participants resorted to the workshop moderators (who - among other things - offered them technical support and advised them on (the feasibility of) their plans) or the Internet in order to solve problems on the spot. From feedback by the participants, we noticed that the participants found this 'search' to be particularly interesting.

Second, a pioneer in the use of digital technologies in education, Papert (1999) departs from the idea that technology allows for new directions for learning: *'if you can use technology to make things you can make a lot more interesting things. And you can learn a lot more by making them'* (Papert, 1999). According to Papert, technology enables students to design, engineer, and construct and caters to many forms of working, expressing, and building (Blikstein, 2013). As constructionism particularly applies to learning with digital technology (Stager, 2012), we set up the 'Hack-a-Thing' workshop series in such a way that technology was indispensable during the creative processes of the participants. The original purpose of Fab Labs is often considered to be an accessible infrastructure for digital fabrication. Fab Labs often drive innovations because they provide people with accessible tools and machines to experiment with and create new things. Therefore, as mentioned above, the workshops started with an introduction to the soft- and hardware that was present in FabLab Genk, which enabled the workshop participants to make objects in a short period of time. This led to new, innovative and unexpected outcomes (as described above, figure 1). Also, getting to know the technology in the FabLab resulted in participants having a better idea of the potential of a FabLab.

Finally, we organised the 'Hack-a-Thing' workshops in such a way that the twenty participating youngsters were divided into four groups, each containing a mix of participants from diverse disciplines and with different backgrounds (e.g. a designer, a programmer, a technician and an artist), in order to brainstorm on repurposing their objects (figure 3). Every group was moderated by an expert in programming, designing objects, fabrication techniques, etc., who guided the participants in their brainstorm sessions and advised them on (the feasibility of) their plans. As Lattuca, Voight and Fath (2004) show, interdisciplinary activities are more engaging than disciplinary ones because they capture intellectual interest and help to

Break-it, hack-it, make-it: the 'Hack-a-Thing' workshop series as a showcase for the integration of creative thinking processes into FabLab Genk

connect information from different disciplines. According to Newell (1994), interdisciplinarity even increases creative or original thinking. From feedback by the participants, we noticed that the participants learned a lot from their fellow-group members. We found that the creation of an interactive object adds a significant degree of complexity and lead to intense collaborations between participants. Since most of the participants' projects targeted the creation of an interactive system, participants were required that had basic knowledge of electronics and programming. The creation of these interactive objects added a significant degree of complexity and led to intense collaborations between participants. We observed that, in such an interdisciplinary setup, the participants learned about other viewpoints on the same problem from their fellow-group members that came from different backgrounds.



Figure 3 The participants of the 'Hack-a-Thing' workshop series worked together in an interdisciplinary way.

Discussion

From the 'Hack-a-Thing' workshops we learned that the environment of a FabLab could be very beneficial to stimulate learning-by-doing (or

KATRIEN DREESSEN, SELINA SCHEPERS, DANNY LEEN, KRIS LUYTEN, TOM DE WEYER

learning-by-making) approaches. Since Papert's constructionism (1987) starts from the idea that the construction of knowledge occurs when participants build and make things, we deliberately chose to setup the workshops in this FabLab setting. In this way, the participants had easy access to the different available machines and technologies from the start.

This easy access resulted in the early use of technology by the participants: even during the brainstorm session some groups already made use of the FabLab infrastructure to visualise or materialise their concepts. Since we noticed that access alone is insufficient, incorporating the workshops into a FabLab environment provided the participants with enough time, space and assistance to use and experiment with the technologies. In this way, the participants were able to develop additional skills (e.g. in programming or in using electronics) and go through processes of trial-and-error. We believe that including experimentation and trial-and-error in these types of workshops (thus incorporating them in a FabLab setting) could result in more elaborate, reworked and tested prototypes (in respect to the degree of materialisation or finishing). However, more research needs to be conducted to test this claim. Additionally, by including the artistic and creative thinking processes into the environment of a FabLab, we go a step further than the problem-solving approach that FabLabs are mostly known for (Gershenfeld, 2005).

Conclusion

In this paper, we discussed the 'Hack-a-Thing' workshop series as a tool for informal learning and creative thinking. The workshop series focused on using various skills to repurpose broken things, giving them a new meaning and even a new identity. This transformation, where participants recycled the material and basic components of a broken thing into something new, turned out to be a very engaging activity. As one of the participants remarked: *'creating new objects, is more than just a hobby for us. As a student, you do not have a lot of money. We need to work with parts from discarded appliances. But that only makes it more fun'* (Nelis, 2012). As mentioned above, this contrasts to the traditional Do-It-Yourself movement and Repair Cafés, which all focus on creating repairing existing things or create new things from raw materials. In contrast, the 'Hack-a-Thing' workshop series did not start from the idea that things need to be repaired or created, rather that many things can be repurposed. This required us to create a specific setting that enabled people to leap forward and come up with unusual new ways to use and repurpose broken things. We believe the

Break-it, hack-it, make-it: the 'Hack-a-Thing' workshop series as a showcase for the integration of creative thinking processes into FabLab Genk

combination of a FabLab environment and people from various backgrounds and disciplines collaborating hands-on within this environment are the key factors that have led to a successful workshop series. We found that participants learned to think beyond the traditional making activities and elaborated more on idea and implementation before exploring various alternatives. We noticed that this resulted in creative thinking processes taking place within FabLab Genk itself, that did not take place there before. The side effect appeared to be people becoming more aware of the consequences of their maker activities and consciously strived for a more sustainable approach.

Acknowledgement

The project 'Fablabs in the border region' (2011-2014) is funded by the European Interreg IV program for the border region Flanders/the Netherlands). FabLab Genk is a collaboration between the Media, Arts and Design faculty and the University of Hasselt. We would like to thank our colleague Johannes Taelman for collaborating in organising, executing and analysing the 'Hack-a-Thing' workshops.

References

- Blikstein, P. (2013) *Digital Fabrication and 'Making' in Education: The Democratization of Invention*. In Walter-Herrmann, J. and Büching, C. (eds.), *FabLabs: Of Machines, Makers and Inventors*. Bielefeld: Transcript Publishers
- Bauwens, M. (2007) *The GNU Project and Free Software*. [Version 1.11.07]. Amsterdam: P2P Foundation. Available from: [http://p2pfoundation.net/1.1_The_GNU_Project_and_Free_Software_\(N utshell\)](http://p2pfoundation.net/1.1_The_GNU_Project_and_Free_Software_(N_utshell)) [Accessed: 3th May 2014].
- Buechley, L., Rosner, D., Paulos, E. and Williams, A. (2009) *DIY for CHI: Methods, Communities, and Values of Reuse and Customization*. Paper Presented at The NordiCHI '09 Extended Abstracts on Human Factors in Computing Systems.
- DeWalt, K.M. and DeWalt, B.R. (2010) *Participant observation: A guide for fieldworkers*. Plymouth: Altamira Press.
- De Weyer, T., Taelman, J., Luyten, K. Leen, D., Schepers, S. and Dreessen, K. (2013) *Hack-a-thing: A Series of FabLab Genk Workshops for Reusing and Repurposing Depreciated Objects*. Paper Presented at The First European Fab Lab Conference FabLabCon 2013, Aachen, Germany.

- KATRIEN DREESSEN, SELINA SCHEPERS, DANNY LEEN, KRIS LUYTEN, TOM DE WEYER
- Geertz, C. (1973) *The Interpretation of Cultures*. New York: Basic Books.
- Gershenfeld, N. (2005) *FAB. The Coming Revolution on Your Desktop. From Personal Computers to Personal Fabrication*. New York: Basic Book.
- Jackson, S. and Kang, L. (2014) *Breakdown, obsolescence and reuse: HCI and the art of repair*. Paper Presented at the CHI '14 Proceedings of the SIGCHI Conference on Human Factors in Computing System.
- König, A. (2013) A Stitch in Time: Changing Cultural Constructions of Craft and Mending. Culture Unbound. *Journal of Current Cultural Research*, 5 (33), 569-585.
- Kuznetsov, S. and Paulos, E. (2010) Rise of the expert amateur: DIY projects, communities, and cultures. Paper Presented at The NordiCHI '09 Extended Abstracts on Human Factors in Computing Systems.
- Lattuca, L., Voight, L. and Fath, K. (2004) Interdisciplinarity Promote Learning? Theoretical Support and Researchable Questions. *The Review of Higher Education*, 28 (1), 23-48.
- Mandavilli, A. (2006) Appropriate technology: Make anything, anywhere. *Nature* 442 (7105), 862-864.
- Mikhak, B., Lyon, C., Gorton, T., Gershenfeld, N., McEnnis, C., and Taylor, J. (2002) *Fab Lab: an alternate model of ICT for development*. Paper presented at the International Conference on Development by Design, Bangalore, India.
- Milanese, F. (2006) FABLab allows you to create the gadget of your dreams. *Science in Africa*. [online] *Africa's First On-Line Science Magazine*. Available from: <http://www.scienceinafrica.co.za/2006/august/fablab.htm> [Accessed: 10th May 2014].
- Nelis, C. (2012) Kringwinkels afschuimen. Het Belang van Limburg.
- Newell, W. H. (1994) *Designing interdisciplinary courses*. In Klein, J.T. and Doty, W.G. (eds.), *Interdisciplinary studies today. New Directions for Teaching and Learning*. San Francisco: Jossey-Bass.
- Open Source Initiative (2010) *The Open Source Definition*. Available from: <http://www.opensource.org/> [Accessed: 31st April 2014].
- Obrenović, Z. (2011) Design-Based Research: What We Learn When We Engage in Design of Interactive Systems. *Interactions*, 18 (5), 56-59.
- Papert, S. (1987) Computer Criticism vs. Technocentric Thinking. *Educational Researcher*, 16(1), 22-30.
- Papert, S. (1993) *The Children's Machine: Rethinking School in the Age of the Computer*. New York: Basic Books.

Break-it, hack-it, make-it: the 'Hack-a-Thing' workshop series as a showcase for the integration of creative thinking processes into FabLab Genk

- Papert, S. (1999) *The Eight Big Ideas Behind the Constructionist Learning Laboratory*. In Stager, G. (eds.) *An Investigation of Constructionism in the Maine Youth Center*. Doctoral dissertation. The University of Melbourne.
- Seravalli, A. (2011) *Democratizing production: challenges in co-designing enabling platform for social innovation*. Paper Presented at the The Tao of Sustainability Conference, Beijing, China.
- Sharpe, K. (2012) Sip Lattés and Fix Busted Stuff at the Repair Café. *Wired Magazine*. Available from: <http://www.wired.com/2012/05/fixer-collectives/> [Accessed: 9th May 2014].
- Tribe, M. and Jana, R. (2006) *New Media Art*. Cologne: Taschen.



SECTION III

Digital Media and Knowledge Society



Designing Identities on the Digital Mirrors of Facebook: The Reflection & the Real

Zeynep ARDA *

Izmir University of Economics

The purpose of this paper is to identify and analyze how human identities are constructed/designed and communicated on the social networking sites. Trying to develop an understanding of how much significance we attribute to Facebook profiles in terms of reflecting one's identity, this paper aims to trace whether these edited/manipulated versions of the self indicate only a commercial superficiality, or whether this approach could be used as a way of putting contemporary human needs and desires in a design perspective. This paper is based on the partial findings of The Digital Life Scale (2011), a survey developed, executed and evaluated by the author (available from: <http://digitallife.uji.es>), especially on one of its three main scales: The Self-Presentation 2.0 Scale (SPS), consisting of twenty-two items about how the self is presented on Facebook. An overall evaluation of the findings confirmed various points about contemporary online communication. For example, displaying our actual identities on social networking sites triggers a higher tendency to present aspects of our actual identities. Similarly, once we reveal our name and face on social networking sites, our story follows shortly after and we start to broadcast our lives to our narrow audiences. The general tendency is to disclose various bits of personal information, though the communication that takes place seems to be quite superficial.

Keywords: *Designed identity; online identity; social networking sites; Facebook; digital communication.*

Introduction

Persona is an Italian word that derives from the Latin for a kind of *mask* made to resonate with the voice of the actor – *per sonare* meaning ‘to sound through’. In the study of communication, *persona* is a term given to describe the versions of self that all individuals possess. Behaviors are

* Corresponding author: **Zeynep Arda** | e-mail: zeynep.arda@ieu.edu.tr

selected according to the desired impression an individual wishes to create when interacting with other people. Therefore, personae presented to other people vary according to the social environment that the person is engaged in. The persona presented before others will probably differ from the persona an individual will present when s/he happens to be alone or with the family (Goffman, 1959). As defined in parallel in psychology by Carl Jung, the persona is the social face the individual presents to the world – ‘a kind of mask, designed on the one hand to make a definite impression upon others, and on the other to conceal the true nature of the individual’ (Jung, 1953, p. 190).

When we consider the construction/perception of identity, our definition is based on three concepts: **Identity**, which is considered to be the *true* self, **self-image**, the mental image we have of our own self and **image**, the mental image that our self-presentation has created on others as a representation of the self. Our image, as it is formed through the gaze of the *Other*, is reflected onto our self-image either negatively or positively, in the form of an approval or a criticism. Yet, selves are social constructs that are reflexively shaped and re-shaped in this gaze, as well as through our own gaze onto ourselves as the *other*. These three agents have bi-directional interactions with one another through the socialization of the individual.

Various theories indicate that the self is considered *meaningful* only in the context of one’s relationship to others and one’s position in social groups (Brewer&Hewstone, 2004, p. 6). Within his concept of the *performing self*, Goffman would put it as, ‘although the object of the self-narrative is a single self, it would be a mistake to view such constructions as the product or possession of single selves in understanding the relationship amongst events in one’s life, one relies on discourse that is born of social interchange and inherently implies an audience’ (Goffman qtd. in Rose, 1998, p. 37).

The concept of an audience is curious regarding the influence of contemporary online social life on identity construction, as the online self-presentation (social introduction in a controlled way) as well as the online representation (the mental image, idea or concept created as a result of such presentation) of the individual in the digital socialization processes strike back to effect the *actual* self. Though the self is always-already a reflexive construct, the edited/editable nature of self-presentation on this medium elaborates the tendency of our self-images to reflect on the feedback of the online audiences that our digital identity/images generate.

our self-images to reflect on the feedback of the online *audiences* that our digital identity/images generate.

As social networking sites start to have a firm and undeniable presence in our lives, seeing ourselves in the digital reflections of our online profiles becomes part of our daily routine and starts to be significant in today's definition of interpersonal communication. In constructing our social relationships, social networking sites like Facebook, come to mean 'almost more than what face-to-face communication means to us: short, casual, no-compromise communication at the touch of our fingertips' (Arda, 2011, p. 5).

The highly introverted nature of our online communication raises the question of whether our online *friends* do serve as the audience from whom to receive feedback for the self-project – and, if possible, to receive approval, admiration and applause. Thus the self-conscious individual of our contemporaneity is excessively conscious of her/his appearance or manner, as it is constantly reflected in the digital mirrors of online social networks. The feedback that arrives in the form of a constant digital flow of *likes*, *retweets*, *fans* and *followers*, causes the illusion of an audience out there listening to everything that we shout out into the abyss.

Throughout this research, intending to fulfil the complex, multi-disciplinary task of analyzing online communication today, a methodology that includes several distinct instruments –literature review, online surveys and statistical evaluation of the results– was used trying to define the theoretical background of the issue as well as to provide empirical data on the current situation.

The *Digital Life Scale (DLS)* was the survey carried out by the author to capture field data relevant for identifying some highlights about the contemporary construction of identity as outlined above. The survey was realized online during January-March 2011 and the participants were invited randomly to take the survey using the social online networks and online multi-player games where applicable. A total of **946** users participated in the DLS, nevertheless, for the reliability of the results, incomplete responses were eliminated. Hence, the sample of the present study consisted of **635** internet users (385 female, 250 male) from 33 different countries.

The DLS consisted of three sections:

1. The first section was the Rosenberg Self-Esteem Scale (1965), an instrument consisting of 10 items that was employed to measure the global self-esteem of the participants, with the objective of identifying the effect of low self-esteem or high narcissistic regard on self-presentation online.

2. The second section was the Narcissistic Personality Inventory-16 (**NPI-16**), originally developed by Raskin and Terry (1988) as a forty-item forced choice inventory that is very commonly employed in social psychological research. NPI-16 was thought of as a necessary component of the DLS, as narcissism is a very pervasive subject in our contemporaneity and there is possibility that it could be identified as a partial responsible for feelings of emptiness, difficulty with interpersonal functioning or inability to see any perspective other than our own, tendencies that seem to prevail in our societies today.

3. The third section was called the *Self-Presentation 2.0 Scale (SPS)* and it consisted of a selection of items on the online behavior of the individuals, on the social networking sites or multi-player games. With a particular focus on the level of involvement in these mediums mentioned, it included questions on self-image, interpersonal communication and self-expression.

This paper is based on the partial findings of the DLS. With the aim of understanding the online behavior of social networking site users, various factors were identified from the survey items. The factors investigated in this paper under the concept of self-presentation online are: *Lifecasting, Negative Attitude, Proximity of Online/Offline Identities, Time Dedicated and Superficiality*. Items that have defined these factors are given in Table 1, while their significances are evaluated in the following sections. These factor loadings identified through the Rotated Component Matrix were compared to key variables such as age, gender, using real name, comparison, narcissistic behavior and self-esteem; and significant correlations were noted.

Mirrors of Identity

'Sometimes, however, I admit that I have thought we might be better off without mirrors, especially when I read that hundreds of thousands of people a year pay for botox injections to smooth their facial wrinkles with a paralytic poison, or when I consider other such attempts to manipulate image and deny mortality.' (Anderson, 2007, p. 11)

An old Eastern tradition tells us that when designing one's home, one should try to minimize the contact with mirrors, trying to avoid the mirrors catching our reflection by covering them with a piece of thick velvet or hanging them on the wall with their backs facing out if possible. This

tradition is based on the common knowledge that it is not healthy for a human being to spend too much time staring at her/his own reflection (Shafak, 2010).

Prominent scholars defend that our identities are results of reflexive processes and that one of the key characteristics of late modernity is its requirement for individuals to define and refine their identities reflexively (Roszak, 1979; Giddens, 1991; Bauman, 2000; Oyserman, 2003). Be it within our momentary awareness or not, we constantly carry out self-projects such as 'discovering oneself, knowing oneself, improving oneself, creating oneself anew, expressing oneself, taking care of oneself, being happy with oneself or being ashamed of oneself' (Oyserman, 2003, p. 11). The process of identity construction begins with the awareness of one's own body and is augmented by the sense of being able to make choices and initiate action. In everyday speech, the familiar expressions "finding oneself" or "knowing oneself" refer to some difficult act regarding complex, abstract knowledge (Baumeister, 1997); while the term self-concept refers to the totality of inferences that a person has made about himself or herself, as well as an understanding of one's social roles and relationships.

In the consumer society of today, the process of identity construction becomes an even more complicated task, as there is a layer of complicated symbolic culture which, drawing from Simmel's 'tragedy of culture', is creating a growing gap between people and what they produce (2004). Identity becomes not a construct of what a person produces, or the cultural objects that people are able to use for their self-development, but instead, a construct of what a person *consumes*.

Miller tells us that the processes of consumption, especially for the female consumers, are connected to the real and ideal social relationships that make up the shopper's world. 'Shopping is an active praxis which intervenes and constitutes as well as referring back to relationships' says Miller, and thus, it can 'reveal contradictions between self-image and the idealization or denigration of self by others' (1998, p. 147). The irony here is that the primary 'purpose behind shopping is not so much to buy the things that people want, but to strive to be in a relationship with subjects that want these things' (Miller, 1998, p. 148). And as such, what we consume, not only in terms of clothing or food but also entertainment, travel or property, become objects of display of an image we strive to project, it skips the stage of being part of 'who we are' and goes straight to 'who we want others to see us to be'. Facebook, not only encourages mass communication

of such a process, but also elevates it to a higher level of appearance dominating the identity.

The commodification of human and the 'extremely visual' character of human identity in our contemporaneity are some of the basic responsables behind the obsession with the body, considering the money and effort dedicated to staying fit, to the consumption of anti-aging products and the scary plastic surgeries that we succumb ourselves in (Noonan and Adler, 2002). Behind the image obsession and the unlimited desire to be *better*, lies constant upward social comparison which is an undeniable part of our contemporary society.

This competitive drive of the human being does not stem from the survival instinct as much as it does from the capitalist interest. We have to be competitive and competent to get the best jobs, sign up the best clients, hang out with the coolest people, earn a higher salary, buy the biggest house and the ultimate car as well as to find love or to be in a satisfying relationship with the most attractive partner possible – and today we have Facebook to show all that to whom it may concern. This capitalist fantasy, today, works with a formula that had proven successful earlier with the brands (Klein, 2000). It becomes a *fait accompli*, to construct a brand identity that our target audience could identify with and build up a relationship on this imaginary identity. Thus and so, the online social network and the constant feedback that it offers us become significant in our social identity construction and reputation management processes.

Social Networking Sites and the Construction of Online Identity/Image

When one talks about reflections, one should always keep in mind the characteristics of the reverberating medium. Narcissus saw his reflection on the surface of the water. The surface that gave him his self-image was not as smooth as that of a mirror and Narcissus had to adjust and interpret his perception to be able to claim the image as his own. As he lacked the experience to do so, he never knew that it was his reflection. In terms of image and identity, social networking sites also have their own peculiarities and the reflection can only be judged after one thoroughly understands the characteristics of the medium. The online social network is a mirror that digitally processes one's identity and where one carefully edits her/his images up to the point that it becomes perfectly presentable –which is not

necessarily the exact reflection of the actual or the real, while it neither is imaginary nor symbolic.

As design becomes a distinguishing property in capitalist consumption and the competition amongst various lines of products, it does so also amongst people. The extreme visibility, or the *obscenity* of human beings in Baudrillardian terms, in today's world, triggers a bigger obsession with the image, and a tendency to care about appearances and images, more than they would care about their actual identities. This point is expressed concisely by Hal Foster as 'the package [becoming] almost as important as the product' in *Design and Crime*:

'For today you don't have to be filthy rich to be projected not only as designer but as designed – whether the product in question is your home or your business, your sagging face (designer surgery) or your lagging personality (designer drugs), your historical memory (designer museums) or your DNA future (designer children). Might this 'designed subject' be the unintended offspring of the 'constructed subject' so vaunted in postmodern culture?' (Foster, 2002, p. 17).

The package signifying more than the product, the image taking over the actual product sounds too familiar indeed. Revisiting *No Logo*, Naomi Klein's handbook on the contemporary power of brands we read: 'I decided to write *No Logo* when I realized these seemingly disparate trends were connected by a single idea ... that successful corporations must **primarily produce brands, as opposed to products**' (2000: xvii, 3, *emphasis added*).

In a manner of creating a brand identity, what emerges with Twitter and Facebook users is a clear tendency to use social media instrumentally for self-conscious commodification. In other words, we create our online identities for the purpose of being consumed by others (Blackman and Choquelle, 2011, p. 14). As Sherry Turkle notes, this online identity dwells at the border of our fantasies: 'In games where we expect to play an avatar, we end up being ourselves in the most revealing ways; on social-networking sites such as Facebook, we think we will be presenting ourselves, but our profile ends up as somebody else –often the fantasy of who we want to be' (Turkle, 2011, p. 153).

On Facebook, people are invited to manage their identities, strategically providing a polished example of their idealized selves, almost as an artistic representation. The pictures of social celebrations, holidays, weddings, and children, convey how people imagine themselves and how they would like to be imagined. Like a narcissist attempting to achieve the 'unity' of her/himself that has long been considered fragmented, and in

remembrance of the joyous, but at the same time deceptive and impossible narcissistic moment of the perfect baby, one tries to build the perfect image in a world where it is attainable: on the online social network.



Figure 1 Marilyn Diptych 2.0, Andy Warhol's famous painting digitalized and modified by Zeynep Arda. 'My Facebook is not me' (2010).

Such is the tendency to create our ideal images on social networking sites and communicating from behind our edited identities/masks – though

we seem to be metaphorically stuck between our ideal ego and super ego in the light of these online personae that we create. Even though the general tendency of Facebook users is to communicate using their real names and hence creating the bond between their Facebook profile and their actual lives, we have also seen that this online identity is created and edited almost to the point of *fiction*. **89.4%** of 528 participants of the *Digital Life Scale* have indicated using their real name on their Facebook profiles, nevertheless, only **41.5%** confirmed (agreed or strongly agreed with) the statement 'My Facebook profile is an accurate reflection of who I am'. Therefore, using factor analysis, several variables were formulated to find out which correlations exist between the communication attributes defined by Facebook and various aspects of the self, narcissism and psychological well-being, as will be explained in detail in the next section.

The Self-Presentation 2.0 Scale

Self-Presentation 2.0 Scale (SPS) consisted of twenty-two items that intended to analyze the online behavior of the participants. The scale was factor analyzed and interpretable factors were determined within the framework defined in the previous section. Controlled for internal consistency, it was found to be reliable (Cronbach's $\alpha = .818$). The responses to the SPS items were subjected to factor analysis using principal components analysis (PCA) with varimax rotation. The preliminary examination of initial eigenvalues, percentages of explained variance, and the scree plot suggested a five-factor solution. These five factors explained **58.6%** of the total variance and the item loadings ranged from **.409** to **.836**. Six items loaded on Factor 1, four items on Factor 2, three items each on Factor 3 and 4 and five items on Factor 5. Besides being relevant to the research objectives, these five factors were found to be internally consistent and reliable, and hence were considered as factors to be used for further analysis. The factor loadings of these variables are given in **Table 1** below.

Lifecasting

The outstanding factors coincided with some of the attributes of Facebook communication that distinguish it from other mediums of daily communication, and earlier forms of online communication. Items such as 'I try to inform my friends as much as possible about what's up in my life through my status updates, my albums & my videos'; 'I'm on Facebook therefore I am' or 'I'd lose contact with my friends if I'm not on Facebook'

loaded on Factor 1 and this factor was called *Lifecasting*. Lifecasting on Facebook factor had an eigenvalue of **5.403** and it explained **27.1%** of the total variance. It was found to be internally consistent with an alpha reliability of **.766**.

As stated before, the nanonymous nature of Facebook communication did not necessarily indicate that the actual self was being communicated, the range within which the actual self is expressed and/or made public is one of the outstanding alterations caused by our submission to the presence of Facebook in our lives. Similarly a concept which was unknown in our pre-Facebook era, 'lifecasting', a short form of life-broadcasting is considered significant both in terms of self-expression and in terms of personal information exposed to actual friends and family, as well as acquaintances and sometimes complete strangers. This type of information published and eternalized on Facebook profiles was not available in any other form previously, except momentarily for our very close circles.

Negative Attitude

Items like 'Facebook is nothing more than rumors, problems and a lot of gossip' and 'Facebook has devalued the concept of 'friendship'' loaded on Factor 2 and this factor was named as *Negative Attitude*. The Negative Attitude factor had an eigenvalue of **2.302**; it explained **11.5%** of the total variance, its internal consistency was controlled with Cronbach's alpha and found to be reliable with $\alpha = 719$.

Despite its popularity, Facebook is not a rose without thorns. Several of the participants of the survey have indicated negative attitudes towards the use of the medium. With this subscale, the research objective was to compare how the anti-Facebook attitude correlates with the other factors.

Proximity of Online/Offline Identities

Some of the items that loaded on Factor 3 were 'My digital identity is a reflection of who I am'; 'Facebook reflects my social life as it is' and 'My Facebook profile is an accurate reflection of who I am'. Hence this factor was called *Proximity of Online/Offline Identities*. The Proximity factor had an eigenvalue of **1.635**; it explained **8.2%** of the total variance and its Cronbach's α was calculated to be **.732**.

The Facebook section of the *Digital Life Scale* included items and reverse items ranging from 'On my Facebook account I use my real name so that my friends can easily find me' to 'Facebook reflects my social life as it is' to determine how close this online presentation is to real life identity. The

presence of friends and family in Facebook communication, adds a specific level of accuracy and a certain control mechanism to the information communicated. Items like ‘My Facebook profile is an accurate reflection of who I am’ were designed in such a context, as the possibility of receiving positive or negative feedback from immediate family or very close friends would limit one from publishing *imaginary* information or from ‘making things up’.

Table 1 Self-Presentation 2.0 Factor Loadings (Rotated Component Matrix).

Factors and Items	F1	F2	F3	F4	F5
Factor 1 - «Lifecasting»					
α = .766					
(fcb06) I try to inform my friends as much as possible about what's up in my life through my status updates, my albums & my videos.	.581	-.047	.314	.301	.019
(fcb17) I give my friends as much feedback as possible concerning what they share on their Facebook pages.	.542	-.002	.379	.125	.132
(fcb24) Facebook gives me the opportunity to really express myself.	.645	-.158	.278	-.026	-.018
(fcb25) I'm on Facebook therefore I am.	.719	-.080	-.076	.028	.104
(fcb26) I'd lose contact with my friends if I'm not on Facebook.	.632	-.047	-.079	.080	.263
(fcb09) Facebook reflects my social life as it is.	.525	-.017	.536	.177	.039
Factor 2 - «Negative Attitude»					
α = .719					
(fcb11) (R) Facebook is nothing more than rumours, problems and a lot of gossip.*	-.186	.717	-.104	-.077	-.124
(fcb19) (R) Facebook has devalued the concept of «friendship».*	-.145	.735	.109	-.023	.001
(fcb21) (R) Facebook is nothing but exhibitionism and voyeurism.*	-.005	.774	-.212	-.103	-.078
(fcb31) Facebook makes us all more narcissistic.	.122	.643	-.144	.007	.167
Factor 3 - «Proximity of Online/Offline Identities»					
α = .732					
(yslo01) My digital identity is a reflection of who I am.	.001	-.160	.753	.185	.133
(fcb09) Facebook reflects my social life as it is.	.525	-.017	.536	.177	.039
(fcb16) My Facebook profile is an accurate reflection of who I am.	.201	-.124	.817	.085	.043
Factor 4 - «Time Dedicated»					
α = .748					
(yslo02) While I'm working with a computer, I sneak off once in a while to check out my Facebook / Twitter / WOW etc. account.	.016	-.132	.209	.650	.349
(yslo03) I login to my online social network accounts ... times every day.	.127	-.077	.041	.836	.042
(fcb01) I spend ... hour(s) every day on my Facebook account.	.137	.004	.162	.827	.024
Factor 5 - «Superficiality»					
α = .702					
(fcb10) I like knowing more about the actual lives of my friends through Facebook.	.330	-.268	.325	.232	.533
(fcb12) Checking out photos of people that I don't know very well on Facebook, makes me get to know them better.	.183	-.116	.221	-.048	.736
(fcb28) (R) I find myself checking out photos of people that I don't know on Facebook and I can't stop myself. It is a total waste of my time.*	.060	.233	-.180	.237	.683
(fcb30) Facebook changes the way that I relate to myself.	.518	.234	.049	.020	.409
(fcb32) I love receiving feedback from my friends for the things I post in my profile.	.418	-.134	.263	.216	.419
α = .776 Total Explained Variance = 58.6%					

Time Dedicated

Items such as 'I login to my online social network accounts ... times every day' or 'While I'm working with a computer, I sneak off once in a while to check out my Facebook / Twitter / WOW etc. account' loaded on Factor 4 and this factor was called *Time Dedicated*. This factor had an eigenvalue of **1.332** and it explained **6.7%** of the total variance, while its alpha value was **.748**.

The time dedicated to checking out, updating our profile, commenting on Facebook profiles of others, looking for and adding new friends is the time what we usually call as 'dedicated to *socializing*', though we are alone with a computer screen all along. Items concerning how we *make* time for Facebook activities during our busy day such as 'While I'm working with a computer, I sneak off once in a while to check out my Facebook / Twitter / WOW etc. account' or 'I login to my online social network accounts ... times every day' were placed in the common sections of the DLS, as well as in the more specific item 'I spend [a number of] hour(s) every day on my Facebook account' in the Facebook section of the survey. This factor together with Lifecasting, would give us a perspective on how high we value Facebook interactions.

Superficiality

A very important factor for this research, *Superficiality*, came up as the fifth one. Items like 'Checking out photos of people that I don't know very well on Facebook, makes me get to know them better' or 'I find myself checking out photos of people that I don't know on Facebook and I can't stop myself. It is a total waste of my time' loaded on this factor. Factor 5 had an eigenvalue of **1.052** and it explained **5.3%** of the total variance. Its internally consistency was found to be high, with $\alpha = 702$.

When we talk about 'image becoming identity', we actually refer to a shallowness of one's presence in her/his social relationships. As one's online profile becomes a social product of feedback mechanisms, gradually *less* of the person is there to communicate and to *be*. Superficial communication renders it easier to 'maintain face' and be in control of the situations, nevertheless 'fulfilling human interaction' tends to lie also in the vulnerability exposed to the other.

Conclusion

The definition of a successful social life could be very relative, however, psychological research tells us that an individual that is affiliated with others, that receives affection and positive feedback from her/his friends and family tends to have a healthier psychology (Maslow, 1962; Marcia, 1973; Kohut, 1978). Construction of a coherent self-concept is essential to healthy interpersonal relationships. Various studies suggest that the introduction of the online social networks in our daily lives has changed the perception of both ourselves and our interpersonal communication. In this study, we have examined the way self is presented on the social networking sites, with the objective of understanding the underlying motives for this particular way of presentation, and how the tools provided by the social networking sites facilitate a new kind of identity/image construction.

To reach some conclusions about the Digital Life Scale data, and based on the nature of the variables, Spearman correlations were used to investigate relationships among the five factors defined in the previous section. Significant relationships were noted among the factors. In all of these analyses, the variables were entered in two blocks. Variables such as age group, gender and comparison were introduced as one block of data to be compared to the second block that consisted of the factors of the Self-Presentation 2.0 scale, namely, *Lifecasting*, *Negative Attitude*, *Proximity of Online/Offline Identities*, *Time Dedicated to Online Social Life* and *Superficiality*. As a second block of criteria, *Facebook Comparison*, *FaceID*, *Nanonymity*, *Living in the country of origin*, *NPI*, *Self-Esteem*, *Age* and *Gender* were entered.

An overall evaluation of the Digital Life Scale findings confirmed various points about contemporary online communication. For example, a correlation between *FaceID* and *Proximity* factors indicated that once we display our actual identities on social networking sites, we are more inclined to be 'ourselves' online. As we are nanonymous, we tend to have a higher tendency to present aspects of actual identity.

Similarly, another correlation was found between identifying our faces with our actual names online by uploading photos that show who we are, and our higher tendency to lifecast on Facebook, hence: Once we reveal our name and face on social network sites, our story follows shortly after. Though we cannot interpret this correlation as a causal relationship between these two behaviors, we could vaguely associate the act of revealing one's face on Facebook as the first step in the tendency to communicate more of one's life, one's narrative, and one's existence online.

One other tendency that is highlighted by this research is our tendency to ‘compare our insides with the outsides of others’, which appears to coincide with the *Superficiality* factor. According to Goffman, less intimacy indicates more superficial interactions: ‘Whatever it is that generates the human want for social contact and for companionship, the effect seems to take two forms: a need for an audience before which to try out one’s vaunted selves, and a need for teammates with whom to enter into collusive intimacies and backstage relaxation’ (Goffman, 1959, p. 206). Facebook is our new stage for testing our ‘vaunted selves’.

At the beginning of the twenty-first century, when Turkle had defined the *de-centralized identity*, she was talking about a parallel multiplicity of identities. But today we are immersed in a process where our *identity on the screen* is more and more part/reflection of our *true selves*, of our *real selves*. And yet, our *identity on the screen* is (1) our reflection of the narcissistic society, (2) a reflection of the narcissistic society on us, (3) a reflection of the narcissistic society that we have inside, (4) a reflection of the narcissistic society in which we live, almost as an image manipulated for self-marketing.

As the ultimate products of the consumer society, we are slowly becoming the *void images* that we have created of ourselves as our *real* and *digital* identities converge: [The brand] image [that we have carefully constructed and manipulated] becomes [our] i identity 2.0.

References

- Anderson, M. (ed.) (2007) *The Book of the Mirror: An Interdisciplinary Collection Exploring the Cultural Story of the Mirror*. Newcastle: Cambridge Scholars.
- Arda, Z. (2011) *Image Becomes Identity 2.0: Contemporary Approaches to the Construction of Human Identity* [Doctoral thesis]. Castellón: Universidad Jaume I.
- Baudrillard, J. (1993) *Otherness Surgery*. In Baudrillard, J. (2002) *Screened Out*. London: Verso.
- Bauman, Z. (2000) *Liquid Modernity*. Cambridge: Polity.
- Baumeister, R. F. (1997) *Identity, Self-Concept and Self-Esteem: The Self Lost and Found*. In Hogan, R., Johnson, J. and Briggs, S. (1997) *Handbook of Personality Psychology*. San Diego: Academic Press.
- Blackman, S. J. and Choquelle, P. (2011) *Seducing the Social Super Ego*. Paris: Proximity BBDO.

- Brewer, M. B. and Hewstone, M. (2004) *Self and Social Identity*. Massachusetts: Blackwell.
- Derrida, J. (1981) *Positions*. Chicago: University of Chicago Press.
- Foster, H. (2002) *Design and Crime (and Other Diatribes)*. London: Verso.
- Gauntlett, D. (2007) *Creative explorations: New approaches to identities and audiences*. London: Routledge.
- Giddens, A. (1991) *Modernity and Self-Identity: Self and Society in the Late Modern Age*. Cambridge: Polity Press.
- Goffman, E. (1959) *The Presentation of the Self in Everyday Life*. New York: Doubleday.
- Hall, S. (1996) *Introduction: Who Needs Identity?* In Hall, S. and Du Gay, P. (1996) *Questions of Cultural Identity*. London: Sage.
- Jung, C. G. (1953) *Two Essays on Analytical Psychology*. London: Routledge.
- Klein, N. (2000) *No Logo: No Space, No Choice, No Jobs*. New York: Picador.
- Kohut, H. (1971) *The Analysis of the Self*. New York: International Universities Press.
- Marcia, J. E. (1973) *Ego-Identity Status*. In Argyle, M. (1973) *Social Encounters*. Chicago: Aldine.
- Maslow, A. (1962) *Toward a Psychology of Being*. New York: Van Nostrand.
- Miller, D. (1998) *A Theory of Shopping*. Ithaca: Cornell University Press.
- Noonan, D. & Adler, J. (2002) The Botox Boom. *Newsweek*, 139:19, 50-58.
- Oyserman, D. (2003) *Self-Concept and Identity*. In Brewer, M.B. and Hewstone, M. (eds.), *Self and Social Identity*. Massachusetts: Blackwell.
- Rose, N. (1998) *Inventing Ourselves: Psychology, Power and Personhood*. Cambridge, MA: Cambridge University Press.
- Roszak, T. (1979) *Person/Planet: The Creative Disintegration of Industrial Society*. London: Gollancz.
- Shafak, E. (2010) *The Politics of Fiction*. [Online] TED Talks. Available from: <http://bit.ly/cMeZRa>. [Accessed: November 10th, 2010].
- Simmel, G. (2004) *The Philosophy of Money*. London: Routledge.
- Turkle, S. (2011) *Alone Together: Why We Expect More from Technology and Less from Each Other*. New York: Basic Books.



Quis Monet Ipsos Monitores? Motivations, methodological issues and techniques for monitoring the controversy on surveillance as a topic in on-line scraped textual data

Alberto CAMMOZZO^a and Andrea LORENZET^{*ab}

^a Observa - Science in Society; ^b University of Padua

This paper illustrates an automated computer program aimed at monitoring surveillance as a public technoscientific controversy within a big data perspective. The program collects on-line articles from selected newspapers, cleans them up, indexes, classifies and presents them according to a relevance criteria. This empirical work presents manifold challenges: (1) assessing the reasons for building such a tool; (2) defining some of the most relevant features of the selected theme; (3) tracing a methodologically sound path for the classification processes measuring the pertinence of a single newspaper article to the whole theme; (4) choosing sources; (5) selecting the textual analysis techniques and eventually building or assembling the necessary tools. Besides (a) describing the effort behind the production of the tool, this work (b) probes the methodological and technical issues of automated textual analysis of large (~700.000) items.

Keywords: Surveillance; big data; media monitoring; public controversies

Introduction

The current debate on surveillance is raging on the press following Wikileaks and Snowden-Datagate revelations, bringing back the central role of the press in monitoring government activities, as well as the interest of social scientists in interpreting these phenomena. But how does this monitoring happen? Does the word 'surveillance' mean the same for everybody? How does this theme get articulated in topics? Is there some topic that is covered more or less as time passes? Which are the most

* Corresponding author: **Alberto Cammozzo** | e-mail: ac+sts@zeromx.net

relevant keywords associated to the public representation of such controversy?

In order to answer to these questions, we are interested here in describing how sociologists and computer scientists can collaborate together in the attempt to create a materialization of what Bruno Latour (2005, p. 181) calls *oligoptica*, sites seeing *very little* in Latour's words; that is, seeing a rather small portion of social reality, but seeing it very well, projected and trained as they are to observe in a very accurate and detailed way what they are looking at.

When describing *oligoptica*, the main interest of Latour has been the attempt to describe some of the elements sustaining the 'sociotechnical', both as a relevant concept for doing social research avoiding to refer to older dichotomies (such as humans/machine, science/technology, and nature/culture), and at the same time as a programmatic academic sound research path.

To contribute to this latter effort, we thought that it was a good idea to reflect on how to create by ourselves an homemade *oligopticon* software, a program for observing the mass media, and in particular what digital online versions of newspapers do in relation to a specific issue, a public controversy (Venturini, 2010; 2012; Lorenzet, 2013) that is rather visible and present in the latter times, the issue of 'surveillance'.

While this does not mean to evaluate and monitor the actual controllers – being them public institutions or private companies - for sure by looking at the media by using text mining measures, we can understand and trace synthetic features regarding the spreading of a public discussion or controversy on the topic of surveillance, and in any case check how the media – one of the most powerful institutions in our society - cover the issue. At the same time, we are interested here in looking at relevant concepts and to the topics which are associated to the issue of surveillance in the social science literature, in order to understand connections and processes regarding the relevant issues identified by scholars with media attention and public understandings of these phenomena.

In describing the reasons motivating us in choosing this topic and what for us this topic means, it is interesting to reflect here a little bit more on the concept of *oligopticon* software machine for several reasons, trying to critically connect this concept as Latour does, to the more traditional idea of *panopticon*, developed by another French scholar, Michel Foucault (1975).

The first reason is related to the collective idea, prejudice, and paranoia on the same topic of surveillance, as a potentially dark and ultimate political

output of knowledge and digital societies. When speaking about surveillance there's obviously a dystopian strike and spin that we need to take into account in serious terms, not as the expression of a technophobia, but as one of the elements of the actual organization of public sphere at several levels, being them a local debate on the installation of CCTV systems in urban areas or the discussions on RFID and scanner systems at international and migration offices, affecting the crowds of travellers daily using airport services, or also the disrupting impact of technological innovations as Google Glass video-recording devices (Adey, 2003; Boyle and Haggerty, 2011; Fonio, 2011; Haggerty and Ericson, 2000; Lyon, 2003).

The second reason is to look at the development of another phenomenon, and precisely to how common users (being them individuals, companies or other organizations), are interacting with control devices in order not only to look and investigate at what others do, but to organize and manage their ordinary daily life. This is the function of the development and spread of data stored in digital and web companies that are managing, accessing and keeping for example email data, and it is also an issue regarding who has the right to own and use private data and for what reasons. In terms of public icons and myths, the outcome of this kind of discussion has been the development and growing interest on data journalism, and its most radical debate on issues such as the 'Snowden affair' and the discussion on Julian Assange's Wikileaks (Ball and Wood, 2013; Landau, 2013, 2014).

As interested human beings in the fields of social and computer sciences, we want also to be part of this collective being formed on surveillance, and we are interested here in reflecting on the opportunity to use web information within the frame of so-called *big data* research (Mayer-Schönberger and Cukier, 2013) to analyse and monitor what some digital media do in relation to the topic of surveillance. Our interest is not in becoming the controllers of the controlling, as our provocative question-title may be suggesting, but rather to understand how a specific public controversy, an issue such as surveillance, can be monitored in order to gain information about its spreading and diffusion in the public sphere.

This kind of work corresponds to the idea of needing a sound and reliable methodology for building social science *oligoptica*, an objective that was recognized by Bruno Latour himself when he coordinated and developed the EU-funded project Macospol (Mapping Controversies in Science for Politics), involving research teams based on the collaboration

between social scientists and computer scientists focused on both the review and the *ad hoc* realization of digital tools to map and visualize data about public Technoscientific controversies, that is public debates in which science and technology have a relevant constitutive dimension within heterogeneous social settings (Latour, Camacho-Hubner and November, 2010; Beck and Kropp, 2011; Venturini, 2008; Latour, 2011; Mélard, 2009; Lorenzet, 2011, 2013; Yaneva, 2012).

For us this work is part of the effort in providing methodologies and techniques for this kind of study, the Mapping of Technoscientific Controversies, and at the same time corresponds to the need of understanding how debates relate to Public Communication of Science and Technology processes, that is how they are related to the generation of a technoscientific public sphere, and thus in the interactions between mass media, public opinion, and policy regulations, as suggested by Bauer in the Mapping the Cultural Authority of Science project (Bauer, Shukla and Allum, 2011; Bauer and Gaskell, 2002; Bauer, Allum e Miller, 2007).

Moreover, our effort is part of the development of digital methods, that seek to move in the analysis of web contents beyond the analysis of Internet cultures, and thus to use the Web as a repository of information in order to study not so much media use, but instead to study relevant aspects of society itself thanks to information available on digital media (Rogers, 2013; Marres and Weltevrede, 2013).

Finally, the work here presented can be seen as one of the outcomes of the Science in the Media Monitoring project at Observa Science in Society, a multidisciplinary team working on the analysis of newspapers and digital media coverage of S&T issues since 2007 (Neresini and Lorenzet, 2011; 2012; 2013; Giardullo and Lorenzet, 2013)

Collecting the press discourse

This section describes the method of acquisition, processing and archiving of newspaper articles, along with the means for their classification and presentation.

The Science in the Media Monitor (SMM) project is a collection of programs articulated in four modular steps (see figure 1).

1) source selection: SMM has monitored since 2007 six newspapers, covering the most of Italian national daily paper readers (excluding those that offer only a regional coverage). For each of these, the a mix of

automatic and manual methods have been used to identify their active RSS feeds of national interest from their online editions;

2) corpus building: The RSS feed items are collected and stored. Each item points to a web page through its URL, which is retrieved in HTML format. The page is then sanitized and cleaned-up to avoid processing errors. Significant textual data (the body of the article) is automatically extracted from the page ('scraped') with XPATH extraction and regular expressions discarding non-relevant parts as advertisements, fixed parts of newspaper page, images, scripts, etc. Each article is then de-duplicated, that is checked for its uniqueness, trying to spot duplicate items published at the same or different URLs (articles with the same content may be published at different URLs) or from different RSS feeds (same content, different feed); to identify updates of the same news article over time and keeping the more recent one (same URL, different date); and to spot articles that are shared between different newspapers. Following the de-duplication check, only 'unique' articles are stored. Alongside the process, metadata is collected, providing information on the process itself;

3) data and metadata management and classification: each stage uses a no-SQL MongoDB database to store its data. The final corpus consisting in unique (de-duplicated) newspaper article text data is stored in yearly collections, along with the metadata regarding the process of its collection. Reporting modules build a daily report informing SMM staff on the harvesting process metrics. Corpora collections are then indexed using an Apache Foundation Solr platform. After indexing, scores are calculated according to classifiers. A classifier is a list of terms (a lexicon) where each term has a value weighting the importance of that term in the semantic field of the given theme. For each document and each classifier a score is calculated as the sum of the values of each term in the lexicon present in the document. Some classifiers may have special terms, called multipliers, used to enhance the value of other co-occurring terms whose meaning may be too broad or polysemic for the topic;

4) data analysis, presentation and query interface. A web interface allows to peruse documents sorted according to their classifiers score, or to search them by content, origin, type of source, time span, etc. Articles whose score is above a given threshold (named the *salience* threshold) are

considered ‘relevant’ for the given theme according to one of the classifiers. The use of multiple classifiers with different lexicons and weights is necessary to fine-tune the classification process and to test better classifiers that fit the evolution of the semantic field of the theme. Building and testing the lexicon is a delicate process described in the next section. Only relevant articles are further classified in four relevance classes (low, medium, high, very high) following their quartile distribution: articles in the top 25% rank are considered very highly relevant. The graphic interface shows also the ‘daily salience trend’ in time, an indicator of the relevance of the documents collected in each day for each source type (newspapers, blogs). A demo of the SMM system is accessible from this URL: <http://www.observa.it/science-in-the-media-monitor/?lang=en>.

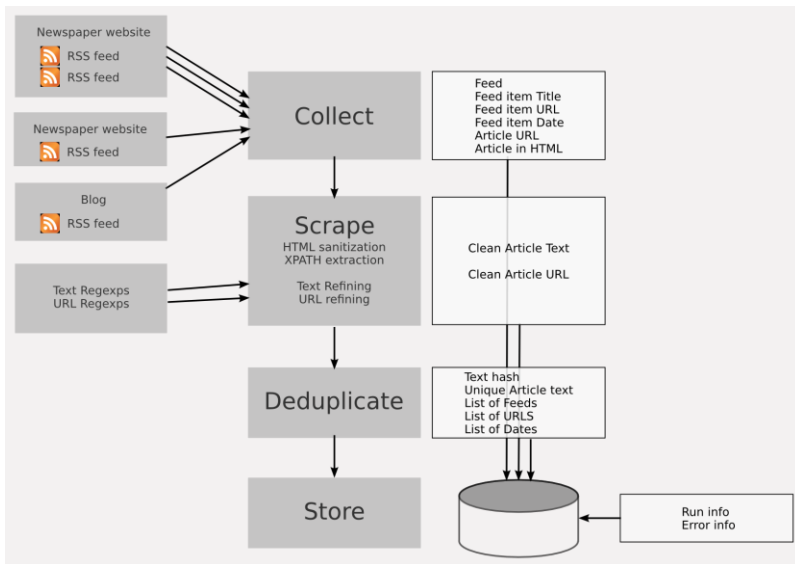


Figure 1 Program data workflow.

Construction of the lexicon for the surveillance topic

In order to understand how a lexicon can be useful in order to categorize the press articles related to a specific theme, in our case surveillance, it is useful to reflect on the relationship between events, media discourses, and

Quis Monet Ipsos Monitores? Motivations, methodological issues and techniques for monitoring the controversy on Surveillance as a topic in on-line newspapers textual data

the selection of specific keywords to be inserted in the lexicon. After that we will describe some techniques that can be used in order to give weights to keywords inside a classifier's lexicon.

We devised a three-layered model for the analysis of the relationship between public issues and a keyword classifier (see figure 2); the three levels of the model correspond to the development of the conceptual path that allows us to go from facts concerning a theme, to media items covering a public issue, and finally come to a lexicon, that is a series of keywords that we can use in order to detect the relevant newspaper articles covering selected topics.

The upper level of our model corresponds to the 'pragmatic plane of events', where we have several issues occurring in the real world. These events are basically facts that can be taken up by the media following the mechanisms and processes that are part of the 'agenda setting' phenomenon, according to which the mass media have the specific function of selecting and deciding the hierarchy of relevance of real world events and thus impacting in the long run on readers' reality perception (McCombs and Shaw, 1972).

The middle plane of our conceptualization corresponds exactly to the outcome of the agenda setting. Around the selected events the mass media generate not only a hierarchy of relevance, but also specific discourses. Media discourses are here intended as narratives that frame events and give to them some specific meanings and not others that resonate and can be understood by the public, becoming thus significant for most of them. Both quantitative coverage and the features of media discourses may vary depending on the specific media source, so what is relevant in one media arena (i.e. blogs), may be not in another (i.e. newspapers), and vice versa; at the same time some issue may generate similar discourses and framing in different sources.

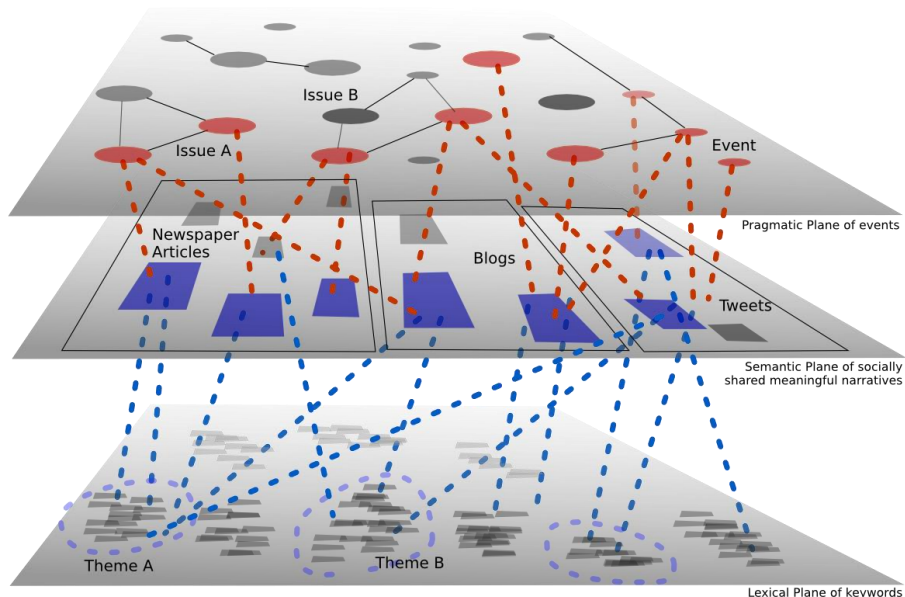


Figure 2 Our three layered conceptual model for thesaurus construction.

The lower part of our scheme is representing the attempt of our analysis to condensate issues reported by the media in a series of keywords, a lexicon, that is able to describe the articulation of the issue in the different medias, attempting to be as *neutral* as possible, that is avoiding noise and biases of sorts. Our aim is thus to build around each theme a classification list of these terms acting as a content selector: on the basis of this list of keywords we can obtain a selection of the relevant mass media coverage, and at the same time describe the relevant features of the discourses and framings occurring in relation to those events. Attempting to build a method for constructing an unbiased lexicon to capture the media discourse on a given topic means that the keywords composing the lexicon are chosen: 1) in a way that is as much as possible reproducible, 2) relying on a broad base of common understanding of the topic, and 3) in a way that can be tested upon.

To reach this objective for the 'surveillance' theme, we first devised two techniques to create a lexicon for categorizing and selecting contents: first automatic topic detection applied to a selection of academic articles and second a 'snowball' method applied on newspaper articles selected from a

keyword search of 'core' terms for the topic; both techniques are based on the analysis of a sample of articles that are somehow strongly related to the issue and constitute in different ways a 'ground truth' archive.

Automatic Topic Modeling

The first technique is based on the application of the LDA (Latent Dirichlet Allocation) algorithm for automated topic modeling (Blei et al., 2003; Blei and McAuliffe, 2007).

The aim is to explore thoroughly the semantic field of the theme, in this case 'surveillance' issues, relying on textual sources devoted to that theme, assuming that those sources will cover all the possible topics that articulate that matter or theme, at least for 'experts' from various disciplines. The second assumption is that an automated topic detection will uncover *all* these topics and present their specific keywords. On the one hand we can expect that topics covered in an interdisciplinary review of academic literature on the theme of 'surveillance issues' will be as broad as possible, ranging from CCTV cameras acceptance to government surveillance. On the other hand we must acknowledge that the process of selection of the academic articles remains biased by an 'academic' understanding of the research field and the knowledge of literature sources of the reviewer.

Topic modeling algorithms are statistical methods allowing to automatically detect the most significant *topics* within a given set of documents. During the last decade several topic modeling algorithms have been proposed, differing mainly on their assumptions (for example on the basis of the relationships among the topics to be extracted). The method we used for this analysis is based on the algorithm *Latent Dirichlet Allocation*, on the basis of which we find the assumption that documents are characterized by a given set of *topics*, where a *topic* is defined as a distribution on a fixed set of words: for example within the topic 'biomedical research and stem cells', the words regarding biomedical research and stem cells will be present with a high probability. Topics manifest within documents in different proportions: to do the analysis here described, we used the open source software called 'Mallet' (Mccallum, 2002), allowing to apply LDA to a set of documents, specifying the number of topics to be extracted and the number of keywords to be visualized (the sum of which can be considered those that best represent each topic).

Regarding the first method we built the corpus for Topic Detection with a two-pronged approach: on the one hand we retrieved 390 articles from

2002 to 2013 published in the journal ‘Surveillance & Society’, which is an interdisciplinary peer-reviewed and open access journal devoted to surveillance studies (Lyon, 2002; Marx and Muschert, 2007). On the other hand we built a review of special issues on surveillance in peer-reviewed academic journals other than ‘Surveillance and Society’. The initial core of articles found with traditional scientific literature exploration methods has been complemented with a crowdsourced approach, publishing the provisional review in two specialized mailing lists (*surveillance listserv* and *liberationtech*), and asking for integrations. The resulting list (Cammazzo, 2013) consists of items from 27 journal special issues from a broad disciplinary spectrum, of which 67 were suitable for download and automated text extraction.

Table 1 shows a sample of LDA output from the Mallet program trained on versions of both corpora modified with Treetagger (Schmid, 1995) to include only nouns. Please note that the topic title in square brackets has been added by the authors and does not come from the program output, that consists only in the first 10 keywords identifying a topic.

Table 1 Topics detected with Mallet from 390 articles retrieved from Surveillance & Society journal.

Topic number and [title]	Topic keywords
1. [Surveillance Studies]	surveillance study technology practice form resistance issue relation work lyon
2. [health & medicine]	health hiv surveillance disease individual sex testing medicine practice population
3. [children]	child parent school teacher family care mother home risk mobility
4. [military]	state police intelligence surveillance citizen war security control germany year
5. [risk]	power part order time risk case fact sense question person
6. [prisons]	home space people city wall prisoner street water prison toilet
7. [gender issues]	woman body discourse identity man gender narrative practice violence experience
8. [data protection law]	privacy protection information law datum data court case individual act
9. [data protection systems]	system datum technology information data project device network design collection
10. [government policies]	policy government crime process approach control strategy issue network agency
11. [privacy and drugs]	drug study research hair cent survey result community level sample
12. [identity cards]	system identification card identity technology database individual recognition biometrics id
13. [Internet]	individual life people information user internet site world network participant
14. [urban security]	space city security centre control system operator mall shopping room
15. [surveillance studies]	medium student event university animal time article interview paper research
16. [school]	year people area school community girl group time offender life

Quis Monet Ipsos Monitores? Motivations, methodological issues and techniques for monitoring the controversy on Surveillance as a topic in on-line newspapers textual data

17. [video surveillance]	camera image surveillance space film technology television art work video
18. [consumer data protection]	consumer information datum market user company marketing advertising form product
19. [book reviews]	book work world author text chapter analysis reader page argument
20. [communication]	information government service internet communication law response phone agency canada
21. [Foucault theory]	power foucault control society life body subject form individual space
22. [workplace]	organization employee information staff company monitoring management patient control work
23. [immigration control]	security border airport mobility state risk people movement immigration passenger
24. [crime control]	police camera crime system surveillance officer evidence safety driver area
25. [government]	welfare people agency service program state population case government technology

Some topics are common to both sources: data protection laws, foucaultian theory, consumer data exploitation and protection, video surveillance, crime control, immigration control, data protection law.

Other topics are specific to one source or the other: surveillance in schools and child security, surveillance and gender issues, healthcare, drugs and patient privacy, surveillance in sport events, surveillance and identification technologies.

Taken together, the topics from both sources illustrate the way the research debate around surveillance is articulated. An ideally unbiased lexicon should take into account keywords coming from all these topics in order to cover the ‘surveillance’ theme.

We have found it useful to make multiple runs changing the number of iterations and the number of topics, as LDA results greatly depend on program parameters: the results shown in the tables should be taken as an example of a larger set of outputs.

Even if topic detection is not intended to directly provide us with keywords for the lexicon but rather to map the semantic field of the ‘surveillance’ theme, some of the keywords from the topic analysis were used to enrich the classifier.

Seeding from the press discourse

Regarding the second point, that is the ‘snowball’ method, in order to analyse the press discourse we collected a sample of data from news search engine Google News, by using three *seed* keywords – ‘surveillance’, ‘privacy’, and ‘data’.

From this operation, we obtained a list of articles that we analysed with text mining software Rapidminer (Mierswa et al., 2006), obtaining the list of

key terms with the highest score in terms of the measure tf-idf (term frequency-inverse document frequency) (see table 2).

From this list, a manual selection of the keywords relating to the topic of surveillance has been made, and for each we obtained three different metrics, that is: the keyword frequency within the whole corpus; the IDF, measured as the logarithm of the total number of articles and frequency ratio, and the keywords salience, that is the percent of articles on the total number of articles that include at least one time the keyword.

The evaluation of the values of these measures allows us to define a scale of values for the keywords, thus weighting them and at the same time to assess their presence within the corpus.

Table 2 List of keyterms with the highest specificity in the considered corpus; IDF scores have been obtained has been tested on a corpus of 167472 documents (words have been translated from the Italian).

Keyterms	Frequency	(1/log (tot.articles/ frequency))	Keyterms salience (% of articles on total including keyword)
Society	18915	1,06	11,29
System	17753	1,03	10,60
Datum	17089	1,01	10,20
Citizen	16699	1,00	9,97
Personal	16081	0,98	9,60
Service	12077	0,88	7,21
Police	10879	0,84	6,50
Safety	10344	0,83	6,18
Services	10172	0,82	6,07
Data	9455	0,80	5,65
Web	8754	0,78	5,23
Information	8696	0,78	5,19
Control	8693	0,78	5,19
Internet	4973	0,65	2,97
Computer	3265	0,58	1,95
Protection	3221	0,58	1,92
Code	2852	0,57	1,70
Digital	2704	0,56	1,61
Mobile	2683	0,56	1,60
Web	2444	0,54	1,46
Processing	2329	0,54	1,39
Device	2085	0,52	1,24
Users	2066	0,52	1,23
Online	1839	0,51	1,10
Surveillance	1070	0,46	0,64
Social	1059	0,45	0,63
Authority	900	0,44	0,54
Privacy	830	0,43	0,50
App	156	0,33	0,09
Cloud	141	0,33	0,08
Nsa	21	0,26	0,01

Testing the classifier

The classifier is made of keywords and weights. The presence of a keyword in a document adds its weight to the document score. Some words may be polysemous: for instance /police/ may be a relevant term in the surveillance discourse, but may be present in lots of newspaper articles that are not relevant in the 'surveillance' theme.

Some keywords may be highly *specific* to the theme (their presence states the relevance to it), others may be more vague, but still relevant when the theme pertinence has been ensured by the presence of other highly specific keywords.

Testing the efficacy of the classifier means testing for 1) the effect of the presence or absence of certain keywords; and 2) the role of the certain keyword's weight value in the overall scoring effect. The score efficacy has to be measured against the relevance threshold value.

In the classifier testing process the documents whose score is near to the threshold value have a very important role, as they allow to assess the classifier *sensitivity* and *selectivity*. That is, measuring the number of relevant articles that were not identified as such, and the number of non-relevant documents that were mistakenly considered relevant.

This test, at the moment, is performed 'by hand', examining the documents whose score is in a certain range around the threshold value, and weighting the keywords and their values accordingly.

Conclusions

In order to automatically observe a phenomenon like surveillance in the press by building an automated software for classification of articles entails within the methodology of SMM – Science in The Media Monitor – different approaches. In this paper we described topic detection on scholarly articles on surveillance and a snow-ball analysis of a sample of the press discourse as tools to (1) explore some of the most relevant linguistic features of the articles, and (2) build a thesaurus classifier to be tested on a sample of articles and then applied to the whole corpus. Both techniques provide means to understand how quantitative analysis of rather large corpora of texts can be relevant for sociological analyses of technoscientific public issues; in particular these processes can be useful in view of automatic text classification as part of both a selection and interpretive processes, whose implications will be deepened in the course of future research.

References

- Adey, P. (2003) Secured and Sorted Mobilities: Examples from the Airport. *Surveillance & Society* 1 (4), 500-514.
- Ball, K.S. and Wood, D.M. (2013) Editorial. Political Economies of Surveillance. *Surveillance & Society*, 11 (1), 1-3.
- Bauer, M. W., and Gaskell, G. (eds.) (2002) *Biotechnology-the making of a global controversy*. Cambridge: Cambridge University Press.
- Bauer, M. W., Allum, N. and Miller, S. (2007) What can we learn from 25 years of PUS survey research? Liberating and expanding the agenda. *Public understanding of science*, 16 (1), 79-95.
- Bauer, M., Shukla, R. and Allum, N. (2011) *The Culture of Science: How does the Public relate to Science across the Globe*. London: Routledge.
- Beck, G. and Kropp, C. (2011) Infrastructures of risk: a mapping approach towards controversies on risks. *Journal of risk research*, 14 (1), 1-16.
- Blei, D.M. and McAuliffe, J.D. (2007) Supervised Topic Models. *Neural Information Processing Systems*, 121-128.
- Blei, D.M., Ng, A.Y. and Jordan, M.I. (2003) Latent dirichlet allocation. *Journal of Machine Learning* , 3, 993-1022.
- Boyle, P. and Haggerty, K.D. (2011) Civil Cities and Urban Governance Regulating Disorder for the Vancouver Winter Olympics. *Urban Studies* 48 (15), 3185-3201.
- Cammozzo, A. (2013) *Special issues on Surveillance* (working paper). [Online] Available from: <http://cammozzo.com/Papers/SurveillanceSpecialIssues.pdf> [Accessed 19th November 2014].
- Fonio, C. (2011) The silent growth of video surveillance in Italy. *Information Polity*, 16, (4), 379-388.
- Foucault, M. (1975) *Surveiller et punir*. Paris: Gallimard.
- Giardullo, P. e Lorenzet, A. (2013) *La ricerca emergente nei media: nanotecnologie, neuroscienze, biologia sintetica e proteomica*. In Neresini, F. e Lorenzet, A. (eds.), *Annuario Scienza e Società 2013*. Bologna: Il Mulino.
- Haggerty, K.D. and Ericson, R.V. (2000) The surveillant assemblage. *The British Journal of Sociology*, 51 (4), 605-622.
- Landau, S. (2013) Making Sense from Snowden: What's Significant in the NSA Surveillance Revelations. *IEEE Security & Privacy*, 11 (4), 54-63.
- Landau, S. (2014) Highlights from Making Sense of Snowden, Part II: What's Significant in the NSA Revelations. *IEEE Security and Privacy*, 12 (1), 62-64.

- Quis Monet Ipsos Monitores? Motivations, methodological issues and techniques for monitoring the controversy on Surveillance as a topic in on-line newspapers textual data*
- Latour, B. (2005) *Reassembling the Social-An Introduction to Actor-Network-Theory*. Oxford: Oxford University Press.
- Latour, B. (2011). Networks, Societies, Spheres – Reflections of an Actor-Network Theorist. *International Journal of Communication*, 5, 796-810.
- Latour, B., Camacho-Hübner, E. and November, V. (2010) Entering a risky territory: space in the age of digital navigation. *Environment and Planning D: Society and Space*, 28, 581-599.
- Lyon, D. (2002). Surveillance Studies: understanding visibility, mobility and the phenetic fix. *Surveillance and Society*, 1 (1), 1-7.
- Lyon, D. (2003) Airports as data filters: Converging surveillance systems after September 11th. *Information, Communication and Ethics in Society* 1 (1), 13-20.
- Lorenzet, A. (2011) Using the World Wide Web for the cartography of technoscientific controversies. *Tecnoscienza: Italian Journal of Science & Technology Studies*, 1 (2), 185-193.
- Lorenzet, A. (2013) *Il lato controverso della tecnoscienza. Biotecnologie, nanotecnologie e grandi opere nella sfera pubblica*. Bologna: Il Mulino.
- McCombs, M. E. and Shaw, D. L. (1972). The agenda-setting function of mass media. *Public opinion quarterly*, 36 (2), 176-187.
- Marres, N. and Weltevrede, E. (2013). Scraping the Social? Issues in live social research. *Journal of Cultural Economy*, 6 (3), 313-335.
- Mayer-Schönberger, V. and Cukier, K. (2013) *Big data: A revolution that will transform how we live, work, and think*. New York: Houghton Mifflin Harcourt.
- Marx, G.T. and Muschert, G.W. (2007) Personal Information, Borders, and the New Surveillance Studies. *Annual Review of Law and Social Science*, 3 (1), 375-395.
- Mccallum, A. (2002) *MALLET: A Machine Learning for Language Toolkit*. [online]. Available from: <http://mallet.cs.umass.edu> [Accessed: 15th May 2014]
- Melard, F. (2009) *Analysis of the participative set up and its outputs-the Debategraph and the bee controversies*. [Online] Available from: <http://orbi.ulg.ac.be/bitstream/2268/62810/1/Deliverable%20D6a%20EN.pdf>. [Accessed: 15th May 2014]
- Mierswa, I., Wurst, M., Klinkenberg, R., Scholz, M. and Euler, T. (2006) *YALE: Rapid Prototyping for Complex Data Mining Tasks*. In Eliassi-Rad, T., Ungar, L. H., Craven, M. and Gunopulos, D. (eds.), *Papers Presented at the*

- Proceedings of the 12th ACM SIGKDD International Conference on Knowledge Discovery and Data Mining (KDD 2006)*, New York: ACM Press.
- Neresini, F. and Lorenzet, A. (eds.) (2013) *Annuario Scienza e Società 2013*, Bologna: Il Mulino.
- Neresini, F. and Lorenzet, A. (2012) *Il dibattito sull'energia nei media italiani*. In Neresini, F. and Pellegrini, G. (eds.), *Annuario Scienza e Società 2012*. Bologna: Il Mulino.
- Neresini, F. and Lorenzet, A. (2011) *La scienza nei media italiani: tendenze e temi emergenti*. In Bucchi, M. and Pellegrini, G. (eds.), *Annuario Scienza e Società 2011*. Bologna: il Mulino.
- Rogers, R. (2013) *Digital methods*. Cambridge: MIT Press.
- Schmid, H. (1995) TreeTagger: a Language Independent Part-of-speech Tagger. Inst. Für Maschinelle Sprachverarbeitung Univ. Stuttg.
- Venturini, T. (2008) Introducing the cartography of controversies. *Etnografia e ricerca qualitativa*, 1 (3), 369-394.
- Venturini, T. (2010) Diving in magma: How to explore controversies with actor-network theory. *Public understanding of science*, 19 (3), 258-273.
- Venturini, T. (2012) Building on faults: how to represent controversies with digital methods. *Public Understanding of Science*, 21 (7), 796-812.
- Yaneva, A. (2012) *Mapping controversies in architecture*. Farnham: Ashgate Publishing.

Affrontare il divario generazionale tecnologico attraverso il gioco

Giuliana CATAPANO* and Ilaria MARIANI
Politecnico di Milano

Il paper presenta la ricerca teorica alla base di uno strumento ludico pensato sia per produrre consapevolezza su ciò che il divario digitale comporta, sia per ridurlo. L'artefatto, chiamato [S]collegati, è un sistema di comunicazione capace di veicolare informazioni e stimolare al dialogo e alla collaborazione tra le generazioni, forte da un lato dei meccanismi motivazionali tipici del gioco, dall'altro dello spazio sicuro che lo contraddistingue e all'interno del quale si incentiva l'apertura al nuovo e al diverso. Attraverso le sue meccaniche, invita i giocatori a riflettere criticamente sulle proprie abitudini e sui propri atteggiamenti nei confronti della tecnologia e di internet. La progettazione, basata sulla letteratura che ha analizzato le problematiche proprie di ciascuna generazione, ha inteso produrre un artefatto ludico che invita i giocatori a fare esperienza diretta dei propri limiti tecnologici e delle proprie abilità, trasformando le differenze alla base del divario in occasioni di condivisione, scambio e miglioramento reciproco. Il paper propone una disamina del contesto teorico e tematico alla base della progettazione e conclude fornendo alcune interpretazioni preliminari di possibili usi da parte degli utenti sulla base di situazioni sperimentali osservate durante lo svolgimento del lavoro progettuale.

Keywords: Consapevolezza tecnologica; nativi e immigrati digitali; gioco come facilitatore; divario digitale; relazione con il web

Introduzione

L'evoluzione tecnologica di cui siamo testimoni sta conducendo a profondi cambiamenti nell'interazione sociale tra le persone che con esse si trovano a interagire quotidianamente (Proserpio, 2011; Flusser, 2004; Da Empoli, 2002). Alla base della presente trattazione vi è la consapevolezza di trovarci in un contesto sempre più denso di strumenti e tecnologie di

* Corresponding author: **Giuliana Catapano** | e-mail: giuliana.catapano@mail.polimi.it

comunicazione. Viviamo infatti in un quotidiano tecnologico che è il frutto della coesistenza da un lato di un'informazione che si fa sempre più diffusa e pervasiva, dall'altro di un numero crescente di dispositivi che permettono la fruizione e trasmissione di contenuti e dati in pressoché qualunque tempo e luogo. Emerge poi una radicata tendenza all'interattività e a una mutua contaminazione tra i dispositivi che consentono la connessione; tale tendenza ha indotto ad abbandonare lo stato di isolamento reciproco che caratterizzava i media fino a pochi anni fa – si pensi ai primi telefoni e computer – a favore di nuove interazioni e linguaggi che li vedono comunicare reciprocamente.

L'evoluzione tecnologica di cui siamo oggi testimoni ha portato a numerose e significative conseguenze nel nostro quotidiano. In particolare, ci interessa indagare qui il modo in cui la presenza di device sempre connessi e la possibilità di accedere costantemente all'informazione si siano tradotti in cambiamenti sociali e culturali profondi e non trascurabili. Quanto detto risulta valido soprattutto per quella parte di popolazione che appare essere più sensibile alle novità, e che risulta propensa a mutare i propri atteggiamenti, linguaggi e abitudini in relazione proprio al rapporto che ha con la tecnologia (Jenkins, 2006). Attraverso il gioco, intendiamo indagare la relazione tra esseri umani, tecnologie di comunicazione e informazione, mirando a sollecitare una riflessione sulle diverse modalità di interazione con il mondo dell'online in generale, e della ricerca di informazione in particolare. Il gioco diventa uno strumento di introspezione, per capire da un lato come ciascuno di noi utilizza internet e i suoi strumenti, dall'altro quanto siamo effettivamente coscienti delle nostre azioni e dei nostri saperi.

Consapevoli del ruolo tradizionale (Huizinga, 1938; Caillois, 1958; Suits, 1978) e innovativo (Bogost, 2007; Gee, 2007) del gioco, proponiamo un artefatto ludico che ci porti a considerare criticamente le problematiche sensibili legate alla convivenza con la rete delle due diverse generazioni (Ferri, 2011; Van Eck, 2006).

Disparità e disuguaglianze legate all'accesso

Il rapporto con la tecnologia incide in modo evidente su attività che oggi, nella società della conoscenza e dell'informazione, siamo sempre più portati a considerare come basilari e necessarie: la possibilità e la capacità di accedere, analizzare, valutare utilizzando i diversi formati che la tecnologia ci propone risultano oggi essere alla portata di una parte significativa della popolazione, ma sicuramente non di tutta la sua totalità. I dati Audiweb che hanno indagato la diffusione dell'online in Italia, definiscono l'accesso alla

rete come diffuso su tutto il territorio e a tutti i livelli socio-demografici. Nella figura 1 si mostrano le percentuali di accesso nella popolazione tra gli 11 e i 74 anni e un dettaglio del segmento 11-34.

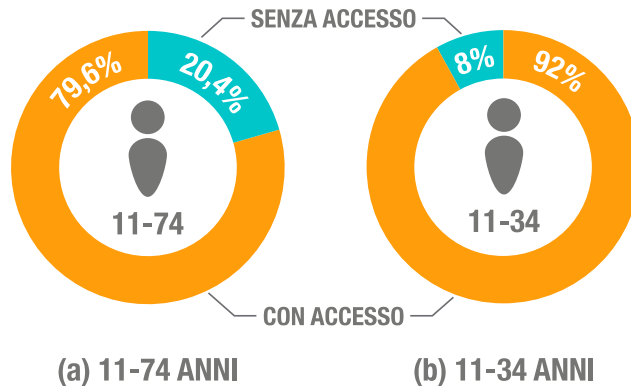


Figura 1 L'accesso alla rete nel contesto italiano raggiunge il 79,6% della popolazione tra gli 11 e i 74 anni (a). Guardando in particolare ai giovani tra gli 11 e i 34 anni (b), si rivela una penetrazione superiore al 92%. Fonte: Audiweb Trends, Ricerca di Base sulla diffusione dell'online in Italia, dicembre 2012.

Una considerazione fondamentale riguarda la fruizione di contenuti e informazioni: essa risulta strettamente legata non solo alla possibilità di connettersi alla rete (estesa ma non totale), ma soprattutto alla *capacità* dell'utente di rapportarsi con gli strumenti e le tecnologie che garantiscono l'accesso a tali saperi. Le diverse intensità di interazione e capacità di dialogo definiscono di fatto delle vere e proprie *disuguaglianze*, generando disparità. A partire dalle considerazioni appena presentate, è stato progettato un gioco capace di rispondere alle disuguaglianze e incentivare il dialogo tra utenti con diversi gradi di vicinanza alla tecnologia: da chi naviga online e usa gli strumenti digitali, spesso con disinvoltura, a chi li considera fuori della propria portata. Nella convivenza con la rete, infatti, i concetti di *incapacità* o *impossibilità di accesso* alla tecnologia o ai suoi contenuti, prendono la forma di problematiche sensibili e generalmente sottovalutate, il cui peso incrementa proporzionalmente all'aumentare del divario digitale (Quartiroli, 2013). L'ostacolo comunicativo che si genera è alla base di una *dicotomia sociale*, a svantaggio di quella parte di popolazione che non possiede i fondamenti utili alla comprensione dei nuovi linguaggi

multimediali. Si crea così un senso di frustrazione e incapacità, direttamente collegato all'impossibilità o possibilità limitata di partecipare alla cosiddetta *società della conoscenza e dell'informazione*: ci si trova di fronte a una vera e propria 'soglia di accesso'. Questa situazione, in assenza di interventi mirati e progettati ad hoc, può trasformare la distanza dalla rete in una forma di vera e propria emarginazione, avvertibile in misura proporzionale all'uso di internet (e dei device) nella quotidianità. Con questo target, una comunicazione di tipo tradizionale, ossia passiva e associabile alle lezioni frontali, risulta essere spesso inconcludente; al contrario, pratiche che prevedono la partecipazione e sperimentazione attiva della tecnologia, da internet agli strumenti per navigare, riescono a generare uno stimolo cognitivo e invitano ad un apprendimento conoscitivo. Il gioco mira a utilizzare le sue capacità motivazionali per contrastare il senso di incapacità e diffidenza verso l'ignoto, trasformandolo in una sfida.

Un aspetto non trascurabile riguarda poi la diffusione degli smartphone e la loro capacità di insinuarsi nei tempi del quotidiano. La comunicazione in mobilità si sta trasformando in pratica culturale comune: dal mantenimento delle proprie reti sociali alla ricerca e condivisione di contenuti, molte delle nostre attività sembrano svolgersi principalmente attraverso smartphone, tablet e strumenti mobili. Persino lo spazio urbano ci appare oggi densamente stratificato di elementi digitali – immagini, post, video e informazioni di varia natura geolocalizzati sul territorio – che si sovrappongono agli elementi architettonico-strutturali e agli aspetti culturali e sociali che in modo più o meno visibile popolano il tessuto cittadino.

Rifacendoci al rapporto Nielsen 2013, si può osservare la penetrazione dei cellulari nella popolazione sopra i sedici anni in diverse nazioni (figure 2a); in Italia, questo dato corrisponde al 97%, e muta sensibilmente se si osserva invece la diffusione degli smartphone, attestandosi al 62% (figure 2b).

Affrontare il divario generazionale tecnologico attraverso il gioco

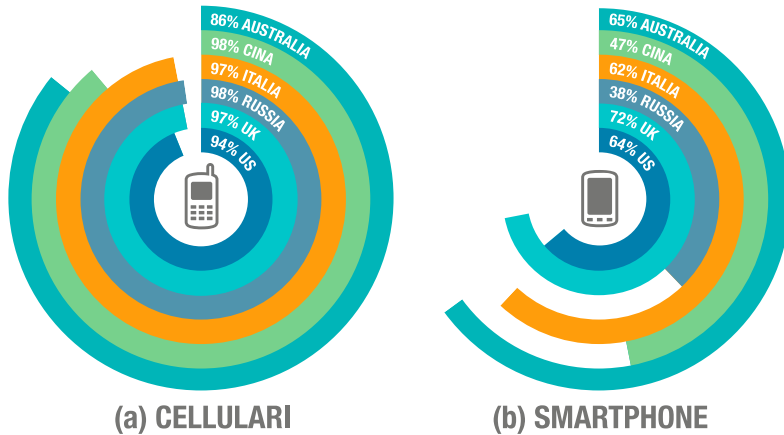


Figura 2 Penetrazione calcolata sui possessori di telefoni cellulari (a) e smartphone (b) con età superiore ai sedici anni. Fonte: Nielsen Global Smartphone Insights, 'The mobile consumer. A global snapshot', Febbraio 2013; Fonte: Nielsen, ottobre 2013.

Proseguendo l'analisi dei dati Nielsen, vediamo un numero crescente di persone trascorrere parte del proprio tempo giocando, e i dati del mercato lo confermano, dimostrando come il gioco si sia inserito nel nostro quotidiano. Secondo l'Istat (2012), 28,6 milioni di italiani, ossia il 48,2% della popolazione, gioca (+ 16% rispetto al 2011), e sono 18,6 i milioni di italiani che si dedicano a giochi digitali e utilizzano più piattaforme. Uno dei presupposti teorici alla base del progetto qui descritto consiste proprio nella generale e diffusa tendenza a giocare; una tendenza che cresce in concomitanza con l'uso sempre più intenso dei device mobili. Tali device consentono infatti di svolgere svariate attività – come si può osservare in figura 3, in cui sono rappresentate le tendenze nel mercato delle applicazioni – tra cui spiccano quelle ludiche.

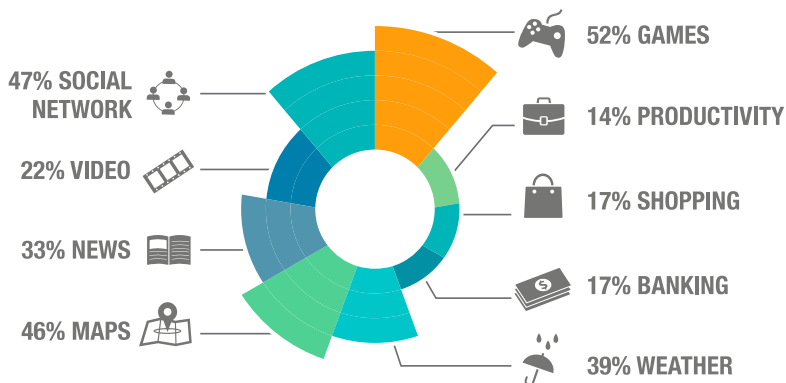


Figura 3 Cosa facciamo con i nostri smartphone? Fonte: Nielsen Global Smartphone Insights, 'The mobile consumer. A global snapshot', febbraio 2013.

Il gioco come attivatore di cambiamento

Il binomio gioco e trasmissione di saperi si presenta quale interessante opportunità progettuale. Numerosi autori hanno indagato l'artefatto ludico quale veicolo di informazioni e contenuti (Bertolo e Mariani, 2014; Gee, 2011; McGonigal, 2011; Salen, 2008), prendendo progressivamente le distanze dalla tradizionale – quanto obsoleta – concezione che il gioco per sua natura si contrapponga a studio, lavoro e impegno. Il gioco si caratterizza inoltre per la sua capacità di trascendere le barriere sociali, culturali e temporali, dimostrandosi un potente e valido strumento comunicativo.

La letteratura nell'ambito dei Game Studies evidenzia come oggi l'attività ludica sia uno strumento che il designer contemporaneo non può trascurare – soprattutto alla luce di una tendenza a giocare sempre più marcata nelle nostre quotidianità. Con riferimento alla ricerca, possiamo infatti affermare che tramite l'esperienza di gioco è possibile:

- incentivare lo sviluppo di connessioni interpersonali e stimolare il dialogo tra comunità sociali (Flanagan, 2009);
- introdurre nuovi pattern (Alexander, 1979) capaci di sensibilizzare su tematiche socio-culturali, ad esempio differenze interculturali e transgenerazionali (Bertolo e Mariani, 2014; McGonigal, 2011);
- incoraggiare il superamento delle tradizionali cornici di riferimento (Bateson, 1972) quale combinazione di abitudini socio-culturali,

Affrontare il divario generazionale tecnologico attraverso il gioco

comportamenti e atteggiamenti che più o meno consapevolmente definiscono il modo di pensare e agire di ciascuno (Sclavi, 2003); facilitare l'apprendimento nel suo più ampio senso di trasferimento della conoscenza e dei saperi (Salen, 2008; Bogost, 2011); promuovere il problem solving creativo-costruttivo volto a migliorare la vita quotidiana (Prensky, 2007; Jenkins, 2006); stimolare stati emozionali di appagamento e gratificazione (Csikszentmihalyi, 1990).

Alla base di questa notevole capacità comunicativa si trova la condizione di immersione, separazione e coinvolgimento che il gioco crea, facendolo emergere sempre più quale attività capace di incentivare l'acquisizione di nuove pratiche. Il gioco si differenzia infatti dalla realtà perché si svolge in spazi e tempi definiti e condivisi dai partecipanti, comunemente definiti *cerchio magico*: la metafora identifica una porzione di spazio/tempo che si distingue dall'ordinario. Ci rifacciamo quindi a quanto dichiarato da Salen e Zimmerman, studiosi di Game Studies e Game Design: 'To play a game is to move into the magic circle, to move from the domain of everyday life into a special place of meaning' (Salen e Zimmerman, 2004, p. 366).

Giocando siamo ben consapevoli di muoverci in uno spazio che concettualmente differisce da quello della realtà (Bateson, 1956, 1972): accediamo ad un mondo *altro* in cui il giocatore si può immergere e vivere esperienze significative che altrimenti non potrebbe o non sarebbe in grado di sperimentare, il tutto in sicurezza. Tale condizione è alla base della predisposizione psicologica che porta ad una maggiore ricettività delle informazioni (Koster, 2004). Il cerchio magico in questi termini può essere considerato quindi come una *cornice protettiva* che permette al giocatore di esperire la realtà proposta senza alcun tipo di paura o pregiudizio nei confronti delle azioni da compiere (Crawford, 1984).

Generazioni a confronto e problematiche relative: uno sguardo progettuale

[S]collegati nasce da una ricerca teorica sui Game Studies e il divario intergenerazionale, oggetto della tesi di Laurea Magistrale in Design della Comunicazione (Scuola del Design, Politecnico di Milano) di Giuliana Catapano, con la supervisione di Maresa Bertolo e Ilaria Mariani.

Esplorando il web come contesto di interazione, indagando le diverse modalità con cui ciascuno interagisce con la rete e i sistemi di comunicazione contemporanei, sono emersi alcuni principi generali che differenziano le persone proprio sulla base del loro rapporto con gli

strumenti digitali. Riprendiamo a tal proposito le categorie che lo studioso e consulente nel campo dell'educazione e dell'apprendimento Marc Prensky, per primo nel 2001, ha individuato. Da un lato troviamo i *nativi digitali* che, essendo nati dopo l'avvento di internet, interagiscono in modo *naturale* con gli strumenti tecnologici; dall'altro gli *immigrati digitali*, che hanno conosciuto internet in età più avanzata e hanno dovuto adattarsi, apprendere e imparare a interagire con la rete e le sue potenzialità (Prensky, 2001; Salen, 2008).

Le differenze sono tanto sostanziali da valere alle due categorie la definizione di "generazioni". Per molti aspetti antipodiche, si caratterizzano per peculiarità e diversità che trascendono l'aspetto prettamente demografico, riguardando principalmente il diverso rapporto con le tecnologie e le conseguenze a livello di abitudini, interazioni e comunicazione. Il progetto si rivolge a entrambe le tipologie di utenti: a coloro che utilizzano i nuovi linguaggi e strumenti tecnologici con disinvoltura e naturalezza (Prensky, 2001, p. 1; Jenkins, 2009; Ferri, 2011;) e a coloro i quali non appartengono alla generazione dei nativi digitali, ma hanno invece adottato le nuove tecnologie e le hanno integrate nella loro quotidianità: questi ultimi sono definiti *immigrati digitali*. Proprio questo secondo target composto da coloro che, nati prima dell'avvento di internet, convivono oggi con gli effetti che i nuovi media generano nei contesti di interazione sociale e di informazione, risulta utilizzare i media e le tecnologie con diversi livelli di cautela e diffidenza, con diversi atteggiamenti di entusiasmo o sospetto, ma soprattutto con scarsa spontaneità, secondo un uso *appreso* e non *intuitivo*.

Osservando le ricerche nazionali Istat del 2012 (figure 4), si può poi individuare una terza categoria, che potremmo definire dei *diversamente digitali*, costituita da coloro che sono cresciuti senza tecnologie e rispondono alle difficoltà di interazione con i media adottando due atteggiamenti, entrambi negativi, di allontanamento. Tale categoria risulta decisamente interessante per il progetto in quanto da un lato presenta un disinteresse nei confronti di internet, leggibile come mancanza di comprensione delle potenzialità del mezzo; dall'altro, sebbene si attesti una volontà di fondo nell'interazione con la rete, dimostra una radicata mancanza delle nozioni fondamentali atte a dialogare con lo strumento digitale, che pertanto risulta – in toto o parzialmente – precluso e inaccessibile. Quindi, il reale problema degli immigrati e dei diversamente digitali sembra in buona parte consistere nella mancanza di confidenza con il sistema e la conseguente frustrazione indotta.

Proguettualmente, riteniamo interessante notare (figure 4), come la presenza di nativi digitali all'interno di un'unità familiare sia in grado di stimolare e influenzare positivamente la relazione dell'intero nucleo con le tecnologie di più recente acquisizione, supportando gli immigrati e spronando i diversamente digitali a interagire e aprirsi alle possibilità offerte dalla rete.

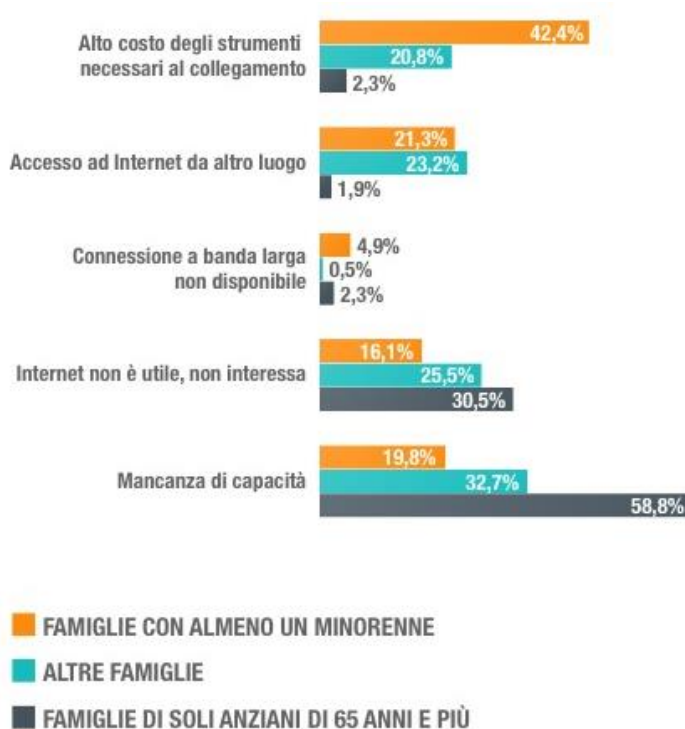


Figura 4 Famiglie prive di accesso domestico a internet in Italia, suddivise per motivazione e tipologia di nucleo familiare. Fonte: Report Istat Cittadini e nuove tecnologie, 2012.

Sono quindi emersi gli aspetti positivi che l'interazione con i nativi digitali può generare nelle altre due generazioni. Tuttavia, al fine di rendere il gioco funzionale ed *educativo* per la totalità del target, non possiamo trascurare le problematiche proprie dei nativi. La stretta relazione che li lega a internet e la loro costante interazione con quest'ultima, è infatti alla base dei cosiddetti *comportamenti digitali*. Se da un lato spiccano abilità positive

quali multitasking, conoscenza distribuita e intelligenza collettiva (Jenkins, 2009; Prensky, 2007), dall'altra troviamo rischi quali una maggiore fatica nella velocità di context switch (Carr in Ferri, 2011), una difficoltà di archiviazione delle informazioni nella memoria a lungo termine, e una minor capacità di concentrazione (Stoll, 2004), e soprattutto la frequente incapacità di avere un reale giudizio critico dovuto all'eccessiva fiducia nella rete, che li porta a considerare affidabili contenuti e fonti che invece necessiterebbero una verifica più accorta (Quartiroli, 2013). Tali pratiche sono in evidente e netto contrasto con l'attitudine delle altre due generazioni ad apprendere assimilando informazioni e custodendole sotto forma di nozioni e sapere acquisiti.

Pertanto, il contatto tra generazioni distanti può incentivare l'interazione con la rete e i suoi strumenti: la collaborazione, il confronto e la contaminazione reciproca assumono così il ruolo di indiscussi protagonisti nella progettazione del gioco *[S]collegati* e delle sue meccaniche. Al contempo, proprio la soluzione che proponiamo, ossia il dialogo e lo scambio, risulta essere il maggior ostacolo da superare, dati i preconcetti di ciascuna generazione verso le altre.

[S]collegati, un progetto ludico per affrontare il divario tecnologico-generazionale

L'analisi fino ad ora presentata ha quindi evidenziato sia l'ambito di interesse sia le problematiche rilevanti su cui il progetto intende intervenire. I meccanismi motivazionali del gioco sono stati di conseguenza studiati e strutturati al fine di raggiungere obiettivi mirati e diversificati per ciascun target, che nello specifico sono:

per i nativi: l'interazione e la collaborazione con i non nativi, e attraverso logiche di scambio, la rivalutazione del potenziale di un sapere non tanto *a portata di mano*, ma *assimilato*, recuperando abitudini di pensiero proattivo appartenenti a esperienze pregresse, ed oggi spesso soppiantati a favore di un uso passivo delle tecnologie di informazione;

per i non nativi: l'utilizzo di strumenti tecnologici altrimenti considerati 'ostili', contribuendo a generare un senso di confidenza verso tali device, e facendo leva sulla possibilità di generare una relazione con chi già padroneggia i modi della rete.

Sul piano della comunicazione intergenerazionale invece, *[S]collegati* fa leva sulle caratteristiche positive proprie di ciascuna delle diverse generazioni, enfatizzandole e valorizzandole, al fine di stimolarne la comprensione e condivisione; viceversa, si vuole incoraggiare una riflessione attiva su atteggiamenti e comportamenti generalmente visti come distanti, e un'apertura a strumenti e pratiche usualmente percepiti come ostili e/o difficili.

Per raggiungere tale scopo, il progetto intende generare un'esperienza significativa che non rimane limitata al gioco in sé, ma che anzi si espande ai diversi aspetti del quotidiano. Si affronta così il divario generazionale-tecnologico in atto, invitando i suoi protagonisti a scoprire di più su se stessi, acquisire consapevolezza sulla modalità di interazione con la rete, e soprattutto comprendere e rivalutare le altre generazioni.

Il gioco si propone come metafora della ricerca online e, nello stesso tempo, come espediente attraverso cui i giocatori possono mettere in discussione le proprie abilità e collaborare per ottenere un fine comune (la vittoria). Il progetto si basa sulle caratteristiche costitutive del web, e si struttura tenendo conto delle attitudini e degli atteggiamenti che gli utenti, a seconda della generazione cui appartengono, sviluppano e portano con sé nel momento in cui si trovano a dover effettuare una ricerca online. I tratti identificativi del web, ossia il suo essere ipertestuale, la rilevanza dell'intelligenza collettiva e collaborativa, definiscono l'aspetto e le meccaniche di *[S]collegati*.

Gameplay

[Scollegati] è un board game nel quale i giocatori, divisi in squadre, si affrontano nell'indovinare parole o espressioni a partire dalle definizioni fornite attraverso carte di gioco. Per riuscirci possono fare affidamento al proprio sapere e alla propria memoria, oppure ricorrere al web e cercare online il termine che risponde alla definizione data. La vittoria, come vedremo, va alla squadra che arriva per prima alla fine del percorso di gioco.

La preparazione della partita ha inizio con la formazione di due squadre, ciascuna composta da minimo due giocatori. Data la finalità inclusiva e collaborativa del progetto, che mira a valorizzare le capacità delle altre generazioni, le squadre dovrebbero essere formate da persone con età e predisposizione alla rete differente. In particolare, la configurazione ottimale si ha con una maggiore differenza di età tra i componenti di una stessa squadra, in quanto a ciò tendenzialmente corrisponde una maggiore diversificazione di saperi. Tale concetto è ulteriormente enfatizzato dalla

scelta di fare iniziare la partita proprio alla squadra che presenta una maggior differenza di età tra i suoi componenti.

Abbiamo scelto a questo fine di sviluppare il materiale di gioco (figura 5) con una forte analogia rispetto alla struttura della rete: il pianale è un'astrazione di un ipertesto e propone il percorso di gioco come connessioni che uniscono le diverse caselle.

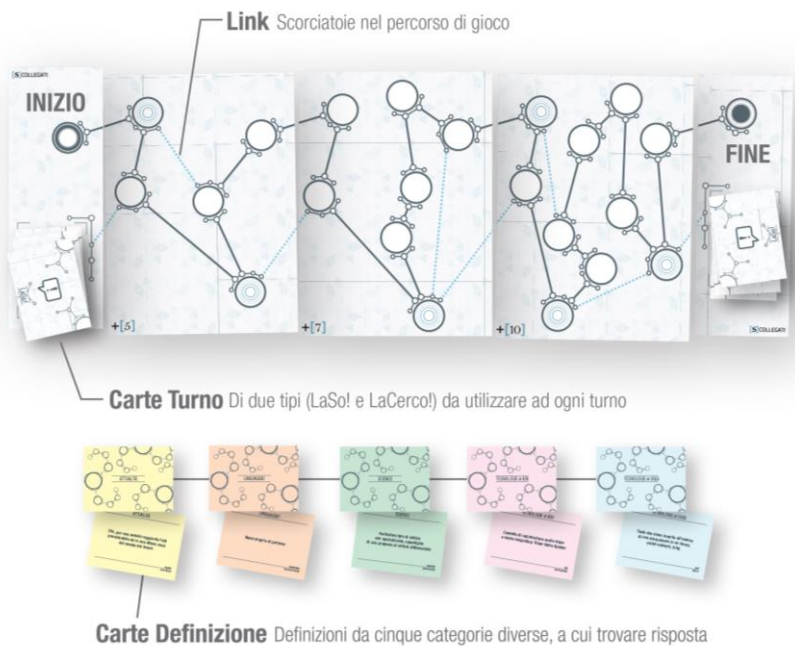


Figura 5 Gli elementi di gioco.

[S]collegati parte sulla casella Inizio e segue una struttura lineare, che consente di proseguire da una casella all'altra; esistono tuttavia delle scorciatoie che permettono connessioni dirette e veloci tra caselle distanti tra loro: come si vedrà a breve, queste particolari connessioni sono chiamate Link. Ciascuna casella corrisponde a un turno, e il numero di turni della partita viene definito scegliendo quanti e quali dei tre pianali (da cinque, sette o dieci turni) saranno utilizzati, e l'ordine in cui disporli.

L'avanzamento dei turni è regolato dall'utilizzo di carte specifiche, dette appunto Carte Turno. Le squadre utilizzano tali carte ogni volta che avanzano di casella e al contempo dichiarano in modo esplicito la modalità

di ricerca che intendono adottare per individuare la parola descritta nella definizione: potranno infatti cercarla online, o tra i propri saperi, ragionando insieme. Queste due diverse azioni sono rappresentate dalle due tipologie di Carte Turno: LaCercò! e LaSo! (figure 6).

Nella fase di preparazione, a ciascuna squadra viene fornita una quantità totale di Carte Turno, pari al numero di turni previsti dalla partita. Entrambe le squadre possono scegliere quante Carte Turno per tipologia avere. Ad esempio, in una partita da cinque turni, si potrà scegliere di avere tre LaSo! e due LaCercò!.



Figura 6 Le due tipologie di Carte Turno: LaCercò! e LaSo!

Ogni turno prevede che una squadra peschi una carta da un mazzo di Carte Definizioni e legga il testo riportato; i giocatori decidono la modalità di ricerca da adottare e giocano la Carta Turno corrispondente (LaSo! e LaCercò!), procedendo poi a individuare il termine cui la definizione si riferisce. Se la squadra indovina il termine descritto sulla carta, può avanzare di casella.

Soprattutto quando le squadre risultano formate da componenti di diverse generazioni, l'esperienza di gioco stimola nei singoli giocatori la sperimentazione di modalità di ricerca che generalmente appartengono ad altre generazioni, attivando un pensiero critico sui propri atteggiamenti consolidati. Quando si decide di utilizzare la Carta Turno LaCercò!, gli immigrati e i diversamente digitali sono invitati a interagire con strumenti di ricerca online, a rapportarsi con le tecnologie che garantiscono l'accesso alla rete e, potenzialmente, a tali saperi. Al contrario, quando i nativi devono utilizzare la Carta LaSo! non possono utilizzare internet e i suoi strumenti e sono quindi portati a ragionare e ricordare saperi acquisiti. Le diverse intensità di interazione e capacità di dialogo, che generalmente definiscono

delle vere e proprie *disuguaglianze* che generano disparità, si trasformano in potenzialità da riconoscere ed esplorare giocando.

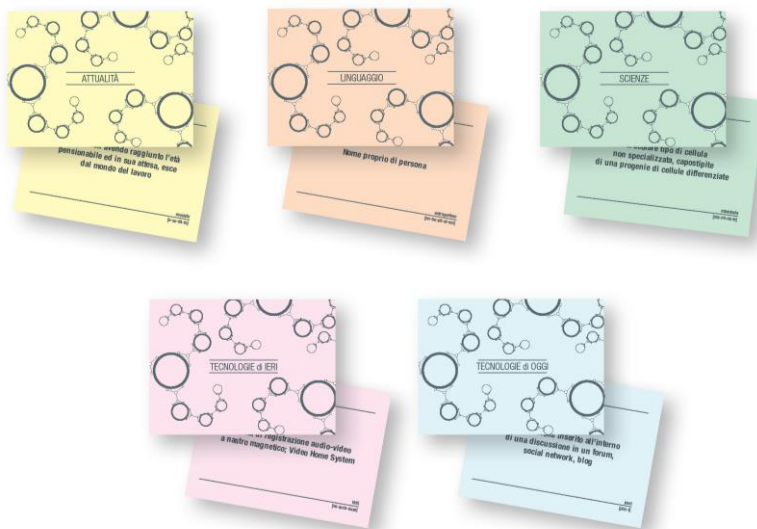


Figura 7 Esempio di una carta, fronte e retro, per ciascuna delle cinque categorie di definizioni.

Le categorie di definizioni individuate sono cinque e sono state scelte per enfatizzare i differenti saperi propri di ciascuna generazione: Attualità, Linguaggio, Scienze, Tecnologie di Ieri, Tecnologie di Oggi. Le tematiche sono state individuate per sollecitare una riflessione collettiva che deriva da un confronto e uno scambio di saperi tra generazioni e spingere i partecipanti ad una collaborazione proattiva. Tra queste categorie, ciascuna squadra deve individuare il proprio Punto Debole, ossia un ambito di saperi verso cui i giocatori hanno una conoscenza complessiva più limitata rispetto alle altre.

Durante il turno di ciascuna squadra non viene posta alcuna domanda appartenente alla categoria individuata come proprio Punto Debole.

Le Carte Turno e la categoria Punto Debole sono alla base dei Link.

Qualora una squadra voglia utilizzare una scorciatoia per abbreviare il proprio percorso e avanzare più rapidamente verso la vittoria, deve giocare la tipologia di Carta Turno che possiede in minor quantità e affrontare il proprio Punto Debole. Se viene indovinato il termine descritto sulla carta, il link viene attivato e si avanza tramite la scorciatoia alla casella collegata.

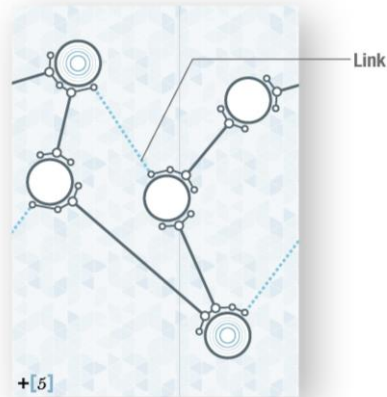


Figura 8 Un esempio di Link presente sul pianale.

Le condizioni di fine gioco sono di due tipi: esaurimento delle Carte Turno e raggiungimento della fine del percorso previsto. Quando una di queste due condizioni si verifica si conclude la partita e si decreta la squadra vincitrice. In particolare, nel primo caso, vince la squadra che possiede ancora delle Carte Turno; nel secondo caso, vince chi raggiunge per primo la casella Fine.

Possibili sviluppi futuri

Data la natura attuale di *[S]collegati* e al fine di garantire longevità al gioco, riteniamo interessante prevedere alcune possibili evoluzioni volte ad ampliare lo spettro di azione e il target del progetto.

Le cinque categorie delle Carte Definizione sono state individuate come tematiche utili a massimizzare il dialogo intergenerazionale e la riflessione individuale sugli atteggiamenti di ciascuna generazione nei confronti della rete. Non si esclude tuttavia la possibilità di ampliare sia la quantità di categorie, sia il numero di definizioni proposte per ciascun argomento. Tra gli sviluppi futuri del gioco si prevede di dare agli stessi giocatori la possibilità di creare categorie personalizzate, fornendo un layout di base precompilabile. Si fornisce così l'opportunità di coinvolgere come parte attiva i giocatori, personalizzando il gioco e i suoi elementi. Ad esempio si potrebbe produrre un'intera categoria che mira all'alfabetizzazione digitale degli anziani, o ancora all'uso consapevole della rete da parte dei bambini.

Un'ulteriore implementazione riguarda il pianale di gioco: si potrebbe infatti progettare un pianale unico, escludendo il fattore di modularità, e declinandolo con dimensioni differenti e tempi definiti. Tale sviluppo renderebbe il gioco attuabile ad esempio nelle aule informatizzate delle scuole o nei centri per gli anziani, permettendo a squadre più numerose o più squadre di giocare contemporaneamente.

Inoltre, forti della tendenza a trasporre su piattaforme digitali boardgame esistenti, si può prevedere una versione di *[S]collegati* per app mobile o online: mentre la versione qui proposta (gioco da tavolo) può risultare più immediata e vicina ai non nativi digitali, pur prevedendo l'ausilio di internet, per i nativi digitali è sicuramente più allettante avere il gioco sempre a portata di mano sui loro smartphone o device mobili in generale. La versione digitale potrebbe incoraggiare gli immigrati e i diversamente digitali a prendere confidenza con i device tecnologici e la rete: attraverso l'ausilio di un gioco già sperimentato 'analogicamente', si può infatti generare un senso di familiarità che incoraggia a superare la diffidenza, avvicinandosi a tecnologie ritenute 'ostili'.

La trasposizione digitale richiederebbe comunque un nuovo iter di playtest volto a validare le dinamiche, ridefinire i tempi di gioco conformemente al device scelto e confermare la validità dell'esperienza di gioco in sé.

Conclusioni

Attraverso la descrizione del lavoro progettuale e delle meccaniche di *[S]collegati* abbiamo mostrato la possibilità di progettare un artefatto ludico in grado di veicolare informazioni e contenuti, trasformando la barriera alla base del divario intergenerazionale e culturale in una possibilità di scambio, interazione e collaborazione costruttivi tra le parti. Le sessioni di gioco finora svolte hanno mostrato come i giocatori si pongano in una condizione di maggiore apertura al diverso e al nuovo, facendo esperienza diretta dei propri limiti delle rispettive abilità, indipendentemente dalla generazione di appartenenza. Ciò ha spesso portato a una riflessione sulle diverse abitudini tecnologiche e sul rapporto con la tecnologia stessa.

[S]collegati è stato infatti progettato per generare un'esperienza significativa e una riflessione critica che non rimanga limitata al gioco in sé, ma che anzi si espanda ai diversi aspetti del quotidiano. Giocando, gli appartenenti alle diverse generazioni hanno potuto attivare delle riflessioni nei riguardi di atteggiamenti divenuti oramai consolidati, rivalutando la

possibilità di modificare le proprie abitudini al fine di avvicinarsi alla rete in modo più consapevole.

Le considerazioni presentate in questo paper derivano principalmente da una prima fase di osservazione volta a indagare l'efficacia delle singole decisioni progettuali. È tuttora in corso una sperimentazione per la raccolta dati che si avvale di una combinazione di strumenti e tecniche per l'osservazione e l'analisi qualitativa e quantitativa delle sessioni di gioco – principalmente basato su questionari e focus group.

Il coinvolgimento di molteplici figure disciplinari è cruciale in quanto ha permesso e permette di investigare l'esperienza di gioco con prospettive differenti e complementari, arricchendo il progetto e contribuendo a definire linee guida per il suo miglioramento. Sociologi ed educatori si sono affiancati al game designer nella fase di ideazione. Si tratta di una proficua collaborazione che sta proseguendo nell'elaborazione, interpretazione ed elaborazione di quanto emerso dalle sessioni di gioco finora svolte, e che accompagnerà il processo di potenzialmento, validazione e valutazione.

Il progetto risulta promettente in termini di riduzione del divario soprattutto considerando come la predisposizione tecnologica che contraddistingue i più giovani alimenti un continuo processo di esclusione dovuto alla produzione di nuovi linguaggi e comportamenti che non appartengono alle altre generazioni. In questo senso, inoltre, alcune sperimentazioni sugli usi previste dal progetto sembrano mostrare una contaminazione positiva tra giocatori/utenti con abitudini tecnologiche agli antipodi, portando ad esempio ad un ampliamento del vocabolario.

In particolare, si sta osservando una presa di consapevolezza non solo verso un uso più ragionato di Internet, ma soprattutto una rivalutazione delle proprie capacità deduttive e attentive. Analogamente, si è riscontrato un cambiamento dell'approccio nella ricerca online, con una maggior attenzione alle fonti e ai termini in fase di ricerca.

A lungo termine, attraverso il suo sistema motivazionale che incentiva ad accedere ad Internet, possiamo ipotizzare che *[S]collegati* possa facilitare i non nativi digitali a una partecipazione più attiva al panorama sociale digitale e in molti casi a una maggiore possibilità di inclusione e comprensione delle comunicazioni istituzionali. Tale fronte, ritenuto socialmente significativo e ricco di potenzialità, è attualmente indagato con una sperimentazione finalizzata a comprendere le reali potenzialità progettuali e formative del gioco.

References

- Alexander, C. (1979) *The Timeless Way of Building*. New York: Oxford University Press.
- Bateson, G. (1956) *The Message 'This is Play'*. Paper Presented at the Second Conference on Group Processes, New York.
- Bateson, G. (1972) *Steps to an Ecology of Mind*. New York: Ballantine Books.
- Bertolo, M. e Mariani, I. (2014). *Game Design. Gioco e giocare tra teoria e progetto*. Milano: Pearson.
- Bogost, I. (2007) *Persuasive Games: The Expressive Power of Videogames*. Cambridge: MIT Press.
- Bogost, I. (2011) *How to do Things with Videogames*. Minneapolis: University of Minnesota Press.
- Caillois, R. (1958) *I Giochi e Gli Uomini. La Maschera e La Vertigine*. Milano: Bompiani.
- Crawford, C. (1984) *The Art of Computer Game Design*. New York: McGraw-Hill.
- Csikszentmihalyi, M. (1990) *Flow: The Psychology of Optimal Experience*. New York: HarperCollins.
- Da Empoli, G. (2002) *Overdose: La società dell'informazione eccessiva*. Venezia: Marsilio.
- Ferri, P. (2011) *Nativi Digitali*. Milano: Mondadori.
- Flanagan, M. (2009) *Critical Play: Radical Game Design*. Cambridge: MIT Press.
- Flusser, V. (2004) *La Cultura Dei Media*. Milano: Bruno Mondadori.
- Gee, J.P. (2007) *What Video Games have to Teach Us about Learning and Literacy*. New York: Palgrave Macmillan.
- Gee, J.P. e Hayes, E.R. (2011) *Language and learning in the digital age*. New York: Routledge.
- Huizinga, J. (1972 - ed. or. 1938) *Homo Ludens*. Torino: Einaudi.
- Jenkins, H. (2006) *Convergence Culture: Where Old and New Media Collide*. New York: NYU press.
- Jenkins, H. (2009) *Confronting the Challenges of Participatory Culture: Media Education for the 21st Century*. Cambridge: MIT Press.
- Koster, R. (2004) *Theory of Fun for Game Design*. Cambridge: O'Reilly.
- McGonigal, J. (2011) *Reality is Broken: Why Games make Us Better and how they can Change the World*. New York: Penguin Press.
- Prensky, M. (2001) Digital Natives, Digital Immigrants. In *the Horizon* 9.
- Prensky, M. (2007) *Digital Game-Based Learning*. New York: Paragon House.
- Proserpio, L. (2011) *Comportamenti Digitali*. Milano: EGEA.

- Quartiroli, I. (2013) *Internet e l'Io Diviso. La Consapevolezza di Sé nel Mondo Digitale*. Torino: Bollati Boringhieri.
- Salen, K. (2008) *The Ecology of Games: Connecting Youth, Games, and Learning*. Cambridge: MIT Press.
- Salen, K. e Zimmerman, E. (2004) *Rules of Play: Game Design Fundamentals*. Cambridge: MIT Press.
- Sclavi, M. (2003) *Arte di ascoltare e mondi possibili. Come si esce dalle cornici di cui siamo parte*. Milano: Mondadori Bruno.
- Stoll, C. (2004) *Confessioni di un Eretico High-Tech*. Milano: Garzanti Libri.
- Suits, B. (1978) *The Grasshopper: Games, Life and Utopia*. Toronto: University of Toronto Press.
- Van Eck, R. (2006) *Digital game-based learning: It's not just the digital natives who are restless*. *EDUCAUSE review*, 41 (2), 16-30.



From bits to atoms: sensory displays for digital information

Sara COLOMBO* and Lucia RAMPINO
Politecnico di Milano

Traditional media conveying digital data (e.g. screens and displays) should be rethought also paying attention to the user experience. Moreover, sensory channels different from the visual one may be explored by design.

This work analyses how physical objects can display information not only by embedding conventional screen-based interfaces, but by dynamic transformations in their sensory features. As there is a gap in design literature about this topic, this paper investigates the roles and meanings of sensory modalities and media in the transmission of different types of messages. The aim is both to propose a framework for the categorization and analysis of this emerging category of 'dynamic products' and to give some insights on the role sensory modalities and media may assume in different situations. To achieve the goal, a case-study analysis was performed on a sample of dynamic products. Moreover, interviews with users were conducted to verify some of the hypotheses emerged. Results show that dynamic products can communicate messages to users by many different sensory media, which can assume different meanings according to the source of the communication, its aim and the overall context. The work constitutes a starting point in the exploration of an emerging scenario for the digital communication from products to users.

Keywords: *Dynamic products; digital information; senses; aesthetics*

Introduction

The world of ICT has been expanding at impressive speed in the last few years, making new forms of communication emerge and spread.

Computers and digital devices, smart products and systems generate huge amounts of data, which require to be converted into readable messages for users (Barker, 2013). Traditionally, these digital data are translated and displayed by means of digital interfaces (e.g. screens or

* Corresponding author: **Sara Colombo** | e-mail: sara.colombo@polimi.it

displays), which exploit the alphanumerical and iconic language (Krippendorff and Butter, 1984).

This paper explores the possibility to communicate bits of information to users through an implicit language, based on dynamic changes in the product appearance, as alternative media to digital interfaces. Indeed, nowadays, the product's appearance, intended as the mix of product's sensory features (Desmet, 2012), can assume a dynamic quality: thanks to electronics, informatics and material technologies, the sensory features of products – e.g. shape, temperature, colour, light, smell, sound, etc. – can be controlled and modified in an active and reversible manner during the product life, changing over time. For instance, One (figure 1) is a kettle that informs that water is boiling by showing a coloured texture on its surface.

Therefore, on the one hand, an increasing amount of information is to be conveyed to users, on the other hand it seems that designers can rely on a new language to perform this communication: the one of product dynamic appearance. We believe dynamic sensory features might constitute, within bounds, a new language for the communication of information, replacing interfaces in search of a less complex, but potentially more engaging, kind of communication.



Figure 1: One kettle by Vessel Ideation. A texture appears on the surface when the water boils.

Background: Tangible Interactions and Ambient Displays

During the last decades, many approaches have been developed to find alternative and more tangible ways to interact with the digital world, by bridging virtual data (bits) to tangible artefacts (atoms) (Wiberg and Robles, 2010). The starting point of all these *Tangible Interactions* (Van Campenhout et al., 2013) was the assumption that traditional digital interfaces have a limit: the constraints of the two-dimensional screens, which lack the richness of the sensory and physical experience we have while interacting with the real world (Holman and Vertegaal, 2008).

Some examples of these directions are the works of Ishii and Ullmer (1997) (i.e. *Tangible User Interfaces*) and Van Campenhout et al. (2013) (i.e.

Tangible Interactions). Such experimentations demonstrate that visual screens are not the only way for users to access digital contents.

In the 90's, within HCI, a new research strand called Ambient Displays emerged (Matthews et al., 2004; Pousman and Stasko, 2006; Wisneski et al., 1998). In Ambient Displays *'information is moved off the screen into the physical environment, manifesting itself as subtle changes in form, movement, sound, colour, smell, temperature, or light'* (Wisneski et al., 1998). The focus was on finding more tangible and natural ways to convey information. However, scholars in this field did not pay too much attention to which sensory modality this information should be displayed by, and why it should be displayed that way. Nevertheless, the way information is displayed by the product, the sensory modality involved (sight, hearing, touch or smell) and the media adopted (light, colour, sound, fragrance, etc.) affect both the communication effectiveness and the user experience. Therefore, by taking the Ambient Displays approach as starting point, we intend to explore how information can be effectively displayed in more physical and sensory ways, by the product's dynamic features.

Informing by Dynamic Products

We define *'dynamic products'* objects showing dynamic sensory features that change proactively and in a reversible manner over time, activating one or more user's sensory modalities. Such products can be employed as alternative to the explicit communication performed by conventional interfaces. However, even though there is a growing number of examples of dynamic products (concepts, prototypes and commercial artefacts) designed to communicative purposes, there is still little knowledge on this area, which could support the designer's work.

Aims

This paper presents an analysis performed on a number of samples of dynamic products in order to understand their features and how they can convey digital information by different dynamic sensory media. The aim of the analysis was both to propose a descriptive framework for dynamic products and to generate preliminary insights on the roles senses and media can assume in the information transmission in different situations.

Methodology

The study investigates the area of dynamic products by two research actions. The first one consists of a case-study analysis on a number of samples of dynamic artefacts (Eisenhardt, 1989), aimed to generate a framework to analyse and categorize these products. Moreover, hypotheses on the role of senses are proposed. The second action consists of qualitative interviews with uninformed users, aimed at verifying some of the hypothesis emerged in the previous step.

The specific methodologies followed in the two research actions are described in the respective paragraphs.

Case studies analysis

The first research step consisted of a case-study analysis based on instances of dynamic products.

We collected 48 samples of dynamic products (in form of images and descriptions) among design concepts, prototypes and commercial artefacts, by reviewing journal articles, conference papers, universities' research projects, but also design contests and companies websites. Products were selected according to their novelty factor, meaning that we discarded objects using standardized dynamic signals, such as common warning lights or sound alarms of appliances. Moreover, products had to show a communicative intent, therefore dynamic objects having expressive or aesthetical purposes only were discarded.

By analysing these samples, we generated a descriptive framework for this category of artefacts.

A framework for Dynamic Products

The descriptive framework is based on three criteria, according to which dynamic products can be categorized: the *source* of the message, the *type* of message, and the output *sensory modality* (i.e. the sense which the message is displayed by).

The message source. Within our samples, dynamic products convey messages coming from three main sources:

The product itself: dynamic products inform about their own internal physical state (like temperature, figure 1), their functions, the action they are performing, their energy consumptions, etc.

The environment: dynamic products inform about states of the environment (e.g. the temperature of a room, the level of pollution in the air), which they are indicators of (figure 2)

A human: dynamic products can be used to convey messages coming from a person. For instance, they can be employed in distance communications, to replace the communication based on verbal language and screens (figure 3)



Figure 2 Wearable detect air by Genevieve Mateyko and Pamela Troyer. The jacket detects the pollution level in the air and displays it by light patterns. When the pollution is too high, the jacket vibrates to alert the user.



Figure 3 HugShirt by CuteCircuite. The shirt makes people send hugs over distance, by reproducing the tactile sensation of a hug on the person who wears it.

The message type. Since the messages transmitted by the samples cover a broad range of contents, it was not relevant to categorize them according to the content of the communication. The parameters we identified to categorize the messages concern the *aim* and the *quality* of the message.

According to the *aim*, dynamic products convey messages that can be:

Data-aimed. The message aims to share some data or knowledge with the user (for instance the emotion a person is feeling, figure 4, or the temperature of a room).

Action-aimed. The message intends to exhort the user to take a short-term action (for instance, it encourages the user to drink water, when s/he is dehydrated, figure 5).



Figure 4 *Smart Second Skin* dress by Jenny Tillotson. It senses the user's emotions and displays them by spreading different smells in the environment.



Figure 5 *I-Dration* by Cambridge Consultants. The bottle tells the user when s/he needs to drink water, by emitting a flashing blue light.

According to the *quality*, messages conveyed by dynamic products can be:

One single bit of information, like an on/off message. The product conveys only one gradient of the message by a unique change in the

product sensory features (a colour appearing/disappearing, e.g. ‘the water is boiling’, figure1).

Multiple bits of information related to multiple and variable qualities, or states, of the message source. Dynamic products can transmit gradual variations of an item (e.g. ‘your consumption is low/medium/high’, figure 6, or ‘the temperature is cold/warm/hot’), using different qualities of the medium (e.g. different colours corresponding to different temperatures, or different fragrances corresponding to different emotions, figure 4).



Figure 6 Flower Lamp by Interactive Institute, Swedish ICT. The lamp changes its shape according to the energy consumption in the household.

The output modality. The third criterion of our framework is the user’s sensory modality that receives the message. Dynamic products display messages by transformations in their sensory appearance, which activate one (or more) user’s sense. The possible transformations in the product appearance, grouped by the modality they activate, are summarized and represented by a Sensory Map (figure 7).



Figure 7 The Sensory Map displays the transformations that product sensory features can undergo. The media (changes in light, shape, colour, sound, etc.) are grouped according to the sensory modality they activate.

The resulting descriptive framework is summarized and visualized in figure 8.

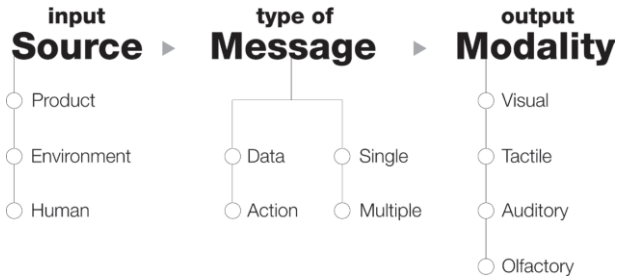


Figure 8 A descriptive framework for dynamic products.

The role of senses

The second step of the case-study analysis intends to investigate if senses assume different roles according to the source and the type of message conveyed. For instance, we analysed the senses used within each source category (product, environment and human), to see if they had different weights. When specific senses appeared more frequently in one source than another, we made hypothesis about the reasons for this discrepancy.

Message Sources vs sensory Modalities

In order to explore the relation between the *senses* and the *sources*, we grouped together the instances related to each sensory modality in the categories of Product, Environment and Human (figure 9). The frequency of the senses within each category is summarized by the graph in figure 10.

	sight	touch	hearing	smell	
product	9 	0	3 	0	12
environment	17 	5 	1 	3 	26
human	6 	6 	0	1 	13

Figure 9 The table puts in relation the source of the message to the sensory modality by which the message is displayed. Pictures of the case studies are reported together with the number of instances.

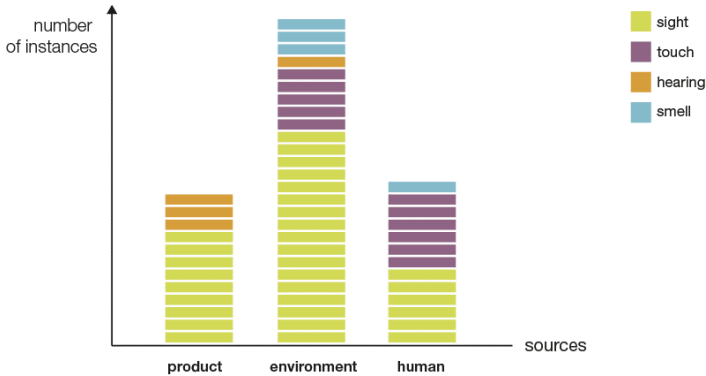


Figure 10 The graph visualizes the frequency of use of the sensory modalities within each source category.

The first finding is that all the sensory modalities are used as channels to communicate information in form of sensations. Even smell, the most overlooked sense in the design of products, has been used to convey information. In the environment category, we can find samples addressing all the four senses, even though with different weights: sound is the less used medium, while sight is the most frequently used sense.

When dynamic products convey information coming from the *product* itself, only sight and hearing are employed. This might be due to the fact that instances in this category are all common products, to which a communicative function is added. These dynamic products are not typological innovations (Rampino, 2011), but products consistent to their category archetypes, to which a layer for the communication is added (e.g. product One in figure 1 is an ordinary product modified to convey information about its function in a poetic way). Thus, the easiest way to achieve the goal is to work on the surface of the artefacts (e.g. by adding lights or thermochromic inks on the surface) and/or to insert a sound.

When the message comes from *humans*, touch gains a great importance, reaching the one of sight. On the contrary, hearing and smell are almost completely absent. This is an interesting finding, whose reason might be that the concept of intimacy which characterizes human communication may be better conveyed by a sensation that recalls the idea of closeness and intimacy (like touch). *'The proximal nature of touch allows for the creation of private displays. This is an important affordance when information is confidential or privileged'* (Jones and Sarter, 2008). Moreover, touch is the

first language we learn and has deep emotional implications (Gallace and Spence, 2010).

Message Aim vs sensory Modalities

The second step of this analysis puts in relation the *aim* of the message (data vs action) to the output modality. The hypothesis that guides this analysis is that the stronger the user is activated by the sensation, the more effective the action-aimed information might be. It means that, to induce the user to act, the medium should be perceived as more intrusive and compelling, also according to the urgency of the required action. Again, the samples were grouped according to the senses and the aim of the message they convey (figure 11) and results are summarized by a graph (figure 12).





	sight	touch	hearing	smell	
data	<p>25</p> 	<p>7</p> 	<p>2</p> 	<p>3</p> 	37
action	<p>7</p> 	<p>4</p> 	<p>2</p> 	<p>1</p> 	

Figure 11 The table puts in relation the aim of the message to the sensory modality by which the message is displayed. Pictures of the case studies are reported together with the number of instances.

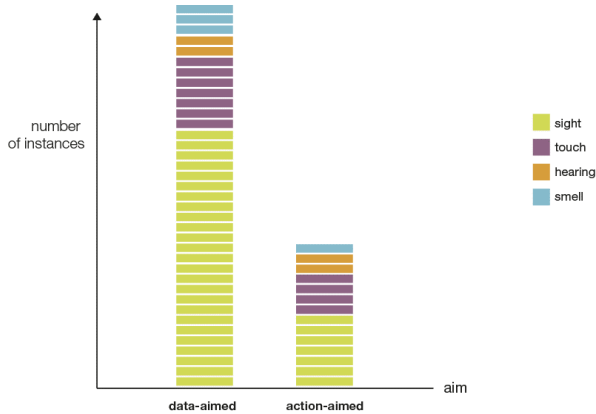


Figure 12 The graph visualizes the frequency of use of the sensory modalities within each message aim category.

The first evident result is that sight is clearly the most used modality in data-aimed messages. In action-aimed messages, results are more equally spread among modalities, and the difference is not significant. By comparing the two categories, no evident results emerge with respect to the role of the different sensory modalities. Indeed, it seems that senses have not different roles in conveying data-aimed rather than action-aimed messages.

However, by analysing the single media instead of the sensory modalities, some elements can be stressed. In touch, vibration is used just in the case of action-aimed messages (e.g. Wearable Detect Air, figure 2) while pressure and temperature are used to convey only data-aimed information. Colour is almost absent in action-aimed information as well. Again, it would be interesting to deepen the analysis of this finding, since it might mean that colour is not as efficient as light or vibration in rapidly grabbing the attention of the user or in exhorting him to take an action.

Message Quality vs sensory Modalities

This last analysis compares the use of senses in conveying single rather than multiple information (figure 13 and 14). The initial hypothesis was that some sensory media (e.g. vibration or pressure) can be intrinsically more suitable to convey single rather than multiple and variable information.

From bits to atoms: sensory displays for digital information


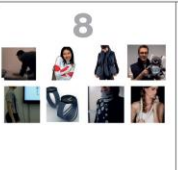



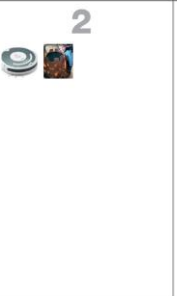
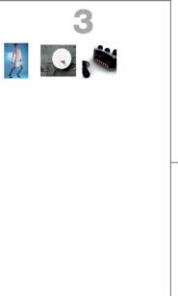
	sight	touch	hearing	smell	
single	10 	8 	2 	1 	22
multiple	22 	3 	2 	3 	29

Figure 13 The table puts in relation the quality of the message to the sensory modality by which the message is displayed. Pictures of the case studies are reported together with the number of instances.

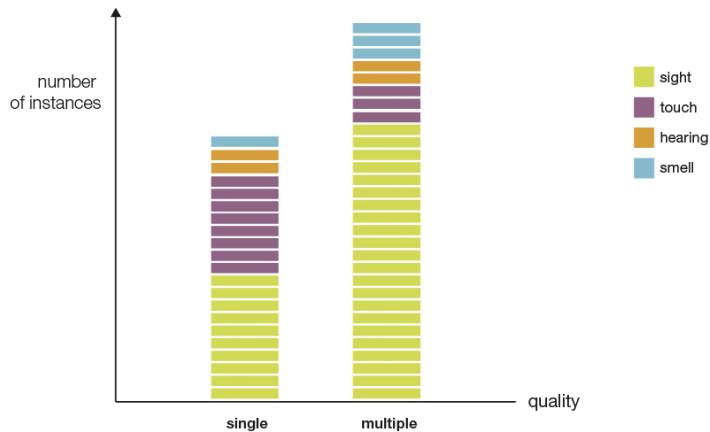


Figure 14 The graph visualizes the frequency of use of the sensory modalities within each message quality category.

Results show that sight is mostly used to display multiple information. Indeed, it is our most precise sense and it allows the user simultaneously receive and compare information. For instance, one can easily compare

different colours or light intensities. Visual media used to convey multiple information comprise light (mainly changing in colour, but also projecting different patterns, or having different intensities, or pulsating at different paces) and colour changes, but also shape transformations. In absolute, colour change is the main medium adopted to convey multiple information.

Touch is employed more to convey single rather than multiple information. This finding might be connected to the fact that touch is perceived with less accuracy than other senses. Especially vibration, even though it can have different intensities, seems to be less suitable to convey different qualities of an event, while it is used much more to convey single information, like simple alerts.

Smell is mainly used to convey multiple rather than single information, adopting different flavours. Interestingly, the analysed dynamic products never use changes in the smell intensity, but only adopted different fragrances.

User interviews: using senses to different aims

In order to confirm or refute some of the insights emerged in the previous analysis, interviews with users were accomplished on a selected number of samples. The overall interviews aimed at investigating many aspects of the interaction with dynamic products. As there are few dynamic products available on the market, for most are in the form of concepts or prototypes, a direct interaction turned out to be unfeasible to set up. For this reason, and since the aim was to perform a preliminary explorative investigation of users' experience, we decided to set up semi-structured qualitative interviews (Drever, 2003) supported by pictures and brief explanations for every product. The results discussed in this paper only concern the relation between the sensory media and the message aims. The intention is to verify if certain sensations might be more effective than others in conveying action-aimed rather than data-aimed information, as the case-study analysis suggested.

Samples selection

For the interviews, 15 dynamic products were selected. As many products adopted similar stimuli to convey the same kind of message, we decided to reduce the number of products to test. We selected the products maintaining the highest variety among the samples, according to the three criteria identified in the first research step. For this reason, within each source category (product, environment and person), we selected products

conveying both exhortative and cognitive messages. Within each sub-category (e.g. products conveying exhortative messages coming from environment) we picked only one product for each different sensory stimulus adopted.

Interviews structure and performance

Five users were involved in the interviews (2 males and 3 females) from an age of 19 to 60. Each user was asked to analyse three products randomly chosen among the selected ones.

The interview consisted of two sections of 5 questions each. The questions were used as a track by the interviewer, and aimed to lead to an open discussion between the interviewer and the user.

The entire interviews were recorded and subsequently transcribed. Memos were written during the interviews, to note additional details. The recordings and memos were analysed following an approach based on Strauss and Corbin's model, already used by previous studies in the field of user experience (Khambete and Athavankar, 2010). The findings were extracted through a coding process aimed at identifying recurrent concepts, which were then clustered into categories based upon similarities.

Results

From the interviews analysis, it came out that specific media have a strong alarming and activating power. In particular, users interpreted vibration, sound and flashing light as conveying urgent information, which required an immediate action:

'I would move away quickly, because I would be afraid. More with vibration than lights, definitely, because it [vibration] is more immediate, you feel it on your body [...]. Would it [the product] have only lights, I would resist longer. Vibration alarms and exhorts; light warns' (User 03 on Wearable DetectAir, figure 2). These results are confirmed by some studies that investigate vibration as a powerful medium for attention allocation (Hattori et al., 1987; Sklar and Sarter, 1999). Light and sound were evaluated differently as well:

'Sound activates more than light, it would make me react' (User 04)

In other cases, when the message wanted to be exhortative in the intention of the designer, but it was conveyed by other stimuli, like a change in colour or visual texture, the information was interpreted as just suggesting or inviting. When talking about Disappearing Pattern Tiles ,

shower tiles whose decoration disappears when the hot shower lasts for too long (Backlund et al., 2007), a user stated:

'I would try to go faster, but the stimulus itself is not asking me to accelerate, the message it conveys do. The change itself does not stimulate me to react [...] It only suggests and warns.'



Figure 15 Noi by design-people is a concept for maintaining indoor climate in private homes. The more polluted the air, the denser the surface texture becomes.

In the case of the texture change in Noi (figure 15), a subject affirmed that:

'even though the message is exhorting [because it requires to do something to improve the quality of the air], the sensation is not alarming or exhorting. It is instead suggesting.'

Colour changes were evaluated as appropriate to convey data-aimed information:

'it [colour] suggests and warns. Suggests that it's ready, and warns that it's time to cook. It is a low level of exhortation, because if you don't put the food inside, it will not go crazy. The pot is saying 'if you care, I'm already ready to start' (User 01 on Coral Cooking, figure 16) .



Figure 16 *Coral cooking* by William Spiga and Juliana Martins is a pot whose texture changes from blue to red to display changes in the internal temperature, so that the user knows when it is hot enough to cook.

Also still light was not interpreted as exhorting. Differently, a flashing light was perceived as exhorting and alarming:

'Seeing an object lighting up does not suggest me to do anything. It attracts me, but it is not exhorting' (User 02)

'I would not use a lamp for alarming; an alarm should be direct and unavoidable. However, was the light flashing, it would be effective in alarming' (User 04)

However, if the user is already aware s/he has to perform a very important task, the medium can also be less strong to obtain a hortative effect. In this case, the dynamic product could be just a reminder. For instance, in the case of a pill-box that lights up when it is time to take a pill, a still light was considered enough to exhort the user to take the pill (note that the interviewed user had to take different pills during the day, so he was sensible to the issue):

'the light exhorts, because it is reminding that you have to do something. But it is more a warning, not an alarm. It does not alarm you, it reminds, but by reminding, it also exhorts, because you cannot choose, you know you have to take the pill, it is too important'. (User 04)

The importance of the context

When asking the users to evaluate the effectiveness of the communication performed by dynamic products, they expressed some concerns regarding the choice of certain stimuli, according to the context of use. In some cases, the users evaluated the choice of one sensory modality as wrong, with respect to the product's context of use.

An example is the I-dration bottle: the subject considered a pulsating light difficult to perceive while running, especially outdoor, because the light

would not be visible enough. The user stated that a tactile stimulus, like vibration, would be more effective, because unavoidable.

In conclusion, even though a message is conveyed by the most effective medium, according to its aim, the communication may still fail because of the context. It came out that the interaction with a dynamic product, being based on senses, must always take into consideration the scenario it will take place in.

Dynamic products vs interfaces

Users were also asked if they would prefer to receive the same message through a verbal or numerical language. In none of the cases, they expressed the desire to replace the communication dynamic products performed with a traditional interface. In fact, they stated that the experience with dynamic products was more engaging and pleasant and the message more immediate, evident and discrete. In more than half of the cases, they argued that they would appreciate a more detailed message, by incorporating or associating an interface to the dynamic product. Nevertheless, they would never replace the direct sensation with the interface.

This is a very interesting result, for it highlights that users are minded to lose some details in favour of more immediate sensations, less precise but more surprising; in other words, in favour of the experience the products create.

Discussion

Through the process of collecting and analysing samples, it emerged that all the four sensory modalities (smell, sound, sight and touch) are adopted in the communication from products to users in our samples, often with different roles and meanings according to the situations in which they are employed (different sources or different kinds of messages). However, sight is the most employed sense in each category, no matter what lens we use for the categorization of dynamic products (source or type of message). The only exception is the human category, where visual and tactile media have the same importance. These results confirm the dominance of sight in our sensory perception, even though the presence of many designs exploring different senses is encouraging for the investigation of novel communicative sensory media.

Not only has each sense specific features and roles, but also some media belonging to the same sensory category are used differently according to the source or the type of message. For instance, vibration is used for single and action-aimed messages coming from environment, while pressure is mainly used for data-aimed messages coming from human. How sensory media can be used in different situations and to diverse aims is definitely a fruitful topic to investigate, since, as Schifferstein and Cleiren (2005) put it, *'each modality picks up a different type of information'*, both at the perceptual, cognitive and experience level. This study supports the hypothesis that this statement is valid also for dynamic sensory features.

Another important element to consider when designing dynamic products, which emerged from the interviews, is the *behaviour* of the sensory medium. For instance, if the dynamic medium is the light emitted by a product, it can be both still or pulsating: this difference is not secondary since, from the analysis, it emerged that still light is more frequently used to convey data-aimed messages, while pulsating light is used in action-aimed messages (within the category of person). Moreover, vibration can be used both to convey a sense of urgency and to represent caution, according to its frequency and intensity (Jones and Sarter, 2008).

What emerges from the users' responses is that the message is strongly affected by the sensation it is conveyed by. The level of urgency of the information and its pushing towards action depends on the nature and behaviour of the medium by which the message is transmitted.

Conclusions

Results emerged from the interviews and the case study analysis stressed the importance of analysing the role of each sensory modality and medium in the communication performed by dynamic products. As each sense has its specific features, investigating the potentialities and limits of senses in specific situations is definitely a direction future research should follow. However, it also emerged that the competences of design are not enough for a deep and trustworthy exploration of such issues. Additional competences and approaches, like perceptual psychology, neuroscience and HCI may advance knowledge in this field, also giving designers the bases for a more informed design process. Nevertheless, general experiments carried out so far by these disciplines do not account for an exhaustive overview of the features of different sensory perceptions (how users perceive shape changes, movements, vibration, colours, etc.) especially when they are

dynamic. That means that this area of design would highly benefit from more focused investigations of the sensory perception, also by designing appropriate experiments together with experts from other disciplines.

References

- Backlund, S., Gyllenswärd, M., Gustafsson, A., Ilstedt Hjelm, S., Mazé, R. and Redström, J. (2007) *Static! the aesthetics of energy in everyday things*. Paper Presented at the Proceedings of Design Research Society Wonderground International Conference.
- Barker, H.R. (2013) *Hive-Design for Big Data*. Paper Presented at the Proceedings of the 8th International Conference on Design and Semantics of Form and Movement, Wuxi.
- Desmet, P. (2012). Faces of product pleasure: 25 positive emotions in human-product interactions. *International Journal of Design*, 6 (2), 1-29.
- Drever, E. (2003) *Using Semi-Structured Interviews in Small-Scale Research. A Teacher's Guide*. Edinburgh: Scottish Council for Research in Education.
- Eisenhardt, K.M. (1989) Building theories from case study research. *Academy of Management Review*, 14 (4), 532-550.
- Gallace, A. and Spence, C. (2010) The science of interpersonal touch: An overview. *Neuroscience and Biobehavioral Reviews*, 34 (2), 246-259.
- Hattori, H., Matsuura, Y., Narumiya, K., Araki, K., and Ohnaka, H. (1987) Effect of vibration stimulus in lowering alertness levels of drivers. Paper Presented at the International Pacific Conference on Automotive Engineering, Melbourne, Australia.
- Holman, D. and Vertegaal, R. (2008) Organic user interfaces: Designing computers in any way, shape, or form. *Communications of the ACM*, 51 (6), 48-55.
- Jones, L.A. and Sarter, N.B. (2008) Tactile displays: Guidance for their design and application. *Human Factors: The Journal of the Human Factors and Ergonomics Society*, 50 (1), 90-111.
- Khambete, P. and Athavankar, U. (2010) Grounded Theory: An Effective Method for User Experience Design Research. *Design Thoughts*, (August), 11-24.
- Krippendorff, K. and Butter, R. (1984) Product semantics: Exploring the symbolic qualities of form. *Innovation: The Journal of the Industrial Designers Society of America*, 3 (2), 4-9.
- Matthews, T., Dey, A. K., Mankoff, J., Carter, S. and Rattenbury, T. (2004) *A toolkit for managing user attention in peripheral displays*. Paper

Presented at the Proceedings of the 17th Annual ACM Symposium on User Interface Software and Technology.

- Pousman, Z. and Stasko, J. (2006). *A taxonomy of ambient information systems: Four patterns of design*. Paper Presented at the Proceedings of the Working Conference on Advanced Visual Interfaces.
- Rampino, L. (2011) The innovation pyramid: A categorization of the innovation phenomenon in the product-design field. *International Journal of Design*, 5 (1), 3-16.
- Schifferstein, H.N.J. and Cleiren, M. (2005) Capturing product experiences: a split-modality approach. *Acta psychologica*, 118 (3), 293-318.
- Sklar, A. E. and Sarter, N. B. (1999) Good vibrations: Tactile feedback in support of attention allocation and human-automation coordination in event-driven domains. *Human Factors*, 41 (4), 543-552.
- Van Campenhout, L., Frens, J., Overbeeke, C., Standaert, A. and Peremans, H. (2013) Physical interaction in a dematerialized world. *International Journal of Design*, 7 (1), 1-18.
- Wiberg, M. and Robles, E. (2010) Computational compositions: Aesthetics, materials, and interaction design. *International Journal of Design*, 4 (2), 65-76.
- Weiser, M. and Brown, J. S. (1996) Designing calm technology. *PowerGrid Journal*, 1 (1).
- Weiser, M. (1993) Hot topics-ubiquitous computing. *Computer*, 26 (10), 71-72.
- Wisneski, C., Ishii, H., Dahley, A., Gorbet, M., Brave, S., Ullmer, B. and Yarin, P. (1998) *Ambient displays: Turning architectural space into an interface between people and digital information*. Paper presented at the Proceedings Of the First International Workshop on Cooperative Buildings.



The Big Data as ‘presentification’ of knowledge

Sabino Di Chio*

Università degli Studi di Bari ‘Aldo Moro’

The rise of Big Data prompts the Sociology of Knowledge to wonder about a predictive model in which the forecasting responsibility slides from the human being to the artificial intelligence, the method abandons theories to correlations, the purpose ceases to be the acceleration in the discovery path and turns into planning of algorithms. The hypothesis advanced in the paper is that Big Data can be analyzed as a form of ‘presentification’ of knowledge in consonance with the change in the temporal sensitivity that affects western societies over the past thirty years. It seems that the insatiable demand for data doesn’t only satisfy the need of forecasting but also the one of legitimation of cultural constructions, unanswered claim in the ‘absolute present’. Social acceleration inhibits the vision of the future that, during Modernity, allowed people to transcend the present in order to improve it on the incentive of project imagination. In lack of time for planning, Big Data succeed in allowing decisions in urgency. The structural uncertainty is faced by an exhaustive reading of the past that actually becomes an automatic guide. By legitimizing the present through the past yet, Big Data predictive models risk to promote the conservation of the status quo.

Keywords: *Big Data; modern knowledge; extended present; social acceleration; legitimation*

Introduction

‘The problem with that is that sometimes you make an assumption that today is the same as yesterday’. (L.A. cop dealing with Predictive Policing program; Horizon, The Age of Big Data, 2013)

Datification is an explosive process developing, like any other technological innovation, out of a widespread need that deeply permeates contemporary society, that is to grant forecasting the highest level of

* Corresponding author: **Sabino Di Chio** | e-mail: s.dichio@scienzepolitiche.uniba.it

accuracy possible. With regard to this, data collection and processing systems seem like an 'intellectual technology' (Carr, 2008) with a blasting potential yet fully compliant with the modern cultural *habitus* because it faithfully reproduces some of its distinctive features: trust in technique, accumulation anxiety and observation of the future.

The unusual amount of data that is nowadays available for processing brings about however a radical discontinuity in the identification of the author, purpose and method of forecasting. In classical modernity, 'rational prognosis' (Koselleck, 2004, p. 19) is a task pertaining to man free from supernatural protection, who sets his world transformation projects above reality. A wide set of hypotheses and assumptions supported by accumulation systems, reservoirs of notions, experience and money that compensate the loss of confidence in the traditional 'cultural moorings' (Lübbe, 2009, p. 162) to absorb the permanent growth of the innovation rate in living conditions. The author of forecasting is thus the rational subject using a modern scientific method, coded by Galileo and Bacon and built upon the formulation of hypotheses regarding cause and effect relationships. The purpose is the acceleration of human activities meant as reduction of the time difference on the path separating experience from vision, the present of planning from an undoubtedly better future, which is intrinsically different from any other past experience.

The rise of Big Data prompts instead the Sociology of Knowledge to think about a predictive model of knowledge in which the forecasting responsibility slides gradually from the human being to the artificial intelligence, and the method abandons any explanatory claim to become a correlation among variables that do not depend on any theoretical cage (Mayer-Schönberger and Cukier, 2013, p. 50; Anderson, 2008); finally, the purpose ceases to be the acceleration in the discovery path and turns into planning of algorithms, able to prevent or react in real time to the different desynchronized stimuli carried by the future.

The form of life that requires and uses Big Data is therefore a social system still committed to the reduction of the distance separating experience from vision, yet by reversing the course of the process, that is by having the vision flattened against the experience, so that the future will look neither scary nor surprising, as it is available in the present in the form of the most probable scenario. It almost seems that the insatiable demand for numbers doesn't only satisfy the need to have a rapid and accurate forecasting tool but also the need to rely once again on an authoritativeness able to give depth to unsteady 'absolute present' (Heller, 1999) of the flows.

An objectivity that deserves the name of science because it is able to legitimize cultural constructions notwithstanding the deterioration of the human reason predictive skills. The human reason is unable to build shared and consolidated signification systems because it is incompatible with the series of instant decisions constantly redefining the survival threshold in the global competitive context. Right there, where nobody can afford the highly human luxury of making a mistake, having an illusion or having to wait.

In order to test this hypothesis, it is necessary to identify the factors that brought about the decision legitimization vacuum, which is actually a distinctive feature of late modern society, currently filled by resorting to the serendipitous oracle represented by databases. The origin is to be found exactly in the outcome of the aforesaid acceleration on the path separating experience from vision, that has been defined as the intimate purpose of modern knowledge. By stating that *'late modernity is nothing more than modern society accelerated (and desynchronized) beyond the point of possible reintegration'* (2009, p. 97), Hartmut Rosa points out that in the 1990s a saturation threshold was crossed: past this threshold, the speed of interrelation rhythms has affected the structural elements of symbolization and thought formulation, as well as creating more difficulties in knowledge transmission.

The 'presentist' society does not allow the consolidation of certainties: the challenge of creating an 'extended present' (Nowotny, 1993, p. 52), that has seen the involvement of societies at the end of the 20th century, in the acrobatic attempt to join the advantages of speed with the short term frenzy, clashes against the *malaise dans la temporalité* Zawadzki talks about, *'notre extraordinaire faiblesse symbolique à nommer le devenir collectif'* (2002, p. 12), the unusual trouble of seeing yourself in time and joining as individuals the plot of a collective time.

Human being, distance and completeness

According to the definition provided by Berger and Luckmann (1966, pp. 110-111), legitimation is a 'second-order objectivation of meanings'. It is a task pertaining to the big theoretical systems that protect institutions (first-order objectivations) from the implausibility risk that the flow of time lays upon each cultural construction, fatally eroded by the endless flow of experience. Observed by the Sociology of Knowledge point of view, science, religion and myth fulfil the same need for a sense, bridging the gap created by the questions that the institutional order is unable to reply to, 'by

ascribing cognitive validity to its objectivated meanings' (1966, p. 133). The legitimation system is thus responsible for directing knowledge and selecting the unshakable contents that are labelled as 'truth' by a specific social group. In modern society, secularization has established the metaphysical Grand Narratives listed by Lyotard (1979), namely Enlightenment, Idealism and Marxism, as symbolic universes. It is impossible here to delve into the huge differences among traditions, yet only understand their common feature: the focus on the centrality of man in creation.

The modern man, who trusts his rationality, throws himself in the quest of space and future by resorting to cognitive schemes that allow the organization, forecasting and identification of regularities through the accumulation of knowledge. Culture conveys this value horizon and ceases to be, in Bacon's own words, 'reverence for ancient wisdom' to become a classification of experiences useful for the project. Facing the growth of uncertainties, due to the melting down of thousand years old religious, geographical and technical certainties, cultural construction turns into the scaffolding to lean upon in order to arrange the formless mass of the new. 'Wounded', as suggested by Agnes Heller (1999) by the contingency discovery, that is by realizing he has no heavenly protection to cling to and that he's the one responsible for his own fortunes on earth, the subject subordinate action to the mechanisms of reasoning.

Brunelleschi's immortal work is considered by several analysts as the conventional turning point (Panofsky, 1991; Laidi, 2000, p. 45); he is actually the inventor of *perspectiva artificialis*, a technical trick that allows the drawing to reproduce spatial depth and therefore to visualize countless new spaces, able to relativize current time and force the comparison with the potential change. Whereas in traditional societies the individual perceived himself as a two-dimensional object of God's vision, with modern age the fundamental point of view coincides with the human eye. The infinite world is so entangled in a geometrical grid having the same depth as the eye, that it spreads vanishing points on the scene, straight lines that suggest an equal number of possible directions to take.

As far as this undertaking is concerned, cultural mediation undergoes a substantial statute change. The human being has always needed this change to ensure its survival, or else, as suggested by Crespi (1982, p. 16), the symbolic order is the birthplace and playground of conscience. Crespi defines the latter as the 'place of difference', that is the human prerogative to contemplate the uncertainty of life and to try and remedy it by resorting

to the certainty of behavioural models, values and rules, even in the awareness of the arbitrariness of this attempt. Free from binding instinctual codes, constantly subject to the danger of death, pain and living nonsense, the individual finds in symbols a 'con-sensus' (1982, p. 15), a network of shared correspondences among images and meanings that ensures a predictability margin of other people's actions and enables the construction of society as institutional order. Therefore, culture tries to '*restore an automatism similar to the instinctual one, yet it always fails to fully do this because of its reductive mediation nature*' (1982, p. 15).

The difference introduced in people's conscience by modern age is the obligation to directly correlate human activity with the restoration of the original unity between certain and uncertain. Man is persuaded to be able to attain through work a dimension in which global comprehension of life is as easy as replying to a primitive instinctual command. As explained by Georg Simmel, culture aims to be 'the path of the soul to itself', the 'way that leads from the closed unity through the unfolded multiplicity to the unfolded unity' (1968, p. 29), a path starting from the simple unity of an identity that fully coincides with the instinctual imperative and leading to a complex unity of the soul that is achieved after facing the plurality of experience and letting the mind express its capabilities by means of the temporary support offered by products of human ingenuity.

Completeness is no longer in the 'beyond', but tomorrow. The road to achieve completeness is built upon linear cause-effect relationships that reproduce the cognitive distance among events, delivering them from their apparent casualness and unintelligibility. The scientific revolution of the seventeenth century, the Enlightenment as well as the two industrial revolutions set the steps of a technical devices specialization process in terms of occupied space and saved time, as well as the corresponding refinement of the legitimizing philosophical equipment, under the banner of ideologies that theorize the need for progress, which turns from wish into law by absorbing the voluntary mobilization of individuals along increasingly prearranged and required paths.

The earth, *tabula rasa* of the project, lubricated by the integrated rationalization system, consisting of the liberal State and fordist industrial organization, is the testing ground for the dictate to increase speed and for the acceleration as 'constitutional aspect' (Rosa, 2009) of 20th century modernity, which introduces the obligation to do things earlier deep into human consciousness. The processes of industrialization, bureaucratization and urbanization involve the transfusion of an increasingly higher number of

physical and psychic resources in the acceleration system, which are spent to sustain the performance capabilities of cultural mediation structure that gradually replaces the legitimising goal of achieving completeness with the self-serving goal of self-preservation.

The erosion of the legitimizing protection

Western history involves therefore a progressive acceleration in institutional contexts designed out of perspective mental schemes, leaning towards the attainment of completeness. The secret of success in the modern way of acquiring knowledge lies in its ability to contemplate the three time dimensions (the past of accumulated knowledge, the present of decision and the future of vision) with a dynamic tension that extends the time horizon of the action, the latter referring to a cognitive infrastructure that allows a homogeneous group to conceive duration and let the individual past time join a meaningful and coherent plot (Di Chio, 2013). The reduction of durations, meant as abolition of distances between action and results, wishes and fulfilments, is the common trait of great narratives, the common sense that fuels the universal meaning of emancipation.

In the 70s this tension expired though when the Grand Narratives, in charge of preserving its boundaries, experienced a downfall due both to the oppressive outcomes of the totalitarian regimes inspired by them and to the explosion of the inner contradiction in a cognitive model that feeds itself in duration, yet theorizing its abolition. The search for continuous innovation actually triggers creativity, yet it denies at the same time the value of what has already been created. This model acts like a grip the individual finds itself caught in: on the one hand, the model prompts the individual to regularly channel the efforts into the great bureaucracies, on the other it instils an existential dissatisfaction made endemic by setting goals always some metres ahead. Whereas acceleration appears as 'the abbreviation of the periods which allow for a homogeneity of experience' (Koselleck, 2004, p. 242), every knowledge form turns out to be limited, temporary, headed towards devaluation first and then sinking into oblivion. Innovation and obsolescence tie to the 'autarchic present' (Laidi, 2000) the time frame of late 20th century societies, which increasingly relies on time suppression techniques: financial economy, flexible accumulation, fashion and real time communication are interaction environments in which schemes, theories and information 'last' always less, reduce the validity range of their contents and alternate always more rapidly, until they take on the temporary form of

a flow. Man is no longer asked to figure out the future but to sense when it's the right moment, react immediately to market impulses and foresee expectations.

The combination of acceleration and short term duration prevents the consolidation of meanings: whereas modern knowledge considered institutions as the place to reorganize technical functions and collective meanings (Magatti 2009, p. 94), the 'extended present' described by Helga Nowotny (1993) relies instead on the confidence in individual consciousness as the only valid control centre. The extreme rationalization of bureaucratic and production procedures, as well as the ensuing specialization of competences and scopes, encourage the gradual drifting of the decision-making moment from collective structures, increasingly perceived as cumbersome and clumsy, to the more rapid and flexible shoulders of a subject perceiving itself by now as totally emancipated, in control of its time and free to decide every life detail by resorting to the power of choice.

One of the aspects of the 'time-space compression' ideology (Harvey, 1989) has been the crushing of Sartre's *projet de vie* along a jagged path consisting of countless everyday crossroads, through which the individual is expected to outline its identity by facing an endless series of decision. In a surrounding reality presented by the logic of consumption as a continuously available scenario for the individual, the latter is required to perform the task of pulling out the greatest potential from every moment, no longer conceiving life direction according to a general plan or in the light of the final destination, yet day by day, like an endless sequence of fully lived moments. Given the groundlessness of prearranged directions, everyone is entitled to outline one's own life path by following just the command of personal dispositions, yet paying the bill in taking on the full responsibility for the partial and final outcome of the attempt to abide by the performance imperative.

The representation of existence as a series of highly intense episodes prompts the individual to pursue the maximization of what we might call 'emotional profit', the asset of an existential balance drawn up in increasingly shorter time frames. Like the 'impatient capital' of the shareholders (Harrison 1994, p. 214), the individual carries out a distortion of preferences that anchors action to the achievement of an immediate benefit, by reviewing any form of obligation, constraint or postponed enjoyment as heavy hindrances preventing personal fulfilment.

A self-confident individual plunges therefore into the world of choices to freely embark on a path that will bring about a stable happiness condition,

crossroad after crossroad. This is the main narration that comes through the downfall of Grand Narratives. Facing the increased number of options, on the one hand there's a shrinking of the amount of time useful for a comprehensive analysis of the alternatives, on the other the individual is totally responsible for the consequences. What are the criteria to be used then in order to choose?

The scientific nature of status quo

The *malaise dans la temporalité* lies thus in the impossibility to substantiate knowledge and the decisions wrapped up in the present. The reduction of time frames prevents us from conceiving the 'second moment' that protects significations from the risk of implausibility. The autarchic present has nothing to do with light-heartedness. Its imperatives are as strong as the previous ones, yet their observance is carried out as matter of urgency (Aubert, 2003), never meeting the need for a sense.

The need for datification is primarily driven by emergency: velocity is one of the three Vs along with volume and variety, that are commonly associated with Big Data. The correlation of 50 million queries with ministerial data allows Google Flu Trends to follow the evolution of flu epidemics. Yet, the worthy outcome of this health mission aiming to understand and wipe out viral diseases also reveals the 'anxious character of our way of life', the 'cold paranoia' of observation and prevention (Cassano, 2001, p. 39) of a social context that can't let a disease paralyse the delicate synchronization system every role is stuck in. Similarly, Google Ground Truth Project provides a map of the territory that improves the efficiency of the transport system, yet trapping the individual even more in the net of time pressure (Madrigal, 2012). In trade, Amazon, Walmart or Datalogix collect and keep the information concerning the habits and interests of the users to customize the offer, because a wrong investment is enough to cause a collapse in an unstable market that narrows down risk margins.

As of today, this structural uncertainty shows two possible answers: on the one hand, the reliance on randomness (the evidence is the recent emphasis on gambling and tempting fate), on the other the frenetic pursuit of determinism somehow able to relieve the burden of choice. Big Data step in to mitigate this bewilderment since they are able to integrate randomness contemplation in a legitimising device that brings the most probable scenario close to certainty.

Like any other knowledge method, the forward-looking analysis carried out by means of Big Data is useful to reduce the amount of uncertainties uncompromisingly associated with every kind of perspective. Datasets ensure the diachronic measurement of an event as a whole, by adding to the full record of what happened in the past the real time introduction of new information collected by the increasingly widespread sensors connected to the net. The analyst's task is to draw two or more meaningful correlations from the figures, able to reveal regularities otherwise invisible to the human eye. Built upon a broad and varied observation range such as never before, these regularities create a new objectivity that claims to be 'scientific', that is free from the fallacy that fatally corrupts the individual eye. A closer look to how Big Data Companies introduce themselves to their site visitors will be enough: the Evolv start-up (Evolv, 2014) and Kenexa (Ibm, 2014), an employee selection and training company recently acquired by Ibm, offer their customers an emerging discipline called workforce science, which promises to minimize the uncertainty related to the actual efficiency of a newly recruited collaborator and to improve the performance monitoring of the already used human resources (Lohr, 2013). Winton Capital, the financial company founded by the mathematician David Harving, assures investors to assist them in their choices by analysing data with an empirical scientific approach and rational inferences (Winton Capital, 2014) because decisions can't be taken *'on the basis of human feelings and how you feel today, and what you heard from your friend and so on but really bringing in to bear the scientific method much more'* (Horizon, The Age of Big Data, 2013). The DataXu company, founded by aerospace engineers, suggests the introduction of science in marketing by using the 'decision theory' in order to foresee consumers next purchase because, despite the digital era, the business sector is 'still operating with manual solutions based on intuition' (DataXu, 2014).

The heart of the modern scientific method was deeply human and social: as pointed out by Cassano (1989), the scaffolding of linear and publicly manageable procedures unexpectedly hid a leap of faith and a social aspect, namely two profession of awareness of the knowing rational subject limits. The first was rationalist metaphysics, the shared belief that man should solve the incognizability of the world, the almost mystical confidence in the possibility that the knowledge undertaking may one day be successful even if it's constantly hindered by the dullness of the world. Achieving objectivity, that is abolishing the distance between subject and object, or at least dream about doing it while living the journey of life. The second was the temporary

and fleeting agreement of a social group, the too human approval of the scientific community, the only decisive factor able to turn a sentence into a 'truth'.

The scientific nature of Big Data is instead disenchanting and emancipated by the human being. It acknowledges the structural disorder of reality, yet it doesn't aim to reduce it; the desire is to have it X-rayed and then turn it into an immediately perceivable number to drive the decision-making process. The uncertainty of the present is reassured by overlapping such an exhaustive reading of the past that actually becomes a guide. The data-driven subject doesn't have to join his fellow man in order to bear the risk of hypothesis anymore. The algorithms allow the fulfilment of the forbidden dream of immediate knowledge without the effort of symbolic mediation, the longing for the automatism similar to the instinctual mechanism human culture ideally leans towards, as mentioned in the second paragraph. Artificial intelligence validates decision thanks to the amazing power of technology and to the unbridgeable disproportion among information systems and human data processing capabilities. And knowledge will be followed by 'wisdom and clairvoyance'. *'At some point in time, the system will be so smart that it will predict problems and correct them before the user realizes that there was something wrong'*, as stated by the process management director of a market leader shipping company (Mayer-Schönberger and Cukier, 2013, p. 89). Utopia means today exceeding the human and delegate existence to automation.

The demand for data and the capabilities of the Big Data approach in solving some of the problems that have long been tormenting mankind (from genetic mapping to detecting epidemic breeding grounds, from transport safety to crime prevention) do not allow hesitations due to prejudices and nostalgic feelings. Yet, the utopia of exceeding the human can't avoid taking social sciences into account and warning them not to give way to a similarly naive enthusiasm for a data-driven society built upon a 'social physics' (Pentland, 2013) confusing human behaviour with his regularities. By legitimizing the present through the past, Big Data promote the conservation of the status quo and suggest a social model that can't stand change, in which the balance of power underlying the contradictions of the present can't be reversed. On the one hand, there is the 'information trapping' (Casati, 2013) of customers profiling, with the user wrapped up in the constant confirmation of behavioural, opinion and purchasing preferences that are minutely recorded when using online sharing services.

On the other hand, however, there is the complete freedom of data owners and data scientists which belong to a class of chosen few who actually manage a dangerous social engineering by means of the arbitrary correlation choice. The utopia of exceeding the human is concretely realized as exodus of an ever larger share of individuals from the possibility to reach the understanding of phenomena, a polarization of skills that supports the concentration of wealth in defining reality as 'given', impervious to every overcoming of inequalities. Beyond any enthusiasm or alarmism, an idea of democratic access to Big Data needs to inspire the next steps of research and public debate.

References

- Anderson, C. (2008) The End of Theory: The Data Deluge Makes the Scientific Method Obsolete. *Wired*. [Online] 23rd June. Available from: http://archive.wired.com/science/discoveries/magazine/16-07/pb_theory. [Accessed: 16th May 2014]
- Aubert, N. (2003) *Le culte de l'urgence. La société malade du temps*. Paris: Flammarion.
- Bennato, D. (2013) Diversamente umani. L'umanesimo del dato e le narrative dei Big Data. *Lettera Internazionale*, 116 (2), 35-25.
- Berger, P. and Luckmann, T. (1966) *The social construction of reality*. London: Penguin Books
- Carr, N. (2008) Is Google Making Us Stupid?. *The Atlantic*. [Online] 1st July. Available from: <http://www.theatlantic.com/magazine/archive/2008/07/is-google-making-us-stupid/306868/>. [Accessed: 16th May 2014]
- Casati, R. (2013) *Contro il colonialismo digitale*. Roma-Bari: Laterza
- Cassano, F. (1989) Il gioco della scienza. *Rassegna Italiana di Sociologia*, 30 (1), 3-30
- Cassano, F. (2001) *Modernizzare Stanca. Perdere tempo, guadagnare tempo*. Bologna: Il Mulino.
- Crespi, F. (1982) *Mediazione simbolica e società*. Milano: Franco Angeli.
- DataXu (2014) Bringing Science to the Art of Marketing. [Online] Available from: <http://www.dataxu.com/about-us/vision>. [Accessed: 16th may 2014]
- Di Chio, S. (2013) Tempo (ir)reale. L'orizzonte temporale in Occidente dalla compressione sul presente all'asfissia dell'immediatezza. *Rassegna Italiana di Sociologia*, 54 (4), 513-538.

- Evolv. (2014) *Our Expertise*. [Online] Available from: <http://www.evolv.net/expertise>. [Accessed: 16th may 2014]
- Harrison, B. (1994) *Lean and Mean*. New York: Guilford Press.
- Harvey, D. (1990) *The Condition of Postmodernity*. Oxford: Blackwell.
- Heller, A. (1999) *A Theory of Modernity*. Oxford: Blackwell.
- Horizon. The Age of Big Data (2013) BBC2. 4th April. 21.00
- Ibm. (2014) *Talent and workforce management*. [Online] Available from: <http://www-03.ibm.com/software/products/en/category/SW333>. [Accessed: 16th may 2014]
- Koselleck, R. (2004) *Futures Past. On the Semantics of Historical Time*. Translated from German by Keith Tribe. New York: Columbia University Press.
- Laidi, Z. (2000) *Le sacre du présent*. Paris: Flammarion.
- Lohr, S. (2013) Big Data, Trying to Build Better Workers. *The New York Times*. [Online] 20th April. Available from: http://www.nytimes.com/2013/04/21/technology/big-data-trying-to-build-better-workers.html?pagewanted=all&_r=2&. [Accessed: 16th may 2014]
- Lübbe, H. (2009) The contraction of the present. In Rosa, H. and Scheuerman, W.E. (eds.), *High-speed society. Social acceleration, power and modernity*. University Park: Pennsylvania State University Press.
- Liotard, F. (1979) *La condition postmoderne. Rapport sur le savoir*. Paris: Minuit.
- Madrigal, A. (2012) How Google Builds Its Maps—and What It Means for the Future of Everything. *The Atlantic*. [Online] 6th september. Available from: <http://www.theatlantic.com/technology/archive/2012/09/how-google-builds-its-maps-and-what-it-means-for-the-future-of-everything/261913/>. [Accessed: 16th may 2014]
- Magatti, M. (2009) *Libertà immaginaria. Le illusioni del capitalismo tecnocratico*. Milano: Feltrinelli.
- Mayer-Schönberger, V. and Cukier, K. (2013) *Big Data. A revolution that will transform how we live work and think*. Boston: Houghton Mifflin Harcour.
- Nowotny, H. (1989) *Eigenzeit - Entstehung und Strukturierung eines Zeitgefühls*. Frankfurt aum Main: Suhrkamp.
- Panofsky, E. (1991) *Perspective as Symbolic Form*. Translated from German by Christopher S. Wood. New York: Zone Books.
- Rosa, H. (2009) Social acceleration: ethical and political consequences of a desynchronized high-speed society. In Rosa, H. and Scheuerman, W.E.

- (eds.), *High-speed society. Social acceleration, power and modernity*. University Park: Pennsylvania State University Press.
- Rosa, H. and Scheuerman, W.E. (eds.) (2009) *High-speed society. Social acceleration, power and modernity*. University Park: Pennsylvania State University Press.
- Simmel, G. (1968) *The conflict in Modern Culture and other essays*. Translated from German by K. Peter Etkorn. New York: Teacher College Press.
- Winton Capital (2014). *An empirical scientific approach*. [Online] Available from <https://www.wintoncapital.com/AboutUs/Philosophy>. [Accessed: 16th may 2014]
- Zawadzki, P. (ed.) (2002), *Malaise dans la temporalité*. Paris: Publications de la Sorbonne.



Networked and Technological Paradigms of Digital Whistleblowing

Philip DI SALVO*

Università della Svizzera italiana

Recently, several cases of journalistic whistleblowing have appeared.

WikiLeaks and the explosion of the Datagate have been the most visible examples of this phenomenon. Moreover, a constellation of smaller whistleblowing projects is expanding in different fields (Chen, 2011). In contrast, before the explosion of the Internet, the only scoop provided by a whistleblower able to reach the same impact in the public attention was represented by the 'Pentagon Papers' on the Vietnam War leaked to the press by Daniel Ellsberg (Ellsberg, 2002).

This paper analyzes the differences between the Ellsberg's case and the WikiLeaks revelations, emphasizing the role of digital technologies. Tracing Patrick McCurdy's analysis (2013), this paper investigates the differences due to the shift from an offline to an online and digital environment, focusing on the nature and formats of the leaked documents. The paper builds towards a case study about the destruction of hard disks in the Guardian newsroom by UK authorities to prevent further publications of Snowden's documents (Harding, 2014), by claiming how physicality still matters when it comes to whistleblowing, despite the constant 'datafication' of the physical world (Mayer-Schönberger and Cukier, 2013) and the attributes of digital artifacts (Kallinikos, Aaltonen and Marton, 2010) such as electronic documents.

Keywords: Whistleblowing; WikiLeaks; Edward Snowden; journalism

Introduction: The Rise of Digital Whistleblowing

Whistleblowing as an informational practice is based on four different elements (Johnson, 2003): 1) it is an act of an individual with the intention of making information public; 2) the information is conveyed to parties outside the organization who make it public and part of the public record; 3) the information has to do with possible or actual nontrivial wrongdoing in an organization and 4) the person exposing the leak is not a journalist, but a

* Corresponding author: Philip Di Salvo | e-mail: phildisa@gmail.com

member or former member of the organization involved. Whistleblowing, intended within this framework, is a classic practice of news making and journalism. Being human sources, whistleblowers are, by definition, one of the most useful resources available to journalists in order to get stories out to the public attention (Dreyfus et. al., 2013). In particular, the history of investigative journalism is strongly based on the contribution of whistleblowers to the creation of important scoops that shaped the journalistic norms until today, being Deep Throat, the source behind the Watergate scoop the most famous one.

In recent years, we assisted to the rise of a new spectrum of web-powered whistleblowing initiatives, where digital technologies play a major part. Following the leaks published by WikiLeaks, whistleblowing has been put at the center of the debate about the state of investigative journalism and beyond in the 'networked era' (Beckett, 2012). Moreover, in the wake of the WikiLeaks' major publications, a constellation of websites aiming to replicate WikiLeaks' success appeared (Chen, 2011), although without reaching the exposure Julian Assange was able to reach, such in the case of the OpenLeaks website (Di Salvo and Porlezza, 2014). Moreover, the Datagate case, concerning the NSA digital surveillance programs, has been the most sensible recent case of whistleblowing and the two newspapers, The Guardian and The Washington Post, which published first Edward Snowden's revelations were awarded a Pulitzer Prize in the spring of 2014 (Pilkington, 2014).

Despite some paradigmatic differences, both the WikiLeaks' and the Snowden's revelations are clear indicators of how the practices of whistleblowing and investigative journalism can benefit from Internet-based and digital technologies in terms of circulation, flexibility and potential audience reach.

From a technological perspective, this is due to the general digitalization of documents, occurring in every field, can help possible sources in copying and disseminate documents and in leaking them to interested media or public institutions on the Internet (Papandrea, 2011), bypassing practical and material limitations intrinsic of analog artifacts which used to be inevitable in the previous analog context. This was at the most visible in the case of Chelsea Manning, the US soldier who became the source behind the major WikiLeaks releases. Manning who was able to deliver to the whistleblowing platform more than 600 thousand files by easily downloading them on to rewriteable (CD-RWs) disks (Madar, 2012) from the the Secret Internet Protocol Router Network (SIPRNet) of the U.S.

Department of Defense and Department of State in order to leak them to WikiLeaks. The SIPRNet network is a Department of Defense network for classified operations and is used by different intelligence and military agencies to store and distribute classified information since 1997, when SIPRNet went online. The network can basically be considered as 'the way the Defense Department moves information around on computer systems' (Weinberger, 2010). On the other side, Daniel Ellsberg's 'Pentagon Papers' leak is the best example available about how whistleblowing used to proceed in an analog age: Ellsberg had to manually photocopy all the seven thousand pages which constituted the whole corpus of the leak from the original books (Ellsberg, 2002) stored in the RAND offices in Washington, applying himself in a long and time consuming procedure of photocopying.

The contribution of the Internet and digital technologies to whistleblowing is notable in different ambits and has an impact from different perspectives involved in the practice: paradigmatic and technological ones in particular. First, the whole digital revolution and the rise of the network society (Castells, 1996) impacted on whistleblowing too, changing its paradigm. Secondly, from a more technological point of view, the overall process of digitalization of archives and the constant 'datafication' (Mayer-Schönberger and Cukier, 2013) in which information is being created and spread, played a major part in shaping whistleblowing in the digital era.

The Networked Paradigm of Digital Whistleblowing

Patrick McCurdy (2013) has provided a first overview of how the rise of the Internet changed whistleblowing, by putting WikiLeaks, which can be considered as the most prominent actor in this field, in Castells' (2000) and Benkler's (2011) perspectives on network society. Manuel Castells has defined (1996) the network society as the product of a wider information technology revolution coming with a general re-organization of informational hierarchies, where 'digitalized flows of information can be instantly shared across mass media and horizontal communication networks', according to McCurdy (2013). Moreover, Benkler (2011) defines the network society also as an 'understanding of a particular historical moment when computer-mediated networks of information and communications have come to play a particular large role and to realign in fairly substantial ways the organization of production, power, and meaning

making in contemporary society'. As Benkler (2011) claims, taking again Chelsea Manning as example, the technologies available in this new networked Internet-centric scenario, can give to whistleblowers new 'forms and pathways for discovering and disseminating information [...] which provided dimensions of power to these people that were not previously available to them'.

McCurdy (2013) has compared Chelsea Manning's whistleblowing act with Daniel Ellsberg's leak of the 'Pentagon Papers' coming to the conclusion that the network society 'has changed also the type of person who can be a leaker'. Following this insight and calling into context the classic agenda setting theory, Daniel Ellsberg, because of his high-ranking position as intelligence analyst who was working 'close to the seat of power on the very dossier he eventually leaked', can be considered as an 'high-power source' (Reese, 1991), whose revelations, beside the relevance of the documents Ellsberg leaked, were legitimized by the media also because of the elite position of the source. On the other side, Manning was a low-ranking soldier with the same security clearance as a multitude of other people granted access to the SIPRNet digital network. Following again Reese's (1991) typology of source-media relationships, Manning could be considered as a 'low-power' source, whose position was empowered mainly by the urgency and relevance the source was able to leak to some major news outlets, using WikiLeaks as conduit to reach the mainstream media and a global exposure.

Being a digital network of computers located in many different connected knots around the globe, SIPRnet gave virtually anyone with granted credentials the capability of accessing and surfing among different databases of classified documents. Potentially anyone who was working within the network could have blown the whistle as Manning did to WikiLeaks: this is due to the disseminated nature of the network itself, whose ability of information sharing among interested and connected agencies and embassies was strongly emphasized by US authorities in the wake of 9/11 in order to link up separate archives of government information (Borger and Leigh, 2010; BBC, 2010). In this sense, the Manning case is an indicator of how the rise of digital technologies, digital archiving and the whole consequences of the network society could make whistleblowing much easier than it used to be in the previous offline informational ecosystem. While discussing the evolution of information, Geoffrey C. Bowker and Susan Leigh Star (2000) have also pointed to this interdependence as a growing 'intermingling of people, things (including

information technologies, representations and politics' using the concept of 'cyborg'.

Also the notion of 'Cyberspace' as outlined by Jonathan Willson (1996) while describing the evolution of archiving in the digital context, can also be considered in discussing the way in which the network society contributed in shaping digital whistleblowing. If Cyberspace is the Internet, the ambient in which Chelsea Manning acted originally, the whistleblower could be located everywhere and nowhere at the same time, profiting from being in a non-physical place. This is again due to the lack of no inherent physical characteristics of the cyberspace (Anders, 1994) and its technological networked structure in which Manning was only a single knot. Moreover, the classified digital networks Manning was able to access also fits perfectly under the definition of 'virtual library as information resources distributed by networks' (Newby, 1993 as quoted in Willson, 1996).

On the other side, for their intrinsic physical nature, the corpus of documents which would later be known as the 'Pentagon Papers' were existing only in its physical shape and was shared within a very small elite community, mainly staff members who were granted access to the offices where the 'Papers' were actually stored in one of their fifteen existing duplicates (Gitelman, 2011). For this technological reason, the number of individuals who could potentially have leaked documents to the outside of the organization was far limited than in the case of Chelsea Manning.

Moreover, the act of whistleblowing itself was intrinsically much more complicated on a practical level. In his book about the "Pentagon Papers' leak, Ellsberg (2002) himself explains the mechanic difficulties he and his friend Anthony Russo had to face in manually copying with a Xerox 914 machine all the seven thousand pages of the books in several copies.

The Technological Paradigm of Digital Whistleblowing

If we consider again Daniel Ellsberg and Chelsea Manning as the examples embodying two different phases of the evolution of journalistic whistleblowing, differences emerge also by analyzing the kind of documents they were able to deliver to the press and their technological nature. As saw, Chelsea Manning was working in a highly-digitalized cyber environment where the exchange of data and digitalized information was encouraged on digital networks by the US authorities themselves. Besides this ambient issue, it is also crucial to consider the growing availability of digitalized

information. According to recent statistics (Hilbert and Lopez, 2011; Hilbert, 2012), already 300 exabytes of stored data existed in 2007 globally.

Moreover, in the time between 2001 and 2011, the federal government of the United States of America digitized 475 million pages of federal records (The White House, 2011). Taking a closer look to this numbers, it is possible to frame them within the wider phenomenon of ‘datafication’ (Mayer-Schönberger and Cukier, 2013) which involves in a constantly less-physical way every aspect of the contemporary age in which information is being shared among individuals and institution, toward a massive and pervasive extension of digitalization of information. Because of this constant digitalization in action, the overall idea of information creation and consumption has gone through a sea change itself. In this section, we will try to focus on how the technological change of leaked documents from analogue to digital and the increased opportunity of leaking digital documents also helped giving whistleblowing a new shape.

In the shift from an offline to an online ecosystem, after having considered networks as a changing agent in action, it is important to focus on the nature of documents which whistleblowers can now access and leak. In order to download the documents which were later leaked to WikiLeaks, Chelsea Manning accessed the SIPRnet network towards a SNAP computer from his workstation in Iraq, accessing five different searchable archives of classified digital documents, including the Net Centric Diplomacy database (Zetter, 2011). SNAP is an acronym which stands for ‘SIPR-NIPR Access Point’ and this kind of proprietary computers are used to access classified networks such as SIPRNet and are produced by the U.S company TeleCommunication Systems. According to Ambinder (2010), at the time of the Manning leak there were 1,500 machines operational in Afghanistan. The SNAP machine Manning used US diplomatic cables, such as those included into the ‘Cablegate’ leak, for instance, are usually transferred from connected offices into the network via email in PDF form using a State Department classified network called ClassNet and, in order to be searchable, are later stored in PST form, the format used by Microsoft Outlook to compress and store data. Manning downloaded a massive load of files from the SNAP computer and saved them on CD-RWs (Ambinder, 2010). For instance, the Cablegate corpus of 250 thousand files weighted 1.6 GB in total and could be delivered by Julian Assange to *the Guardian* using on a USB flash device, journalist David Leigh recalls (2010).

These events fit perfectly in Floridi’s (2010) description of the digital revolution and theorization of how digitalization and ‘datafication’ were

able to change completely the idea itself of 'objects' and 'processes'. Following this path, the growing digitalization caused the loss of 'physical connotation' of objects which, in a digital form, can easily be considered independent from their original supports. In this sense, if we can consider as the original 'Pentagon Papers', the documents stored in the RAND offices in Washington, it is intrinsically more difficult to individuate the 'original' copies of the diplomatic cables Manning was able to copy and download during the leak.

Following again Floridi's proposed framework (2010), digital objects (Floridi uses digital music files as examples, but the definition fits with every kind of digital artifacts) are 'typified in the sense that an instance of an object (my copy of a music file) is as good as its type (the music file of which my copy is an instance)'. In this sense again, digital objects are perfectly clonable and each copy of a file is interchangeable with another one. Consequently, to create copies of them is much easier than it used to be in the offline environment Daniel Ellsberg was operating. It has been calculated (McCurdy, 2013), that it would take around 41.8 hours of straight printing at a rate of 100 pages a minute to print the whole Cablegate leak. Chelsea Manning's leak, instead, was only one click away and despite its vastness, it could have been downloaded, copied and leaked with relative low computing skills and agility (Zetter, 2011).

Another peculiarity of digital artifacts such as the files Manning was able to copy and leak to WikiLeaks is their distributed nature (Kallinikos, Aaltonen and Marton, 2010). Within this categorization, it is possible to consider digital artifacts as 'borderless' entities, meaning that they cannot be identified within clear physical borders which defined them as physical entity such as books or paper documents. Moreover, according to the BBC (McCurdy, 2013) about 2.5 million people, military and civilian, could access the SIPRnet network when Manning decided to become a whistleblower. When it comes to the networked nature of digital whistleblowing, taking into consideration the wideness of the access granted to the SIPRnet network, the distributed nature of digital artifacts evolves into the substantial impossibility to control the spreading of leaked documents once they are taken out from the archives and start to disseminate.

The Re-Materialization of Whistleblowing

Up to this point this paper considered digital whistleblowing as an Internet-empowered phenomenon in information and journalism. This

paper claims how the disseminated structure of the network society and the global digitalization has given whistleblowers easier and more ways to leak out information. As saw in the second section of this paper, the immateriality of digital artifacts is one of the bases of the spread of digital whistleblowing, thanks to the improvements in terms of practical handling of documents and diffusion. The notion of 'infosphere' has been used to describe a completion of the move into a digital ecosystem, could suggest an almost-fulfilled transition into an advanced fully digitalized informational environment. But when it comes to digital whistleblowing, as it is for other different areas where digital technologies are at work, we can see how materiality still matters at a certain point.

The concept of 're-materialization' has been analyzed in different field of technology studies and consumer cultures. For instance, Paolo Magaudda (2011, 2012) analyzed how materiality regained an important role in digital music consumption because of material objects such as the iPod, the hard disk and the vinyl disc which, even in times of strong digitalization, have gained a crucial role in shaping consuming practices. This theorization can fit also in the field of whistleblowing. If we take a closer look at the wake of the Snowden's leak, we can find at least an episode suggesting a strong role of materiality into digital whistleblowing: the request made by the British GCHQ to *the Guardian* newsroom to hand Snowden's file back and the consequent destruction of the hard disks where the leaked files were stored in order to prevent the London-based newspaper from publishing more material based on the secret documents leaked by Edward Snowden (Harding, 2014a; 2014b).

During the operation, two staffers of the British secret services GCHQ supervised the smashing of hard disks in *The Guardian* newsroom basement with the use of angle-grinders and drills. When smashed, pieces of technology were also put inside a degausser in order to erase all the data. As Magaudda puts it (2012) 're-materilization' brings together a complexity of phenomenon, practices and technologies which are giving back to digital artifacts a strong emphasis on materiality. This happens because material objects such as the iPod, hard disks and vinyl records, pure physical entities, are re-gaining importance in the consumption of music, even in a highly digitalized environment which might suggest a complete loss of relevance for everything material.

Magaudda (2012) hypothesizes possible further applications of the concept of 're-materialization' to other different fields where, in recent times, digitalization played a major part in re-shaping practices and

paradigms, starting from newspapers, books and other fields where paper went through a strong digitalization. As saw, whistleblowing met deep changes because of digitalization and the intrinsic nature of digital artifacts which are more and more frequently leaked by whistleblowers over the Internet. It is interesting to see how materiality still matters in the case of the Snowden files when the intrinsic tension of a whistleblowing act is at its most visible extension: materiality arises again when a leak needs to be stopped and all the digital ways to prevent it from spreading have been proved to be almost powerless.

Discussion and further research suggestions

This paper attempted to contribute to the analysis of whistleblowing in the digital era. As mentioned, this field of information and investigative journalism went through, great change because of digitalization, datafication and the overall changes promoted by the raise of the network society. As expected, this new digital paradigm has changed the practice of whistleblowing from the bottom up as the recent cases of Chelsea Manning and Edward Snowden evidently demonstrate. Moreover, materiality still plays its part in the generality of a whistleblowing act, as the events of the destruction of *The Guardian's* hard disks seem to suggest.

The notion of 're-materialization' has been used mainly in the analysis of the digitalization of consumer practices but, as demonstrated, can also be noticed also in this field. Further research could analyze more in detail how re-materialization effects the diffusion of a leak of digital files and whether re-materialized tactics such as the physical destruction of hard disk can be effective in actually stopping leaked digital documents in spreading all over the Internet.

Notes

This paper refers to PVT Manning as a female. This is due to Manning's decision of changing her name from Bradley to Chelsea and to be identified as a female. At the times of writing, Chelsea Manning is currently conducting a legal battle to get hormone treatment while in custody in the Fort Leavenworth prison, Kansas.

References

Ambinder, M. (2010) WikiLeaks: One Analyst, So Many Documents. How could Bradley Manning alone have leaked so much classified material?.

- NationalJournal.com*, November 29. Available from: <http://www.nationaljournal.com/whitehouse/wikileaks-one-analyst-so-many-documents-20101129>.
- Anders, P. (1994) The Architecture of Cyberspace. *Progressive Architecture*, 75 (10).
- BBC. (2010) Siphnet: Where the leaked cables came from. *BBC.com*, 29 November. Available from <http://www.bbc.com/news/world-us-canada-11863618>.
- Beckett, C. (2012) *WikiLeaks. News in the Networked Era*. Cambridge: Polity.
- Benkler, Y. (2011) Networks of Power, Degrees of Freedom. *International Journal of Communications*, 5, 721-755.
- Borger, J. and Leigh D. (2010) Siphnet: where America stores its secret cables. *The Guardian*, 28 November. Available from <http://www.theguardian.com/world/2010/nov/28/siphnet-america-stores-secret-cables>.
- Bowker, G. C. and Star, S. L. (2000) *Sorting Things Out. Classification and Its Consequences*. Cambridge: The MIT Press.
- Cammaerts, B. (2013) Networked Resistance: the case of WikiLeaks. *Journal of Computer-Mediated Communication*, 18 (4), 420-436.
- Castells, M. (2000) *The Rise of the Network Society*. Oxford: Blackwell.
- Chen, N. (2011) Wikileaks and its Spinoffs: new models of journalism or the new media gatekeepers? *Journal of Digital Research & Publishing*, 1, 157-167.
- Di Salvo, P. and Porlezza, C. (2014) *OpenLeaks*. In Harveyet, K. (eds.), *Encyclopedia of Social Media and Politics*. London: Sage.
- Dreyfus, S., Lederman, R.M., Brown, A.J., Milton, S., Miceli, M.P., Bosua, R., Clausen, A. and Schanzle, J. (2013) *Human Sources: The Journalist and the Whistle-blower in the Digital Era*. In Tanner, S. and Richardson, N. (eds.) *Journalism Research and Investigation in a Digital World*. Oxford: Oxford University Press.
- Ellsberg, D. (2002) *Secrets: A Memoir of Vietnam and the Pentagon Papers*. New York: Penguin.
- Floridi, L. (2010) *Information. A Very Short Introduction*. Oxford: Oxford University Press.
- Gitelman, L. (2011) *Daniel Ellsberg and the Lost Idea of the Photocopy*. In Jülich, S., Ekström, A., Lundgren, F., and Wisselgren, P. (eds.), *History of Participatory Media. Politics and Publics: 1750-2000*. London: Routledge.
- Harding, L. (2014a) *The Snowden Files: The Inside Story of the World's Most Wanted Man*. London: Guardian Faber Publishing.

- Harding, L. (2014b) Footage released of Guardian editors destroying Snowden hard drives. *The Guardian*, January 31. Available in <http://www.theguardian.com/uk-news/2014/jan/31/footage-released-guardian-editors-snowden-hard-drives-gchq>.
- Hilbert, M. and Lopez, P. (2011) The World's Technologic Capacity to Store, Communicate, and Compute Information. *Science*, 332 (6025), 60-65.
- Hilbert, M. (2012) How much information is there in the 'information society'? *Significance*, 9 (4), 8-12.
- Johnson, R.A. (2003) *Whistleblowing. When It Works and Why*. London: Lynne Rienner Publishers.
- Kallinikos, J., Aaltonen, A. and Marton, A. (2010) A Theory of Digital Objects. *First Monday*, 15 (6-7).
- Leigh, D. (2010) How 250,000 US embassy cables were leaked. *The Guardian*, November 28. <http://www.theguardian.com/world/2010/nov/28/how-us-embassy-cables-leaked>.
- Madar, C. (2012) *The Passion of Bradley Manning: The Story Behind the Wikileaks Whistleblower*. New York: OR.
- Magaudda, P. (2011) When materiality «bites back». Digital music consumption practices in the age of dematerialization. *Journal of Consumer Culture*, 11 (1), 15-36.
- Magaudda, P. (2012) *What happens to materiality in digital virtual consumption?* In Molesworth, M. and Denegri-Knott, J. (eds.), *Digital Virtual Consumption*. London: Routledge.
- Mayer-Schönberger, V. and Cukier K. (2013) *Big Data. A Revolution That Will Transform How We Live, Work and Think*. London: John Murray.
- McCurdy, P. (2013) *From the Pentagon Papers to Cablegate: How the Network Society Has Changed Leaking*. In Brevini, B. (eds.), *Beyond WikiLeaks: Implications for the Future of Communications, Journalism and Society*. New York: Palgrave MacMillan.
- N.A. (2011) Why Is That a Secret? *The New York Times*, 24 August. Available at http://www.nytimes.com/2011/08/25/opinion/why-is-that-a-secret.html?_r=1.
- Newby, G.B. (1993) Virtual Reality. *Annual Review of Information Science and Technology*, 28, 187-229.
- Papandrea, M. (2011). The Publication of National Security Information in the Digital Age. *Journal of National Security Law & Policy*, 5 (1), 119-130.
- Pilkington, E. (2014) Guardian and Washington Post win Pulitzer prize for NSA revelations. *The Guardian*, April 14th. Available at

<http://www.theguardian.com/media/2014/apr/14/guardian-washington-post-pulitzer-nsa-revelations>.

Reese, S. D. (1991) *Setting the Media's Agenda: A Power Balance Perspective*. In Anderson, J.A. (eds.), *Communication Yearbook*. Newbury Park: Sage.

Slack, M. (2011) By the Numbers: 475 Million. *Whitehouse.org*. Available at <http://www.whitehouse.gov/blog/2011/11/28/numbers-475-million>.

Weinberger, S. (2010) What Is SIPRNet? *Popular Mechanics*, 1 December. Available at <http://www.popularmechanics.com/technology/how-to/computer-security/what-is-siprnet-and-wikileaks-4085507>.

Willson, J. (1996) Enter the cyberpunk librarian: future directions in cyberspace. *Internet Research*, 6 (1), 22-18.

Zetter, K. (2011) Forensic Expert: Manning's Computer Had 10K Cables, Downloading Scripts. *Wired*, December 18. Available at <http://www.wired.com/2011/12/cables-scripts-manning/>.

Identità immortali. L'Afterlife digitale come estensione dell'identità

Firenze GAMBA*
Università di Sassari

La pluralizzazione dell'identità si può osservare tanto nella modalità on line che in quella off line. Tuttavia c'è un ambito in cui l'identità digitale incomincia soltanto ora ad essere indagata : è quello relativo alla morte e ai rituali. Nota con il termine di Afterlife digitale, vale a dire come 'la continuazione della vita e della presenza digitale dell'utente dopo la sua morte', tale forma di permanenza post mortem produce delle vere e proprie identità immortali rispetto alle quali l'utente svolge un ruolo attivo. Il servizio di messaggeria post mortem offerto da alcuni siti definiti casse forti digitali illustra questa trasformazione: la possibilità per l'utente di pianificare i messaggi da inviare ai propri familiari ed amici corrisponde alla possibilità dell'Afterlife digitale di trasformare l'immortalità da sogno irrealizzabile a progetto digitale pianificato, in cui l'utente interviene direttamente producendo la propria identità immortale.

Keywords: Digital afterlife; messagerie post mortem; identità immortali

Introduzione

Le trasformazioni dell'esperienza prodotte dalle ICT mostrano forse gli effetti più evidenti sull'identità. Ibridata dal digitale, l'esperienza fisica ha permesso all'individuo di estendere i propri confini, producendo un *extended self* (Belk, 2013) dalle aumentate potenzialità cognitive, espressive e d'azione. Si tratta di effetti che oltrepassano anche l'ultimo confine dell'identità: la morte. Da qualche tempo la gestione dei dati digitali abbandonati nel web dopo la morte degli utenti ha dato luogo al fenomeno dell'*Afterlife digitale*, una 'vita dopo la vita' digitale che rimette in questione l'identità digitale. Partendo da una prospettiva di estensione e moltiplicazione dell'identità, l'articolo considera il concetto di *Afterlife*

* Corresponding author: **Fiorenza Gamba** | e-mail: fiorenza.gamba@gmail.com

digitale attraverso l'analisi dei servizi di gestione dei dati degli utenti –casse forti digitali– che comprendono anche le messaggerie *post mortem*.

Le identità contemporanee

L'analisi dell'identità indica le caratteristiche dell'uomo moderno: gli elementi critici dell'identità sono anche le modalità adattive alla condizione contemporanea. Attraverso fragilità, solitudine, narcisismo l'identità si frammenta, ma anche si riconosce come tale (Bauman, 1998; Elias, 1990; Lasch, 1979). Il web acuisce questa dinamica attraverso meccanismi di visibilità/invisibilità, in continuità con la vita quotidiana e dipendenti dalle piattaforme (Cardon, 2008). Di conseguenza, la pluralizzazione dell'identità mostra la sua complessità sia on line che off line. Tuttavia, c'è un ambito in cui l'identità incomincia soltanto ora ad essere indagata: quello relativo alla morte e ai rituali. Di questa permanenza dell'identità, nota con il termine di *Afterlife digitale*, uno degli aspetti più problematici riguarda il corpo. Infatti, nel gioco delle identità multiple, (Elster, 1985; Bauman, 1997; Giddens, 1991) si impone una semplificazione che oppone le identità corporee, reali, alle identità digitali, fittizie. Tale dicotomia, riproduce l'opposizione tra digitale e reale e mostra come l'esperienza umana, nei momenti simbolicamente più importanti, metta in discussione i confini l'identità.

Due prospettive derivano da questa dicotomia: una estensiva, che assegna identico valore a tutte le sue manifestazioni (corporee o digitali); una restrittiva che considera le sue manifestazioni concrete. Secondo la prospettiva restrittiva, la morte è un fatto che trasforma irreversibilmente il percorso identitario con la sua interruzione (Jankelevitch, 1977). Di conseguenza, il desiderio umano di sconfiggere la morte, rappresentato dal mito dell'amortalità, si concentrerebbe sull'elemento più concreto dell'identità umana: il corpo. Per questo motivo il corpo sarebbe anche il punto dove si concentra l'orrore della morte. Edgar Morin in *L'homme et la mort* descrive la perdita di individualizzazione (rappresentata dalla contaminazione del cadavere) il fattore che rende inaccettabile la morte, un trauma che l'uomo ha sempre cercato di contrastare e la cui coscienza si manifesta come un triplo dato antropologico: la coscienza realista della morte, la coscienza traumatica, l'affermazione di un al di là della morte (Morin, 2002, p. 42-47). In questo senso, i rituali funebri sono una risposta simbolica alla distruzione della morte, un tentativo di opporre una ricostituzione dell'individualità del soggetto. Da questo punto di vista i rituali funebri svolgono sia una funzione materiale di conservazione del

cadavere sia una funzione astratta di conservazione nella memoria collettiva e sociale per tenere insieme i frammenti centrifughi di un'identità umana.

Per la prospettiva estensiva, corrispondente alla diffusione delle ICT, gli strumenti digitali, ibridati con le pratiche della vita quotidiana, hanno trasformato il concetto di esperienza in esperienza mediata ed aumentata. Mediata, per effetto della moltiplicazione di informazioni sul mondo prodotta dai media che ha contribuito a definire la dinamica identitaria della contemporaneità. Una tendenza che ha modificando profondamente il processo riflessivo di formazione del sé, il quale individua nei materiali simbolici mediati i contenuti fondamentali di cui appropriarsi (Thompson, 1998, 289-325). L'esperienza risulta aumentata anche a seguito dell'arricchimento prodotto dalle tecnologie digitali. Una forma di contaminazione/autoproduzione che si inserisce in quel processo di estroflessione riconosciuto come tratto specifico dell'umanità da Leroi-Gourhan (1964) e che attualmente trova probabilmente nell'Ubiquitous Computing una delle espressioni più complesse e rappresentative.

In questo contesto di estensione dell'orizzonte di esperienza legata alla tecnologia si inserisce un fenomeno apparso recentemente nel web che ha sottolineato alcuni aspetti problematici dell'Afterlife digitale: la nascita delle casse forti digitali. Si tratta di siti specializzati che offrono a richiesta degli utenti dei servizi di gestione dei dati dopo la loro morte tramite la sottoscrizione di un accordo con gli amministratori del sito. Nata come risposta ad un problema di privacy, la possibilità di gestione anticipata delle informazioni personali ha avuto come effetto non previsto la possibilità di realizzare un servizio di messaggeria *post mortem* attraverso il quale l'utente può inviare dopo la morte messaggi ai propri familiari e agli amici.

Se è difficile valutare l'effettiva diffusione del fenomeno, l'uso di questi servizi solleva però alcune questioni inerenti all'immaginario dell'immortalità, ai limiti dell'azione umana e alla loro trasformazione grazie alle tecnologie digitali. Inoltre, le messaggerie *post mortem* ripropongono la questione dell'identità da una diversa prospettiva. In questo caso, infatti, non è in questione la concezione estensiva dell'identità, come mostrano gli studi sulle identità digitali, sia nella prospettiva della Computer Science che ne indaga gli aspetti della sicurezza e della privacy (White, 2008; Glässer e Vajihollahi, 2010) sia nella prospettiva delle scienze umane che si concentrano sugli aspetti sociali e culturali (Turkle, 1995; Cardon, 2009; Liu, 2007; Bradwell e Gallagher, 2007; Merzeau, 2009; Lardellier e Bryon-Portet, 2010; Donath e Boyd, 2004). Al contrario, l'uso delle casse forti digitali presuppone un'estensione dell'esperienza che comprenda l'Afterlife

digitale. A partire da un problema di gestione relativo al trattamento dei dati on line di un utente quando questi muore, non essendo i familiari né l'amministratore autorizzati ad accedervi, hanno preso forma interrogativi che inducono a considerare il desiderio di sopravvivenza come un'affermazione dell'identità umana che si esprime in tutte le sfere dell'esperienza, reale o digitale, al di là dei confini spazio-temporali dell'esistenza.

L'Afterlife digitale

L'Afterlife digitale (*Digital Afterlife*) è, secondo la definizione riportata dal sito Cirrus Legacy "La continuazione della vita e della presenza digitale dell'utente dopo la sua morte" (<http://www.cirruslegacy.com/143-definition-of-terms.html>). Una riflessione sulle sue implicazioni e sui suoi sviluppi si sta producendo a più livelli: un primo livello, più immediato e superficiale affronta il tema della morte digitale come una curiosità che cattura l'attenzione delle redazioni web e degli utenti; un secondo livello è rappresentato dall'analisi degli specialisti, *web designers* o *interaction designers*, che produce una meta riflessione sul web e sul suo uso sociale e culturale; un terzo livello coinvolge direttamente la ricerca in una prospettiva multidisciplinare concentrandosi sugli aspetti sociologici, antropologici e psicologici delle attività *post mortem* che hanno luogo nel web. In questa prospettiva, l'analisi della relazione tra l'Afterlife digitale e l'immortalità, considerata come la più recente espressione di un *extended self* che oltrepassa anche i limiti imposti dalla tecnologia, insiste sulla ricerca delle modalità espressive in cui l'Afterlife digitale si manifesta. Infatti, il dato principale che emerge dall'analisi dei siti web che offrono servizi di gestione dati dopo la morte è la ricerca volontaria da parte degli utenti di una forma di immortalità in grado di assicurare la sopravvivenza all'identità soggettiva oltre i propri confini di esistenza spazio-temporali. L'identità non si interrompe con la morte dell'individuo, non solo perché i suoi dati personali rimangono presenti nel web anche dopo la sua morte, ma anche perché essa continua a manifestarsi dopo la morte grazie ai servizi offerti dai siti specializzati. Per definire il fenomeno dell'Afterlife digitale e le sue implicazioni riguardanti l'identità, un punto di riferimento sono i rituali funebri on line: nati circa vent'anni fa, questi rituali non convenzionali (De Vries e Rutherford, 2004; Roberts e Vidal 1999, 2000; Sofka et. al., 2012; Gamba, 2007a) esprimono una richiesta di personalizzazione causata anche dal disagio emotivo legato ad alcune prescrizioni riguardanti i rituali funebri

tradizionali, emerse soprattutto con la diffusione dell'AIDS, (Hintermeyer, 1988; Sherr, 1995; Thomas, 1989; Fecht, 1996). Infatti, la negazione dell'identità sessuale dei morti di AIDS nei funerali tradizionali ha avuto un'influenza diretta sulla moltiplicazione di pratiche alternative che hanno trovato l'espressione più rappresentativa nel web con la diffusione di cimiteri virtuali (Gamba, 2007b). Tali rituali hanno segnato l'ingresso della morte nel web, anche dell'*Afterlife* digitale. Infatti, essa comprende tutte le problematiche che la morte di un utente fanno emergere in relazione alla gestione – e alla sua legittimità – dei dati riguardanti la sua identità digitale.

In primo luogo emergono aspetti legati alla privacy sia da un punto di vista formale, dipendenti dalle pratiche e dalle politiche dei siti, sia da un punto di vista legale, inerenti ai diritti di un soggetto giuridico che non è di nuova costituzione – l'individuo digitale – ma che indubbiamente è collocato in un contesto inusuale come quello legato alla morte. Il web, nel tentativo di fornire una soluzione pratica a un problema tecnico, ha prodotto le casse forti digitali: cassette di sicurezza digitali in cui conservare e proteggere documenti riservati e password, spesso gratuitamente. Se in origine il servizio si è limitato alla gestione dei dati degli utenti (aspetto prevalente), successivamente ha ampliato l'offerta, segnando così il passaggio, ma anche il legame, dagli aspetti puramente informatici a quelli emotivi ed affettivi della gestione dell'identità *post mortem* (Benski e Fisher, 2013; Davies e Park, 2012). Affrontare da parte degli utenti il problema della destinazione dei propri dati dopo la propria morte ha aperto un canale di contatto e di scambio digitali con i propri cari e di conseguenza con il mondo. L'*Afterlife* si presenta dunque come una forma di sopravvivenza delle identità dell'individuo che trova nella tecnologia digitale una forma di realizzazione. Da un punto di vista oggettivo, essa concerne l'esistenza digitale e le sue trasformazioni dopo la morte considerando la possibilità, forse la necessità, per l'utente di progettare la propria vita dopo la vita tanto nella forma (Carroll e Romano, 2011; Brubaker, 2013) che nel contenuto. Da un punto di vista del significato simbolico l'*Afterlife* digitale ripropone il tema dell'immortalità in versione aggiornata, trasformandola da mito irraggiungibile dell'umanità a condizione personale realizzabile attraverso i supporti digitali.

Tipologie di *Afterlife* digitale

Un'analisi dei siti che offrono servizi di gestione dei dati e di messaggeria *post mortem* mostra variazioni molto ampie del concetto di *Afterlife* che si

estende tra due polarità opposte. Da un lato l'*Afterlife* è intesa come l'effetto della permanenza dei dati digitali degli utenti conseguente all'uso specifiche applicazioni informatiche. Al lato opposto essa comprende la possibilità di estendere la presenza dell'utente anche dopo la sua morte attraverso un *dialogo* – paradossale – con i famigliari e con gli amici garantito dai servizi di messaggeria. Un dialogo che, pur dipendendo strettamente dalla tecnologia si inserisce in un più ampio discorso tanatologico ispirato ad una riflessione generale sulla morte e ai suoi effetti sull'esperienza umana, ai principi che definiscono una serie di iniziative di cui il servizio di messaggeria *post mortem* costituisce soltanto un aspetto, non necessariamente principale.

Nel *continuum* che va da un polo all'altro del concetto dell'*Afterlife* digitale sono state individuate alcune tipologie di siti con funzioni di casse forti digitali per meglio comprendere il desiderio umano di sopravvivenza dopo la morte attraverso applicazioni digitali. A questo fine sono stati presi in esame 50 siti specializzati con servizi di messaggeria *post mortem*. Di questi sono state individuate le caratteristiche comuni e le tipologie.

Per quanto riguarda le caratteristiche comuni: la quasi totalità dei siti si avvale di un sistema di archiviazione *Cloud*; tutti i siti forniscono una garanzia di sicurezza rispetto alla protezione dei dati; i servizi offerti sono gratuiti o a costi contenuti. Per quanto riguarda le tipologie cinque sono state considerate le più rappresentative: *social, financial, creative, relationship, thanatological*.

Social: in questa tipologia sono compresi i siti che offrono i servizi più generali, come la semplice gestione dei dati informatici dell'utente, in particolare quelli relativi a SNS. Talvolta si tratta di app da scaricare legate a SNS come Facebook, come nel caso di *Sanctri* e *If I die* o di siti specializzati nell'invio ben pianificato di messaggi *post mortem*, a richiesta dell'interessato, a familiari ed amici come *Dead Social*.

Financial: i siti appartenenti a questa tipologia si occupano soprattutto della gestione di dati sensibili, in particolare finanziari (password di accesso a conti o depositi on line), di indicazioni funerarie o anche sanitarie – ad esempio per quanto riguarda le cure d'urgenza oin materia di eutanasia – , di disposizioni testamentarie, tra cui è compreso anche il servizio di messaggeria. In alcuni casi l'amministratore del sito prevede la figura di veri e propri esecutori testamentari digitali, come *Cirrus Legacy, Docubank e After steps*.

Creative: questa tipologia riunisce i siti che predispongono gli strumenti digitali e le indicazioni affinché l'utente possa creare direttamente in modo

personalizzato la propria *Afterlife* digitale, scegliendone i contenuti, le forme i tempi e le modalità. L'intervento dell'amministratore è limitato al minimo, poiché è l'utente che prepara una sorta di autopromozione del proprio ricordo nel futuro e dei propri contatti con gli amici e i familiari, scegliendo e caricando sul proprio profilo *Afterlife* non solo formati digitali diversi: testi, immagini – fisse e in movimento –, suoni come *MyWonderfulLife*, *PassingBye*, *RememberedVoices*, *Eterniam*, ma talvolta anche precisi segni dell'immortalità futura della propria identità, come gli avatar realizzati con le foto degli utenti e speciali algoritmi oppure i modelli del loro DNA opportunamente custoditi come avviene nel sito *LifeNaut*.

Relationship: i siti di questa tipologia pur non presentando servizi di messaggiaia particolari, pongono l'accento sulla relazione che l'utente vuole mantenere nel futuro con i propri contatti. Più che sulla forma dei supporti, puntano sui contenuti e predispongono una modalità di contatto idealmente dialogica e continuativa anche se necessariamente non reciproca, ad esempio *My Goodbye Message*.

Thanatological: quest'ultima tipologia di siti è molto complessa, riunisce temi riguardanti la morte ed è talvolta difficile riconoscerla come appartenente all'insieme delle casse forti digitali, poiché il servizio di messaggiaia post mortem rappresenta solo una delle molteplici funzioni del sito. Si tratta infatti di siti che affrontano il tema della morte da una prospettiva completamente tanatologica, considerando la morte come fenomeno simbolo dell'esperienza umana da affrontare in maniera aperta, favorendo la riflessione e la valorizzazione dei rituali che la accompagnano, anche tramite pratiche semplici accessibili a tutti, come indica il sito *La mort fait partie de la vie*.

Le identità digitali come identità immortali

Dalla descrizione delle cinque tipologie di siti di casse forti digitali emergono alcuni aspetti che mettono in evidenza la capacità di trasformazione che l'*Afterlife* digitale sta esercitando sull'identità ed in particolare sull'identità digitale.

Infatti, inizialmente l'*Afterlife* si è manifestata in relazione ad una condizione prodotta dal web, una sorta di disfunzionalità –gestire i dati e le informazioni degli utenti deceduti senza infrangere le leggi sulla privacy, i regolamenti dei siti e possibilmente senza urtare la sensibilità dei familiari e degli amici –. Una disfunzionalità percepita dagli interessati come una condizione accidentale rispetto alla quale assumere una posizione in gran

parte passiva. La diffusione dei siti casse forti digitali ha trasformato l'*Afterlife* digitale in un momento di partecipazione attiva, volontaria e programmata dei utenti che si occupano della gestione dei propri dati digitali, delle tracce che essi lasciano e dell'uso che altri potrebbero farne dopo la loro morte.

Si tratta di un'intenzionalità che riguarda la vita futura dei propri dati informatici e delle loro tracce che coinvolge anche le identità digitali degli individui. Varcata i confini della corporeità e integrata la dimensione digitale emersa con il web partecipativo e la diffusione di profili personali nei SNS, l'identità oltrepassa l'ultimo dei propri limiti oggettivi: la fine della vita. Così considerata l'*Afterlife* digitale estremizza le caratteristiche dell'identità digitale fino a renderle problematiche. L'ibridazione, ad esempio è uno degli aspetti caratterizzanti l'identità digitale, che in questo senso è il prodotto dell'ibridazione tra le dimensioni fisica e digitale dell'individuo. Con l'*Afterlife* digitale l'ibridazione viene spinta oltre i suoi confini, poiché alle dimensioni fisica e digitale si aggiunge quella *post mortem* attivata dai servizi di messaggiera, una dimensione propriamente immortale.

In questo senso, l'identità *post mortem* implicata dall'*Afterlife* digitale rientra nel progetto riflessivo che coinvolge il sé tout court. Un progetto che sembra avvicinarsi sempre di più alla realizzazione del desiderio umano di immortalità e, di conseguenza, di un'identità immortale. Così considerata l'immortalità digitale presenta degli aspetti caratteristici che non si ritrovano nei tentativi precedenti di realizzazione. Nel passato l'immortalità ha avuto come unica via di realizzazione la memoria dei rituali di commemorazione. Si è sempre trattato di una forma di sopravvivenza *post mortem* in cui la memoria si è dimostrata uno strumento particolarmente efficace per quanto riguarda gli eroi, i grandi uomini, i personaggi celebri la cui appartenenza alle élites attivava un potere di sopravvivenza – di immortalità – pubblica (Gamba, 2014).

L'*Afterlife* digitale, al contrario, tramite la gestione dei dati *post mortem*, rende l'accesso all'immortalità non una condizione straordinaria definita dallo status del defunto e attivata dalle pratiche di commemorazione dei sopravvissuti, bensì una condizione comune alla quale tutti possono avere accesso: quasi totalmente gratuite le casse forti digitali mettono a disposizione dell'utente una tecnologia intuitiva per realizzare la propria identità immortale in modalità selfmade e integrarla nella vita quotidiana.

Non si tratta però soltanto di una semplificazione della produzione di contenuti digitali o di una democratizzazione dell'immortalità. La pianificazione della propria *Afterlife* digitale pone l'utente di servizi web

nella condizione di costruire in modo attivo la propria immortalità, prevedendo o solo immaginando anche un feedback alle sue pratiche proiettate nel futuro: le reazioni degli amici e dei familiari ai suoi messaggi, di conseguenza un dialogo ideale con i sopravvissuti e una presenza di sé che sopravvivono oltre la morte.

Lo spazio dell'azione delle identità immortali

Gli strumenti ICT dell'*Afterlife* digitale hanno anche l'effetto di ridisegnare lo spazio d'azione dell'utente che ingloba in un continuum l'orizzonte della vita e l'immortalità. Non si tratta di una semplice estensione degli effetti dell'azione umana poiché questa ha sempre oltrepassato i limiti delle singole vite: da questo punto di vista gli artefatti culturali sono il segno di una sopravvivenza che va al di là della vita dei loro produttori; le azioni hanno, in virtù delle mediazioni a cui sono soggette, degli "effetti a distanza" (Thompson, 1995). Allo stesso modo si possono ritrovare delle analogie tra i servizi proposti dalle casse forti digitali ed altre pratiche consolidate come ad esempio il testamento, analogie sottolineate anche dalle forme mediali condivise: non è raro infatti che il testamento sia videoregistrato, così come avviene per molti messaggi digitali *post mortem*. In entrambi i casi è presente l'intenzione di raggiungere i familiari e di mantenere un legame con loro oltre la morte. Nel caso del testamento tuttavia si tratta di un messaggio *una tantum*, mentre la messaggeria digitale prevede l'iterazione e la continuità, come se i messaggi potessero davvero entrare a fare parte della vita quotidiana dei familiari e in questo modo permettessero all'individuo di farne ancora parte.

In questo caso lo spazio d'azione dell'utente estende i propri confini seguendo un procedimento tale per cui non sono soltanto le azioni, le intenzioni, i desideri individuali e i loro effetti ad oltrepassare i limiti spazio-temporali della vita umana. È invece il futuro, eccedente tali limiti, che grazie all'*Afterlife* digitale entra nello spazio d'azione dell'individuo producendo una forma di interazione rispetto alla quale non abbiamo ancora modelli interpretativi collaudati. Le varietà di questa forma che vanno dalle manifestazioni più semplici dei siti *Social* o *Financial*, a quelle più articolate e complesse del tipo *Creative* o *Relationship*, mostrano una scala di intensità nelle pratiche offerte dalle casse forti digitali, che incide sul significato simbolico attribuito dagli utenti a questi servizi: la gestione dei propri dati esistenti sul web ha un significato diverso rispetto al valore affettivo di un messaggio realizzato interamente per i propri familiari. Si

tratta di forme diverse, che tuttavia convergono sul medesimo aspetto :l'estensione dell'identità digitale oltre i confini stessi del digitale.

Dall'immortalità all'Afterlife digitale

Le casse forti digitali e il servizio di messaggeria post mortem rappresentano la versione digitale, di un desiderio di sopravvivenza che ha origine con l'uomo stesso e con la consapevolezza della morte. Tuttavia, non si tratta di un desiderio di sopravvivenza tout court. Non c'è infatti nelle pratiche legate all'offerta delle messaggerie post mortem una esplicita richiesta d'immortalità, né possono essere ricomprese nel mito dell'amortalità, non essendo qui in questione la sopravvivenza del corpo. Ciò che questi siti offrono è l'immortalità dell'identità, la sua permanenza volontaria pianificata dagli utenti. Questo è particolarmente evidente se riconsideriamo i servizi offerti dai siti di casse forti digitali alla luce degli effetti sull'identità. Le tipologie più semplici – *Social* e *Financial* – presentano l'identità immortale come una specie di manutenzione postuma dell'identità degli utenti, risultato sia di un'efficienza digitale che di un compiacimento estetico della permanenza della propria identità. La traccia digitale dell'utente dopo la morte è una forma di sopravvivenza dell'identità digitale. Le tipologie *Creative* e *Relationship*, insistono invece sull'estensione volontaria dell'identità digitale per quanto riguarda l'elemento di interazione che supera l'ambito strettamente digitale. I supporti digitali, organizzati in maniera personalizzata, sono usati in maniera attiva e strumentale, non soltanto come nei SNS per esprimere la propria identità digitale, ma anche per estenderla oltre i suoi limiti proprio attraverso l'interazione postuma con familiari e amici. In altri termini, ciò che queste tipologie di siti aggiungono rispetto alle caratteristiche iniziali dell'*Afterlife* digitale sono la consapevolezza e l'intenzionalità da parte dell'utente di estendere la propria identità digitale – un ibrido tra dimensione fisica e dimensione digitale – all'identità immortale intesa come ibrido ulteriore a cui si integra anche la dimensione futura post mortem. Infine, la tipologia *Thanatological* se da un punto di vista digitale non aggiunge particolari acquisizioni all'*Afterlife*, vale a dire non estende in maniera sostanziale le possibilità dell'identità immortale, dal punto di vista del significato della morte per le identità digitali mette in luce come l'identità digitale sia una narrazione personalizzata in cui la morte occupa una posizione importante inseparabile dalla vita come mostrano le iniziative di tipo diverso ospitate dai siti: analisi della morte nei prodotti mediali, scambi e incontri che si

realizzano nel mondo fisico, a cui si aggiunge la messaggeria *post mortem*. Come indica il nome di uno dei siti appartenente a questa tipologia, *La mort fait partie de la vie*, l'interazione tra i vivi e morti – attuali e futuri – è la chiave di lettura delle identità digitali intese come identità immortali.

Tali forme di identità immortali indicano uno spostamento di attenzione da un'idea di immortalità trascendente (o di un'amortalità che si estende anche alla durata del corpo) a un *Afterlife* immanente, che implica una trasformazione altrettanto importante riguardo al desiderio di sopravvivenza. Se l'immortalità è l'espressione di un progettarsi – del tutto incerto e immaginario – nel futuro, al di là dell'orizzonte spazio/temporale soggettivo, l'*Afterlife* segue un procedimento inverso: attirare il futuro della sopravvivenza del soggetto all'interno del suo stesso orizzonte spazio/temporale e nel caso specifico della sua identità digitale. Detto altrimenti, l'*Afterlife* trasforma l'immortalità da sogno irrealizzabile a progetto digitale pianificato, in cui l'utente interviene direttamente producendo la propria immortalità.

Conclusioni

In questo paper ho discusso il recente fenomeno dell'Afterlife digitale e delle sue ricadute. Inizialmente apparso come gestione dei dati digitali post mortem degli utenti da parte di siti specializzati, noti come casse forti digitali, si è rapidamente caratterizzato anche come occasione per estendere l'identità digitale oltre il confine della vita: una realizzazione digitale del sogno umano di immortalità. Infatti, le casse forti digitali nei propri pacchetti di servizi offrono non solo la gestione di dati riservarti ma anche la messaggeria post mortem: la possibilità per l'utente di inviare messaggi ai propri familiari ed amici dopo la propria morte. Le diverse combinazioni di questi servizi hanno permesso di individuare 5 tipologie di siti, dalla più semplice alla più complessa, che implicano livelli differenti di coinvolgimento delle identità digitali nella produzione delle identità immortali che in questo senso sono il prodotto rispettivamente di una *manutenzione* dei dati digitali affidata dagli utenti agli amministratori; di una *interazione* con i propri cari organizzata a partire dai dati digitali dagli utenti tramite i servizi post mortem offerti dai siti; di un *coinvolgimento*, tramite i dati digitali, in un discorso più ampio sulla morte. L'estensione dell'identità digitale come effetto dall'*Afterlife* digitale presenta nondimeno qualche aspetto problematico. Infatti, il termine *Afterlife* digitale non indica un fenomeno univoco, l'analisi dei siti a fatto emergere che per certi aspetti

è un fenomeno digitale inerente esclusivamente alla tecnologia, mentre per altri aspetti è un fenomeno esistenziale che interessa il significato simbolico della morte e dell'immortalità. Un aspetto questo che complica la sua analisi che deve essere al tempo stesso tecnologica e socio-antropologica. Ciò che invece rappresenta una costante dell'*Afterlife* digitale è il fatto che l'identità digitale la integri sempre più come proprio elemento costitutivo. Come indicano alcune proiezioni, la tendenza per il futuro è che l'identità digitale sarà principalmente un'identità immortale, post mortem, considerando il fatto che la percentuale della presenza degli utenti deceduti nei SNS, come Facebook ad esempio, sarà pari o superiore a quella degli utenti vivi (<http://www.webpagefx.com/blog/internet/happens-online-presence-die-infographic/>). Si tratta di una di una condizione da realizzare ancor prima che da analizzare, della quale tuttavia disponiamo già di molti elementi anticipatori come l'analisi delle tipologie dei siti che offrono il servizio di casse forti digitali ha fatto emergere.

Bibliografia

- Bauman, Z. (1998) *La società dell'incertezza*. Bologna: il Mulino.
- Bauman, Z. (1997) *Postmodernity and its Discontents*. Cambridge: Polity Press.
- Belk, R.W. (2013) Extended Self in a Digital World. *Journal of Consumer Research*, 40 (3), 477-500.
- Benski, T. and Fisher, E. (2013) *Emotions and the Internet*. London: Routledge.
- Bradwell, P. and Gallagher, N. (2007) *We no longer control what others know about us, but we don't yet understand the consequences*. London: Demos.
- Brubaker, J.R. (2013) The afterlife of identity. Paper presented at the proceedings of the 2013 conference on Computer supported cooperative work companion. S. Antonio. Texas: ACM New York.
- Cardon, D. (2008) Le design de la visibilité. Un essai de cartographie du web 2.0. *Réseaux*, 26, 93-137.
- Cardon, D. (2009) L'identité comme stratégie relationnelle. *Hermès La Revue*, 1, 61-66.
- Carrol, E. and Romano, J. (2011) *Your Digital Afterlife: When Facebook, Flickr and Twitter Are Your Estate . What's Your Legacy?* Berkeley: New Readers.

- Davies, D. and Park, C.W. (2012) *Emotion, identity and death*. Aldershot: Ashgate.
- De Vries, B. and Rutherford, J. (2004) Memorializing Loved Ones On The World Wide Web. *Omega: journal of death and dying*, 49 (1), 5-26.
- Donath, J. and boyd, D. (2004) Public displays of connection. *BT Technology Journal*, 22 (4), 71-82.
- Elias, N. (1939, 1987) *Die Gesellschaft der Individuen*. Frankfurt am Main: Suhrkamp
- Elster, J. (1985) *The Multiple Self*. Cambridge: Cambridge University Press.
- Fecht, T. (1996) *Namen und stein: mémoire nomade*. Berlin: Deutsche AIDS-stiftung.
- Gamba, F. (2007a) La mort en Réseau: une re-sacralisation postmoderne. *International Review of Sociology-Revue Internationale de Sociologie*, 17 (1), 135-148.
- Gamba, F. (2007b) *Il gioco e il tabù*. Napoli: Ipermedium.
- Gamba, F. (2014) *Pouvoirs de survie: du mythe de l'amortalité aux pratiques d'immortalité*. In Costantopoulou, C. (eds.), *Médias et Pouvoir. Hommage à Louis-Vincent Thomas*. Paris: L'Harmattan.
- Giddens, A. (1991) *Modernity an Self Identity*. Stanford: Stanford University Press.
- Glässer, U. and Vajihollahi, M. (2010) *Identity Management Architecture*. In Yang, C.C., Chau, M. and Wang, J.H. (eds.), *Security Informatics*. New York: Springer.
- Hintermayer, P. (1988) La pensée-sida. *Actions et Recherches Sociale*, 32 (3), 61-73.
- Jankélévitch, V. (1977) *La mort*. Paris: Flammarion.
- Lardellier, P. and Bryon-Portet, C. (2010) Ego 2.0. Quelques considérations théoriques sur l'identité et les relations à l'ère des réseaux. *Les Cahiers du numériques*, 6, 13-34.
- Leroi-Gourhan, A. (1964) *Le geste et la parole*. Paris: Albin Michel.
- Lasch, C. (1979) *The Culture of Narcissism*. New York, Norton.
- Liu, H. (2007) Social network profiles as taste performances. *Journal of Computer-Mediated Communication*, 13 (1), 252-275.
- Maciel, C. and Carvalho Perera, V. (2013) *Digital Legacy and Interaction. Post-Mortem Issues*. New York: Springer.
- Merzeau, L. (2009) Présence numérique : les médiations de l'identité. *Les enjeux de l'information et de la communication*, 1, 79-91.
- Morin, E. (2002) *L'Homme et la Mort*, Paris: Editions du Seuil.

- Roberts, P. and Vidal, A. (1999-2000) Perpetual care in cyberspace: A portrait of memorials on the web. *Omega*, 40, 521-545.
- Sherr, L. (eds.) (1995) *Grief and AIDS*. Chichester: John Wiley & Sons Ltd.
- Sofka, C., Cupit, I.N. and Gilbert K.R. (2012) *Dying, Death and Grief in a Online Universe: For Counselors and Educators*. New York: Springer.
- Thomas, L.V. (1992) *Le sida: agression, fantasmes, espérances*. In Thomas, L.V. (eds.), *La mort en question: traces de mort, mort des traces*. Paris: Éditions L'Harmattan.
- Thompson, J.B. (1995) *The Media and Modernity. A Social Theory of the Media*. Cambridge: Polity Press.
- Turkle, S. (1995) *Life on the Screen: Identity in the Age of the Internet*. New York: Simon & Schuster.
- Weiser, M. (1991) The Computer for the Twenty-First Century. *Scientific American*, 3 (3), 3-11.
- White, P. (2008) Identity Management Architecture: A new direction. Paper Presented at the Proceedings Of 8th IEEE International Conference, Sydney.

Webgrafia

- After steps (<http://www.aftersteps.com/>)
- Cirrus Legacy (<http://www.cirruslegacy.com/143-definition-of-terms.html>)
- Dead Social (<http://www.deadsoci.al>)
- Docubank (<https://www.docubank.com/>)
- Eterniam (<https://eterniam.com/>)
- If I die (<http://ifidie.net>)
- La mort fait partie de la vie (<http://lamortfaitpartiedelavie.com>)
- LifeNaut (<https://www.lifenaut.com/>)
- Mark Weiser (<http://www.ubiq.com/weiser/UbiHome.html>)
- My Goodbye Message (<http://www.mygoodbyemessage.com/>)
- MyWonderfulLife (<https://www.mywonderfullife.com/>)
- PassingBye (<https://passingbye.com/>)
- RememberedVoices (<http://www.rememberedvoices.com/>)
- Sanctri (<http://www.sanctri.com/resources-for-online-memorials/>)
- Ubiquitous Computing (<http://www.ubiq.com/weiser/UbiHome.html>)
- Webpage FX (<http://www.webpagefx.com/blog/internet/happens-online-presence-die-infographic/>)
- Data di ultimo accesso ai siti: 10 ottobre 2014.

Big Data and Nate Silver's Computational Protocols: predictive Analytics and innovative Digital Methods for the Study of the Political Trends. A critical debate

Michele Infante*

Università degli Studi di Napoli, Suor Orsola Benincasa

This paper tries to discuss and critically address the possibility to combine Big Data with the computational protocols of predictive analytics and its innovatively, cost-effectively and profitably segment/discriminate the political participation on-line methods. Even if elections are dynamic complex systems, Nate Silver tries to understand political correlations between Big Data and political issues. Silvers uses many sources of data (electoral outcomes, historical polls, incorporated historical data) combined with statistical model, in order to extract information from every source looking at trends over time and comparing changes in polls on a long-term basis. If are innovative Silvers's methodologies, more controversial appears his theoretical approach. In some way, we can assume that Silver underestimates other factors that can influence elections, like economic variables, demographics, and party registration figures, and above two main factors. First, the emotional state of voters related to some social phenomena at the top of the agenda—setting in the weeks before the election, then he ignores that the on-line political participation's audience is usually more unsatisfied than the traditional media audience of their political leaders. Bayes's theorem cannot solve all challenges in the world of applied statistics to the Big Data. We discuss the challenges in the science of prediction through Big Data in a wide range of domains (sports, epidemics, earthquakes, economics, and climate change) and compare them to Silver's Methods, and in this sense we debate some critical points and controversial issues.

Keywords: *Big data; sentiment analysis; prediction; social statistic; computational sociology*

* Corresponding author: **Michele Infante** | e-mail: m.infante@unilink.it

The Big Data Age or the 'New Age' of Sociology

The Internet offers data previously unavailable to social scientists and statistics. This new source of data offers enormous opportunities to investigate social and political behaviors through data series. The abundance of digital data on individuals, organizations and institutions stimulate social research. However, this new fields of investigation opens also a debate. On one hand, Chris Anderson claimed that Big Data would make the development of scientific theories and models 'obsolete' (Wired, 2008); on the other the statistician Nate Silver claims that raw data, no matter how extensive, are useless without a model: Numbers have no way of speaking for themselves [...] Data-driven predictions can succeed-and they can fail. It is when we deny our role in the process that the odds of failure rise' (Silver, 2013).

In the January 5, 2006 issue of *Economist*, it's possible to read a column titled 'Bayes rules. A once-neglected statistical technique may help to explain how the mind works' where you can read:

SCIENCE, being a human activity, is not immune to fashion [...] ideas about the prediction of future events from one or two examples were popular for a while, and have never been fundamentally challenged. But they were eventually overwhelmed by those of the 'frequentist' school, which developed the methods based on sampling from a large population that now dominate the field and are used to predict things as diverse as the outcomes of elections and preferences for chocolate bars¹.

This extract is the proof of the presence of the interaction between Big Data (from now BD) and statistical science's issue in the public debate, and in some way signs the starting point on debate between the relation between them. These few lines contain both, the idea of 'fashion' and idea of the possibilities open by this new approach. As the famous *New Age* (New Age refers to the coming astrological 'Age of Aquarius') was a spiritual movement that tried to create a worldview that includes both science and spirituality and embraces a number of forms of mainstream science as well as other forms of science that are considered fringe, so the BD movement looks like in some excesses. In fact, as the New Age movement - developed in the second half of the 20th century - declares that Mind, Body, and Spirit

1 <http://www.economist.com/node/5354696>

are interrelated, the new wave of BD holds to a holistic worldview, emphasizing that there is a form of monism and unity throughout the universe: God is the Data. In fact, whether we should expect an over-reliance on the scientific consistency of big datasets - and in parallel, a neglect of their inaccuracy - is open to debate, but not for BD's theorist, for whom everything can be predicted through Big Data Analysis, Sentiment and Network Analysis. Chris Anderson the theorist of Big Data Age states:

The Petabyte Age is different because more is different. Kilobytes were stored on floppy disks. Megabytes were stored on hard disks. Terabytes were stored in disk arrays. Petabytes are stored in the cloud. As we moved along that progression, we went from the folder analogy to the file cabinet analogy to the library analogy to - well, at petabytes we ran out of organizational analogies (Anderson, 2007)².

If analysing massive quantities of information allows us to look for patterns that might predict future behaviours, how does this influence not only researchers, but political actors, as well (Grimmer and King, 2011; Grimmer and Stewart, 2013)? How is the 'BD way' of producing knowledge about social actors challenging political institutions and public issue sentiment? The Big Data and Opinion Mining Sociologists simply state that by changing the amount of data, we change the essence of them. When we increase the scale of the data, we can research and look at social phenomena that are not possible with smaller amounts. BD could be significant tools for the social research in terms of predictions (Gasperoni, 2013).

To analyse way more data with more exactitude, and at the same time, the Data Mining moves away from the age-old search for causality (Swigger, 2012). BD makes possible through social researcher querying to obtain information in real time on the main public issues (North, 2012; Kantardzic, 2011). In the digital and massive database storage of the information's world, we can analyse more data, and we can obtain artificial sampling fetter before the prevalence of high-performance digital technologies. The access to a huge amount of data and the availability of an increasing number of informatics and statistical tools is changing the way to do social research and elaborate social theory (Miner et al., 2012). Manly, it refers not only to taking and collecting information, but using data science to transform information into ideas, social value and rules, decision making

2 http://archive.wired.com/science/discoveries/magazine/16-07/pb_theory

process, public policy (Foreman, 2013). So we can look at the fact that 'Big Data' (BD) refers to the increase in the scale of datasets, but at the same time of *social complexity of information flux* (Ian et al., 2011).

Nete Silver: gamers, statistician or political media guru (maybe, currently it is the same thing).

The media cover the Nete Silver's career as a media star, and successively looking to his blogs, article, book, as a sort of brand or media group³. Silver is a public figure and more than a statistician. He is a sort of political guru and opinion leaders (also another great theorist of media studies as Marshal McLuhan was a media guru and figured in movie). Before Nate Silver's political prediction prowess landed him a gig at the *New York Times* and guest spots on Comedy Central's *The Daily Show*, there was once a time when he largely relied on his abilities as a poker player. After quitting a job as an economic consultant in 2004, Silver worked on a system for forecasting the performance of *Major League Baseball* players for *Baseball Prospectus*. After leaving Baseball, In 2008 Silver founded his political blog FiveThirtyEight, where he correctly predicted the winner in 49 of 50 states in the 2008 Presidential Election. For this predictions, *Time Magazine* had named him one of its 100 Most Influential People of 2009⁴, in according to the issues: 'name the people who most affect our world'.

Nowadays, with two years until the next midterm elections, Silver is looking to keep his blog, 'no more than about 50% politics in the off-years.' Silver's popularity is currently related to correct predicting the winner in 50 of 50 states in the 2012 Presidential Election (during the United States presidential election between Barack Obama and Mitt Romney, correctly predicted the winner of all 50 states and the District of Columbia). That same year, Silver's predictions of U.S. Senate races were correct in 31 of 33 states; he predicted Republican victory in North Dakota and Montana,

3 Alex Weprin, "The New York Times Wants To Keep Nate Silver, 'Expand On What He Does'", Mediabistro, Nov. 27, 2012. Also see Connor Simpson, "What the Future Holds for Nate Silver at The New York Times," Atlantic Wire, Nov. 27, 2012; "Nate Silver makes move to ESPN," ESPN.com, July 22, 2013; "Nate Silver – Renowned Statistician, Author and Founder of Five ThirtyEight – Joins ESPN in Multi-Faceted Role," ESPN Front Row, July 22, 2013; Sullivan, Margaret (July 22, 2013). "Nate Silver Went Against the Grain for Some at The Times". The New York Times. Retrieved 23 July 2013.

4 The 2009 annual TIME 100 issue, name the people who most affect our world Times On-line http://content.time.com/time/specials/packages/article/0,28804,1894410_1893209_1893477,00.html

where Democrats won. He uses this popularity in order to promote his political blogging and his book *The Signal and The Noise*. In July 2013, it was revealed that Silver and his *FiveThirtyEight* blog would depart *The New York Times* and join ESPN. Silver would become editor-in-chief of the *FiveThirtyEight* site in his new role at ESPN. ESPN would own the *FiveThirtyEight* site and the brand (the ESPN-owned *FiveThirtyEight* launched on March 17, 2014. Silver's lead article explained that the site would focus on a broad range of subjects under the general rubric of "data journalism". Finally, Silver gain popularity and visibility trough a campaign in favor of on-line gaming and poker on-line. Silver went on to mention that his new book features some interviews with professional sports bettor and poker player Haralabos Voulgaris, who has three *World Poker Tour* final table finishes and years of high-stakes cash game experience⁵. 'In the book, I talk to Bob Voulgaris, who is maybe the best sports bettor in the world. Super sharp. Works his butt off. He gets 57% of his *NBA* bets right, not more than that.' Silver has been the special guest to the *World Series of Poker*. He declares that 'my hunch is that the poker community probably underrates how difficult it is to get anything done at the federal level, especially in the near term. But the intersection of the need for more tax revenues, poker having become increasingly mainstream, better lobbying efforts on behalf of the poker community, etc., bodes reasonably well in the medium-to-long term'. Silver's last statement released to the press seems to be a proof of this approach: 'from a public policy standpoint, it's ridiculous that so many states allow the lottery but not online poker - Silver continued - the demographics of poker tend much more toward people who can 'afford' to gamble'⁶.

Anxiety for prediction, anxiety for future in the Bayes' algorithm

As many BD fans, who believe that many aspects of the social world can be finally and definitely forecast, Silver's crucial point is that more data means more accurately and reliably results. More data, more predictions, more accuracy: here is that growing technological sophistication is

5 Political Predictions Guru Nate Silver Talks Legalized Online Poker New York Times Writer And Former Poker Player Discusses Federal Outlook For Web Poker, by Erik Fast,; Published: Nov 15, 2012, <http://www.cardplayer.com/poker-news/14447-political-predictions-guru-nate-silver-talks-legalized-online-poker>

6 Ivi

threatening to bury the world in the pseudo-sophistication of 95 percent confidence intervals and r-squared values. Silver's book, *The Signal and the Noise*, offers a wide range of subjects about which people make professional predictions – the housing market, the stock market, elections, baseball, the weather, earthquakes, terrorist attacks – Silver argues for a sharper recognition of 'the difference between what we know and what we think we know' and recommends a strategy for closing the gap. What Silver has to offer is a lucid explanation of how to think probabilistically. In a promising start, he claims that his model – based on a theorem inspired by Thomas Bayes, the 18th-century English mathematician – has more in common with how soldiers and doctors think than with the cognitive habits of TV pundits. More broadly, forecasts are hampered by 'over fitting,' 'the act of mistaking noise for signal'.

The Signal and the Noise produces eight alternative explanations for Obama's gains after the storm hit – including recent encouraging economic news – Silver concluded that the gains were "over-determined": a lot of variables might have contributed to the one result. He uses the Bayes' theorem says we need to update our old estimate (x), in light of our new evidence (y and z), through the formula:

$$Xy$$

$$xy + z(1-x)$$

Given a series of data points, an analyst can choose between a number of different formulae that 'fit' the information on hand. Given the increasing ease with which complicated calculations can be undertaken, the temptation exists to devise elaborate models that fit the data very closely. But as Silver points out, this often results in over-emphasizing random fluctuations, leading to horrible predictions. Silver model is linear rather than non-linear, is static rather than dynamic, is explicit rather than implicit, discrete rather than continuous, too much probabilistic rather than deterministic. While a deductive model is a logical structure based on a theory, in few words Silver's predicative Protocol seems rather inductive,. An inductive model arises from empirical findings and generalization from them. The floating model rests on neither theory nor observation, but is merely the invocation of expected structure. Application of mathematics in social sciences outside of economics has been criticized for unfounded models. In a statistical linear model, it is assumed that a relationship is linear in the parameters, but it may be nonlinear in the predictor variables.

In some way, the Silver's model use in ambivalent way the concept of risk and uncertainty.

Recognition of the gap is not new: there are plenty of political theorists and scientists droning on about it already, in the manner of the automated voice on the tube when train and platform don't quite meet. Strategies for closing, or at least narrowing are several and act to different level, but in any case the gap between what we know and what we think we know in specific contexts, are rarer, specialized, and probably pretty hard for anyone outside a small circle of experts to understand. In other words, we need some kind of underlying theory to guide our forecast, with the data increasing or decreasing our confidence. The level and sources of variation in the earth's climate, for example, are so great that 'there would be much reason to doubt claims about global warming were it not for their grounding in causality' (Silver, 2012, p. 15). The Bayesian methods put in evidence has our prior understanding of the situation, but is not the situation, because the contingency and risk structural dominate the social life.

Complex Adaptive System and Social Chaotic System can be predicted?

The application of statistic protocols and predictions models to the BD try to find the mechanisms behind apparently unstructured systems (Castellani and Hafferty, 2010; Infante, 2012a; Infante 2012b), but if we can consider the Web as C.A.S. (complex adaptive system) – as I demonstrated in my essay 'The Web as an adaptive complex system. A systemic approach to the Net' - we can read the Net as a form of unsupervised learning platform without any rationality in single agent's action, who didn't know the general form of the system, the single agent has not a comprehensive awareness of the entire system. This fact means that we cannot predicts the single behaviours of the agent-users of the Net, and we cannot make the line between voters and politics, voters and political issues. Many Big Data's Statistician fans don't acknowledge that many political aspects cannot be accurately and reliably forecast. For example, despite a massive effort by scientists, data scientists, and researchers we have almost no ability to forecast an earthquake. This is probably because an earthquake is a chaotic event and we don't have enough information about what is happening under the ground and around the world, i.e. the failure is caused by missing data and compounded by chaos theory.

Silver seems pretend to ignore the nature of 'Chaotic systems'. In according to the Chaotic Theory, a tiny change in the input data can result in a massive change in the outcome event. The best known is the metaphor that the fluttering of the wings of a butterfly in the Amazon can cause a hurricane in another part of the world. In this sense, the Silver's Protocol seems in reference to the social system and political too much deterministic, meaning that their future behavior is fully determined by their initial conditions, with no random elements involved in the analysis. Humanists want to believe that human beings possess an inherently valuable common essence, and this essence has been threaten or manipulated by the media (Luhmann, 2013b; Infante, 2012b). Any critical theory of political communication has the idea that an authenticity of human being exists (Luhmann, 1998, 1995; Infante, 2010). The 'Social Mining' (der *Sozial Sinn*) of BD revolution doesn't answer to a simple logic of cause-effect, but presents several different consequences starting from the same points, in systemic term, it works according to an *equifinality model*, different ways bring to the same results. Moreover, the missing data and the extrapolation problem present in chaotic systems, these can represent a lack of predictability (as states Nassim Taleb in his book *The Black Swan*).

Missing Data on the scale of Big Data can blind people to what is not being measured. For example, a data survey's project might collect a respondent's location through every moment of the day, their online connections, their purchases, and their exposure to advertising. Surely that is enough to estimate their behavior?

Not if their electoral behavior depends on things such as family political values or tradition (someone in opposite to father's one), their schooling experiences, their economic expectations, the influence of pairs more than opinion leaders, pop-star or hip-hop music than editorials in newspaper, etc.. Silver highlights this issue as politic system can be in comparison with the context and the system of earthquakes. The limited explanatory power of many political research models raises the question about how much the lack of consistent accuracy arises from missing information. As the earthquake illustration shows, missing information, especially in a complex system, can have massive consequences.

Data for everything doesn't mean that everything can be predicted

Civic society, citizens and public are massively present on-line and use the Net for their communications on politics and public issues. Political blogs, political independent news coverage, a digital agenda setting, political Twitter, Facebook political leader's pages, can increase the political consciousness of electoral audience; and at the same time, they can increase the reliability of policy making through transparent and traceable, consistent and replicable results (Parmelee, 2013; Grimmer and King, 2011; Grimmer and Stewart, 2013). Silver shows how the quality and accuracy of weather forecasts have improved radically over the last twenty five years, but he also highlights two tests that are highly relevant to anybody seeking to make forecasts about markets and consumers. Any 'good' prediction scheme should be able to beat complexity (Castellani and Hafferty, 2010; Neuendorf, 2002). Despite what Silver showed, as for the weather, despite the improvements in weather forecasting, its chaotic nature persists. For example, in their books *Politics and the Twitter Revolution: How Tweets Influence the Relationship between Political Leaders and the Public*, two scholars as Parmelee and Bichard try to describe the public sphere of the Digital Society analyzing the Big Data produced by Twitter (Parmelee and Bichard, 2011). But as we increasingly rely on big data's numbers to speak for themselves, we risk misunderstanding the social phenomena and the results of research on important public issues (political participation, democracy and decision making).

As Shvetank Shah, Andrew Horne and Jaime Capellá write in their 'Good Data Won't Guarantee Good Decisions', because BD doesn't speak by themselves we need social meaning and cultural interpretation of data. Even if the ability to gather, store, access, and analyze data has grown exponentially over the past decade, the result of social monitoring the Web in analytics can be still useless, even harmful, and above all, it is still difficult to incorporate the info-visualization of data into complex decision-makings (Shah et al., 2012). Research on the effective use of information and communication technologies suggests that BD's technology can make important contributions to the social research, but also can present some misunderstanding around voters' sentiment. Advancements in big data analysis offer cost-effective opportunities to improve opinion mining and social research on relevant issue, but data don't speak alone, they need a

cultural and socio-economic interpretation of scholars (Pang and Lillian, 2008).

In some critical development areas such as digital democracy, social participation, transparency, they can give data, but it will be always the decision makers to interpret them. In this sense, data mining offers great opportunities and resources to social sciences (North, 2012; Kantardzic, 2011; Han, Kamber and Jian Pei, 2011). Many applications show that data analytics can provide huge benefits for social research and publicity, and an encouragement to consider alternatives in policy making. Of course, the BD statistical analysis can provides innovative consultancy services for e-Governance and evident benefit for Politics, e.g. policy modeling, nurture further research, bring advancements in ICT, scenario generation based on the Agent-Based Computational Sociology (Squazzoni, 2012; Sang and Bos, 2012). The statistical and predictive use of digital data can be fundamentals for policy stakeholders as government agencies and NGOs (Davenport and Siegel, 2013; Davenport and Kim, 2014; Jiawei Han et al., 2011); but the data cannot predicts any aspect of social life. Data scientists and statistics make usually reference to biologists, medicines and especially genetics scientists, who have a long history asking where the data they're working with comes from, what methods were used to gather and analyze it, and what cognitive biases they might bring to its interpretation; however, we must ask how we can apply BD statistics not the something that chance slowly as a results of a long biologic evolution process but change in every moment and constantly as the digital data, in this case we need 'living analytic Methods for the Social Web' (Diaz-Aviles, 2013; Gwet, 2008; Williams and Vogt, 2011).

Social media as 'a double observation' of political issues

Silver model could be a 'great equalizer', it seems to make everything comparable to everything; in fact, once information has been warehoused and made available in a database, we begin to think of it as all being comparable. Where is the wisdom? Mostly political data and information are meaningless without wisdom. Wisdom can come from small data or from details, rather than a huge amount of them. Often Wisdom is what sets up the hypotheses that can then be analyzed by statistical protocols. Data are created by the researchers. As we give data, their voice we are well served to reinforce them and create an agenda-setting issue based on them; otherwise, we risk becoming myth-builders rather than storytellers. For

example, in a paradoxical way, the result of a search's query on Google is more accurate on commercial issues than on other information. Google is able to search for the favorite books, pizza, train timetables, etc., but less for thinking that have not commercial relations (e.g. a hobby or political activism, democratic issues). Google uses the users' location to match information more than other information.

The Silver's methodology cannot work in area and region where there is a little flux of digital data (Sakaki, Okazaki and Matsuo, 2013), even if it is a natural disaster far from the city (e.g. the Sandy-Hurricane). In fact, there was much more going on outside the privileged-urban experience of Sandy that Twitter data failed to convey, especially in the aggregate (e.g. a book as Geographic data mining and knowledge discovery by Harvey Miller and Han, 2009). The data are assumed to accurately reflect the social world, but there are significant gaps, with little or no signal coming from a particular community (Crooks et al., 2012). While massive datasets may feel very abstract, they are intricately linked to physical place and human culture (de Groot Roy, 2012). And places, like people, have their own individual character and grain. A first example of Big Data as Big Error, we can look at two main examples measuring the first one, the peak of Flu by Google Trends and the tweets about Sandy in order to allocate disaster relief aids. Declan Butler in his article on Nature titled 'When Google got flu wrong' states as US outbreak foxes a leading web-based method for tracking seasonal flu.

In fact, Google Flu Trends mistakenly estimated that peak flu levels reached 11% of the US public flu season, almost double the CDC's estimate of about 6%. While Google will not comment on the reason for the overestimation, it seems likely that it was caused by the extensive media coverage of the flu season, creating a spike in search queries. Similarly, we can imagine the substantial problems if we look at the tweets about Sandy to allocate disaster relief aid. As the geographers Michael Crutcher and Matthew Zook noted, after Hurricane Katrina, in their article 'Placemarks and waterlines: Racialized cyberscapes in post-Katrina Google Earth' in the *Geoforum Journal*, technologies are always differentially adopted, and 'any divide in accessing digital technology is not a one-time event but a constantly moving target as new devices, software and cultural practices emerge' (Crutcher and Zook, 2009, pp. 523-534). The new availability of huge amounts of data, along with the statistical tools to crunch these numbers, offers a whole new way of understanding the world. Correlation supersedes causation, and science can advance even without coherent

models, unified theories, or really any mechanistic explanation at all (Miner et al., 2012). Chris Anderson former *Wired* editor-in-chief, in his article 'The End of Theory: The Data Deluge Makes the Scientific Method Obsolete' on *Wired Magazine* in 2008 states that 'with enough data, the numbers speak for themselves' (Anderson, 2008). Chris Anderson make a comparison between the Darwin Methodology of Pre-Big Data Age and Craig Venter's one. Craig Venter is an American biochemist, geneticist, known for being one of the first to sequence the human genome and the first to transfect a cell with a synthetic genome. Chirs Anderson claims deserve to be transcript:

If the words "discover a new species" call to mind Darwin and drawings of finches, you may be stuck in the old way of doing science. [...] All he has is a statistical blip — a unique sequence that, being unlike any other sequence in the database, must represent a new species. This sequence may correlate with other sequences that resemble those of species we do know more about. [...] But besides that, he has no better model of this species than Google has of your MySpace page. It's just data. By analyzing it with Google-quality computing resources, though, Venter has advanced biology more than anyone else of his generation⁷.

But can statistic really deliver on that promise? Can numbers actually speak for themselves?

On the contrary, according to the claim 'with enough data, the numbers speak for themselves', we know they can't. Data and data sets are not objective; they are creations of human design. We give numbers to their voice, draw inferences from them, and define their meaning through our socio-cultural interpretations. Hidden biases in both the collection and analysis stages present considerable risks, and are as important to the big-data equation as the numbers themselves (Infante, 2013).

For example, the Hurricane Sandy generated more than 20 million tweets between October 27 and November 1 on Twitter (Crawford, 2013)⁸ even from persons very from the area interested by Hurricane. A fascinating study combining Sandy-related Twitter and Foursquare data produced some expected findings (grocery shopping peaks the night before the storm) and

7 Anderson C., (2007) 'The End of Theory: The Data Deluge Makes the Scientific Method Obsolete', in *Wired Magazine* 16, but I think also to the blog http://political-scientist.blogspot.it/2008_07_01_archive.html.

8 Crawford K (2013) 'The Hidden Biases in Big Databy' in Harward University Press, HBR Blog Network 2:00 PM April 1, 2013, <http://blogs.hbr.org/2013/04/the-hidden-biases-in-big-data/>

some surprising ones (nightlife picked up the day after-presumably when cabin fever strikes). It's not a case, that Silver observes that the most accurate forecasters tend to have a superior command of probability, and they tend to be both humble and hardworking. They distinguish the predictable from the unpredictable, and they notice a thousand little details that lead them closer to the truth. Because of their appreciation of probability, they can distinguish the signal from the noise.

With everything from the health of the global economy to our ability to fight terrorism dependent on the quality of our predictions, Nate Silver's insights can be an essential key for reading social political change. People in lower income groups are less likely to have smartphones, and this is particularly true of older residents, where smartphone penetration can be as low, this means that smartphone datasets are missing inputs from significant parts of the population - often those who have the fewest resources. A mathematical model usually describes a system by a set of variables and a set of equations that establish relationships between the variables, cannot work deterministically for a social system. Even if variables can be of several types (Boolean values or strings, real or integer numbers, etc.), they represent some properties of the system, for example, measured system outputs often in the form of signals, timing data, counters, and event occurrence (yes/no), but never the system as a whole.

Weakness and critics of Sentiment Analysis for the Political Issues

The *Sentiment Analysis* uses a statistical approach rather than plain computer science, all the Big Data of Net-activity (blogs, social media, twitter, post, tag...) are divided in according to the automatic reporting by a web crawler or net-robot. Because, although the subject matters and methodologies in social science differ from those in natural science or computer science, several of the approaches used in contemporary social simulation and BD analysis is originated from fields such as physics and artificial intelligence (Baba et al., 2012). Differently from the traditional content analysis, the sentiment analysis of the social media does not make use of ontological dictionaries but a statistical engine for automatic and supervised monitoring of the Web.

Nevertheless, we register many critics towards automatic sentiment analysis. First, given the current size of the Web, even large search engines cover only a portion of the publicly available part. A 2005 study showed that

large-scale search engines index no more than 40-70% of the indexable Web (Gulli and Signorini, 2005). Secondly, the critics originate from companies producing software for sentiment analysis and their overpromises. Examples like above are often mistakenly cited solely as obstacles to automatic sentiment analysis, when they are just as applicable to human analysis. To perform accurately and judge statements like these correctly, humans need to be fully informed of the related context, background, standards and so on – machines are no different (Ceron, Curini and Iacus, 2013). The software companies exaggerate its accuracy and the extent to which it can replace human analysis as a generic tool that is capable of processing almost any data at any time (Khurshid, 2013). Of course, the *Statistics Analysis* is not a replacement for human-research and traditional opinion mining and behavioral analysis, just like a printer doesn't replace an artist although both produce pictures. By it can capture the 'general sentiment' of the net-users on some main political topics. Using all the data, lets us see details we never could when we were limited to smaller quantities (Han, Kamber and Pei, 2006). However, we have mainly three limits or obstacles in order to apply Data Mining and Statistics Analysis to the web and to its community, one his about humans, the other regards the machine, the last one about interpretation of data (Ceron, Curini and Iacus, 2013; Gayo-Avello, Metaxas and Mustafaraj, 2011; Ramezani, 2013). Can they understand if 'good' is actually 'bad' in a certain context? Actually, for the social media platform and Sentiment Analysis Companies they can. The secret of effective automatic sentiment analysis is based on an understanding of two main problems: domain-dependency and time-dependency (Russell, 2011). The first one, domain-dependency means that a machine that classify reviews on restaurant or on foods will not perform well on political debates, we have error on the attribution of a category to a domain. Time-dependency refers to when a classifier becomes ineffective after a certain period: the language or topics might have changed so that the classifier doesn't 'understand' the data in the same way as before. In few words, there are mistakes in correlations and in the change time by time of this correlations (yet *The Signal and the Noise* is also a reminder that in a sense Silver's skills are wasted on election forecasting). The innovative methods for data mining and social media monitoring using a digital platform permit that the tracking input data change so that it will be able to notify when a classifier is becoming ineffective (Baba et al., 2012). These methods are capable of looking at a query and automatically choosing the most appropriate classifier (of the many available) based on the phrases used in the query

(Jiawei, Kamber and Jian Pei, 2011). When tables contain thousands or even millions of rows of data, this matching process can be very intensive and time consuming on even the most robust computers (Scharnow and Vogelgesang, 2011). Because the linguistic expressions are often only fully comprehensible with additional contextual and background information – the linguistic query and text mining information can't be misunderstood by the software machine (Feldman and James, 2007). Many of the most persuasive examples focus on illustrating how poor machines are at understanding emotions expressed through the complexities of human language. It's not hard to find criticism of automatic sentiment analysis Humans are better and accurate than machines when they have to decide what is positive, what is negative and what is neutral (Ceron, Curini and Iacus, 2013).

Conclusion: from 'datification' to prediction and back (re)datification.

We know that data insights can be found at multiple levels of granularity, and by combining methods such as ethnography with analytics, or conducting semi-structured interviews paired with information retrieval techniques, we can add depth to the data we collect. Friedemann Mattern and Christian Floerkemeier: 'smart objects play a key role in the Internet of Things vision, since embedded communication and information technology would have the potential to revolutionize' (Friedemann and Floerkemeier, 2010:, pp. 107–121). We get a much richer sense of the world when we ask people the why and the how not just the 'how many'. Without a general theory of digital media, we are not able to see the aquarium, the tank in which the users move as a *Complex Adaptive System* (Infante, 2012). While sociology looked at the gold fish in the tank, today sociologists can see the track left by the gold fish in the water; but looking at these tracks can sociologists describe what the water is?

In the 11 February 2011 issue, *Science* joins with his related supplements - Science Signaling, Science Translational Medicine and Science Careers - provided a broad look at the issues surrounding the increasingly huge influx of research data. This collection of articles highlights both the challenges posed by the data deluge and the opportunities that can be realized if we can better organize and access the data (*Science*, 2011, p. 11). In according to the *Science's* editors, the amount of stored information grows four times faster than the world economy, while the processing power of computers

grows nine times faster (Hilbert and López, 2011). Statisticians are trained to recognize correlation not conclusions, results or prediction should not be drawn simply on the basis of correlation between X and Y (it could just be a coincidence). Once you have a model, you can connect the data sets with confidence, but when a theoretical model is missing you cannot have conclusions. Data without a theory as interpretative and hermeneutic model are just noise.

From the Era of simply posting entries on keywords, march forward Sentiment Analysis towards the innovative next level of social media research based on the Agent-Based Social Systems (Deguchi, 2010). The digital network is a new form of 'the virtual circle of complexity' and the web - as a complex adaptive system - is a collection of interacting adaptive agents. As we have seen, as in the Age of Big Data, the Web became a sort as a Social Memory Storage and Connective Social-Brain (Infante, 2012). In a big-data world, we won't have to be fixated on causality; instead, we can discover patterns and correlations in the data that offer us novel and invaluable insights.

The correlations may not tell us why this happens but just alert us that this is happening (Ramezani, 2013). Social network analysis views social relationships in terms of network theory (Allan, 2002), consisting of nodes (representing individual actors within the network) and ties (which represent relationships between the individuals, such as friendship, kinship, organizations, sexual relationships, etc.).

It should never be claimed that automatic analysis can be solely independent or speaks by itself or that human analysis is no longer necessary; automatic analysis in its current state should be thought of as a supplement to human analysis rather than a substitution and BD give us an imperfect approach to the simulation and its discontents, ambiguity and complexity. Using computer simulations, complex statistical methods, and analytic approaches like social network analysis, the computational sociology develops and tests theories of complex social processes through bottom-up modeling of social interactions (Squazzoni, 2012). Using all the data at hand instead of just a portion of it, statisticians have shown that sampling precision improves most dramatically with randomness, not with increased sample size. However, on the other hand, the statistical approach to the Big Data for social research it also a reduction of social meaning (Erwin, 2013). Complex social phenomena are random sampling has been a huge success and it is the backbone of modern measurement at scale. The concept of sampling no longer makes as much sense when we can harness

large amounts of data, because the sampling process in the Big Data's Age loses too much details. Anyway, in some case sampling is synonymous of simplification, so the contingent and unpredictable behavior of digital audience is 'dataficate'. The risk in applying to the BD the Statistic is the *datafication ideology*, the fact that we lose in accuracy at the micro level while we gain insight at the macro level. So the BD's statistic scholars try to understand the vote through the interaction among social agents and the effect of these interactions on the social aggregate. The data sampling is artificial fetter before the prevalence of high-performance digital technologies (Erwin, 2013). We need innovative models and algorithms to collect, pre-process, analyze, and evaluate data, from various fields such as statistics, system theory, machine learning, pattern recognition, or computational intelligence. We need to learn more about the most important methods and algorithms for data analytics and apply the traditional software for the social research to this new challenge, in order to be able to choose appropriate methods for specific tasks and apply these in your own data analytics projects. But we have to avoid the *datafication* as a form of simplification of *data mining* process, and to have an overview the basic concepts of the growing field of data analytics, which will allow you to keep pace and to actively contribute to the advancement of innovative methods in data research. BD's ascendancy represents a shift in the way we analyze information that transform how we understand and organize society (Davenport et al., 2013). The hype becomes problematic when it leads to what we can call 'data fundamentalism' or so-called *datafication*, the notion that correlation always indicates causation, and that massive data sets and predictive analytics always reflect objective truth (e.g. particularly looking at the book of Harvard Scholar, Thomas Davenport). In any case, we cannot underestimate that data and above all the datasets are not objective; they are creations of human design. We give numbers to their voice, draw inferences from them and define their meaning through our interpretations. Now if one wants to buy a product, he/she is no longer limited to asking his/her friends and families because there are many product reviews on the Web, which give opinions of existing users of the product. It may no longer be necessary to conduct surveys, organize focus groups or employ external consultants in order to find consumer opinions about its products and those of its competitors because the user-generated content on the Web can already give them such information. Hidden biases in both the collection and analysis stages present considerable risks, and are as important to the big-data equation as the numbers themselves (North,

2012; Kantardzic, 2011). What we really need is not big data but, to use Crawford's state, data with depth. Big data is not necessarily big in absolute terms. What classifies them as BD is that instead of using the shortcut of a random sample, data as much of the entire dataset as feasible are used. Using all the data instead of a sample isn't always necessary (Sathi, 2013; Liu, 2010).

So the possibility to harness 'actual' data instead of statistically-defined portions of reality might give rise to neo-positivist claims for objectivity. The real revolution is not in the machines that calculate data, how we use them. Social science methodologies may make the challenge of understanding though big data complex social phenomena and the trend of political communication or sentiment, but they also bring context-awareness to research to address serious signal problems. Then we can move from the focus on merely 'big' data towards something three-dimensional: data with depth.

Even if the DB Analysis for its theoretical and empirical consequences on social research is changing the epistemological and methodological study of social sciences and the relation between technology and society, it could be risky to reduce the research to a *datification*. On one hand, using vast process-produced datasets instead of survey-produced samples, will be the future of matters and represents in a global society the most avant-garde of disciple, on the other, we still need a clear comprehension of the digital social subjectivity and social simulation of global phenomena involved huge numbers of social-agent (Han, Kamber and Pei, 2011)

Harnessing vast quantities of data rather than a small portion means also privileging more data of less exactitude than selected data of more accurate. However, it is clear that the age of representative samples, long timelines, and statistics based on the normal distribution is passing. New approaches such as insight communities, social media research, Big Data, mobile market research and Bayesian analytics are the tools of the day, demanding new mindsets. Marketers, market researchers, and insight professionals need to find ways of using the new tools and approaches to ensure that they improve their ability to forecast future outcomes, to understand what can and cannot be forecast and how to make this information useful to decision makers. The arrival of Big Data is not a reason for businesses to sit back and assume that this will solve all their needs. One major challenge for marketers, market researchers, and insight professionals is to become knowledgeable users of Big Data and Bayesian thinkers. Companies who do not gain an overview of what Big Data is, and

what it can and can't do, are likely to be seen as easy targets by aggressive sales teams looking to create momentum and to sell, what can be in some cases, the modern day equivalent of snake oil techniques. You can build elaborate models showing that past recessions can be accounted for by 'shocks' to technology or people's desire to work hard. This 'explains' the observed fluctuations in the business cycle in a mathematical sense, but it should be obvious that it doesn't actually explain anything. It's no coincidence that such methods are completely useless in producing policy-relevant forecasts, even as their fans are quite adept at continually fitting new events into the model. *FiveThirtyEight's* predictive content - essentially a daily reassurance to liberals that, yes, Obama is winning - is interspersed with little essays on the political geography of different states. That epic primary battle aside, the conventional pollsters' methods are pretty darn good at telling you who's winning. But plenty of fields aren't that good at predicting anything. Silver probably can't crack the underlying science of earthquakes, but mainstream economic forecasting is an embarrassing mess despite a wealth of relevant data. Silver might be able to more greatly improve our understanding if he turned his attention to the problem in a more sustained way. It is not certain that Nate Silver's prescriptions and recommendations for the process of forecasting human behavior and intentions will prove to be as useful or as long lasting as George Gallup's were in 1936. However, it is clear that the age of representative samples, long timelines, and statistics based on the normal distribution is passing. The risk is that the statistical analysis of data produce just other data, from the *datification of political issues* (in these case of complex political system) we reach a new *datification*, the data coming out and produces as result by predictive and analytics protocols.

However, new approaches such as insight communities, social media research, Big Data, political sentiment research are currently necessary and useful; predictive analysis seems to speak around data through data. Moreover, the Bayesian analytics is still one of the main tool and predictive protocol, even if it deserves and demands for a new mindsets. Sociologists and political researchers need to find ways of using the new tools and approaches to ensure that they improve their ability to forecast future outcomes, to understand what can and cannot be forecast, and how to make this information useful to decision makers. However, the arrival of Big Data is not a reason for sociologists to sit back and assume that this will solve all investigations questions, and leave software do predictions. In many ways Big Data and statistical protocol creates as many problems as it

solves and the solving of these new problems is likely to require the involvement of the human mind, the development of hypotheses, and the application of market research. Despite that, Silver never succumbed to the temptation to tweak his model, he seems to state that the only thing that changed is the incoming data.

If Silvers's methodologies are to be considered innovative – as we have seen - more controversial appears his theoretical approach. In some way, we can state that Silver underestimates other factors that can influence elections (media issues, unemployment rate, emotional news, campaign building process, etc.). One major challenge for political sociologists is to become knowledgeable users of Big Data and Bayesian thinkers, but the politics and social media needs also to gain a theoretical overview of their social impacts (Alvarez and Hall, 2011). In any case, even if Silver's methodology is a constancy and a pivotal point of reflection on possibility for a political and digital Sentiment Analysis; data *produces* data and not sociology discourse, etymologically, not socio-logy, *logos* on society.

References

- Alvarez, R.M. and Hall, T.E. (2011) *Electronic Elections: the Perils and Promises of Digital Democracy*. Princeton: Princeton University Press.
- Allan, J. (2002) Introduction to Topic Detection and Tracking. *The Information Retrieval Series*, 12 (1), 1-16
- Anderson, C. (2013) 'The End of Theory: The Data Deluge Makes the Scientific Method Obsolete' on Wired Magazine. *WIRED MAGAZINE*, 16.07. [Online]. Accessible from: archive.wired.com/science/discoveries/magazine/16-07/pb_theory. [Accessed: 30th December 2014].
- Maas, A.L., Daly, R.E., Pham, P.T., Huang, D., Ng, A.Y. and Potts, C. (2011) *Learning Word Vectors for Sentiment Analysis*. Paper Presented at The 49th Annual Meeting of the Association for Computational Linguistics (ACL).
- Ashton, K. (2009) That 'Internet of Things' Thing. [Online]. Accessible from: www.rfidjournal.com/articles/view?4986. [Accessed: 30th December 2014].
- Baba, Y., Hayter, A.J., Kanefuji, K. and Kuriki, S. (2012) *Recent Advances in Statistical Research and Data Analysis*. London: Springer.
- Bettors, E. (2014) Internet of Things explained: What is it, and can it really change the world? [Online]. Accessible from: <http://www.pocket->

- lint.com/news/126559-internet-of-things-explained-what-is-it-and-can-it-really-change-the-world. [Accessed: 30th December 2014].
- Bollen, J., Mao, H. and Zeng, X. (2011) Twitter mood predicts the stock market. *Journal of Computational Science*, 2 (1), 1-8.
- Boulianne, S. (2009) Does Internet use affect engagement? A meta-analysis of research. *Political Communication*, 2(2), 193–211.
- Bryman, A. (2007) *Social Research Methods*. London: SAGE Publications
- Buchanan, M. (2002) *Nexus: Small Worlds and the Groundbreaking Theory of Networks*. New York: W.W. Norton & Company.
- Butler, D. (2013) When Google got flu wrong. *Nature*, 494 (7436), 155-156.
- Cameron, A.M., Massie, A.B., Alexander, C.E., Stewart, B., Montgomery, R.A., Benavides, N.R., Fleming, G.D. and Segev, D.I. (2012) Social Media and Organ Donor Registration: The Facebook Effect. *American Journal of Transplantation*, 13 (8), 2059–2065.
- Castells, M. (1996) *The Rise of the Network Society, The Information Age: Economy, Society and Culture. Vol. I*. Oxford UK: Blackwell.
- Castellani, B. and Hafferty F.W. (2010) *Sociology and Complexity Science: A New Field of Inquiry (Understanding Complex Systems)*. Berlin: Springer.
- Ceron, A., Curini, L.M. and Iacus, M.S. (2013) *Social Media e Sentiment Analysis: L'evoluzione dei fenomeni sociali attraverso la Rete*. Milano: Springer.
- Chen, C.Q., Liu, G., Bu, B.J. (2011) Opinion Word Expansion and Target Extraction through Double Propagation. *Computational Linguistics*, 37 (1), 9-27.
- Christen, P., Georgakopoulos, D., Perera, C. and Zaslavsky, A. (2013) Context Aware Computing for The Internet of Things: A Survey. *Communications Surveys*, 16 (1), 1-44.
- Cioffi-Revilla, C., Takadama, K. and Deffuant, G. (2010) *Simulating Interacting Agents and Social Phenomena: The Second World Congress (Agent-Based Social Systems)*. Berlin: Springer-Verlang.
- Corten, R. (2014) *Computational Approaches to Studying the Co-evolution of Networks and Behavior in Social Dilemmas*. Hoboken: Wiley–Blackwell.
- Crooks, A.T., Heppenstall, A.J., Linda See, M.L. and Batty, M. (2012) *Agent-Based Models of Geographical Systems*. Berlin: Springer Verlag.
- Crutcher, M. and Zook, M. (2009) Placemarks and waterlines: Racialized cyberscapes in post-Katrina Google Earth. *Geoforum*, 40 (4), 523-534.
- Mayer-Schönberger, V. and Cukier, K. (2013) *Big Data: A Revolution That Will Transform How We Live, Work, and Think*. Boston: Houghton Mifflin.

- Davenport, T.H. and Siegel, E. (2013) *Predictive Analytics: The Power to Predict Who Will Click, Buy, Lie, or Die*. Hoboken: Wiley–Blackwell.
- Davenport T.H. and Jinho, K. (2013) *Keeping Up with the Quants: Your Guide to Understanding and Using Analytics*. Cambridge: Harvard Business Review Press.
- Davenport, T.H. (2014) *Big Data at Work: Dispelling the Myths, Uncovering the Opportunities*, Cambridge: Harvard Business Press.
- de Groot, R. (2012) *Data Mining for Tweet Sentiment Classification: Twitter Sentiment Analysis*. Saarbrücken: Lap Lambert.
- Deguchi, H. (2010) *Agent-Based Social Systems*. Tokio: Springer International
- Diaz-Aviles, E. (2013) *Living Analytics Methods for the Social Web*. Create Space Independent Publishing Platform.
- Dimmick, J. and Rothenbuhler, E. (1984) The Theory of the Niche: Quantifying Competition Among Media Industries. *Journal of Communication*, 34 (1), 103-119.
- Dimmick, W.J. (2013) *Media Competition and Coexistence: the theory of the Niche*. London: Routledge.
- Friedemann, M. and Floerkemeier, C. (2010) From the Internet of Computers to the Internet of Things. *Informatik-Spektrum* 33 (2), 107-121.
- Erwin, K. (2013) *Communicating the New: Methods to Shape and Accelerate Innovation*. Hoboken: Wiley–Blackwell.
- Feldman, R. James, S. (2007) *The Text Mining Handbook*. New York, Palo Alto CA: Cambridge University Press
- Foreman, J.W. (2013) *Data Smart: Using Data Science to Transform Information into Insight*. Hoboken: Wiley–Blackwell
- Gayo-Avello, D., Metaxas, P.T. and Mustafaraj, E. (2011) *Limits of Electoral Predictions Using Twitter*. Paper presented at the Proceedings of the Fifth International Conference on Weblogs and Social Media.
- Gasperoni, G. (2013) Review of Current Issues and Challenges in Political Opinion Polling. *Rivista Italiana di Scienza Politica*, XLIII (2),277-292.
- Gearhart, S. and Zhang, W. (2013) Gay Bullying and Online Opinion Expression: Testing Spiral of Silence in the Social Media Environment. *Social Science Computer Review*, 32 (1), 18-36.
- Gerner, D.J., Schrod, P.A., Ronald, A.F. and Weddle, J. (1994) Machine Coding of Event Data Using Regional and International Sources. *International Studies Quarterly*, 38 (1), 91–119.
- Gilbert, N. (2007) *Agent-Based Models (Quantitative Applications in the Social Sciences)*. London: Sage.

- Goidel, K. (2011) *Public Opinion Polling in a Digital Age: Meaning and Meseasurement*. In Godiel, K. (eds.), *Political Polling in Digital Age: The Challenge of Measuring and Understanding Public Opinion*. Baton Rouge: Louisiana State University.
- Grimmer, J. and King, G. (2011) General purpose computer-assisted clustering and conceptualization. *Proceedings of the National Academy of Sciences*, 108 (7), 2643-2650.
- Grimmer, J. and Stewart, B.M. (2013) Text as Data: The Promise and Pitfalls of Automatic Content Analysis Methods for Political Texts. *Political Analysis*, 21 (3), 267-297.
- Gwet, K. (2008) Computing inter-rater reliability and its variance in the presence of high agreement. *British Journal of Mathematical and Statistical Psychology* 61 (1), 29-48
- Gulli, A. and Signorini, A. (2005) *The indexable web is more than 11.5 billion pages*. Paper presented at the Special interest tracks and posters of the 14th international conference on World Wide Web, ACM Press.
- Kagan, V., Rossini, E. and Sapounas, D. (2013) *Sentiment Analysis for PTSD Signals*. Berlin: Springer.
- Kahneman, D. (2013) *Thinking, Fast and Slow*. New York: Farrar, Straus and Giroux.
- Kantardzic, M. (2011) *Data Mining: Concepts, Models, Methods, and Algorithms*. Hoboken: Wiley-Blackwell.
- Khurshid, A. (2013) *Affective Computing and Sentiment Analysis: Emotion, Metaphor and Terminology*. Berlin: Springer-Verlag.
- King, G. and Hopkins, D. (2010) A Method of Automated Nonparametric Content Analysis for Social Science. *American Journal of Political Science*, 54 (1), 229-247.
- Kotler, P. (1986) Prosumers: A New Type of Customer. *Futurist*, 20 (5), 24-28.
- Kotler, P. (1986) The Prosumer Movement. A New Challenge for Marketers. *Advances in Consumer Research*, 13, 510-513.
- Krippendorff, D.K. (2004) *Content Analysis: An Introduction to Its Methodology*. London: Sage.
- Han, J., Kamber, M. and Pei, J. (2011) *Data Mining: Concepts and Techniques*. Massachusetts: Morgan Kaufmann Publishers.
- Hilbert, M. and López, P. (2011) The World's Technological Capacity to Store, Communicate, and Compute Information. *Science*, 332 (6025), 60-65.
- Infante, M. (2010) The 'systemic communication' between Social and Media Systems. *Nuova Atlantide*, 25 (3), 95-117.

- Infante, M. (2012a) *Teoria sistemica dei media. Vol. II. La mosca e la ragnatela: la soggettività nel sistema della rete*. Roma: Aracne.
- Infante, M. (2012b) *The Web as an adaptive complex system. A systemic approach to the Net*. In D'Alessandro S., Marini G. and Affuso S. (eds.), *The next global scenario. The systemic approach and the 21st Century Challenges*. Roma: Aracne.
- Infante, M. (2013) Media Construction of Fair and Social Risk in the Late-2000s Financial Crisis. *New Atlantis*, 28 (1), 59-78.
- Leetaru, K. (2011) *Data Mining Methods for the Content Analyst: An Introduction to the Computational Analysis of Content*. London: Routledge.
- Liu, B. (2010) Sentiment Analysis: A Multifaceted Problem. *IEEE Intelligent Systems*, 25 (3), 76-80.
- Luhmann, N. (1995) *Was ist Kommunikation?*. In Luhmann, N. (eds.), *Soziologische Aufklärung 6 Auflage. Die Soziologie und der Mensch*, Westdeutscher Verlag. Köln und Opladen.
- Luhmann, N. (1998) *Die Gesellschaft der Gesellschaft*. Frankfurt am Main: Suhrkamp Verlag.
- Luhmann, N. (2012a) *Theory of Society. Vol. I*. Palo Alto: Stanford University Press.
- Luhmann, N., (2012b) *Theory of Society. Vol. II*. Palo Alto: Stanford University Press.
- Miller, H.J. and Han, J. (2009) *Geographic Data Mining and Knowledge Discovery*. London: Chapman & Hall CRC.
- Miner, G., Delen, D., Elder, J., Fast, A. and Hill, T. (2012) *Practical Text Mining and Statistical Analysis for Non-structured Text Data Applications*. Oxford: Academic Press.
- Naldi, G., Pareschi, L. and Toscani, G. (2010) *Mathematical Modeling of Collective Behavior in Socio-Economic and Life Sciences (Modeling and Simulation in Science)*. Basel: Birkhäuser Verlag.
- Nathan, M. and Warren, J. (2014) *Big Data: Principles and best practices of scalable realtime data systems*. Greenwich: Manning Publications.
- Neuendorf, K.A. (2002) *The Content Analysis Guidebook*. London: Sage.
- North, M.A. (2012) *Data Mining for the Masses*. Global Text Project.
- Pang, B. and Lillian, L. (2008) *Opinion Mining and Sentiment Analysis*, Delft: Now Publishers.
- Parmelee, Z. (2002) The virtual sphere: the Internet as public sphere. *New Media & Society*, 4 (1), 9-27.

- Parmelee, J.H. (2013) The agenda-building function of political tweets. *New Media Society*, 16 (3), 434-450.
- Parmelee, J.H. and Bichard, S.L. (2011) *Politics and the Twitter Revolution: How Tweets Influence the Relationship between Political Leaders and the Public*. Lanham: Lexington Books.
- Russell, M.A. (2011) *Mining the Social Web: Analyzing Data from Facebook, Twitter, LinkedIn, and Other Social Media Sites*. Sebastopol: O'Reilly & Associates.
- Ramezani, M. (2013) *Using Data Mining for Facilitating User Contributions in the Social Semantic Web*. Munich: GRIN Verlag.
- Sang, E.K. and Bos, J. (2012) *Predicting the 2011 dutch senate election results with twitter*. Paper Presented at the Proceedings of the 13th Conference of the European Chapter of the Association for Computational Linguistics.
- Sathi, A. (2013) *Big Data Analytics: Disruptive Technologies for Changing the Game*. London: Mc Press.
- Scharkow, M. and Vogelgesang, J. (2011) Measuring the Public Agenda using Search Engine Queries. *International Journal of Public Opinion Research*, 23 (1), 104-111.
- Sakaki, T., Okazaki, M. and Matsuo, Y. (2013) Earthquake Shakes Twitter Users: Real-time Event Detection by Social Sensors. *Knowledge and Data Engineering, IEEE Transactions*, 25 (4), 919-931.
- Shah, S., Horne, A. and Capellá, J. (2012) Good data won't guarantee good decisions. *Harvard Business Review*, 90 (4), 23-25.
- Silver, N. (2012) *The Signal and the Noise*. New York: Penguin
- Squazzoni, F. (2012) *Agent-Based Computational Sociology*. Hoboken: Wiley-Blackwell.
- Swigger, N. (2012) The Online Citizen: Is Social Media Changing Citizens Beliefs about Democratic Values?. *Political Behavior*, 35 (3), 589-603.
- Scott, J. (2000) *Social Network Analysis: A Handbook. 2nd Ed*. London: Sage.
- Taleb, N. (2007) *The Black Swan*. New York: Random House.
- Terano, T., Kita, H., Deguchi, H. and Kijima, K. (2005) *Agent-Based Approaches in Economic and Social Complex Systems IV*. London: Springer.
- von Foerster, H. (1962) *Technology of Self-Organizing Systems*. London: Pergamon Press.
- von Foerster, H., Mead, M. and Teuber, H.L. (eds.) (1951) *Cybernetics: Circular causal and feedback mechanisms in biological and social systems. Transactions of the seventh conference*. New York: Josiah Macy Foundation.

MICHELE INFANTE

Wiener, N., Siegel, A., Rankin, B. and Martin, W.T. (1966) *Differential space, Quantum systems and prediction*. Cambridge: MIT Press.

Wiener, N. (1988) *The Human Use of Human Beings, Cybernetics And Society*. Cambridge: Da Capo Paperback.

Williams, M. and Vogt, W.P. (2011) *The SAGE Handbook of Innovation in Social Research Methods*. London: Sage.

Witten, I., Frank, E. and Hall, M.A. (2011) *Data Mining: Practical Machine Learning Tools and Techniques*. Burlington: Morgan Kaufmann.

Towards a typology of materiality/corporeality of music in the digital multimedia regime

Stefano LOMBARDI VALLAURI*

Libera Università di Lingue e Comunicazione, IULM

The first part of the article examines the contemporary trend of the dematerialization of music in the multimedia spectacle, and in particular, thanks to the technological instruments, how this leads to conjunction with digital, and especially abstract, video. Various types of multimedia musical work are classified, in decreasing order of materiality/corporeality: from the traditional opera, regularly provided with all its normal material components, as well as the new dematerialized component, to new kinds of audiovisual works which instead are totally dematerialized. The second part of the article examines the countertrend of rematerialization and recorporealization of the musical multimedia spectacle. Other types of work are classified in which matter and the body, directly or indirectly and sometimes even metaphorically, regain centrality, despite the digital management and elaboration of the musical and video material.

Keywords: *Transcoding; fraying of the boundaries; composition; abstract video; post-digital; gesture*

Introduction

The present article considers music as an art, but also, more generally, as a system of experience. Both from the philosophical aesthetic point of view and from a multidisciplinary one which calls upon media studies, anthropology, and psychology, it is useful to examine the manner in which scientific and technological knowledge and practice contribute to determining the definition of music, the forms that very concretely it takes. Music is one among the many ways in which man designs matter and, through the latter, experience. The present-day means for designing the

* Corresponding author: **Stefano Lombardi Vallauri** | e-mail: stefano.vallauri@iulm.it

shape of sounds – previously electronic, then computational, now also prosthetic, hybrid man/machine means – are capable of inducing specific experiences, relationships of man with himself and with reality that had never existed before. We shall see that in a first, more obvious way, these means are the cause of a dematerialization (and, more specifically, decorporealization) of music, along the whole process of its creation, production, and reproduction; but that in a different, precisely contrasting way, they also lead to a rematerialization (and recorporealization) of the musical fact. The latter should be understood in the broadest sense, also including the contribution of other concurrent and kindred arts and systems of experience: language, dance, painting, video (and video, just as essentially based on post-mechanical technologies, supersedes language in the position of brother-german of music today, thus giving birth to multimedia). The following analysis is conducted in a comparative manner on a large sample of contemporary musical and mixed works, seeking to combine the philosophical aesthetic approach with the technological point of view, also constantly in the historical consideration of the models of musical spectacle of tradition.

1. Dematerialization, decorporealization

1.1 Dematerialization

1.1.1 Statement

According to standard critical reception, nowadays the predominant trend in the various genres of musical multimedia is towards the dematerialization of music, and thus to its combination, at the deepest level, with other equally dematerialized media techniques and forms. Technological means, previously electronic and now computer-based, favour the creation of music which is:

- independent of the traditional acoustic instruments;
- based on procedures, and producing results, akin to those of electronic creativity in other artistic fields, and particularly in digital video.

In fact it is increasingly common to find composers who, thanks to their proficiency in computer assisted creation in general, take on the role of video makers. Thanks to "numeric transcoding" (Manovich, 2001, pp. 63-65), the process of the erosion of boundaries between the different arts ('fraying') envisaged by Theodor W. Adorno (1997) becomes a reality at the technical level.

1.1.2 Glosses

The field of artistic creativity studied here is not pure music, nor indeed music in its exclusively acoustic conformation ('acousmatic'), devoid not only of a literary text or a poetic programme (according to the Romantic definition of 'Absolute Musik') but also of the possibly constituent visual aspect (which pertains to pure music when it is produced in the normal situation of a live concert). Rather, it is medially impure music, associated with other arts in global forms of spectacle and performance, founded in particular on post-mechanical technologies (Rogers, 2011).

If it is what we can call the 'electronic turn' which has caused music to move in the acousmatic direction, because for the first time in history sound production stripped of any corresponding visual aspect has become a possibility, the opposite is also true, i.e. that precisely this electronic turn makes new media conjunctions and combinations possible in music.

The principal field to open up in this direction is video (in the broadest sense, including cinema, videoart, computer graphics, videogame etc.), basically because it shares with music the temporal unfolding of form. And in particular abstract video (i.e. non-narrative and non-representative), because the semiotic regime of music is also essentially abstract. A total numeric transcoding between music and video can occur only at the shared level of abstractness. There can also be intermediate cases, in which music is associated with non- or non-totally abstract video.

The fraying to which Adorno makes reference mainly concerns the relationships of music with painting, above all abstract and informal art, but precisely the temporal unfolding of video adds an element that Adorno does not consider, although it fits into his theoretical model and indeed completes it.

From the outset, all the principal experiences tending towards a union between music and abstract video are made on the part of the latter as a conscious emulation of the peculiar abstract nature of music. Just as Kandinsky based his new conception of painting on the natural status of music (Kandinsky, 1994, pp. 153-155), so all the early and most important essays in abstract cinema (starting with the works by the Corradini brothers, Léopold Survage, Hans Richter, Viking Eggeling etc.; cf. Provenzano, 1992) take music as their paradigm, looking for a correspondence, a transcoding, albeit one which is not yet digital.

1.2 Decorporealization

1.2.1 Statement

The dematerialization of music also involves, in particular, a subtraction of corporeality: at the stages of both creation and, especially, of actual production, the medium of sound generation is no longer the body, but the machine. In the results the convergence of music with (abstract) video and the trend of both towards dematerialization takes the form, in order of decreasing materiality/corporeality, of:

- 1) operas which sum video to the traditional *mise en scène* with the singers;
- 2) operas which substitute video for one essential component or other of the bodily musical spectacle (e.g. *L'Angelo e il Golem* by La Licata/Lupo, 2000; *Machinations* by Aperghis/Regnault/Levy, 2000);
- 3) musical multimedia spectacles which completely substitute video for the bodily action (e.g. *An Index of Metals* by Romitelli/Lèkovich/Pachini, 2003; *utp_* by Noto/Sakamoto, 2007);
- 4) purely audiovisual genres, up to what can be called abstract 'musical videoart', where the material part is reduced almost to zero, even on the representative level (e.g. *cyclo.id* by Ikeda/Nicolai, 2011).

1.2.2 Glosses

Man has always naturally maintained his relationships with matter through the body. In fact the body itself is a material instrument which man uses to play the musical instruments; or, as for the voice, it is itself a musical instrument. 'Technical reproducibility' already made it possible to skip the bodily mediation in the moment of the music's reproduction, but dematerialization makes it possible to skip the bodily mediation also in real-time production of sound, devolving it to the machine, as well as in the moment of its composition, unless of course the composer works with the aid of traditional acoustic instruments.

This development actually reconnects the present with a past stage of music making. European composers have always been able to compose music without involving the body playing instruments: at the desk, directly onto the sheet of paper. This shows that even then a non-material existence was possible for music: as information, not of course digital, but as information rather than as matter.

1.2.3 Explication

Here we are examining general trends in contemporary music composition, which in fact are transversal with respect to genres. Thus examples are drawn above all from the European contemporary classical (academic) genre, but not only: also from post-minimalism and from popular electronics. Furthermore, the present typology makes no claim to historiographical sorting. The examples are chosen without seeking to indicate temporal priorities in the history of music, but only as clear samples of the main trends (concerning the prehistory and 'proto-history' of the musical multimedia spectacle in the academic context, cf. Gennaro and Borio, 2007; Borio, 2011).

1) In such cases every part of the traditional music spectacle remains intact, and it is not subject to dematerialization. Rather a portion of dematerialized art is added to all the standard material and corporeal ones. Indeed, this type is also represented by pre-contemporary music spectacles, traditional in everything but the addition of the video (viz. the production by La Fura dels Baus of Wagner's Ring cycle, in Valencia and Florence, 2007 - 2009).

2) In *L'Angelo e il Golem* by Francesco La Licata (music and dramaturgy) by Fabrizio Lupo (*libretto*, staging, video) (created in Palermo, November 2000) the *libretto* alone is quite inadequate to account for the dramaturgy: the contents of the various excerpts that make it up (according to the model of *Literaturoper*), and similarly the links that connect them, are of a philosophical, psychoanthropological kind rather than relating to the action or narrative; the facts and events are communicated by all the other integrated media, in particular cinema. The latter functions as the main information channel and is the place of representation and the means of transmission of the narrative contents, through the projection – on two semitransparent screens located at the side of the stage before two rows of spectators facing each other – of eight filmic fragments interspersed with seven musical *tableaux* (in fact the alternation between film pieces and theatrical-musical moments restores the traditional alternation between *recitativo* and *aria*, between phases of action and phases of introspection and psychological expression). In a case like this, the material and corporeal attributes music is supposed to "lose" do not actually pertain to it from the outset, because strictly speaking they belong to the art of acting. The instrumental performance remains; what is lost is only the bodily action of the singers in the narrative phases (not in the introspective-expressive ones).

In *Machinations* by Georges Aperghis (music, staging, *libretto*), François Regnault (*libretto*) and Daniel Levy (video) (Witten, April 2000) the part of corporeality that is typically proper to the traditional spectacle and that is lost is again the one related to the acting, but not, as in *L'Angelo e il Golem*, in its unfolding in time, rather in space. During the whole performance four women stay behind four tables, letting us see only their faces and hands. Behind each of them, on four screens, the images of the video are seen. It is the latter, then, that once again here replaces the corporeality of the music spectacle.

3) In the 'video-opera' or 'light show' *An Index of Metals* by Fausto Romitelli (music), Kenka Lèkovich (*libretto*) and Paolo Pachini (video, in collaboration with Leonardo Romoli) (Cergy-Pontoise, October 2003) the representation and the stage narration vanish completely, while the projection of a video component is prescribed on three screens. Hence the bodily action is altogether lost, except for the visible aspect of the performance of the instrumentalists, which however takes place in the dark. The video images renounce narration and representation, which instead are typical and necessary in traditional cinema. The formal aspect of the video, in fact, although stemming from concrete original shots, proves to be abstract: so essentially material-based, and subject to such a range of computer elaborations (exactly like an acoustic sound treated electronically), that it proves to be practically indecipherable in figurative terms. The work realises, according to Romitelli, «le projet tout à fait original de penser conjointement le son et la lumière, la musique et la vidéo, d'utiliser timbres et images comme éléments d'un même continuum soumis aux mêmes transformations informatiques» (Romitelli, 2003).

A similar model is also realised in *utp_* by Carsten Nicolai (*alias* Alva Noto) and Ryuichi Sakamoto (both music, with the Ensemble Modern; Nicolai video, in collaboration with Simon Mayer) (Mannheim, November 2007): musicians in near darkness; the visible part of the spectacle entirely transferred to the video, on a large screen; abstractness of the form of the moving images, in close relationship with the form of the music.

4) In the 'studies' (in the sense of the artistic genre) of musical videoart collected in *cyclo.id* by Ryoji Ikeda and Carsten Nicolai (both music and video) (book and CD-ROM, Raster-Noton, r-n 127-3, 2011) the coincidence between music and video is total, as both derive from the same forms (which, moreover, are geometric-mathematical forms), and according to analogous generative processes. At this level the dematerialization and decorporealization is complete: we no longer find the action proper to a

musical-theatrical spectacle, nor even that proper to the musicians in pure music; and the video itself, in which the whole of the visible aspect converges (precisely because the visible aspect of the musical performance is lost), in turn represents nothing material, concrete, but is purely synthetic. Everything is pure digital form: music, at every stage of its creative-(re)productive process; and video, equally at every stage of its creative-(re)productive process, as well as in its semiotic-semantic level, since it gives up representation in favour of abstractness.

2. Rematerialization, recorporealization

2.1 Statement

However, equal and contrary to the described trend, and always in the field of the digital multimedia, there is a countertrend towards the rematerialization of music, and in particular to its recorporealization. The latter occurs:

1) directly, when a material *datum* is transformed into sound (in real time) by means of computer tools; for example:

1.1) a human gesture:

1.1.1) musical instrumental (e.g. *Capt-Actions* by I. Fedele, 2005);

1.1.2) non-musical: choreographic (e.g. *Silence/Text* by Aralla/Veggetti, 2005); graphic-pictorial (e.g. *Ciò che cresce sopra* by Aralla/Veggetti/Yoshida, 2013);

1.2) a non-human, mechanical movement (e.g. *Regnum Animale* by Lanza/Valle, 2013).

2) indirectly, when, beyond the reintroduction of the body in the works in a direct way, there is a re-evaluation of *the corporeality of sound as such*:

2.1) by accentuation of the intelligibility of the instrumental gesture (on the basis of motor empathy, or of its motor traits known culturally);

2.2) by accentuation of the more material aspects, in the sense of *concrete* (less pure, ethereal, clean), of sound:

2.2.1) through spatialization;

2.2.2) through the elaboration of the intensity of sound, understood as a pre-musical physical category;

2.2.3) through the elaboration of timbre, understood – with respect to pitch and duration – as a more concrete dimension of sound, less reducible to hierarchical and rationalizable relationships.

2.2 Glosses

The rematerialization of the music spectacle is equal and contrary to the dematerialization because it happens also precisely as a reaction and in contrast to it. If technology tends towards dematerialization, the artists – in whose consciousness tradition and innovation continue to be in productively dialectical relationship – balance this trend by also emphasizing the rematerialization (this, as well, not only in traditional ways but also in innovative ways).

The trend towards rematerialization also converges with the trend towards that condition which is called ‘post-digital’ and ‘post-media’ (Cascone, 2000; Apprich et al., 2013), namely a regime in which the digital is so pervasive and obvious as no longer to be exceptional, and thus not needing to be concealed or highlighted; in which, in short, the digital and the material-corporeal coexist on the same plane and intertwine in the most free and varied ways.

However, the question is more profound, and probably relates to some ineliminable characteristics of human cognitive faculties. Man tends to perceive every phenomenon *sub specie humanitatis*, as a human manifestation. Even what does not have any human trait, because it is completely devoid of materiality and corporeality, is still understood – through a metaphorical projection, anthropomorphising – as human.

2.3 Explication

1) In live electronics, technological means interact with the acoustic ones, dematerializing the sound they produce. But today, besides sound, the process may also include other material and corporeal elements involved in the production of the sound itself or in any action.

1.1.1) In *Capt-Actions* (for string quartet, accordion and live electronics) by Ivan Fedele (Metz, April 2005) the electronic device, a special *capteur* developed by Thierry Coduys, enables the real-time transformation of the form of the physical movements of the musicians into the form of sound.

1.1.2) In *Silence/Text* (choreographic-musical action for five dancers and live electronics) by Paolo Aralla (music) and Luca Veggetti (choreography) (New York, 2005) dancers interact with microphones and produce sounds that are electronically elaborated in real time; in *Ciò che cresce sopra* (choreographic-musical action for painter and live electronics) by Paolo Aralla (music), Luca Veggetti (choreography) and Moe Yoshida (painting) (Bologna, 2013) it is the artist who, painting on a wall which has microphones applied to it, performs physical movements that produce

sounds (naturally inaudible for the ear) that are in turn electronically elaborated.

1.2) In *Regnum Animale* (for amplified string trio and electromechanical devices) by Mauro Lanza and Andrea Valle (Milano, November 2013) a sound director uses a computer to control a number of mechanical objects of daily use, thus, in a broad sense, endowed with an anthropic materiality, which move visibly on the stage producing sounds.

2) Beyond the materiality or corporeality of the objects and processes that precede sound, it is necessary to consider the materiality and corporeality intrinsic to the sound itself. First of all, materiality belongs inevitably to sound as a physical reality. But there is also a human materiality and corporeality of sound that lies beyond the physical *datum*, in a complex stratification of sense and significance that needs to be clarified in perceptual-cognitive, semiotic, psychospiritual and anthropological terms.

2.1) At least since the 60s, and transversally with respect to the various music genres (jazz and rock of course, but also in particular the contemporary classical), a constructive principle operates that makes the determination of the form of sound dependent on the form of the bodily gesture that produces that sound. Thus, in the reception, the spectator is required to pay equal attention to both sound and gesture. If the gesture is visible, he reacts to it both on a cognitive level and, probably, at the level of direct motor empathy, due to the activation of the mirror neuron system (Lombardi Vallauri, 2012). But even when the gesture is not visible, as in the case of recorded music, the user is often still able, through an inverse passage, to find in the sound the form of the gesture, as he has a previous knowledge (albeit mostly unconscious) about which are the bodily gestures associated with the various configurations of the sound.

2.2) Contemporary composition, free with respect to every historical system (modal, tonal, serial, or whatever), willingly expands its experiences not only *beyond* the existing systems but also towards the level *on this side* of the systems, of any system: sound itself, pure and simple.

2.2.1) There are four commonly recognised elementary dimensions of sound: pitch, duration, intensity, and timbre. But there is also a fifth dimension, space, because a sound cannot exist without a spatial determination, concerning the origin and propagation of vibrations in the ambient medium. The formal management of the facts pertaining to the spatial dimension of sound, in music and even more so in the musical multimedia spectacle, involves the valorisation of something that is material by definition, since space is an essential dimension of every physical body.

2.2.2) Intensity, too, despite being a dimension that fully belongs to all articulated music systems, is nonetheless also an elementary dimension of sound, whose elaboration particularly highlights the material-concrete aspect of music.

2.2.3) In recent decades the primacy of timbre for composers is normally attributed, among other causes, to the advent of the instruments of electronics and computing, i.e to instruments of dematerialization. But it probably also depends on the equally strong, irreducible, material and corporeal quality of timbre itself: in the metaphorical perception, that is constitutive of man's experience of the world (Lakoff and Johnson, 1980) and is especially vivid in the experience of music, timbre is *the body of sound*. Indeed, timbre is *metaphorically* endowed, as physical bodies *really* are, with qualities for which it is perceived by man as thick or evanescent, smooth or rough, sharp or frayed, bright or dark, warm or cold, big or small, stiff or fluid, hard or soft, strong or fragile, etc.

Conclusion

After this survey in which we have tried, adopting an analytical approach, to account for the diverging trends of dematerialization-decorporealization and rematerialization-recorporealization of music and of the musical multimedia spectacle, we can affirm, in a synthetic manner, that in fact the two trends also converge, often coexist in the same circumstances, and give together the idea not of contradiction, but of complexity. Digital technology does not make music and the whole system of the arts and of experiences explode in incoherent parts, rather it makes their spectrum more wide-ranging and articulate. They can still be observed as a unity, a complex unity. Matter is not only matter, body is not only body, music is not only music, in isolation. What is more, everything – that in itself is already something other than itself – in the digital regime is also transcoded into information, dematerialized; however, paradoxically, dematerialization and decorporealization imply and favour material and corporeal experiences, such as every human experience inevitably is. This awareness entails a major consequence, on the methodological plane, that is the necessary integration of the musicological approach into a wholly systemic, together humanistic and scientific, perspective.

References

- Adorno, T.W. (1997) *Die Kunst und die Künste*. In Adorno, T.W., *Gesammelte Schriften*. 10/1. *Kulturkritik und Gesellschaft: Prismen. Ohne Leitbild*. Frankfurt: Suhrkamp.
- Apprich, C., Slater, B.J., Iles, A. and Schultz, O.L. (2013) *Provocative Alloys: A Post-Media Anthology*. Lüneburg & London: Post-Media Lab & Mute Books.
- Borio, G. (2011) *Franco Evangelisti's 'Die Schachtel' and its filmic transposition by Gregory Markopoulos*. Paper presented at the proceedings of the study group Worlds of AudioVision. Available from: http://www-5.unipv.it/wav/pdf/WAV_Borio_2011_eng.pdf. [Accessed: 10th May 2014].
- Cascone, K. (2000) The Aesthetic of Failure: 'Post-Digital' Tendencies in Contemporary Computer Music. *Computer Music Journal*, 24 (4), 12-18.
- Gennaro, S. and Borio, G. (2007) *Multimedialità e metamorfosi del concetto di opera*. In Borio, G. and Gentili, C. (eds.), *Storia dei concetti musicali. II. Espressione, forma, opera*. Roma: Carocci.
- Kandinsky, W. (1994) *Complete Writings on Art*. New York: Da Capo Press.
- Lakoff, G. and Johnson, M. (1980) *Metaphors We Live By*. Chicago: The University of Chicago Press.
- Lombardi Vallauri, S. (2012) *Azione fisica ed empatia nell'opera musicale-performativa di Dario Buccino*. In Falletti, C. and Sofia, G. (eds.), *Prospettive su teatro e neuroscienze: Dialoghi e sperimentazioni*. Roma: Bulzoni.
- Manovich, L. (2001) *The Language of New Media*. Cambridge: MIT Press.
- Provenzano, R.C. (eds.) (1992) *Dal ritmo colorato alla musica visuale: Continuità ed evoluzione linguistica nell'audiovisivo astratto*. Milano: Ergonarte.
- Rogers, H. (2011) The Unification of the Senses: Intermediality in Video Art-Music. *Journal of the Royal Musical Association*, 136 (2), 399-428.
- Romitelli, F. (2005) *'An Index of Metals': Note d'intention*. In Arbo, A. (eds.), *Le corps électrique: Voyage dans le son de Fausto Romitelli*. Paris: L'Harmattan.
- Zbikowski, L.M. (2008) *Metaphor and Music*. In Gibbs, R.W. (eds.), *The Cambridge Handbook of Metaphor and Thought*. Cambridge: Cambridge University Press.



BORDERS. Visual analysis of Cinema's inner dynamics and evolutions. A case study based on the Internet Movie Database

Giovanni MAGNI^{*a}, Paolo CIUCCARELLI^a, Giorgio UBOLDI^a and Giorgio CAVIGLIA^b

^a Politecnico di Milano; ^b Stanford University

Since the launch of the Internet Movie Database (abbreviated IMDb), in 1990, a large amount of data about movies has been collected online, giving us the possibility to analyse the film industry on a large scale. This paper describes the design and some results of 'Borders. A geo-political atlas of film's production', a project that aims at visually represent and exploring the multi-dimensional and heterogeneous data coming from this online archive. The main goal is to visually analyse the relationships between geo-political regions and countries, using the data related to the film industry as a privileged point of view.

Keywords: Cinema; data visualization; online archives; networks; internet movie database

Introduction

The opening of enormous online databases and the increasing availability of tools to extract and analyse huge amount of data are providing a unique opportunity for researchers and scholars to represent and study social and cultural complex systems.

The work presented here aims at making a step in the direction of deepening the possibilities offered by the abundance of online data to define new modes of observation, exploration, and interpretation to analyse the evolution of a large scale social and cultural phenomenon such as the film industry.

The film industry is a cultural and economical system that has grown enough to develop proper dynamics thanks to phenomena such as co-

* Corresponding author: Giovanni Magni | e-mail: giovanni1.magni@mail.polimi.it

production and tax-incentives (Morawetz and Norbert, 2007), therefore it appears as a world extremely connected to reality and history but with its own inner geographies, built and shaped during time, film by film.

The birth of digital archives and online platforms to collect, store and share information about the world of cinema (e.g.:IMDb, Rotten Tomatoes, Wikipedia) opened new possibilities to study and analyse the film production as a collective system rather than a sum of individual cases.

In our work we focused on the quantitative and visual analysis of this data as a key to understand the evolution of large scale phenomena such as the relationship between countries and different geo-political and cultural areas within the global film production.

The goal is to offer a macroscopic perspective both on the studied subject (whole national identities rather than small social groups) and for what concern typology of used data (analyzing the whole dataset available rather than rely on small subsets).

In this perspective, information and data visualizations have increasingly emerged as essential tools to explore and make sense out of the growing quantity and variety of available data, playing a key role in research activity and not just the final output (Jessop, 2008).

The paper collects and discusses the whole process that has lead to the definition and the development of a thematic atlas, namely 'Borders. A geo-political atlas of film production', starting from the theoretical and the methodological assumptions behind the collection and transformation of the data to the use of network visualizations to produce an image of the phenomenon.

The project is part of a Master of Science thesis in Communication Design and it has been developed in collaboration with the DensityDesign Research Lab. (densitydesign.org) at Politecnico di Milano.

As done in thematic atlases (e.g. Historical) where the world's geography is modified in order to depict the evolving political landscape or a specific phenomenon, 'Borders' aims to analyse quantitatively the evolution of global film production during time showing how data collected online could be an interesting point of view on more complex phenomena. The final output of the thesis is a visual artefact in which we represent connections between countries and cultures involved in the production of movies, using metadata coming from online database, in particular IMDb and Wikipedia.

Background

A preliminary research showed us how even if there are many projects on this theme (especially outside academic environment) there was a lack of projects and analysis of cinema able to consider large amount of data.

Except for some interesting projects made on similar datasets (Herr et al., 2007; Ahmed et al., 2007) usually this kind of works focuses on sample surveys, on the production of a single director or on an artistic movement.

At the same time most of the analysis considered are related to technical features of films, many projects try to see movies from a different point of view. They focus on various aspects of the productions trying to generate for example chromatic overviews ('CinemaRedux', Dawes, 2004), to understand features of editing ('Visualizing Vertov', Manovich, 2013), network of characters ('Lostalgitic', Ortiz) or trying to correlate different movies to each other using properties such as genre, director or actors involved, rarely considering the organization's system that exists behind every single production.

Therefore, the aim is not to study cinema from a 'technical' point of view but rather to give it a social role, to use it as a reading key to study and highlight historical and social dynamics developed during time, in this paper we would like to show potentialities of this project showing results coming directly from the Master of Science thesis 'Borders'.

Methodology

The starting point of our analysis is the single production, whether it is a movie, a short movie, a TV series or an episode.

We can retrieve a large amount of information about various aspects for each production, for example we can easily know the people who worked in or which companies have been involved. Most of these data can be related to a geographic position, a spatiality or a national belonging and this, from our point of view, creates connections between the nationality of the production itself and the countries that appear in the data.

The idea was to analyse these connections counting how many times they occurred during years, giving them a proper dimension and using them to graphically represent a social and economic evolution of collaborations during time.

The process we put in place is basically simple, we went through the archives we had and movie by movie we kept trace of every link between

the nationality of the production and any other country that, for various reasons, is related to the production and consequently appears in the data.

This way we have been able to give to these connections a size, a dimension, which has been used lately to create visual representations of the various phenomena treated, we were not interested in why these correlations happen, we wanted to know how many times they happen.

Data Collection and Process

Since the target of the project was to create a quantitatively significant analysis, we could not base the whole project on a small amount of data, so we would have to rely on the biggest archives available online.

The data for this project comes mainly from two sources, the Internet Movie Database (imdb.com) and Wikipedia (wikipedia.org).

IMDb is a free online database of information related to movies, TV series, TV programs and video games that takes in account many metadata related to the productions and the contents.

Since we wanted to analyse the geo-political and cultural dimension of the system, the first step to obtain a consistent database to work on, was to extract all the movies' features that, as we said before, can give us connections between countries.

For what concern IMDb, we started from a subset of the whole archive (imdb.com/interfaces) focusing on the most complete and well recorded metadata, specifically:

- Locations of shooting (774.687 locations known)
- Companies involved into production (1.632.046 collaborations known)
- Languages spoken inside of movies (932.943 language appearances known)
- Release dates (1.008.384 dates known)

To have a more complete database to work on we also decided to integrate the information coming from IMDb with other data taken from different linguistic versions of Wikipedia (wikipedia.org), the most famous and collaboratively edited, multilingual, free Internet encyclopedia.

Regarding these data, we have analysed 160.031 different pages related to films on the various language versions of the website (285 at the last official update) and their own detail level (page weight).

For all the data cleaning and manipulating we personally created scripts in the Python programming language which revealed itself as very powerful handling huge text files.

The datasets we obtained from the websites were very raw, therefore the first important step has been a concrete cleaning to remove all the useless information that were incomplete, inconsistent or secondary.

After that we proceeded to count, as we said previously, the amount of connections inside of the archives obtaining a list for each aspect considered, structured as the following extract:

Table 1 Example of list of connections between countries.

Country of production	Country involved	Amount of occurrences
...
USA	Spain	1222
USA	State of Palestine	8
USA	Sri Lanka	21
...

These values have been lately used to quantify the 'attraction' between different countries and to develop visual representations of the subject.

Many times happened that a single movie has two or more nationalities since the production companies could come from different nations, in these cases we considered all of them and we repeated the process for each nationality.

Visualizations

Generally, one of the best ways to represent large scale social dynamics and relationships is the network visualization. Networks allow us to shape and to explore a phenomenon, to focus on clusters and, using quantitative methods for measuring social relationships (e.g. degree distribution, clustering, closeness, centrality, distance), to understand how they interact with each other inside of the graph.

Networks are, such as Information Visualization in general, rather than the last step of a process of visual representation, a tool used to understand and to explore a subject and to see the structure of a large archive (Van Ham et al., 2009).

Using a software package such as Gephi (gephi.org), an open source network analysis application which allows us to visualize and to explore large graphs coming from complex datasets (Bastian et al., 2009), the values

obtained from metadata of individual films (the list we saw before) have been used as a base on which build networks of countries considering them as forces of attraction between nodes of the networks.

Using different positioning layouts such as the force directed Force Atlas 2 (Bastian et al., 2011) we were able to produce different kind of visualizations. The main idea was to explore the potentiality of the network visualization in order to analyse the relationships between countries based on the data coming from our dataset, ignoring their actual geographical position.

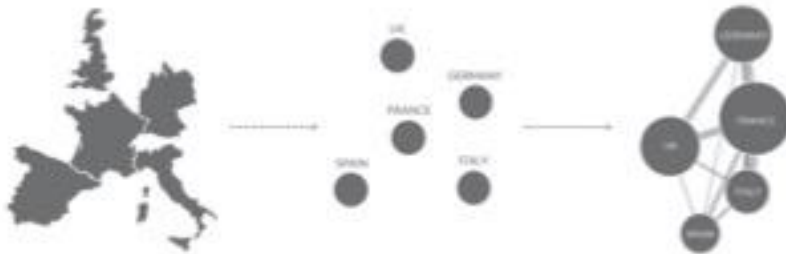


Figure 1 How it works; comparison between real geography and positioning of same countries in a world created by film productions.

Results

'Borders' is the result of a process of harvesting, analysis and visual processing of data, it consists of five chapters, each one of them refers to a different dimension of the information we analysed.

Explaining every single visualization obtained would take too long, therefore we are showing just some of the most interesting examples of the results.

1. Location's Analysis

'Where' a shot is taken is a choice that depends on various causes, two of them are costs of production and the requirement to move to a specific place according to the film's plot. An entire cast moves to a different location to follow the film's theme which can require specific place and sets or to save on production's costs moving to places where, for multiple reasons, it results cheaper.

Analysing the whole list of locations recorded on IMDB, the aim is to visualize which are the countries that take advantage from these dynamics

and how nations behave differently in this process of import/export of shooting.

In figure 02 we can see how nodes inside of the general network acquire more or less authority bases on which parameter we choose to define their size. Difference is between this two parameters:

- inDegree: the bigger is the amount of countries which made locations into the referred node, the bigger is the node.
- outDegree: the bigger is the amount of countries in which movies of the referred node made locations, the bigger is the node.

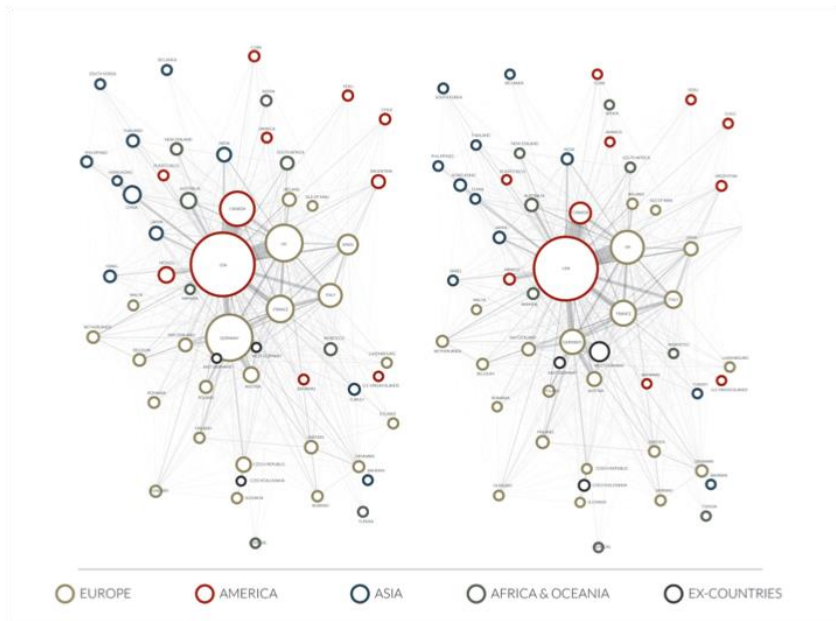


Figure 2 Network of countries linked by amount of location. Two nodes are close if the movies made in one of them have done a lot of shooting in the other one. Comparison between different node's size parameters, inDegree (left) and outDegree (right).

Using the same node's positioning, we can modify the visual substance of each country inside of the representation and we can see how there are big dissimilarity between the two variations.

At the same time, using the same information, an additional analysis on individual countries can be done, we can visualize the percentage of

locations made in a foreign country related to the total amount of locations recorded in the archive and see how different nations behave differently.

We can see in figure 03 some examples:

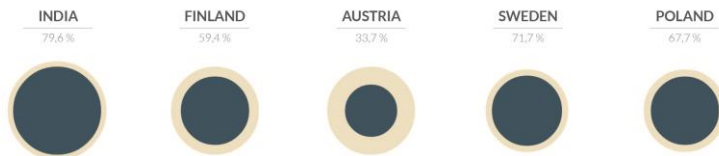


Figure 3 Example of individual country profiling. The light big circle is proportioned to the amount of locations known, the blue one represents the amount of location within the country.

2. Companies Analysis

A study on collaborations between national productions and different companies shows again a sort of economical side of this world. The most interesting part of this analysis is made by a network of countries more or less attracted to each other according to a value which is a count of times that a particular connection occurred (for example amount of times that Italian movies involved Spanish companies). As we see in figure 04 this network is dominated by western and economically better developed countries, it basically shows importance of a national film's industry within the global production.

BORDERS. Visual analysis of Cinema's inner dynamics and evolutions. A case study based on the Internet Movie Database

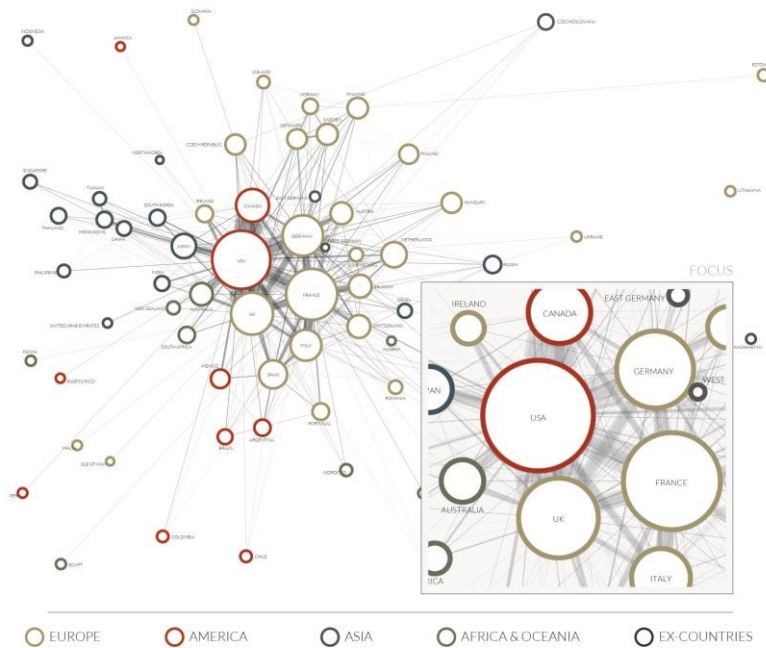


Figure 4 Network of countries linked by amount of companies involved in respective productions. The closer two nodes are, the bigger is the amount of times that the collaboration between elements of the two nodes appears in the archives.

At the same time it's interesting to focus on smaller economic systems and geographic areas, showing the historical evolution of inner dynamics.

In figure 05 we can see how the situation in the European continent has evolved and strongly changed during time, the amount of connections has clearly increased according to the dense network of connections between nodes and the amount of countries of which we have available data in the archive.

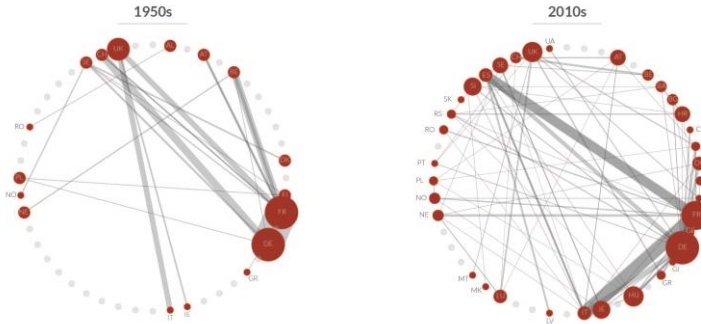


Figure 5 Circular network of european countries linked by amount of companies involved in respective productions. Comparison between 1950s and 2010s. Values are normalized to 2010s connections.

As we did before, we can visualize (figure 06) how an individual country evolved its own production involving foreign companies, showing interesting trends and a much more detailed point of view.

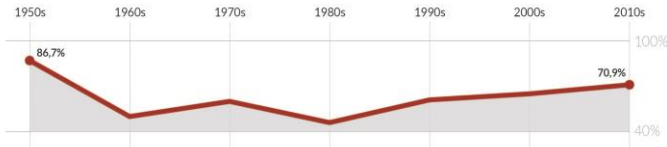


Figure 6 Percentage of Canadian companies involved in the Canadian movie’s production during time on the total amount of companies recorded.

3. Languages Analysis

As we said previously, a kind of information available on IMDB concerns languages of dialogs within the movies. Our opinion was that themes debated within a national film’s production are strongly connected to the history of the country and to events in which the nation itself has been involved in. Therefore a strong appearance of a foreign language in the

movies' dialogs of a specific country could represent a sort of link, a connection between different cultures and nations considered.

A bipartite network show us in figure 07 how countries and languages arrange themselves mutually, according to connections between them, generating new clusters and showing relationship developed during time. It's important to point out that, to highlight this feature, within the network has not been considered the link between a nation and its own mother language, obviously this value is numerically much bigger than any other connection and should force the network into a not interesting shape.

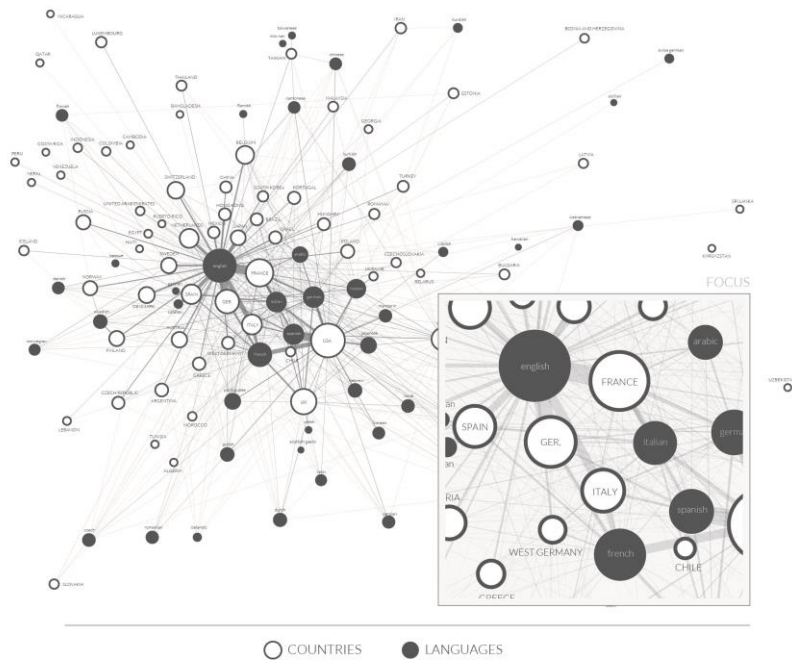


Figure 7 Bipartite network of countries and languages, nodes are linked by amount of times that a language appears in the movies of a country therefore a country and a language are close if the idiom appears a lot of times in the productions of that nation.

4. Release Dates Analysis

In this case, available data revealed itself as messy and confusing compared to the previous ones, tracking release dates of movies in different countries is not easy and it shows another peculiarity, in the IMDB archive we can find complete data regarding most famous and biggest productions but at the same time, data regarding small national systems and less important movies are incomplete or not significant.

To develop a correct analysis of the global movies' distribution phenomenon it was necessary to take a step back and base it on a reliable set of data. Specifically we decided to focus and analyse distribution of US movies around the world, indeed into the database they are quantitatively much more represented than the other countries and related release dates are better recorded.

Furthermore we decided not to evaluate data related to TV programs and TV series, which follows different and specific ways of distribution.

We thought that the better way to verify potential trends during time of this particular aspect was to visualize in each decade how many American movies were released in any other nation and how far (days of delay) from the American release date, generating a sort of economic and cultural detachment between United States (which can be considerate as leading country) and any other country.

Supposition is that a movie is released earlier where there is more interest and therefore more chance to get a gain from it.

In figure 08 we have a clear representation of the phenomenon and how it evolved during time, speeding up. For example, if we look at two different decades, the nineties and the last one from 2010 and beyond, we can see how there are significant differences between them. In the first case, American movies were not released before a six months delay from the American date, in the last years they need no more than ninety days to get in almost every country, witnessing the process of globalization, expansion of the Hollywood industry and technology evolution of the last century.

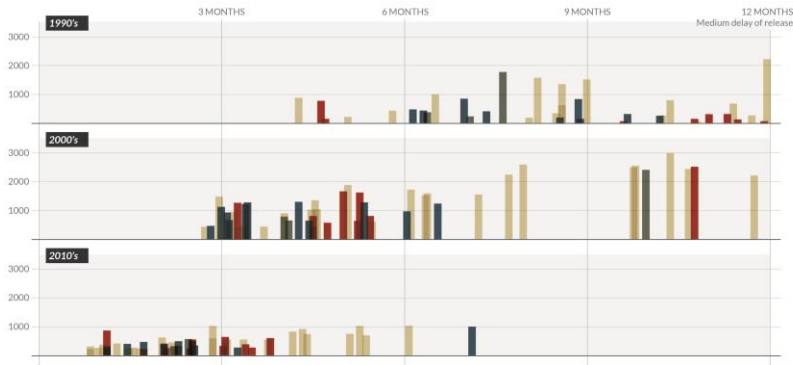


Figure 8 Evolution of American movies distribution during time. Each bar represent a country colored by continent, proportioned to amount of movies distributed and moved to the right depending on medium delay from the American release date.

5. Wikipedia's analysis

What we did in this last paragraph was to verify how films of each country are represented on the different Wikipedian linguistic versions through related pages.

To collect necessary data we used both DbPedia (dbpedia.org) and the encyclopedia's APIs.

DbPedia is a crowd-sourced community which extract structured information from Wikipedia, we relied on it to obtain a list movies with all the respective pages on the different linguistic versions of the online encyclopedia. What we wanted to do was to verify the overall interest on national productions evaluating their amount of pages on each Wikipedia.

Since pages are different between each other, we had to find a way to evaluate the importance of every single one, the idea was that a page full of information could not be considered likewise a page which is just sketched or incomplete.

To overcome this problem we decided to use the 'Page size' data which is available for each one.

We were not interested in the accuracy of information within the pages which can be problematic and untrustworthy (Kittur *et al.*, 2008), otherwise since we just wanted to consider differences between pages, the weight (expressed in bytes) was enough since we did not care about kind of

informations, indeed in any case lot of data means lot of interest which was what we were searching for.

So, the value which connects countries and Wikipedias in figure 09 has been calculated not just counting the amount of pages but summing their weight.

Our supposition was that people are more inclined to upload data on their own language version of the encyclopedia and so what we got is a bipartite network in which we can see how national movie's production is available on different Wikipedias.

A problem here was how to consider the English version, since it is a kind of global web landmark which we could not relate to a language culture, moreover since we use it as a starting point where to find list of movies categorized by country of origin (dpPedia.org refers to the english version of the encyclopedia), it would result as a version where all the pages related to movies are available, so we removed it and we considered it as we did with mother languages in the paragraphs before.

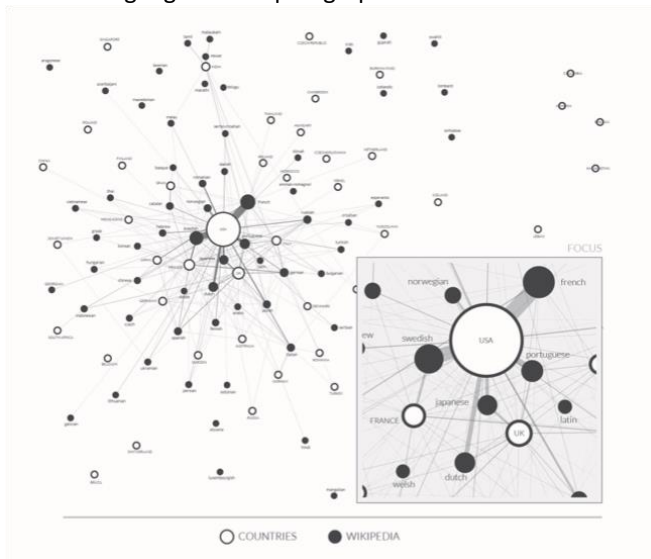


Figure 9 Bipartite network of countries and Wikipedias. Nodes are linked by total amount of page sizes related to movies of each country available on the encyclopedias, therefore a proximity between a nation and a website means that the national production is well recorded on that particular Wikipedia.

Discussion and future work

The enormous starting database gave us big hints but at the same time big doubts on the actual feasibility of this analysis, while human eye is able to evaluate in advance and wonders a certain kind of results on small datasets, when we deal with archives as big as what we had we can only try some sample surveys to explore and verify the actual consistency of the used information.

Risk to obtain non significant or non consistent visualizations was big but, after all, we saw how data have revealed themselves as graphically analyzable, showing trends and evolutions during time. If we consider networks, one of the possibilities was to obtain unclear or scattered results which could be very hard to understand, on the contrary countries grouped into clusters easing the comprehension of visualizations.

Visual representations return clear images of a non tangible world with new geographies built up film by film and year by year. The world of cinema is a complex system characterised by no accidental dynamics which have been developed during time.

The visualizations we obtained do not solve this complexity, on the opposite they try to preserve it creating a way to show inner relations and roles of individual national productions, revealing that connections that would otherwise remain hidden inside the archives without any chance to get explored and understood.

Getting access to this huge amount of data, combined with the simplification of processes of visual exploration given us by new software and by recent general interest in data visualization, gives us the chance to verify different features of different phenomena such as Cinema or Literature, without relying on sample surveys.

Results show, especially where it is possible and reasonable to verify an historical evolution, various aspects related to different sides of society.

They concern economical features when we analyse locations and companies involved into productions, otherwise they concern some more social-cultural features when we focus on release dates, languages or the Wikipedian part of the subject. What we mean is that with these archives of information we can obtain a complete and variegated picture of global situation and dynamics evolved during the last century.

We want to highlight that in this project has been used just a little part of data available on IMDB. In future could be very interesting to aggregate new datasets extending the research and showing new aspects of the film

industry. A study on the social networks between actors, directors and other people involved in the production or on the budgets and incomes in different geographic areas are just two of the various chances offered by IMDb which can lead to a future bigger research and projects.

At the same time one of the weaknesses of this project is its strong connection with the user generated nature of the data. It is important to remind that the whole analysis does not come from an official archive but on the user generated content available on these platforms.

These websites have both positive and negative features. First of all during time they became a web landmark, attracting to themselves more and more users and data, generating an enormous archive on which we can develop analysis. Secondly this kind of information represent an image of the global interest of people in cinema rather than an 'official record' of the whole movie's production, since the upload of data is assigned to the users the archive reflects the matter of movies into the collective social imaginary (bigger the fame of a film is, bigger is the chance of having information into the database).

These websites have some lack for what concern the kind of users involved, national production such as Indian and Chinese (the first one much more bigger than the second one) are not well reported, both for a possible lack of interest by indian/chinese users (that maybe use to refer to other websites) and for a shortage of interest by western users to that kind of national productions that are numerically considerable, especially for the Indian one. To avoid incorrect or incomplete observations it's therefore necessary to keep in mind this peculiarities of the global society that affect participation and completeness of these archives.

However it could be very interesting to do the same analysis we did on IMDb starting from official databases and to verify differences and equivalences in these two images of the same world coming from various sources, to see disparities between the 'official' or verified situation and the collective interest in cinema.

'Borders' is the results of a Master of Science degree in Communication Design, therefore it has been developed since the beginning with a Design point of view.

We think that a collaboration with domain experts such as cinema's critics, data journalists, analysts or sociologists could provide more interesting insights and a deeper analysis about the subject.

This debate, which lacked during the project, could give us that interpretation of results that, being designers, we can't have the experience and skills to do.

What we create is an interpretation of the data, explored and graphically elaborated various times in that design process which lead us back and forth, from information to visualization repeatedly, in a continuous exchange of hints and elaborations.

Getting an external point of view, from professional fields perhaps more indicated for the study of cinema, could complete the project bringing impressions and evaluations which can lead the analysis to a multidisciplinary condision of process and results.

Conclusion

These maps and visualizations are more than a picture of cinema's world and its inner dynamics, they are hints and source of interests which in the future could develop again, fixing the lacks of the project and showing even new aspects.

The need of feedbacks and opinions from domain experts, such as the possibility to explore new datasets make 'Borders' a starting point for further analysis.

At the same time the chance given by this project of analysing different aspects of huge archives related to millions of cinema's and television's productions shows tangible results and a macroscopic point of view of this world and society.

References

- Ahmed, A., Batagelj, V., Fu, X., Hong, S., Merrick, D. and Mrvar, A. (2007) *Visualisation and analysis of the Internet movie database*. Paper Presented at the 6th International Asia-Pacific Symposium on IEEE.
- Bastian, M., Heymann, S. and Jacomy, M. (2009) *Gephi: an open source software for exploring and manipulating networks*. Paper Presented the International AAAI Conference on Weblogs and Social Media, North America.
- Bencivenga, A., Mattei, F.E.E., Chiarullo, L., Colangelo, D. and Percoco, A. (2013) *La formazione dell'immagine turistica della Basilicata e il ruolo del cinema*. *Rivista di Scienze Regionali*, 3 (6).

- Caviglia, G. (2013) *The design of heuristic practices. Rethinking communication design in the digital humanities*. Unpublished Ph.D. Dissertation.
- Cutting, J.E., Brunick, K.L., DeLong, J.E., Iricinschi, C. and Candan, A. (2011) *Quicker, faster, darker: Changes in Hollywood film over 75 years. I- Perception*, 2 (6), 569-576.
- Goldfarb, D., Arends, M., Froschauer, J. and Merkl, D. (2013) *Art History on Wikipedia, a Macroscopic Observation*. Paper Presented at the Proceedings of the 3rd Annual ACM Web Science Conference, New York.
- Herr, B.W., Ke, W., Hardy, E.F. and Börner, K. (2007) *Movies and Actors: Mapping the Internet Movie Database*. Paper Presented at the Proceedings of the 11th International Conference on Information Visualization Zurich.
- Jacomy, M., Heymann, S., Venturini, T. and Bastian, M. (2011) *ForceAtlas2, A continuous graph layout algorithm for handy network visualization*. Medialab center of research.
- Jessop, M. (2008) Digital visualization as a scholarly activity. *Literary and Linguistic Computing*, 23 (3), 281-293.
- Jockers, M.L. (2012) *Computing and visualizing the 19th-century literary genome*. Paper Presented at the Proceedings of Digital Humanities Conference, Hamburg.
- Kittur, A., Suh, B. and Chi, E.H. (2008) *Can you ever trust a wiki?: impacting perceived trustworthiness in wikipedia*. Paper Presented at the Proceedings of ACM conference on Computer supported cooperative.
- Latour, B. (1996) *On actor-network theory. A few clarifications plus more than a few complications*. *Soziale welt*, 47 (4), 369-381.
- Manovich, L. (2013) *Visualizing Vertov*. *Russian Journal of Communication*, 5 (1), 44-55.
- Masud, L., Valsecchi, F., Ciuccarelli, P., Ricci, D. and Caviglia, G. (2010) *From data to knowledge-visualizations as transformation processes within the data-information-knowledge continuum*. Paper Presented at the Proceedings of the International Conference on Information Visualisation.
- Morawetz, N., Hardy, J., Haslam, C. and Randle, K. (2007) *Finance, Policy and Industrial Dynamics—The Rise of Co-productions in the Film Industry*. *Industry and Innovation*, 14 (4), 421-443.
- Moretti, F. (2005) *Graphs, maps, trees: abstract models for a literary history*. London: Verso Books.
- Van Ham, F. and Perer, A. (2009) 'Search, Show Context, Expand on Demand': Supporting Large Graph Exploration with Degree-of-Interest.

BORDERS. Visual analysis of Cinema's inner dynamics and evolutions. A case study based on the Internet Movie Database
IEEE Transactions On Visualization And Computer Graphics, 15 (6), 953-960.



Smart Meters as boundary objects in the energy paradigm change: the CIVIS experience

Giacomo PODERI^{*}, Matteo BONIFACIO, Andrea CAPACCIOLI, Vincenzo D'ANDREA and Maurizio MARCHESE
University of Trento

The challenges of global warming, together with developments in renewable energy technologies and ICT are driving a radical change in the way energy is produced, transmitted and used: we are entering the paradigm of smart grids that is characterized by a fundamental shift from a central and one-way energy flow to a distributed and bidirectional one. As suggested by STS tradition, we see paradigm changes and technological innovations as collective construction processes whereby negotiation, appropriation, adoption and resistance dynamics characterize the complex relationships brought about by different human and non-human actors. By drawing on the goals and preliminary activities of CIVIS we discuss smart metering technology as a key boundary object amid intricate and heterogeneous stakeholders' interests. CIVIS objective is to design a fairer and more sustainable, energy-optimized city by linking energy, ICT and society to achieve significant impacts in terms of CO₂ emissions reduction and new forms of social innovations that are able to tackle actual social demands. The paper will (i) briefly discuss the potentialities and the critical aspects of smart meters; and (ii) sketch a stakeholders' map where smart meters act as boundary objects along the way of achieving CIVIS goals.

Keywords: Smart meters; boundary object; smart energy grids; energy paradigm; multiple value systems

The ongoing energy paradigm change

To respond to the challenges of climate change has progressively become a pressing issue for contemporary society. Over the last couple of decades, international and national efforts tried to produce a shared

^{*}Corresponding author: Giacomo Poderi | e-mail: giacomo.poderi@unitn.it

actionable vision for reducing gas emissions and adapting to climate impacts (e.g. UN Kyoto Protocol; EU 2020 Climate and Energy Package). Despite the doubts about their efficacy, these efforts made clear the need for a transition in our energy paradigm (Bulkeley et al., 2011). The developments and the diffusion of renewable energy technologies together with the deployment of advanced ICTs into the energy infrastructure are important parts of this transition: we are entering the paradigm of smart grids that is characterized by a fundamental shift from a central and one-way energy flow to a distributed and bidirectional one. Passive one-way communications and power flows centrally managed by large suppliers to consumers are giving way to a more (re)active and de-centralized paradigm (Farhangi, 2010). Energy grids are defined as 'smart' if they can modify their output and are able to monitor, control and meter the demands of consumers in a regulated and fair way. In this sense, ICT plays a key role in measuring, forecasting, and optimizing the consumption and production patterns and in adjusting the energy flows between different parts of the system (Hargreaves, Nye and Burgess, 2010).

As clearly identified in Science and Technology Studies (STS) tradition, paradigm changes and technological innovations rarely follow linear, clear and deterministic trajectories while they are emerging and consolidating. Indeed, they are part of collective construction processes whereby negotiation, appropriation, adoption and resistance dynamics characterize the complex relationships brought about by the different human and non-human actors who populate the various social worlds that are directly or indirectly affected by such changes (Hughes, 1993; Bijker, 1995). This is particularly fitting for the energy domain. At the normative level, national and supranational entities are promoting policies and directives that cover new energy sources and, at the same time, try to steer energy management for the achievement of CO2 emission targets (Da Graça Carvalho, Bonifacio and Dechamps, 2011). At the level of technological infrastructure, the rise of a new set of energy production technologies is converging into the traditional energy distribution network and new integrated ICT tools are getting progressively adopted in order to provide the system with 'smart' capabilities (Hidaka, 2011). At the socio-economic level, a proliferation of new actors in the market value chain emerged both from the disbandment of national energy monopolies into a free market condition (Genoud and Varone, 2002) and from local, bottom-up aggregations sustained by energy *prosumers* (Toffler, Langul and Forbes, 1981) and consumers. Indeed,

people and groups are becoming prosumers of energy and are gaining a greater control over the use of the energy that they consume and produce: they can benefit from energy tariffs that better supports their energy needs or economic constraints. More interestingly, they have the concrete possibility to produce energy (e.g. with photovoltaic panels or biomass heating).

One of the key enabler paving the way for such a transition has been the development of smart metering technology and its deployment into the energy infrastructure. By allowing for remote control, bi-directional communication and frequent readings of energy consumption (and production) data at the end-users level – private citizens or enterprises – smart metering enables a whole new set of possibilities for energy management. However, as we will try to show in this paper, smart meters are amid intricate layers of heterogeneous interests that, if properly aligned, may promote far greater benefits for the society than just energy optimization. Indeed, by reflecting on the early activities of CIVIS project we will present smart meters as boundary objects in the ongoing energy paradigm change. Furthermore, we propose that, with the proper alignment and translations of stakeholders' interests, energy may be turned into a collectively managed common good (Ostrom, 1990) that can be beneficial at a societal level beyond the sole energy domain.

The paper tackles the relationship between emerging ICT and citizens' values at two different, yet intertwined levels: it focuses on the crucial challenge that society at large faces in relationship to global warming, climate change, CO2 emissions and the changing energy paradigm by putting it in direct relationship with societal issues that go beyond the domain of energy. Furthermore, it specifically focuses on the role of smart metering technology as boundary objects along the way of the implementation of fairer, more sustainable, and energy-optimized living areas. The paper is structured as follows. Firstly, we briefly describe the characteristics of smart metering technology and its most common usage. Secondly, we present the concept of boundary object. Thirdly, we introduce the vision of the CIVIS project, its objectives and methodology. Fourthly, we describe in more details the characteristics of the project's Italian test beds and their contingencies related to smart metering. Finally, we briefly discuss the idea of smart metering technology as a boundary object.

Smart metering technology for electricity

Smart meters are a new generation of advanced and intelligent measurement devices that have the ability to record the energy consumption of a particular measuring point with a variable frequency (intervals of fifteen minutes or even less). Differently from old traditional analog meters whose information could only be read on-site, these so called 'smart meters' can also communicate and transfer the information recorded in real time or at least on a daily basis by means of any communications network to the utility company for purposes such as monitoring of the system load as well as for billing purposes ('tele-metering'). In addition to the ability to measure the consumption over very short intervals, smart meters enable a two-way communication between the meter and the central system of the utility company, the so called Distribution System Operator (DSO). In other words, a smart meter not only communicates current or recent metering data, but it also enables the DSO – and possibly the energy supplier as well – to remotely control functionalities of the meter (Knyrim and Trieb, 2011; Farhangi, 2010). Smart meters exist for all types of energy (electricity, heating, gas, water), but only the electricity ones achieved high-level usability and deployment into energy infrastructures. Therefore, we focus here mainly on smart meters for electricity.

Starting from the early 00's, smart meters have been progressively installed in large numbers throughout the world due to the benefits they are expected to bring to the electricity supply industry and its customers. In Europe the legislative push by the European Union is the major drive for the adoption of such technology (Hierzinger et al., 2012). The Directive 2009/72/EC, which is part of the so-called Third Energy Package demands the Member States in order to promote energy efficiency and to ensure consumer protection to implement smart metering systems "that shall assist the active participation of consumers in the electricity supply market". Where the roll-out is assessed positively, the directive demands that by 2020 at least the 80% shall be equipped with smart meters.

Many different stakeholders gravitate around smart meters, with very different objectives. Producers of smart meters are eager to take advantage of the expansion of this market. The companies that purchase electricity in the wholesale market and sell electricity to consumers in the retail market (energy suppliers) expect to reduce the operational overheads associated with traditional manual meter reading; the operators of the energy transmission system and distribution networks hope to benefit from a more

flexible demand side which could allow greater adoption of renewable energy technologies; governments hope that the improvements in end-use energy efficiency promised by smart meters will help to achieve binding carbon reduction targets (McKenna, Richardson and Thomson, 2012). Finally, end-users may benefit from reduced electricity bills. Indeed, smart meters allow for more fine-grained and richer energy consumption information both at the household level, where reading may be done directly by end-users, and through enhanced bills provided by the retailers. As end-users become more energy aware they also tend to adopt more energy-friendly practices (Hargreaves, Nye and Burgess, 2010).

The development and deployment of smart metering technology is connected with a series of critical areas. From the perspective of general acceptance smart meters raise issues about end-users privacy as well as the assignment of too much power into the hands of energy utilities. Indeed on one hand the extensive use of personal data that each smart meters need for expressing its potential has often been a serious source of debate and opposition (McKenna, Richardson and Thomson, 2012; Knyrim and Trieb, 2011). From the perspective of their effectiveness, one of the major problems associated with smart meters capabilities relates to the communication means they rely on for transmitting their data. Indeed each smart meter installed depends on the local condition for transferring data. Some households are well connected the ICT networks, others are not. Furthermore, the large scale deployment of smart meter is a source of data transfer traffic that cannot be neglected. Whether smart meters should rely on existing data networks in place at the local level of installation or whether they should develop their own communication network is critical area of concern (Kulatunga et al., 2012). Finally, in order to effectively enhance smart grids capabilities, smart metering technology is getting progressively integrated into systemic frames for energy management. It is the case of so called Advanced Metering Infrastructure – AMI – or (Smart) Home Energy Management Systems – (S)HEMS (Saad Al-Sumaiti, Ahmed and Salama, 2014).

STS and boundary objects

Science and Technology Studies (STS) have traditionally focused on understanding scientific and technological knowledge production and they developed a long standing track on providing useful accounts and concepts for the study of complex socio-technical dynamics. In particular, STS clearly

showed that paradigm changes and technological innovations rarely follow linear and deterministic trajectories while these are emerging and consolidating. Indeed, such transformations are part of collective construction processes whereby negotiation, appropriation, adoption and resistance dynamics characterize the complex relationships brought about by the human and non-human actors who populate the various social worlds that are directly or indirectly affected by such changes.

In STS, the use of ecological and non-reductionist approaches to complex phenomena and dynamics, favoured the emergence of useful concepts for the disentanglement and understanding of such dynamics. In particular, the idea of *boundary objects* emerged to highlight both the network of interests brought about by different stakeholders and the common ground through which the social world of each stakeholder can be translated and made 'understandable' to others. In its original definition:

this is an analytic concept of those scientific objects which both inhabit several intersecting social worlds and satisfy the informational requirements of each of them. Boundary objects are objects which are both plastic enough to adapt to local needs and the constraints of the several parties employing them, yet robust enough to maintain a common identity across sites. They are weakly structured in common use, and become strongly structured in individual-site use. These objects may be abstract or concrete. (Star and Griesemer, 1989, p. 393)

Very different entities can act as boundary object as long as they provide this double function of maintaining stability for creating identity, while allowing for flexibility and adaptation. Basically, when a tension that cannot be avoided or deleted emerge between (a) an ongoing, stable relationship among different social worlds and (b) the shared objects that are built and exist across community boundaries, then boundary objects arise (Bowker and Star, 2000, p. 292). As such, boundary objects also become an interesting vantage point, or analytical lens, through which this tension can be better understood.

CIVIS vision towards a socially smart(er) city

Current projects and major approaches dealing with the transformation of the energy paradigm do it mainly from an economic and transactional

Smart Meters as boundary objects in the energy paradigm change: the CIVIS experience

perspective: objectives of energy consumption and CO₂ emissions reduction are pursued by leveraging on the idea that end-users act as *homo-oeconomicus* and therefore that economic incentives (e.g. incentives for solar panels installations; cheaper bills; 'ad-hoc' tariffs) are the best triggers for achieving these objectives. Projects such as *EcoGrid EU*, *ADDRESS* (Active Distribution network with Demand and distributed energy RESourceS), *BedZED* (Hodge and Haltrecht, 2010) and *Smarties* (Smart individual energy savers) all try to develop low-carbon emission and sustainable districts (or communities) by leveraging mainly on economic incentives and efficiency logics. However, energy paradigms have always had a pervasive role in changing and shaping societies and people's behaviors. Major transformations in energy paradigms corresponded to tipping points in the transformation of society and economy (Rifkin, 2011). We believe to be paramount that approaches harnessing with the transformation of energy paradigm do it also by accounting for their societal impact or by investigating the possibilities that such transformation opens up for domains other than the energy one.

CIVIS is a recently funded interdisciplinary project (2013-2016) in the 7th European Framework Programme that goes one step further than these approaches. Indeed, CIVIS tries to assess whether energy may be turned into a common good that people can consume, generate and allocate on the basis of diverse and heterogeneous needs, preferences and values. The project explores the potential of social networks and communities to significantly reduce energy use and carbon emissions by developing social models for the resulting energy system and by supporting it with the necessary ICT. In a nutshell, CIVIS will contribute to the design of a fairer, more sustainable, energy-optimized smart city by linking energy, ICT and society to achieve significant impacts in terms of CO₂ reduction and new forms of social innovation that provide responses to pressing social demands.

The project adopts an experimentally driven approach, whereby R&D activities are complemented and sustained by testing and validation in real-life environments. Such an approach will be pursued iteratively in collaboration with local stakeholders. Two main pilot sites, located in Trentino (Italy) and Stockholm (Sweden) will be used to test and validate the technical developments of the project as well as to assess their impacts in terms of energy savings, CO₂ reduction, changes in users' attitudes and behaviors. This paper focuses on the Italian pilot site which is, in turn, divided into two specific test beds: *Southvillage* and *Northvillage*.

Currently, CIVIS just passed the half of its first year and the main project activities, which the consortium is occupied with, concern the definition of (i) the baseline scenarios for the pilot sites and (ii) the piloting activities that will be performed on site. The former requires the gathering and modeling of historical energy data and of socio-economic ones. These data are to be accessed and retrieved through the local stakeholders (public administrations, energy utilities and retailers, local associations). The latter involves the use of scenarios and user stories (Kankainen et al., 2012) as method for defining a feasible line of actions to be performed in the pilot sites in order to meet the project objectives. This activity also involves a close cooperation with local stakeholders.

The relevance of smart meters for the project implementation clearly emerged already in this initial phase. On one hand, the project aims for changes at the level of end-users energy-related practices and in order to achieve this, one of the most effective way is to make energy consumption more visible and transparent to the end-users (Hargreaves, Nye and Burgess, 2010). This implies smart meters data to be fed back to end-users in a synthesized, analyzed and more understandable way. On the other hand, in order to monitor the impact of CIVIS activities, the projects need to gather energy-flows data. For both aspects, data should be available at the best possible level of granularity either at the point in time (frequency of reading) and place (individual end-users households).

The Italian test beds

CIVIS Italian pilot site is located in Trentino Alto-Adige, a northeast Italian region and it includes two specific test beds: two small municipalities, located in the inner and southernmost area of the region. The municipality of Southvillage covers an area of about 62km² and has a population of about 4800 inhabitants. It is mainly a residential area with little tourism. However, it has a lively and small manufacturing area. The municipality of Northvillage covers an area of about 60km² with a population of 1200 inhabitants. This is a residential area with no manufacturing district. However, it has some infrastructure for tourism as it is an area with a very old and well preserved historical hamlet beside being a way into a National Natural Park.

From the perspective of energy supply, an interesting peculiarity that is common to both test beds is that electricity is produced and provided by two electrical consortia: respectively, Southern Electrical Consortium (SEC)

Smart Meters as boundary objects in the energy paradigm change: the CIVIS experience

and Northern Electrical Consortium (NEC). These are local based Cooperative institutions participated by individuals with the aim to support the local territory in managing energy services, particularly with the production, distribution and management of electrical energy. For both consortia, slightly more than 90% of their customers are also associate members of the organizations. Being a member grants favorable discounts in the energy price. Due to the existence of these consortia which are deeply rooted in the history of these areas (their constitution dates back to 1900s), the local communities are relatively aware of energy management and renewable energy issues.

Through the involvement of the local stakeholders (mainly the Electrical consortia and public administration representatives) of South- and Northvillage in the designing of the user stories and scenarios for CIVIS activities the main area of intervention has been identified at the level of energy load balance. By relying on renewable sources both SEC and NEC produce electrical power capacity that could potentially cover more than 50% of the citizenship's electrical needs in the case of the former and 100%, in the case of the latter. However, being renewable sources highly conditioned by time of day and season of the year, there are countless situations when the Consortia cannot cover citizenship's needs and therefore must buy electricity from the national grid. At the same time, there are moments when produced energy is in surplus and therefore is sold to the national grid, with very little margins for profits, due to the national regulations on energy market.

To bring peak of consumptions closer to peaks of production is the concrete goal that is able to put on common factor CIVIS objectives with local stakeholders' ones. Indeed, SEC and NEC will reinvest part of the savings coming from load balancing into collectively defined targets for the improvement of quality of life in the test beds.

In order to trigger individual-to-collective dynamics that can affect energy load balance and achieve these goals, CIVIS will work at the level of public awareness; it will enable feedback loops about energy production and consumption at the end-users level, either via enhanced billings and via mobile apps (or other ICT-based means); it will promote simulations of distributed and virtual power plant based on serious-games approaches. In order for this approach to be implemented the data about energy consumption and production need to be accessed and processed at the best possible granularity level: intervals of 15 minutes at individual household.

Here, the preliminary effort of CIVIS revealed very different situations and intricate network of relationship among stakeholders, which we try to simplify in the next subsections.

Smart metering in Southvillage

Smart meters installed in Southvillage are produced by Landis+Gyr: a multinational corporation headquartered in Switzerland that focuses on metering and other technologies for energy management. SEC which is the DSO and, for more than 90% of Southvillage population, also the electricity retailer retrieves the metering data monthly for billing purposes.

However, the software of these meters allows for the retrieval of data at a more detailed granularity level. Therefore, SEC could provide CIVIS with 15 min intervals data (provided that proper warranties for confidentiality and ethical treatments are given) at households level.

The transmission of data at 15 min interval level would imply an increase of data traffic on the local network. At the moment metering data get transferred only monthly, a 15 min, or an hourly transfer of data for each meter installed implies a consistent increase of data traffic on the network. Nonetheless, this would be feasible in this specific context, because NEC is also owner of the optical fiber network and service provider for connectivity in Southvillage. Given that at the moment the bandwidth of the hyperlan network is heavily underutilized and given that basically each NEC electricity end-user is also a network end-user there is a favourable overlap between metering technology and telecommunication infrastructure for data transfer.

Smart metering in Northvillage

Smart meters installed in Northvillage are produced by IBM/Enel: a joint venture of two multinational corporations which produced one of the most widely adopted smart meter model worldwide and, certainly, in Italy. NEC which is the DSO and, for more than 90% of Northvillage population, also the electricity retailer retrieves the metering data monthly for billing purposes.

The software of the installed meters does not allow for the retrieval of data at a more fine-grained level. Therefore, NEC could only provide CIVIS with monthly data (provided that proper warranties for confidentiality and ethical treatments are given). A more granular level of data would require the meters manufacturer to modify the meter software and enter in a

Smart Meters as boundary objects in the energy paradigm change: the CIVIS experience

different agreement with NEC about the procurement of the smart meter installed. An option that is not feasible under CIVIS frame.

For this reason, it was agreed that a number of additional sensor would be installed by CIVIS, on top of the existing meters which would allow for more fine-grained data availability. At the moment, four different sensors are being evaluated for deployment and integration. Key criteria for the evaluation are the means of data transfer. Indeed, additional sensors as well as traditional smart meters, do not have long distance broadcasting capabilities. Therefore, data transfer should rely on local ICT infrastructure either via Wi-Fi or via cable.

Boundary objects along the way of CIVIS implementation

CIVIS tries to answer in an innovative way and through a systemic approach to a pressing contemporary challenge: climate change and the related transformation of the energy paradigm. This implies that goals of CO2 emission reduction and energy optimization are pursued by putting societal needs 'on the map' and by leveraging on the belief that individual can be harbinger of multiple-value systems when they come together as groups or communities. In the attempt of gaining access to the main data type (*i.e.* energy flows) which is required for pursuing piloting activities and implementing CIVIS vision, it became clearer the tangled network of interests put in place by smart metering technology.

As hinted in Star (2010), we suggest that such technology can be seen to act as a boundary object within the scale and scope of the organizational setting which is enacted by CIVIS project consortium and the local stakeholders in the attempt to cooperate for the design and implementation of a 'socially smart(er) grid' that is able to harness energy as a common good.

Smart metering technology is a stable enough entity allowing the emergence of relatively stable power relations among different stakeholders: as (preliminarily) identified in figure 1, smart meters enable a 'functioning' socio-technical network that attends to the production, distribution, sales, management and consumption of electricity. More interestingly, with particular regards to CIVIS practical activities, smart meters emerged as a 'given for granted' technological object upon which the stakeholders (CIVIS' ones included) had no problems in discussing and agreeing about as if the meters were able to satisfy most of the project data-needs.

However, when the socio-technical configurations that are specific to each individual test bed came to the fore, smart meters became a much more concrete and specific object, strongly structured and embedded in local contexts which allowed very different data supply. This called for tailored investigations and ad-hoc solutions for what concerned the standardization of data-gathering approach (retrieval and transmission) that is needed within the scope of CIVIS. In this sense, smart metering technology also emerges as flexible enough entity that comprises local contingencies, work around, incremental developments and (re-)interpretations into broader frames which re-configure their main purposes and features.

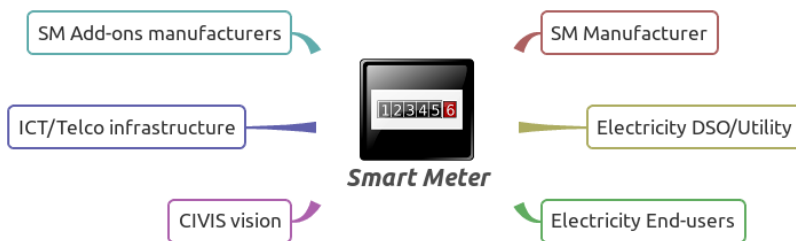


Figure 1 CIVIS stakeholders map for smart metering technology as a boundary object.

By putting together the different contexts of the two Italian test beds, we identified a set of preliminary key stakeholders, as mapped in (figure 1), having at the centre smart metering technology as a boundary object. Each of the stakeholders represented in the Figure has a specific configuration attending the individual test beds. It is the aim of CIVIS forthcoming steps to identify the most optimal infrastructuring solutions that, by accounting for these contingences, will be able to enhance and standardize smart meters capabilities for harnessing energy data and therefore to promote new socio-technical alignments that are more capable to support the implementation of a 'socially smart grid'.

Acknowledgment

The research leading to these results has received funding from the European Union Seventh Framework Programme (FP7/2007-2013) under grant agreement n° 608774.

References

- Bijker, W.E. (1995) *Of bicycles, bakelites, and bulbs: Toward a theory of sociotechnical change*. Cambridge: MIT Press.
- Bowker, G.C. and Star, S.L. (2000) *Sorting things out: classification and its consequences*. Cambridge: MIT Press.
- Bulkeley, H.A., Broto, V.C., Hodson, M. and Marvin, S. (2011) *Cities and Low Carbon Transitions*. London: Routledge.
- Farhangi, H. (2010) The Path of the Smart Grid. *IEEE Power and Energy Magazine*, 8 (1), 18-28.
- Genoud, C. and Varone, F. (2002) Does Privatization Matter? Liberalization and regulation: The case of European electricity. *Public Management Review*, 4 (2), 231-256.
- Da Graça Carvalho, M., Bonifacio, M. and Dechamps, P. (2011) Building a low carbon society. *Energy*, 36 (4), 1842-1847.
- Hargreaves, T., Nye, M. and Burgess, J. (2010) Making energy visible: A qualitative field study of how householders interact with feedback from smart energy monitors. *Energy Policy*, 38 (10), 6111-6119.
- Hidaka, K. (2011) Smart grid as new big opportunity of information and communication technology. *Quarterly Review*, 38, 23-39.
- Hierzinger, R., Albu, M., van Helburg, H., Scott, J.A., Lazicki, A., Penttinen, L., Puente, F. and Saele, H. (2012) European Smart Metering Landscape Report 2012, Vienna: Austrian Energy Agency (AEA). [Online] <http://www.energyagency.at/fileadmin/dam/pdf/projekte/klimapolitik/SmartRegionsLandscapeReport2012.pdf> [Accessed: 17 May 2014].
- Hodge, J. and Haltrecht, J. (2010) *BedZED Seven Years on: The Impact of the UK's Best Known Eco-village and Its Residents*. London: BioRegional.
- Hughes, T.P. (1993) *Networks of power: electrification in Western society, 1880-1930*. Baltimore: Johns Hopkins University Press.
- Kankainen, A., Vaajakallio, K., Kantola, V. and Mattelmäki, T. (2012) Storytelling Group—a co-design method for service design. *Behaviour and Information Technology*, 31 (3), 221-230.
- Knyrim, R. and Trieb, G. (2011) Smart metering under EU data protection law. *International Data Privacy Law*, 1 (2), 121-128.
- Kulatunga, N.A., Navaratne, S., Dole, J., Liyanagedera, G. and Martin, T. (2012) *Hardware development for Smart Meter based innovations*. Paper Presented at the Proceedings of the 2012 IEEE Innovative Smart Grid Technologies – Asia. Tianjin, China.

- McKenna, E., Richardson, I. and Thomson, M. (2012) Smart meter data: Balancing consumer privacy concerns with legitimate applications. *Energy Policy*, 41, 807-814.
- Ostrom, E. (1990) *Governing the commons: The evolution of institutions for collective action*. Cambridge: Cambridge University Press.
- Rifkin, J. (2011) *The third industrial revolution: How lateral power is transforming energy, the economy, and the world*. New York: Palgrave Macmillan.
- Saad Al-Sumaiti, A., Ahmed, M.H. and Salama, M.M.A. (2014) Smart Home Activities: A Literature Review. *Electric Power Components and Systems*, 42 (3-4), 294-305.
- Star, S.L. and Griesemer, J.R. (1989) Institutional Ecology, 'Translations' and Boundary Objects: Amateurs and Professionals in Berkeley's Museum of Vertebrate Zoology, 1907-39. *Social Studies of Science*, 19 (3), 387-420.
- Star, S.L. (2010) This Is Not a Boundary Object: Reflections on the Origin of a Concept. *Science, Technology & Human Values*, 35 (5), 601-617.
- Toffler, A., Longul, W. and Forbes, H. (1981) *The Third Wave*. New York: Bantam Books.

The materiality of code: Towards an understanding of socio-technical relations

Winnie SOON*

Aarhus University

This essay studies the source code of an artwork from a software studies perspective. By examining code that come close to the approach of critical code studies (Marino, 2006), I trace the network artwork, Pupufu (Lin, 2009) to understand various real-time approaches to social media platforms (MSN, Twitter and Facebook). The focus is not to investigate the functionalities and efficiencies of the code, but to study and interpret the program level of code in order to trace the use of various technological methods such as third-party libraries and platforms' interfaces. These are important to understand the socio-technical side of a changing network environment. Through the study of code, including but not limited to source code, technical specifications and other materials in relation to the artwork production, I would like to explore the materiality of code that goes beyond technical implementation, and to consider the things that have been inscribed in the level of code socially. I argue that examining code is a way to understand socio-technical relations.

Keywords: Code; software; socio-technical; non-human

Introduction

This paper is about the social relations and the socio-technical interfaces of the Internet, traced from and through a piece of software artwork. Drawing upon actor-network theory, Latour reiterates the notion that encountering the nonhuman is essential and that attention should not be given exclusively to the human in order to understand the social (1992). He considers both humans and nonhumans as hybrid assemblages (Latour, 1993; 2005) that post forces through multiple connections, relations and interactions in a network. Social technology such as software libraries, social media platforms and parameters of software communication interfaces are all regarded as assemblages that inform how software is being produced

* Corresponding author: Winnie Soon | e-mail: wsoon@dac.au.dk

and shaped. Indeed, the conceptualization of a software artwork is constantly negotiated with technology; it is not merely a tool for execution. In other words, what the audience experiences with and through an artwork, or an action-event specifically through the running of software, essentially involves the co-participation of humans and nonhumans. By focusing and analyzing the program code of artists' software and the use of social technology, I ask how social technology shapes the work of art, in particular those artworks that require coding and working with real-time forms of data. Although scholars have explored different dimensions of software sociality (Fuller, 2003; Chun, 2011; Bucher, 2012; Manovich, 2013; Berry, 2013), little attention has been paid to the relation of program code and sociality. The aim of this paper is to understand the social network environment by discussing the materiality of code, examining sociality through program code and unfolding the social-technical inscriptions at the level of code.

Social Software

Software is an invisible material, which nowadays manifests and embeds into different devices, gadgets and touch points. Berry states that 'software has become crucial to the everyday operation of the society' and he proposes that we are living in a 'softwarized society' (2013, p. 55). It is ubiquitous and permeates seamlessly into every aspect of life. Along the line of thinking software as an essential operational tool in our culture, Mackenzie describes software as 'a social object and process' that is mutable (2006, p. 1). It alters according to new technology, digital culture and network environments. He states that the reading and writing of code express 'abstract relations and formal operations' between, and within systems (ibid, p. 6). These systems associate with wider social domains, '[encompassing] different practices of production, consumption, use, circulation and identity' (ibid, p. 2). In this way, both Berry and Mackenzie offer a perspective in examining programmable software beyond instrumentation.

Network artists write software with computer code that interfaces with different programs, databases and protocols, allowing data to translate and transform continuously from one space to another, as well as from one form to another. They are interested in the materiality of network, and many of them use real-time forms of data as an artistic material; and with real time technology, the live happening of data translation is understood as an event

that is triggered by code running invisibly and establishing a connection with the social, where assemblages are constantly transforming. Thinking with both the dimensions of humans and nonhumans, technological relations—such as how program code consumes data, how program code retrieves data from databases and how program code accesses data—become as what Adrian Mackenzie might call ‘action-events’ to describe agency.

Technology goes beyond technical actions and instrumentations as ‘physical events’, whereby ‘an action to which a cognitive dimension is attached’ (Mackenzie, 2006, p. 8). All these actions suggest the attention at social—how things are related—and technical interfaces that allow data translation to take place. This comes close to how Andersen and Pold (2011, pp. 9-10) discuss both the functioning and meaning of interfaces, which ‘combine—and translate—signs and signals’ from one space to another. The focus here, then, is to critically investigate the technological, artistic, cultural or social significance of these action-events through interfaces.

What’s behind the award-winning piece, *Pupufu*

This paper discusses a network art project, *PuPufu* (2009), produced by the Taiwanese artist Lin Shih Chang who has a background in robotic technology. The artwork *Pupufu* has been widely exhibited in the United States, Hong Kong and Taiwan. It won the gold prize of K.T. Creativity Award/ Interactive Technology Art at the 4th Digital Art Festival Taipei. The piece contains four robotic devices functioning as ‘pseudo-organisms,’ and they have all been implemented with sensors that detect the physical condition and network happening (See fig 1). Text messages—in particular with the language symbols of ‘!’, ‘,’ ‘?’ and ‘.’—from three social media platforms (Twitter, MSN and Facebook) are extracted in real time from the network. The symbol data is then translated into physical behaviours: the flickering lights of LEDs and the kinetic movement of mechanical limbs.

These make the artwork a very dynamic piece that fills the gallery with live creatures, because the audience will not know when a creature will move and which one will move. The machines perform through running the software of *Pupufu*, and are subject to the dynamics of network environments. Every moving and flickering behaviour of each creature represents the presence of action-events from the network. On the one hand, the event is triggered by an unknown Internet user who composes a text message with a special symbol. On the other hand, the event is about the translation of the text data from users’ computers to storages in social media databases, to the gallery space where data manifests as pseudo-

WINNIE SOON

organisms. What I have described here relates to the processing of data. But how might we be able to understand the computational process between software? And how do they negotiate with the network? What are the socio-technical parameters involved in processing data? According to Mcpherson, the fluidity and processing of digital data 'involves data in motion'. These processes of navigation or motion relate to 'the depth of electronic forms' (2006, p. 202). Therefore, we might have to understand how data performs in order to examine the complex computational processes. She further suggests that examining code behind what the audience registers might help knowing the processing of data better.

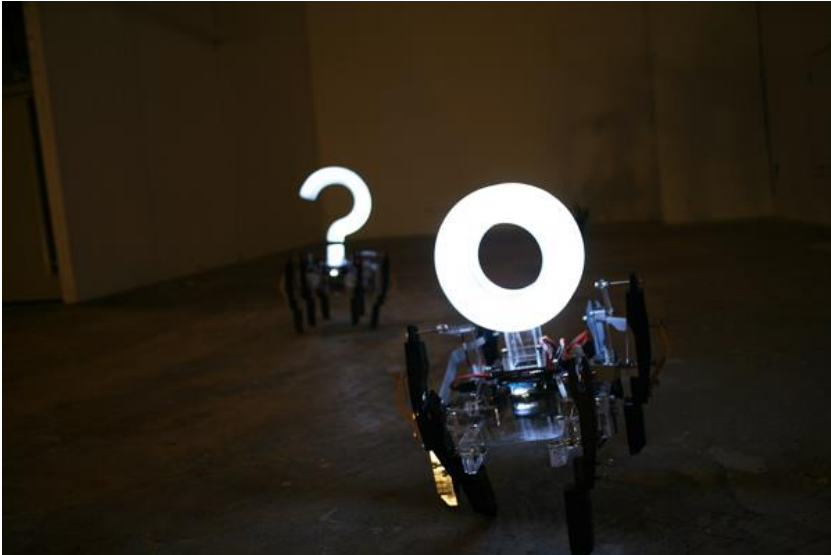


Figure 1 *Pupufu* (2009). Courtesy of the artist.

Examining and interpreting code: critical code studies

This essay undertakes a close reading of code. Indeed, a certain amount of technical knowledge is required in order to study and interpret code in detail. Although, as I have mentioned, the complexity of the data negotiation processes involves three different social media architectures, my background and knowledge in coding and technical interfaces enables me to understand them sufficiently. Therefore, I have asked Lin to submit

the source code of *Pupufu* and the technical flow diagram of the artwork in order to understand the interfacing of the networks. This approach is close to the semiotic-interpretative method that Mark Marino has suggested in critical code studies (CCS), where code is a 'cultural text' which presents different 'possibilities for interpretation' (2006). One of the important aspects for CCS relates to the critique of code. Here, I examine neither the aesthetics nor the efficiency of code. Marino's critical approach is to 'stress meaning, implication, and connotation...with respect to the broader social contexts' (ibid). As such, the executability of the code is not a focus. Rather, the analysis sheds light on the social relations of code that are embedded in the software. My analysis of code reading places emphasis on socio-technical dimension of inquiry and interpretation to understand the commercial institutions/platforms, network environment and software culture. Software contains algorithms, logics and code at program level. Marino further suggests a reflective analysis towards 'code itself, the coding architecture, the functioning of the code, and specific programming choices or expressions, to that which it acts upon, outputs, processes and represents' (ibid). Similarly, Mitchell suggests investigating beyond the interface and reception of software, 'to interrogate machine architecture', to examine the inscription of the computation (Mitchell, 2010, p. 26). This is how he might think CCS is a material approach that examines the deep structure and invisible machinic layer of software. Software, as Mackenzie notes, 'as a material with specificities, singularities, traits and modes of existence has been displaced by software as mundane application, as infrastructural element in a wider social or technological change' (Mackenzie, 2006, p. 2). As such, reading code implies more than a technical examination but interprets socio-technical relations to the wider domain of software culture. *Pupufu* software uses various social technology and program interfaces, which allow data translates and distributes from various networks to the gallery site. In addition to the study of code, the semi-structured dialogues via face-to-face and electronic medium help understand Lin's code and the related social technology comprehensively. Reading *Pupufu's* source code involves investigation of social traces that have been left in the code, indicating the artist's thinking and decision-making processes that have shaped and created the work of art.

Arguably, many programmers might forget what they have written and what they have tested during their development processes. CCS gives us both a context for inquiry and a source for tracing as a departure point for examining social relations. By using critical code studies, I aim to tackle the

following specific questions: What possible traces of sociality have been inscribed in the code? How might we understand the socio-interaction of the network through the materiality of code?

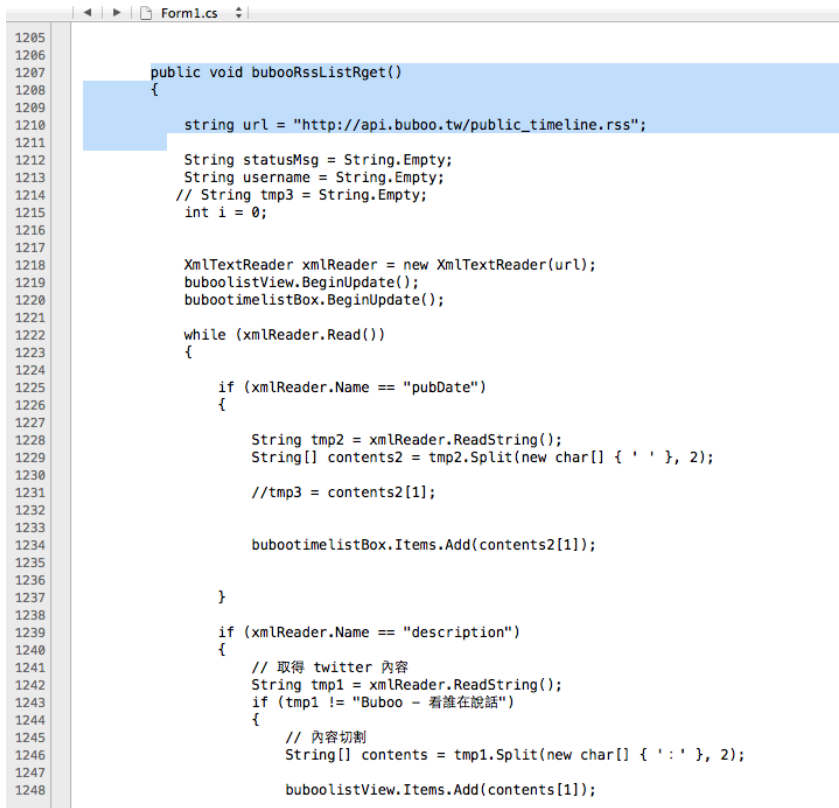
Processing social relations

Social Media Relations

Since 2009, *Pupufu* has been updated with different versions to cope with the technology and changes in social media platforms. Before the official launch of *Pupufu*, it included other social media platform called Buboo. However, due to massive advertising messages from Buboo, Lin preferred to exclude it. But the trace can still be found in the code (see figure 1) since the program function of Buboo is still present in a human readable format, whereby the machine does not execute it. Although the data retrieving function of Buboo still appears in the source code, the machine does not run this particular block of code. The network relations between *Pupufu* and various social media platforms are fragile and unstable but these heterogeneous relations include different agents. Latour uses the useful term actants to describe various human and nonhuman entities (1994; 2004), and in the case of *Pupufu* the term applies to the artist's concept, program code, Internet media and machine. What the code does literally is to establish a connection with network media, retrieving and translating data. This network is comprised of human and nonhuman actants that constantly evolve over time. It is not only programmed technically, but also incurs a social dimension. Therefore, these heterogeneous relations reshuffle the inclusion of social media platforms.

The initial launched version consisted of MSN and Twitter but since Microsoft announced in 2012 that MSN messenger would no longer be available by March 2013 and it was suggested that existing MSN should switch over to Skype which was bought by Microsoft in 2011. In fact, this kind of business acquisition is fairly common in the realm of Internet technology and ecology. Furthermore, the popularity of social media applications has shifted quite a lot. Most social media platforms are hardly able to maintain their users active over time and across locations. The discontinuation or replacement of Internet technology is frequent and continues to be volatile since each product has its own life cycle. The dynamics of the social has forced Lin to reconsider the handling and features of *Pupufu* in subsequent software versions. Thus, the latest version only retains the Facebook connection in *Pupufu* whilst the others, namely MSN

The materiality of code: Towards an understanding of social-technical relations and Twitter, have been removed. Does technology help shape the decision and does it enter a process of co-evolving with humans (Latour 1992, p. 151)? By expanding the thinking beyond technical considerations, the selected artist's option involves 'a range of social factors' which shapes the artwork (Williams and Edge, 1996, p.866). As such, the relationship between things falls under complex socio-technical forces.



```
1205
1206
1207     public void bubooRssListRget()
1208     {
1209
1210         string url = "http://api.buboo.tw/public_timeline.rss";
1211
1212         String statusMsg = String.Empty;
1213         String username = String.Empty;
1214         // String tmp3 = String.Empty;
1215         int i = 0;
1216
1217
1218         XmlTextReader xmlReader = new XmlTextReader(url);
1219         buboolistView.BeginUpdate();
1220         bubootimelistBox.BeginUpdate();
1221
1222         while (xmlReader.Read())
1223         {
1224
1225             if (xmlReader.Name == "pubDate")
1226             {
1227
1228                 String tmp2 = xmlReader.ReadString();
1229                 String[] contents2 = tmp2.Split(new char[] { ' ' }, 2);
1230
1231                 //tmp3 = contents2[1];
1232
1233                 bubootimelistBox.Items.Add(contents2[1]);
1234
1235             }
1236
1237
1238             if (xmlReader.Name == "description")
1239             {
1240                 // 取得 twitter 內容
1241                 String tmp1 = xmlReader.ReadString();
1242                 if (tmp1 != "Buboo - 看誰在說話")
1243                 {
1244                     // 內容切割
1245                     String[] contents = tmp1.Split(new char[] { ' ' }, 2);
1246
1247                     buboolistView.Items.Add(contents[1]);
1248
1249                 }
1250             }
1251         }
1252     }
1253 }
```

Figure 2 *Pupufu* source code, the presence of *Buboo*.

The dynamics of the Twitter's API

In the following section, I will discuss the forces of Twitter API. It is one of the important technical objects not only in the examined version of *Pupufu*, but also in other software that utilize API to retrieve data. Application Programming Interface (API) is one of the important Web 2.0 services offered by many service providers (Fuller and Cramer, 2008, p. 151).

An API is 'an interface where external programs are permitted to establish *access* connections simultaneously, retrieving data with pre-defined structure and parameters' (Pritchard and Soon, in press). This interface allows a connection to be established, data processing takes place over a network, and communicates across various hardware and software platforms through computer code. Individuals, developers or artists make use of APIs to access, replicate and re-represent data in diverse forms through applications and even art representations. Scholars, practitioners and artists have argued that API is a data maker (Vis, 2013), quasi-object (Bucher, 2012), art object (Thorp cited in Lane, 2013) and an art-making enabler (Soon, 2011). These discussions have indicated that API does not merely exist with operational and technological research value, but also provides a cultural, artistic and sociological contribution to the academic and industry sectors. Bucher investigates web APIs through an empirical study that is 'an account of the specificity of APIs in terms of its sociomateriality' (2013). She argues that API is not a neutral object and that it asserts 'enactive power' to what kinds of applications are to be imagined and developed through the entire governing strategies of Twitter in her specific case study on the platform (ibid). In this article, I am concerned with the constitution of *Pupufu* as an artwork or an application, not simply the participation of humans – the artist-programmer, Internet users or on-site audiences, but the participation of nonhumans through socio-technical dimensions. API is one of the socio-objects and actants, also in the form of code, which perpetually shape how the artwork performs.

In 2008-2009, Lin had also used the Twitter API to harvest real time data of users that were tweeting within 100 kilometre of Taipei. This parameter (refer to fig 3) was set in order to limit the messages that enter into the gallery, making the scope of it more relevant to the exhibition context and closer to the visitors who interact with the pseudo-organisms on site. As Lane suggests, the API has to interpret from an emotional and expressive representation (Lane, 2013), thus the API comes with more than factual data. Lane then argues, 'API was designed by another application and not a human', considering other painting artworks that have used the parameters of materials such as stroke weight and specific design elements (ibid). In the artwork of *Pupufu*, the Twitter API also comes with its parameters and characteristics. Lin did not plan to include a locative parameter during his initial design stage, but after he found out that this feature was available, he used it in *Pupufu*. He said the configurable API helps to present the artwork with a more immersive experience to audiences.

```
private void autoTwitterload() {  
    //string url = "http://twitter.com/statuses/public_timeline.atom";  
    string url = "http://search.twitter.com/search.atom?geocode=23.69781,120.960515," + twitterkm.Text + "&q=++RT+&near:Taiwan+within:" + twi  
    String statusMsg = String.Empty;  
    String username = String.Empty;  
  
    int i = 0;  
    int j = 0;  
    XmlTextReader xmlReader = new XmlTextReader(url);  
    XmlTextReader xmlReader = new XmlTextReader(url);  
    TwitterimListBox.BeginUpdate();  
    TwitterimListBox.BeginUpdate();  
    while (xmlReader.Read())
```

Figure 3 *Pupufu* source code- the use of Twitter API and the geocode parameter.

In fact, Lin expresses the difficulties of coping with the ever-changing aspect of the Twitter API. The developer communities who use web APIs have complained about this issue continuously. I have discussed this in a recent article that focuses on the lifespan of an application that uses another social media platform (Soon, 2014). Escaping the use of web API is possible but Lin has chosen to remove Twitter entirely from the version of *Pupufu* from 2013 onwards. This is one of the reasons that Twitter is not that popular when compared with Facebook in Taiwan; the other reason is the instability and dynamic changes of the Twitter web API. Lin is aware that he has less control by using API, for instance when it comes to the rules, logging, monitoring and authentication required by Twitter in its major API version 1.1 release (Twitter, 2012). As Puschmann puts it, '[p]latform providers and users are in a constant state of negotiation regarding access to and control over information' (2013, p. 2). He also points out that these 'specific services and placing controls on third-party developers who wish to exploit the platforms or contribute applications which are not in accordance with the strategic aims of the platform providers' might cause problems for those using the API (Puschmann, p. 3). In other words, Twitter is controlling what should be available in the market through the API object. One has to understand APIs in a different way that go beyond technical functionalities. It could be understood as 'a control apparatus' that constantly monitor the behavior of the network connection (Soon, 2013); and its specification intrinsically incorporate power to control the activity of third-party social software.

Lin was fully aware that the frequent change of the Twitter API specification means that his program has to be updated from time to time. This is fundamentally the reason for not including it in the latest version of *Pupufu*.

Open source and social culture

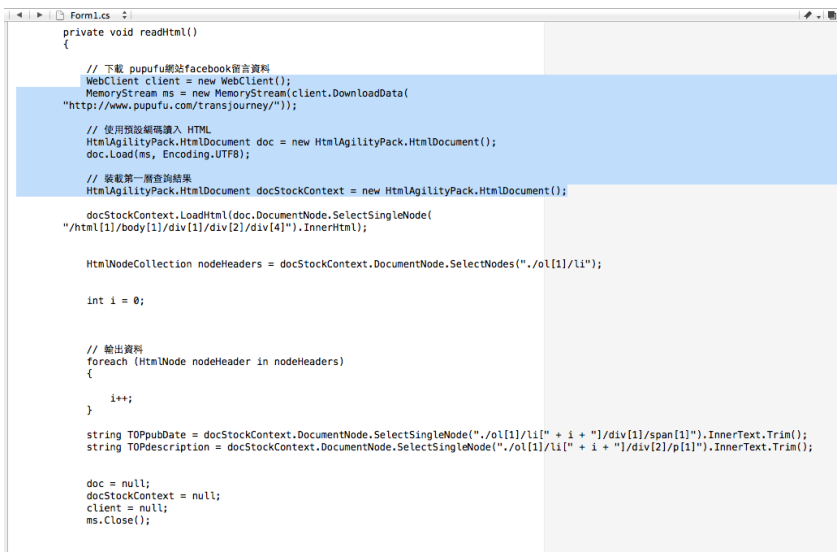
Instead of relying on the web API entirely, Lin uses an external library HTML Agility Pack to parse required Facebook data from a specific user

account. The act of parsing is a process of programmable screen scraping, extracting data that is represented on the web. Using this approach, *Pupufu* does not directly need to query Facebook's specific data fields and data sets. It only hosts a separate web page that isolates specific account of Facebook posts. *Pupufu* will then parse the whole web page, and is then able to process, obtain and filter the specific data to trigger the movement of the pseudo-organisms.

The HTML Agility Pack is simply designed to read and write an HTML document. Having a specific data schematics and structures in an HTML document, the HTML Agility Pack can easily locate a particular piece of data. It is a free and open source library developed by independent developers that is unlike closed system. The source code is available to all Internet users and there is a huge community, which provides support to one another through a discussion forum online. The notion of the open source format is being entangled with social relations in a collective and open form. The free sharing of software development is made possible via the socialization of public contributions, such as debugging, suggesting improvements and helping each other to code with the HTML Agility Pack. In contrast to the closed nature of proprietary software, open source 'is arguably more reliable, stable and less bug-ridden, as a result of peer review and collective development' (Cox, 2010, p. 125). The peer-reviewed process of the HTML Agility Pack is arguably a driving force for the software's development excellence. As Mackenzie puts it, 'code objects demonstrate that operability depends on the constitution of collective agency' (2005, p. 88). With each iteration, the software release is no longer a mere technical or economic matter. This operability of software, as Mackenzie describes it, is performative as it 'realize[s] specific social actions' through 'production, circulation and consumption of information'(ibid). Collective labour shapes how the software functions and is used, but not the other way round. Hence, the socio-political of software is flipped towards a relatively decentralized co-production. Cox reminds us that, open source culture involves 'creative labour' which is different from the usual notion of labour that is paid and often tied with a centralized and commercial institution for profit making (2010, p. 133). The relationship between producers and consumers is increasingly blurred and the reward is hardly reduced to a monetary term that exists in a capitalist market. At least, the model for open source community is different from the privatized market because it does not exploit 'users' personal data for profit' (Ippolita and Mancinelli, 2013, p.

160). As such, controlling how the data is being used and hence shaping the developers' community is not the drive for the open source community.

To Lin, the HTML Agility Pack is compatible with the *Pupufu* program that is written in a C# programming language, hence, less customization and handshaking is required between the two programs (Facebook and *Pupufu*). Indeed, I would argue this conscious and unconscious action, the use of the HTML Agility Pack, comes with complex social relations within the open source community. As Latour explains, '[a]ction is not done under the full control of consciousness; action should rather be felt as a node, a knot, and a conglomerate of many surprising sets of agencies' (2005, p. 44). Although Lin does not explain and articulate the choices and actions in details, the open and close social relations and their actants do have an impact on the software behaviour and on *Pupufu*. The uses of the HTML Agility Pack as the parsing tool remains in *Pupufu* until now, and Facebook is the only social media connection that appears in the artwork since 2013.



```
private void readHtml()
{
    // 下載 pupufu網站facebook留言資料
    WebClient client = new WebClient();
    MemoryStream ms = new MemoryStream(client.DownloadData(
        "http://www.pupufu.com/transjourney/"));

    // 使用預設編碼讀入 HTML
    HtmlAgilityPack.HtmlDocument doc = new HtmlAgilityPack.HtmlDocument();
    doc.Load(ms, Encoding.UTF8);

    // 裝載第一條查詢結果
    HtmlAgilityPack.HtmlDocument docStockContext = new HtmlAgilityPack.HtmlDocument();

    docStockContext.LoadHtml(doc.DocumentNode.SelectSingleNode(
        "/html[1]/body[1]/div[1]/div[2]/div[4]").InnerText);

    HtmlNodeCollection nodeHeaders = docStockContext.DocumentNode.SelectNodes("/ol[1]/li[*]");

    int i = 0;

    // 輸出資料
    foreach (HtmlNode nodeHeader in nodeHeaders)
    {
        i++;
    }

    string TOPpubDate = docStockContext.DocumentNode.SelectSingleNode("/ol[1]/li[" + i + "]/div[1]/span[1]").InnerText.Trim();
    string TOPDescription = docStockContext.DocumentNode.SelectSingleNode("/ol[1]/li[" + i + "]/div[2]/p[1]").InnerText.Trim();

    doc = null;
    docStockContext = null;
    client = null;
    ms.Close();
}
```

Figure 4 *Pupufu* source code, the use of the HTMLAgilityPack parser.

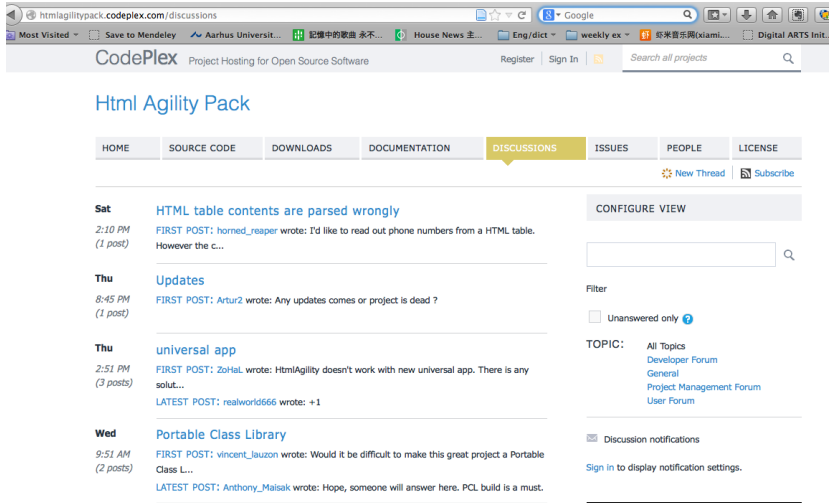


Figure 5 The discussion community forum of the HTML Agility Pack.

The concept and significance of code

Artists who use real time technology, third-party libraries, engines, plugins and APIs to program software are fairly common in the art scene, in particular in what concerns software art, network art, media art and games art. Technology is intertwined with network art. As Weibei and Druckrey describe network art is an art form not only about artistic expression, but also addresses the '[network] condition'. 'It focuses on the social conditions forced into existence by the [network], while at the same time exploring conditions that the [network] itself imposes on society' (1999, p. 14) In other words, network artworks inscribe with social conditions that express in the form of code running, interfacing with other network parameters. The current circulation of digital information almost certainly requires network and software. The net is comprised of software and data, and software requires running different lines of program code in order to perform and materialize. The perpetual and continuous reading and writing of code is always taking place in the network as the network is happening. This action of reading and writing is performative and goes beyond linguistic or syntax analysis of technical code writing. Cox draws on Austin's 'Speech Act Theory' and Butler's *Excitable Speech* to discuss how the running of code performs actions (2013). However, these actions cannot be fully recognized or made visible in the utterance. The notion of the dynamics of the network and its

social forces might be inscribed in the computer code. Following up the problem that raised by Berry, the lack of software understanding is the issue to uncover as we now live in 'softwarized society' (Berry, 2013, p. 55); our lives increasingly engage with software and algorithms, so how well are we able to understand the social that has been inscribed in code? Berry further reminds us that, 'we have to take account of the fact that the internal structures that enable things to become softwarized are complex and structured' (ibid, p. 57), but then how do we move beyond the technical study of code?

What I have discussed so far is the instantiation with computer code of an artwork. Through the analysis of the artwork *Pupufu*, I trace another layer of code in order to understand its social relations. The use of different data processing methods in computer code, for instance API and library, allows me to further trace and interpret social relations with a socio-technical dimension through a semiotic-interpretative approach of code reading. As such, the notion of code includes more than computer-readable code, it includes things that are not computer-readable but human-readable. Some examples of this are: the block of computer code that has not been run by the software; the technical specification of how Twitter's API works; and the open source community platform that documents all the release notes, discussion dialogues and source code. Studying all these relations from the perspective of software studies is crucial 'in developing our understanding of contemporary society, political economy and aesthetics, as software mediation has reached a point at which it is at *saturation levels*' (Berry, 2013, p. 55, *Italic in original*). We might also be able to understand art, society and aesthetics beyond the study of an artwork' interface and reception.

Conclusion

A number of earlier studies have indicated the relationship and importance between software and the social (Fuller, 2003; Chun, 2011; Bucher, 2012; Manovich, 2013; Berry, 2013). It is essential that media and cultural studies pay attention to software. Manovich warns that there are dangers if we only examine the effects of software but not the cause: 'the output that appears on a computer screen rather than the programs and social cultures that produce these outputs' (2013, p. 9). This is also true for the study of art, in particular software and network art inasmuch as artworks reveal the net or social conditions. What I have addressed in this paper relates to the social process of technology, in particular where code is

concerned. However, thinking of code through only an output is not enough. Here, I suggest tracing sociality through the close reading of code as a departure point. This is a pragmatic way, as I demonstrate here, to understand network environments in a specific context. The method might also apply in the context of STS in examining wider implications of software culture. If one considers the materiality of code, including the technical aspects that have been inscribed with social perspectives, then the focus shifts from a code object to the things surround an object that are, indeed, human and nonhuman, material and immaterial.

Acknowledgement

Thank you to the artist Lin Shuh-Chang for providing the materials of Pupufu and for taking the time to discuss the work with me. Also thanks are due to Tao Ya Lun and Taipei National University of the Arts for hosting me as a visiting researcher. I am also thankful to my supervisors Geoff Cox, Christian Ulrik Andersen and Jane Prophet. Thanks to Maureen Eastwood, Polly Poon and Ana Bê Pereira for reading an earlier draft.

References

- Andersen, C.U. and Pold, S.B. (2011) *Interface Criticism: Aesthetics Beyond the Buttons*. Aarhus: Aarhus University Press.
- Berry, D.M. (2013) *Critical Theory and the Digital*. New York: Bloomsbury.
- Bucher, T. (2012) *Programmed sociality: A software studies perspective on social networking sites*. Doctoral dissertation, University of Oslo.
- Bucher, T. (2013) Objects of intense feeling: The case of the Twitter APIs. [online] *Computational Culture*, 3. Available from: <http://computationalculture.net/article/objects-of-intense-feeling-the-case-of-the-twitter-api>. [Accessed: 30th December 2014].
- Chun, W.H.K. (2011) *Programmed visions: Software and memory*. Cambridge: MIT Press.
- Cox, G. (2010) *Antithesis: the Dialectics of Software Art*. Plymouth: University of Plymouth.
- Cox, G. (2013) *Speaking Code: Coding as Aesthetic and Political Expression*. Cambridge: MIT Press.
- Fuller, M. (2003). *Behind the blip: Essays on the Culture of Software*. New York: Autonomedia.
- Fuller, M., & Cramer, F. (2008). Interface. In: Fuller, M. (ed.). *Software Studies*. MIT Press.

- Ippolita and Mancinelli, T. (2013) *The Facebook Aquarium: Freedom in a profile*. In Lovink, G. and Rasch, M. (eds), *Unlike us reader: social media monopolies and their alternatives*. Institute of Network Cultures.
- Lane, K. (2013) *APIs as Art*. [Online]. Available from: <http://apievangelist.com/2013/03/19/apis-as-art/>. [Accessed: 4th May 2014].
- Latour, B. (1992) *Where Are the Missing Masses? The Sociology of a Few Mundane Artifacts*. In Bijker, W. and Law, J. (eds.), *Shaping Technology-Building Society. Studies in Sociotechnical Change*. Cambridge: MIT Press.
- Latour, B. (1993) *We have never been modern*. Cambridge: Harvard University Press.
- Latour, B. (1994) On technical mediation. *Common knowledge*, 3 (2), 29-64.
- Latour, B. (2004) *Politics of Nature: How to Bring the Sciences into Democracy*. Cambridge: Harvard University Press.
- Latour, B. (2005) *Reassembling the Social*. Oxford: Oxford University Press.
- Lin, S.C. (2009) 匍匍匍 Pupufu. *Installation*. [Online Video]. Available from: <https://vimeo.com/6891295>. [Accessed: 4th May 2014].
- Mackenzie, A. (2005) The Performativity of Code Software and Cultures of Circulation. *Theory, Culture & Society*, 22 (1), 71-92.
- Mackenzie, A. (2006) *Cutting Code: Software and Sociality*. New York: Peter Lang International Academic Publishers.
- Manovich, L. (2013) *Software takes command*. London: Bloomsbury Academic.
- Marino, M.C. (2006) Critical Code Studies. *Electronic Book Review*. Electropoetics. [Online] Available from: <http://www.electronicbookreview.com/thread/electropoetics/codology>. [Accessed: 4th May 2014].
- Mcperson, T. (2006) *Reload: Liveness, Mobility, and the Web*. In Chun, W.H.K. and Keenan, T. (eds.), *New media, old media : A History and Theory Reader*. Oxford: Routledge.
- Mitchell, C. (2010) Translation and Materiality: The Paradox of Visible Translation. *Spectator*, 30 (1), 23-29.
- Pritchard, H. and Soon, W. (Forthcoming) 'Performativity of 'Jsut Code'. *Leonardo Electronic Almanac*.
- Puschmann, C. and Burgess, J. (2013) *The politics of Twitter data*. [Online] Available from: <http://eprints.qut.edu.au/56737/>. [Accessed: 4th May 2014].
- Soon, W. (2011) The Public Interface as an Art-Making enabler. *Parsons Journal For Infomation Mapping*, 3 (4), 1-7.

- Soon, W. (2014) Post-digital approach: Rethinking Digital Liveness in 'The Likes of Brother Cream Cat'. *A Peer-reviewed Journal About*, 3(1). [Online] Available from: <http://www.aprja.net/?p=1814>. [Accessed: 4th May 2014].
- Twitter. (2012) *Changes coming in Version 1.1 of the Twitter API*. [Online] 16th August 2012. Available from: Twitter Blogs <https://blog.twitter.com/2012/changes-coming-to-twitter-api>. [Accessed: 4th May 2014].
- Vis, F. (2013) A critical reflection on Big Data: Considering APIs, researchers and tools as data makers. *First Monday*, 18 (10).
- Weibel, P. and Druckrey, T. (eds.) (2001) *net_condition: art and global media*. Cambridge: MIT Press.
- Williams, R. and Edge, D. (1996). The social shaping of technology. *Research policy*, 25 (6), 865-899.

Digital literacy e disuguaglianze tra i giovani: oltre le metafore semplificatorie

Simona TIROCCHI*

Università di Torino

Questo articolo si propone di analizzare il rapporto tra giovani e digital literacy con l'obiettivo di evidenziarne e discuterne la complessità, alla luce della riformulazione del problema del digital divide e della parziale fragilità euristica del concetto di 'nativi digitali'. La disamina di alcuni contributi internazionali su questi temi, rivela un'eterogeneità di risultati che da un lato conferma la necessità di ridefinire il problema delle disuguaglianze digitali andando oltre la questione dell'accesso, dall'altro tende a ridimensionare la celebrata capacità delle giovani generazioni di rapportarsi in modo complesso e sofisticato ai pc, alla Rete e ai device più recenti. Anche i dati sull'uso delle nuove tecnologie pubblicati dall'Istat nel 2013 confermano il possesso, da parte delle coorti giovanili, di competenze digitali di natura prevalentemente operativa. Nella sua parte conclusiva, il contributo analizza il concetto di media literacy, con una prospettiva rivolta all'ampio tema dell'educazione e dei processi formativi, offrendo una riflessione sulle policies da attuare e implementare in futuro al fine di garantire una diffusione sempre più ampia e omogenea delle cosiddette digital skills.

Keywords: Digital literacy; disuguaglianze digitali; nativi digitali; competenze digitali

Introduzione: dal digital divide alle digital skills

Il tema delle disuguaglianze digitali costituisce un classico della riflessione sugli effetti sociali dei media (Wolf, 1992; Bentivegna, 2003; Stella, 2012), soprattutto da quando nelle nostre organizzazioni sociali l'accesso alle informazioni, anche a quelle diffuse in rete, è diventato fondamentale per la partecipazione produttiva e consapevole alla vita pubblica, ma anche, più semplicemente, per la gestione di numerosi aspetti della vita quotidiana.

* Corresponding author: **Simona Tirocchi** | e-mail: simona.tirocchi@unito.it

L'importanza strategica delle risorse informative è cresciuta in maniera esponenziale soprattutto con la diffusione di Internet, rivelando la sua centralità per il miglioramento del benessere e della qualità della vita, ma ancor prima per l'ingresso nel mondo del lavoro e l'avanzamento professionale. Allo stesso tempo, però, è emersa immediatamente la difficoltà di garantire un eguale accesso di tutti i cittadini alle risorse informative messe a disposizione dalla Rete, poiché le disuguaglianze digitali hanno spesso finito per riflettere le differenze strutturalmente presenti nei contesti sociali, resi ancora più instabili e frammentari dall'accelerazione del mutamento e dall'impatto dei processi di globalizzazione.

Le radici di quello che in letteratura, fino a qualche tempo fa, era definito 'digital divide' risalgono alla formulazione dell'ipotesi comunicativa degli scarti di conoscenza (Tichenor, Donohue and Olien, 1970), secondo la quale il consumo mediale contribuirebbe ad aumentare anziché a colmare i gap tra chi possiede le informazioni e chi, al contrario, si trova escluso dal flusso informativo a causa di disparità economiche o socioculturali. Tale ipotesi è confluita nel più ampio tema del digital divide, successivamente caratterizzato da una focalizzazione dell'attenzione sull'inclusione digitale (Warschauer, 2003) e dal riconoscimento di una stratificazione delle disuguaglianze anche nell'uso (*digital inequalities*), legata sempre più a fattori come la dotazione tecnica, le capacità cognitive, le reti sociali disponibili, la varietà e l'esperienza in rete (Hargittai, 2002; Livingstone, Helsper, 2007; Bentivegna, 2009). Così, da un'iniziale formulazione basata sull'esistenza di una netta dicotomia tra *information haves* e *information have nots*, fondata esclusivamente sulla dimensione 'fisica' dell'accesso, il problema del digital divide è stato affrontato facendo ricorso a modelli di spiegazione multidimensionali, che mostrano l'incidenza, anche congiunta, di più variabili, di natura sociale, psicologica e culturale. Numerose ricerche hanno dimostrato, inoltre, che mentre i gap basati sull'accesso hanno una qualche possibilità di essere colmati (attraverso l'avvicinamento progressivo delle categorie più 'svantaggiate' ai soggetti più equipaggiati), altri divari sembrano invece aumentare (Gallina, 2010), specialmente quando spostiamo l'attenzione sul concetto di competenza digitale: le differenze riferite alle competenze sono, infatti, un aspetto rilevante di quello che è stato definito *second-level digital divide* (Hargittai, 2002).

Secondo la Raccomandazione del Parlamento Europeo e del Consiglio del 18 dicembre 2006 relativa a competenze chiave per l'apprendimento permanente 'La competenza digitale consiste nel saper utilizzare con dimestichezza e spirito critico le tecnologie della società dell'informazione

(TSI) per il lavoro, il tempo libero e la comunicazione. Essa è supportata da abilità di base nelle TIC: l'uso del computer per reperire, valutare, conservare, produrre, presentare e scambiare informazioni nonché per comunicare e partecipare a reti collaborative tramite Internet' (Commissione Europea, 2006).

Van Deursen e van Dijck (2010), propongono, come strumento di classificazione, un range di *internet skills* che va da un livello base sino ai livelli più complessi:

- *competenze digitali operative*: si riferiscono a un set di competenze che definisce l'uso della rete a un livello base;
- *competenze digitali formali*: hanno a che fare con la struttura ipermediale di Internet che richiede abilità di navigazione e orientamento;
- *competenze digitali informazionali*: riguardano le azioni che l'utente svolge per rispondere ai suoi bisogni informativi;
- *competenze digitali strategiche*: si riferiscono alla capacità di usare Internet come mezzo per raggiungere particolari scopi e comunque al fine di migliorare la propria posizione nella società.

Come ha recentemente osservato Hsieh (2012), le competenze digitali dovrebbero essere considerate un concetto teorico 'in progressione', implementabile con il tempo, includendo anche quelle riferite ai nuovi dispositivi di comunicazione, nel momento in cui questi ultimi si apprestano a entrare nell'uso quotidiano di strati sempre più ampi della popolazione. A fronte dell'impiego sempre più diffuso delle piattaforme web per il social networking (l'universo tecnologico che ruota intorno ai social media e al cosiddetto web 2.0), l'autore propone di introdurre il concetto di *online social networking skills* ponendolo in relazione con l'uso delle ICT orientato all'interazione sociale: 'online social networking skills can be defined as the ability and knowledge of how to use ICTs, specifically for social interaction' (Hsieh, 2012). Questa definizione è particolarmente utile, proprio perché permette di cogliere una trasformazione fondamentale delle pratiche comunicative dei giovani, sempre più protesi verso i social network sites e, ancora più recentemente, verso le piattaforme di messaggia istantanea, come *Whatsapp*, con una chiara propensione a valorizzare l'aspetto sociale e relazionale delle tecnologie utilizzate.

Oltre la metafora dei nativi digitali

Con riferimento al tema delle disuguaglianze digitali, la variabile 'età' è stata spesso chiamata in causa per spiegare la maggiore abilità dei giovani di padroneggiare gli strumenti che caratterizzano il nuovo panorama comunicativo, contrassegnato dal dominio dei network e dell'informazione come assi portanti della società (Castells, 2002) e dalla sempre più ampia partecipazione dei pubblici alla rielaborazione e diffusione dei contenuti mediali (Jenkins, 2006; Jenkins et al., 2013). Quella dei digital natives, in particolare, è un'etichetta definitoria largamente diffusa nella letteratura scientifica (anche nelle scienze della comunicazione e dell'educazione, nostro specifico campo di analisi) e nella pubblicistica internazionale, ma il cui significato richiede di essere approfondito, soprattutto con riferimento ai riscontri empirici disponibili. Secondo questa definizione, i giovani (inizialmente si parlava di soggetti nati a partire dagli anni '80, oggi si fa riferimento a bambini e ragazzi nati nei decenni successivi) costituirebbero un gruppo sociale caratterizzato da un rapporto particolarmente sofisticato e avveduto con le tecnologie di ultima generazione, che si assocerebbe anche a un cambiamento degli stili di apprendimento, per il solo fatto di essere nati e cresciuti in un 'ambiente digitale'. Questa prospettiva di analisi dei giovani è il prodotto e l'espressione di una corrente culturale che ha tradizionalmente attribuito a questi soggetti sociali una capacità quasi endemica e 'naturale' di gestione delle tecnologie, secondo quella che David Buckingham (2004) definisce *nuova retorica generazionale*: dai nativi digitali di Marc Prensky (2001; 2009), alla Net Generation di Don Tapscott (2011), sino ai New Millenium Learners (OECD, 2009), soltanto per citare alcune definizioni. Giovani i cui cervelli si sarebbero sviluppati in modo diverso rispetto a quelli degli adulti e che dunque avrebbero assunto un differente atteggiamento nei confronti delle tecnologie digitali e dell'apprendimento.

Il determinismo tecnologico di Prensky, che confida nella capacità performativa e potenziante delle tecnologie digitali, in grado addirittura di renderci più 'saggi' (non a caso l'autore parla di '*digital wisdom*', saggezza digitale), si è scontrato, negli ultimi anni, con una serie di osservazioni e prove empiriche che hanno messo in seria difficoltà la credibilità ed estensibilità della sua affascinante teoria.

In primo luogo, l'individuazione temporale specifica dei nativi è piuttosto controversa, nel senso che non è possibile stabilire con certezza chi siano oggi i cosiddetti 'nativi digitali' o fino a che età si possa parlare di soggetti che condividono queste caratteristiche (Ferri, 2011). L'aumento delle applicazioni web 2.0 potrebbe aver creato una seconda generazione di nativi

distinguibile dalla prima grazie alla sua particolare familiarità con questo mondo digitale 'di seconda generazione'.

In secondo luogo, i giovani 'non sono tutti uguali', concetto che ricorre più volte nelle critiche alla teoria. In un intervento pubblicato nel suo blog ufficiale 'Confessions of an Aca Fan' (Jenkins, 2007), Henry Jenkins osserva come i nativi digitali condividano una comune cultura globale che non è definita esclusivamente dall'età, ma da attributi ed esperienze che hanno a che fare con il modo di interagire e di rapportarsi al mondo esterno. Inoltre il 'guru' fa osservare come esistano ambienti (la rete o alcuni spazi della rete) in cui adulti e giovani possono interagire in modo paritario attraverso un processo di apprendimento reciproco.

In terzo luogo, la critica si fonda sullo scardinamento della cosiddetta 'neuromitologia' dei nativi digitali (Rivoltella, 2012): si mette in dubbio l'idea che il funzionamento cerebrale dei nativi sia diverso da quello dei non nativi. Nel replicare a chi sostiene l'ipotesi dei nativi digitali, Rivoltella utilizza tre tipi di argomentazioni, riconducibili ad altrettanti approcci: la ricerca educativa, la sociologia della conoscenza, l'approccio neuroscientifico. In merito al primo tipo di spiegazione, utilizzando il lavoro di Bennet, Maton e Kervin (2008), l'autore osserva come possano essere messi in discussione i due assunti che sostengono che una generazione di nativi digitali esista e che l'educazione debba cambiare per venire incontro ai loro bisogni.

Dal punto di vista della sociologia della conoscenza, il costruito sociale dei 'nativi' sarebbe portatore di particolari valori e comportamenti che ne farebbero oggetto di costante attenzione da parte del sistema mediale. Quest'ultimo, ponendo spesso i nativi al centro dei suoi discorsi sociali, contribuirebbe a una riduzione e semplificazione della complessità del reale (un tema che viene, quindi, ripetuto e che porta a situazioni di panico morale).

Sebbene, dunque, questa etichetta definitoria si sia rivelata utile per marcare una differenza generazionale, essa non ha mostrato di possedere altrettanta forza esplicativa per decretare una maggiore capacità di accesso e d'uso delle tecnologie digitali.

La debolezza della metafora dei nativi digitali è in parte confermata dalle evidenze empiriche disponibili in una serie di studi condotti in differenti contesti geografici, con il coinvolgimento di differenti tipologie di campioni. Si tratta generalmente di studi statistici, dunque di carattere quantitativo, in forma di *survey*, oppure di test in cui ai soggetti si chiede di svolgere alcuni compiti (*tasks*) relativi all'uso del pc o, più specificamente, alla navigazione in rete.

Nonostante l'eterogeneità degli approcci proposti, si tratta di contributi che evidenziano comunque l'esistenza di numerose sfumature all'interno del target apparentemente omogeneo dei nativi e che molto spesso sembrano ridimensionare le decantate abilità e performance delle giovani generazioni rispetto ai cosiddetti 'immigrati digitali'.

Alcuni di questi studi sono stati condotti all'interno di contesti universitari. La ricerca di Thinyane (2010) riguarda più di 290 studenti del primo anno iscritti in due università del Sud Africa. Lo studio descrive le modalità di accesso e uso delle tecnologie da parte dei ragazzi, rivelando una popolazione piuttosto eterogenea, con diversi livelli di relazione con la maggior parte dei dispositivi considerati. Il risultato più rilevante è che i partecipanti alla ricerca non utilizzano tutti i device e soprattutto che non sembrano interessati a usarli nell'ambito delle loro attività di studio.

Lo strumento che registra i più alti livelli accesso (98,1%), ma anche d'uso, è il telefono cellulare, menzionato più spesso degli altri media quando si fa riferimento all'uso per motivi di studio.

Quest'indagine è stata oggetto di comparazione con una ricerca condotta da Kennedy et. al. (2008) che aveva dimostrato l'esistenza di differenze tra gli studenti che dipendevano dal loro background, ma anche dall'appartenenza a paesi sviluppati piuttosto che ad aree in via di sviluppo.

Il contributo di Margaryan et. al. (2011), indaga l'uso delle tecnologie digitali per l'apprendimento e la socializzazione da parte di un campione di studenti universitari britannici. Anche in questo caso l'uso di *tools* per l'apprendimento collaborativo, di ambienti virtuali e di social network sites è limitato: non sembra, cioè, che gli studenti tendano ad adottare stili di apprendimento radicalmente diversi da quelli degli adulti e quindi, ancora una volta, i dati sembrano deludere le aspettative rispetto alla conferma dell'ipotesi dei nativi digitali.

Andando oltre le ricerche in contesti universitari, ma rivolgendosi a un campione differenziato, Helsper ed Eynon (2009) criticano una concezione dei digital natives che sia basata puramente sulle differenze generazionali: il paper propone un certo numero di 'attività digitali' che denotano la condizione di 'nativo' per poi esaminare le tipologie di soggetti più propense a mostrare queste caratteristiche. Più importanti dell'età, sono l'ampiezza d'uso, l'esperienza, la self-efficacy e l'istruzione.

Questo lavoro fornisce dati sull'accesso e l'uso di internet e di altre nuove tecnologie da parte della popolazione britannica, sulla base di un'inchiesta rappresentativa a livello nazionale centrata su interviste faccia a faccia (the Oxford Internet Surveys), individuando le dimensioni che

potrebbero definire i nativi: età (chi è nato nell'era della tecnologia); esperienza (coloro che sono stati su Internet per il più lungo periodo di tempo o l'ampiezza d'uso - coloro per i quali Internet è integrato quasi in ogni aspetto della loro vita quotidiana, indipendentemente dalla loro età ed esperienza).

Per 'esperienza' si intende il numero di anni di trascorsi dal primo accesso a Internet, mentre l' 'ampiezza d'uso' è operazionalizzata come il numero di attività differenti che una persona effettua online, e infine il livello di self-efficacy, cioè la bravura nell'uso di Internet fornisce un indicatore soggettivo di expertise.

Le analisi descrittive dell'OxIS hanno dimostrato che l'ampiezza d'uso e la self-efficacy sono fortemente correlate con l'età, mentre l'esperienza non lo è.

Il paper dimostra, dunque, ancora una volta, che l'appartenenza a una generazione non è una variabile sufficiente a definire la condizione di 'nativo digitale', poiché sono coinvolti numerosi fattori, che vanno dal genere, all'istruzione, all'esperienza, all'ampiezza d'uso. In ogni caso l'immersione in un ambiente digitale tende a essere una variabile determinante per capire se il soggetto agisce da nativo nel rapporto con le tecnologie.

Due studi condotti van Deursen e van Dijk (2010) su due campioni di 109 soggetti della popolazione tedesca hanno dimostrato, che nel quadro di un generale livello di alfabetizzazione che si limita prevalentemente a competenze di gestione del computer di carattere operativo e formale, l'età e il livello di istruzione possono essere fattori che spiegano e favoriscono il possesso di competenze digitali. E se le nuove generazioni (nelle due ricerche rappresentate rispettivamente da 25 e 27 soggetti dai 18 ai 29 anni) vantano buone performance nelle competenze operative e formali, non mostrano gli stessi risultati in quelle informazionali e strategiche.

Nel contesto italiano, Gui e Argentin (2011) presentano un'indagine su un campione casuale di 65 classi del terzo anno di scuola superiore, per un totale di 980 studenti coinvolti. Gli autori osservano come, in accordo con la letteratura di riferimento, il campione ottenga risultati migliori nelle competenze operative, esibendo performance più deboli per quel che riguarda le competenze valutative. Lo *skills divide*, inoltre, sembrerebbe fondarsi su variabili strutturali quali genere e background culturale della famiglia.

Alcuni studi si concentrano, più in particolare, sui nuovi device e sui nuovi ambienti social.

Dopo aver effettuato una ricerca nazionale su 800 adolescenti tra i 12 e i 17 anni e sui loro genitori, Park (2014) rileva l'esistenza di numerose differenze rispetto alle competenze e all'uso anche all'interno di un gruppo di giovani 'fortemente equipaggiati' dal punto di vista della comunicazione *mobile*. Molti divari sono basati sull'etnia e alcune variazioni sono associate allo status socioculturale dei genitori, anche in relazione al possesso di un cellulare personale.

Uno studio condotto da Sanz e Turlea (2012) dimostra, invece, che esiste una forte correlazione tra l'attività di downloading di materiali online e quella di uploading di contenuti originali (*self-created content*) e che dunque l'inclusione digitale, più che alla dimensione dell'accesso, dovrebbe far riferimento a queste dimensioni creative e interattive, tipiche dell'orizzonte della cultura convergente.

Lo studio, realizzato mediante l'elaborazione dei dati di 27 paesi membri dell'Unione Europea, con un approfondimento sul caso specifico della Spagna, ha provato che l'uso di servizi comunicativi avanzati è più diffuso tra i giovani spagnoli, se si confronta il dato con la media dei paesi europei. Inoltre le cifre mostrano come lo status di studente (almeno nelle istituzioni spagnole) non vada necessariamente di pari passo con l'appropriazione della cultura dello sharing online.

La tesi della debolezza concettuale della metafora dei nativi digitali sembrerebbe essere avvalorata anche dai più recenti dati diffusi dall'Istat. L'indagine 'Cittadini e nuove tecnologie' pubblicata dall'Istituto (Istat, 2013), nel quadro di un generale incremento dell'accesso a Internet e ai computer da parte delle famiglie, mostra che i maggiori utilizzatori del personal computer e di Internet restano i giovani tra i 15 e i 19 anni (rispettivamente, oltre l'88% e oltre l'89%).

I giovani tra i 15 e i 24 anni avrebbero competenze superiori alla media nazionale, ma le abilità informatiche cui si fa riferimento sono di natura prevalentemente operativa: copiare o muovere una cartella di lavoro o usare il copia incolla (operazioni che sa effettuare il 94% di questi giovani), trasferire file tra pc e/o da altri dispositivi (oltre l'82%), connettere e installare periferiche (oltre il 68%), effettuare calcoli matematici tramite fogli elettronici (oltre il 65%), comprimere un file (oltre il 55%), creare presentazioni con un apposito software (oltre il 51%). E i dati non cambiano se ci riferiamo alle operazioni effettuate su Internet: si parla al massimo di uso di motori di ricerca, della capacità di spedire e-mail o di postare messaggi in chat. È ovvio che si tratta di dimensioni lontane da quel concetto complesso di competenza digitale che dovrebbe implicare, per

esempio, un uso critico e consapevole delle informazioni reperite, al termine di un percorso di scelta delle fonti altrettanto critico e consapevole o all'interno di un contesto relazionale di condivisione delle informazioni.

Digital literacy: una sfida educative

In che modo è possibile intraprendere un percorso che aiuti a superare le disuguaglianze comunicative che permangono anche tra le giovani generazioni? Siamo di fronte a un problema culturale, che investe la sfera educativa nella sua accezione più ampia: l'istruzione e dunque il mondo della scuola, ma anche la dimensione familiare e la sfera del tempo libero, le pratiche sociali e, in ultima analisi, tutti gli ambienti in cui si forma e si costruisce il capitale sociale.

La digital literacy si inserisce, infatti, in un contesto più generale di acquisizione di competenze che hanno a che fare con la formazione del capitale umano: 'we should consider digital literacy more carefully, and put it in practice for children's and young people's present and future digital inclusion, together with other basic information-processing competences and communication abilities taught in the school in the network society' (Meneses e Mominò, 2010, p. 206).

La digital literacy è stata definita, nei documenti ufficiali della Commissione Europea, come: 'the skills required to achieve digital competence, the confident and critical use of ICT for work, leisure, learning and communication [...] Digital literacy is underpinned by basic technical use of computers and the Internet' (European Commission, 2010).

Nella prospettiva di Sonia Livingstone, docente presso il Dipartimento di Media e Comunicazioni della London School of Economics e una delle maggiori esperte mondiali di Media Literacy, concetto da cui la Digital literacy è derivata, essa fa riferimento all'abilità di *accedere, analizzare, valutare e creare* messaggi. Si tratta di azioni che costituiscono, insieme, un approccio sistemico basato su un set di competenze che hanno a che fare con un approccio critico ai media e ai loro contenuti.

Ovviamente la presenza dei media digitali ha determinato una riflessione e un ripensamento che riguarda i vari aspetti considerati, a partire dall'accesso: con il digitale e la rete cambiano molte cose, perché muta la natura del mezzo e si trasformano radicalmente i messaggi e i criteri che devono essere utilizzati per valutarli e per crearne di nuovi (Livingstone, 2004; 2010).

Non a caso, si deve ancora a un gruppo di lavoro guidato da Sonia Livingstone, un tentativo di riformulazione del concetto di Literacy, che integra tre componenti (information, media and computer) e le fa interagire in una struttura interdisciplinare: 'that such multi-media and trans-domain structuring may produce 'transliteracy' defined as the ability to read, write and encode in interaction with digital tools and platforms as well as the capacity to search, test and validate 'information' in its various shapes as understood in computer sciences (codes), in media and communication sciences (news) and in information sciences (documents)' (Frau-Meigs, 2012, p. 21).

Conclusioni

La parziale disamina degli studi sul tema delle disuguaglianze digitali con riferimento alla categoria concettuale dei nativi, ha confermato l'idea che questa etichetta sia stata spesso applicata ai giovani (di tutte le età) in maniera eccessivamente sbrigativa, offuscando l'esistenza di squilibri ed effettive disuguaglianze nel rapporto con i media digitali e specialmente con i nuovi ambienti comunicativi caratterizzati dalla presenza del web partecipativo (o web 2.0) e dei social media.

Dai materiali analizzati emerge piuttosto una varietà di comportamenti comunicativi, che possiamo associare ad altre considerazioni, derivanti dalle tendenze rilevabili in questa fase storica. La prima considerazione è che le distanze tra giovani e adulti, con riferimento all'uso delle tecnologie digitali, si stanno, almeno in parte, riducendo: sono sempre più numerosi gli adulti che navigano in Internet e che utilizzano i social network o i servizi di messaggiera istantanea; da un altro punto di vista, i più piccoli (a partire dai bambini dai 3 a 5 anni) mostrano comportamenti sempre più precoci nella gestione delle tecnologie digitali, avvicinandosi sempre più ai 'nativi' di ieri.

Una seconda osservazione riguarda il riconoscimento dell'importanza strategica dell'acquisizione delle competenze digitali per diverse ragioni, che vanno dalla partecipazione politica, allo sfruttamento dei servizi digitali implementati dalle PA, sino alla facilitazione delle relazioni sociali. Essere 'digitalmente inclusi', possedere competenze digitali, è diventato un obiettivo irrinunciabile per i cittadini della network society (Bentivegna, 2009).

La cosiddetta digital literacy rientra, perciò, in un quadro più ampio che chiama in causa le politiche formative, diventate sempre più strategiche per contribuire, attraverso l'investimento nelle risorse umane, alla crescita

economica dei nostri paesi. La *Strategia di Lisbona* e ancor più *Europa 2020* si fondano su obiettivi legati a un modello di sviluppo economico orientato all'innovazione, all'efficienza e alla coesione sociale. Tali obiettivi prioritari sono sintetizzati da espressioni quali: *crescita intelligente, crescita sostenibile e crescita inclusiva*. Per la loro realizzazione l'istruzione, la formazione e l'apprendimento permanente, cioè l'apprendimento lungo tutto il corso della vita (*lifelong learning*), rivestono un ruolo fondamentale. Inoltre, nell'ambito delle iniziative di Europa 2020, l'Agenda Digitale prevede un 'pilastro' dedicato al potenziamento della digital literacy e delle competenze digitali per favorire l'inclusione sociale di tutti i cittadini. Tale obiettivo deve naturalmente connettersi all'implementazione di iniziative di Media education (Tirocchi, 2013) rivolte a contesti formali e informali e a tutte le categorie di soggetti, non soltanto alle giovani generazioni.

La Media literacy è dunque un obiettivo irrinunciabile per l'Europa, anche se è sempre molto difficile riuscire a far entrare questi temi tra le policies prioritarie, in uno scenario di risorse sempre più scarse. Occorre inoltre che i vari paesi si coordinino per non disperdere il valore delle iniziative intraprese puntando su forme di valutazione della Media Literacy, inizialmente anche a breve termine (COST, 2013).

Un discorso a parte, infine, merita la scuola, un'istituzione che sta attraversando momenti difficili ma che è ancora importantissima, un luogo fisico in cui dovrebbe essere possibile fare esperienza delle ICT e dei nuovi ambienti di apprendimento fondati sui social media. Secondo l'ultimo rapporto European Schoolnet (2012), in Italia le condizioni infrastrutturali che dovrebbero sostenere e favorire l'insegnamento e l'apprendimento con le ICT non sono presenti in tutte le scuole e anche la banda larga negli edifici è disponibile in misura inferiore alla media europea (European Schoolnet, 2012).

Iniziative come il Progetto Nazionale Cl@ssi 2.0, promosso nel 2009 dal Ministero dell'Istruzione e conclusosi nel 2012, hanno dimostrato come a partire da un investimento sulle tecnologie, si possano gettare le basi per un cambiamento degli ambienti e degli stili di apprendimento tradizionali. In questo caso gli insegnanti delle classi coinvolte nella Regione Piemonte, in particolare, hanno dimostrato di possedere le competenze comunicative e relazionali necessarie per avviare progetti basati sulla presenza delle tecnologie e delle piattaforme partecipative, progetti che in molti casi si sono rivelati davvero innovativi (Taddeo e Tirocchi, 2012). Questo aspetto fa riflettere ancora una volta sulle molteplici sfaccettature della digital literacy

e sulla versatilità e ampiezza del concetto di competenza digitale (Jenkins et al., 2010).

Proprio per questo, se la scuola potrebbe costituire un punto di partenza per promuovere le pratiche di digital literacy, essa non può certo rappresentare l'unica istituzione di riferimento: la famiglia, il territorio e tutta la dimensione informale dei processi educativi potrebbero giocare, in futuro, un ruolo molto rilevante.

References

- Bennet, S., Maton, K. and Kervin, L. (2008) The 'digital natives' debate: A critical review of the evidence. *British Journal of Education Technology*, 39 (5), 775-786.
- Bentivegna, S. (2003) *Teorie delle comunicazioni di massa*. Roma-Bari: Laterza.
- Bentivegna, S. (2009) *Disuguaglianze digitali. Le nuove forme di esclusione nella società dell'informazione*. Roma-Bari: Laterza.
- Buckingham, D. (2004) *Né con la tv, né senza la tv. Bambini, media e cittadinanza nel XXI secolo*. Milano: FrancoAngeli.
- Castells, M. (2002) *La nascita della società in rete*. Milano: Egea.
- Ferri, P. (2011) *Nativi digitali*. Milano-Torino: Pearson.
- Frau-Meigs, D. (2012) Transliteracy as the New Research Horizon for Media and Information Literacy. *Media Studies*, 3 (6), 14-27.
- Gallina, M.A. (2010) *I divari del futuro. Giovani e Internet*. Acireale: Bonanno.
- Gui, M. and Argentin, G. (2011) Digital skills of internet natives: Different forms of digital literacy in a random sample of northern Italian high school students. *New Media & Society* 13 (6), 963-980.
- Hargittai, E. (2002) Second-level digital divide: Differences in people's online skills. *First Monday*, 7 (4). [Online]. Available from: <http://firstmonday.org/article/view/942/864>. [Accessed: 18th May 2014].
- Helsper, E. and Eynon, R. (2009) Digital natives: where is the evidence? *British educational research journal* 36 (3), 503-520.
- Hsieh, Y.P. (2012) Online social networking skills: The social affordances Approach to Digital Inequality. *First Monday*, 17 (4). [Online]. Available from: <http://firstmonday.org/article/view/3893/3192>. [Accessed: 18th May 2014].

- ISTAT (2013) *Cittadini e nuove tecnologie. Report*, [Online]. Available from: <http://www.istat.it>. [Accessed: 18th May 2014].
- Jenkins, H. (2006) *Convergence Culture*. New York: New York University Press.
- Jenkins, H. (2007) Reconsidering Digital Immigrants, [Online]. Available from: http://henryjenkins.org/2007/12/reconsidering_digital_immigran.html [Accessed: 18th May 2014].
- Jenkins, H., Ford, S. and Green, J. (2013) *Spreadable media: Creating Value and Meaning in a Networked Culture*. New York: New York University Press.
- Jenkins, H., Purushotma, R., Weigel, M., Clinton, K. and Robinson, A. (2010) *Culture partecipative e competenze digitali. Media education per il XXI secolo*. Milano: Guerini.
- Kennedy, G., Judd, T., Churchward, A., Gray, K. and Krause, K. (2008) First year students experience with technology: Are they really digital natives? *Australasian Journal of Educational Technology*, 24 (1), 108-122.
- Livingstone, S. (2004) Media Literacy and the Challenge of New Information and Communication Technologies. *The Communication Review*, 7 (1), 3-14.
- Livingstone, S. (2010) *Ragazzi online*. Milano: Vita & Pensiero.
- Livingstone, S. and Helsper, E. (2007) Gradations in digital inclusion: Children, young people and the digital divide. *New Media & Society* 9 (4), 671-696.
- Margaryan, A., Littlejohn, A. and Vojt, G. (2011) Are digital natives a myth or reality? University students' use of digital technologies. *Computers & Education*, 56 (2), 429-440.
- Meneses, J. and Mominò, J.M. (2010) Putting Digital Literacy in Practice: How Schools Contribute to Digital Inclusion in the Network Society. *The Information Society*, 26 (3), 197-208.
- OECD (2009) 21st century skills and competences for new millennium learners in Oecd countries. *Oecd Education Working Papers*, n. 41.
- Park, Y.J. (2014) My whole world's in my palm! The second-level divide of teenagers' mobile use and skill. *New Media & Society*, published online, doi: 10.1177/1461444813520302.
- Prensky, M. (2001) Digital Natives, Digital Immigrants. *On the Horizon*, 9 (5), 1-6.
- Prensky, M. (2009) H. Sapiens Digital: From Digital Immigrants and Digital Natives to Digital Wisdom. *Innovate: journal of online education*, 5 (3).

- Rivoltella, P. (2012) *Neurodidattica. Insegnare al cervello che apprende*. Milano: Raffaello Cortina.
- Sanz, E. and Turlea, G. (2012) Downloading inclusion: a statistical analysis of young people's digital communication inequalities. *The European Journal of Social Science Research*, 25 (3), 337-353.
- Stella, R. (2012) *Sociologia delle comunicazioni di massa*. Torino: Utet.
- Taddeo, G. and Tirocchi, S. (2012) 'Re-tweet the teacher...'. Are Italian teachers 'followed by' or 'following' the Web 2.0 culture? *REM*, 5 (2), 219-234.
- Tapscott, D. (2011) *Net generation. Come la generazione digitale sta cambiando il mondo*. Milano: Franco Angeli.
- Thinyan, H. (2010) Are digital natives a world-wide phenomenon? An investigation into South African first students' use and experience with technology. *Computers & Education* 55 (1), 406-414.
- Tichenor, P.J., Donohue, G.A. and Olien, C.N. (1970) Mass Media Flow and Differential Growth in Knowledge. *Public Opinion Quarterly* 34 (2), 159-70.
- Tirocchi, S. (2013) *Sociologie della Media education. Giovani e media al tempo dei nativi digitali*. Milano: Franco Angeli.
- Van Deursen, A.J., van Dijk, J. (2010) Internet skills and the digital divide. *New Media & Society*, 13 (6), 893-911.
- Warschauer, M. (2003) *Technology and social inclusion: Rethinking the digital divide*. Cambridge: MIT Press.
- Wolf, M. (1992) *Gli effetti sociali dei media*. Milano: Bompiani.

Orientare l'analisi. Una semiotica critica e materiale è possibile?

Matteo TRELEANI*

Université Sorbonne Nouvelle, Paris III

Cosa accade quando i delegati assumono la responsabilità della parola che devono proferire? E si presentano, al tempo stesso, come ambasciatori imparziali, portatori di un verbo che basta a se stesso? O meglio, cosa accade quando gli sforzi critici s'indirizzano ai delegati e non a coloro che li hanno nominati? La delegazione alla tecnica di una pletera di attività umane pare oggi all'ordine del giorno, nel dibattito pubblico e mediatico. Un approccio critico dovrebbe rendere conto dei valori sottesi a queste pratiche. Una semiotica potrebbe allora riassumere un ruolo sociale come 'critica del discorso ideologico'. Tenteremo di capire se una semiotica critica e materiale è possibile, e in quali termini si può sviluppare un dialogo tra due prospettive apparentemente contrastanti.

Keywords: *Semiotica; digitale; dispositivo; delegazione; tecnica; critica, semiotica materiale; ant; latour; intenzionalità; rete; patrimonio culturale*

Introduzione

Nel film *Her* di Spike Jonze (2013), si descrive un mondo del futuro dove le intelligenze artificiali saranno talmente avanzate che gli umani finiranno per innamorarsene. Un nuovo sistema operativo finisce per soppiantare la fine di una relazione per il protagonista. Il film pone delle domande esistenziali interessanti. Se ognuno di noi contiene alla fine una parte di ripetizione e di tecnica, come distinguere tra un umano e un non-umano nel momento in cui quest'ultimo sembra aver preso coscienza di sé? Domande che erano già state poste da Philip K. Dick quando raccontava dei *replicanti* ma che nel film di Jonze assumono un aspetto romantico affettivo. Dal nostro punto di vista, questo tipo di approccio alle nuove tecnologie rivela una caratteristica tipicamente contemporanea.

* Corresponding author: **Matteo Treleani** | e-mail: matteo.treleani@gmail.com

Dallo spunto di partenza di Jonze c'erano due possibilità per far evolvere la storia. La prima, quella adottata da Jonze, era quella di osservare le conseguenze esistenziali di un'intelligenza artificiale oramai autonoma, e vedere come queste pongono delle questioni alla nostra stessa esistenza. La seconda, che riteniamo più critica, era quella di vedere come questi sistemi operativi a cui tutti si affeziono in maniera quasi ossessiva, costituiscono alla fine una relazione di potere. Una volta innamorato di un dispositivo digitale, ci si può domandare quale effetto di potere questo dispositivo può avere sull'umano. Il dispositivo, prodotto da qualcuno con dei fini precisi, dunque, può essere osservato come l'origine di una relazione di potere che implica l'umano e gli *fa fare* delle cose, oppure si può osservarne le conseguenze indipendentemente da un discorso politico, visto che gli effetti trascendono le intenzioni.

La seconda ipotesi tiene conto di due questioni. Innanzitutto l'intenzionalità dietro il dispositivo. Si sostiene, dunque, che queste intelligenze artificiali sarebbero state create da qualcuno e le relazioni di potere che intrattengono potrebbero essere il risultato di una precisa strategia politica di manipolazione. In secondo luogo, si osserva la rete d'interazioni tra umano e non-umano seguendo una precisa orientazione dello sguardo.

Iniziamo da un esempio. Si tratta di un esempio complesso che semplificheremo per motivi di spazio. Il patrimonio culturale è uno dei campi più soggetti a cambiamento in ragione dei supporti digitali. Il digitale provoca non poche difficoltà in materia di conservazione degli archivi ma è tuttavia utile per pubblicare gli oggetti patrimoniali, renderli disponibili al pubblico. La maggior parte delle istituzioni tende a difendere delle strategie che mirano a un'accessibilità totale del patrimonio, soprattutto in rete.

Questo tipo di approccio è condiviso da stati, organizzazioni e, in particolare dalla Commissione Europea che incita gli stati membri a pubblicare il maggior numero di *oggetti* (termine usato dalla Commissione stessa) sul portale *Europeana* (si veda la Raccomandazione del 27 ottobre 2011 sulla *digitalizzazione e accessibilità on-line del materiale culturale*). L'obiettivo condiviso dalle politiche pubbliche è quello di garantire l'accessibilità *materiale* ai contenuti culturali.

E' una visione normalmente condivisa dalla maggior parte dei discorsi anche filosofici. Michel Serres (2012, p. 19), per esempio, afferma che il *sapere* sarà prossimamente *disponibile, oggettivato sulla rete*. Dietro queste politiche e affermazioni si nascondono dei presupposti epistemologici che vale la pena indagare.

Innanzitutto si fa riferimento a una nozione di *accessibilità* basata su un'idea di *trasparenza*. Non ci attarderemo in questa sede su queste nozioni e le conseguenze sul concetto di patrimonio, ma vogliamo riflettere su come questa strategia politica apparentemente legittima e, spesso, in specifici casi concreti, utile, nasconda, in effetti, un'ideologia soggiacente. L'idea della trasparenza e dell'accessibilità implica che si vuole dare al pubblico l'archivio senza intermediari *semiotici* (che ne operino una rinunciazione).

E per farlo si deve delegare a un dispositivo neutro, tecnologico, il processo di pubblicazione. Il tutto si basa a nostro avviso sul fatto di occultare due dimensioni semiotiche proprie al processo di pubblicazione del documento.

Occultamento degli intermediari

Innanzitutto la nozione di trasparenza implica l'idea che ci si possa disfare degli intermediari, che, nel caso del patrimonio, sarebbero gli storici per esempio, potendo raggiungere direttamente gli oggetti su cui essi si basano, ovvero gli archivi. Il che, però, implica che questi oggetti contengono in sé la storia, cosa visibilmente discutibile. Si dà dunque per scontato che il dato, possa essere significativo indipendentemente dalla *rete* e dalle relazioni complesse in cui questo è implicato, e da cui è costituito. Si occultava dunque, intenzionalmente o no, una dimensione propriamente semiotica del documento, seguendo la tripartizione del documento secondo Rastier (2013) che parla di dimensioni filologica, ermeneutica e semiotica.

Concretamente questo significa che un documento d'archivio è raramente significativo di per sé, ma soltanto se messo in rete con una serie di altri documenti o discorsi, del passato o del presente, che permettono di contestualizzarlo.

In secondo luogo, e qui ci avviciniamo al centro della nostra questione, si dà per scontato che il dispositivo tecnologico sia neutro, non significativo e non influente sul contenuto. Il criterio di accessibilità e trasparenza, che vuole bypassare gli intermediari per metterci direttamente di fronte all'oggetto, tende a *delegare alla tecnica*, la pubblicazione. Tuttavia questo implica che la tecnica è neutra, priva di una dimensione semiotica. Ciò che manca sembra dunque essere un *sensu della tecnica*, una razionalità propriamente computazionale, nei termini di Bruno Bachimont (2010).

Occultamento del dispositivo

Al fine di garantire la trasparenza si ricorre dunque a un dispositivo tecnologico: questo permette un'accessibilità materiale all'archivio. Ora, il dispositivo digitale implica un regime d'interazione col contenuto (Landowski, 2006), gli archivi nel nostro caso (Treleani, 2014b). Seguendo Landowski possiamo affermare che i regimi d'interazione sono dei regimi di senso. Il tipo d'interazione orienta la nostra lettura del documento costituendo un orizzonte di attesa sul tipo di mondo descritto dai documenti. In altri termini, questo quadro di lettura implicherà che crederemo reale o finzionale (Jost, 2005), per esempio, il mondo raccontato dal documento d'archivio dipendentemente dal modo d'interazione che ci ha condotto a lui. L'interazione retta dal dispositivo costituisce dunque un regime di credenza sul contenuto (Fontanille, 2013), definisce i criteri di oggettività adottati per *leggere* quel contenuto.

Per esempio, si può credere che il mondo cui fa riferimento un telegiornale degli anni '60 pubblicato on-line su *EUScreen.eu* (portale audiovisivo di *Europeana*) – nel quadro di una strategia pubblica di accessibilità del patrimonio audiovisivo - sia reale, perché facciamo aderire il documento a un regime di oggettività in cui l'archivio vale come *prova di un evento*. Il che sarà indotto dal genere del documento – il telegiornale – ma anche dal modo in cui arriviamo all'archivio, il regime d'interazione, dunque. Poter manipolare fisicamente, con l'interattività, questi documenti mette l'utente di fronte a una situazione in cui crediamo di aver a che fare con dati spuri, privi d'intermediazione, e dunque significanti di per sé, indipendentemente dal contesto del dispositivo in cui questi sono inseriti.

Un *grado zero della scrittura* riferito al contesto mediatico. Se i discorsi raccontati in questo telegiornale si rivelassero essere della propaganda filtrata da un governo, ci sarebbe un contrasto evidente tra l'orizzonte d'attesa dato dal dispositivo e il contenuto effettivamente mostrato.

Saremmo dunque in un caso di manipolazione dell'utente cui viene dato come vero qualcosa che effettivamente non lo è (Treleani, 2014a).

Riassumiamo. La delegazione alla tecnica dell'accessibilità al patrimonio culturale implica due occultamenti. Un primo vuole che gli oggetti cui si accede contengano in sé un patrimonio oggettivo, occultando un'intermediazione che rende questo patrimonio effettivamente intellegibile (l'intermediazione dello storico, per esempio). Un secondo vuole che i dispositivi digitali usati siano anch'essi trasparenti, neutri. Nel tentativo di superare gli intermediari bisogna che l'intermediario tecnico sia il meno possibile influente, sparisca per lasciar spazio agli oggetti mostrati.

Un errore di categoria?

Proviamo ora ad applicare un approccio latouriano a questo esempio. Il fatto d'interpretare un film di propaganda come un documento che attesta la verità di un evento è ciò che Latour definisce un *errore di categoria*? Fare a botte con un attore che interpreta il cattivo sul palco è un errore di categoria, per esempio (Fossier e Gardella, 2006). Prendere per attualità un documento di propaganda è forse un errore dello stesso tipo?

Probabilmente la questione può essere posta in questi termini e un approccio ANT sarebbe utile per descrivere la serie di relazioni complesse in cui gli editori del sito *EUScreen.eu* sono implicati, il modo in cui vengono trattati i dati, le limitazioni tecniche, professionali e tutto un insieme di questioni che fanno sì che un reportage di propaganda venga alla fine posto in una rete di dispositivi che daranno all'utente l'impressione che si tratti di un evento reale. Inoltre l'approccio ANT integra per forza di cose il dispositivo digitale in quanto attore *non-umano* nell'interazione tra utente e documento d'archivio. Tuttavia la questione, dal nostro punto di vista, non riguarda il problema in se, localmente, ma il fatto di capire *perché questo problema si pone oggi*? Non si tratta solo di capire dov'è l'errore ma perché questo errore ha luogo e, soprattutto, se questo errore non sia in realtà un epifenomeno di un discorso ideologico generale e di cui poter, in seconda istanza, effettuare una critica.

Dal punto di vista semiotico si tratterebbe di tornare ai propositi di Eco (1975, p. 365) nel *Trattato di semiotica generale*, riguardo a una semiotica come 'critica del discorso ideologico'. D'invertire dunque il proposito saussuriano secondo cui bisogna studiare la vita dei segni nel contesto della vita sociale per studiare invece 'la vita sociale attraverso i segni', come afferma Andrea Catellani (2013, p. 205). Il che non preclude la possibilità di una semiotica critica *materiale*, ovvero di determinare il senso e le relazioni di potere come frutto di reti complesse. Ma implica che questo insieme d'interazioni dev'essere come minimo *orientato* dall'analista al fine di discernere delle eventuali finalità dietro un fascio di valori.

Non sarebbe dunque legittimo chiedersi, perché oggi si veicola l'idea che la tecnica è neutra e che le interfacce ci avvicinano a una forma di oggettività? Si tratterebbe dunque di andare oltre la semplice descrizione di ciò che accade su *EUScreen* e l'errore di categoria conseguente e di capire per quale motivo questo errore si produce, se non si tratti, per esempio, al di là delle intenzioni locali, del risultato di un'ideologia generale che si concretizza in casi come questo. Capire il perché oltre che il come dunque, che è forse la distinzione più nota tra una sociologia tradizionale e la

sociologia delle reti. Tentiamo allora di capire se questa prospettiva critica può sposarsi con la visione dell'ANT proposta da Bruno Latour.

Le reti sono orientate?

John Law (2009) afferma che l'ANT può essere vista come una 'versione empirica del post-strutturalismo' foucauldiano. Foucault ha dato molti concetti utili al discorso critico, dalla nozione di biopotere e società disciplinare a quella di dispositivo. Permettiamoci allora un parallelo tra la nozione di *réseau* dell'ANT e quella di *dispositivo* usata sopra, due opzioni che sembrano avere non pochi punti in comune. Perché per esempio Latour parla ormai di *associazioni* e non più di dispositivi quando spiega di volersi interessare al sociale, ovvero alle 'associazioni tra elementi eterogenei' (Latour, 2006, p. 8) e al modo in cui queste associazioni si costruiscono, si disfano e si ricostruiscono secondo un movimento inatteso? Il concetto di associazione o di rete sembra essere più neutro di quello di dispositivo, certamente ambiguo e spesso usato nei modi più disparati, ma che mantiene tuttavia una connotazione propriamente politica. Nella sua accezione foucauldiana (1994, pp. 299-300), quella usata da Agamben, per esempio (2006), il dispositivo è un insieme di relazioni tra elementi eterogenei la cui finalità è l'esercizio del potere sull'individuo. Il dispositivo è un mezzo per esercitare il potere.

In questo senso va intesa la nozione di *soggettivazione*, ovvero di costituzione del soggetto da parte del dispositivo. L'individuo in interazione con un telefono cellulare, per esempio, assume un ruolo di soggetto, chiamiamolo pure 'ruolo attanziale', che gli è dato dal particolare tipo di pratiche necessarie ad agire con e attraverso il cellulare. Si può per esempio affermare che la *reperibilità* e la *mobilizzazione totale* di cui parla Maurizio Ferraris (2011), ovvero l'assoggettamento dell'individuo che, nella sua quotidianità è di fatto disponibile per l'attività lavorativa, potendo rispondere a una mail alle tre del mattino, per esempio, sono delle condizioni in qualche modo *imposte* dal tipo di relazione che intratteniamo col dispositivo.

Non si tratta dunque solo di spiegare il funzionamento di queste reti di associazioni ma di farlo attraverso una prospettiva *orientata*: ovvero di vedere le reti come portatrici di valori e dunque di discorsi ideologici. Anche nell'accezione ristretta d'*ideologia* in effetti, quella semiotica di Greimas e Courtès (2007, p. 150), per esempio, quest'ultima è intesa come un'articolazione sintagmatica di valori (opposta all'assiologia che ne è

l'articolazione paradigmatica): 'l'ideologia è una ricerca permanente di valori, e la struttura attanziale che l'informa dev'essere considerata come ricorrente in ogni discorso ideologico'. L'ideologia è dunque una tensione verso dei valori. Si potrebbe allora affermare che i discorsi tendono in qualche modo a un'organizzazione valoriale in modo ideologico. Una questione di *orientazione*, appunto.

Possiamo per esempio affermare, come fa Stephane Vial (2013, p. 277) che l'iPad è un mezzo per liberarci dalla dittatura dell'ufficio nelle relazioni lavorative. Ma possiamo ugualmente affermare che l'iPad è in effetti un'estensione dello spazio del lavoro alla sfera privata, come fanno per esempio Eleni Mitropoulou (2007) quando parla di un *non poter non fare*, indotto dai dispositivi interattivi o Maurizio Ferraris, appunto, riguardo alla *reperibilità* degli Smartphone.

Si tratta dunque di *orientare* l'analisi al fine di rivelare il discorso ideologico sotteso alle pratiche d'interazione. E' una scelta da assumere; un'altra scelta può essere quella di descrivere queste pratiche indipendentemente dalla situazione sociale d'interazione, uscendo però di fatto dal campo di quella che vogliamo chiamare *socio-semiotica* ma anche da una semiotica materiale intesa come studio delle relazioni.

Questa posizione sul concetto di dispositivo (che resta un esempio, altri concetti e teorie sono naturalmente possibili) mostra soprattutto la necessità di disfarsi di un'idea di dereificazione del potere in reti e effetti locali di cui è impossibile riconoscere le intenzioni. Dal nostro punto di vista, il dispositivo come lo intende Agamben (e dunque in una reinterpretazione del dispositivo per Foucault) è orientato. Ovvero tende a un preciso effetto sul soggetto. Il potere non è solo un effetto locale ma il prodotto di una strategia precisa.

Controversie e modi di esistenza

Nelle sue opere più recenti, Bruno Latour (2012) offre diversi spunti di riflessione per le questioni sviluppate sopra. Prendiamo per esempio l'ultima fatica del sociologo, un'opera di *metafisica* se vogliamo seguire Patrice Maniglier (2012). Nell'*Enquête sur les modes d'existence*, la teoria ANT è uno tra i possibili modi di esistenza, ovvero i regimi di veridizione che dovrebbero reggere, secondo Latour, i discorsi sociali (e che costituiscono allo stesso tempo le categorie metafisiche di questi *esseri*). La rete avrebbe un limite secondo lo stesso Latour (2012, p. 47) quello di 'non qualificare i valori'. Il che sembra avvicinarsi al nostro discorso, ovvero alla possibilità di

vedere nelle relazioni tra elementi eterogenei un veicolo per dei valori e dunque, appunto, un'orientazione.

Vediamo in cosa consistono i modi di esistenza. Latour parla di un modo politico, religioso, della tecnica, del diritto, della finzione ma anche della metamorfosi, della riproduzione ecc. Questa quasi medievale categorizzazione degli *esseri* nasce con uno scopo ben preciso, quello di indicare che spesso le controversie nascono da ciò che Latour (2012) chiama *errori di categoria*. Mettere a confronto i discorsi sul riscaldamento globale degli scienziati (modo di esistenza scientifico) con quelli di alcuni politici texani che ne negano il pericolo (modo di esistenza politico), per esempio, significa fare un errore di categoria. Per parlare del riscaldamento, il regime scientifico – che Latour chiama *référance* - è quello che garantisce un regime di oggettività adeguato. In effetti, il problema non è a chi credere, ma quale regime adottare.

Secondo Latour dunque non si dovrebbe parlare di realismo ma di *realismi*, ognuno di essi con delle logiche proprie e dei criteri di oggettività particolari. E la semiotica potrebbe essere il metalinguaggio utile a gestire il dialogo tra i modi di esistenza o meglio, azzardiamo, il dialogo tra queste diverse *realità*. Perché l'obiettivo dell'ultima fatica latouriana è una forma di *diplomazia*, che spetterebbe alle scienze sociali, ovvero la costituzione di matrici di comunicabilità tra i diversi regimi, al fine di dar vita a una commensurabilità che ponga fine a delle controversie che non sono altro, appunto, che errori di categoria e, dunque, problemi riguardanti i punti di vista adottati nel dialogo.

Tornando all'esempio del patrimonio on-line, questa prospettiva si può rivelare fertile: si potrebbe dunque parlare di errore di categoria. Un modo referenziale di tipo scientifico si scontrerebbe con un modo della finzione.

Tuttavia resta sempre l'impressione che non coglieremmo il punto della questione. Perché il vero problema non è l'errore in sé, ma il perché dell'errore. Il motivo che ha spinto gli editori a pubblicare un documento di propaganda senza dirlo, seguendo una logica dell'accessibilità e della trasparenza diffuse nei discorsi pubblici. Ovvero si tratta di *orientare* la descrizione, della serie di elementi implicati nella pubblicazione e della confusione tra due regimi di credenza, al fine di capire se tutto questo non sia il frutto di un'ideologia e non diventi dunque veicolo di questa stessa ideologia.

La questione della critica

Bruno Latour si è più volte espresso contro un discorso critico (avendo probabilmente come obiettivo, soprattutto la sociologia critica di Bourdieu). Uno dei suoi punti principali è che la critica si sarebbe esaurita ('ran out of steam') in quanto cercava di svelare la realtà dietro alle manipolazioni, demistificare, per l'appunto (Latour, 2004). Facendo dunque i conti con una realtà che sarebbe 'en retrait' come afferma Maniglier, sempre altrove, sempre oltre. Da una parte ci sarebbero i discorsi, ideologici per esempio, che si tratta di studiare, dall'altra la realtà che essi descrivono. La demistificazione implica che qualcosa dall'altra parte ci sia realmente, per poter giudicare i discorsi come più o meno aderenti ad essa. La posizione latouriana è invece totalmente immanentista: in una prospettiva forse figlia delle scoperte scientifiche della fisica nel XX secolo, afferma che *le* realtà, al plurale, si costruiscono durante l'osservazione. 'Un approccio critico, per rinnovarsi e tornare rilevante, si troverebbe nel coltivare un'attitudine realista, ma un realismo che tratta dei motivi d'interesse (*matter of concern*) e non dei dati di fatto (*matter of fact*)' (Latour, 2004). Ovvero, traduciamo, si tratterebbe di capire perché certe cose ci interessano e non di cedere a dei presunti esseri che vivrebbero dietro i discorsi, questo perché i discorsi stessi creano gli *esseri*: l'essere non è da cercarsi *sotto* il linguaggio ma si crea continuamente nel momento stesso in cui ne parliamo.

Questa posizione porterebbe a una sospensione del gesto critico per comporre invece di distruggere, mettere insieme diverse prospettive e comprenderne le differenze e le similitudini, invece di scontrarle. La difficoltà è che Latour tende in questo modo a cancellare qualsiasi orientazione nelle descrizioni scientifiche. La descrizione crea la realtà non la descrive. I dibattiti sono allora il frutto di *errori di categoria*, trovare il posto ontologicamente giusto all'oggetto in una categorizzazione permette di superare ogni scontro.

Tuttavia, il gesto critico è sensato nel momento in cui afferma la propria origine, nel momento in cui esplicita il proprio sguardo al fine di mostrare che, per esempio, usando un dato approccio le cose si presentano in dati termini e sono dunque problematiche da un certo punto di vista. Il gesto critico afferma se stesso, in una pratica che è d'altra parte ben nota all'antropologia. Nell'ultima opera di Latour, sottotitolata un'*antropologia dei moderni*, è invece proprio il punto di vista a mancare. Latour vuole far dialogare i modi di esistenza e creare una diplomazia che permetta di superare le controversie ma non è chiaro da quale punto di vista parli il libro stesso. Una diplomazia necessita due parti in causa e, soprattutto, i

diplomatici stessi sono sempre due, non uno. La critica, dal nostro punto di vista, non è la distruzione dell'oggetto (*hammer*, per Latour, 2004) per dimostrare che si trattava di un falso, ma l'affermazione del proprio sguardo nel momento in cui questo mostra che un oggetto ci stava manipolando. La critica può adottare un'attitudine pragmatica, occupandosi del modo in cui l'oggetto si presenta a noi e non necessariamente della realtà di questo oggetto.

Non è necessario affermare una realtà *dietro* il discorso per dar luogo alla critica: Jacques Fontanille (2013), per esempio, basandosi su alcune intuizioni di François Jost, individua nella sovrapposizione tra più regimi di credenza nei media, una forma di manipolazione. I reality, per esempio, si presentano allo spettatore come il filmato di eventi in corso ma occultano il fatto che la maggior parte di questi eventi seguono delle logiche finzionali, sono messi in scena. Qui non si tratta di affermare ciò che una cosa è o non è – il reality è allo stesso tempo messo in scena e filmato in diretta – si tratta di mostrare che il canale che lo diffonde fa credere allo spettatore che si deve seguire un certo regime di credenza quando ne sono necessari anche altri.

La critica può dunque aver luogo indipendentemente dall'affermazione di una presunta realtà reale, più reale delle affermazioni manipolatrici, nel momento in cui questa esplicita il proprio sguardo. Il che, d'altra parte, è una condizione necessaria a qualsiasi prospettiva scientifica.

Possiamo limitarci agli effetti locali?

Preso in considerazione questa necessità di esplicitare il proprio sguardo, torniamo ai modi di esistenza. Un altro problema nella strutturazione dei modi, sembra la possibilità di una controversia interna a uno stesso regime di veridizione. Se ogni scontro nasce da un errore di categoria, ciò che viene a mancare è la possibilità che un discorso sia intenzionalmente orientato o strumentale. Lo scontro tra modo di esistenza politico e scientifico nel dibattito sul riscaldamento globale, per esempio, dovrebbe poter tener conto della strumentalizzazione dei discorsi basata su diverse intenzioni.

Non è detto che i politici texani credano in ciò che dicono perché parte di un modo di esistenza preciso, ma perché hanno delle intenzioni precise.

Se la semiotica studia secondo il vecchio motto echiano 'tutto ciò che può essere usato per mentire', il nuovo impianto di Latour sembra, al contrario, escludere qualsiasi possibilità di questo genere, la menzogna essendo, il più delle volte, intenzionale. Latour stesso afferma che la

menzogna è 'la domanda posta da un modo di esistenza a un altro modo di esistenza' e dunque un errore. Il politico mente perché questo regime d'enunciazione fa parte del suo modo di esistenza e non si potrebbe chiedergli di parlare secondo un modo referenziale di tipo scientifico. Ma vedere le cose in questo modo esclude che il politico possa per esempio, non mentire o, più semplicemente, costruire un discorso che trascende una semplice logica verocondizionale dove ciò che si dice è vero o falso (anche perché se i modi di esistenza sono modi dell'essere, tutto è vero ma secondo diversi regimi di oggettività).

La vera questione è, dunque, come noto, l'intenzionalità. Possiamo mettere in atto una semiotica critica senza tener conto dell'intenzionalità? Il punto a nostro avviso è di capire di quale intenzionalità stiamo parlando. Alvise Mattozzi (2009) afferma che 'il fatto che qualcosa sia costruito da un umano non significa che ciò che è costruito non acquisti una sua autonomia'. Le intenzioni dietro ai costrutti, che siano essi digitali o no, sarebbero dunque non pertinenti per gli studi semiotici in ragione dell'agency delle cose stesse che le trascendono e diventano attanti in un campo di forze che oltrepassa i loro stessi autori. Questa prospettiva è utile in particolare per rilevare un atteggiamento epistemico come prodotto dagli interstizi delle relazioni intertestuali e interoggettuali. Se rivelare un'intenzionalità in certe pratiche indotte da Facebook sembra quasi banale, per esempio (si incita a lasciare i propri dati perché Facebook possa rivenderli), come trovare un'intenzionalità ideologica dietro il cellulare come lo describe Ferraris? I produttori di Apple vogliono forse che la nostra vita privata sia dedicata al lavoro? Ma quali produttori esattamente? I designer?

Come risalire la scala d'intenzioni dietro un oggetto di questo tipo e capire se un discorso ideologico è veicolato intenzionalmente dall'iPhone? L'origine evidentemente si disperde più si tenta di raggiungerla. Il rischio di non cercarla, certo, è quello di vanificare gli sforzi analitici in una nebulosa tanto locale quanto incerta. Ma mantenere questa prospettiva permette di trascendere i discorsi dietrologici per rilevare piuttosto delle venature ideologiche anche in pratiche che all'apparenza non lo sono e che non vogliono esserlo. L'iPhone, da questo punto di vista, sarebbe *portatore* di ideologia, appunto perché facente parte di una rete d'interazioni che lo rendono tale e non perché qualcuno, coscientemente ha deciso di renderlo tale.

Il problema, dal punto di vista critico, si pone nel momento in cui una teoria si limita a descrivere una rete d'interazioni senza trovare una finalità alla propria descrizione. In altri termini, il problema è quello di rendere

conto di relazioni di potere come prodotto di *effetti locali* perdendo di vista una prospettiva più generale. Nel senso che seguendo pedissequamente una pura descrizione materiale si rischia di perdere, appunto, la visione generale che lega l'estensione dello spazio lavorativo permessa dall'iPhone alla diminuzione della sfera privata. John Law (2009) afferma che la 'l'approccio ANT non è una teoria. Le teorie di solito spiegano perché qualcosa accade, ANT è descrittiva più che fondativa in termini esplicativi [...] Racconta 'come' le relazioni si assemblano o non si assemblano'. Il che implica che una semiotica materiale sarebbe uno strumento che descrive delle relazioni locali e che esiste solo in quanto applicato a specifici casi concreti. Al fine di mettere in atto una prospettiva critica, si tratta dunque di trovare un orientamento a delle reti in modo che esse possano esprimere dei valori. E dunque esprimere, coscientemente, uno sguardo analitico orientato.

Il punto è che l'orientamento delle reti non riguarda le cose descritte ma la descrizione. Spetta all'analista semiotico orientare le reti in modo tale da capire certi meccanismi. Riprendiamo la questione dell'iPad, osservata sopra. Vial osserva la rete di relazioni tra soggetto e dispositivo in modo da vedere la possibilità di uscire da alcune logiche che fino ad oggi avevano governato l'attività lavorativa. Ferraris invece inverte la prospettiva: secondo lui, l'uscire da quelle logiche significa, per l'appunto, l'abolizione dei confini tra l'attività lavorativa e la vita privata – a questo proposito vale anche il discorso di Alexander R. Galloway (2012). La differenza non risiede nell'oggetto osservato, nel modo di costruire la rete d'interazioni, ma nello sguardo adottato.

Il che significa sfuggire alla tentazione parafrastica della descrizione per proporre una semiotica interpretativa che dà senso e costruisce il senso nella descrizione. In questo senso le reti descrittive sarebbero dal nostro punto di vista *orientate* ovvero veicolanti valori e intenzionalmente indirizzate – seguendo l'idea, cara a Rastier (2001), della semiotica come ermeneutica materiale, ovvero di una semiotica che mira a '*éclairer*' piuttosto che a '*éclaircir*', illuminare sotto un nuovo sguardo e non schiarire qualcosa che sarebbe già là, da scoprire.

La questione dunque non è se le reti sono o no orientate ma piuttosto di capire come *orientare le reti* dal punto di vista analitico. Si tratta di giustificare delle scelte. Una semiotica materiale può adottare un approccio *critico* se giustifica le proprie scelte ed esplicita il proprio sguardo. L'intenzionalità, sfuggita al dominio semiotico, se c'è, dev'essere intesa non

tanto come intenzione nascosta dietro alle cose ma, piuttosto, come intenzione di un modo di vedere le cose.

Riferimenti bibliografici

- Agamben G. (2006) *Che cos'è un dispositivo?* Roma: Nottetempo.
- Bachimont, B. (2010) *Le sens de la technique. Le numérique et le calcul.* Paris: Les Belles Lettres.
- Catellani, A. (2013) *Un apport sémiotique aux approches critiques de la communication. Notes sémio-rhétoriques sur le discours environnementaliste et sur la critique on-line du green-washing.* In Heller, T., Huet, R. e Vidaillet, B. (eds.), *Communication et organisation: perspectives critiques.* Lille: Presses du Septentrion.
- Eco, U. (1975) *Trattato di semiotica generale.* Milano: Bompiani.
- Ferraris, M. (2011) *Anima et iPad.* Parma: Guanda.
- Fontanille, J. (2013) *Médias, régimes de croyance et formes de vie.* In de Oliveira, A.C. (eds.), *As interações sensíveis.* São Paulo: Estação das Letras e Cores.
- Foucault, M. (1994) *Dits et écrits III (1976-1979).* Paris: Gallimard.
- Fossier, A. e Gardella, E. (2006) Entretien avec Bruno Latour. *Tracés. Revue de Sciences Humaines*, 10, 113-129.
- Galloway, A.R. (2012) *The Interface Effect.* New York: Polity Press.
- Greimas, A.J. e Courtès, J. (2007) *Semiotica. Dizionario ragionato della teoria del linguaggio.* Milano: Mondadori.
- Landowski, E. e Fontanille, J. (2006) *Les interactions risquées.* Limoges: PULIM.
- Latour, B. (2004) Why has critique ran out of steam? *Critical Inquiry*, 30 (2), 225-248.
- Latour, B. (2006) *Changer la société, refaire de la sociologie.* Paris: La Découverte.
- Latour, B. (2012) *Enquête sur les modes d'existence.* Paris: La Découverte.
- Law, J. (2009) *Actor Network Theory and Material Semiotics.* In Turner, B.S. (eds.), *The New Blackwell Companion to Social Theory.* New York: Blackwell Publishing.
- Maniglier, P. (2012) Un tournant métaphysique? *Critique*, 11 (786), 916-932.
- Mattozzi, A. (2009) La politica degli artefatti. Il caso del nuovo contatore elettronico. [online] *E/C Rivista dell'Associazione Italiana di Studi Semiotici.* Disponibile su: www.ecaiss.it/includes/tng/pub/tNG_download4.php?KT_download1=6b

- bcad3054a96c8e2855496b5571de92. [Ultimo Accesso: 31 Dicembre 2013].
- Mitropoulou, E. (2007) Média, multimédia et interactivité : jeux de rôles et enjeux sémiotiques. [online] *Actes Sémiotiques* Disponible su: epublications.unilim.fr/revues/as/4540. Ultimo Accesso: 31 Dicembre 2013.
- Rastier, F. (2013) *La sémiotique des textes, du document à l'œuvre*. In Frey, V. e Treleani, M. (a cura), *Vers un nouvel archiviste numérique*. Paris: L'Harmattan.
- Rastier, F. (2000) *Arts et sciences du texte*. Paris: PUF.
- Serres, M. (2012) *Petite poucette*. Paris: Le Pommier.
- Treleani, M. (2014a) *Mémoires audiovisuelles. Les archives en ligne ont-elles un sens?* Montreal: Presses de l'Université de Montréal.
- Treleani, M. (2014b) Dispositifs numériques. Régimes d'interaction et de croyance. [online] *Actes Sémiotiques* Disponible su: <http://epublications.unilim.fr/revues/as/5035>. Ultimo Accesso: 31 Dicembre 2013.
- Vial, S. (2013) *L'être et l'écran*. Paris: PUF.

Mobility and the Smart City. Innovative Solutions for Responsive Urban Space

Marco ZILVETTI* and Fausto BREVI
Politecnico di Milano

In the late years the expression 'smart city' is being used to define sentient urban contexts, capable to connect citizens and provide innovative solutions to their everyday needs. Cities are redefining themselves as stages for innovation and pervasive technologies are gaining a growing relevance in our everyday lives. Municipalities and researchers tend to underline the crucial role of collaborative patterns, involving citizens as active stakeholders in the value-generation process, towards solutions capable to improve the quality of their urban experience. As people are called to share the same urban spaces, possible conflicts may take place between personal interests and collective requirements; social life becomes therefore a sort of peace-treaty in which the tendency towards social equality and the individual tendency to stand out ought to find a balance. This is particularly evident in the field of urban transport, since the individual is called to recast his identity in terms of flexibility, adaptability and instant transformation, in order to adjust his own interests to the social requirement for a more sustainable mobility. The following dissertation intends to introduce a transdisciplinary overview of current urban trends, and of their possible evolution towards innovative solutions for the mobility needs of our tomorrow's cities.

Keywords: Smart city; urban spaces; applied technologies; collaboration; individualism; social frictions; personal mobility

1. Introduction

In recent years our cities are experiencing deep changes as technologies applied to the urban environment become more and more pervasive. In early Nineties the internet outbreak led researchers talk about 'death of distance', predicting the decease of cities and in 1995 the American writer George Gilder argued that networked communications would have become so easy and universal that people and businesses would have had no need

* Corresponding author **Marco Zilveti** | e-mail: marco.zilveti@polimi.it

to be near one another, turning cities into 'leftover baggage from the industrial era'. Despite such forecasts, urban areas are growing fast and people still flock to cities, attracted by potentially better opportunities to improve their lives than in smaller towns, even when challenged by lack of resources. Since 2008 more than 50% of the world population (3.3 billion people) live in urban contexts and this percentage is expected to grow, reaching a 70% (almost 5 billion people) within the year 2050. According to Cisco's Win Elfrink (2011), in the next decade 100 cities, mainly in Asia, will reach a population of more than 1million. Such a rapid urban growth underlines the double nature of city which may be considered on the one hand as a pivotal testing ground for technologies and social innovation and on the other hand as a battle-ground between individual and collective necessities, as far as urban population grows and the need of differentiation and the desire for change increase. Notwithstanding technological advance, the persistence of several open issues like pollution, traffic jam and fuel consumption still entail waste of time, stress and sense of frustration, underscoring how cities need a total commitment to find effective solutions capable to fix past mistakes and foster innovative solutions. In this sense, municipalities may choose between a traditional top-down policy and a bottom-up approach, the latter of which invite people to cooperate and solve open issues from a different point of view.

The starting point of this dissertation is a general outlook of the main opportunities deriving from the spread of pervasive information and communication technologies, applied to the built environment and to transportation design. To this end, information and communication technologies (ICT) often prove their potentials to support citizens' active role to enhance the perceived quality of products and services. Through an interdisciplinary overview of current urban trends and their possible evolution, the intent is to underline potential conflicts that may arise between individual and collective needs. Since urban mobility represents a crucial and often unsolved issue in contemporary cities, this paper intends to focus on this topic, highlighting opportunities about sustainable and 'tailored' solutions designed for individual commutes in the future urban spaces.

2. Smart Urban Spaces

Cities have always attracted people by promising three main things: security, prosperity, and quality of life, as underlined by Glaeser, Kahn and

Rappaport (2000). At a time when the spread of electronic devices seems to be increasingly dematerializing the world around us, urban environments gain a growing relevance as pivotal testing grounds for the conception and the implementation of innovative strategies to enhance connectivity opportunities and urban living standards. The resulting space can be seen as multi-layered complex systems where the digital and the physical worlds are intertwined and feedback loops become crucial (Resch et al., 2008) in the so-called 'smart city': a sort of 'open air computer' where information-processing capabilities are embedded throughout urban infrastructures and interactions take place as computing activities 'leave the desktop and spill out onto the sidewalks, streets, and other public urban spaces' (Shepard, 2011). Furthermore, the increasing presence of web-connected urban infrastructures and affordable mobile devices strengthens urban sensing capabilities, giving birth to what Mark Shepard (2009) describes as 'sentient cities', using a term that foregrounds the subjective aspects of the urban capability to feel and perceive data, without necessarily include the faculty of self-awareness. The production of a huge quantity of data is becoming a crucial factor for a better quality of life for all citizens, thanks to the pervasive 'sentient' equipment, recalling the theory of Ubiquitous computing (also known as 'UbiComp'), developed by the American computer scientist Mark Weiser (1991), who argued that in the coming future, miniaturization and ubiquity of sensors would have eventually lead to the integration of computers into the world at large, through technological solutions that 'disappear', moving into an invisible background.

3. Towards a Responsive Urban Body

At a first glance, future cities may not differ so much from today's ones, but the most changing feature will surely be the way people use spaces, live and interact with each other and with the surrounding urban spaces, thanks to new forms of information-sharing.

The traditional debate between architects, policy makers, engineers and planners is set to a broader level, focusing on urban and social improvements with their impacts on the society at large. Municipalities are called to take actions to provide citizens greener and more connected spaces, with high-quality services, where people can work together, interact and exchange data, thanks to efficient and pervasive web-based technology networks. As underlined by Richard Dorsey in a recent interview (Palis,

2012), the best technologies are those that disappear in the physical environment and city planners and local administrators need to conceive solutions capable to ease people's lives, without making them feel the presence of pervasive technologies.

It shall be said that even brilliant technology is not much use if cities are badly managed or their politics are dysfunctional. As John Day of IBM Research argues ('Open-Air Computers', 2012), it is crucial to focus not only on single areas – such as traffic or policing – but also on improving the quality of cities as a whole by drawing on data from multiple sources and use them to solve various open issues related to the personal and the collective urban experience.

Unlike what is happening in Asia, where several cities are being designed and built from scratch, in Europe we often need to face existing infrastructures and 'reinvent' them. Possible improvements may simply deal with late information and communication technologies applied to existing equipment, like streetlights, platforms and screens applied to urban furniture. They may also affect systems of energy distribution and other strategic urban services, with consequences not only on urban planning but even on citizens' everyday lives.

The resulting metropolitan areas are no more just mere geographical entities: as Resch, Britter and Ratti (2012) suggest, they turn instead into 'vibrant knowledge-network hubs, rich in high-potential connections and cooperating people', and the resulting smart city may look like a responsive body, where people get online almost everywhere thanks to an efficient ICT.

4. Individualism versus Collectivity

The mixture of collective intelligence and pervasive communication capabilities may be considered through a fresh interpretation, as personal mobile devices connected to the web are widespread and technologies become more and more performing on the move. Traditional limits tend to fade and our daily life changes, since work and spare time tend to be intertwined and a growing amount of work-related activities can be easily managed out of office, with deep impact on job management and other social activities.

Elliott and Urry (2010) underline that various social theories underscore the emergence of a 'new individualism' seen both as a set of institutional processes and as novel kind of identity-formation, related to the demand for instant change and the desire for continual self-invention.

More than a century ago, Simmel's study (1904) analysed how social life might be seen as a sort of 'battle-ground', every inch of which is stubbornly contested and the social institutions may be looked upon as peace-treaties, according to which the constant antagonism between the tendencies towards social equality on the one hand and the desire to stand out have been reduced externally to a form of cooperation.

Researchers like Bauman (2005) tend to use terms like 'Individualization', 'reflexive self-identity' and 'liquid life' to define trends, processes and lifestyles of contemporary society that Elliott and Urry (2010) see as marked by transitory rather than permanent, immediate and utility as prior to other values, underscoring the variable patterns, as well as the splitting of identity between a subjective and an objective dimension and between individual creation and system dependency.

As the Internet has become incorporated into everyday life with the implementation of pervasive mobile technologies, the growth of the web and the spread of social networks lead to the rise of 'networked individualism' (Wellman, 2001), based on connected individuals and personalized services. At the same time, as Greenfield (2006) argues, the rising patterns of the current urban evolution tend to hinge on the concepts of community, social communication, digital collaboration and networking.

5. Collaborative Patterns

The introduction of the term *Web 2.0* defines a computing paradigm that outlines the tendency to use the Web as a common space to collaborate and share information among users through wikis, blogs and social network services. This behaviour, also labelled as 'technology-mediated social/civic participation' (Preece and Shneiderman, 2009), shows the ability of masses to achieve common goals through participation and collaboration on the Web – goals that no single individual or organization could achieve alone. Users are now able to engage themselves in a more critical and direct way on Web-based activities, with an attitude tending to subvert the traditional top-down approach with a breaking-down process of the system's big picture. In this sense, individuals may cooperate to achieve great results for the benefit of the whole community.

Several studies (Jenkins, 2006; 2009) underline how urban communities tend to behave as interwoven structures of widespread awareness and users tend to move from spectators to direct actors and even co-authors of contents. Coalitions and networks are increasingly turning out to be pivotal

to successful change (Murray, Caulier-Grice and Mulgan, 2010), and the word 'collaboration' is gaining a crucial relevance for people-to-people communication patterns, considering that in a 'smart' city people, businesses and other stakeholders may easily communicate and cooperate.

Collaborative networks have now a big potential to exercise the citizenship, while information and knowledge sharing is becoming an ordinary attitude across society (Lévy, 1999), as digital technologies trigger a constructive and innovative dialog among citizens, administrations and urban environment (Büscher et al., 2009). Social production of space becomes an open process and much of the gathered data related to transport, housing, pollution and use of spaces is held by city government and agencies to enhance the quality of urban services (Hemment and Townsend, 2013).

A bottom-up approach becomes crucial, as citizens overcome their individualism to actively engage in the creation of cooperating communities, using the so-called 'collective intelligence' (CI) as a meaningful tool to enhance product and service quality. At the same time, also firms and public institutions explore the use of such approach for tackling systemic problems, fostering innovation and developing useful social interactions (Maher, Paulini and Murty, 2010). To this end, the so-called 'wisdom of crowds' can be crucial to reach fast and effective results, as people may have a more direct perception of problems and may share and report issues in real time through their mobile devices and eventually turning into sources of information to solve issues concerning the whole community.

6. Towards Innovative Solutions for Personal Transport

Mobility is one of the most important activities regarding citizens' everyday life and it also represents an often unsolved topic that needs a total commitment to find ultimate solutions since, despite technological advances, several cities still suffer from traditional problems like traffic, congestion, parking lot scarcity and consequent rising costs, health disease and pollution. According to Elliott and Urry's study (2010), the social structure of individual tasks is increasingly constituted through systems of movement and it is possible to see a paradox in contemporary mobile lives and analyse the *'intensive and extensive dimensions (real, imagined, virtual) of people's movements and travel in order to unearth the novel textures of*

individual life, [but] today few social forms are more predictable, routine and uniform than those of the mobile denizens of this global age'.

According to this assumption, we have two different points of view:

- the first one allows a glimpse of common features in the way people move and use public and private means of transport, to cope with their day-to-day lives;
- the second one underscores the subjective dimensions of travel activities, noticing that people tend to move in different ways, organizing their trips in terms of contrasting time-space modalities, from daily commuting to once-in-a-life escape.

In their contradictory urban experience, individuals are called to travel recasting their own identity in terms of flexibility and instant transformation, adapting to the different situations in which social and collective requirements must be taken into account. Mobile patterns are hard to summarize and deeply depending on social and geographical factors, while several issues can be analysed about user experience, vehicle design and service implementation.

Public Authorities have the mandatory mission to grant the right to mobility, making it more efficient, secure, reliable, cost-effective and environment-friendly, considering at the same time the requests coming from the population.

The main efforts of local administrations tend to push people towards a wider suite of options including ideas vehicles for personal mobility capable to reconcile individualism and community in a sustainable and cost-effective way. For this reason, we need a total commitment to innovate and improve the current situation and in this sense, the enhancement of public transportation systems is the first step to make urban mobility more efficient, reducing the number of vehicles on the roads and consequent stress and pollution.

In this sense, the individual will be more and more often called to recast his own identity in terms of flexibility, adaptability and instant transformation, in order to adjust his own interests to the social requirements.

In Italy, for instance, the 1998 Urban Mobility decree by the Italian Ministry of the Environment invited local administrations to foster alternative and shared forms of mobility, to reduce the impacts deriving from the use of private cars and consequent traffic, fuel consumption and pollution.

Considering that in several cities it is impossible to conceive a total shift towards public solutions – either because of inefficiencies of public transport or because people have specific requirements (mainly related to time, space and objects to carry) – there will be a consequent demand for efficient and flexible means of transport and local administrations are called to develop a multimodal transport system in which private, shared and public vehicles can be easily and effectively combined.

7. The Future of Cars

The experience of urban mobility entails inequalities by class, gender, age, ethnicity and capacity, as well as the demand for social adaptation since, despite several current alternatives for urban travels, many of them are clearly unsustainable from a either collective or environmental point of view. Car (intended as vehicles for personal commutes) might disappear from the metropolitan landscape only in a far-distant future, through great changes in urban mobility entailing implications and potential conflicts between environmental sustainability and community on one side and desired freedom of choice on the other (The City of the Future, 2012). In the meanwhile, it is mandatory to design innovative solutions capable to provide effective answers to local urban needs and constraints, taking advantage of actual and forthcoming innovations in the field of ICT and mobile devices, towards sustainable, integrated and more comfortable vehicles. As established by several studies and transnational directions (European Commission, 2011), future urban transport systems shall act on few main factors, in order to achieve solutions capable to merge individual, collective and environmental requirements in a more efficient and sustainable way, providing as well striking solutions to current urban open issues.

Clean efficiency

First of all, future solutions shall be really capable to reconcile personal and collective dimensions but also to encourage more sustainable and clean behaviours, towards post-carbon futures. Whitelegg (1993) underlines in his study that the existence of air quality guidelines is useful in giving focus to environmental objectives which represent the first stirrings of progress towards sustainability. To this end, in late years many ideas are brewing in several cities to support real-time data-exchange, travel information systems and instant reports of urban issues, related both to street

maintenance, traffic and transport delays, but also to air quality, turning users and vehicles into sources of information. For example, air quality can be continually monitored by cyclists and cross-checked with time, place and weather and gathered data may represent a source of inspiration for taking action (Resch et al., 2011).

Intermodality

This is a first step, but companies, administrators, designers and programmers can do much more to improve the actual situation towards more sustainable and more efficient solutions. To this end, according to a common sense logic, in our future urban mobility we will be increasingly called to combine several means of transport during the same journey. According to this assumption, it is possible to imagine a wider suite of options – including micro electric vehicles for the so-called ‘last mile’ mobility and for rapid transits, as well as other personal mobility devices – to make the conventional transport neither suited nor cost-effective, bridging the gap between public and private transport and creating an intermodal system of mobility. To this end, technologies may be supportive, helping individuals to reduce travel costs, finding travelling companions through carpooling services, while at a broader level, many contemporary cities are quite literally saturated with various sources of real-time data that may help improving mobility experience and influencing demand transport service supply (Amey et al., 2009).

Crossbreeding

In the same way, possible evolutions of actual standards may result from a crossbreeding process of traditional vehicles, merging the best features of each, towards compact and optimized solutions for urban environments capable to meet individual and collective requirements. Every year in the main international motor shows it is possible to notice concept cars that experiment technologies and investigate alternative ways to provide innovative answers to specific urban mobility issues.

Just to mention two examples that hit the market in different years, we have the Smart Fortwo, launched in 1998 and the Renault Twizy, launched in 2012. The first one was the result of a research lasting nine years, focused on providing an innovative compact 2-seaters layout, capable to maximise safety and interior space, designed to fit packed urban spaces, marked by traffic jam and parking scarcity. The Renault Twizy is an all-electric quadricycle, half-way between a car and a scooter, intended to be

individually used and designed for an urban purpose, as it intends to provide an agile and clean solution for short-range daily commutes. Both examples show the growing interest towards innovative solutions in which the vehicle is reduced to a minimum size, in line with its exclusively urban purpose. At the same time, both vehicles are currently applied to flexible car sharing services and may represent considerable solutions for the so-called 'last-mile mobility'.

Sharing

We have to keep in mind two factors: we are in a service economy, and environmental topics are driving the agenda. Considering current trends in big-sized European cities, we can notice how a growing range of flexible car sharing solutions are blooming, like Autolib', Car2go, Enjoy and Zipcar among others. Furthermore, bicycles and bike-sharing services are increasing their presence in city-centres, alongside with a new generation of electric bicycles and other crossbreeding vehicles.

This represents a clear message about the growing interest about shared, flexible and sustainable solutions, many of which are enabled by web-based services, accessible from any mobile device connected to the Net and capable to give birth to real-time data management.

Local peculiarities

In this process we need to keep in mind that great cities have a soul and that their peculiarities, traditions and socio-cultural background affect how people behave and interact. It is therefore necessary to conceive solutions customizable for specific urban environments, capable to provide effective answers to local open issues. Customization plays a key role in the conception and implementation of products and services aiming to improve current urban standards.

Autolib' is an example of car sharing service, inaugurated in Paris in 2011, deploying all-electric Bolloré Bluecars, specifically conceived and developed to be applied to this service.

Collaboration

As introduced above, cooperation and bottom-up approach make it possible to subvert traditional habits, turning potential users into active actors in the value-creation process towards sustainable behaviours and efficient services. The **collective creativity** (CC) may be used by car manufacturers and technological companies to enhance the design practice,

showing how the most creative outputs can result from social processes involving many individuals (Amabile, 1996; Fischer, 2004).

Almost any object can tell a story and there is an even richer seam to be mined as people are invited to engage themselves, provide their opinion and eventually work together. As underlined by Fagone (2012), a striking example of such direct involvement is represented by the participatory approach adopted for the Fiat 500 project. To this end, Fiat Automobiles created a well-structured communication project called '500 Wants You', based on a multimedia platform mixing marketing and design tools, to involve people – ranging from users, brand supporters and other representatives – in order to collect useful feedbacks and suggestions for designers, engineers other stakeholders, in order to adjust and enhance the project.

Connections

Information and communication technologies are expected to play an increasing role in the coming years, redefining well established manufacturing standards and traditional design principles, as embedded web-based technologies get cheaper and allow real-time data exchange and communication with intuitive gestures.

According to the study by Wellman (2001), the individual becomes both an economic and a symbolic capital and since 1990s, with person-to-person communities, the person has become the portal, being connected even while on the move.

We need to transfer this potential to future vehicles, connecting the user/driver with the surrounding spaces and with other vehicles, thus creating an efficient and **interactive network**. In this vision, experts tend to focus on making transportation more intelligent by creating a networked infrastructure in which cars and other vehicles can exchange information in an ad-hoc mode. To this end, customers need to know and share as much information as possible; but delivering useless data may gradually become 'noise'. It is therefore crucial to find a balance between individual requests and community-oriented design, using context-aware applications, participatory sensing, user-generated content and social networking applications. As suggested by Büscher et al. (2009), acting this way, it is possible to optimize services and get suggestions for the improvement of informed travel systems, capable to drive customers towards smart decisions.

Several concepts every year show technological improvement about connecting equipment for cars. As a matter of fact, technology companies like Android and Apple, are working hard to refine technologies to provide systems for in-car connectivity systems capable to 'mirror' and expand users' digital life and connectivity potentials. The resulting cleverer vehicle, capable to communicate with other cars and to provide a wide set of directions about trips and surrounding places, is just one of the possible demonstrations of how web-based smart technologies can connect individuals and create responsive and collaborative networks.

Self-driving

Furthermore, an increasing amount of studies is pushing the boundaries to provide in the next future more intelligent and autonomous vehicles, less relying on human involvement or even not needing a driver at all (Buehler, Lagnemma and Singh, 2009). This is a really exciting opportunity entailing big consequences on future vehicles perception, as well as debates about limits and potentials related to their use. They may in fact turn into a sort of 'mobile spaces' in which ICT may support communication and interaction with other vehicles and surrounding spaces, allowing users to work and relax while on the move, instead of simply drive.

Future cars for personal mobility may come to be dwelt within very differently in the next decades, with almost untold consequences on urban life and consequently on the relationship between individual and community. Car manufacturers are constantly at work on various micro-cars capable to provide innovative answers to commuting needs. Urry (2006) underlines how 'the evolution towards smaller, lighter, smarter, information-rich, communication-enhanced vehicles better integrated into the public transport systems and public spaces' will not include telecommuting as a key feature to transforming urban life, since current trends 'suggest that many people want to engage in communication simultaneously with locomotion'. It is therefore increasingly crucial to provide vehicles capable to improve the actual urban situation merging a private and a public dimension. This is an essential step in the way we conceive infrastructures and services, towards a revolution in urban mobility, influencing the way we perceive technologies and products, as well as our lifestyle and sense of community (Argante, 2010).

8. Conclusion

Technologies are becoming more and more pervasive in the urban environment, creating responsive spaces labelled as 'smart' cities in which feedback loops enable connections between the environment, people, products and administrations. Municipalities are called to take actions to provide citizens better and more sustainable spaces but, as technologies are becoming more and more pervasive in the urban environment, it is also mandatory to have ultimate technologies and efficient connections to allow citizens to interact, communicate and exchange information. To this end, Web-enabled networks are gaining a growing relevance in the contemporary society and several studies tend to underline the crucial role of collaborative patterns, capable to exploit ICT as supportive equipment and to involve citizens in the value-generation process, towards striking solutions capable to improve the quality of urban life. These may range from web-based platforms to online applications for mobile devices. However, when people are called to share the same urban spaces, possible conflicts may arise, because of the discrepancy between individual interests and collective needs.

Social life becomes therefore a sort of deal, according to which the individual tendency to stand out and the collective needs towards social equality try to find a balance Simmel (1904). This is particularly evident in the field of urban transport that represents a knotty problem for crowded cities, requiring a total commitment to find effective solutions.

Even if it is too early to define with certainty the future of urban transportation design, it is possible to understand how pervasive ICT together with flexible and shared solutions, meant to provide answers to the individual desire of personal transport, will have to coexist with more 'traditional' public transport. Striking solutions for citizens' everyday commutes may be individually used, owned, rented or shared, optimizing space and power consumption, minimizing their environmental impacts and integrating pervasive technologies, thanks to which users can actively participate as 'sensors' (Büscher et al., 2009).

The future car industry will have to be coherent with his own past, but also carefully concerned with users' and brand's requirements, like safety and customization issues, as well as environmental constraints, like clean energy use and integration with other forms of mobility. The result will be a wide range of vehicles supporting more sustainable behaviours and reconciling personal mobility demand with collective requirements in an integrated intermodal mobility for our future metropolitan areas.

References

- Amabile, T. (1996) *Creativity in Context*. Denver: Colorado Press Association.
- Amev, A., Liu, L., Pereira, F., Zegras, C., Veloso, M., Bento, C. and Biderman, A. (2009) State of the Practice Overview of Transportation Data Fusion: Technical and Institutional Considerations. *Transportation Systems-Working Paper Series*, Paper# ITS-CM-09-01.
- Argante, E. (2010) *L'Auto che Sarà. Il Futuro della Mobilità*. Milano: Egea.
- Bauman, Z. (2005) *Liquid Life*. Hoboken: Wiley.
- Buehler, M., Iagnemma, K. and Singh, S. (2009) *The DARPA Urban Challenge: Autonomous Vehicles in City Traffic*. Berlin: Springer.
- Büscher, M., Coulton, P., Efstratiou, C., Gellersen, H., Hemment, D., Mehmood, R. and Sangiorgi, D. (2009) *Intelligent Mobility Systems: Some Socio-Technical Challenges and Opportunities*. In Mehmood, R., Cerqueira, E., Piesiewicz, R. and Chlamtac, I. (eds.), *Communications Infrastructure: Systems and Applications in Europe. Lecture Notes of the Institute for Computer Sciences, Social Informatics and Telecommunications Engineering*. Berlin: Springer.
- Elliott, A. and Urry, J. (2010) *Mobile Lives*. Abington. Oxford: Routledge.
- European Commission (2011) *White Paper on Transport. Roadmap to a single European transport area — Towards a Competitive and Resource-Efficient Transport System*. Luxembourg: Publications Office of the European Union.
- Fagone, E.L. (2012) *Car Design, Genesi ed Evoluzione del Design Automobilistico*. Bologna: Editrice Compositori.
- Fischer, G. (2004) *Social Creativity: Turning barriers into opportunities for collaborative design*. Paper Presented at the Proceedings of the Participatory Design Conference (PDC 2004), University of Toronto, Canada.
- Glaeser, E.L., Kahn, M.E. and Rappaport, J. (2000) Why Do the Poor Live in Cities? The Role of Public Transportation. *Journal of Urban Economics* Volume, 63 (1), 1–24.
- Greenfield, A. (2006) *Everyware: The Dawning Age of Ubiquitous Computing*. Edinburgh Gate: New Riders Press.
- Hemment, D. and Townsend, A. (2013) *Smart Citizens*. Manchester: Future Everything.
- Jenkins, H. (2006) *Convergence Culture: Where Old and New media Collide*. New York: New York University Press.
- Jenkins, H. (2009) *Confronting the Challenges of Participatory Culture: Media Education for the 21st Century*. Boston: MIT Press.

- Lévy, P. (1999) *Collective Intelligence: Mankind's Emerging World in Cyberspace*. Toronto: Perseus Books Group.
- Maher, M.L., Paulini, M. and Murty, P. (2010) *Collective Intelligence and Design Thinking*. Paper Presented at the Design Thinking Research Symposium 2010, Sydney.
- Murray, R., Caulier-Grice, J. and Mulgan, G. (2010) *The Open Book of Social Innovation - Social Innovation Series: Ways to Design, develop and grow social innovation*. London: The Young Foundation.
- Palis, C. (2012) *Jack Dorsey On 'Charlie Rose': The Best Tech Disappears*. Retrieved from: http://www.huffingtonpost.com/2012/04/27/jack-dorsey-charlie-rose_n_1459400.html [accessed on: 25th November 2014].
- Preece, J. and Shneiderman, B. (2009) The Reader-to-Leader Framework: Motivating Technology-Mediated Social Participation. *AIS Transactions on Human-Computer Interaction*, 1 (1), 13-32.
- Resch, B., Calabrese, F., Ratti, C. and Biederman, A. (2008) *An Approach Towards a Real-Time Data Exchange Platform System Architecture*. Paper Presented at the Proceedings of the 6th Annual IEEE International Conference on Pervasive Computing and Communications, New York.
- Resch, B., Lipson, S., Bers, J. and Ratti, C. (2011) Integrated Urban Sensing: A Geo-sensor Network for Public Health Monitoring and Beyond. *International Journal of Geographical Information Science*, 26 (12), 2239-2251.
- Resch, B., Britter, R. and Ratti, C. (2012) *Live Urbanism – Towards Senseable Cities and Beyond*. In Rasia, S. and Pardalos, P.M. (2012) *Sustainable Environmental Design in Architecture. Impacts on Health, Springer Optimization and Its Applications*. New York: Springer.
- Shepard, M. (2009) *Curatorial Statement*. In Shepard, M. (eds.), *Toward the Sentient City Retrieved*. New York: Architectural League.
- Shepard, M. (2011) *Sentient city: Ubiquitous Computing, Architecture and the Future of Urban Space*. New York: Architectural League.
- Simmel, G. (1904) Fashion. *International Quarterly*, X, 130-155.
- Urry, J. (2006) Inhabiting the Car. *The Sociological Review*, 54 (1), 17-31.
- Weiser, M. (1991) The Computer for the 21st. *Scientific American*, 265 (3), 94-104.
- Wellman, B. (2001) *Designing the Internet for a Networked Society: Little Boxes, Glocalization and Networked Individualism*. In Tanabe, M., Van den Besselaar, P. and Ishida, T. (eds.), *Revised Papers from Second Kyoto*

MARCO ZILVETTI, FAUSTO BREVI

Workshop on Digital Cities II, Computational and Sociological Approaches.
London: Springer.

Wellman, B. (2001) Physical Place and Cyber Place: The Rise of Networked Individualism. *International journal of urban and regional research*, 25 (2), 227-252.

Whitelegg, J. (1993) *Transport for a Sustainable Future. The Case of Europe.*
London: Belhaven.

SECTION IV

Aesthetics, Narration and Critical Design



Narratives and the co-design of spaces for innovation

Valentina ANZOISE^a and Stefania SARDO^b

^a Ca' Foscari University of Venice; ^b BI Norwegian Business School

In any process oriented to foster innovation, its designers have to face complex foresight horizons due to unforeseen changes that can occur in the space they are seeking to transform. This is both because of the transformations they induce with their actions, and because of those happening in the broader context their activities are embedded in. Socio-cultural innovation in particular involve many cycles of feedbacks, and we can argue that it is 'nothing but a story of negotiations structured by rules structured by negotiations' (Lane et al., 2009) among social agents over alternative attributions. In this sense it is always directly and indirectly co-designed and co-produced, triggering cascades of transformations in the agent-artifact space in which it is introduced. Given this complexity and uncertainty, it is almost impossible for any project team to exhaustively design processes and settings related to the envisioned innovation, able to encompass all the possible variations that could happen (such as the emergence of new agents, attributions, artifacts and interaction modalities), which in turn influence and depend on constantly evolving interactions. This contribution focuses on the proposal for a new approach to evaluation¹ supporting process design and management. Such an approach has been developed and partially tested in the context of a number of social innovation projects, including a one-year project based in Southern Italy and funded by the Italian Ministry of Environment, which we use as our lead example.

Keywords: Innovation management and evaluation; local development; complexity; cascades of transformation

* Corresponding authors: **Valentina Anzoise** | e-mail: valentina.anzoise@unive.it

¹ Dynamic Evaluation approach has been designed within the EU project 'Emergence by Design' (MD, FP7- GA n. 284625): www.emergencebydesign.org coordinated by the European Centre for Living Technology. Its outcomes have been informed by the theory, and the theory has been informed by the experience of consortium partners immersed in the world of relevant practice and engaged in social innovation projects.

Introduction

In order to discuss which could be the possible configurations and conditions enabling or preventing the full deployment of innovation processes², we will analyse a specific local development project, which is not intended to be representative of all kinds of innovation processes but in fact it proved to be useful to point out some general and relevant aspects about the connections among project design, management and evaluation.

The *Green Communities* project – funded by the Italian Ministry of Environment and run in 2012 - showed some of the uncertainties that a project has to tackle, starting from the design of the setting, the activities and roles of the organizations involved, the resources needed.

One of the hypotheses is that the composition of the management and project team and the interaction modalities adopted – especially in the preliminary and early stages of a project – are crucial. Indeed, they can set some conditions which enable individual and collective agents³ action and learning, so as to better respond to changing and complex horizons⁴.

We will analyse the Green Communities project adopting the perspective of Dynamic Evaluation (DE). DE is an approach⁵ intended to support the enhancement of collective capabilities (Sen, 1993) through distributed design and organizing, so as to be able to deal with the inherent variability, complexity and ‘ontological uncertainty’ (Lane and Maxfield, 2005) characterizing innovation projects (Patton, 2011).

Nonetheless, DE assumes that agents, regardless of the difficulties in imagining and even naming the future transformations of the space they are acting in, decide to act according to the *generative potential of relationships*

2 By innovation we mean ‘a set of processes, extended in time, which involve the construction of new agents, artifacts and attributions – and new kinds of relations among them’ (Lane and Maxfield, 2005). More specifically we refer to those innovations performed by human sociocultural organizations which, differently from biological systems, are self-reflexive and self-modifying. For these kind of organizations negotiation processes can lead to transformations in organizational structure and functionality, including the essential activities of recruitment, differentiation and coordination (Lane, 2009).

3 By agent we mean ‘an organization of human beings and artifacts, in the name of which social action is initiated and executed’ (Lane et al., 2009, p. 26).

4 The approach proposed here shares some of the assumptions and aims of Developmental Evaluation as well. As stated by Patton ‘the evaluator becomes part of a design team helping monitor what’s happening, both processes and outcomes, in an evolving, rapidly changing environment of constant feedback and change’ (1994, p. 313).

5 Such an approach to evaluation and the corresponding methodology started to be explored, named and outlined within the MD project.

(GPR) they perceive (Lane and Maxfield, 1997). The components of *generative potential of relationships*, as defined by Lane and Maxfield (2005) are: a sufficient level of *heterogeneity* among agents, i.e. agents have to be not too much different, otherwise they won't be able to understand each other, but at the same time enough diverse to enrich and 'shake each other'; reciprocity and mutual willingness to collaborate (*mutual directedness*) in the transformation of a common zone of the agent-artifact space (*aligned directedness*); adequate *permissions structures* determining what agents can communicate about, with whom, in which modalities; and *joint action opportunities*.

Therefore, the DE methodology envisages an evaluation imminent in and inherent to the process, able to dynamically return to project participants information and interpretations (i.e. narratives, as they also are accounts of accounts, or interpretations of interpretations) regarding what is happening in the project and which narratives participants are enacting and are embedded in⁶. This iteration (feedback loop) should allow agents to reflect in a more systemic way on the changes that are taking place, and on how it could be possible to make further adjustments to the process in such a way to enhance the *generative potential* of relationships.

Succinctly, DE aims and tasks are to:

- detect and monitor relationships, so as to map the transformations occurring in the context in which agents and artifacts are embedded in (i.e. the project agent-artifact space), and explicit this knowledge to them;
- systematically collect, elicit, map, further analyse and provide feedback regarding participants' narratives and perceptions; and alert eventual divergences that might be arising. This should stimulate the project's participants self-reflection and deeper and broader understanding of the processes they are involved in. Moreover, this will make accessible and distributed the 'perception' of the generative potential of relationships, setting the conditions for agents to act co-ordinately, thus disclosing and enhancing the possibilities provided by the joint action opportunities already set (or that can be set);

⁶ Enacted narratives are actions constructed and undertaken discursively (Czarniawska, 2004; Pentland, 1999), coherent with individual and collective narrative logics, which allow individuals to make sense out of what is happening, communicate one each other and face ontological uncertainty.

- develop narratives that describe the different points of view and provide timely feedback to participants, including a final project narrative that make sense, even retrospectively, of what happened.

Even if we might agree that innovation processes should deploy in a plurality of spaces (e.g. virtual and physical or different for size and social groups engaged), managing and supporting them is other than trivial. Narratives, which permeate all these spaces, and which do not just relate, but also explain and constitute reality, are the privileged analytic tool used by DE.

1. How to continuously configure plural spaces of innovations? Setting the enabling conditions

Hereafter we propose a set of conditions and issues that have to be adequately considered when setting up a project, especially when innovation is addressing a public issue, and therefore the 'client' is the community (as in local development projects). Similar considerations can be applied also to private organizations, especially when they are paving the path towards strategic changes, which will entail considerable transformation in roles, routines and norms, knowledge construction and sharing processes.

1.1. Building the project team

A first issues is how to select and engage the 'right' agents, especially those who are, at least initially, part of the core team, having the 'burden' to frame project's main activities and interaction modalities. With respect to the generative potential of relationship outlined above, we might say that the team inner *heterogeneity* is crucial, and it should refer not only to technical competences and soft skills relevant for *that* specific project, but also to other variables (e.g. gender and cultural background).

Moreover, since the challenging nature of these processes could put into questions even people self-identities, it is not sufficient to have competent and rigorous agents, but also people having an attitude towards dialogue, towards the empathetic understanding of others' feelings and conditions, and a capability to proactively respond to uncertainties.

In addition, the value the team will attribute to its 'constitutional' process (which could last years), more than just to the final outcomes, is crucial. The acknowledgment that an organization has more transformative

and generative capabilities than those of the single individual, the possibility of continuous and mutual learning, and a clear willingness to invest in the team are somehow mandatory. Not only this enhances the empathy among agents and the openness to recognize, understand and hopefully incorporate others' points of view and ways of acting, but it primes a reciprocal flow of value, which fuels and renews alignment about the broader vision and aims.

The project team's relationships can sediment and intensify in time since their main gain derives not from the fact that they provide knowledge and services to others, adequately paid, but that they will 'earn' greatly from what – tangible or intangible - the team, or the broader community, will produce. Something a single agent cannot achieve.

This also means that, as long as the project develops and other agents and organizations join it, these conditions have always to be recalled and questioned. They have to be shared with the newcomers, and eventually adapted and renewed according to the increased heterogeneity of the team, not just mechanically transferred. This comes from the fact that they deal with values, strategic objectives, work modalities, and valorisation of roles and synergies.

Further requirements for building a project team are: the inclusion of figures adequately trained/experienced in taking care of the project structure (i.e. identification, recruitment and monitoring of required roles and functions, roles' coordination, management of the team enlargement, etc.), and a broadly shared agreement on the *permissions' structures*, that can be re-discussed and redefined at any time, but that - till then – regulate the team's interactions, commitment and its acknowledgement of each role's relevance.

1.2. 'Making phase' and design of projects

Once the core of the project team is set up – even if it isn't still formalized and can at any time be enlarged and adapted – further precautions are needed. At the preliminary and early stages (i.e. the *gestation* of an idea that then will turn into a project), in fact:

- Project contents and goals (i.e. tangible and intangible artifacts or processes) are still not enough elaborated, they may be vague or too much restricted;
- Diverse agents have been recruited assigning them different roles; but, on the one hand, it is not clear whether they are the most adequate for

that specific project, for its vision(s) and for the envisioned team; on the other hand, other agents and roles could *emerge as necessary*;

– The set of intertwined processes tackling the targeted issue are underspecified or not identified yet.

For these reasons, *opportunities of joint action* and reflection have to be set up and run, since the team commitment should be grounded also on the perception of a shared understanding (common vision) and willingness to risk and invest together in the same ‘venture’ (i.e. *aligned directedness*).

Agents participating to this challenging but constructive phase should be aware of the fact that its success has a trade-off: the call into question of their own identities and ideas, which needs to be combined with a sort of distributed managerial and entrepreneurial attitude to risk and experimentation, as well as perseverance and resolution. These attitudes should be stimulated over time⁷ since these projects are aimed at finding possible, viable and constructive alternatives to otherwise detrimental conditions or dead-end streets, requiring in some cases radical mindset’ shifts (cultural, technological, organizational).

1.3. Enacting the project: open configuration and plural settings

Once a sufficient amount of resources (infrastructural, financial, cognitive and relational) have been made available and the project is launched, new kinds of uncertainties may arise, deriving from the confrontation with the context in which it is implemented. In fact, a project does nothing but ‘disturb’ an area of already sedimented relationships, because it re-assigns identities, defines new relationships and changes the relative importance of others, sets new rules, etc.

These perturbations can produce emergences in the form of the opening/closing of spaces of interactions, i.e. agent-artifact spaces (Lane and Maxfield, 1997, 2005), followed by the appearance, disappearance and transformation of agents, artifacts, interaction modalities.

However, the negotiation capability and the readiness to adaptively respond to these changes, whether they are opportunities or threats, are related to the project’s structure and to the ability of the team to detect, understand and manage them.

⁷ Either from agents formally in charge of this task and from participants themselves.

This inevitably reopens the design of the process, and its spatial, temporal, relational, material and value configurations. Meaning for instance:

- Introducing new artifacts (tangible/intangible) and agents (identity and roles) that were not even thinkable before, or transforming those already in place;
- Resizing objectives, activities, resources;
- Re-formalizing permissions to act;
- Developing, configuring / reconfiguring patterns and formats of action and communication (internal/external).

2. Taking the advantage of the evaluation process

According to what has been outlined above, what we want to recall here is that the evaluation process should be considered in its intrinsic meaning of *giving value*, and not just a mere assessment or 'judgment' with no added value for the project team and those directly/indirectly involved in it. Evaluation is a process that could help to re-open spaces of design, allowing the questioning of project's configurations any time it is required to.

The DE approach aims at enhancing project participants' reflexivity through the use/making of a combination of different approaches and techniques (e.g. interviews, network analysis, narrative analysis, participatory and co-design techniques), whose triangulation allow to access, process and analyse different kind of information and perspectives, even those that haven't been foreseen in the project 'gestation phase'.

What we claim here is the need for an evaluation which is dynamic and developmental with respect to the processes it is applied to, and that pays a particular attention to narratives, considered as privileged hermeneutic units of analysis for studying social change and action (Anzoin and Sardo, 2013). Narratives are the 'most widely used forms of organizing human experience' (Bruner, 1991, p.9), and provide thick but synthetic information that can facilitate the understanding of agents' actions, their motivations and the way they give meanings to the reality they constantly construct.

Narratives are especially relevant to the analysis of organizational processes because people do not simply tell stories, they also enact them: that is why they are not just a form of representing, but also of constituting reality (Bruner, 1991). Moreover, stories provide legitimacy and accountability for people's actions (Czarniawska, 2004; Pentland, 1999), and respond to a *narrative logic* that allows individuals to make sense out of

what is happening around them, and to act - in the face of the challenges and uncertainties that arise in the context - consistently with their expectations and values.

Indeed, we might say that narratives matter a lot in 'designed' or intentional action. Primarily because they are a medium of communication and they perform a *sensemaking* function (where *sensemaking* also refer to the crucial role of structuring the unknown), and then because they offer the basis – a sort of 'driving force', a resource available - for action in the face of ontological uncertainty. Narratives help agents to explain the correlation among events in a process, and to encode data that are relevant for a wide range of organizational phenomena (even if their interpretation differ from agent to agent): 'in the same way that surveys contain indicators for the underlying constructs in a variance theory, a narrative text contains indicators for an underlying process theory' (Pentland, 1999, p. 711).

Nonetheless, narratives are absolutely non-trivial objects, either to collect and elicit, or to analyse and feedback. To succeed in explicating dominant, hidden or emerging narratives, and in coding and comparing them with the narrative structures shared by that narrative community, not only 'all' the values involved and the 'usable knowledge' available (Fareri, 2009) to the project team should be considered, but these values and knowledge should also be included and activated so as to grab the project purposes.

Indeed, DE also assumes that, as the project goes on, a progressive inclusion of agents, directly and indirectly affected by it, will have to be managed and their values considered. Therefore, the availability of a shared knowledge will be more than valuable and on target, and a project team joint agreement on the necessity to integrate and make available to participants – even with some differentiations – the outcomes and feedbacks of such an evaluation, should contribute in making the project a fully and shared learning environment.

At the same time, evaluation isn't effective and incisive if implemented and integrated within a rigid and 'blind' organizational structure: the project structure should be solid but flexible, able to adapt enough rapidly to changes, modifying its activities and conceiving the emergences of new roles, instruments, visions, and therefore open to embrace the iterative feedback loops coming from the DE.

2.1. Dynamic Evaluation and project design configurations

The conditions outlined up to here require a reconceptualization of what we mean by project and by project design configurations, the former being more related to the *experimental character* of the processes undertaken (somehow to its etymology of 'throwing ahead'), the latter to a necessary evolution in project activities' organization and relevance. Therefore, we claim that projects should fold in them an ongoing evaluation (i.e. Dynamic Evaluation) aimed at setting up and questioning the necessity of opening up further spaces of re-design and learning. The price to pay for whichever organization for not being enough receptive and adaptive is necessary a blind alley.

The introduction of the Dynamic Evaluator (DER) role within the project has to be declared and acknowledged by everyone: adequate spaces, permissions and timely action opportunities have to be provided, either the evaluation can be carried on together with some internal figures (directly involved in some of its tasks) or not.

The feedbacks the DER will provide will be returned/ given back in different ways and timing, according to the stage of the project, participants' characteristics, etc. As an example, through the analysis of the data gathered from different sources, a DER should be able to detect and make explicit 'disrupting narratives' (e.g. underlying narratives which can strongly affect the 'original' narrative the project is willing to instantiate) that could mine the project deployment or, on the contrary, make it take wing.

Participatory techniques, e.g. Open Space Technology, Scenario workshops, World Cafés, Public Debate, Collective deliberation (online and offline), could be useful, as it is not a matter of winning upon the opponent, but instead of taking decisions collectively and putting them into actions. At this point, the new and synthetic narrative, resulting from this reflexive process, is supposed to be perceived as correct and coherent by 'all' participants, and it will be the 'inner force' in some ways motivating their actions related to the project.

We should keep in mind that an everlasting narrative doesn't exist: it will remain approximately stable (with small increasing changes in time) until when it will be accepted as a common frame to position and support coherently participants' particular narratives.

Notwithstanding, narratives are not 'enough' to drive changes: dominant discourses are inscribed in societal institutions, texts, settings, behaviours

and material culture, giving them enormous advantages, and alternative discourses could remain marginalized (Witkin, 2010).

Hence, the role narratives play is multifold: they are ‘thick’ objects of analysis and tools that can enhance reflexivity by generating feedback loops that can nurture projects’ design and its progressive inclusiveness. They also have a ‘dark side’: since each group’s narrative privileges some voices and silences others, they are exercises of power. Finding the silent voices and revealing the different values as well as the sources of power constitute one purpose of narratives’ deconstruction (Martin, 1990) which should be always considered in evaluation protocols.

To facilitate this delicate task, within the MD project we have been designing and implementing the DE methodology but, parallel to the case study conduction, which worked as a tester of the adequacy and robustness of the theory, we have been also designing an ICT toolset to support DE.

Well aware that technology won't provide solutions for all the complex issues that still remain open for further research, we co-designed this dedicated theory-based toolset to bear at least: the *systematic collection and storing* of information which progressively enlarges the project's available base of data; the *mapping of the project agent-artifact space*; the *encoding of narratives*; the *participants' generated stories collection*; the *drawing and visualization* of instantiated narratives and narrative structures⁸.

3. Case study: the Green Communities project

The Green Communities project (www.greencommunities.it) was funded by the Italian Ministry of Environment through EU funds specifically devoted to Convergence Regions, and supported by the National Association for Municipalities and Mountain Communities (UNCCEM).

The official main aim of the project was to promote the constitution of sustainable communities, able to efficiently manage energy and other local resources. The call prioritized three main actions: feasibility studies for the energy efficiency of buildings, feasibility studies for the sustainable

⁸ Even if we do not have enough space to go into further details, suffice it to say here that among the MD tools – a Repository and a Clipping Tool connected to a Database that allow also to perform Social Network Analysis, etc. – we have been developing a Narrative Modeling Language (namely A4 Language, which stands for Agents, Artifacts, Attributions and Actions), which allow to graphically visualize the elements and relationships contained in the Database (but also integrate natural language) so as to allow the identification of patterns (i.e. narrative structures) and their matching with the narratives ‘really’ enacted by participants.

management of forests, and broader territorial audits. The project also included the first draft (a prototype) of a rating system to assess the sustainability of a territory according to some dimensions (e.g. mobility, waste, tourism, welfare, etc.). Nonetheless, according to the scientific director of the project, the definition of the guidelines to design the rating system was the first and crucial output to be achieved⁹. In his opinion, these guidelines were necessary to provide the mayors of mountain communities of a tool (i.e. the rating system) 'supporting their change of role into local development agents', able to design strategies of socio-economic development coherent with the identity and values and the resources available in their territories.

Four mountain communities of Southern Italy were selected as pilot territories. In addition to the management team that formally ran the project, i.e. the project manager, the administrative manager, the scientific advisor and the steering committee, the other agents involved were: a dozen of technicians with specific expertise (i.e. three of them responsible for the main actions addressed by the project, and the others with sound expertise relevant to draw the guidelines needed for the rating system development); at least three local technicians per mountain community (i.e. usually a construction engineer/an architect; an agronomist/a forest expert; a coordinator, expert of the territory as a whole). Local technicians, together with one (or more) political representatives, constituted the local groups.

Before commenting the GC project highlighting which spaces of innovation (or for further design) had been opened and which not, and how certain issues have been tackled, it might be interesting to start with a statement the project scientific advisor made. His reflection, even if retrospectively – and regardless of it – gives interesting hints on the project 'original' directedness. '[The project was] a local development project. The project was aimed at designing 'green' local development policy in areas characterized by woodlands and fields, ideally led by coalitions of mayors (...). This is what I have been working on from the beginning to the end, but the results haven't been that good (...). Actually, the point is that the mayors we interacted with, while expressing their willingness in changing their role and becoming 'development agents', able to manage integrated and sustainable communities, barely rallied and almost struggled to recruit local agents belonging to [what I define as] the 'productive classes'.

⁹ i.e. what we refer to as the directedness of an agent.

3.1. *Team Building, making phase and design of a project*

A premise is needed. The 'gestation phase' of the GC project begun several years before its formal start: the first ideas on ways to support local administrations in tackling the dramatic conditions of rural and mountain areas, through the promotion of the development of sustainable and coherent policy, emerged within a small group of people. This group - tied by friendship relationships and previous collaboration experiences – spent almost two years sporadically meeting and participating in formal and informal discussions, which lead to the writing of some contributions introducing this new *narrative* into public discourses (e.g. a Manifesto, books), and to the submission of a project for a Ministerial call (i.e. these are examples of what we have previously referred to as *joint action opportunities*, one of the main component of generative potential of relationships).

When the possibility to get the funding from the Ministry of Environment became real, the group initial idea had to be adapted to the formal requirements of the call, which inevitably resized its goals, activities and roles.

Nonetheless, when asked to describe this 'gestation phase', some participants recall that at the time of building the project team, no one had expressed (or even conceived) the necessity to have specific figures dedicated to accompanying and better funnelling it together with the whole implementation of the project, and not just to the proposal writing and the negotiation phase. In addition, more attention to the construction and strengthening of the project structure (i.e. its organization) would have been crucial. Indeed, most of the people – those sporadically involved in the previous years and contacted again - had a clear idea of how the discussion on those issues went on. Moreover, there was almost no time dedicated to check if the alignment on the broader vision of the project was shared among those technicians hired later to work on the rating system¹⁰.

A further remark concerns both the technical competences and the soft skills required to accomplish some key passages, and the system of governance that could have funnelled the best human and material resources, from the project conception to the delivery of the outcomes.

Administrative figures - who normally know well the bureaucratic language

10 i.e. what we referred to as the necessity, not to assume and take for granted but to monitor and support the alignment of the project team directedness – which the whole project structure should be imbued with -, especially if the process is long, fragmented and other people get involved or are recruited, etc.

(and its formal constraints) that should be used (in particular during the negotiations with the clients) and are able to mediate between what has been envisioned and what can *realistically* be done – should have co-designed the project together with its ‘authors’ from the very beginning. As recalled by one of the technician responsible of one of the main project actions ‘The lack of well-established habits and dialogue among certain linking roles had undermined the course of the project, paving the way to misunderstandings and drawbacks that otherwise could have been – at least partially – prevented’. This comment, given one year after the end of the project, highlights the fact that heterogeneity is always project-specific, and reciprocity and willingness to collaborate (i.e. mutual directedness) must be constantly nurtured.

3.2. Enacting the project: open configuration and plural settings?

Once the project was on track, the centralized and not-so-flexible structure, the low heterogeneity among participants, and the mismatch between assigned, enacted and perceived roles, hindered the possibility to re-open spaces of design and therefore to find management alternatives, possible mediations or adjustments to unexpected conditions and drawbacks. As an example, the project saw the relieve and change of some key roles charged of expectations and taking upon themselves the accomplishment of crucial - written and unwritten – agreements.

Again, concerning the management of the project, some of the participants highlighted how important would have been that some key figures in the project team had a stronger managerial attitude, which is a broad capability one should consolidate through experience, and that cannot be created from scratch. As a technician said, during an interview, ‘You have to establish and constantly renew a good feeling with people and institutions, otherwise you won’t carry the project on well. You have to know how to mend relationships, you have to know how to recover’.

Moreover, the lack of a facilitator(s) and/ or of a general coordinator mattered a lot, especially if one considers non-linear activities, such as the outline and development of the guidelines for the rating system prototype. Such a role was only lately introduced in the project, without an adequate consideration of the importance of previously sharing, with the already involved agents, its role and activities. The underestimation of this ‘design mistake’ delayed (or even precluded) the other participants’ recognition of its relevance and the effectiveness of its delicate tasks, e.g. starting a

reasoning on sustainability to drive people in making a paradigmatic shift in the way they looked at their specific expertise, at the same time conveying individuals the augmented value that would have resulted from the synergy of their concrete contributions. These values – fundamental to consolidate an alignment still very loose – would have needed more time to take root and feedback. Moreover, in this already complex and highly fragmented situation, budget constrained further opportunities of joint action that would have been needed.

Another underestimated activity was communication, both internal and external. The person in charge of the website and of the social networks interrupted its collaboration during the course of the project and wasn't replaced. In addition, none had ever had the task to take care neither of the internal communication, nor of the construction of a larger network. The role that communication could have played to widen the spaces of design was not sufficiently exploited, and the use of ICT tools (e.g. Dropbox, emails, Skype) to facilitate the outcomes delivery didn't constitute a common workframe for all the components of the team¹¹ - despite they had been efficiently used by the responsible of one of the subgroup.

3.3. Dynamic evaluation and the generation of iterative feedback loops, what could have been done?

Although the GC project had formally scheduled an evaluation activity, this was not integrated with the implementation of the project, and therefore it did not contribute to test and possibly readjust the adequacy of the project design and its subsequent implementation. The question we want to raise here is: what is the value of an evaluation that comes at the end once the opportunities have passed away and the resources have been misused or ended? The added value of an evaluation process should be also that of re-opening the space of design, better funnelling emerging situations, and supporting the facing of unexpected events.

Concerning our research activities, thanks to the MD project we had been able to observe the GC project as a case study to learn from and from which to start designing a new approach to project evaluation aimed at fostering innovation and steering emergence; but we hadn't the chance to really act as dynamic evaluators.

11 The two last considerations show how little attention have been given to narratives, as medium of communication and as performing a sensemaking function, and therefore to the need of figures in charge of them.

Even though we managed to tie trust relationships with some of the participants, and to collect the narratives on what was happening both within the core team and within the local communities, there weren't either agreements to guarantee our autonomy of action. Even if we provided constructive feedbacks to some participants, they were episodic, as we didn't have at our disposal adequate settings for action (and couldn't ask for them, because of a lack of permissions, which meant also that we had access only to certain information and certain point of views!). On the other hand, we were at the first stage of the DE development (as well as of the MD project), so we hadn't either the toolset ready or even designed differentiated ways to scaffold and share feedbacks loops.

Moreover, the way the project was run and decisions undertaken within the project team was somehow blurred, and just few information were shared among all the participants.

Since DE requires some minimal conditions of trust and permissions to set spaces for sharing results, experiences, meanings, none of the results of our engaged research activity could have ever had the chance to be systemically exploited.

In any case, through the analysis of information collected from different sources (e.g. interviews, informal talks, emails, formal/informal documents, etc.) we were able to detect three narratives under deployment that were undermining the 'happy' deployment of the project: the *Triumvirate*, the internal 'fight' among the managing team components on the correct interpretation of the project vision and implementation (i.e. the directedness was no more aligned and mutual); the *Magic Artifact*, originated from the acknowledgment of a broad and firm and ideological belief in technical solutions to solve problems, and in the capability of expert knowledge to provide the right frame to analyse any complex object¹²; the *Missing Bottom*, pointing out the lack of communities' engagement even in a project supposedly aimed at stimulating local agents (individuals and organizations). The lack of reflexivity impeded the project team to rethink the main target of the project and, eventually find the way

12 Three are the key presuppositions embedded in this narrative structure_ 1. that social problems can be converted into technical problems, second that, through the application of technique by relevant experts, technical problems are resolvable, and third, that technique compels conviction; this endows artifacts linked to technique (the technical problem and the technical artifact) with the capacity to drive the society-wide (i.e. in this case the Mayors, since the technical artifact was addressed mainly to them) attributional alignments.

to involve other relevant agents (and their values) that could have been directly or indirectly impacted by the project.

Once detected, these narratives should have been shared to enhance self-reflection among participants, to create bridges and spaces for mutual understanding, if not agreement, even among very different normative worlds (Mittica, 2010). If we have had different conditions, the role of DE could have been that of providing lateral thinking and alternative perspectives, highlighting agents' narratives, possible misalignments and/or diverging interpretations and attributions, lack of mutual trust and of adequate joint action opportunities. This feedback could have been used to adjust and re-elaborate the project strategy and build a new, shared, project narrative¹³.

3.4 The Green Communities project: innovation and development. How, where, when, with and for whom?

Although the GC project formally accomplished the goals set, it can be said that the opportunities and resources that were involved in terms of funds, competences, and relationships haven't been fully exploited.

In particular, the 'hinge roles' (management, communication, evaluation) that could have made a difference in designing compelling and shared narratives, as well as the character traits and skills required for adequately carrying their specific tasks on, have not been adequately considered. This resulted in the following main cascade of consequences: *lack of a transparent flow of information* about the uncertainties the project was facing and the reasons behind the changes undertaken and, in turn, decrease in the *generative potential of the relationships*.

Particular narratives couldn't coalesce into a synthesis, as it could have been if a shared and coherent narrative had been driving the whole process. This was due to: misalignment with respect to the general vision, to the point that the way participants describe the project and its objectives are different (reflecting the partial view each one had); little cohesion, empathy and dialogue among participants, underestimation of the relational tasks a project manager has to accomplish; decreased acknowledgement of the advantage of working in/for a wider community.

13 What we referred to as the third reason why narratives matter so much, i.e. as a basis for action to face ontological uncertainty (e.g. through adaptation, adjustments, etc.).

To this respect, we might ask how and in which way did this project contribute in triggering a change in participants' way of thinking, if most of them, at the end of it, found themselves acting as before¹⁴.

A final comment, indeed, concerns the lack of a strong commitment on the part of the clients (and somehow also of the management team) to look beyond the project and its specific financing line both taking the chance of promoting a broader awareness on sustainability-related issues, and encouraging a cross-comparison and peer learning among areas.

Conclusions: Frames and settings

With the present contribution we discussed a new approach to process management and evaluation aimed at tackling complex projects (such as those regarding local development). It clearly emerged that, not only it is necessary to coordinate and intertwine project management activities with those of evaluation – which offer multiple opportunities to re-open, discuss and reconfigure spaces of design -, but that it is important to reflect on the very nature of the frames and settings available to projects. An entire set of related things has to be re-configured, from the way calls are made and the way we conceive 'projects', to the use we make of the resources (material, immaterial and of time) allocated and the competences we indicate as necessary for a project, included those required to conduct the evaluation.

Too frequently the formal structures in which projects must fit in (i.e. budget and contract constraints) prevent to capture, monitor, understand and take full advantage of the cascades of consequences that arise from their implementation. Indeed, the projects' structure too often don't give sufficient freedom to involve agents whenever it would be most suitable to, or dedicate enough time to sediment, analyse and understand the accumulated experiences, so as to feed all this back again into the process triggered by the project.

14 ' (...) indeed the national experts, with some cooperation from the local experts in the four pilot territories, did develop such guidelines. What they failed to do is figure out a process that could identify groups of 'champions' in a territory to work together with local public and private sector agents to mobilize the citizens in a territory to design and implement a strategy for local development based upon creative applications of the best-practice guidelines. In the end, they created some very interesting technical tools – but no process for developing patterns of social interactions in which those tools could perform their desired functions' (Lane, 2014, p. 48).

References

- Anzoise, V. and Sardo S. (2013), *Dynamic Evaluation process: the co-design of a vision*. Deliverable 3.1. MD project.
- Bijker, W.E. (1995) *On Bicycles, Bakelites, and Bulbs: Toward a Theory of Sociotechnical Change*. Cambridge: MIT Press,
- Borghi, E. and Letta, E. (2009) *La sfida dei territori nella Green Economy*. Bologna: Il Mulino.
- Browning, T.R. (2010) On the alignment of the purposes and views of process models in project management. *Journal of Operations Management*, 28 (4), 316-332.
- Bruner, J. (1991) The Narrative Construction of Reality. *Critical Inquiry*, 18 (1), 1-21.
- Cousins, J.B. and Earl, L. (1992) The case for participatory evaluation. *Educational evaluation and Policy Analysis*, 14 (4), 397-418.
- Fetterman, D.M. (1994) Empowerment evaluation. *Evaluation Practice*, 15 (1), 1-15.
- Fetterman, D.M. (1995) In Response. *American Journal of Evaluation*, 16 (2), 179-199.
- Czarniawska, B. (1998) *A Narrative Approach to Organization Studies*. London: Sage
- Fareri, P. (2009) *Rallentare. Il disegno delle politiche urbane*. Milano: Franco Angeli.
- Hoholm, T. and Araujo, L. (2011) Studying innovation processes in real-time: The promises and challenges of ethnography. *Industrial Marketing Management*, 40 (6), 933-939.
- Lane, D.A. and Maxfield, R. (1997) *Foresight, complexity and strategy*. In Arthur, B., Durlauf, AS. and Lane, D. (eds.), *The Economy as an Evolving Complex System II*. Boulder: Addison-Wesley Press.
- Lane, D.A and Maxfield, R. (2005) Ontological uncertainty and innovation. *Journal of Evolutionary Economics*, 15 (1), 3-50.
- Lane, D.A., Maxfield R., Read, D. and van der Leeuw, S. (2009) *From Population to Organization Thinking*. In Lane, D., Pumain, D., van der Leeuw, S.E. and West, G. (eds.), *Complexity Perspectives in Innovation and Social Change*. New York: Springer Editions.
- Lane, D.A. (2014) *The Innovation Society and Social Innovation*. [online] Deliverable 2.2. INSITE Project. Available from: http://www.insiteproject.org/wp-content/uploads/2014/07/WP2_Deliverable-2-2.pdf [Accessed: 14th December 2014]

- Martin, J. (1990) Deconstructing Organizational Taboos: The Suppression of Gender Conflict in Organizations. *Organization Science*, 1 (4), 339-359.
- Mittica, M.P. (2010) Diritto e costruzione narrative. La connessione tra diritto e letteratura: spunti di riflessione. *Tigor: Rivista di scienze della comunicazione*, 2 (1), 14-23.
- Patton, M.Q. (1994) Developmental Evaluation. *Evaluation Practice*, 15 (3), 311-319.
- Patton, M.Q. (2011) *Developmental Evaluation. Applying complexity concepts to enhance innovation and use*. New York: The Guildford Press.
- Pentland, B. (1999) Building Process Theory with Narrative: From Description to Explanation. *Academy of Management Review*, 24 (4), 711-724.
- Rossi, P.H., Lipsey, M.W. and Freeman H. E. (2004) *Evaluation: A Systematic Approach*. London: Sage.
- Roe, E. (1992) Applied Narrative Analysis: the tangency of literary criticism, social science and policy analysis. *New Literary History*, 23 (3), 555-581.
- Scriven, M. (1994) *Evaluation thesaurus*. London: Sage.
- Sen, A. (1993) *Capability and Well-being*. In Nussbaum, M. and Sen, A. (eds.), *The Quality of Life*. Oxford: Clarendon Press.
- Weick, K.E. (1995) *Sensemaking in Organization*. London: Sage.
- Witkin, S.L. (2010) A discourse perspective on evaluation. *Culture & Society*, 1 (1), 109-122.



***Lições de Salazar* [Salazar's lessons] 1938: the role of progress and technology on an authoritarian regime ideology**

Carlos BÁRTOLO*

Universidade Nova de Lisboa, and Universidade Lusíada de Lisboa

*Since 1926, and for five decades, Portugal went through a far-right dictatorship regime. In the first decade the main concern was to validate its arrival to power by presenting itself as the regime that finally was able to save the nation from previous harmful circumstances that had wreaked the economy. In order to achieve this, it was necessary to demonstrate how this new government had the capacity of hauling the nation to the same level of progress reached by the so-called developed countries. In 1938, commemorating the 10th anniversary of dictator Salazar's appointment as Minister of Finance, seven posters untitled *Lições de Salazar* were printed and affixed at every school. Six represented different viewpoints of Salazar's economic miracle; the seventh represented the moral values over which education should be established, and hence the Nation. Through these posters a dual and contradictory regime message comes clear: the pressure to employ 'progress' and 'technology' as propaganda concepts, but also the reluctance in its use, since these notions were commonly associated to a 'disruptive modernity', contrary to a conservative regime continuousness need to preserve its moral sovereignty free of malevolent international influences.*

Keywords: Portugal; propaganda; nationalism; identity; progress

Introduction

In 1938, on the tenth anniversary commemoration of António de Oliveira Salazar (1889-1970) appointment as Minister of Finance, the Education Ministry printed a set of educational lithography posters untitled 'A *Lição de Salazar*' [Salazar's Lesson]. They were affixed throughout the country's public classrooms, emphasizing the double meaning of *lição*

* Corresponding authors: Carlos Bártoło | e-mail: chm.bartolo@gmail.com

[lesson] — as simple didactic moment but also as a more profound ideological doctrine —, (figure 1) and thus stressing the school role in the new regime:

'The school activity was expanded, its aim shouldn't be only to teach, but mainly to indoctrinate, politically indoctrinate in the noble sense of the word. More precisely: to disseminate knowledge that doesn't oppose, above all advocate the State moral bases; and to have constantly the concern that on the juvenile spirits should stay indelibly embedded the thought that the individual is worthless, if his effort isn't focused on the community service' (Ramos, 1937, p. 6) [The quotations originally in Portuguese or French are author's free translations.]



Figure 1 A boy's classroom in a state school, 1930-40's (available at http://restosdecoleccion.blogspot.pt/2012_06_01_archive.html).

At that time the regime was finally achieving a secured position, twelve years after the 1926 military *coup d'état*. This *coup* was the outcome of an extended political crisis led by the failure to implement and stabilize a liberal and democratic system (monarchic and more recently republican), experienced since one hundred years before.

After an unstable beginning, the regime found its pace under Salazar authority, a celibate conservative catholic economy professor invited in 1928 to straighten out the national debt as an all-powerful Minister of Finance. Gradually, he secured prominent roles in the government until he arose to Prime Minister in 1932, incarnating a stoic *persona* that carried out the divine duty of fathering the country (Rivero, 2010). With the 1933 *Constitution* ratification — establishing the power on a corporative regime entitled *Estado Novo* [New State] —, Salazar held his position in practice as a dictator, balancing out the different factions of the Portuguese far right. For the equilibrium of these forces (from the poles of the *ancien régime* to the *pro-fascists*) Salazar — himself a Conservative Catholic close to Integralism — created a single-party regime congregating, in the Establishment, reactionaries with modern-authoritarians while answering to different society sectors yearnings, all against the same unique enemy: the *social-liberal-democratic* system (Rosas, 1989).

Different propaganda for the same message

Due to several factors these seven posters were conceived in a completely different way than other propaganda simultaneously produced by the regime. The most obvious reason was its target identification, children of every social stratum (from the poor rural worker's sons to the urban middle-class' ones). Accordingly the posters were conceived using illustrations with the same character than the mandatory school manuals. Their authors were Emmérico Nunes (1888-1965), Raquel Roque Cameiro (1889-1970), and Martins Barata (1899-1970), all artists associated with a conservative and figurative genre of art: following the naturalistic and realistic movements; excelling in historical, landscape or genre painting, mainly in the depiction of rustic or popular scenes and still lifes; and in illustration — including the official school manuals. The predominant use of realistic image over text — resumed to the title *A Lição de Salazar* and a phrase summarizing each case — was a result of the intention to fetch the broadest public possible: not only students but also the gullible alphabetic parents, unfortunately a majority (according to 1930 and 1940 population census, the Portuguese alphabetic population percentage was of 67,8 and 59,4%, respectively (Carvalho, 2011, p. 771). These were simple lessons for simple people.

Another reason was the organism in charge of this edition: the Education Ministry, controlled by the party's most reactionary factions. As such its output was mainly traditional, not subscribing the most recent trends used

by the official propaganda department. During this first decade the *Secretariado de Propaganda Nacional-SPN* [National Propaganda Bureau], created in 1933 under the command of António Ferro (1895-1956) — a cosmopolitan writer associated with the Portuguese and European modernist and futurist milieu since his youth — was producing material of a much more innovative genre. The *Portugal 1934* opulent photographic album (figure 2) and the Portuguese pavilion information display at the *1937 Paris World Exhibition* (figure 3), conceived with the same goal, were perfect examples of this.



Figure 2 Pages from Portugal 1934 photographic album (Portugal.SP.N, 1934, n.p.).



Figure 3 Interiors of Paris 1937 Portuguese pavillion by Keil do Amaral (arch.), and a SPN artists-decorators team (int.). Exposição Internacional de Paris, 1937. Photo Mário Novais [1937]. Col. Estúdio Mário Novais. FCG-BA.

On them, with the help of his modernist *old comrades*, Ferro presented the same discourse supported on statistical data mapped on: photography,

forms, colours, simple graphics and modern typography, assembled, in the pavilion case, over geometric three-dimensional compositions that enveloped the spaces. In these works were perceivable influences from experiments of recent avant-garde graphic and exhibition design like: El Lissitzky's 1928 Soviet pavilion, and catalogue, at the *Pressa* exhibition in Cologne; or Adalberto Libera and Mario de Rizi's 1932 *Mostra della Rivoluzione Fascista* in Rome (other artists collaborated in this exhibition like Marcello Nizzoli, Giuseppe Terragni, Mario Sironi, Achille Funi and many others). Naturally the public lured by the *SPN* was diverse: this was propaganda conceived to Portuguese — and foreign — literate classes, not the common illiterate peasant; to people used to the cosmopolitan terraces of Lisbon, Paris or New York, and not to someone that didn't know what was outside his village limits, and where the modest teacher's classroom was the most enlightened place on earth. Nevertheless, these posters composition should be alluded on the use of functional graphic communication laws that efficiently contributed to getting the message delivered.

The lessons

Six of these posters promulgated the *miracle* occurred during those ten years of Salazar guardianship (figure 4). Each one has the same composition: two images, one smaller (the *before*) on the upper left corner slightly superimposed by a bigger and more colourful one (the *after*) on the opposing corner; and at the residual space the title, on the upper right corner — printed in black with Salazar's initial S bigger than the other letters thus highlighting the dictator's name — and a short emphatic caption on the remaining quadrant. The predominant elements are shown in a diagonal line, recurring to different layers, dimensions and tonal scales, stressing the dynamic action that wants to be revealed: the transfiguration from an ulterior moment to a subsequent present. Cascading from the left upper corner to the bottom right, the oblique composition emphasized the solidity of what had been achieved: the present.

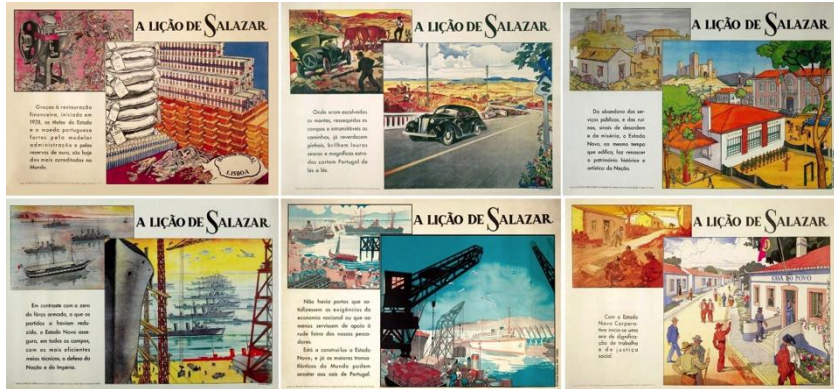


Figure 4 A Lição de Salazar evolution posters by: Raquel Gameiro 1st, 5th; Martins Barata 2nd, 3rd, 6th; Emmérico Nunes 4th (Portugal.MEN et al., 1936, 1-6).

Through these operative means, that underlined the change from a recent *decadent* past to a fulfilled present, six topics were announced: the achieved financial stability; the improvement on communications and agriculture; the cultural heritage recovery and public infrastructures construction; the armed forces growth; the commercial ports development supporting the economy; and the work and social conditions enhancement achieved through the corporative system.

Modern technology outcomes were discerned in almost all of these posters: modern cars roaring over perfect country roads contoured with new telecommunications lines; similar cars and lines crossing the village's centre equipped with revamped public buildings and modern schools where uniformed children played; on the background of a bustling shipyard endless formations of aeroplanes, submarines and warships traversing a bay; lines of busy cranes unloading cargo from modern freighters moored near enormous passenger liners; everything contrasting with corresponding gloomy *before* scenes.

All this information, even if slightly enhanced, was the result of a State endeavour to recover and haul the nation to the same level of progress reached by the so-called developed countries (something deficiently tried to achieve since the establishment of the liberal regime in the 19th c.). Through a determined policy of infrastructure development, *Política de Obras Públicas* [Public Works Policy], carried by the minister Duarte Pacheco (1900-1943), roads, airports, and ports were developed; hospitals, schools and other public equipment built; hydroelectric plants raised and modern

communication networks spread. This effort was permanently announced, as the government main concern was to validate its recent arrival to power by presenting itself as the regime that finally was able to save the nation from previous harmful socio-politic circumstances (decades of liberal and democratic ephemeral *chaotic* governments) that had dramatically wrecked the feeble Portuguese economy.

The trilogy poster

Notwithstanding, for this essay, it's the remaining poster — different from all others graphically and in content— that turns up more revealing of the regime intentions.

The double *before-after* illustrations scheme was replaced by one single image. The title is still in the upper right corner, but presented more colourfully, in black with L and S red initials over a yellow scroll; on the opposing quadrant, a classic tablet with the short legend *Deus, Pátria e Família: A Trilogia da Educação Nacional* [God, Fatherland and Family: the National Indoctrination Trilogy], in the same colour palette with highlighted D, P and F initials.

The oblique dynamic composition seen on the others vanished in a poster that didn't want to express an evolution or comparison, but to affirm a unique, solid and immutable stance. Graphically this was achieved extending the image all over the surface reducing the texts to floating secondary elements, hence the need of scroll and tablet. Even the image's tonal density was balanced. The decision to distinguish this poster from others stresses its importance as the one where, more than simply present facts, fundamental principles to the regime were proclaimed.

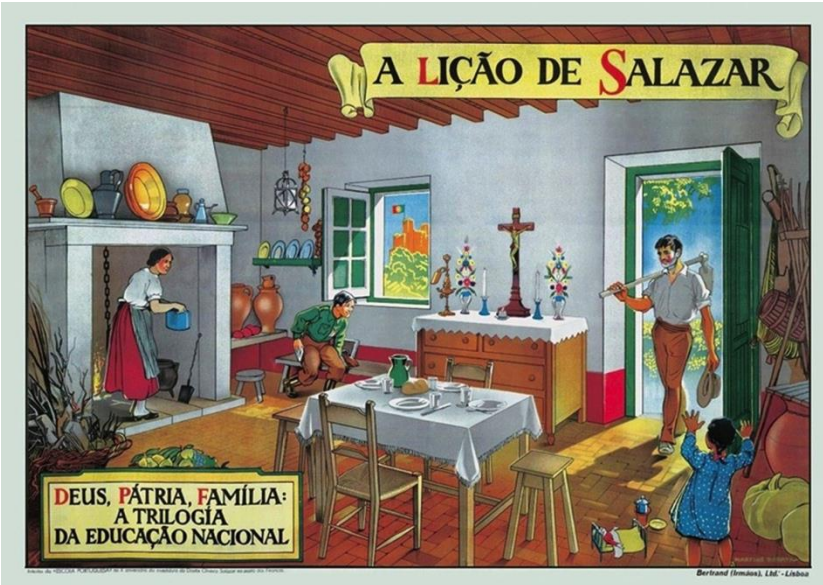


Figure 5 A Lição de Salazar trilogy poster by Martins Barata (Portugal.MEN et al., 1936, p. 7).

This seventh poster depicted just one scene happening in a domestic interior (figure 5). Through the open door and window is possible to realize that it is a modest one-storey house with direct access from outside. The room is flood with warm and yellowish sunlight, creating a joyful ambiance for the effusive moment where a father arrives from work and is cheerfully welcomed by the family.

In this room the desired moral trinity *God, Fatherland and Family* — fundamental dogmas of *Estado Novo* (abiding Catholicism, obedient nationalism, and traditional family morals) —, is presented in a scene that assembles all in a singular picture. Salazar had previously formulated his *trinity*: at a conference in 1912, he proclaimed '*only one entity apprehend my main thought: the Christian-democrat perfectly consolidated in the family, fatherland and religious society should be the useful entity during this historical moment when each individual discourse try to be a social inutility.*' (Salazar, 1912 [1997], p. 178); and on *The National Revolution great certainties* discourse of 1936, '*We don't discuss God and virtue; we don't discuss Fatherland and its History; we don't discuss authority and its*

prominence; we don't discuss family and its moral; we don't discuss work exaltation and its duty' (Salazar, 1937, p. 130).

The caption proclaimed this group of interconnected values according to their hierarchy, from the universal (*God* as creator) to the particular (*Family* as primordial social unity): '[family was the] *irreducible social cell, original nucleus of the village, the county and, therefore, the Nation: it is, by nature, the primary organic element of the constitutional state'* (Salazar, 1935, p.85). The *Individual* was excluded from this representation, as it wasn't, per se, social. Charles Barrès, one of the *nationalism* and *fascism* fathers, said '*But don't you know that the individual is nothing, and society everything?'* (Barrès, 1897 [1922], p. 261); and years later Salazar declared '*The 19th c. liberal politics made 'citizen' an individual dismembered from family, class, profession, cultural environment or economic aggregation, and gave him, facultatively, the right to intervene on the State constitution'* (Salazar, 1935, p.85).

In the poster *God* is perceived in this devotional ensemble over the chest of drawers, and *Fatherland* on the castle's waving flag seen through the window and on the son's *Mocidade Portuguesa* official uniform (*Mocidade Portuguesa* was the compulsory Portuguese youth organization created by *Estado Novo* in 1936, and originally inspired upon the model of the Italian Fascist *Opera Nazionale Balilla* and the German National-Socialist *Hitlerjugend*). Nevertheless, of this three values, the focus is on *Family*, thus understood as the system nucleus, simultaneously consequence and origin of them all, '*There [in the family], the man is born; there, generations are educated; there, the small world of affections is formed, without which he can hardly live. When the family falls down, the house falls down, the home falls down, the kinship bonds fall down, and the men remain isolated before the State, strange, without support, morally stripped of half of themselves; a name is lost, a number is acquired — the social life promptly heads in a different way'* (Salazar, 1937, p. 134). By choosing *Family* as *fulcrum* value, Salazar was also portraying the dictatorship citizen primeval duty: uncritical obedience. Respect and obedience to fathers (more precisely *the father*, the family chief) signified obedience that all should maintain to their superiors: *God* on the divine domain; and on the earthly world — the *Fatherland* — its supreme leader, the dictator. '[Obedience was the] *high gift of providence, as without it nothing could be possible on social life, or human civilization [...]. In family, school, church, workshop, guild, army quarter or State, authority never exists for itself but for others'* (Salazar, 1937, p. 122).

It's also interesting to perceive how *Family* concept is presented in this picture in its minimal but ideal configuration: a couple and their pair of one son and one daughter. In this representation all performed their traditionally ascribed roles: a working father, in charge of the family means of support, coming from outside; a homely mother responsible for nourishment, the care of house and offspring; a young daughter, innocently playing with dolls, thus already learning her attributed place in society; and an uniformed boy studying to obediently serve the Country, and God, as respectfully as he saluted his father, in reality the only one that could break the perpetual primitive rural life cycle through work and studies, holding the only book visible in the room, testimony of the existence of a single unquestionable truth in the entire nation. Interestingly the men stand next to the sunny outside openings and the women are sheltered in the interior but in spite of the outside-inside locations, they are all on the most *sacrum* place, inside their own home (the etymological origins of *home*, *family*, *fatherland*, and *nation* can all be intertwined on wide ranging definitions that underline the *group* or *belonging* meaning). *House*, *nest*, *home* were here understood as the primal space of physical and spiritual values safekeeping, refuge from malevolent external influences. As a result *Home*, as symbol, stood for *Family* and consequently for *Fatherland*.

Therefore the importance of this innocent representation: not any house, but the *Portuguese family home* as an abstract entity; not a realistic model to be copied, but the representation of ideals that all should spiritually attain.

In this manner these *family* and *home* representations were the sum of attributes understood as this pursued abstract concept signifiers. They were intended to represent costumes, details and characteristics easily and broadly regarded as vernacular Portuguese, but that shouldn't be attributed specifically to a particular region, thus creating a mingled reinvented tradition (Hobsbawm, 1988), a fake and generic national symbolic repertoire endlessly repeated without acrimonious regional disputes. *Nation* and *People* perceived as a single entity.

The Portuguese Home

Returning to this paper aim — understand how *Estado Novo* understood the role of progress and technology on Portugal — it should be analysed how technology was addressed in the trilogy poster.

The room, while small in dimensions, accommodates a diverse group of functions: living —the boy studying in a corner and the girl playing on the

floor; eating — the dinner table ready in the middle of the room; cooking — with the mother preparing a meal at the chimney surrounded by firewood, ingredients and kitchen utensils; storage of personal items (the chest of drawers) or of farming activity (tools and stored goods, pumpkins and other goods in baskets and earthen vessels); and of devotion — on top of the chest a crucifix flanked by flower vases, candleholders, and a brass oil lamp.

The only house function spaces missing were the sleeping and hygiene ones, both too sinful according to the Christian morality to be represented. Apart from the devotional ensemble — naturally the most ornate and important room pieces — the other objects forms obeyed mainly to strict constructive and functional simplicity, with discreet decorative details in some furniture and table set items. The general spirit was of modesty and poverty, not miserabilist but ascetic; a family proud of its barely but honest possessions.

The home was in pristine and ordered condition: ironed cloths, shining metals, whitewashed walls... everything in its place. While there isn't any display of wealth and luxury on the objects, the abundance of food denoted that there was no famine, and the sustenance and well-being was, at reasonable modest limits, attainable. Overall the entire scene emanated calm, joy, happiness and bonhomie.

'... the reasonable house, house of the poorest, salubrious house, independent, arranged like a nest — home of the workers family, modest home, restrained, Portuguese.' (Salazar, 1935, p. 323)

If the first posters displayed elements of civilizational and technological progress, the last one presented none. Instead of fast automobiles, zigzagged roads, rows of telecommunication poles, mighty cranes, liners, airplanes, warships, submarines, etc., there was just a simple and humble rural home, lost on Salazar's *locus amoenus*. No sign of electric light, a house being lighted with candles, lanterns and oil lamps. Also no signs of plumbing, with earthenware and tinfoil water jugs visible around the chimney. No signs of modernity at all, as the mother continued cooking with caldrons and iron cast pots in the chimney. None of the domestic appliances long time developed are in sight: a radio, a telephone, a refrigerator, a gas or electric stove (in fact not even a charcoal, kerosene or wood-burning stove), benefits that the modern technologic progress had already trivialised on many 1930's Portuguese urban houses. It's important to mention that the distribution of piped gas in Lisbon and its outskirts had begun in the mid

19th c., for public lightning and domestic use; and that electricity production began in 1889, quickly supplanting the gas as light energy, with the gas network persisting in Lisbon for domestic use. In the 1930's the country electrification was one of the public infrastructures being developed, with the State assuming the task and since the 1920's the gas and electricity companies were vigorously promoting the use of every kind of electric and gas appliances and educating on its use (figure 6).



Figure 6 CRGE 1937 electricity campaign posters by Guy(?) (Faria et al., 2000, pp. 41, 43, 45, 35).

In reality all objects of this home could be found in a mid 19th c. house, if not earlier, and hadn't been, since then, subject to many alterations: formal, functional or of production. Almost all of them were the outcome of small artisanal production, and only few were mass-produced, but even these, through methods developed during the Industrial Revolution, at the second half of the 18th c. or during the beginning of the subsequent one, namely: the girl's dress printed calico, the iron cast pots, the enamelled or earthenware dishes and the pressed glass. Even the family clothes, exception made to the son's *Mocidade* uniform, could belong to an *uchronic* time, making it difficult to date.

Technology and progress at a conservative country

Salazar, or the regime, didn't intend to force Portuguese people, urban or rural, to return to a pre-Industrial Revolution crude way of life, according to *luddites* principles. In fact it shouldn't be forgotten that great part of the population was still living in similar conditions, specifically the lower classes and the ones outside the cities. Nevertheless this was the model chosen to represent the social and moral values, the depiction of the founding

ideological principles, and not one resulting from the existent and flourishing urban contemporary life.

The first posters revealed the demand to modernize the national infrastructures, subsequently improving the population well being, but the regime didn't intend to place the progress and comfort desire (reference of the technological contemporaneity) at the top of Nation's principles. Not even the *Public Works Policy* —fundamental to the regime propaganda and acceptance — could be motive enough to alter the corporative system backbone, its traditional values. In 1952 Christine Garnier adulatory interview/book (the original Portuguese version untitled *Férias com Salazar* [Vacations with Salazar], was published in various idioms.), a dialogue between the dictator and the journalist explained his viewpoint:

— *So, Madame, what impressions do you take from Portugal?*

— *One of calm, Mister President, probably of extreme calm. I would say numbness.*

— *That calm that impresses you is intentional. — he said — We apply ourselves to protect it from everything that could hurt it, but that doesn't refrain the Portuguese people, that isn't unconscious or uninterested, to be attentive to the world events. I frankly think that the permanent frenzy and exultation in which some regimes maintain their people is a bad and insane thing. [...] I consider this calm one of the present time Portuguese people characteristics. [...] I eagerly wish that our small piece of land preserve this precious gift, common to so many nations in a recent past: the sweetness of tranquil living. Nobody can deny that we, until now, managed to achieve that goal.*

The sweetness of a tranquil living.... I melancholy repeated these words. I think on the flowers, on the people that peacefully wander through Lisbon. I remember the nights when quiet men sit on the belvederes contemplating the city lights, while fados roam through the streets. In Portugal, the people still have time to feel, and guard the pleasure of dreaming. Anyway, I think again of Salazar in his vineyards, quietly chatting with peasants and stonemasons, unhurried, like he owns eternity. In which other country can we find this spirit today? While Salazar vehemently evoke the Portuguese serenity, it looks like we're hearing a healthy man mourning his sick companions, or a wealthy man bragging his home to the unfortunate ones. And this triggers in me some sadness.

— *The experience teach us — he continues — that an intense economical activity, the best technological progress, the most profound social reforms*

leave undamaged the qualities of our people if, by all careful means, we manage to keep their hearts pure and their thoughts sane. That's why we keep the spirit above everything.

The spirit? That's the keyword, the word that better define Salazar politics. For him, whatever the realm, everything is a projection of the spirit. He believes that the spirit mould and transform men more profoundly than dominant forces. Didn't he said once that peace is, overall, a creation of the spirit?

— According to this condition — said Salazar — we pursue, as fast as we can, with the national reconstruction work. You shouldn't forget that one of our agenda items was to bring us up to date since, due to different causes, and in many domains, we let ourselves regretfully to fall behind.' (Garnier, 1952, pp.219-222)

However necessary the demand to *bring us up to date*, this created problems with nuclear nationalistic ideals: how could the nation pursue its attempt to even out other progressive nations while simultaneously preserving its necessary moral sovereignty free of *malevolent* international influences? Especially when this progress was commonly associated to the *Liberal-Bolshevik disruptive modernity*, contrary to the continuousness need of a conservative regime, even one making an effort to built a *new state*.

In this inconsistent set of 6+1 posters, it's perceivable the incongruous *Estado Novo* attitude towards technology, progress or modernity. Lost in a dilemma where the unstoppable modern condition collided with perennial values, and even acknowledging the propaganda demand for facts to self-announce, the regime opted to divide the world in two realms — physical and spiritual — vigorously promoting the latter merits, and subordinating to them the former ones.

A serene nation on an unrested world

Regarded in the broadest sense as *fascist*, *Estado Novo* attempted to differentiate itself from other contemporary systems as an *original* non-belligerent hybrid regime that, while trying to modernize a underdeveloped country, simultaneously kept it lost in a *gone-by glorified, bucolic and pious dream*. This position was clear in the national *discourses* to the 1937 Paris and 1939 New York expositions, both events about contemporaneity and future: the Paris 1937 *Exposition Internationale des Arts et Techniques dans la Vie Moderne* [International Exposition dedicated to Art and Technology in

Modern Life]; and 'Dawn of a New Day/The World of Tomorrow' 1939-40 *New York World's Fair*. In Paris, Portugal exhibited the *modern life art and technique of ruling a country* displaying the success of Salazar's regime work through the results avant-gardist mapping. The itinerary climaxed on a contrasting room entirely dedicated to an extensive ethnographic collection of popular artefacts while, on the pavilion terrace, folkloric dance and music played in parties mimicking traditional summer festivities (figure 7).



Figure 7 Paris 1937 pavilion's popular arts room and three of the decorator-artists dancing with guests dressed in folkloric costumes at the 28th July inaugural ball. Exposição Internacional de Paris, 1937. Photo Mário Novais [1937]. Col. Estúdio Mário Novais. FCG-BA.

In the New York exposition (renown for several utopic presentations) after a presentation of the Portuguese discoveries role and the country endeavour results, Portugal presented, on bucolic gardens, its own *world of tomorrow*, an allegoric ensemble of captions, photographs, bas-reliefs, and sculpture placed over a terrace. The central piece was composed by: a lower bas-relief representing labour; an higher one the family; and on top a sculptured stylized depiction of a white small country village surrounding a church in front of a photographic collage of natural and industrial landscapes with white sculpted doves scattered (figure 8).

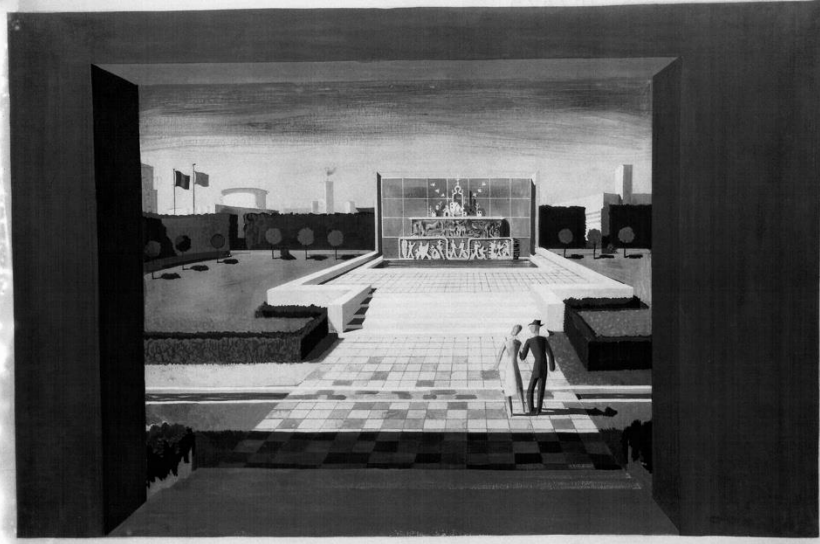


Figure 8 'The gardens with a symbolical group of the Portuguese World of Tomorrow' drawing, Carlos Botelho and José Rocha (project), Canto da Maia (sculptor). O mundo de amanhã, projecto de Carlos Botelho e José Rocha, escultura de Canto da Maia. Photo Mário Novais [1939]. Col. Estúdio Mário Novais. FCG-BA.

The captions emphasized the ensemble ideas quoting Salazar:

'Civilization includes progress but progress alone does not include civilization. § We propose to build up a social and corporative state which shall correspond to the natural structure of society.' (Costa, 1939).

Once again the traditional over the technology, the spiritual over the physical world.

This aversion to technology would delay the necessary and fruitful interdependence between design and a, once again, disregarded industrialization, but in spite of that, the discussion in good taste, culture and identity matters — promoted by the *SPN* — and its profuse graphic and exhibition production, while seemingly distant from the modernist canon, would support the appearance of the discipline conscience and of a generation of artists that would be the *grandfathers* of the Portuguese Design, *born* a few decades latter.

References

- Barrès, M. (1922 [1897]) *Les Déracinés: Le Roman de L'Énergie Nationale*. Paris: Librairie Plon.
- Carvalho, R. (2011 [1986]) *História do Ensino em Portugal*. 5th Ed. Lisboa: Fundação Calouste Gulbenkian.
- Costa, M. (1939) *Portugal in the New York World's Fair 1939: The Official Book of the Portuguese Representation*. Lisbon: SPN.
- Faria, F. and Freitas, M.H. (2000) *Electricidade e Modernidade*. Lisboa: Museu da Electricidade EDP.
- Garnier, C. (1952) *Férias com Salazar*. 2nd Ed. Lisboa: Parceria António Maria Pereira.
- Hobsbawm, E. (1988 [1983]) *Tradições Inventadas*. Lisboa: Direcção Geral dos Desportos.
- Portugal. MEN [Ministério da Educação Nacional], Barata, M., Gameiro, R. and Nunes, E. (1936) *A Lição de Salazar* [set of seven posters]. Lisboa: MEN/ Bertrand.
- Portugal. SPN [Secretariado de Propaganda Nacional] (1934) *Portugal 1934*. Lisboa: SPN.
- Rivero, Á. (2010) *Salazar and Charismatic Leadership* [Online]. London: The London School of Economics and Political Science. Available from: http://www2.lse.ac.uk/researchAndExpertise/units/ASEN/Conference/conferencepapers2010/Angel_Rivero.pdf%3E. [Accessed: 20th March 2012].
- Rosas, F. (1989) A crise do Liberalismo e as origens do «Autoritarismo Moderno» e do Estado Novo em Portugal. *Penélope, Fazer e Desfazer a História*. [Online]. Lisboa: Cooperativa Penélope; Quetzal Editores. (2/Feb. 1989) p. 98-114. Available from: http://www.penelope.ics.ul.pt/indices/penelope_02/02_08_FRosas.pdf%3E. [Accessed: 26th March 2012].
- Salazar, A.O. (1935) *Discursos, 1928-1934*. Coimbra: Coimbra Editora.
- Salazar, A.O. (1937) *Discursos e Notas Políticas, vol. II, 1935-1937*. Coimbra: Coimbra Editora.
- Salazar, A.O. (1997 [1912]) *Conferência na reabertura do CADC (1912)*. In Cruz, M.B. (eds.), *Inéditos e Dispersos I (1908-1928)*. Venda Nova: Bertrand Editora.



Experts, Expertise and Qualitative Judgment in Canadian Architectural Competitions

Carmela CUCUZZELLA^{*a} and Jean-Pierre CHUPIN^b

^a Concordia University; ^b Université de Montréal

How do experts and expertise impact the outcome of the architectural competitions? What do they bring to the judgment process? This study of experts and expertise in the judgment process is based on our previous research, which shows that environmental management tools are shifting the definition of quality in the architectural competition today. We argue that, with the contemporary condition of risk society, there is an evaluation of architectural quality dictated by environmental management tools. With this phenomenon today, it appears that more and more, buildings must be proven to be environmental, otherwise their overall quality is actually questioned. This approach to evaluation seems to confront the more qualitative form of constructing a definition of architectural quality through deliberation and debate of the competitor projects. Our analysis first categorizes the various types of 'experts' in the competition jury and then analyses the impacts that such experts have on the qualitative architectonic judgment for selecting or converging to the winning project.

Keywords: *Expert evaluation; judgment; qualitative debate; expertise; risk society, architectural competition*

Introduction

How do expert evaluations and expertise impact the outcome of the architectural competitions? What do they bring to the judgment process? This study of experts and expertise in the judgment process originated from our previous study that showed that environmental management tools are shifting the definition of quality in the architectural competition today (Cucuzzella, 2013b). Environmental management tools and certifications are some of the many outcomes of what we refer to today as risk society. This is a society that began in the early 1980's, focused on the assessment and

^{*} Corresponding author: **Carmela Cucuzzella** | e-mail: carmela.cucuzzella@concordia.ca

quantification of an array of risks, each with their corresponding set of experts. Among these today, the environmental experts are prominent newcomers in the competition.

This paper has three main parts. In the first part, we will circumscribe the various issues related to qualitative judgment in the architectural competition today, specifically with the growing imperatives of sustainability. Here we will also introduce the methodology adopted. Second, we present a series of competitions in order to categorize the types of expert evaluations in the competition today, identify how these impact the jury deliberation and the conflicts they introduce. In the third and largest section, we place this work in the general theory of judgment where we highlight the differences between the expert evaluation of specific project criteria and general qualitative judgment. A critique of the prescriptive and restrictive character of expertise is conducted through a wider theoretical framework. Here we examine the series of observed tensions from a broader epistemological and historical perspective, by looking at the theories of risk society. Here we will reflect on how the emergence of a risk society has changed the way humans deal with uncertainty and how this has led to a rethinking of how we judge the built environment.

Identifying Tensions in the Judgment Process of Competitions

The specific focus of this paper is to understand how the various forms of architectural expertise are having an impact on the way the jury judges the competitor projects in order to identify the project with the best overall qualities. There are many tools or processes to help define the many dimensions of quality of an architectural project, of which the competition process is an important device. The jury process is ideally meant to collectively find the project with the overall best qualities through a constructive deliberation. We contend that experts confront this construction with the prescriptive measures and restrictive visions resulting from their assessment tools. Is the growing expertise in the competition leading to a fragmented vision of the project intentions?

We compared a variety of Canadian competitions where the reliance on expertise was a dominating factor in the jury deliberation process. We found that this situation arose most frequently when an environmental certification was a strict requirement and explains why there was a focus on

such competitions. In addition we have been increasingly observing in competitions today that proving a building is environmentally sustainable through the acquisition of some green building certification has become a goal in itself. In a previous research, we have observed that these certifications actually become the main competition prize for the client in the Canadian context (Cucuzzella, 2012).

In Canada, the emerging norm used to address sustainability, particularly environmental sustainability is the LEED (Leadership in Energy and Environmental Design) rating system. This rating system is increasingly required as part of the criteria in Canadian competitions. It was introduced in Canada in 2003, but has gathered traction in competitions, specifically since 2008. We complemented some of the Canadian competition analyses with examples of competitions from around the world in order to better understand the phenomena.

We conducted a comparative discourse analysis of the competition brief, competitor textual proposals, and the jury report. We also conducted a comparative analysis of the visual dimensions of the competitor panels, i.e. drawings, schemas, tables, and renderings. Our results are presented in a two-fold manner. We first present a categorization of various expert-types within the competition. We then present some brief analyses of the impacts of experts and expertise on the competition process within this categorization. For purposes of brevity we will only present the results of a few competitions in this second part. We conclude this paper with a reflection of these observations through the lens of the contemporary Western condition of risk society in order to contextualize their implication.

Experts, Expert Evaluation and Qualitative Judgment in the Architectural Competition

Who are the experts in the competition process today? Although one could consider that most of the actors engaged in a competition are experts in one way or another, in this research we propose to distinguish between *explicit experts*, *implicit experts* and another category that can be referred to as the *meta-experts*.

Observations

What we will call the *explicit experts* in a competition are those actors that deal with areas like energy or material efficiency, technical or structural feasibility, performance measures, and acoustics among others. They are

referred here to as 'explicit' since in most cases, their titles include their area of expertise. The growing plethora of measurement tools or software to assist in the task of performance evaluation today calls for increasingly improved performance and therefore more explicit-experts. This precise quantitative assessment comes into conflict, at times, with the more qualitative debate of the overall project. These experts usually have no deciding power in the jury since they are typically called in before the jury takes place. However, we are witnessing that some of these explicit experts are at times invited as jurors.

We will also identify a category of *implicit experts*, since: *the client* is an expert of the requirements; *the advisor* is an expert of the competition process; *the architect* of the jury is an expert in architectural quality; and *the competitors* are obviously experts in design. We refer to these actors as 'implicit' since their professional titles do not state their area of expertise. For example, the client, who is the representative of the user, understands the project in a general sense and within this, has a rich understanding of the requirements. Another example is the architect. The architect is above all, an expert in the conception and construction of projects. As part of this area of expertise, they are inherently experts in qualitatively judging the diverse dimensions of quality.

What about the *meta-expert*? This is an expert whose claims remain on the most part unchallenged since he/she is perceived as the ultimate expert in his/her field at large. A meta-expert can be either an explicit expert, for example, the world-renowned expert on energy assessments. In this case, the meta-expert has worked at an international level on questions related to energy efficiency and energy systems and where their work is cited worldwide. A meta-expert can also be an implicit expert. In this case, an example could be a world-renowned architect that has won competitions internationally. He is respected as a professional who inherently understands the essence of winning projects. Both of these types of meta-experts are important to our observations, as they have demonstrated their capacity to short-circuit the debate in the jury process.

One wonders how we can maintain the balance necessary for a qualitative judgment in this 'market' of experts. Today, this is aggravated by the need to refer to environmental experts – be it a person or an environmental certification system, before a final judgment can be made. In this sense, tensions are abundant, since architects and jurors are caught between a will to protect the planet through prescriptive rules and expectations for innovation and excellence.

Of course, tensions and conflicts occur in many complex projects that have substantial technical requirements. Nevertheless, the fact that competitions nowadays include an evaluation of performance appears to increase the conflicts of expertise and as such, may explain why more and more, competitions are seen as exhibiting a difficult ‘crab mentality’ – where the actors in this process, rather than working together to collectively define the best project, seem to draw out the entire process to a halt through their competing points of view. How do these experts impact the jury deliberation?

Explicit expert in the jury: The environmental expert

A burgeoning situation in the competition today, with the imperative of sustainable development, is when an expert of a green building rating system is included in the jury rather than used only for consultation. This new situation changes the deliberation process significantly. Because they are explicit experts, their voice can heavily drive the jury deliberation, leaving an imbalance in the weight given to the more qualitative arguments. These explicit experts are not experts of overall architectural project quality, but rather experts of a very specific and fragmented part of the project limiting their vision of the overall project.

This situation increasingly occurs in Canada. A library competition in Montreal emphasized this conflict. In this case, even if the jury¹ conferred that all teams could achieve the LEED requirement, of the two last teams left competing for the winning prize, the safest project regarding the ability to achieve LEED Gold rating was selected. The jury claimed that the runner up was too risky in terms of attaining LEED, yet the team’s discourse was the most encompassing regarding how they addressed sustainability. The winning project did not have any encompassing sustainability strategy, rather only an enumeration of technologies to address performance issues. This specific situation was further aggravated by the fact that for the mayor, the LEED ranking was the most important criteria of architectural quality. The explicit expert in the jury biased the decision, pushing the qualitative architectural dimensions aside so as to ensure a predictable LEED certification was secured. This has occurred in a series of competitions in Canada, particularly where the LEED certification is high.

1 The jury consisted of 7 members: 2 architects, 1 environmental expert/architect, 2 representatives of the client, 1 academic, 1 cultural representative.

Explicit nonhuman expert in the jury: Rigid environmental prescriptions

So an explicit expert is not the only element to perturb the qualitative debate. A rigid environmental certification requirement could also sharply sway the jury. For example, the New Montreal Planetarium competition, launched in 2008 had a LEED Platinum certification requirement – the highest rating of LEED – and the only explicit criterion for sustainable development. The most redeeming quality for the winning project was not its symbolism as the jury² stated: *‘Further exploration of the symbolism of the cones in terms of iconography and the materiality’* (Ville de Montréal, 2009, p. 7).

From the media perception, the most conventional of the projects submitted won, yet it met the strictest LEED standards mainly from ‘tried and true’ technical solutions that were easily understandable by the jury and visible to the public (extensive green roof). The multitude of press releases and documents connected to the project emphasized the importance of the project for strengthening Montreal’s position as a leader in sustainable development. This would also be an example for the next category, which is the invisible member in the jury.

Another example of a competition that was rigidly driven by the measurable requirements of low carbon performance was the *Concours EDF Architecture Bas Carbone 2011*. This was the 4th edition of this competition, organized by EDF on the premise that *‘the low carbon performance stimulates architectural innovation on all levels and processes of design towards a quality that privileges comfort and the habitat.’* (Caille and Francois, 2011, p. 15, author’s translation). In spite of the fact that the jury consisted of mostly architects³, the jury’s comments regarding the winning project were very divided on this outcome since there was much concern about the lack of overall architectural quality. It is clear that technical solutions won this project. In fact, the state architect/urbanist, and member of the minister of ecology of sustainable development as well as member of the jury, voiced profound concern about the project saying that, *‘I have some fears with regards to the image, as part of a larger whole, and with the omissions it may encourage. I think that we must one day give ourselves the means to analyse the existent correlation between the technical*

2 The jury consisted of 9 members: 3 architects, 1 environmental expert/architect, 3 representatives of the client, 1 set-designer, 1 academic

3 The jury consisted of 12 members: 4 architects, 2 urbanists, 2 politicians, 3 representatives from EDF, 1 environmental expert.

Experts, Expertise and Qualitative Judgment in Canadian Architectural Competition solutions and the urban form and to measure these on the architecture.' (Caille and Francois, 2011, p. 29, author's translation). In this competition, the rigid environmental requirements can be considered as the invisible 'member of the jury', driving the entire deliberation process down the path of reducing the debate of architectural quality to a decision of the best project based on the best quantifiable result (lowest carbon).

Meta-expert in the jury: The elephant in the room

Yet, there is another problematic scenario that can be related to either explicit or implicit experts – the meta-experts. These actors are perceived as world-renowned specialists of a profession, field of expertise, or domain. They are similar to the explicit experts in a jury, specifically in the way they are seen to set an imbalance in the jury deliberation.

An example of this situation in Montreal was a competition for a cultural center launched in 2010. Here the meta-expert was the jury president⁴. There were four finalist, all projects equally strong. As an observer in this competition's jury deliberation process, it could be seen that there was a deliberate swaying of the jury members' perception of the four finalist projects by this expert. In other words, the jury president's comments regarding the four finalists were intentional in that they were deliberately seeking to eliminate all the finalists, except that finalist that this meta-expert wanted as the winner. The way in which this was done was through a combination of the jury president's comments followed immediately by a vote. In this case, the meta-experts comments directly influenced the voting by the jury and in turn, the selection of the final winner.

Non-evaluable by experts: When proposals escape quantifiable evaluation

Architects seem to be aware of this inflation of experts in competitions today and tend to produce fuzzy and open-ended projects. Such projects escape any definitive expert assessment and can only be qualitatively judged because of their ambiguous details. In these cases the competitor proposals are meant to depict a striking idea that is not yet quite crystallized in terms of constructability. In these cases, it is not clear what the expert evaluations can bring, specifically because the images are meant to represent an intention more than constructive details. There are many

4 The jury consisted of 10 members: 4 architects, 1 environmental expert/architect, 1 representative of the client, 1 artistic director dance and resident of borough, 2 cultural/political representatives, 1 municipal urbanist.

examples of this, such as the FRAC competition of Marseilles, where Kengo Kuma's winning project was starkly different from what was depicted in the competition (Caille, 2013). Whether it is the rendering technologies available today, the lack of constructive details in the original competitor proposals, or the compromises taken during the construction phase after the competition, it is very difficult for explicit experts to make any conclusive quantifiable evaluations in cases where projects are open-ended. We know that a certain amount of transformation will inevitably occur because of unforeseen constraints. In the case of this example, one could say that the built project was a non-recognizable representation of the competition proposal.

Analysis

Our research on competitions show that environmental experts and certifications are not only problematic for the jury process, but they also seem to impact the design phase, shifting the designer's focus to technological solutions (Chupin and Cucuzzella, 2011). Our research has also shown that it is not only environmental experts that deliberately sway jury decisions, but any of the expert-types identified can also purposefully bias jury decisions. So, we can see that the conflicts related to experts in a competition are complex. We have observed at least three problems. The following is an analytical summary of the above-observed situations.

First, in the case where *an explicit expert, such as an environmental expert, is a member of the jury*, the difficulty in the jury deliberation arises because the expert is not usually versed or has 'whole' project experience since his/her expertise lies within the question of performance optimization of buildings. We can counter-argue that experts of environmental certifications may also be architects, who have project experience. Yet observations in the jury have shown that, in their role as environmental experts, their arguments are systemically those related to the certification system. Such an expert opens up a discursive gap in the jury deliberation, leading to deadlock, since a project may not meet the quality ideals of an architect in the jury, who has a whole project vision, yet the same project may meet the quality ideals of an explicit expert in the jury (Cucuzzella, 2013a).

Second, in the case of *the explicit nonhuman expert in the jury – where environmental management tools are very strictly adopted* – the main difficulty lies in the double-edged situation where there is the questionable validity of such preliminary environmental claims on one end, yet there is a

perceived accuracy of these results, accompanied with their strict use, on the other end. This presents a daunting inconsistent and contradictory situation for the jurors. Our previous studies have shown that the timing of these environmental evaluations in the competition are counter-productive as they occur far too early in the design process – in other words, much uncertainty exists since the project is not yet concretized and constructed (Cucuzzella, 2013a). In addition, research has already begun to show that energy estimates conducted early in the design project, which often use ideal scenarios, are far from the post-occupancy use, so they do not guarantee better building performance (Burnett, 2007; Carassus, 2011; Newsham, Mancini and Birt, 2009; Scofield, 2009). The question of validity and reliability of these expert evaluations arises. Yet the boroughs that run the competitions would prefer to have this early ‘stamp of approval’. Even if the timing seems paradoxical, in Canada, this is fast becoming the norm.

Third, in the case where *a meta-expert is the president or even simply, a member of the jury*, the jury is often swayed in the direction that this expert intends – similar behavior as in the explicit expert. In this case however, the arguments are seen as ‘black box’ arguments since they are perceived to come from the expert’s extensive and exceptional experience, rather than from a series of quantified results, which are more ‘white box’ arguments. Here the debate typically fades quickly as it converges to the meta-expert’s advice. On the one hand, this can be problematic since the fairness and democratic nature of the competition process is diluted in such an intervention. Yet, on the other hand, because of the extensive project vision of a meta-expert, their arguments and choices may be the most appropriate. This is not always the case however.

Some of the conflicts related to expert evaluations in these three situations are then directly related to (1) the value systems embedded within each jury member and the expertise that each one brings to the deliberation; and/or (2) the valorization given to systematic methods of quantifiable evaluation. These values dictate a worldview that to some extent, define what is designated as ‘quality’.

However, in the fourth case, when proposals are *nonevaluable by experts*, this presents a contradiction. In a contemporary competition context when experts are increasingly sought after, this is a situation when the limits of such expertise are made evident. Are we witnessing a situation where architects produce images of buildings that remain intentionally open to interpretation and to future developments because they want their projects to remain supple to the forgoing process? Tostrup suggests that the

visual and verbal competition material presented by competitors, communicate the value systems that are embodied in their proposals (1999). Even if architects say this is done in the spirit of openness of their work and suppleness to process, can it also be that they want to escape any expert evaluation?

Theoretical Implications: Expert Evaluation, Qualitative Judgment, and Risk Society

How should the question of expert evaluations in competitions then be studied? Ideally, in a competition the winning selection is made through a collective deliberation process (Strong, 1996). Qualitative debate in the competition is the means to collectively construct and finally choose the best overall project (Chupin and Cucuzzella, 2011; Van Wezemaal, Silberberger and Paisiou, 2011). However as Nasar has stated, the jury deliberation process is not a given (1999). Let us emphasize that without a qualitative debate the final choice of the winning project is reduced to a vote rather than remain a collectively constructed judgment. From this perspective, it is difficult to circumvent the general theory of qualitative judgment.

Distinguishing Expert Evaluation and Qualitative Judgment

According to the American pragmatist James Dewey judgment is defined as criticism and further states that: 'Judgment has to evoke a clearer consciousness of constituent parts and to discover how consistently these parts are related to form a whole. Theory gives the name of analysis and synthesis to the execution of these functions' (Dewey, 1934, p. 310). Dewey, however, prefers to refer to these functions as discrimination and unification, and claims that the unifying phase (synthesis) is in fact the creative response of the individual who judges and that without a unifying view, criticism (and therefore judgment or emergence) ends in the enumeration of details. Dewey says that discord, conflict, disagreement, or dissonance induce reflection of a situation, experience or object of observation. One cannot ignore the reflection necessary to comprehend this discord or conflict, and by doing so, can resist from oversimplifying a given problem. For Dewey (1910, ed. 1933) reflective thinking is judgment suspended during further inquiry, where a state of doubt is maintained until some conclusion can be finally reached. A judgment therefore arises when there are different meanings, rival interpretations, points of contention

regarding some matter at stake, in short, when there is doubt and controversy. Evaluation, on the other hand, is the specific analysis of constituent parts of a whole, an inevitable activity in the criticism of a whole.

From this definition, evaluation is then incomplete on its own to judge quality in an architectural project. Yet we have seen how evaluations by the explicit experts in some competitions provide quick conclusions, since they assume to have enough evidence – knowing that this evidence rests on their fragmented or sliced vision of the project. Architects (the implicit experts) in the jury, on the other hand, are observed to be in a continual state of suspended conclusion and reflective thinking, grounding the information from explicit experts within their overall project experience – preferring qualitative debate rather than quick deductions.

In the competition cases described above, this debate was avoided based on three major reasons: (1) a powerful and persuasive opinion by an implicit meta-expert that biases the jury and forces an early convergence to a winner (2) a discursive gap amongst the jurors because an explicit environmental expert in the jury pushes decisions to lean heavily on the measurable data rather than the qualitative debate; and (3) the environmental certification requirement heavily biases the jury decisions as this must be unquestionably met.

In the first case, the qualitative debate is cut short because of a forceful and strategic argument that seems incontestable to the other jurors. In this case, as the collective construction of quality among the jurors and their judgment regarding the winning project is cut short, has the meta-expert confiscated the definition of quality? And if yes, then judgment in such situations, as elaborated by Dewey, may have been *controlled* where the controversies were evaded, the elaboration of claims and the sifting through of facts, were abandoned. Yet, in some cases this situation results in great winning projects. Can it be that the meta-expert has embedded tacit knowledge that can circumvent such shortcomings in the jury process?

In the second and third case, the deliberation gives priority to the arguments that can be ‘proven’, or what Habermas (1985) refers to as the cognitive-instrumental or objective realm, rather than those to those arguments that can be constructed through questions of the moral-practical (normative) or the aesthetic-expressive (subjective). In this case, we are increasingly observing, particularly through the growing imposition of the use of environmental certifications for public buildings today, an evaluation of quality emerging from the prescriptions of environmental certifications.

Are the environmental experts – the actors of risk society – conditioning the definition of quality?

This question actually introduces a contemporary paradox where risk society and its plethora of environmental analysis or prescriptive tools are redefining quality in a general sense, and not only for architectural projects. This represents not only a practical but epistemological problem, since more and more today, quantifiable and empirical data is actually needed, not only to design an architectural project but also to judge its quality. Can a reflection on what constitutes a risk society help in untangling the question of experts in the competition?

Is Risk Society a Society of Experts?

Risk society emerged in response to the modern conditions of technology and uncertainty. It describes the way that modern society responds to risk. Giddens defines it as *'a society increasingly preoccupied with the future (and also with safety), which generates the notion of risk'* (Giddens, 1991, p. 3). Risk society emerged specifically with the parallel emergence of: (1) the growing concerns of environmental risk, as these had come to be the predominant product of industrial society; and (2) the renewed interest of subjective Bayesian statistical methods of risk assessment. Obviously the question of environmental risk has been around since the emergence of the industrial revolution. However, since the 1980s, there has been much work done in the field of Bayesian statistical methods, specifically, in the discovery of the Monte Carlo methods with a rising interest for complex applications. At this important junction the hypothesis of risk society was put forth, particularly as has been theorized by Ulrich Beck and Anthony Giddens.

How is risk defined in this context? 'Risk may be defined as a systematic way of dealing with hazards and insecurities induced and introduced by modernization itself' (Beck, 1992, p. 21). Where society is increasingly threatened by potential risks that are a result of the modernization process. By modernization we mean the way humans increasingly seek technological mastery over nature. The prevention of these 'manufactured' risks through measurable, predictable means has become inadequate in a society where risks are being introduced faster than they could be understood, let alone quantified. In fact, Giddens (1991) has stated that the modern understanding of risk was supposed to help humans control their future, to normalize it. Yet according to Giddens (1991) and Beck (1992) things have not turned out that way. Even if this modern understanding of risk was

supposed to help humans control their future or to normalize it, attempts to control the future through these measurable methods have led to the realization that humans need different approaches for relating with uncertainty.

A risk society is therefore focused on efforts for identifying and controlling risks, specifically through probabilistic expert knowledge, even in a global situation where many risks cannot be predicted in a reliable manner. The incarnation of this societal condition in the western world is attested through the development of the International Standards Organization (ISO) 31000 family of standards referred to as Risk Management (International Standards Organization, 2009). In these standards, the creation of uniform risk criteria and evaluation metrics is central for risk management and reporting. The growing international power of insurance companies is another important testimony to the contemporary condition of risk society.

Beck has stated that risk has deepened the reliance on experts, since they have the very precise knowledge to make the authoritative evaluations based on unambiguous and measurable criteria (1997). In our paper, we refer to these individuals as explicit experts – those experts with exclusive knowledge that is only communicable through metrics and quantified results. In a world where uncertainty or danger are governed by risk managers, it is no surprise that there is an overcompensation of risk management experts entering the process in design competitions, where uncertainty and ambiguity are the rule rather than the exception.

How is risk society shifting the qualitative debate in architectural competitions? Can we say that architectural projects are slowly being reduced to any other development project, concerned more with the quantification and minimization of potential measurable risks rather than by an architectural intention and anticipative vision? In a risk society, qualities and outcomes that cannot be measured are harshly challenged. And this is one of the main reasons why environmental certifications for buildings have become so important – they allow for the utmost control (as far as humanity has been able to predict to date) of potential risks in buildings. This presents an obvious problem when assessing the quality of architectural projects.

Discussion

From an understanding of risk society as a society of experts to our engaging criticism of modernity through the paradoxes of conflicting

technological experts, we have reflected on how deeply these issues are rooted in our contemporary western condition. We can already conclude by acknowledging that the conflict of experts in competitions stems, in part, by the discursive gaps between the two sets of experts – the explicit and the implicit experts. The explicit experts often have universalizing statements of a very fragmented vision of the project. It seems, at a first glance, that their arguments are real, concrete and incontestable. The implicit experts often have project specific arguments of an integrated project vision. Their arguments appear abstract and contestable since they cannot be easily proven with a measuring tool or software.

The dichotomy between performance measurements and the complexity of projects is a disciplinary problematic. This becomes quite evident in the competition and represents a point of fragility since some jury members prefer to measure quality from an objective perspective, while others will argue that the notion of architectural quality can only be debated in order to arrive at a collective construction.

Can we say that all that is left of the complexity of the project through the filter of the explicit experts are the technical details? In this light, the conflict of experts may then be summed up as the contradiction between the fact that explicit experts escape the complexity of design projects yet, clients require official expert advice to counter-balance the expertise of the architect. Explicit experts in this sense, appear to be rather remote to the very idea of a competition as a space for qualitative debate and judgment.

We are not suggesting the exclusion of the explicit experts in a competition process, or the total exclusion of rigid prescriptive green building rating systems, which, in their current use, may stifle creativity in the search for innovative solutions. Rather if we are asked, as *experts* on competition research, to provide a recommendation, we could formulate two. First, ironically, we would advise that the explicit experts should remain external to the jury process, since their project vision is limited at best, and fragmentary at worst and could have a counter-productive on the redefinition of quality. Second, environmental tools such as green building rating systems, can be used as guidelines by the competitors in order to guide them in their performance objectives, if necessary, without having to be part of the competition process at all.

References

Beck, U. (1992) *Risk Society: Towards a New Modernity*. London: Sage.

- Beck, U. (1997) *The Reinvention of Politics: Rethinking Modernity in the Global Social Order*. Cambridge: Polity.
- Burnett, J. (2007) City buildings - Eco-labels and shades of green! *Landscape and Urban Planning: Cities and Sustainability*, 83 (1), 29-38.
- Caille, E. (2013) Le concours instrumentalisé par les communicants: bienvenue dans le monde des popstarchitectes. *D'architectures*, 216 (April).
- Caille, E. and Francois, L. (2011) Concours EDF 'Architecture Bas Carbone 2011'. *d'a hors serie*.
- Carassus, J. (2011) Are 'Green' Office Buildings Keeping their Promises? Actual performance, real estate values and 'HQE Exploitation'. Certification: Centre Scientifique et Technique du Batiment and Certivea.
- Chupin, J.P. and Cucuzzella, C. (2011) Environmental standards and judgment processes in competitions for public buildings. *Geographica Helvetica*, 1, 13-23.
- Cucuzzella, C. (2012) *Environmental certifications, National Norms, and the Architectural Competition: a problematic shift of the definition of quality*. Paper presented at the International Competitions and Architectural Quality in the Planetary Age, Université de Montréal, Canada.
- Cucuzzella, C. (2013a) A Theoretical Model For Design For Sustainability: The Impact Of Data Intensive Evaluation Approaches On Design Thinking. *The International Journal of Sustainability Policy and Practice*, 8 (1), 95-108.
- Cucuzzella, C. (2013b) *When The Narrative Of Environmental Certifications Replaces The Debate On Quality*. In Matthey, C.M.L., Gaillard, D. and Gallezot H. (eds.), *Faire des histoires? Du récit d'urbanisme a l'urbanisme fonctionnel: Faire la ville a l'heure de la société su spectacle*. Geneva: Fondation Braillard Architectes.
- Dewey, J. (1910 ed. 1933) *How We Think*. Boston: D.C. Heath and Company.
- Dewey, J. (1934) *Art as Experience*. New York: Perigee Books.
- Giddens, A. (1991) *Modernity and Self-Identity: Self and Society in the Late Modern Age*. Oxford, Cambridge: Polity Press and Blackwell Publishing.
- Habermas, J. (1985) *Modernity - An Incomplete Project*. In Foster, H. (eds.), *Postmodern Culture*. London: Pluto Press.
- International Standards Organization (2009) *ISO 31000 - Risk Management Principles and guidelines*. Geneva, Switzerland.
- Nasar, J.L. (1999) *Design by competition: making design competition work*. Cambridge: Cambridge University Press.
- Newsham, G.R., Mancini, S. and Birt, B.J. (2009) Do LEED-certified buildings save energy? Yes, but... *Energy and Buildings*, 41 (8), 897-905.

- Scofield, J.H. (2009) Do LEED-certified buildings save energy? Not really. . . *Energy and Buildings*, 41 (8), 1386-1390.
- Strong, J. (1996) *Winning by design : architectural competitions*. Boston: Butterworth-Heinemann.
- Tostrup, E. (1999) *Architecture and Rhetoric; Text and Design in Architectural Competitions Oslo 1939-1997*. Great Britain: Andreas PAPADAKIS Publisher.
- Van Wezemaal, J., Silberberger, J. and Paisiou, S. (2011) Assessing 'Quality': The unfolding of the 'Good'—Collective decision making in juries of urban design competitions. *Scandinavian Journal of Management*, 27 (1), 167-172.
- Ville de Montréal. (2009) *Le Planétarium/Concours d'architecture*. Rapport du Jury: Étape 2. Montreal.

Il concetto di sostenibilità nella moda: il caso della lana rustica italiana

Monica CARIOLA, Greta FALAVIGNA, Valentina MOISO* and Elena PAGLIARINO

Istituto di Ricerca sull'Impresa e lo Sviluppo del Consiglio Nazionale delle Ricerche (CNR-Ceris)

Nella moda si sta diffondendo la retorica per cui estetica ed etica sono concetti non solo conciliabili, ma anche necessari e strategici per lo sviluppo del settore. Di conseguenza, da un lato si assiste a quanto si è già verificato nel settore agroalimentare, dove prodotti artigianali, locali, tradizionali stanno segnando un ritorno a significati, tecniche e pratiche dell'era preindustriale visti come garanzia di qualità, esclusività e tracciabilità del prodotto. Dall'altro lato questi prodotti incorporano nuove esigenze (ad esempio di tipo immateriale ed emozionale) e anche nuove tecnologie nella produzione, nella comunicazione e nella distribuzione.

La ricerca evidenzia queste recenti tendenze nella moda sostenibile italiana presentando un caso di produzione di capi di abbigliamento in lana rustica, un rifiuto – si tratta di fibra grossolana e ordinaria - che numerosi progetti finanziati pubblicamente stanno cercando di nobilitare in materia prima. Si tratta di una sperimentazione guidata dal Consiglio Nazionale delle Ricerche in collaborazione con alcune aziende tessili dei distretti di Biella e di Prato. Specularmente è stata indagata l'opinione dei consumatori su questa particolare declinazione del concetto di sostenibilità nell'abbigliamento, un campo dove il gusto, lo stile e l'espressione di sé rivestono fondamentale importanza.

Keywords: Moda sostenibile; filiera tessile; consumo critico

Introduzione

'Sustainability is an example of what is called a wicked problem. Wicked problems are complex and messy, characterized by several features: non definitive formulation of the problem exists; its solution is not true or false, but rather better or worse; stakeholders have

* Corresponding author: **Valentina Moiso** | e-mail: v.moiso@ceris.cnr.it

radically different frames of reference concerning the problem; constraints and resources for solution change overtime; and, the problem is never solved' (Peterson, 2009, p. 71).

Nella moda la sostenibilità si declina in vari attributi: compatibilità con l'ambiente; sostegno allo sviluppo economico del territorio; sostegno alla cultura, principale fonte di ispirazione in termini di codici estetici; rispetto dei diritti dei lavoratori e sviluppo delle loro competenze in tutti i paesi in cui ha sede la produzione; rispetto dei consumatori (Hethorn e Ulasewicz, 2008). Il Manifesto della sostenibilità per la moda italiana della Camera nazionale della moda italiana (2012) traccia una via nazionale alla produzione di abbigliamento responsabile e sostenibile. È un decalogo di indicazioni concrete da attuare lungo tutta la catena del valore della moda: il primo punto fa riferimento al design e raccomanda un suo utilizzo al fine di aumentare la durata dei prodotti e ridurre gli impatti sull'ecosistema (Unioncamere, 2012).

Il caso della lana rustica italiana si presta bene a studiare l'applicazione del concetto di sostenibilità al caso della moda, con attenzione al design del prodotto. Lo smaltimento della lana rustica prodotta dall'allevamento ovino solleva problemi economici e ambientali: per i pastori il costo della tosatura, da cui non possono esimersi, e dello smaltimento della fibra di lana è molto gravoso, non mancano i casi in cui tale rifiuto viene sotterrato abusivamente. Questa lana veniva utilizzata per la produzione di abbigliamento fino alla Seconda Guerra Mondiale, quando è stata sostituita dalle cosiddette lane merinos, più fini e leggere, che hanno incontrato il favore dei consumatori. Il suo reinserimento nella filiera tessile italiana è pensato per superare i problemi di smaltimento ma anche come innovazione di prodotto che potrebbe sostenere un settore che mostra segnali di crisi. La creazione di abbigliamento in lana è dunque al centro di interessi differenti ma convergenti, e anche se gli operatori che si confrontano direttamente con il mercato sono pochissimi, i finanziamenti pubblici stanziati nell'ultimo decennio per R&D in questo campo sono quantificabili in 21 euro per kg di lana sucida (cioè appena tosata) utilizzata nei progetti, un supporto ingente considerato che la lana sucida è attualmente valutata circa 0,50 euro al kg.

Dal punto di vista analitico il tema riveste un grande interesse per lo studio di come viene materialmente declinato il concetto di *sostenibilità* di un capo di abbigliamento da una serie di operatori differenti, connessi in una rete *tecnologicamente densa* in cui la strumentazione disponibile concorre a definire le relazioni tra gli attori e la progettazione del prodotto (Bruni e Gherardi, 2007). La valorizzazione della lana rustica in capi di

abbigliamento può essere interpretata in vari modi, sempre ricondotti al concetto di sostenibilità: nobilitazione di un rifiuto, diminuzione dell'impatto ambientale, supporto allo sviluppo locale e al *Made in Italy*. A seconda del messaggio che vogliono trasmettere al consumatore finale, gli operatori accentuano l'una o l'altra caratteristica di queste lane, dovendo però sottostare a rigidi vincoli imposti dalla disponibilità di macchinari adatti a specifici tipi di lavorazione. Inoltre, la diffusione di abbigliamento di questo tipo implica un'assunzione importante: che i consumatori incorporino nel loro stile il concetto di sostenibilità, ovvero che siano coinvolti in un processo di transizione a stili di vita più sostenibili (Spaargaren, 2011). In sede di progettazione, si tratta di creare oggetti che rendano *fashion* l'abbigliamento *sostenibile*, continuando a lavorare alla recente diffusione del connubio 'etica-estetica' anche nel campo della moda (Rinaldi e Testa, 2013). In questa direzione un ruolo centrale è assunto dai *fashionist*, gli stilisti o in senso più ampio i creatori di modelli (Giusti, 2009).

L'articolo presenta uno dei principali e più recenti esperimenti di progettazione di capi di abbigliamento in lana rustica: 'FTS-Filiera del Tessile Sostenibile', una sperimentazione del CNR-Consiglio Nazionale delle Ricerche sull'utilizzo di lana rustica italiana per la creazione di abbigliamento *sostenibile* che ha visto la collaborazione di ricercatori afferenti a diverse discipline – sociali, economiche, tecniche – e di operatori del settore tessile. La partecipazione al progetto ha permesso la raccolta di una consistente mole di materiale su come le componenti *tecniche* e *simboliche* vengano assemblate nello strutturare il *design* di un prodotto che presenta difficoltà non di poco conto in merito alla commercializzazione sul mercato. La sua sostenibilità, infatti, è difficile da comunicare al consumatore finale, in quanto si basa sostanzialmente solo sull'utilizzo di una materia prima che altrimenti sarebbe considerata un rifiuto inquinante, ma nello stesso tempo è un'indispensabile attributo di questi capi ai fini della loro commercializzazione, in quanto dal punto di vista della vestibilità presentano notevoli svantaggi in termini di spessore del tessuto, pesantezza e ruvidità.

La letteratura recente a cui si rifà il presente lavoro è riconducibile alla *social practice theory*, il cui scopo non è l'analisi di individui, prodotti e tecnologie quali agenti 'atomizzati', bensì la comprensione delle *pratiche* in cui agiscono congiuntamente tre piani distinti: l'azione umana, gli strumenti a disposizione e il contesto sociale (Sahakian e Wilhite, 2014; Reckwitz, 2002; Shove, 2003; Warde, 2005; Ropke, 2009; Spaargaren, 2011). Recuperare la materialità dell'agire comporta due principali conseguenze:

da un lato assume importanza analizzare come gli attori sociali utilizzano gli strumenti di cui vengono a disposizione, e quindi tenere in conto di come la tecnologia influenza il modo di fare le cose e ne è al contempo cambiata. Dall'altro occorre indagare gli aspetti legati alla legittimazione delle pratiche, ai valori attribuiti dalla comunità, alle convenzioni collettive tacitamente accettate. La commistione di fattori tecnici, cognitivi e culturali risulta particolarmente evidente nei tentativi di rinobilitare la lana rustica italiana: la produzione di capi di abbigliamento con questa materia prima presenta infatti delle peculiarità su un piano sia tecnico-operativo, sia simbolico. In particolare, tre fasi risultano centrali: i) la *strutturazione di una filiera* in cui siano riuniti macchinari adeguati e tecnici competenti; ii) il *design del prodotto*, messo a punto da *fashionist*, stilisti, creativi che conoscano le caratteristiche della lana rustica e riescano a creare abiti che le valorizzino nascondendone al contempo i difetti, quali pesantezza e ruvidità; iii) la *produzione simbolica*, in cui gli operatori danno ai capi un valore simbolico in termini di sostenibilità e si fanno garanti nei confronti dei consumatori del valore dei prodotti, permettendo loro di riconoscerlo e di identificarsi (Hirsch, 1972; Bourdieu, 1979; Giusti, 2009). Queste tre fasi sono strettamente interdipendenti, e la loro interrelazione genera un determinato *design* del prodotto finale.

Nel resto dell'articolo viene presentata la sperimentazione e vengono illustrati i primi risultati sulla reazione dei potenziali consumatori, seguono infine le conclusioni.

La progettazione della sostenibilità

Con *lane rustiche*, più in precisione, intendiamo lane di pecore da latte o carne con fibra grossolana e ordinaria. In quanto sottoprodotto della produzione lattiero casearia, questa materia attualmente viene smaltita come rifiuto speciale o venduta all'estero per la produzione di tessuti di bassa qualità o per l'arredamento: sono in particolare gli imprenditori dei lavaggi, già contoterzisti e ora commercianti, che raccolgono la lana autoctona dagli allevatori, riconoscendole un valore bassissimo, e la rivendono in Cina, India e Russia. Ad oggi si contano alcune decine di esperienze di trasformazione della lana rustica (Cariola et. al., 2014), che vedono gli operatori collegati in reti in cui pochissimi soggetti molto specializzati, in particolar modo nelle lavorazioni a monte della filiera (la trasformazione della materia prima in filato) fungono da punti nodali, perseguendo strategie di accumulazione di conoscenza ed esperienza, ora

partecipando a progetti finanziati pubblicamente (come il CNR-FTS qui presentato) ora rifiutandosi di diffondere il sapere acquisito. Di conseguenza, la differenziazione dei prodotti avviene soprattutto nelle fasi finali della lavorazione, in cui si agisce solo in parte sulle caratteristiche di *comfort* dei tessuti, ma soprattutto sulla *progettazione stilistica*. Si ottengono così una serie di abiti piuttosto uniformati rispetto alla cosiddetta 'mano del tessuto' – l'insieme delle sensazioni raccolte quando un tessuto è toccato o manipolato tra le dita (Ibimet, 2011): tendenzialmente ruvidi e pesanti, cercano di trovare il favore del consumatore distinguendosi per il tipo di lavorazione – a telaio o a maglia – per i modelli o i colori.

Il Progetto CNR 'Filiera del Tessile Sostenibile' ha strutturato una cooperazione con aziende tessili dei noti distretti di Biella e di Prato, con una sartoria di Firenze e una maglieria di Torino.

Le aziende biellesi e pratesi hanno lavorato la lana rustica fornita dai ricercatori trasformandola in filato, utilizzando i macchinari applicati alla trasformazione della lana tradizionale e le tecniche che derivano dalla specializzazione locale. Fin dall'Ottocento Biella è specializzata nei tessuti pettinati, più morbidi e fini, adatti all'abbigliamento elegante maschile, mentre Prato in quelli cardati, in particolare nel processo di rigenerazione dei tessuti ricavati dai cosiddetti 'stracci'. I due distretti si differenziano anche per i modelli organizzativi e la loro evoluzione nel tempo, ma sono oggi accomunati da una crisi che tocca particolarmente i comparti della lavorazione della fibra fino alla filatura, dove si rilevano i seguenti fenomeni interrelati:

- esternalizzazione della produzione;
- dismissione di macchinari per la lavorazione della lana;
- necessità degli operatori contoterzisti di diversificare la produzione;
- necessità di investimenti per adattare i macchinari alla lavorazione delle nuove fibre sintetiche.

In questo quadro la lavorazione della lana rustica si è configurata agli occhi di alcuni operatori come una strategia di differenziazione di prodotto diretta a fronteggiare la crisi in atto.

Nel progetto CNR-FTS, in particolare, sono stati coinvolti filatori e tessitori di Prato per produrre tessuti più spessi da trasformare sartorialmente – dalla sartoria fiorentina – in giacche e più in generale coprispalla, e filatori di Biella per ottenere un prodotto più leggero che è stato lavorato dalla maglieria Torinese. Gli operatori hanno lavorato in rete tra loro coordinati dai ricercatori del progetto, in una simulazione della

tradizionale lavorazione per conto terzi caratteristica soprattutto del distretto pratese, in cui un unico imprenditore tessile progetta e vende abiti di cui esternalizza a operatori specializzati ogni fase della produzione.

Il punto fondamentale dell'intero processo di progettazione dei capi è stata la *comunicazione della sostenibilità* mediante le caratteristiche del prodotto finale: il design deve comunicare ai consumatori un valore del capo al di là del basso comfort che questo presenta secondo i canoni contemporanei, e questo valore deve essere declinato in termini di sostenibilità: ma secondo quale declinazione tra le tante possibili?

La declinazione di sostenibilità *ambientale* è richiamata nell'idea di utilizzare un rifiuto come materia prima, quindi si inserisce nella retorica del riciclo, ma da un punto di vista prettamente teorico. Non solo mancano analisi di quantificazione dell'impatto ambientale di queste lavorazioni in comparazione a quelle dello smaltimento della lana in quanto rifiuto, ma anche la trasformazione dei filati (che abbiamo detto essere piuttosto simili tra loro per una serie di caratteristiche) in tessuti e in capi di abbigliamento avviene con una netta differenziazione in termini di spreco di materiale, di utilizzo di altre materie (le cosiddette mischie di lana con filati sintetici o naturali), di tipo di lavorazione (con i macchinari industriali o i telai artigianali) quindi di costi e di *sostenibilità economica*, differenze che si ripercuotono sul prezzo a cui il prodotto è presentato al consumatore finale. La figura 1 presenta queste differenze per la produzione di filati differenti da parte degli operatori coinvolti.

Il tessile sostenibile è high tech o lana rustica? Un'analisi della filiera e dei consumatori

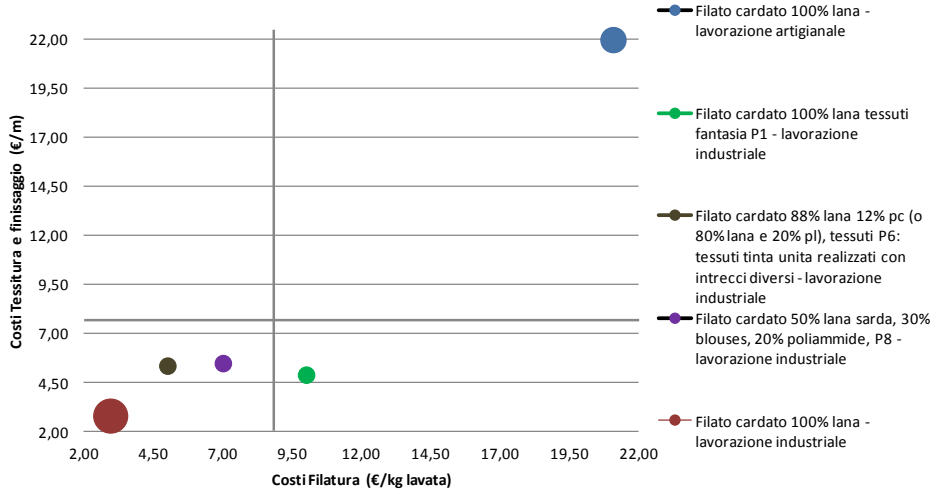


Figura 1 Progetto CNR-FTS. Efficienza produttiva delle lavorazioni industriali e artigianale dei tessuti in lana rustica (costi di produzione). Fonte: elaborazione propria su dati rilevati autonomamente. La dimensione delle palline indica il costo effettivo della materia prima. Le linee spesse indicano le medie di ascissa e ordinata.

Durante la progettazione gli operatori hanno sperimentato mischie e tipi di lavorazione differenti non avendo come obiettivo la riduzione dell'impatto ambientale, ma immaginano i modi con cui nobilitare una materia prima difficile, perché come si è detto è ruvida e spessa, cercando le forme, i colori e gli accostamenti con altre fibre che ne valorizzano meglio le caratteristiche nascondendone i difetti - ad esempio la pesantezza tipica di questi tessuti fa sì che i capi cadano meglio, non perdendo la forma - e che nel contempo aiutino a comunicare ai consumatori i valori a cui si sono ispirati (figura 2 e 3).



Figura 2 I capi di sartoria prodotti sperimentalmente dal progetto CNR Filiera del Tessile Sostenibile.

Questa impostazione è confermata dal fatto che l'attributo di *sostenibilità* del capo non è collegato a un utilizzo di mischie con fibre naturali: i filatori hanno preferito utilizzare fibre sintetiche perché contrastavano meglio i difetti di quelle in lana rustica in quanto a leggerezza e morbidezza, e possibilità di manipolare meglio il tessuto lavorato in modo sartoriale (figura 2).

Nel caso dei tessuti destinati alla sartoria, la sostenibilità comunicata al consumatore è intesa soprattutto come *Made in Italy*, quindi con una declinazione fortemente situata, che richiama il sostegno economico allo sviluppo locale, ed ha quindi un'importante componente immateriale, evocando il recupero di tradizioni e culture territoriali:

'Per distinguerci dobbiamo avere una cosa che abbiamo solo noi e la cosa che abbiamo solo noi non è tessere- perché ce l'abbiamo tutti nel Biellese e in Francia dove queste cose esistono- la cosa che abbiamo noi è questa famosa lana rustica che è già un bel punto di partenza perché determina il valore che avrà il prodotto finale. Quindi, secondo me, sostenibile è già poter dire 'io evito che questa cosa qua diventi un rifiuto, la recupero io'. In più quello che facciamo dà valore aggiunto perché è locale e anche tutta la scelta dei vari passaggi per produrre (...) ad esempio non sono andata in Sardegna dove potevo comprare a meno, ma cerco di continuare ad acquisire valori aggiunti man mano che li trasformo in prodotti' (Int. tessitori).



Figura 3 I capi di maglieria prodotti sperimentalmente dal progetto CNR Filiera del Tessile Sostenibile.

Nel caso della maglieria, invece, è la scelta dei colori a essere giudicata cruciale: non intervenire sul colore della lana, o utilizzare *nuances* che non se ne discostano in modo netto e che richiamano colori presenti in un contesto rurale, è una scelta effettuata per esprimere meglio la sostenibilità del prodotto, dal punto di vista ambientale perché il processo di tintura è molto inquinante, ma anche dal punto di vista culturale perché in questo modo viene restituito il prodotto locale esattamente come si trova in natura, o in un colore che la richiama (figura 3).

Dalla progettazione al consumo

L'offerta internazionale di abbigliamento in lana rustica a livello europeo si concentra nella nicchia di mercato del cosiddetto *country chic*, ma non è da questa pienamente rappresentato. A livello nazionale, non è possibile parlare di un vero e proprio mercato di abbigliamento in lana rustica italiana, quanto piuttosto di pratiche a livello di operatori singoli o di sistemi locali di produzione, spesso supportati da progetti che mirano ad avviare e rafforzare il mercato (Cariola et. al., 2014).

Oggi è cambiata la percezione dei consumatori su cosa è considerato *comodo*: la lana *deve essere* sottile e leggera, anche dato il massiccio utilizzo del riscaldamento, e sono sempre meno diffusi i capi 100% lana: questo crea un abbandono della lana rustica italiana a favore di quelle importate da

Australia e Nuova Zelanda, più fini e leggere, o di altre fibre sintetiche. A tale cambiamento si è accompagnato un abbandono dei macchinari e una progressiva perdita delle competenze sui metodi più efficaci ed efficienti con cui lavorare questa materia prima.

Le titolari della sartoria e della maglieria coinvolte nel progetto CNR-FTS hanno realizzato e progettato due vere e proprie *capsule collection* (una collezione di prova): ciò è servito a capire l'interesse dei consumatori in un situazione reale di mercato. I capi sono stati messi in vendita nella maglieria e nella sartoria nel corso della stagione autunno inverno 2013/2014. La vendita è stata supportata da un'azione di informazione delle clienti svolta dalle titolari con l'ausilio di cartoline e roll-up realizzati ad hoc e disponibili nel punto vendita. In questo modo è stato possibile raccogliere la percezione e la disponibilità all'acquisto della clientela abituale della maglieria composta in prevalenza da donne di ceto medio alto, orientate a un tipo di abbigliamento esclusivo, di alta qualità e disponibili a pagare prezzi medio-alti. L'esperienza è stata completamente fallimentare dal punto di vista della reazione dei clienti. Nessun capo è stato acquistato, evidenziando un passaggio cruciale e dal risultato per nulla scontato: il trasferimento del valore del capo in lana rustica dall'operatore al consumatore.

È stata quindi organizzata una raccolta dati sulla domanda, che ha visto l'elaborazione e la somministrazione di un questionario on-line e face-to-face che ha permesso di raccogliere le risposte di 915 soggetti, in prevalenza donne (68%), ben distribuiti per classi di età, eterogenei per titolo di studio e occupazione, ma con una maggiore frequenza di persone con formazione e livello occupazionale medi e alti, rappresentativi della popolazione italiana superiore ai 15 anni per la situazione familiare. Pur essendo ben rappresentate tutte le classi sociodemografiche, sono sovrarappresentate alcune categorie che interessava particolarmente interpellare in merito all'abbigliamento in lana: le donne e le classi medie e medio-alte (individuare tramite il titolo di studio e l'occupazione). Ai fini della presente analisi sono stati analizzati in particolare i 500 commenti liberi che i rispondenti hanno inserito in relazione alla sostenibilità percepita e al più generale gradimento dei nostri capi, presentati in fotografia anche nel caso del questionario face-to-face, ai fini della comparabilità dei risultati con quello on-line. Il punto di vista dei consumatori, dunque, riguarda specificamente il design della sostenibilità del capo, cioè il giudizio su come è stato reinterpretato il 'rifiuto' lana rustica per nobilitarlo in un capo di abbigliamento.

Il tessile sostenibile è high tech o lana rustica? Un'analisi della filiera e dei consumatori

La declinazione di sostenibilità da parte dei consumatori è decisamente variegata (tabella 1)

Tabella 1 La sostenibilità secondo i consumatori (N=915, risposte multiple).

Secondo lei un capo di abbigliamento 'sostenibile' è sinonimo di ...	N	%
Ecologico	468	51
Etico (es. per le condizioni di lavoro)	381	42
Rispettoso del benessere animale	274	30
Locale	187	20
Artigianale e/o tradizionale	155	17
Altro	10	1

La sostenibilità è intesa soprattutto in termini di rispetto dell'ambiente, delle persone e degli animali. Dalle risposte libere alla voce 'altro' emergono alcuni attributi non previsti del concetto di tessile sostenibile. Un capo deve avere un prezzo ragionevole, accessibile ai più, deve essere duraturo e non dannoso per la pelle: in sintesi deve essere sostenibile per lo stesso consumatore.

Questo significa che se anche la progettazione riesce nel trasferimento del concetto di sostenibilità, non è detto che il valore del capo in termini di *valore ambientale* o *sociale*, seppur percepito, si trasferisca in termini di fruibilità del bene, quindi di *valore monetario* e porti all'acquisto (tabella 2).

Tabella 2 La valutazione dei capi del progetto CNR – Filiera del Tessile Sostenibile.

Acquisterebbe capi di questo tipo?	N	%
No	332	37
Si	558	63
Totale	890	100

Più di un terzo del campione intervistato non acquisterebbe i capi: le motivazioni sono che non ne apprezza la materia prima (il 59 per cento) e lo stile (il 63 per cento). Se nel primo caso si tratta di un mancato

riconoscimento del valore dell'intero progetto, nel secondo caso si tratta di un fallimento della progettazione nel valorizzare la lana rustica in termini di capi di abbigliamento, che gli intervistati individuano in particolare in tagli fuori moda e in colori 'tristi e monotoni'.

In altre parole, spesso il *capo sostenibile* è inteso come il veicolo di un messaggio che, seppur 'buono e giusto', è completamente slegato dal gusto e dallo stile di chi lo indossa: 'Perché i prodotti sostenibili, locali, fatti giustamente con lane locali (immagino anche più reperibili e per questo meno costose), (...), devono sempre essere 'diversi' nei colori, nei modelli, senza rispecchiare i gusti delle persone 'normali'?' (Questionario 45). Si apre così un discorso cruciale nel campo dell'abbigliamento, il vestire come risposta a un proprio bisogno, oggi anche e soprattutto immateriale, legato all'espressione di sé e del proprio stile di vita, elemento fondamentale nelle pratiche di riconoscimento: 'non li indosserebbe mia nonna perché sono troppo moderni e non li indosserebbe mia moglie perché sono troppo tradizionali. Mancano di identità. Il materiale dà l'idea di essere troppo rigido e poco comodo' (questionario 678).

Emerge con forza l'idea che i capi in lana rustica non debbano per forza richiamare una *diversità* e essere individuabili in quanto *sostenibili*, il che spesso significa essere *brutti*, apprezzati solo da una nicchia altamente ideologizzata: l'abbigliamento per definizione non si dovrebbe porre al di sopra dello stile e la moda, e il valore della materia prima può essere un *di più* dato a un capo che permette al consumatore di esprimere il proprio stile e l'adesione a una particolare moda.



Figura 4 Capo tessuto a telaio misto lana e canapa (Phamphile-Bologna).



Figura 5 Capo tessuto a telaio misto lana e seta (Phamphile-Bologna).

Particolarmente apprezzata, ad esempio, è la possibilità di personalizzare il capo agendo sulla sua forma a seconda dell'occasione in cui lo si vuole indossare e la mischia con materiali che ne impreziosiscano l'effetto visivo, una scelta per ora percorsa da pochissimi operatori (Cariola, Moiso e Pagliarino, 2014, vedi figura 4 e 5).

Conclusioni: il tassello mancante tra filiera e designer

Nell'articolo si è presentato il caso di progettazione della sostenibilità dei capi di abbigliamento in lana rustica – un rifiuto dell'allevamento ovino da cui si traggono tessuti tendenzialmente spessi e ruvidi - svolta dal progetto CNR 'Filiera del tessile Sostenibile', mostrando come alcune declinazioni della sostenibilità – la produzione a km 0, il made in Italy, il sostegno allo sviluppo locale, il rispetto delle tradizioni e culture locali - siano state privilegiate rispetto ad altre – l'impatto ambientale – a causa delle necessità tecniche di trasformare una materia prima molto difficile da immettere sul mercato dell'abbigliamento. Analizzando anche il punto di vista dei consumatori, si è giunti a una osservazione di sintesi. L'idea che *sostenibile* si accompagni a un processo produttivo *naturale, tradizionale, locale* è condivisa dai consumatori, ma non lo è altrettanto il fatto che il capo prodotto debba trasmettere questi valori secondo uno stile definito. In particolare, l'immagine stereotipata piuttosto diffusa tra i produttori che si sono confrontati con l'utilizzo di lana rustica (Cariola et. al., 2014) e condivisa dagli operatori del progetto, per cui un capo di lana rustica debba

rimanere del colore naturale del vello, richiamare il folklore del territorio di appartenenza dei pascoli oppure uno stile sartoriale e *country chic*, è considerata dai consumatori un elemento che allontana dall'acquisto del capo, perché lo rende difficilmente o poco piacevolmente fruibile. Detto in altre parole, sembra possibile affermare che nei capi prodotti dal progetto, e mostrati al pubblico nella ricerca di mercato, sia mancato proprio il ruolo dei *fashionist* nel facilitare il *match* tra il design dei modelli e il concetto di sostenibilità incorporato dai consumatori. O meglio, secondo quanto emerso dai commenti liberi nel questionario, il modo in cui i creatori di modelli hanno espresso stilisticamente la sostenibilità può essere apprezzato da una nicchia di nostalgici degli abiti tradizionali e di utenti di sartorie. Uno stile giudicato poco *fashion* soprattutto dai giovani, che non riescono a identificarsi e soprattutto a trovare in esso un mezzo per esprimere il proprio stile, prima ancora che il concetto di sostenibilità incorporato.

Il progetto prevedeva una seconda fase, in cui si sono coinvolte reti italiane di *fashionist* che sono stati invitati a reinterpretare la lana rustica secondo le più recenti tendenze della moda internazionale. I nodi di tali reti sono le scuole di design e le associazioni di promozione dell'artigianalità, in particolare con sede a Milano e Firenze. I risultati non sono valutati nel presente articolo per una questione di sovrapposizione di tempistiche, ma grazie a queste collaborazioni si è rilevato come nella maggioranza dei casi il freno alla diffusione di materiali sostenibili, quale sia la loro declinazione, prima ancora che per resistenze culturali o valutazioni economiche è la mancata conoscenza della loro disponibilità o la difficoltà di approvvigionamento da parte delle reti dei creativi nel campo tessile. I designer coinvolti, in particolare, sottolineano come un elemento cruciale della diffusione di materie prime innovative sia creare reti tra gli operatori di filiera, quali quella strutturata dal progetto, per permettere la circolazione di continui *feed back* lungo la catena di lavorazione: in questo modo è possibile permettere lo sviluppo delle competenze tecniche necessarie per valorizzare al meglio la materia e renderla manipolabile nelle fasi di lavorazione successive. Al proposito si segnala l'impatto di soggetti che mirano a diventare nodi cruciali per lo scambio di materiali in queste reti, quali ad esempio CLASS di Giusi Bettoni, una *eco-library* di filati sostenibili, una sorta di *biblioteca* tattile che mette in mostra - e a conoscenza - i filati giudicati sostenibili in tre showroom a Milano, Londra e New York. Se i tessuti in lana rustica sviluppati nel progetto fossero accettati in questo contenitore, ad esempio, l'expertise sviluppato dagli operatori della filiera

Il tessile sostenibile è high tech o lana rustica? Un'analisi della filiera e dei consumatori potrebbe essere messo al servizio di altri designer, in particolare giovani, che abbiano le competenze per progettare capi che li valorizzino in direzioni non scontate, ma che altrimenti non saprebbero della possibilità di utilizzarle.

Bibliografia

- Bourdieu, P. (1979) *La distinction. Critique sociale du jugement*. Paris: Editions de Minuit.
- Bruni, A. e Gherardi, S. (2007) *Studiare le pratiche lavorative*. Bologna: il Mulino.
- Camera Nazionale della Moda Italiana (2012) *Il manifesto della sostenibilità per la moda italiana*. Milano.
- Cariola, M., Moiso, V. e Pagliarino, E. (2014) *Economia del tessile sostenibile. La lana italiana*. Milano, Franco Angeli.
- Gallico, L. (2000) *La lana*. Vigliano Biellese: Eventi e Progetti Editore.
- Giusti, N. (2009) Il designer di moda, «man-in-the-middle» e intermediario culturale. *Rassegna Italiana di Sociologia*, XLX (4), 579-607.
- Hirsch, P.M. (1972) Processing Fads and Fashions: An Organization Set Analysis of Cultural Industry Systems. *American Journal of Sociology*, 77 (4), 639-659.
- Ibimet (2011) *progetto di ricerca 'Filiera del tessile sostenibile'*. Rapporto di ricerca CNR Ibimet, Firenze.
- Hethorn, J. e Ulasewicz, C. (2008) *Sustainable Fashion. Why now? A conversation about issues, practices, and possibilities*. New York: Fairchild Books.
- Reckwitz, A. (2002) Toward a theory of social practices: A development in culturalist theorizing. *European Journal of Social Theory*, 5 (2), 243-263.
- Rinaldi, F. e Testa, S. (2013) *L'impresa moda responsabile*. Milano: Egea.
- Røpke, I. (2009) Theories of practice – new inspiration for ecological economic studies on consumption. *Ecological Economics*, 68 (10), 2490-2497.
- Spaargaren, G. (2011) Theories of practices: Agency, technology, and culture. Exploring the relevance of practice theories for the governance of sustainable consumption practices in the new world-order. *Global Environmental Change*, 21 (3), 813-822.
- Shove, E. (2003) *Comfort, Cleanliness and Convenience: The Social Organization of Normality*. Oxford and New York: Berg.

MONICA CARIOLA, GRETA FALAVIGNA, VALENTINA MOISO, ELENA PAGLIARINO

Unioncamere (2012) *Green Italy - L'economia verde sfida la crisi. Rapporto 2011*. Rapporto Unioncamere - Fondazione Symbola.

Warde, A. (2005) Consumption and Theories of Practice. *Journal of Consumer Culture*, 5 (2), 131-153.

Estetiche dei futuri come estetiche dei contrasti. Processi *design driven* di costruzione condivisa di scenari

Flaviano CELASCHI, Elena FORMIA*
Università di Bologna

Esistono tradizioni condivise, e socialmente accettate, rispetto all'estetica dei futuri. Narrazioni letterarie, cinematografiche, progettuali architettoniche o di design le hanno utilizzate per costruire, di volta in volta, all'interno di esse, plot diversi e originali. Ma se progettare significa, etimologicamente, 'gettare in avanti', in che modo il design può intervenire nei processi di costruzione delle narrazioni di futuri? È possibile educare pratiche allargate d'immaginazione di scenari? Attraverso quali strumenti e modelli? Per fornire una possibile risposta a questi quesiti, sono proposti tre livelli di lettura e approfondimento. La prima parte del paper introduce il rapporto tra Advanced design, processi di progettazione e intermediazione dei futuri possibili; la seconda esplicita quali fattori e piani di lavoro derivanti dalle future sciences siano solitamente impiegati per determinare estetiche strutturalmente allineate a macro-scenari accondiscesi e prevalenti e propone un modello per la costruzione di scenari design driven; la terza legge una serie di esempi evidenziando i livelli e i fattori che hanno contribuito alla struttura della rappresentazione e rileva che, in molti casi, s'impiega la tecnica dell'accostamento d'immaginarsi fortemente divergenti, quasi schizofrenici per creare una condizione di dualità in contrasto, di habitat per il bene e il male che possono così essere percepiti come mescolati e interagenti nella costruzione di visioni di futuro attraverso le sue estetiche condivise.

Keywords: *Advanced Design; interdisciplinarietà; scenari design-driven.*

Introduzione

Costruire scenari futuri rappresenta uno degli elementi fondamentali del processo progettuale, soprattutto nell'Advanced design, un'area dell'innovazione non *hard-technology driven*, naturalmente proiettata verso

* Corresponding author: **Elena Formia** | e-mail: emformia@gmail.com

il futuro anteriore o verso processi di progettazione complessi. Lo studio degli scenari, e dei servizi o delle merci da questi suggeriti, è un tema che, nell'ultimo decennio, ha riscontrato un vasto interesse da parte della letteratura scientifica del settore, impegnata a restituire metodologie, approcci e strumenti utilizzati nella creazione di alternative di futuri sostenibili (Schwartz, 1991; Schoemaker, 1995; Celaschi, 2000; 2008; Jegou e Manzini, 2000; Bertola e Teixeira 2003; Bertola e Manzini 2006; Anggreen e Van Der Voort, 2009; Celaschi e Formia, 2012).

A partire da questo contesto, il contributo propone una riflessione dedicata ai processi di costruzione di estetiche dei futuri attraverso l'elaborazione di un modello di riferimento per la progettazione di scenari *design driven*. Sottesa a questa rappresentazione vi è la constatazione di quanto le scienze del design si occupino sempre più dei processi e sempre meno dei prodotti (Celaschi, De Marco e Formia, 2008; Celaschi e Formia 2010; Celaschi e Formia, 2012; Celaschi e Franzato, 2012) e che esista legittimamente un problema di 'estetica dei processi' che deriva dal fatto che estetica significa percepire e conoscere attraverso la mediazione dei sensi (Menna, 2001; De Fusco, 2010; Garroni, 2010; Pasca, 2010; Lupo, 2011). In questo senso non esiste nulla di più etico che verificare che il processo di rappresentazione dei futuri sia esteticamente condiviso dal più elevato numero di persone che ne subiranno le conseguenze.

Advanced design, mediazione di saperi e intermediazione dei futuri possibili

La progressiva maturazione metodologica del design e il suo ingresso nella comunità scientifica internazionale, dopo essere stato per decenni annoverato come poco più di un insieme di pratiche artistiche per la determinazione della forma delle merci industrialmente prodotte, ha generato una progressiva frammentazione con lo sviluppo di sotto-ambiti di ricerca orientati a più specifiche problematiche. Fra questi l'Advanced design (Celaschi, 2008a; 2008b; Celi, 2010) studia i processi di progettazione secondo due grandi insiemi di caratteristiche: la progettazione a lungo termine temporale (*long term design*) e i processi non convenzionali di progettazione (progettazione senza committenza, innovazione continua, *extreme design*, progettazione 2.0, ecc.) L'Advanced design, nato nei settori a elevata complessità come l'*automotive*, oggi può assumere gran parte delle pratiche di studio delle *future sciences* e fa dell'anticipazione (Arnaldi e Poli, 2012) un tema centrale del proprio interesse, soprattutto in relazione

alla capacità tipica del designer di creare scenari, intesi come contesti dentro ai quali si rende possibile immaginare nuove merci e servizi per un futuro anteriore.

Il ruolo del designer nell'anticipazione è importante perché, materializzando beni e servizi futuri e collocandoli in scenari che possono essere raccontati visivamente o attraverso prototipi e modelli realistici, riesce a far condividere un'idea di futuro a un elevato numero di persone non dotate di particolari competenze o attitudini alla rappresentazione. Il disegno figurativo del futuro lo rende vivo, credibile, opinabile, scambiabile, condivisibile, realizzabile attraverso la partecipazione di un numero di soggetti interessati più elevato possibile.

L'Advanced design s'innesta pertanto all'interno di un dibattito nel quale la narrazione dei futuri possibili da stretto predominio della fantasia (fantascienza) è diventata dominio accettato della scienza e tematica chiave nei processi politici di condivisione sociale del futuro desiderato e verso il quale sono orientati gli sforzi di trasformazione dell'ambiente, del territorio e della società.

Tema centrale di questo approccio è rappresentato dal ruolo mediatore del designer all'interno di sistemi di saperi tradizionalmente non comunicanti tra loro (scienze esatte e scienze umane e sociali, arte ed economia, mitologia e medicina, scienze ambientali e poesia, ecc.), ovvero nei territori dove il 'giovane design' (Penati, 2001) s'innesta e lavora nel quotidiano delle relazioni interculturali. Il potenziale dell'innesto di temi tecnologici su problemi umanistici, di visioni artistiche su narrazioni oggettive tipiche dell'economia e dello studio dei bisogni, è forte e la costruzione di scenari nei quali si rende possibile meticcicare elementi provenienti da territori storicamente in-comunicanti del sapere umano ne è una naturale conseguenza.

Questo sforzo del design, e in particolare dell'Advanced design, di mediare tra saperi giunge a emergere proprio nell'istante storico di crisi dell'intermediazione dentro alla quale il cittadino, l'utente, il consumatore vogliono, anzi pretendono di riannodare una relazione diretta tra loro (il successo di applicativi *software* come Zopa nel prestito *peer to peer*; Kickstarter, eBay, ecc., lo dimostrano), ma soprattutto con i produttori di conoscenza, con gli scienziati, con gli agenti di trasformazione sociale e tecnologica, allo scopo di controllare e influire direttamente sul risultato ottenibile (Celaschi, 2008a; 2008b), la cui importanza e determinazione nel futuro della vita appare sempre più indelebile.

Pertanto poco tempo dopo aver appreso e sperimentato la costruzione sistematica dei futuri possibili attraverso la realizzazione degli scenari, e in essi di nuovi servizi e merci, i designer si scontrano con l'inevitabile necessità di condividere le loro pratiche alla cittadinanza. Il lavoro del designer diventa, più o meno di colpo (rispetto ai lunghi tempi del cammino della conoscenza), quello di formare il più elevato numero possibile di persone, cittadini, consumatori, utenti, destinatari, alle pratiche d'immaginazione dei futuri e di allenamento alla condivisione delle dinamiche, comprese quelle estetiche, che li determinano. Per questo motivo, i primi passi di questo processo di costruzione di futuri attraverso pratiche *design driven* è grossolano: l'obiettivo principale si è subito evoluto in 'condivisione' rispetto al perfezionismo a cui avrebbe probabilmente teso l'esperto professionista del cinema o della narrativa *science fiction oriented*. In questa approssimativa attività di condivisione i forti contrasti, come quelli tra 'apocalittici' e 'integrati', giocano un ruolo potenzialmente molto interessante e produttivo per spiegare e condividere ai più i processi di costruzione di scenari futuribili. Per questo motivo il contributo si sofferma sulle estetiche che sembrano caratterizzare questi due estremi del processo di narrazione dei futuri.

Estetiche dei futuri come estetiche dei processi: Un possibile modello

Le estetiche materializzano il futuro in quanto esito finale ottenuto al tempo 'x', ma suggeriscono e permettono di ragionare rispetto al processo attraverso il quale si è arrivati a ottenere quella specifica situazione rappresentata. Oggi siamo collettivamente più attenti all'estetica del risultato che all'estetica del processo, ma l'estetica del processo è eticamente più importante di quella legata al risultato, pur essendo più difficile da condividere. Nell'Advanced design, che è un approccio attento proprio alla forma dei processi come strategia per l'ottenimento dell'estetica dei risultati, questo aspetto dell'estetica non appare per nulla marginale, anzi. È per questo motivo che nel presente studio poniamo l'attenzione intorno a uno strumento semplice e facilmente condivisibile per rappresentare un esito futuro, mentre ben altra profondità e significato deve assumere, a nostro avviso, il tentativo di condividere i processi attraverso i quali si arriva a ragionare di futuro anteriore in modo socialmente condiviso (Arnaldi e Poli, 2012).

Fattori quali:

- l'ampiezza e la profondità della previsione,
- la finestra temporale della previsione,
- lo scopo della previsione e del cambiamento sociale che ci si attende,
- il numero di soggetti e di tipologie di utenti che s'intende considerare come coinvolti nella previsione e nel processo di raggiungimento del risultato previsto (costruzione dei futuri),

sono parte intima della condivisione di processo che avranno conseguenze estetiche, nonché etiche, sull'esito finale a cui si perviene.

Il nostro approccio si fonda, pertanto, sulla costruzione di un modello di riferimento semplificato per la progettazione di scenari *design driven*, basato sull'interpolazione di due tipologie di elementi: da una parte sono rappresentati i livelli strutturali per la costruzione di un qualsiasi ambiente futuro (sociale, fisico-spaziale, biologico, ecc.); dall'altra sono introdotti tre fattori di permutazione (immutabilità, latenza di futuro o cambiamento radicale) (Cinquegrani, 2012). Dall'incrocio di questi elementi, reso visibile da una semplice matrice di combinazioni possibili, possono nascere numerose visioni di futuro che, tuttavia, possono essere ricondotte a una duplice natura di fondo nella quale si riconoscono le visioni degli 'apocalittici' o degli 'integrati'.

Macro-scenari prevalenti: apocalittici vs integrati

La riflessione che desideriamo mettere in evidenza agisce attraverso una apparente forte semplificazione che mette in contrasto 'pessimisti' e 'ottimisti' sul futuro (Barbieri Masini, 2012). Per individuare due estremi chiari e condivisi, noti a tutti e facili da riconoscere, di macro-scenari futuri prevalenti abbiamo utilizzato due categorie esasperate come quelle a cui Umberto Eco, avviando lo studio semiotico delle comunicazioni di massa in Italia, dedicò un saggio nel 1964: gli 'apocalittici' e gli 'integrati'. A distanza di cinquant'anni, in una recente intervista, l'autore ha affermato: 'Gli apocalittici erano quelli che avevano la tendenza estrema di condannare tutta la cultura di massa, gli integrati ci sguazzavano dentro senza porsi grossi problemi morali. Erano entrambi un po' una caricatura'.

Queste due tradizioni estreme sono storicamente condivise e socialmente accettate attraverso l'assunzione avvenuta nei processi narrativi, dalla Bibbia a Isaac Asimov, dalla tragedia greca all'attuale cinematografia digitale (figura 1).

In epoca contemporanea grande peso hanno avuto, per esempio, visioni 'catastrofiste', di distruzione totale della civiltà umana; basti pensare ai

primi romanzi fantascientifici come *The last man* di Mary Shelley del 1826 o *The Scarlet Plague* di Jack London del 1912. Altri scenari hanno trasformato il progresso tecnologico in una minaccia 'iper-tecnologica'; un genere che ha vissuto grande successo a partire dall'avvento del 'robotismo', passando per gli 'androidi' (*Blade runner* di Ridley Scott del 1982), fino ad arrivare alle provocazioni artistiche di Michael Burton (*Future Farm, Nanotopia*). Immaginari di 'morfosi' propongono invece il sopravvento dell'elemento naturale e alieno o la mutazione del genere umano, come nelle narrazioni di Herbert George Wells, quali *The time machine* del 1895, o Richard Matheson quali *I am a legend* del 1954.

Al contrario, la dimensione 'integrata' dei macro-scenari può essere rintracciata in narrazioni utopiche (Mazzoli e Zanchini, 2012) nelle quali si propone una visione sostanzialmente positiva del futuro. Come spiega Gillo Dorfles (2012):

siccome iùtopia si può scrivere 'utopia', ma anche 'eùtopia', perché in inglese si pronunciano nello stesso modo, ecco che sin dal principio si verificò un grosso abbaglio, per cui l'utopia [...] non è stata tanto 'un luogo che non esiste' quanto un luogo buono, una buona utopia.

Narrano di un futuro integrato, ad esempio, le visioni di 'decrescita felice', di ritorno all'età dell'oro, di paradiso in terra, come quella proposta da William Morris nel romanzo *News from nowhere* del 1891 che rappresenta una Londra rigenerata dalla scomparsa della proprietà privata e del denaro, abitata da persone amiche e serene, solcata da un Tamigi allo stato di natura. Una società senza nemici, senza differenze di classe e violenza, senza conflitti naturali, senza abomini tecnologici, profondamente 'sostenibile', è, ad esempio, il modello di *dreamland* proposto nel 1965 da Walt Disney per Epcot (Experimental Prototype Community of Tomorrow), poi sfociato nei celebri parchi tematici. Un futuro integrato può anche ruotare attorno all'idea di 'big-brother', ovvero di un controllo totale della società garantito dall'alto, come quello alla base della trama del romanzo di Aldous Huxley *Brave new world* del 1932 dove l'umanità è finalmente libera da preoccupazioni, sana, tecnologicamente avanzata, priva di povertà e guerra, permanentemente felice.

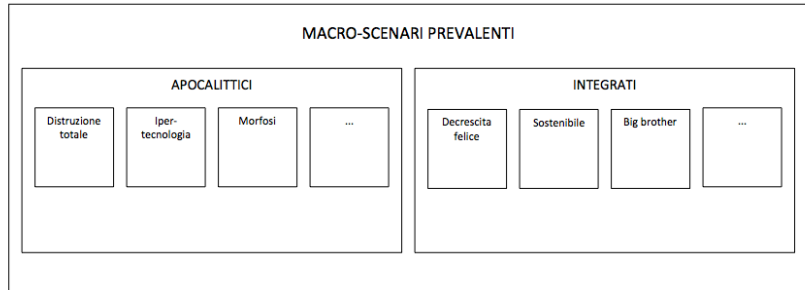


Figura 1 Possibili esempi di macro-scenari estremi presi come riferimento del modello di condivisione dei processi di costruzione di estetiche dei futuri.

Layer e fattori chiave per la costruzione di scenari futuri

La matrice che proponiamo (tabella 1) ha la caratteristica della semplicità poiché il suo primo scopo è l'essere paradigmatica del processo che, a un aumento del numero e della qualità dei livelli usati per descrivere lo scenario (righe) e a un aumento parallelo della precisione nella descrizione dei fattori chiave (colonne), corrispondono progressivi aumenti del dettaglio, della complessità, dell'approssimazione che si possono ottenere. Parafrasando il linguaggio del design è come se passassimo dalla descrizione di un *concept* (che si può ottenere con uno schizzo grafico), al livello di un progetto di massima che necessita di disegni tecnici, fino a un progetto esecutivo che utilizza il rendering 3D e vari stratagemmi di stratificazione del disegno per rappresentare intimamente ogni dettaglio del progetto.

Descrivendo i singoli componenti della matrice semplificata, nelle colonne si trovano i fattori che sono antropologicamente invariati, come, per esempio, il bisogno di rappresentare architettonicamente il potere attraverso l'edificazione di costruzioni e l'organizzazione di celebrazioni a esso dedicati, fattore che travalica un tempo storico e che attraversa la storia dell'uomo ben oltre i tempi delle civiltà e le varie latitudini geografiche di localizzazione. I fattori latenti sono quelli che solitamente nel design, come nelle scienze sociali, vengono chiamati 'segnali deboli' di futuro, ossia elementi che già esistono nel presente e che dalla realtà odierna si presume possano attraversare il futuro esprimendo conseguenze ancora più importanti che nell'oggi: per esempio, l'uso della rete cellulare telefonica che già invade in modo rilevante il presente e che sembra poter essere l'infrastruttura per determinare il cosiddetto 'internet delle cose' mettendo in connessione oggetti inanimati e persone in uno scenario futuro

d'intermediazione diretta degli oggetti tra loro. Infine i fatti mutanti, ovvero quei fattori che non sono per nulla presenti nella realtà odierna, ma che si considerano poter essere i vettori forti del cambiamento promesso dallo scenario: per esempio, l'uso del nostro corpo come strumento di comunicazione invece dell'uso di artefatti a noi esterni, oggi indispensabili per comunicare (quindi l'impiego dell'energia umana per alimentare ricettori ed emittenti impiantati all'interno del nostro organismo o addirittura l'uso dei nostri tessuti epiteliali come ricettori adatti a comunicare con altri analoghi dispositivi biologicamente naturali).

A queste colonne, nel modello semplificato proposto, contrapponiamo almeno tre piani su cui devono essere compiute delle scelte per poter descrivere lo scenario: come sarà fatto il modello sociale che vogliamo realizzare (*layer* sociale); quali forme avranno gli oggetti materiali che abitano i luoghi antropizzati e che ci permettono di vivere (*layer* materiale); infine quali caratteri avrà la natura nella quale il sistema antropizzato si confronta (*layer* biologico).

Il caricamento della matrice determina la costruzione di un brief per lo scenario che contiene gli estremi determinanti del futuro atteso, ma che lascia al designer (o al cittadino evoluto nell'uso di strumenti di rappresentazione e narrazione dei futuri) la materializzazione estetica del risultato verso cui si tende, tenendo presente che, per quanto attiene all'estetica dei processi per raggiungere in modo condiviso il risultato, si rende ancora vistosamente indispensabile un cluster di professioni e di saperi che sono ancora lontane dal poter essere autodeterminate dai cittadini.

Tabella 1 Esempio di matrice semplificata che sta alla base del modello di condivisione dei processi di costruzione di estetiche dei futuri.

FATTORI CHIAVE	COSTANTI	LATENTI	MUTANTI
<i>LAYER</i>			
SOCIALE			
MATERIALE			
BIOLOGICO			

In questo processo di costruzione di scenari futuri attraverso la comprensione e l'uso della matrice semplificata che suggeriamo, sono in gioco diversi livelli estetici legati a differenti fattori chiave della rappresentazione del mondo che desideriamo privilegiare o enfatizzare in chiave sociale/biologica/tecnologica/materiale. Per esempio, nella chiave

tecnologica esistono processi di rappresentazione che possono assumere la totale simbiosi tra dimensione organica e forma della tecnologia, che arrivano a ottenere l'esito di 'una macchina biologica' che processa fatti relazionali, ma assume sembianze organiche perfette: il robot. Nella chiave sociale la rappresentazione può enfatizzare la fine del mercato e dello scambio tramite denaro verso una dimensione relazionale tutta egualitaria e basata sul contributo che i soggetti possono cerebralmente, aristocraticamente o democraticamente, assumere nelle relazioni interpersonali o gruppalì (ognuno dà per il ruolo che possiede, oppure ognuno dà per le sue facoltà mentali, ecc.). In questo caso nella rappresentazione del futuro potrà assumere una differente importanza e centralità la forma dei luoghi artificiali nei quali le persone si riuniscono e deliberano: ci saranno cattedrali che permettono fisicamente l'aggregazione tra persone oppure dimensioni digitali di condivisione totalmente immateriali.

Estetiche dei futuri come estetiche dei contrasti: Una rappresentazione

Una delle tesi della presente ricerca è legata alla necessità di rendere fruttuoso il dualismo tra macro-scenari prevalenti ('apocalittici' e 'integrati'), concentrando l'attenzione su alcuni passaggi intermedi, punti di transizione che prendono in considerazione le dinamiche relazionali sottese alle estetiche dei futuri, intese come 'forme-processo' (Lupo, 2011). Pertanto, un'attenzione particolare viene posta sulla dimensione dell'estetica per 'contrasto', dove cioè il processo si basa sulla creazione di un voluto attrito nella rappresentazione della narrazione del futuro.

Modelli contemporanei di questo approccio possono essere rintracciati nella letteratura e nel cinema fantascientifico. Pur nella consapevolezza che la fantascienza non rappresenti l'unico ambito al quale riferirsi in termini di 'estetica dei contrasti', ed anzi sapendo che una delle esigenze intrinseche della narratività consista proprio nel procedere per contrasti tra una mancanza e la sua eliminazione, questo specifico genere sembra proliferare per introdurre la riflessione, accostando dinamiche narrative e progettuali (Bleecker, 2009; Johnson, 2011; Kirby, 2011; Penati, 2013). Ad esempio, la letteratura e la filmografia cosiddetta 'post-apocalittica' insistono proprio su una dimensione di contrasto tra macro-scenari, in cui il futuro nasce, dopo l'apocalisse, come una rigenerazione fondata sui fattori latenti preesistenti:

It seems significant that in the late twentieth century we have had the opportunity, previously enjoyed only by means of technology and fiction, to see after the end of our civilization – to see in a strange prospective retrospect what the end would actually look like: it would look like a Nazi death camp, or an atomic explosion, or an ecological or urban wasteland. (Berger, 1999)

Anche la corrente letteraria del 'cyber punk' (Sterling, 1986) s'inserisce in una prospettiva in cui la fertilità della combinazione di contrasti – il regno dell'*high tech* e il moderno *pop underground* – genera nuove opportunità narrative e, quindi, nuove estetiche.

Contrastante è la dimensione dei robot presentata da Isaac Asimov ad esempio in *The complete robot* del 1982, dove la disumanità delle macchine sta proprio nella loro intrinseca onestà; o la metropoli del 2026 immaginata da Fritz Lang, dove alla paradisiaca città dei ricchi, corredata da espressionistici giardini sospesi, si contrappone la città sotterranea dei lavoratori (*Metropolis* del 1926); o l'opposizione, poi rivelatasi relativa e superabile, tra matrix (illusione)/mondo (realtà), macchine/uomini proposta dalla trilogia cinematografica diretta dai fratelli Wachowski dal 1998 al 2003; o, ancora, il dualismo tra mondi del film di animazione *Wall-e* del 2008, dove la salvezza del genere umano è affidata a un robot più umano degli umani, e di *The Hunger Games* (romanzo di Susanne Collins del 2008 e film di Gary Ross del 2012), in cui al florido regime totalitario di Capitol City si contrappongono tredici distretti assoggettati.

Per rappresentare la dimensione del contrasto attraverso il processo precedentemente presentato, appare particolarmente interessante soffermarsi su estetiche dei futuri nate dalla cultura progettuale architettonica e di design. Utopici e distopici scenari futuri hanno attraversato la storia della progettazione contemporanea, a partire dai visionari Claude-Nicolas Ledoux ed Etienne-Louis Boullée fino ai giorni nostri:

Visionary projects [...] cast their shadows over into the real world of experience, expense and frustration. If we could learn what they have to teach, we might exchange irrelevant rationalizations for more useful critical standards. Vision and reality might then coincide. (Drexler, 1960)

Emblematica è, in questo senso, una recente installazione a opera di Konstantin Grcic (esposizione *Konstantin Grcic. Panorma*, Vitra Design

Museum, Weil am Rhein, marzo 2014). *Urban Space* propone un'istantanea dello spazio urbano del futuro: una realtà stratificata, plurima, piena di ambiguità che è insieme utopica e distopica, giocata sull'opposizione tra sogno e paura, la cui decodificazione finale spetta all'osservatore, considerato come cittadino evoluto.

Gli esempi di estetiche dei futuri di seguito enunciati, pur nella brevità della descrizione e nel rischio di riduzione della complessità storico-critica, forniscono una lettura che si avvale del processo rappresentato nella matrice semplificata proposta (tab. 1). Alcuni criteri hanno guidato la scelta: in primo luogo, le visioni ricoprono una periodizzazione vasta ed eterogenea; in secondo luogo, la tecnologia rappresenta, in tutti i casi, il livello estetico prevalente: si parla quindi di futuri altamente tecnologici e d'incremento delle opportunità offerte dalle nuove tecnologie d'informazione e comunicazione. L'estetica tecnologica però si sposa con un livello di rappresentazione (biologico, materiale, sociale), da cui nasce il contrasto. Infatti, in tutti i casi è possibile rintracciare, nella trama sottesa, situazioni di convivenza tra macro-scenari ('apocalittici' e 'integrati') materializzata attraverso l'enfasi posta su singoli livelli legati a vari fattori.

Layer di contrasto tecnologico-biologico: il corpo

Professori presso il Royal College of Art di Londra, Anthony Dunne e Fiona Raby (2001; 2013) hanno sviluppato nell'ultimo decennio il concetto di Critical design, poi materializzato in una serie di progetti/istallazioni. Tra questi, *Foragers* (2010) propone uno scenario immaginifico in cui, a una 'apocalittica' visione di progressiva carenza di cibo a livello planetario, si contrappone un 'integrato' e sostenibile uso di tecnologie biomimetiche e della biologia di sintesi (fattore latente) per far fronte al naturale bisogno dell'uomo di nutrirsi (fattore costante). Indossati sul capo o sul corpo, questi strumenti estendono le membra umane, la bocca e gli organi interni, agendo come micro-unità di elaborazione che sostengono i naturali processi evolutivi (fattore mutante). All'interno di questa estetica, il contrasto si materializza attraverso il ritorno a un immaginario primitivo e, al tempo stesso, ipertecnologico:

Dunne e Raby immaginano di ingegnerizzare, nonché di affidare in 'outsourcing', il tratto gastrointestinale usando nuovi strumenti capaci di facilitare la digestione e la metabolizzazione di cibi difficilmente commestibili che già esistono intorno a noi - come radici coriacee e sostanze a base di cellulosa di cui si cibano molti altri

mammiferi e uccelli, e di cui gli stessi nostri antenati erano in grado di nutrirsi (Antonelli, 2011).

Layer di contrasto tecnologico-materiale: lo spazio abitativo

Consacrato come uno dei designer visionari del XX secolo, Joe Colombo ha fatto della progettazione del futuro una professione: 'A Colombo toccò il destino strano di chi, superando il momento, predice il futuro' (Romanelli, 2005). La capacità di creare visioni abitative ha caratterizzato gran parte della sua produzione degli anni sessanta e settanta connotata da una costante tensione tra macro-cosmo contenitore e micro-cosmo di artefatti. Nel progetto di ri-allestimento del suo appartamento di via Argelati a Milano (1970), dove vengono inseriti il 'Rotoliving' e il 'Cabriolet Bed', o nell'ambiente 'Visiona I', presentato a Colonia nel 1969 su commissione del gruppo chimico Bayer, Colombo propone un'idea di abitare nel futuro 'integrata', basata su una convivenza armonica tra uomo e nuovi media (fattore latente), che s'inserisce, però, in un 'apocalittica' fine del modello abitativo borghese, un modello tradizionalmente accettato, anzi promosso dalla società e dalla cultura italiana contemporanea (fattore costante). All'interno di questa estetica il contrasto si genera nella creazione di spazi-non spazi (fattore mutante), di macchine 'come amplificatori di emozioni e megafoni per l'inconscio', d'interfacce movibili e delocalizzabili in grado di potenziare le capacità e i desideri dell'uomo (Romanelli, 2005).

Layer di contrasto tecnologico-sociale: la città

Nel 1935 l'architetto americano Frank Lloyd Wright propone il modello di 'Broadacre City', poi teorizzato in contestuali e successivi scritti, tra cui *The Living City* del 1958. Un modello urbano che riveste un ruolo fondamentale nella storia dell'architettura contemporanea, per la fortuna esercitata a livello internazionale. Alla critica della crescita verticale della città americana considerata come catastrofico destino involutivo, l'architetto propone il modello 'integrato' di città diffusa sul territorio, basato sull'uso generalizzato dell'automobile (fattore latente) e sul ritorno al ruralismo. Dunque, un'ipotesi di democrazia tecnologica che libera il cittadino 'inurbato', una specie di schiavo o addirittura di animale; una società composta da modeste unità che però non è arcaica nelle sue tecniche. In questa immagine di contrapposizione tra modello verticale e orizzontale, tra abitante delle caverne e nomade, tra *prairie houses* e aeroplani, il concetto di 'capitalismo organico' presuppone un contrasto sociale nella misura in cui pone un'alternativa al denaro (fattore mutante),

pur mantenendo l'inalienabilità del diritto sociale alla proprietà della terra (fattore costante) (Cohen, 2000).

Conclusioni

La presentazione dei progressivi livelli di esplicitazione del concetto di estetica del futuro presentati nei paragrafi precedenti rappresenta la risposta che gli autori hanno fornito ai quesiti posti inizialmente.

In primis, l'estetica è intesa come percezione, esperienza e conoscenza degli aspetti e del valore delle cose attraverso la mediazione dei sensi. In quest'accezione, l'estetica di processo' diviene una 'forma-immateriale' il cui fine è quello di creare una rappresentazione, quindi una 'forma-materiale' di futuro condivisibile. Attraverso le logiche relazionali tipiche dell'Advanced design e rifacendosi a metodologie proprie delle scienze dell'anticipazione, lo studio propone un modello (la matrice presentata nella tab. 1), inteso come un possibile 'processo-guida' per realizzare visioni condivise di futuri, ovvero esteticamente accettate.

All'interno di questa riflessione, e attraverso l'uso di questo strumento semplificato, lo studio introduce poi il concetto di 'estetica del contrasto', intesa come una declinazione esemplificativa del modello proposto, nella quale, andando a insistere su uno o più livelli e fattori chiave della rappresentazione, si concretizzano situazioni antitetiche esasperate, visioni schizofreniche di habitat per il bene e il male che convivono e, anzi, si fertilizzano positivamente. È proprio nella dimensione narrativa del contrasto che viene rintracciato un ruolo potenzialmente interessante e produttivo per spiegare e condividere i processi di costruzione degli scenari di futuro possibile.

Attribuzione dei paragrafi

La ricerca sottesa a questo testo è frutto collettivo degli autori, che sono poi singolarmente responsabili della stesura dei seguenti paragrafi: Flaviano Celaschi, 'Advanced design, mediazione di saperi e intermediazione dei futuri possibili', 'Estetiche dei futuri come estetiche dei processi: un possibile modello', 'Layer estetici e fattori chiave per la costruzione di scenari futuri'; Elena Formia, 'Macro-scenari prevalenti: apocalittici vs integrati', 'Estetiche dei futuri come estetiche dei contrasti: una rappresentazione', 'Conclusioni'; le parti non specificate sono state stese collettivamente.

Bibliografia

- Anggreeni, I. e Van Der Voort, M.C. (2009) *Supporting Scenario-Based Product Design and Its adapters: An Informal Framework for Scenario Creation and Use*. In Smith, M.J. and Salvendy, G. (a cura), *Human Interface and the Management of Information. Designing Information Environments. Lecture Notes in Computer Science*. Berlin Heidelberg: Springer.
- Antonelli, P. (2011) *States of Design 04: Critical Design*. [Online] Available from: <http://www.domusweb.it/it/design/2011/08/31/states-of-design-04-critical-design.html>. [Accessed: 8th May 2014].
- Arnaldi, S. and Poli, R. (2012) *La previsione sociale: introduzione allo studio dei futuri*. Roma: Carocci.
- Barbieri Masini, E. (2012) *Introduzione. Perché pensare al futuro oggi?* In Arnaldi, S. and Poli, R. *La previsione sociale: introduzione allo studio dei futuri*. Roma: Carocci.
- Berger, J. (1999) *After the End. Representations of Post-Apocalypse*. Minnesota: University of Minnesota Press.
- Bertola, P. and Teixeira, C. (2003) *Design as a knowledge agent: How design as a knowledge process is embedded into organizations to foster innovation*. *Design Studies*, 24 (2), 181-194.
- Bertola, P. and Manzini, E. (2006) *Design multiverso: appunti di fenomenologia del design*. Milano: Poli.design.
- Bleecker, J. (2009) *Design Fiction. A short essay on design, science, fact and fiction*. [Online]. Available from: http://drbfw5wflxon.cloudfront.net/writing/DesignFiction_WebEdition.pdf. [Accessed: 7th November 2014].
- Celaschi, F. (2000) *Il design della forma merce*. Milano: Il Sole 24 Ore Edizioni.
- Celaschi, F. (2008) *Il design come mediatore tra saperi*. In Germak, C. (a cura), *Uomo al centro del progetto*. Torino: Allemandi.
- Celaschi, F. (2008) *Design mediatore tra bisogni*. In Germak, C. (a cura), *Uomo al centro del progetto*. Torino: Allemandi.
- Celaschi, F., De Marco, A. e Formia E. (2008) *Design Culture: From Product to Process*. In Cipolla, C. and Peruccio, P.P. (a cura), *Changing the Change. Proceedings*. Torino: Allemandi.
- Celaschi, F. e Formia, E. (2010) *Design cultures as models of biodiversity: design processes as agent of innovation and intercultural relations*. *Strategic Design Research Journal*, 3 (1), 1-6.

- Celaschi, F. e Formia, E. (2012) *Education for Design Processes*. In Formia, E. (a cura), *Innovation in Design Education*. Torino: Allemandi.
- Celaschi, F. and Franzato, C. (2012) *Design of organizational innovation scenarios. Results of an action-research within a security doors company*. Paper Presented at the Proceedings of Projecting Design 2012 - Global Design Bridge, Comulus Conference, Instituto Profesional DuocU, Santiago, Chile.
- Celi, M. (a cura) (2010) *AdvanceDesign. Visioni, percorsi e strumenti per predisporre all'innovazione continua*. Milano: McGraw-Hill.
- Cinquegrani, R. (2012) L'approccio per scenari tra passato, presente e futuro. In Arnaldi, S. and Poli, R. (a cura di), *La previsione sociale: introduzione allo studio dei futuri*. Roma: Carocci.
- Cohen, J.L. (2000) *Prefazione*. In Wright, F L. (a cura di), *La città vivente*. Milano: Edizioni di Comunità.
- De Fusco, R. (2010) *Il gusto come convenzione storica in arte, architettura, design*. Firenze: Alinea.
- Dorfles, G. (2012) *L'utopia è architettura*. In Mazzoli, L.E e Zanchini, G. (a cura di), *Utopie: percorsi per immaginare il futuro*. Torino: Codice.
- Drexler, A. (1960) *Visionary Architecture*. New York: Museum of Modern Art.
- Dunne, A. and Raby, F. (2013) *Speculative Everything: Design, Fiction, and Social Dreaming*. Cambridge: The MIT Press.
- Garroni, E. (2010) *Creatività*. Milano: Quodlibet.
- Lupo, E. (2011) Design, arts and 'aesthetics of innovation'. *Strategic Design Research Journal*, 4 (2), 40-53.
- Jegou, F. e Manzini, E. (2000) *The Construction of Design-Orienting Scenarios*. Final Report, SusHouse Project, Faculty of Technology, Policy and Management. Netherlands: Delft University.
- Johnson, B. D. (2011) *Science Fiction Prototyping: Designing the Future with Science Fiction. Synthesis Lectures on Computer Science*. San Rafael (CA): Morgan&Claypool Publishers.
- Kirby, D. A. (2011) *Lab Coats in Hollywood. Science, Scientists, and Cinema*. Cambridge: The MIT Press.
- Mazzoli, L. e Zanchini, G. (a cura di) (2012) *Utopie: percorsi per immaginare il futuro*. Torino: Codice.
- Menna, F. (2001) *Profezia di una società estetica*. Milano: Editoriale Modo.
- Pasca, V. (2010) *Il design nel futuro*. [Online] Available from: http://www.treccani.it/enciclopedia/il-design-nel-futuro_%28XXI-Secolo%29/. [Accessed: 8th May 2014].

- Penati, A. (2001) *Giovane è il design: nodi contemporanei della didattica per il progetto*. Milano: Poli.design.
- Penati, A. (2013) *È il design una narrazione? Design e narrazioni*. Milano: Mimesis.
- Raby, F. (2001) *Design Noir: The Secret Life of Electronic Objects*. Basel: Birkhäuser.
- Romanelli, M. (2005) *Joe Colombo: una profezia interrotta. Accenni per un ritratto progettuale*. In Kries, M. and Von Vegesack, A. (eds.) *Joe Colombo: l'invenzione del futuro*. Milano: Skira.
- Schwartz, P. (1991) *The Art of the Long View: Planning for the Future in an Uncertain World*. New York: Currency Doubleday.
- Schoemaker, P.J.H. (1995) Scenario Planning: A Tool for Strategic Thinking. *Sloan Management Review*, 36 (2), 25-40.
- Sterling, B. (1986) *Mirrorshades*. London: Grafton Books-Paladin.

The rhetoric and rhetoricality of Bio-Design

Marjan Groot*
Leiden University

This paper discusses the relevance of rhetorical concepts as powerful tools to address the workings and meaning of visual Bio-Design reflecting on biotechnology. It examines the visual rhetoric of two Bio-Design projects making for an effective agency of emotions on the one hand and intellectual considerations on science and ethics on the other hand. The paper applies common devices from classical rhetoric for the first time to these contemporary forms of visual design and combines rhetorical analysis with the art historical methodology of iconography and iconology. In so doing, the paper aims to produce meaning while acknowledging a common method of semiotics and literary studies as to personal subjectivity of the viewer as narrator.

Keywords: Bio-design; rhetoric; affect; life sciences; biotechnology

Introduction

In this paper I will discuss two recent Bio-Design works: *myBio dolls* by Elio Caccavale and *Chrissy Caviar*® by Chrissy Conant. I will do so to investigate the relevance of rhetorical devices and concepts used since antiquity and re-used over time, to achieve particular affects in beholders of contemporary design works today. Though both works exist as tangible design and art and were exhibited as such, this paper focuses on their rhetoric as effectuated through web-images and web-sites. As is standard practice in art and design historical methodology, examining images in depth makes for further exploration of context and agency. The effect and affect of the images concern our position *vis à vis* possibilities and promises of biotechnologies and evolve as the process of giving meaning proceeds. I will start with some relevant achievements in the field of biotechnology.

* Corresponding author: **Marjan Groot** | e-mail: m.h.groot@hum.leidenuniv.nl

Biomedical and life sciences and Bio-Design

As many philosophers and philosophers of science have argued – on the annual British Design History Society conference of 2008 for example by Bruno Latour (2009) – the notion of design has come to concern the ever-growing impact of biomedical and life sciences on our lives and society. On a practical level this happens through ongoing research in technologies of which biotechnology is only one. Life sciences research – today the No.1 science in terms of scope and impact – has given us In Vitro Fecundation (IVF), the cloning of animals, the designing of transgenic animals, the cloning of human sperm stem cells and of human embryos with normal gene functioning. Our genes were ‘mapped’ by the Human Genome Project and some genes were patented. More recently came the engineering of non-natural synthetic cells (Synthetic Biology). All this research has an international competitive dimension, debates on genomics and bioethics are also international (Sleeboom, 2004), as is the unprecedented growth of partnerships between science and commerce (Koepsell, 2009; Rose and Rose, 2013). On a theoretical level the impact of biotechnologies happens through scientific principles, theories and epistemology. These principles and theories are all directed by the discourse of the ‘Science Establishment’, which, to quote Jeffrey Burkhardt on animal biotechnology, ‘has the power to define what is or is not real, reasonable or rational’ (Burkhardt, 2008, p. 403). The rhetoric of science is that of progress and rational thinking directed by theories and proof.

Bio-Design projects as discussed in this paper respond to outcomes of life sciences and bio-engineering without using bio-engineering techniques or moist media such as eggs, sperm, stem cells, genes, tissue, microbes or bacteria. Practising designers have an international focus and ground their projects in actual scientific research. Their works address ethical, legal and societal issues of technologies (ELSI) on individual persons or our society in general terms alongside the specialist discourse and scholarship (Groot, 2013). As British designers and teachers Anthony Dunne and Fiona Raby – who stimulate these speculative design projects in Europe via their Design Interactions Department at the Royal College of Art in London – wrote in 2005 in the Centre Pompidou Museum exhibition catalogue *D.Day, le design aujourd'hui*, Bio-Design asks philosophical questions that we can be confronted with in everyday life. Their own project *Evidence Dolls*, presented as ‘critical scenarios’ in this museum, features one hundred Dolls as hypothetical products sold in a fictional shopping mall to be used by women to store DNA samples from potential partners, helping them gain an

increased sense of control in dating with men (figure 1). In the context of a famous museum of modern and contemporary art, the dolls act to provoke discussion amongst young single women about the impact of genetic technology on their choice of lifestyle and partners.



Figure 1 Anthony Dunne and Fiona Raby, Evidence Dolls in the Centre Pompidou, Paris, 2005. Website of the artists.

Biotechnological research, however varied, is commonly justified by the strongest argument in favour of any technology: a utilitarian objective which is usually considered to be morally 'good'. Biotechnology can obviously be of vital importance for anyone who has a particular physical problem, whether this is declared to be genetic or not. In the case of cloning human sperm stem cells, for example, it aims to contribute towards treating infertility problems in men. Most of us will find it easy to sympathise with this and similar goals. There may nonetheless also be reasons for caution with regard to the technologies. These were first put on the political agenda by environmental and animal rights activists. When compared to militant actions and interventions by such activists, Bio-Design indeed seems not to provoke any real serious engagement. We may, however, reconsider engagement when we examine its power to persuade.

Bio-Design, the narrator and meaning

Designers who are involved with Bio-Design call their projects *speculative* or *critical* design or *social fiction*. Underlining their narrative potential – which they actually borrow from semiotics and literary studies – they present the projects as fictional scenarios that can be observed in the same way as literary fiction can be read (Ward and Wilkie, 2009; Dunne and Raby, 2013). With *narratio* being an ancient rhetorical device, we can thus speak about the rhetoric of narratives of Bio-Design. Rhetoric is the art of persuasion. It aims to convince a spectator or audience and trigger affective responses. The term ‘rhetorality’ designates 20th-century theoretical reconsiderations and extensions of rhetoric.

Regarding the immediate affective workings of Bio-Design on a suggested beholder, two things must be noted in general. First, the rhetoric of affect of Bio-Design (like that of other visual media) is primarily concerned with the visual and the material. Rhetorical figures and tropes are ‘translated’ in visual properties such as shape, colour, composition and texture. Any written texts are secondary, though certainly not unimportant as we shall see. Second, the rhetoric of Bio-Design is not the traditional classical rhetorical practice of privileged men and meant for speaking in court and for politics, as analyzed by (among others) Brian Vickers in his reference work on the history of rhetoric (1989; also Richards, 2008; Brummett, 2011). The rhetoric of Bio-Design is the activity of male and female artists/designers and has an artistic intention. Though Bio-Design is exclusive and does not have the outreach of popular visual media, such as advertisements or film, it does meet the rhetoric (and rhetorality) of these forms of contemporary popular culture. The projects do recognise Quintilian’s statement that an orator must keep in touch with what ordinary people can think and feel and that emotions are better expressed in a ‘visual’ vernacular than in specialist learned formulas. Yet, without rules and manuals to apply in the classical manner, Bio-Design also operates according to devices that classical rhetoric explores. Famous classical written texts on rhetoric – notably those by Plato, Aristotle, Quintilian, and Pseudo-Longinus – did not consider the workings of visual art or design but later on they did inspire historical forms of visual art and design in achieving or evoking particular effects and affects, and these also acquired a theoretical construct (Vickers, 1989, pp. 341-374; Campanelli, 2008, pp. 48-84).

When I consider Bio-Design as a visual rhetorical narrative that is not situated in a classical context or referring to classical texts, I apply rhetorical devices and strategies in order to gain a better insight into its workings; its

workings, or agency, being entangled with possible meanings. These rhetorical devices and strategies are part of the invention and style of the design project and the intention of the designer. The actual workings, effect and affects, however, are established in mutual contact between design project and beholder or audience, and may go beyond intentions of designers to stimulate a personal dialogue with biotechnologies that the projects address. It may examine what is at stake as in the important rhetorical practice of arguing on both sides of an issue (i.e. *in utramque partem*), a dialectic which Plato also considered to be the goal of rhetoric (Vickers, 1989, p. 16; Richards, 2008, p. 71). Through this, while introducing ambivalence, the projects produce meaning.

Design historical narratives discuss the working of designs most often via written sources, with a suggested viewer/reader/observer who is a stand-in for the design historian herself and who might be addressed when effects are examined by this historian as narrator. This way, the narrator demonstrates any possible effects and affects that a visual design may achieve. Extra sources used to strengthen the dialogue are the narrator's choice. This mode of engaging also acknowledges that effect and affect of Bio-Design on individual persons will depend on knowledge, susceptibility towards visual signs, gender, age, etc.; even Aristotle recognised that various emotions appealed to audiences from various life stages (Vickers, 1989, pp. 296-304). Subjectivity makes for many affective reactions and effects, not just one. Let us now, in the outlined mode of thought, consider the two cases.

Rhetoric of hybridity and utility

Genetic manipulation brings up the issue of hybridity of species, as in human-to-animal embryonic, foetal or adult chimeras, and in transgenic organisms. The project *myBio dolls* by Elio Caccavale presents the consequences of newly created chimeras and hybrids in a quite literal way by means of dolls. For example, *myBio spider goat* refers to a 2001 biotechnical experiment in which goat's chromosomes were manipulated to include a spider gene so that their mammary glands could produce a tougher strand of silk. Hence, Caccavale gives *myBio spider goat* a spider's web attached to its udder and shows the silk (figure 2). Exposing what is at stake, informing by means of the web image of a boy holding the transgenic animal persuades by a mildly affective power, which appeals both to the intellect and to feelings of tenderness with regard to the boy. Affective devices are a certain friendliness, good will, and *enargeia* (illumination and actuality, with

MARJAN GROOT

the rhetoric of figurative elements mirroring real-life emotional states, Vickers, 1989, pp. 300-304). The image appeases, is soft and pleasurable, though it does have a confrontational element by having the boy actively point at the animal; so feelings of anxiety and concern may be aroused. Its minimal colouring: overall white with black accents of the boy's hair and eyes and the goat's hoofs, and both the goat's udder and boy's face standing out in their pinkness, works to suggest neutrality, cleanliness and sterility, and to give it a factual medical and biotechnological aura which may work reassuringly as well. The entire image arouses a visual equivalent of *ethos*.



Figure 2 Elio Caccavale, *myBio dolls: myBio-spider goat*, 2003. Courtesy Elio Caccavale.

By indicating results of applied technologies in future human and animal lives by the 'figure' of a child, which has its life still to live, Caccavale does not really seem to question the issue if we could seriously adhere to a moral relevance of species boundaries, as discussed by Robert and Baylis (2008), and Streiffer (2008). In its innocence, the child represents generations which need to come to terms with the technologies. On the other hand, silence here may imply that these technologies are good for human animals and make the design supportive of the utilitarian argument for biotechnology, an issue brought forward by Morton (2008, pp. 373-375), Smith (2008), and also Blackburn (2001, pp. 70-80).

By calling his designed pets *Utility Pets* and suggesting that they become a kind of ‘life insurance’ for humans, Caccavale points to a utilitarianism which deals with the human side of design and leaves animal ethics aside. This is perhaps more of an issue with a design for *Knockout Pig* responding to xenotransplantation, which is aimed at producing transgenic animals with human-compatible medical uses (Caccavale and Ashcroft, n.d.; Exhibition catalogue, 2008, pp. 31, 112-113). *Knockout Pig* was inspired by a real-life case of liver transplantation from a pig to a young patient who was acutely ill while awaiting a liver from a human donor. Caccavale then imagines we will have a personal piglet to provide us with a new organ or other bodily ‘material’ in case we should need it. The future personal donor-animal has been genetically modified through injection with human DNA to make its organs or whatever else successfully integrate in the body of its human recipient and owner. We may want to establish new and closer emotional relations with our future donor-animals, keeping them at home and treating them well. For this, Caccavale designed additional products which function as the visual ‘proofs’ that Quintillian found helpful in arousing strong emotions in a plea, such as a pink ‘pig-snout’ smoke cap for human owners to prevent the pig from inhaling cigarette smoke and stay as healthy as possible (figura 3). The rhetoric of *phantasia* is strong here.



Figure 3 Elio Caccavale, Smoke Cap and Inhaler for Knockout Pig, 2003–2004, exhibited at the symposium Trans-Natural, Amsterdam, 13 March 2010.

MyBio dolls and *Utility Pets* do not have the rhetorical nature of inviting a protest against current biotechnical practice aroused by a rigorous emotional *pathos* of strong emotions – they lack a ‘yuck factor’, which in the

ethical debate refers to the instinctive hostility and revulsion against transgressing species boundaries (Robert and Baylis, 2008, p. 381). Caccavale's narrative is, as 'rhetorical didactics', educating by way of giving *information (docere)* through *demonstrating* (Ottmers, 1996, pp. 123-124). The restrained rhetorical innocence of toys makes for an ambiguity, for, as Burkhardt has pointed out, if the toys of projects such as Caccavale's inform and educate, on another level they may cause human concerns about the impact of science to diminish and even generate more funding for, as he critically writes, 'the biotechnology enterprise' (Burkhardt, 2008, p. 404).

Rhetoric of gender and race

My second example relates rhetoric to the performativity of the female gender and body via the project *Chrissy Caviar*[®] (Conant, 2001-2002). The project from 2001-2002 by artist Chrissy Conant, allows for an intricate rhetorical interplay of image, texts, invention and concept.

The caviar around which the project revolves, is stated to be a product of The Chrissy Conant Ovaries in New York and offered as 'The World's Most Expensive Luxury Consumable Item'. Packed in a glass jar, like most good caviar, its label bears the image of a young woman: she is Chrissy Conant herself, lying in a sensual pose, dressed up in sexy evening wear and smiling at the viewer. Her happiness (*eudaimonia*) makes the matter light, resembling *occupation* or *paralipsis*, something which in classical rhetoric was perceived as being the manner of women (Richards, 2008, p. 71). In one of her hands, she holds up the delicacy for us to notice; it is surrounded by a magic glow (figure 4, left).



Figure 4 On the left: Label *Chrissy Caviar*[®], 2001-2002. Courtesy Chrissy Conant. On the right: Jan Massys, *Flora*, 1559. Kunsthalle, Hamburg (Accessed 28 February 2014).

The woman's gesture of demonstrating proof is an effective technique and her image on the jar follows sensible rhetorical advice (by Pseudo-Longinus) in honouring unsurpassed examples of a hugely successful pictorial composition of famous seductive nudes in Western European high art (as with *aemulatio*), with predecessors such as the *Venus of Urbino* (1538) by Titian, *Olympia* (1863) by Edouard Manet, or – very convincing in its composition resemblance – a *Flora* from 1559 by Jan Massys (figura 4, right). In Western visual culture the image of these female nudes has always been exposed to and connected with an ideal of beauty and eroticism. The woman on the label of *Chrissy Caviar*[®], however, is individualised and easy to identify with. She also refrains from a too-confrontational physical sexuality – that is, if we accept evening dresses exposing female flesh only through naked shoulders, arms and feet as being fairly common and mainstream. By contrast, the renaissance *Flora* with her visible near-naked breasts has much more sex appeal.

Chrissy Conant redesigned the existing design of the Beluga caviar in glass jars with their familiar labels to become the artist's own product. A jar does not contain caviar, but one of Chrissy's own eggs in human tubal fluid, packed by the Private IVF Center in the USA. She presented these in a commercial display refrigerator 'deli-style' resembling that of a fishmonger (figura 5). There are twelve jars in all because hormone treatments made Chrissy 'produce' about twelve eggs during ovulation, a number which references the commercial package design of a dozen hens' eggs. This rhetoric of display combines a humorous metaphor with a most convincing presentation.

MARJAN GROOT



Figure 5 *Chrissy Caviar®* display, 2002. Courtesy Chrissy Conant.



Figure 6 *My Chrissy Caviar® Floaty Pen* with the tiny white egg floating halfway, 2014.

On the website the project *Chrissy Caviar®* follows the general format of web texts and additional web pages add persuasive arguments to the visual

design. A page with 'General Information' presents a photo of two hands holding a jar of 'caviar' in front of a woman's belly near the womb; a powerful close-up figure. A page with 'Reproductive History' shows a photo of female legs and a hand which in its sensuality contrasts with the listing of facts on her health, previous pregnancies and contraception that she has used. The 'Education/Intelligence' profile compares a portrait photo of Chrissy as child with her as an adult. Positive rhetorical proof of the good quality of her eggs is given by listing her education and study results, indicating an intelligence level which is much higher than average. As an extra, the website offers the *Chrissy Caviar*[®] Floaty Pen. This has a tiny white egg floating from oviduct (nature) to jar (technique) (figura 6). The gadget's rhetoric of banality adds to the commercial nature of the product.

While the artist says that her project describes the desire of single Western women in their thirties, like her, looking for ways to get a baby and offering their eggs on the Web in order to interest a male 'fertiliser', one can also claim that its rhetoric goes far beyond this. It certainly demands a focus on her biological sex and gender, and cannot only be related to the 'liberating' opportunities that IVF promises for women. The website keeps relating women to their reproductive 'function' and implies that traditional gender roles – such as caring for and raising children – are female tasks. The image of the woman, Chrissy Conant, on the jar represents her egg as well, even if this egg is not at all identical to her identity and her appearance/look as a woman. The reproductive and genetic technologies which lay behind the project *Chrissy Caviar*[®] further lead to a medical gaze at the female body. The rational rhetoric of technologies and this gaze turn eggs into things and consumption goods – which CHRISSY CAVIAR in big letters emphasises – and women into suppliers, subjected to quality demands and controls. This function, however, contradicts the un-medical sexy image on the jar. The visual rhetoric of commercial websites for IVF services advising women on offering their eggs convey a similar contrast between emotions and the technological process. As feminist science scholars have been arguing since the 1980s, the new bio-power of technologies is making changes to the system of biological reproduction and common socio-cultural patterns of parenting, (Merchant, 1980; Plumwood, 1993; Keller, 1985; 1992; Cranny-Francis et al., 2003).

The matching of egg cells with Caucasian caviar permits the adding of the 'race' factor to the rhetoric of gender. In the past, the term 'Caucasian' designated physical properties of the peoples in the geographical areas of Europe (minus the Lapps and other Finnish peoples), western Asia to the Ob

River in Siberia, the Caspian Sea and Ganges, and the peoples from North Africa. The German philosopher Christoph Meiners coined the term 'Caucasian race' in 1785 but changed his geographical categorisation of two groups – Caucasian and Mongolian – in 1793 into two main races: the 'white and beautiful' and the 'dark and ugly' (Meiners, 1793, pp. 4-6); shortly after, professor of medicine Johann F. Blumenbach referred to *varietas Caucasia* (Blumenbach, 1795, p. 206). Today, the term Caucasian still marks white people in the official files of the US Census Bureau. Through having a white complexion and with both parents being Caucasian, maternal ethnic ancestry registered as white Russian/Tatar and paternal ethnic ancestry as Polish/British, plus by mentioning Caucasian on the caviar label, Chrissy Conant is actually registered as Caucasian (Conant). Her eggs are therefore literally Caucasian as well. They make the Beluga sturgeon (figure 7) a surprising metaphorical stand-in for Chrissy herself.



Figure 7 A sturgeon.

The most desirable Beluga caviar is Caucasian. Its eggs are relatively big and colour grades range from dark grey-black to light grey and whitish.

White Iranian Beluga appears to be one of the best and most expensive varieties; it is called *Almas*, a word that means 'diamond' in Persian. This allows the positioning of caviar eggs as a metaphor for human skin and race types. The roots of the word 'caviar', which involves Turkish *hāvyār*, Persian *chāviyr* and Latinised Greek *cavealium*, also support the rhetorical play with the variety of peoples and cultures in the area.

With the ancestry of the sturgeon dating back 120 to 250 million years, the particular Beluga caviar comes from a centennial female sturgeon. Beluga is Russian for the sturgeon species *Huso huso* and it incorporates the word for 'white' (which can also refer to a white beluga whale). While the brilliant white egg in Chrissy's hand depicts her premium white caviar variety literally as a round and shining pearly diamond, the website of

Chrissy Caviar[®] refers to this extremely rare white Beluga sturgeon. Via the metaphor of the sturgeon, the *Chrissy Caviar*[®] label thus supports the white race as a desideratum on the human egg trade market. The sturgeon itself also has some reproductive limitations. It needs as long as human beings to become sexually mature and even though a female sturgeon can produce around 10 million eggs, there is a fair chance that only one egg will grow into a mature fish. The beluga sturgeon can produce eggs once in seven years and it has only ten chances to reproduce itself (Saffron, 2002, p. 31).

Considered an endangered species, it is now protected by importation bans in the US on Beluga caviar from the Caspian Sea and Black Sea. The rhetoric of the caviar jar here may be that of counteracting the diminishing of the white race.

All this contextualising which I as narrator have so far explored works as the piling up of proofs to defend a plea, as with original Greek rhetoric. It fits in with the image, the invention and concept, and the narrative texts of the caviar project. What is more, skin colour, race and population are all significant in the commercialisation of the market for human female egg donation. Imitating commercial websites, *Chrissy Caviar*[®] alludes to IVF and the opportunities that this biotechnology offers for women. Web advertisements try to persuade Asian women to become salaried egg donors. Selling their biological 'capital' gives them the opportunity to consume to their hearts' desires and imitate the lifestyle presented by Western designer brands, which target their advertisements and commercials for the most part at women as stereotypical thoughtless consumers. It also has social and ethical relevance to new forms of market-driven and individualised eugenics, which biotechnologies present through enhancement and designer children. Shopping for eggs and sperm leads on to choosing sperm and eggs with desirable genetic properties, as eggs from fashion models, meeting a desire for physical beauty, or from women with a high IQ already are expensive products on the American market (Sandel, 2007, pp. 63-83; Dickenson, 2012, pp. 20-38).

The socio-cultural and ethical problems of IVF and egg commerce in general seem to be veiled by the smiling woman on the *Chrissy Caviar*[®] label. This is its overall rhetoric of contradiction and antithesis, for the design project in fact sharpens the problems that reproductive technologies raise by irony (*dissimulatio*) and exaggeration. It does so in the form of *and* disguised as a personal testimony of 'practical' and 'creative' solutions sought after by single women.

Indirect and direct workings of Bio-Design

Having discussed the agency of static images mediated by the web in terms of rhetorical figures with a form of common art historical iconology, it is important to realise that the context in which Bio-Design is presented can be of relevance for other particular rhetorical effects. I shall give a few examples which are different from static images and information on a Website. The project *Biojewellery* by bio-engineer Ian Thompson and design researchers Nikki Stott and Tobie Kerridge (2006) was initially presented and documented in the context of people working in a hospital and an arts college. Classes and workshops by artists and designers, such as Adam Zaretsky in 2007, Jennifer Willet in 2008, Anna Dumitriu in 2009, Boo Chapple in 2009 and 2012, had students from the Humanities department and the Faculty of Medicine of the University of Leiden experiencing wet-lab practices. When attending a seminar I could easily see how these classes stimulate awareness of the ethics of arguments on 'common' biotechnology (also Burkhardt, 2008, p. 405). The students mixed body fluids, created funguses, or unexpectedly found themselves confronted with chicken embryos in a blender, which produced a veritable shock – an affective reaction which reminds of the unprecedented experience of 'sublimity' (Vickers, 1989, p. 307) or even the romantic rhetorical 'sublime'.

When concrete results of Bio-Art and Bio-Design projects are presented as exhibits in galleries or temporary exhibition spaces they may draw the attention of anyone interested in any form of reflection on contemporary technologies in a more playful and relaxed way. This happened with symposia on nature and technology *Trans-Natural* in Amsterdam, the Netherlands. The events, which I attended in 2010 and 2011, took place in an empty and unused newspaper office. In the basement, documentation and results of Bio-Design projects by Rachel Armstrong, Tobie Kerridge and Elio Caccavale were exhibited next to other contemporary projects on art and technology (figura 3). This presentation made the Bio-Design projects look arty and 'not of this world'. Additional workshops by these designers made visitors act through their designed material mediators without having experienced the very first presentation of the project. But further explanation is always needed to understand a thing such as the exhibited smoke cap of figure 3.

In this respect it is important to notice that calling a work or object 'design' in an art museum or gallery context already is a rhetorical act in itself. The label 'design' de-contextualises this design from everyday life and simultaneously re-contextualises it with regard to notions of originality,

beauty, form and meaning. Presentations in art museums certainly acknowledge this rhetoric. By contrast, bio-technologies presented in the context of other museum types, such as a *natural* history museum, a *science, technology* and *design* museum, or a *national* history museum, make for other rhetoric. They are likely to support the rhetoric of scientific progress and celebrate scientific national achievements by properly and 'correctly' explaining the technologies.

Any reflection afterwards, as done in the first half of this paper, misses the directness of workshops and practices that are part of the designers' rhetorical engagement with the public (for this goal e.g. Thompson, Stott and Kerridge, 2006). However, and as we saw, without having attended a symposium or workshop, the project publications and the Internet importantly inform about Bio-Design projects through designed websites of artists and designers, and also through reception from first-hand interviews and comments (e.g. Regine, 2007, 2009). Mediated by the Internet, Bio-Design may invite responses from all over the world regardless of a specific context. Although Bio-Design as a Western expression reflects Western concerns, aesthetics and ethics, these may not be so exclusive, as technologies are global as well. Examining these media only, the route followed is different but need not be less effective when it comes to both the rhetoric of and reflection on the issues that Bio-Design addresses.

Conclusion

This paper has shown for two discussed works, *myBio dolls* by Elio Caccavale and *Chrissy Caviar*[®] by Chrissy Conant, that Bio-Design narratives of social and speculative fiction imply rhetoric of workings. Examining the works through illustrations on the Web, classical observations on rhetoric were useful in considering an agency of affect of these types of Bio-Design on a personal beholder – the present author – where they allow for a re-contextualization via notions of morality, education, gender and race as a form of contemporary rhetoric or rhetoricality, all involved with issues and consequences related to biotechnology. To even basically understand what they address, both projects also need explaining when exhibited in real life. But further examination through the method of art historical iconography and iconology, importantly fed by written sources and adding notions of subjectivity of the beholder makes for a varied production of meaning. In so doing, *Chrissy Caviar*[®] opens up a more complex narrative than *myBio dolls*. Disconnected from their original context of exhibitions, however, mediation

of chosen Bio-Design projects by the Web filters the rhetorical potential of design that exists through the connotations of material properties of real objects, brought about by the senses. Their 'distance' in visual rhetoric seems to make any anxieties far removed from our material bodies and unjustified. In this way, these cases follow real biotechnologies that are also no longer perceivable in haptic terms as 'material'. We might conclude that their highly relevant 'rhetoric of distance' imitates the visual distance of communication in science.

References

- Armstrong, S.J. and Botzler, R.G. (eds.) (2008) *The Animal Ethics Reader*. London: Routledge.
- Blackburn, S. (2001) *Ethics. A Very Short Introduction*. Oxford: Oxford University Press.
- Blumenbach, J.F. (1795) *Über die natürlichen Verschiedenheiten im Menschengeschlechte*. Leipzig: Breitkopf.
- Brummett, B. (2011) *Rhetoric in popular culture*. London: Sage.
- Burkhardt, J. (2008) *The inevitability of animal biotechnology? Ethics and the scientific attitude*. In Armstrong, S.J. and Botzler, R.G. (eds.) (2008), *The Animal Ethics Reader*. London: Routledge.
- Caccavale, E. (2009) Web. [online] <http://www.eliocaccavale.com/> [Last accessed: 10th May 2014].
- Caccavale, E. and Ashcroft, R. (n.d.) *Hybrids: Towards a New Typology of Beings and Animal Products*. London: Wellcome Trust, University of the Arts, London, Central Saint Martins College of Art and Design.
- Campanelli, V. (2010) *Web Aesthetics. How Digital Media Affect Culture and Society*. Rotterdam: Nai publishers.
- Conant, Ch. (2001-2002) Web. [online] <http://www.chrissycaaviar.com> [Last accessed: 25th March 2014].
- Cranny-Francis, A., Waring, W., Stavropoulos, P. and Kirkby, J. (2003) *Gender Studies. Terms and Debates*. Basingstoke: Palgrave Macmillan.
- Crosthwaite, J. (2001) *Gender and bioethics*. In Kuhse, H. and Singer, P. (eds.), *A Companion to Bioethics*, Oxford: Blackwell Publishing.
- Dickenson, D. (2012) *Bioethics. All that matters*. London: Hodder Education.
- Dunne, A. and Raby, F. (2005) *Pour un design critique consommer des monstres*. In Exhibition catalogue, *D.Day. Le Design Aujourd'hui*. Paris: Centre Pompidou.
- Dunne, A. and Raby, F. (2013) *Speculative Everything. Design, Fiction, and*

- Social Dreaming*. Cambridge: MIT Press.
- Exhibition catalogue (2005) *D.Day. Le Design Aujourd'hui*. Paris: Centre Pompidou.
- Exhibition catalogue (2008) *Design and the Elastic Mind*. New York: MOMA.
- Groot, M. (2013) *Visualizing genes and gender in speculative realities of the natural and the synthetic*. *Jaarboek voor Vrouwengeschiedenis*, 33, 79-95.
- Keller, E.F. (1985) *Reflections on Gender and Science*. New Haven and London: Yale University Press.
- Keller, E.F. (1992) *Secrets of Life, Secrets of Death. Essays on Language, Gender and Science*. London: Routledge.
- Koepsell, D. (2009) *Who Owns You? The Corporate Gold-Rush to Patent Your Genes*. Chichester: Wiley-Blackwell.
- Latour, B. (2009) *A Cautious Prometheus? A Few Steps Toward a Philosophy of Design (with Special Attention to Peter Sloterdijk)*. In Glynne, J., Hackney, F. and Minton, V. (eds.), *Networks of Design. Proceedings of the 2008 Annual International Conference of the Design History Society (UK), University College Falmouth 3–6 September*. Florida: Universal Publishers.
- Meiners, C. (1793) *Grundriß der Geschichte der Menschheit*. Lemgo: Meyer.
- Merchant, C. (1980) *The Death of Nature. Women, Ecology and The Scientific Revolution*. San Francisco: Harper and Row.
- Morton, D. (2008) *Some ethical issues in biotechnology involving animals*. *The Journal of Commercial Biotechnology*, 9 (2), 163-170.
- Ottmers, C. (1996) *Rhetorik*. Stuttgart/Weimar: Verlag.
- Metzler, J.B. and Plumwood, V. (1993) *Feminism and the Mastery of Nature*. London: Routledge.
- Regine (2007) *Interview with Anthony Dunne*. Available from <http://we-make-money-not-art.com/archives/2007/03/>. [Accessed: 12th March 2007; 31st October 2014].
- Regine (2008) Interview with Tobie Kerridge (Material Beliefs). Available from <http://we-make-money-not-art.com/archives/2008/11/>. [Accessed: 20th November 2008; 25th October 2014].
- Regine (2009a) *The VivoArts School for Transgenic Aesthetics: Seed broadcasting workshop*. Available from <http://www.worldchanging.com/archives>. [Accessed: 23rd May 2009; 31st October 2014].
- Regine (2009b) *Green Revolution*. Available from <http://we-make-money-not-art.com/archives/2009/06/>. [Accessed: 23rd June 2009; 31st October 2014].

- Richards, J. (2008) *Rhetoric*. London: Routledge.
- Robert, J.S. and Baylis, F. (2008) *Crossing species boundaries*. *The American Journal of Bioethics*, 3 (3),1-13.
- Rose, H. and Rose, S. (2013) *Genes, Cells and Brains. The Promethean Promises of the New Technology*. London: Verso.
- Saffron, I. (2002) *Caviar. The strange history and uncertain future of the world's most coveted delicacy*. New York: Broadway Books.
- Sandel, M.J. (2007) *The Case against Perfection. Ethics in the Age of Genetic Engineering*. Cambridge/London: The Belknap Press.
- Sleeboom, M. (eds.) (2004) *Genomics in Asia. A Clash of Bioethical interests?* London/New York/Bahrain: Kegan Paul.
- Smith, K.R. (2008) *Animal genetic manipulation: a utilitarian response*. *Bioethics*, 16 (1),55-71.
- Streiffer, R. (2008) *In defence of the moral relevance of species boundaries*. *The American Journal of Bioethics*, 3 (3), 37-8.
- Thompson, I., Stott, N. and Kerridge, T. (2006) *Biojewellery. Designing rings with bioengineered bone tissue*. London: King's College London.
- Vickers, B. (1989) *In Defence of Rhetoric*. Oxford: Clarendon Press.
- Ward, M. and Wilkie, A. (2009) *Made in critcilland: designing matters of concern*. In Glynne, J., Hackney, F. and Minton, V. (eds.), *Networks of Design. Proceedings of the 2008 Annual International Conference of the Design History Society (UK), University College Falmouth 3–6 September*. Boca Raton, Florida: Universal Publishers.

Chasing The Hobbit. The Cultural Contents Of Mainstream Media Products

Luca GUERRINI*

Politecnico di Milano

An ‘unexpected journey’ in the world of fantasy and science fiction films describes the rules of scenography and setting in mainstream media products nowadays. An in-depth work of excavation has to be undertaken to recognise each narrative component and to return it to the context it belongs to. This work offers us an opportunity to grasp the multi-layer meaning behind these new cultural products, and to understand the way in which they mark a distance between themselves and those of the so-called modern age by breaking the boundaries among social and cultural groups. As a result, these products, usually classified as entertainment products, and therefore apparently simply-structured, show their highly professional contents as well as an extraordinary cultural complexity, which often encourage the appearing of new languages and social behaviours. When dealing with these new cultural products, the designer has to handle a very complex and multi-faced matter.

Whatever the purpose is – to identify references or to provide them – a mastery of the disciplinary knowledge involved in the process is required, which in design tradition rests on the history of the Arts and of Architecture.

Keywords: *Mainstream media products; urban design; scenography*

Contents and methodology

There’s a sequence in *The Hobbit. An unexpected journey* (2012), in which the thirteen dwarfs, led by Thorin and followed by a reluctant Bilbo Baggins, clear their way towards freedom fighting against the goblins. They run over dangerous wooden suspension bridges, swords in their hands, facing the enemies, many of whom fall down into the bottomless abyss of the cavern where the Goblin Town has been built.

The sequence is far different from the text written by J.R.R. Tolkien: there, not the dwarfs but Gandalf, the magician, puts a spell on the goblins to save

*Corresponding author: Luca Guerrini | e-mail: luca.guerrini@polimi.it

his friends, but this is only one of the many variations added by Peter Jackson to transform the book into a film. Focusing on this sequence and its variations a journey can start across the ways in which a communication product is built nowadays. There are many reasons to undertake this task.

The Hobbit is a fantasy film, a highly popular genre, together with science fiction, especially among younger generations. It is a good example of what Frédéric Martel (2010) defines as a mainstream media product: audio/video formats, firstly shaped according to American customer's preferences and now suitable for the taste of a large audience worldwide. Their widespread acceptance offers an opportunity to investigate the forms and contents of cultural products in a globalised market.

Aesthetics of innovation is always located at the crossroad of a very complex network of social, cultural and technological events. Analysing any product or service, this network can be brought to light in the form of a narrative, which summarises all the aspects into a coherent whole. An in-depth work of excavation, a sort of archaeology of the present, has to be undertaken to recognise each narrative component and to return it to the context it belongs to. Focusing on the symbolic aesthetics this methodology can be fruitfully applied to outline the aesthetic features of contemporary products and to understand the process of their making.

This approach recalls Erwin Panofsky's lesson; notably when the author, together with Raymond Klibansky and Fritz Saxl, investigates the visual structure of Albrecht Dürer's *Melancholia I*, comparing it with a very wide range of influences and sources. Accordingly, the artist's work – we could say the designer's, in a broader meaning – is seen as being part of a vast set of references, not necessarily coming from his own disciplinary tradition (Klibansky, Panofsky and Saxl, 1964).

Since 1950s, however, the definition of culture has changed 'as a result of the pressure of the great audience, which is no longer new but experienced in the consumption of its arts' (Alloway, 1958). Therefore the distinction between the 'naive beholder' and the expert, highlighted by Panofsky with regard to the Art of the past (Panofsky, 1955, p. 17), seems to acquire new meanings. Notably, at the end of the XX century, the distance between the new cultural products and those of the so-called modern age enlarges, breaking the boundaries among social and cultural groups.

New languages are the result of a mixing up of cultivated forms of expression and popular ones, of 'major' arts and 'minor' ones. Traditions belonging to any group within society can be found in these languages. As a result these products incorporate a multi-layer meaning, which basically

transforms the way they address the audience/customers. This new societal condition has been explored from different cultural and political perspectives by philosophers, historians and sociologists such as Jean Baudrillard (1981, 1983), David Harvey (1990), Jean-Francois Lyotard (1979) and Fredric Jameson (1991, 1998).

Terms like 'double coding', firstly appeared in Architecture (Jenks, 1977), and 'metalinguistic play', 'dialogism', 'intertextual irony', which refer to Literature (Eco, 1984; 2002; Hutcheon, 1988), have been introduced to describe this multi-layer structure which enables anyone to understand and appreciate the contents of a cultural product, no matter what level of education and culture they possess, for there's always at least one layer, within the work of Art the 'reader' finds meaningful and enjoyable.

Within the fields of film critique and the history of cinema, this cultural shift has been highlighted by the works of Scott Bukatman (1993, 1998, 2003), Brooks Landon (1992), Vivian Carol Sobchack (1997), David Thorburn and Henry Jenkins (2004). Above all, the cross-media approach and the constant reference to the history of the arts of the book by Angela Ndaljianis, *Neo-Baroque Aesthetics and Contemporary Entertainment* (2004), has been particularly inspiring for the purpose of the present essay.

Concerning The Hobbit

When dealing with these new cultural products, the designer has to handle a very complex and multi-faced matter, which has become even more complex in the so-called globalised age. To face this challenge he cannot run the risk of acting as a 'naïve beholder'. No matter what the purpose is (an analysis of the visual structure, as the present essay; an attempt to sketch a design methodology; or even a critique of mainstream approach), a mastery of the disciplinary knowledge involved in the process is always required.

As a test to verify this approach we can go back to the sequence of *The Hobbit* we started with, focusing on aspects regarding scenography, setting and design in a broad sense.

The whole sequence is built on the model of a 'platformer' video-game: speed, pace and movements of the characters are similar to the ones in video-games such as *Trine* (2009) and many other games of 'beat 'em up' genre, from *Rastan Saga* (1987) and *Golden Axe* (1989) onward. By this strategy, the audience, especially young people, clearly identify themselves with the protagonists and get engrossed in the story.



Figure 1 Film still from *The Hobbit. An unexpected journey* (2012), directed by Peter Jackson. ©Warner Bros. Pictures. Source: <http://lotr.wikia.com/wiki/Goblin-Town> [Assessed 22nd November 2014].

The gloomy cavern where the action takes place (figure 1) is shaped to emphasise a threatening condition. Darkness is dominant and the wooden multi-level structure of the town seems to be weak and precarious over the bottomless abyss of the huge space. The cavern itself looks much more like a petrified forest than a geological structure and the platforms are reminiscent of a settlement built on top of high trees.

If a kind of 'geological' structure can be seen, it is in the stratification of the references contributing to shape the scene, many of which the audience can easily identify. The first one comes from reality: the shaky paths, crossing the town are literally a cut-and-paste of Hussaini Hanging Bridge, in Pakistan, known as the most dangerous bridge in the world.

The second reference comes from film tradition: many 'cities on trees' can be quoted in this respect: the Ewok tree village on the Forest Moon of Endor, in *Star Wars. Return of the Jedi* (1983) or the Oompa Lumpa village of Loompa Land in *Charlie and the Chocolate Factory* (2005), the latter deriving from the novel by Roald Dahl (1964). Moreover, in literature the *topos* of the tree house has been largely explored since 1812, when *The Swiss Family Robinson*, written by Johann David Wyss, was published. In this sense the world of fiction is the third reference of the scene.

Comics play an important role as well, in devising the space. Alex Raymond, 'the artist's artist' among cartoonists (Sabin, 1996, p. 54), in 1935

puts an entire city in Art-Deco style, called Arboria, on top of huge trees to illustrate an adventure of *Flash Gordon* (figure 2). This character, probably the best known of Raymond's ones, has been very popular among comic readers worldwide. His stories have been published until 2003, and have inspired many TV serials and films, even George Lucas has been greatly influenced by them when he started thinking of the *Star Wars* saga and its protagonists.

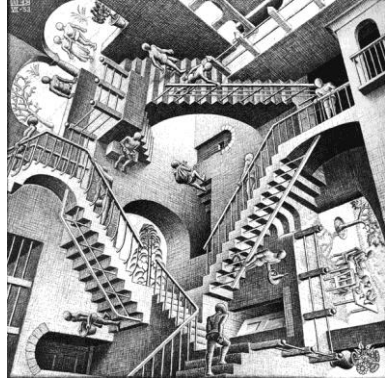


Figure 2 (left) The city of Arboria from Alex Raymond's *Flash Gordon*. Source: <http://flashgordon.wikia.com/wiki/Arboria> [Assessed 22nd November 2014].

Figure 3 (right) Maurits Cornelis Escher, *Relativity* (1953). Source: Locher, J.L. (ed.) (1971) *The World of M.C. Escher*. Amsterdam: Meulenhoff International.

Another illustrator/artist we can refer to is Maurits Cornelis Escher. His lithograph *Cubic Space Division* (1952) represents the mathematical notion of the infinite, by means of an endless, strong-structured, multi-level space. His puzzling pictures have been printed on the covers of many books, magazines and LPs, as well as on posters. More recently they have become a model for video-games and science fiction films such as *The Matrix* (1999) (Jones, 2006, 131) and *Inception* (2010). Numberless quotations of his print *Relativity* (1953) can be listed (figure 3), among them the well known moving staircases of Hogwarts in *Harry Potter and the Order of the Phoenix* (2007) (Berndt and Steveker, 2011, p. 45).

Expanding the analysis, the strategy of the filmmakers becomes increasingly clear: what, at first glance, seems to be an outlandish and fantastic world, discloses a Chinese nested boxes structure where an image, an action, a story are reminiscent of other images, actions, stories, thus enriching the experience of the viewer.

In-depth investigations

The contents and meanings we have referred to so far, are the most popular ones, those with which filmmakers – let's say – wink at the audience. The expert viewer can find other deeper meanings within the film, as a result of its 'double coding' structure.

The contorted branches of the trees of Arboria, which, by the way, have inspired James Cameron in shaping the Na'vi's Hometree in *Avatar* (2009), remind of other twisted, dead trees painted by Caspar David Friedrich in *The Abbey in the Oakwood* (1810) to visualise a gloomy atmosphere of ruins in a cemetery. This typical romantic context announces that of the gothic novel, which has inspired so many horror and fantasy films, from *Nosferatu* (1922) to the *Harry Potter* saga (2001, 2011).

Friedrich is investigating the concept of the sublime, the 'delightful horror' (Burke, 1756) pervading man when facing the overwhelming power of Nature, that of 'the tempest, the storm, the earthquake' – the 'dynamically sublime', according to Immanuel Kant – that of 'all the cases in which we are given [...] a large unit for the measure of the Imagination' – the 'mathematically sublime'; the latter concerning the mountains, the Earth, the Universe (Kant, 1790, § 26 and § 28).

The dizziness, pervading a man standing on the brink of an abyss, with its unlimited depth, is considered by the Danish philosopher Søren Kierkegaard as a metaphor of human condition (Kierkegaard, 1844, p. 61). But anxiety and threat connote the notion of the sublime since its first appearing in early XVIII century, when authors such as John Dennis, Shaftesbury and Joseph Addison describe this feeling as that pervading the viewer looking at the astonishing heights and dreadful chasms of Alpine valleys (Nicolson, 1959).

The painting *The Passage of the St. Gotthard* (1804) by Joseph Turner, admirably represents the mix of astonishment and fear, which the concept of the sublime evokes: a narrow path, cut into the mountain, looks over the gorge. Not surprisingly the same bare rocks appear in the cavern of Goblin Town and in the passage through the mountains leading to it. In this respect not only reality, cinema, literature, comics and video games contribute to the design of the scene, but also philosophy and the visual arts.

Going further, we can even compare the complex multi-level structure of Goblin Town to that of Giovanni Battista Piranesi's *Prisons* (1761): the gloomy atmosphere, the infinity of space and the gigantic scale of architecture, are all elements we can find within the scene, although adapted and transformed.

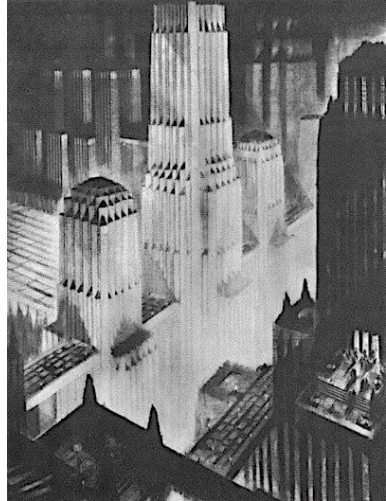


Figure 4 (left) Giovanni Battista Piranesi, Prisons, VII– The Drawbridge (1761). Source: <http://upload.wikimedia.org/wikipedia/commons/2/29/Piranesi9c.jpg> [Assessed 22nd November 2014].

Figure 5 (right) Hugh Ferriss, Escher, Crowding Towers (1923). Source: Ferriss, H. (1929) *The Metropolis of Tomorrow*. New York: Ives Washburn. [Online] *Archive.org*. Available from <https://archive.org/details/mettomo00ferr>. [Accessed: 10th May 2014].

In the Pre-romantic atmosphere of Piranesi's etchings, architecture replaces Nature, the insufficiency and the dwarfishness of man is not confronted with natural elements, but with the artificial, in the form of enormous Roman ruins. Galleries, hanging paths, drawbridges and stairs are piled up without an order, which both confuses and fascinates the viewer. Notably in plate VII-*The Drawbridge* (figure 4) we can appreciate the dizzying sequence of multi-directional suspended walkways overlapping each other, which the Goblin Town imitates, even though here represented from the bottom upwards.

Enlarging the scene

Such a complex network of references is only one of the possible paths suggested by a single sequence in a fantasy film. It probes the multiplicity of sources and the variety of the fields they come from.

The exercise can be pushed even further, investigating on the

'intertextual' content of the product, that is its capability to engage in a dialogue with other similar products – films in our case; and we can focus on the notion of the abyss, which, as we highlighted in previous paragraphs, appears to be the most prominent within the scene.

At the beginning of the XX century, many architects and urban designers took upon themselves the task of visualising the city of the future. Eugène Hénard in his speech at R.I.B.A. Town Planning Conference in London (1910) prefigured the dominant role of technologies: his 'rue future', compared with the 'rue actuelle', shows many levels dug under the street to separate different traffic flows (pedestrians, private cars, goods). At the same time new buildings are 'excavated' to house new technical systems and to store vehicles of any kind, from cars to aeroplanes (Hénard, 1910). Only seven years after the Wright brothers' first flight, the flimsy aircrafts landing on top of the buildings of Hénard's city, forerun numberless flying objects crossing the streets of science fiction films.



Figure 6 (left) Harvey Wiley Corbett, *City of the Future* (1910). Source: <http://architazer.com/blog/cross-sections/> [Assessed 22nd November 2014].

Figure 7 (right) Film still (part.) from *Metropolis* (1927), directed by Fritz Lang. © Friedrich-Wilhelm-Murnau-Foundation. Source: <http://it.wikipedia.org/wiki/File:Metropolis-new-tower-of-babel.png> [Accessed: 22nd November 2014].

That same year, Harvey Wiley Corbett publishes an image of *The City of the Future* (figure 6) on the cover of the Sunday supplement of *New York*

Tribune. Although reminiscent of previous representations – notably: William Robinson Leigh, *Visionary City*, (1908) and Moses King, *The Cosmopolis of the Future* (1908) – that of Corbett is a seminal work for its canyon-shaped streets, its multi-level bridges and the crowded frenetic context of the scene (Axelrod, 2009).

Corbett is a genuine supporter of high-rise buildings and an architect himself. His collaboration with Hugh Ferriss – result of which are the well-known perspectives showing the consequences of New York’s zoning law (1916) on the image of the city (Corbett, 1923) – helps the latter in developing his distinctive style. Ferriss likes to dramatise the urban scene by using strong chiaroscuro effects, generally preferring night misty backgrounds crossed by bright beams of artificial light (Ferriss, 1929, p. 62-65).

When Fritz Lang designs *Metropolis* (1927), as an expressionist version of New York in 2026 (figure 7), he conjures, among others, four main visions: the real city (Grant, 2003, p. 68-69), Corbett’s drawing, Ferriss’s perspectives and the blind, grid-shaped façades of the Chicago Tribune building in the competition project by Ludwig Hilberseimer (1922).

The relevance of Lang’s film in the history of cinema is beyond doubt. It’s hard to find science fiction filmmakers who have never compared themselves with its hallucinatory atmospheres. Notably those belonging to the latest generations, who deliberately adopted the ‘intertextual’ strategy, and the history of cinema, as a subject matter to deal with, within the process of film making.

In this regard in *Blade Runner* by Ridley Scott (1982) it’s easy to recognise the shape of the Stadtkrone Tower behind the Tyrell Building (Sammon, 1996, p. 111) as well as the canyon-shaped streets although dimmed under the gloomy rainy sky.

Nonetheless, even in this cult-movie of the 1980s other aspects, among those we have highlighted, contribute to the scene; such as the importance of reality, which gives Los Angeles of 2019 the semblance of a contemporary city of the Far East: ‘Hong Kong on a very bad day’ (Wheale, 1995, p. 107).

On the other hand comics remain of particular relevance to the process of film making. Scott himself has revealed that the stories of Moebius (Jean Giraud) were inspiring for the film script and for scenography (Sammon, 1996, p. 74). Particularly significant (Knapp and Kulas, 2005, p. 37) is *The Long Tomorrow* (1976), a story by Dan O’ Bannon and Moebius set in a multi-level city (figure 8), which has been dug, like a well on the surface of a planet. The protagonist, a detective, lives at level 97: the same of Rick Deckard, the ‘blade runner’.

Moebius plays a relevant role in connecting the world of cinema with that of comics for his strong collaboration to science fiction and fantasy films such as *Alien* (1979), *Tron* (1982) and *Abyss* (1989). Particularly significant to our topic is his contribution to the production of *The Fifth Element* (1997) directed by Luc Besson (figure 9), in which he develops many ideas collaborating with another master of comics: Jean-Claude Mézières.



Figure 8 (left) Cover image of Dan O'Bannon and Moebius, *The Long Tomorrow* (1976). © Les Humanoïdes Associés. Source: http://www.humano.com/assets/CatalogueArticle/35743/TheLongTomorrow_Cover_original.jpg [Assessed 22nd November 2014].

Figure 9 (right) Film still (part.) from *The Fifth Element* (1997), directed by Luc Besson. © Gaumont Film Company. Source: <http://www.theverge.com/2014/8/11/5990723/the-last-skybridges-of-new-york-city> [Accessed: 22nd November 2014].

To conclude, the canyon-shape bottomless design of the city of the future in science fiction films, proves to be the outcome of a long, demanding work bringing together many references and sources. The scene arouses a distinct feeling of dizziness, thrill and motion, which makes it perfectly suitable for an action shot. Consequently it has become a sort of *topos* of science fiction and fantasy films that the audience is confident to rediscover each time: from *Brazil* (1985) to *The Matrix* (1999). On the other hand many successful videogames have adopted the same scheme confirming the effectiveness of it and extending the popularity of this scene among younger generations.

Hence if the reader will ever come across a sequence such as that of 'Coruscant speeders chase' (*Star Wars Episode II: Attack of the Clones*, 2002),

this essay should have provided him with the tools to decode its meanings and contents, at least concerning scenography.

Conclusions

Film historians and theorists like M. Christine Boyer (1996), David Desser (1999), Vivian Carol Sobchack (1997) and Vita Janet Staiger (1988) have investigated the nature of the urban space in science fiction and fantasy films from different perspectives, notably focusing on socio-cultural, historical and philosophical aspects of the urban experience. This essay is an attempt 'to see the broad picture' from an architectural and urban perspective given that, ultimately, this is 'a matter of design'.

Mainstream films are very powerful communication machines: their cross-media, multi-layer structure helps us understanding how to build new paradigms that can be extended to any cultural product. They deal with design in many respects: as an operational field; as a reference of the design process; as an expression of contemporary aesthetics.

As the task is to provide visual contents, to shape spaces and to attribute a meaning to them, disciplinary competencies of design are involved such as those of scenography, architectural and interior design, communication and graphic design.

Furthermore, the collective nature of this new kind of work is becoming increasingly clear: reaching a globalised audience requires the contribution of a wide range of disciplines as well as a vast amount of knowledge. Thus the interdisciplinary approach, which typically characterises the process of film making, seems suitable to face the increasing complexity of cultural products at large.

This essay, however, focuses on the third aspect, that of contemporary aesthetics, notably describing the way in which cultural references from the past are connected together to produce parallel meaningful paths along the film's narration. This seems to be a crucial issue.

In debating about the postmodern condition the role of the past in the present age has been, and still is, a key issue. Fredric Jameson (1991) and Mario Perniola (1990) among others have investigated the opposition between surface and depth in the present culture and the weakening of the role of historical depth.

We cannot dramatise the past as the piling up of 'wreckage' produced by the 'storm' of the progress, like Walter Benjamin's *Angelus Novus* (Benjamin, 1940, 392). As well as we cannot settle for looking 'at the present through a

rear-view mirror' (McLuhan and Fiore, 1967, p. 75). Nonetheless the process of analysing and understanding contemporary products still crosses the past; in plain words: 'we need to go backward in order to move forward' (Stafford, 1994, p. 3).

Whether the aim is to identify references or to provide them, when dealing with the design of cultural products, an in-depth knowledge of the disciplinary past is required, which in design tradition rests on the history of the Arts and of Architecture.

Notes

Copyrighted illustrations of the present essay are published for non-profit educational purposes under the fair use doctrine. The author would like to thank Daniele Barosi, Martin Boycott-Brown and Pietro Righi Riva, for their help in providing comments and suggestions to expand the contents of this essay.

References

- Alloway, L. (1958) The Arts and the Mass Media. *Architectural Design*, 28 (February), p. 34-35. Reprint in: Harrison, C. and Wood, P. (eds.) *Art in Theory, 1900–1990*, 1994. Oxford: Blackwell Publishers.
- Andrew, W. (2006) *Turner in his time*. London: Thames & Hudson.
- Axelrod, J. (2009) *Inventing Autopia: Dreams and Visions of the Modern Metropolis in Jazz Age Los Angeles*. Oakland: University of California Press.
- Baudrillard, J. (1981) *Simulacra and Simulation*. Ann Arbor: University of Michigan Press.
- Baudrillard, J. (1983) *In the Shadow of the Silent Majorities . . . or the End of the Social and Other Essays*. New York: Semiotext(e).
- Benjamin, W. (1940) *Selected Writings, Volume 4: 1938-1940*. Cambridge: Harvard University Press.
- Besson, L. (1997) *The Story of The Fifth Element*. London: Titan Books.
- Boyer, M.C. (1996) *CyberCities: Visual Perception in the Age of Electronic Communication*. New York: Princeton Architectural Press.
- Bukatman, S. (1993) *Terminal Identity: The Virtual Subject in Post-Modern Science Fiction*. Durham: Duke University Press.
- Bukatman, S. (1998) *Zooming Out: The End of Offscreen Space*. In Lewis, J. (eds.), *The New American Cinema*. Durham: Duke University Press.
- Bukatman, S. (2003) *Matters of Gravity: Special Effects and Superman in the 20th Century*. Durham: Duke University Press.

- Burke, E. (1756) *A Philosophical Inquiry into the Origin of Our Ideas of The Sublime and Beautiful*. [Online] Bartlebay.com. Available from: <http://www.bartlebay.com/24/2/>. [Accessed: 3rd May 2014].
- Corbett, H.W. (1923) The Influence of Zoning in New York's Skyline. *The American Architect and the Architectural Review*, 73 (2410), 1-4.
- Desser, D. (1999) *Race, Space and Class: The Politics of Cityscapes in Science Fiction Films*. In Kuhn, A. (eds.), *Alien Zone II: Cultural Theory and Contemporary Science Fiction Cinema*. London: Verso Books.
- Eco, U. (1980) *The Name of the Rose*. New York: Harcourt.
- Eco, U. (1983) *Postscript to The Name of the Rose*. New York: Harcourt.
- Eco, U. (2002) *Intertextual Irony and Levels of Reading*. In McLaughlin, M. (eds.), *On Literature*. New York: Harcourt.
- and Ferriss, H. (1929) *The Metropolis of Tomorrow*. New York: Ives Washburn. [Online] Archive.org. Available from: <https://archive.org/details/mettomo00ferr>. [Accessed: 10th May 2014].
- Grant, B.K. (eds.) (2003) *Fritz Lang: Interviews*. Jackson: University Press of Mississippi.
- Harvey, D. (1990) *The Condition of Postmodernity: An Enquiry into the Origins of Cultural Change*. Oxford: Blackwell.
- Hénard, E. (1983 - ed or. 1910) *Etudes sur les transformations de Paris, et autres écrits sur l'urbanisme*. Paris: L'Equerre.
- Henderson, P. and Mornement, A. (2008) *Treehouses*. London: Frances Lincoln.
- Hilberseimer, L. (1927) *Metropolisarchitecture and Selected Essays*. New York: Gsapp Books.
- Hofmann, W. (2000) *Caspar David Friedrich*. London: Thames & Hudson.
- Hutcheon, L. (1988) *A Poetics of Postmodernism*. London: Routledge.
- Jameson, F. (1991) *Postmodernism, or, The Cultural Logic of Late Capitalism*. London: Verso Books.
- Jameson, F. (1998) *The Cultural Turn: Selected Writings on the Postmodern, 1983-1998*. London: Verso Books.
- Jenks, C. (1977) *The Language of Post-Modern Architecture*. London: Academy.
- Kant, I. (1790) *Kant's Critique of Judgement*. London: Macmillan.
- Kaufmann, E. (1952) *Three Revolutionary Architects, Boullée, Ledoux and Lequeu*. Philadelphia: American Philosophical Society.
- Kierkegaard, S. (1844) *The Concept of Dread*. Princeton: Princeton University Press.

- Klinbansky, R., Panofsky, E. and Saxl, F. (1964) *Saturn and Melancholy: Studies in the History of Natural Philosophy, Religion, and Art*. London: Thomas Nelson and Sons.
- Kuhn, A. (eds.) (1990) *Alien Zone: Cultural Theory and Contemporary Science Fiction Cinema*. London: Verso Books.
- Kuhn, A. (eds.) (1999) *Alien Zone II: Cultural Theory and Contemporary Science Fiction Cinema*. London: Verso Books.
- Landon, B. (1992) *The Aesthetics of Ambivalence: Rethinking Science Fiction Film in the Age of Electronic (Re)production*. Westport: Greenwood.
- Locher, J.L. (eds.) (1971) *The World of M.C. Escher*. Amsterdam: Meulenhoff International.
- Liotard, J.F. (1979) *The Postmodern Condition: A Report on Knowledge*. Minneapolis: University of Minnesota Press.
- Martel, F. (2010) *Mainstream: Enquête sur cette Culture qui plaît à tout le Monde*. Paris: Flammarion.
- McLuhan, M., Fiore, Q. and Agel, J. (1967) *The Medium is the Massage: An Inventory of Effects*. New York: Random House.
- Mézières, J.C. (1998) *Les Extras de Mézières No.2*. Paris: Dargaud.
- Moebius (Giraud, J.) and O'Bannon, D. (1976) *The Long Tomorrow*. *Metal Hurlant*, 1 (7-8).
- Ndalianis, A. (2004) *Neo-Baroque Aesthetics and Contemporary Entertainment*. Cambridge: MIT press.
- Nicolson, M.H. (1959) *Mountain Gloom and Mountain Glory: The Development of the Aesthetics of the Infinite*. Washington: University of Washington Press.
- Panofsky, E. (1955) *Meaning in the Visual Arts: Papers in and on Art History*. Garden City: Doubleday & Company.
- Perniola, M. (1990) *Enigmas: The Egyptian Movement in Society and Art*. London: Verso Books.
- Raymond, A. (1934-1938) *Flash Gordon*. Miamisburg: Checker Book Publishing Group.
- Sabin, R. (1996) *Comics, Comix & Graphic Novels: A History of Comic Art*. London: Phaidon Press.
- Sammon, P.M. (1996) *Future Noir: the Making of Blade Runner*. New York: Harper Collins.
- Sobchack, V.C. (1988) *Cities on the Edge of Time: The Urban Science Fiction Film*. *East-West Film Journal*, 3 (1 December), 4-19.
- Sobchack, V.C. (1997) *Screening Space: The American Science Fiction Film*. New Brunswick: Rutgers University Press.

- Stafford, B.M. (1994) *Artful Science. Enlightenment, Entertainment and the Eclipse of Visual Education*. Cambridge: MIT Press.
- Staiger, V.J. (1988) Future Noir: Contemporary Representations of Visionary Cities. *East-West Film Journal*, 3 (1 December), 20-44.
- Tafuri, M. (1980) *The Sphere and the Labyrinth: Avant-Gardes and Architecture from Piranesi to the 1970s*. Cambridge: MIT Press.
- Thorburn, D. and Jenkins, H. (eds.) (2004) *Rethinking Media Change: The Aesthetics of Transition*. Cambridge: MIT Press.
- Zito, S. (1977) George Lucas Goes Far Out. *American Film*, 2 (6), 8-13.



Design, scienza ed estetica nei territori dell'innovazione

Francesca LA ROCCA*

Seconda Università degli Studi di Napoli

Le forme di collaborazione tra creatività, scienza e tecnologia configurano oggi una estetica dell'innovazione generata dalle influenze reciproche tra immaginari propri di discipline anche lontane.

Il paper parte da un inquadramento del concetto di innovazione per il design in relazione alla crisi dei paradigmi dell'arte e della scienza moderne.

Focalizza quindi l'attenzione su come il design sia in grado di generare un nuovo pluralismo estetico, contaminando settori molto diversificati della cultura e della produzione. Nei territori dell'innovazione contemporanei il discorso estetico riguarda non solo il prodotto, ma tutto il processo produttivo e generativo, mettendo in gioco quella che nel campo dell'arte è stata definita come estetica relazionale. In particolare si evidenzia come oggi sempre più spesso l'immaginario scientifico, e soprattutto quello della biologia, sia in prima linea a dare spettacolo suggerendo mondi futuri, ma come nello stesso tempo la regia del design si riveli fondamentale per conferire trama e senso alla performance.

Keywords: *Innovazione; estetica; biologia; design*

I territori mobili dell'innovazione

Per parlare di *estetiche dell'innovazione* nella fase contemporanea in rapporto al design è d'obbligo riferirci ad un inquadramento della idea stessa di innovazione, rimarcando innanzitutto come la crisi del paradigma della modernità abbia alterato profondamente rapporti consolidati. Se introduciamo il concetto di innovazione, quasi in automatico, infatti, apriamo la riflessione sul binomio tecnica/design, e quindi verso le innumerevoli intersezioni con quello che è considerato generalmente il fattore chiave dell'innovazione, ossia l'aspetto scientifico-tecnologico.

Sappiamo infatti che nella modernità il concetto di innovazione è fortemente legato all'idea di progresso e presuppone uno sviluppo lineare

* Corresponding author: **Francesca La Rocca** | e-mail: f.larocca@mclink.it

della techno-scienza. In una famosa sequenza di disegni Le Corbusier illustra lo sviluppo progressivo dei modelli di automobile. Friedrich Kiesler descrive secondo un diagramma l'evoluzione di un sistema di coltelli come processo di perfezionamento attraverso la selezione, che conduce a sempre nuovi standard (Steadman 1988, p. 214-217) (figura 1); nella sua concezione della 'biotecnica' il design è a pieno titolo la disciplina in grado di guidare uno sviluppo evolutivo nel campo dell'artificiale, aderente al variare delle esigenze della società e dell'individuo.

Nella fase odierna il concetto di innovazione prescinde in parte da questo paradigma, contemplando invece salti inaspettati o apparenti regressioni ed esulando da una idea acritica di un incessante superamento, per coinvolgere sempre più i temi dell'etica e della sostenibilità ambientale.

La compresenza di hi-tech e low-tech in uno stesso oggetto – pensiamo solo alla nuova attenzione all'utilizzo dell'energia generata dal movimento manuale – ci chiarisce inoltre come oggi si debba tener conto di qualcosa che prima era tendenzialmente escluso: la commistione di livelli tecnologici diversi che, nel loro complesso, danno luogo ad un sistema innovativo.

D'altra parte è anche nell'arte che l'idea di innovazione ha assunto con la post-modernità un significato più indefinito. Come osserva Danto (2008) la cifra distintiva di tutte le arti visive a partire dalla fine del modernismo, che egli colloca intorno all'inizio degli anni '70, è la mancanza di un orientamento narrativo univoco in grado di distinguere la vera innovazione da fenomeni ascrivibili come marginali. Quello contemporaneo è quindi 'un periodo di disordine informativo, una condizione di entropia estetica totale. È però allo stesso tempo una fase di libertà praticamente assoluta' (Danto 2008, p. 12).

Quindi solo inquadrandolo in un panorama complesso, con riguardo alle intersezioni disciplinari cui può dar luogo, possiamo osservare il movimento secondo cui negli ultimi venti anni si intersecano design ed estetiche dell'innovazione all'interno di un territorio mobile e pluralistico.

Una predisposizione alla *open innovation*

Fin dalla sua nascita e nel corso dello sviluppo di tutta la modernità, il design si identifica come una disciplina deputata all'innovazione, capace cioè di utilizzare il progresso tecnico-scientifico per configurare oggetti funzionalmente e formalmente sempre più ineccepibili. Questo tipo di rappresentazione coinvolge il giudizio estetico verso la tecnologia. Con la nascita dell'industrial design emerge infatti la necessità di attribuzione di una *cittadinanza nel mondo della significazione* a categorie di oggetti che

prima erano del tutto estranei al giudizio estetico, il riconoscimento cioè di una capacità semantica ed espressiva dell'oggetto tecnico (Simondon, 1969).

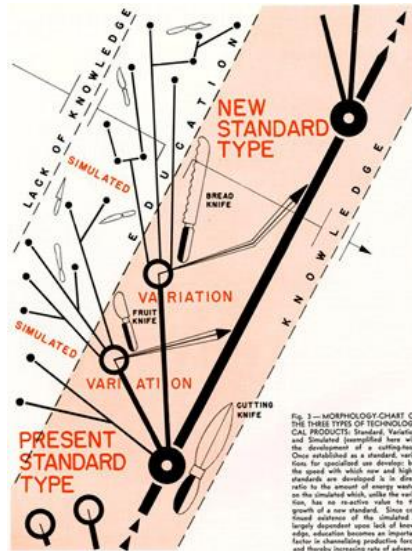


Figure 1 'Morphology—Chart of Three Types of Technological Products: Standard, Variation, and Simulated,' F. Kiesler (1939).

Il funzionalismo trae dalle scienze biologiche un'idea processuale dell'innovazione, una propria legittimazione scientifica e insieme un modello estetico. Secondo tale paradigma l'innovazione che la selezione darwiniana determina nella natura è accostabile a quanto avviene nel mondo artificiale; simmetricamente la 'bellezza dei prodotti tecnici', ha un suo parallelo in quelli della natura, come frutto di un perfezionamento continuo dell'adattamento.

Quel che avviene con l'avvento della post-modernità è l'instaurarsi di nuove relazioni tra progetto e tecnologia, che coinvolgono la sfera del design e che rendono i rapporti tra design/ innovazione tecnica/estetica molto più complessi. Nella modernità l'innovazione muove dalla scienza e confina il discorso estetico in una sfera marginale, considerando la qualità estetica alla stregua di un corollario della funzionalità. Cosicché possiamo definire una visione estetica limite del design, simbolizzata dal

metodologismo esasperato degli anni '60, come una concentrazione purista sull'essenza della funzione.

La 'Hochschule für Gestaltung', la cosiddetta scuola di Ulm, rappresenta uno degli ultimi tentativi compiuti dalla cultura del design nel dopoguerra di riassorbire in maniera armonica tecnologia, innovazione ed estetica; un tentativo per lo più incompreso dalla critica, ma forse dagli stessi ulmiani, tacciato di iper-razionalismo e fallito invece proprio per aver cercato in extremis una conciliazione, nel frattempo divenuta inattuabile e quindi romantica, tra innovazione tecnica e sociale (Branzi, 1988).

Al medesimo tempo l'arte moderna diviene nel '900 riflessione stessa sulla natura e le ragioni dell'arte. Così assistiamo parallelamente ad una concentrazione dell'arte su sé stessa; per Joseph Kosuth il ruolo dell'artista inquadrato nello scenario della fine degli anni '60 è quello di 'mettere in questione la natura dell'arte'. Quasi insieme giungono quindi a maturazione in tale periodo due processi: 1) la crisi del paradigma della tecnica moderna mette sotto accusa qualsiasi visione puramente efficientista dell'oggetto 2) si va verso l'abolizione del divario estetico tra arte e vita e ci si interroga su cosa separi l'arte dai 'semplici oggetti del mondo'.

La fine della modernità coincide per Danto con l'assenza di una direzione unica rintracciabile per l'arte: si abbandona l'idea di una innovazione come superamento di uno stile attraverso una nuova forma d'arte che si consideri quella atta a rappresentare a pieno titolo l'epoca presente (Danto, 2008).

Da questo momento, e con questa doppia incertezza sui propri fondamenti teorici, si apre per la cultura del design un nuovo problema: quello di capire cosa per il proprio specifico ambito sia rappresentabile come 'innovazione', al di là della sua vicinanza e compromissione sia con il mondo scientifico che con quello dell'arte. La disciplina del design diviene quindi luogo autonomo di elaborazione di un'estetica dell'innovazione più svincolata da paradigmi esterni.

Il design infatti non identifica più il suo ruolo con quello di un interprete, privilegiato quanto eterodiretto, di una tecno-scienza a sua volta dubbiosa sui propri fondamenti; si avvia invece a dover intraprendere un percorso più difficile e faticoso, dopo aver attinto a quello che Baudrillard definisce 'il grado zero dell'oggetto' (Baudrillard, 2004, pp. 22-23). Ma si apre allo stesso tempo per esso anche una condizione favorevole. A fronte di un oggetto d'arte che dall'ideale scende sempre più al mondo del quotidiano, lungo quel piano inclinato reso più ripido dalla lunga scia della pop-art, l'oggetto di design ha un grande vantaggio rispetto all'arte: di non *rappresentare* una realtà ma di *essere* una realtà. Questa circostanza ha un

significato particolare se la rapportiamo a quella parabola dell'arte nel '900 per cui l'opera sempre più 'rifiuta di presentarsi come apparenza (...) e pretende di affermarsi come una realtà, una realtà *sui generis*, ma di pari dignità di quella 'vera' (Vercellone, 2013, p. 113).

La cultura del design, quindi, benché coinvolta dalla crisi della scienza e dalla 'morte dell'arte', sembra in grado di acquisire nuova forza e importanza anche grazie a questi sommovimenti. Per la sua capacità di muoversi oltre i confini tra le discipline, accettando di compromettersi anche con il mondo della merce, il design si trova coinvolto in una *molteplicità di territori della significazione*, a secondo dei campi della cultura, della scienza e della società con cui si trova ad interagire.

Scriva Branzi: 'Il design di oggi (che poco ha a che vedere con quello del secolo scorso) in mancanza di sistemi aggregativi più generali, sembra invadere tutta la realtà, materiale e immateriale, del mondo contemporaneo: dal design dei prodotti a quello della comunicazione; da quello strategico all'interior design; da quello dei servizi al design urbano; dal design delle interfacce al fashion design; dal light design al design del colore; dal web design al design primario; fino al food design e all'hair design (ma l'elenco continua). Sembra non esista uno spazio interstiziale che non possa essere occupato da questa sorta di liquido invasivo e rivitalizzante' (Branzi, 2008).

Il design si trova quindi spesso nel ruolo di un *naturale interprete* di estetiche dell'innovazione che vanno a configurarsi nella sperimentazione di inediti incroci disciplinari, soprattutto laddove l'interazione riguarda settori di ricerca ad alto contenuto scientifico-tecnologico.

Detto in altre parole, la disciplina del design è tra le prime ad avere, più o meno coscientemente, adottato modelli cosiddetti di *open innovation*, nel senso di un'apertura costante, spesso spregiudicata, alla fertilizzazione con aree della cultura, della scienza e della tecnologia emergenti.

Il design italiano in particolare, come osserva Andrea Branzi, ha sempre saputo usare 'l'arte per le sue possibilità tecnologiche e la tecnologia per le sue possibilità artistiche'. Quest'ambiguità strategica significa anche che la cultura del design è dotata di un alto grado di resilienza: è stata cioè in grado sfuggire al momento giusto alla doppia crisi che ha investito i rispettivi paradigmi fondativi della scienza e dell'arte (La Rocca, 2006).

È in questa ottica che andiamo oggi a considerare i variegati scenari del design in rapporto ad una estetica dell'innovazione. Possiamo concepire quest'ultima come un fenomeno generato dalla influenza reciproca tra discipline tradizionalmente divise da steccati quasi invalicabili; da un

intersecarsi, spesso indissolubile, tra aspetti artistici, scientifici, etici, sociali, tecnologici e antropologici.

Tra design, scienza e biologia: tre mostre, innumerevoli estetiche

Le osservazioni svolte preludono ad una domanda cardine: quando oggi parliamo di estetiche dell'innovazione, quali sono i paradigmi prevalenti che coinvolgono il design?

Il design ha alle spalle una storia in cui il suo valore è stato strettamente legato alla capacità di tradurre in un linguaggio umanistico la freddezza e l'anonimato del mondo tecnico. Anche oggi, nei campi limitrofi più strettamente scientifici in cui lavora, il design è garante di un codice variegato e universale di valori estetici e comunicativi, e ha titolo a dichiararsi il soggetto culturale privilegiato per produrre innovazione proprio in tal senso.

Tre mostre di design emblematiche, organizzate a partire dal 2008 al Museum of Modern Art di New York, ci possono aiutare a rispondere alla domanda che ci siamo posti, costituendo una ricognizione internazionale sul campo.

Nella prima mostra, *Design and the Elastic Mind*, tenutasi nel 2008, attraverso la selezione di progetti in tutto il mondo viene focalizzato il rapporto tra design e ricerca scientifica sperimentale. Da questa esplorazione emerge una novità importante: 'While technology still traditionally acts as the interface, the conversation between design and science has become more direct and focused' (Antonelli, 2008, p. 18). Ciò significa che le estetiche dell'innovazione scaturiscono in maniera più libera e imprevedibile dall'incontro diretto tra design e scienza, senza una preventiva mediazione di tipo tecnologico. Come dimostrano gli oggetti esposti, non esiste un unico punto di vista che domina sugli altri: robotica, nanotecnologie, bioingegneria, rapid prototyping, tecnologie interattive, modelli matematici concorrono alla risoluzione di problematiche molto varie, ma possono anche essere l'occasione per una sperimentazione a valenza prevalentemente artistica.

Prendiamo il caso di due progetti basati su biotecnologie: 'Victimless leather', e 'The Pig Wings', ambedue sviluppati nel SymbioticA, Art and Science Collaborative Research Laboratory in Australia.

Il primo è una sperimentazione, esposta per la prima volta nel 2004, di una coltivazione in vitro di tessuti animali che dà luogo ad un prototipo di una

giacca, in scala ridotta, prodotta partendo dalla replicazione di cellule ossee e di tessuto connettivo, integrate con una matrice polimerica biodegradabile (figura 2). Questa prospettiva apre un nuovo senso nella relazione tra l'uomo e la natura: la filiera dei prodotti di pellame si discosta totalmente dai processi millenari di allevamento, uccisione degli animali e trattamenti inquinanti delle pelli. Al discorso etico, ecologico e di economia produttiva si affianca la dimensione estetica, che non riguarda tanto il prodotto in sè, quanto tutto il processo generativo e l'apparato laboratoriale messo in esposizione.

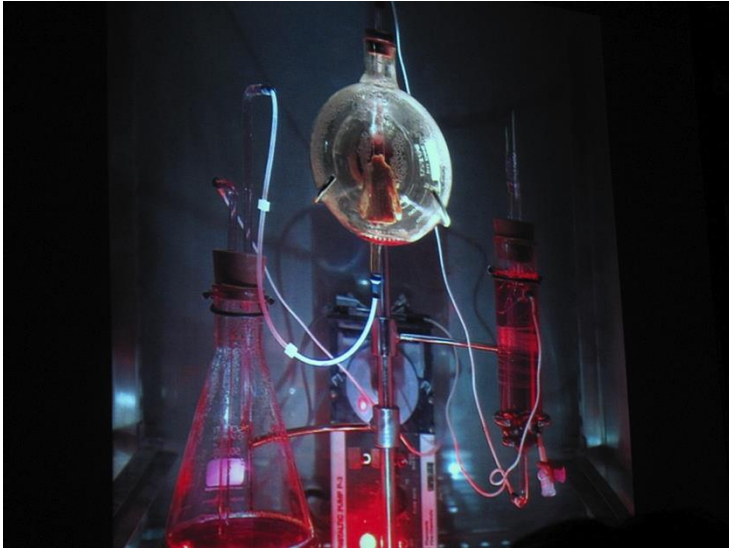


Figure 2 The Tissue Culture & Art (Oron Catts & Ionat Zurr), Victimless Leather - A Prototype of Stitch-less Jacket grown in a Technoscientific "Body", Polimeri biodegradabili, cellule di tessuto osseo e connettivo, 2004.

The 'Ping Wings', pur basandosi su un'analogia applicazione di bioingegneria, si presenta come un progetto a valenza prevalentemente artistica (figura 3). Usando cellule staminali vengono realizzate a partire da tessuti ossei del maiale delle improbabili ali che combinano al loro interno polimeri biodegradabili. Si tratta quindi di un progetto che porta a riflettere sul confine tra vita e artificiale, ma in cui l'aspetto di esperimento concettuale è decisivo.

La più recente mostra organizzata dal MoMa nel 2012, *Biodesign. Nature, Science, Creativity*, indaga specificamente il rapporto tra design e

biologia e le possibilità andare oltre la biomimetica esplorando 'an emerging and often radical approach to design that draws on biological tenets and even incorporates the use of living materials into structures, objects and tools' (Myers, 2012).

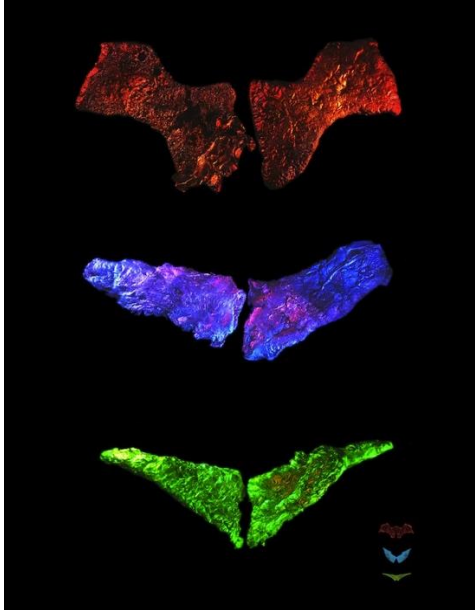


Figure 3 *The Tissue Culture & Art* (Oron Catts & Ionat Zurr), *The Pig Wings*, Cellule di tessuto mesenchimale di maiale, polimeri biodegradabili/bioassorbibili (PGA, P4HB), 2000-2001.

Come in *Design and the Elastic Mind*, il tema costantemente sotteso è quello dell'ecosostenibilità, in cui le estetiche dell'innovazione si connettono alla dimensione etica.

Biodesign presenta una grande varietà di casi studio che riguardano organismi viventi ad ogni scala – dalle piante a batteri, alghe, funghi o cellule – che vengono utilizzati come elemento integrabile nel progetto nelle più svariate interpretazioni ed applicazioni: per la configurazione dello spazio, da quello privato a quello urbano; inseriti in un sistema per la comunicazione grafica, per esperimenti di morfologia mutante o di bioluminescenza; con il ruolo di immagazzinatori di energia o di sensori di controllo ambientale.

Si segnala a questo proposito il progetto 'Contaminant' sviluppato da Steve Pike presso la Bartlett Scholl of Architecture di Londra (figura 4 e 9). Si tratta di una installazione volta a mappare la presenza di microorganismi all'interno della rete metropolitana di Londra, e in altri luoghi pubblici molto frequentati come mercati o uffici, attraverso delle celle di monitoraggio che variano colori e morfologia a seconda dei microfunghi o batteri captati.

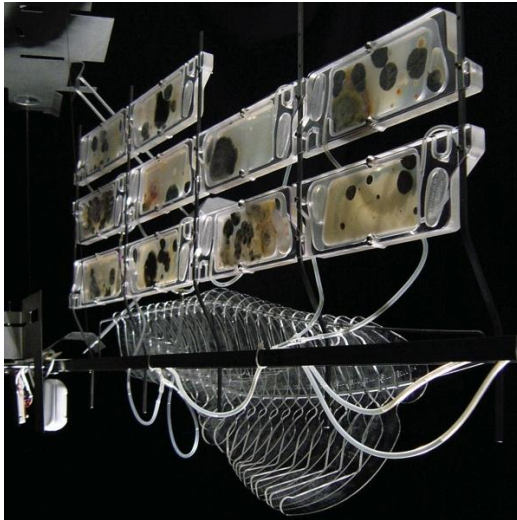


Figure 4 Steve Pike, Contaminant, Acciaio, vetro, acrilico e microorganismi.

L'obiettivo primo della sperimentazione è sicuramente di tipo biomedico ed epidemiologico, ma l'aspetto più innovativo è proprio quello di tradursi in un sistema scenografico di comunicazione.

Quindi, sia che parliamo di applicazioni del biodesign alla facciata di un edificio, al biomedicale, all'arredo urbano, nella grafica dinamica, nello sviluppo di pellami *in vitro*, nella configurazione di un mini-ecosistema domestico o di un materiale auto-riparante, emerge un dato forte: l'aspetto estetico non consegue l'esperimento come un effetto collaterale, ma ne è spesso l'elemento chiave, anche laddove la sperimentazione non ha dichiarate finalità di tipo espressivo.

Nel progetto 'Objectivity' di Nurit Bar-Shai il tema centrale è la visualizzazione delle attitudini auto-organizzative del *Paenibacillus vortex*, un batterio in grado di formare colonie che mostrano delle capacità di motilità cooperativa. Bar-Shai stimola il microorganismo con diverse

frequenze sonore e input visivi: il segnale sinestetico induce il batterio a svilupparsi, dando luogo ad una varietà di pattern che altro non sono che rappresentazioni visive dello scambio di 'chemical tweets' tra cellule (figura 5).

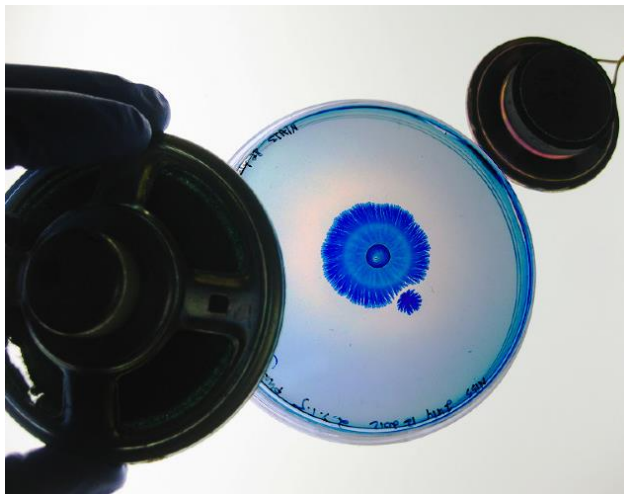


Figure 5 Nurit Bar-Shai, "Objectivity [tentative]: Sound to Shape, (in corso). Il microrganismo viene sottoposto a stimoli sonori che fungono da catalizzatori della sua auto-configurazione.

Nella terza mostra che riteniamo significativa, *Talk to me*, tenutasi nel 2011 sempre al MoMA, il tema è l'interazione tra l'uomo e l'oggetto, con particolare riferimento alle possibilità offerte dalle nuove tecnologie elettroniche, dal mondo della robotica, dall'ubiquitous computing e dalla realtà aumentata.

Everyware, wearable computing, calm computing, ambient intelligence, things that think, digital-physical computing, internet of things, networked objects, geospatial web, locative media. Tutti questi termini esprimono la convergenza tra fisico e digitale e indicano quella che si può definire la rivoluzione dei nostri tempi.

Con l'affermarsi di questo nuovo scenario tecnologico è emersa nel design un'incertezza su quale sia l'oggetto, per così dire l'output, del processo progettuale, rendendo incerta e sfuggente la sua natura. D'altronde, uno dei modi in cui la disciplina del design si è progressivamente addentrata nei più diversi settori della produzione umana di artefatti è proprio *abbattendo le barriere tra oggetti materiali e virtuali*,

confrontandosi con nuove declinazioni come l'interaction design o il design dei servizi che configurano quello che è stato definito un 'design of the other things' (Maffei, 2010).



Figure 6 Stephen Spyropoulos and Theodore Spyropoulos, Minimaforms, Becoming Animal, 2007. Dalla mostra 'Talk-to-me', MoMA 2011.

Un'estetica dell'innovazione passa oggi per l'ideazione di oggetti in grado di incorporare un vastissimo *range* di tecnologie, che, lasciate altrimenti a sé stesse non sono in grado di configurare di per sé un ambiente più abitabile per l'uomo. 'New branches of design practice have emerged in the past decades that combine design's old-fashioned preoccupations – with form, function, and meaning – with a focus on the exchange of information and even emotion. Communication design deals with the delivery of messages, encompassing graphic design, wayfinding, and communicative objects of all kinds, from printed materials to three-dimensional and digital projects. Interface and interaction design delineate the behavior of products and systems as well as the experiences that people will have with them. Information and visualization design deal with the maps, diagrams, and tools that filter and make sense of information. In critical design, conceptual scenarios are built around hypothetical objects to comment on the social, political, and cultural consequences of new technologies and behaviors' (Antonelli, 2011).

In queste nuove declinazioni del design si intravede la scia sotterranea ma profonda del Situazionismo, riaggiornata attraverso il conseguimento di

un diverso livello tecnologico (Perniola, 2005); il progetto vira naturalmente verso quella *estetica relazionale* descritta da Nicholas Bourriaud come caratterizzante lo scenario contemporaneo dell'arte: 'Negli anni Novanta, con le tecnologie interattive che si sviluppano a velocità esponenziale, gli artisti esplorano gli arcani della partecipazione sociale e dell'interazione' (Bourriaud, 2010, p. 69).

Quando parliamo della creazione di ambienti ibridi, che mescolano il mondo virtuale con quello fisico su scala planetaria e come parte integrante della vita quotidiana, è necessario ripensare il ruolo non solo della percezione ma anche del corpo, della sua capacità di immersione dello spazio, poichè la dimensione estetica dipende strettamente dalla posizione del soggetto osservante. Come osserva Roberto Diodato: 'pensare la fruizione estetica privandola della distanza, che è stata condizione di possibilità di una forma rilevante del valore artistico, e di pensare la fruizione nella dimensione del risucchio, dell'ingresso da parte del fruitore nel corpo dell'opera e insieme dell'opera nel proprio corpo o immaginario.

Ciò comporta l'accentuazione della dimensione patica e panica della relazione: fare corpo con l'opera, la quale subisce l'effetto della mia presenza, e che attraverso il mutamento prodotto da questo subire, modifica il mio sentire' (Diodato, 2005, p. 72).

La varietà di coniugazioni tra ricerca scientifica ed aspetti della vita quotidiana e del sociale testimoniato in queste tre esposizioni ci restituisce un panorama quanto mai significativo delle estetiche contemporanee dell'innovazione, viste però attraverso un *filtro ottico* indispensabile: si tratta della mediazione culturale del design.

Un altro fattore rilevante che viene alla luce è una concezione estetica che riguarda non tanto e non solo il prodotto, ma che focalizza l'attenzione su tutto il processo produttivo e generativo. Fab lab, laboratori di bioingegneria, centri di ricerca biomedica, laboratori chimici e di elettronica: non solo gli oggetti, ma gli scenari in cui essi sono sviluppati, con particolare evidenza su metodi, attrezzature e strumentazioni, diviene argomento della mostra. Cosicché, al di là della rilevanza che si dà all'aspetto scientifico o artistico, il focus riguarda il concept generale e l'estetica relazionale innescata dal progetto. L'ambientazione, i processi produttivi e tecnologici coinvolti, il contesto complessivo divengono sia oggetto di giudizio etico che di considerazione estetica alla stregua di una performance. L'importanza di diffondere il progetto e condividere la sua filosofia sancisce la centralità di un'altra competenza patrimonio della cultura del design che è la comunicazione visiva.

Le estetiche che emergono dalla contaminazione tra design, arte e scienza sono quanto mai plurali, ma sono accomunate da un fattore decisivo: se oggi sempre più spesso l'immaginario scientifico è in prima linea a dare spettacolo suggerendo mondi futuri, la regia del design appare importante per conferire *trama* e *sensò* alla performance.

Il preciso, il mutante e l'informe

Un campo molto influente per l'innovazione contemporanea e che coinvolge il design riguarda la ricerca sui materiali. In questo caso le estetiche dell'innovazione fanno leva anche sulle possibilità espressive insite in materiali avanzati, caratterizzati da qualità di dinamicità e trasformabilità.

L'idea di materiali ed oggetti in grado di mutare nel tempo – utopicamente prefigurata dalle avanguardie radicali a partire dagli anni '60 – ha in realtà anticipato risultati conseguibili oggi con il sostegno di tecnologie avanzate.

Tra le 'città della chimica' di William Katawolos e gli odierni oggetti sperimentali della serie 'Noumenon' di Carl de Smet è passato più di mezzo secolo, ma non invano: Noumenon è basato su polimeri intelligenti a memoria di forma in grado di trasformarsi reversibilmente in arredi in risposta ad uno stimolo termico che attiva il materiale compattato (figura 7).

Materiali con comportamenti analoghi alla materia organica, capaci cioè di prestazioni dinamiche quali l'interattività, l'autoriparazione, la variabilità cromatica, la memoria di forma, costituiscono oggi un universo fertile per la creatività. I cosiddetti 'smart materials' sono capaci di rispondere agli stimoli esterni, come i materiali a cambiamento di fase o i materiali cromogenici (Ritter, 2007). Bioconcrete è un cemento, sviluppato da Henk Jonkers della Delft University of Technology in Olanda, capace di autoriparare le piccole fratture che si generano con il tempo grazie all'aggiunta al suo interno di batteri specializzati.

Molti materiali avanzati hanno inoltre un'insita attrattività estetica: caratteri visivi molto sofisticati, associabili alla traslucenza, leggerezza, luminescenza, variabilità cromatica, fanno sì che essi contribuiscano oggi a rendere più incerta la definizione stessa di 'oggetto', inteso come qualcosa di necessariamente definito ed immobile. Il materiale può essere in grado di svolgere esso stesso una funzione, o la sua superficie svolgere un ruolo autonomo di comunicazione, coinvolgendo un'esperienza sensoriale che riguarda non solo la vista, ma anche il tatto, l'udito, l'odorato.

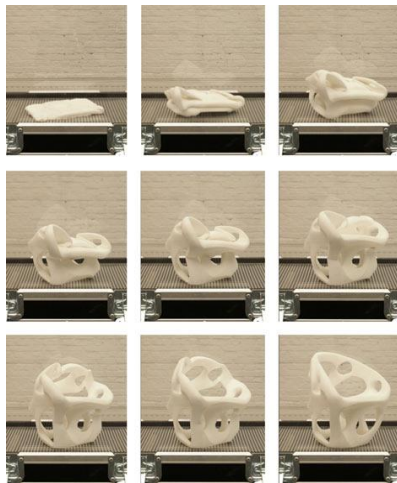


Figure 7 Carl De Smet, Noumenon, 2012. Seduta in polimero a memoria di forma che si trasforma in base ad uno stimolo elettrico.

La miniaturizzazione rende obsoleta la vecchia estetica macchinista, inapplicabile ad entità sempre più smaterializzate: nel fotovoltaico, ad esempio, una semplice vernice riesce oggi a svolgere le stesse prestazioni dei pannelli; o ancora, con l'uso di nanotecnologie, un 'fiore' della grandezza di un granello di sale – ottenuto dal solfuro di germanio e sviluppato alla North Caroline State University – basta per captare l'energia luminosa.

Metalli traforati come merletti, cementi luminosi, ma anche plastiche biodegradabili dalle trame e colori traslucidi: la ricerca su generazioni di nuovi materiali eco-compatibili si affranca dalla approssimazione formale degli inizi e coinvolge la nascita di nuovi universi estetici.

Ma allo stesso tempo la sensibilità ecologica ci porta anche a giudicare diversamente progetti che presentano una quota implicita di imperfezione che non sarebbe stata prima accettabile. Hi-tech e low-tech si coniugano liberamente in oggetti in cui tecnologie preindustriali convivono con quelle più avanzate. L'innovazione sostenibile si accompagna talvolta ad estetiche che fanno riferimento ad una natura 'bruta' o comunque non formalmente 'depurata', luogo di metamorfosi che comprendono elementi di casualità e imprecisione.



Figure 8 Samuel Cabot Cochran, Grow, 2005. Sistema che combina sottili film fotovoltaici e un sistema piezoelettrico che converte l'energia eolica.

L'imperfezione dell'oggetto di scarto può divenire ad esempio l'elemento chiave del progetto; alcuni prodotti dell'ecodesign vengono percepiti inconsciamente con un richiamo alla pop art; altri, soprattutto quelli basati sulle strategie innovative di riuso, ci indirizzano ad apprezzare il prodotto come una sorta di collage o di ready-made, formalmente discutibile se valutato con i parametri classici dell'estetica del design.

Con l'influenza dei paradigmi della fuzzy logic cade l'idea di un progetto necessariamente preciso: l'innovazione oggi passa anche attraverso la rivalutazione dell'umido, dello 'sporco', del degradato, di materiali e processi imperfetti che si accompagnano però all'idea di una capacità di autorigenerazione dell'ecosistema naturale e industriale. La fine del modernismo, come teorizzato da Rosalynn Kraus e Yves Alain Bois, coinvolge d'altra parte anche l'emergere di una 'estetica dell'informe', contro una idealizzazione della forma e una concezione asettica del progetto (Kraus and Bois, 2003).

Come affermò Salvador Dalì, in risposta a Le Corbusier sul futuro dell'architettura – 'sarà flaccida e pelosa' – così spesso oggi ci troviamo a rivalutare il valore estetico della natura non per la sua presunta perfezione, ma utilizzando materiali e fenomeni al loro stato primario, come la terra, il verde, l'umido, la sabbia, il bruciato. Analogamente riconosciamo una potenziale valenza estetica agli scarti industriali e all'oggetto usato, rispetto ai quali l'ecodesign come l'arte sviluppano ormai una sorta di *mediazione culturale*: attraverso una riflessione sul senso di un progetto in grado di

innovare partendo dal 'desueto' e dal 'rotto', nonché un'attenzione ai processi tecnologici, simbolici ed espressivi in gioco (Duque, 2007).



Figure 9 Steve Pike, *Contaminant*, particolare delle celle di monitoraggio.

Ma anche per quanto attiene i materiali non si può prescindere dalla radicale svolta rappresentata dalla bioingegneria: 'Biodesign harnesses living materials, whether they are cultured tissues or plants, and embodied the dream of organic design: watching objects grow and, after the first impulse, letting nature, the best among all engineers and architect, run its course. It goes without saying that when the materials of design are not plastics, woods, ceramics, or glass, but rather living beings or living tissues, the implication of every project reach beyond the form/function equation and any idea of comfort, modernity or progress' (Antonelli, 2012, p. 7).

I materiali prodotti a partire da cellule viventi non solo rendono improvvisamente obsoleta la dicotomia tra la precisione dei materiali artificiali e l'incontrollabilità del materiale 'vivo'; essi ci prospettano qualcosa di diverso da una natura asservita alle esigenze umane: un mondo realmente post-umano in cui l'ibridazione con l'universo animale o *macchinico* non è più il marchio di una *hybris*.

Conclusioni

La cultura del design è apparsa in grado negli ultimi anni di gestire le inedite estetiche dell'innovazione che genera il suo stesso movimento in campi e ambiti della ricerca molto differenziati. Fornire competenze ma nello stesso tempo trovarsi marginale ai reali processi di innovazione, subire

acriticamente l'influenza delle 'scienze dure' erano i rischi principali in cui essa poteva incorrere. Dallo scenario delineato appare invece un design che lavora quotidianamente a nuove elaborazioni della sua appartenenza, equidistanza o estraneità a paradigmi mobili tra arte e scienza.

Un risultato significativo che emerge dalle esperienze più recenti è che alla storica fascinazione del design per la scienza, comunque secondo un approccio molto più libero ed aperto che in passato, corrisponde anche un diverso atteggiamento da parte degli scienziati. Le nuove forme di collaborazione tra creatività, scienza e tecnologia prendono infatti sempre più frequentemente il carattere di una 'Joyous contamination'. In questa nuova atmosfera 'scientist feel, even if just for a moment, liberated from the rigor of peer review and free to attempt intuitive leaps. Indeed, physicists, mathematicians, computer scientists, engineers, chemist, and bioethicists have leaped at the opportunity, their contribution encouraged and celebrated in a few centers of 'irradiation', such as the London's Royal College of Art Design Interactions program or Le Laboratoire, an idea incubator in Paris'. Risultato di questo nuovo modo di operare è l'intreccio tra 'the lyrical and demonstrative power of art and the realistic possibilities of design'(Antonelli, 2012, pp. 6-7).

Ma possiamo sostenere anche qualcosa di più radicale ponendoci da un altro punto di vista: quando parliamo oggi di estetiche dell'innovazione dobbiamo dimenticare la vecchia ricerca scientifica in cui 'il bello' è un corollario affidato alla sensibilità personale o il riconoscimento implicito di un immaginario legato ad una tecnica spesso aggressiva e autoidiretta; in cui il determinismo biologico è il solo concetto guida nella comprensione di un universo del vivente di cui si nega la irriducibile enigmaticità.

Sotto l'egida di un progresso tecnico-scientifico come categoria critica e non più assoluta, emerge oggi una attenzione sempre più forte alla ricerca di una *concreta vivibilità* di un mondo percepito ormai come costitutivamente ibrido e post-umano. Una vivibilità da costruirsi quindi attraverso un continuo vaglio etico, ma che passa anche per la sperimentazione incessante, talvolta disordinata, di sempre *nuove forme inspiegabili di bellezza*. Quale che sia l'universo originario di senso da cui provengano.

References

Antonelli, P. (2008) *Design and the elastic mind*. New York: the Museum of Modern Art.

- Antonelli, P. (2011) *Talk-to-me. Editorial for the exhibition Talk to Me.*
[Online] The Museum of Modern Art New York. Available from:
<http://www.moma.org/interactives/exhibitions/2011/talktome/essay>.
[Accessed: 30th December 2014].
- Antonelli, P. (2012) *Vital design.* In Myers W. (eds.), *Biodesign. Nature, Science, Creativity.* New York: the Museum of Modern Art.
- Baudrillard, J. (2004) *Il sistema degli oggetti.* Milano: Bompiani.
- Bourriaud, N. (2010) *Estetica relazionale.* Napoli: Postmedia.
- Branzi, A. (1988) *Pomeriggi alla media industria. Design e Seconda Modernità.* Milano: Idea Books.
- Branzi, A. (2008) I colori instabili dell'incertezza. *Interni*, n. 578.
- Chesbrough, H., Van Haverbeke, W. and West, J. (2006) *Open Innovation, Researching a new paradigm.* Oxford: Oxford University Press.
- Danto, A. (2008) *Dopo la fine dell'arte. L'arte contemporanea e il confine della storia.* Milano: Paravia Bruno Mondadori.
- Duque, F. (2007) *La fresca rovina della terra. Dell'arte e i suoi rifiuti.* Napoli: Bibliopolis.
- Diodato, R. (2005) *Estetica del virtuale.* Milano: Bruno Mondadori.
- Haque, U. (2005) *A coreography of Sensation.* In Thwaites, H. (eds.), *Hybrid Realities & Digital Partners.* Proceedings Of The Tenth International Conference On Virtual Systems And Multimedia, 17-19 November, 2004. Softopia Japan.
- La Rocca, F. (2006) *Il tempo opaco degli oggetti.* Milano: FrancoAngeli.
- Krauss, R. and Bois, Y.A. (2003) *L'informe.* Milano: Paravia Mondadori.
- Maffei, S. (2010) *Design of the other things.* Catalogo della omonima mostra, Triennale di Milano Design Museum, 26 maggio-27giugno 2010. Milano: Electa.
- Myers, W. (2012) *The Hybrid frontier.* In Myers, W. (eds.), *Biodesign. Nature, Science, Creativity.* New York: the Museum of Modern Art.
- Perniola, M. (2005) *I Situazionisti. Il movimento che ha profetizzato la Società dello spettacolo.* Roma: Castelvechi.
- Pireddu, M. and Tursi, A. (eds.) (2006), *Post-umano.* Milano: Guerini.
- Ritter, A. (2007) *Smart materials in architecture, interior architecture and design.* Basel: Birkhäuser.
- Simondon, G. (1969) *Du mode d'existence des objets techniques.* Paris: Aubier.
- Steadman, P. (1988) *L'evoluzione del design. L'analisi biologica in architettura e nelle arti applicate.* Napoli: Liguori Editore.
- Vercellone, F. (2013) *Dopo la morte dell'arte.* Bologna: Il Mulino.

The Human Emotional System and the Creativity in Design

Marco MAIOCCHI and Margherita PILLAN*
Politecnico di Milano

The paper presents the basic human emotional systems, according to recent neurobiological researches, and the way in which the perception of the aspects (or the use) of design artefacts can rise those emotions; such an arousal can be due to primary perceptual aspects (colours, shapes, materials, etc.) or to recalls to metaphoric 'scripts'. Those aspects allow to build a useful model both in the analysis of the emotions produced and in the synthesis of desirable characteristics of design artefacts. Such a model explains why some masterpiece, as well as some commercial design products, have success on the market. Examples of different artefacts (products, communication, services, etc.) are presented, showing which of their perceptual characteristics affect unconscious interpretation, and which emotions are involved, making them desirable 'objects'. The same model is presented as a design support, for suggesting to the designer roads to be explored in attributing perceptual characteristics to the artefacts, to raise specific emotions. In this way, the rigorous industrial design process, as well as an artistic one, can be complemented with a parallel approach inventing new constraints dimensions, and them becoming a creativity prompter.

Keywords: Emotional design; creativity; neurosciences in design

Introduction

At the beginning there was craftsmanship, characterised by the craftsman capabilities: experience, product competence, apprenticeship, non-formalised excellence, one shot products, personalization, and the products had high costs. With the growth of middle class, the requests for goods imposed a larger production capability and a reduction of costs: industrialisation can be seen as a consequence of those facts. The need of a standard quality and of a huge product numbers resulted into serial

*Corresponding author: Margherita Pillan | e-mail: margherita.pillan@polimi.it

production, with attention to processes and to their definition, and in particular to the initial design phases: Industrial Design was born, with attention to the early phases, to formalised and measured processes, to standardisation, to cost reduction and to controlled quality.

The serial production method spread everywhere, and competition increased: today, also complex products as cars, are, for each market segment, aligned from the point of view of costs, performances, consumptions, maintainability, life duration, and so on.

The only way a maker had to compete has been to add some new 'meanings' to the products, making the difference, and adding some reasons for convincing customers to buy one product instead of another.

For the above reason, beside the proper functions and an acceptable cost, products started to present shapes and styles able to communicate to users emotions; it is what we now call *Design*: industrial production assuring costs and quality are considered unavoidable and implicitly understood, while a product must have the capability of communicating some kind of emotions. In some way we can consider the present status of mass products industry as in a post-industrial phase, where capitals are, in some way, a commodity.

So, when we think of a Design artefact, we should mean an element in which at least three different 'components' are present: *function*, *shape* and *meaning* (Maiocchi e Pillan, 2009):

Function: the goal of the artefact;

Shape: the perceptual appearance (in a broader sense, we consider 'shape' any kind of appearance for any sensorial channel, including hearing, touching, smelling, tasting);

Meaning: the communicated interpretation, often unconscious and often unrelated to the functions, able to rise emotions.



Figure 1 The vacuum cleaner Bidone Aspiratutto, suggesting a war against dirty.

As an example, the vacuum cleaner *Bidone Aspiratutto* (figure 1), has the function of sucking powder, the shape recalling the structure of a vacuum cleaner (body, tube and brushes), but the same shape, with army-green colour, stencil letters, rough and essential lines, convey the meaning of a war against the dirty. The perceived meaning (and the role played while using it) constitute a significant element for choosing it.

A model for Design

We consider the scheme in figure 2 a suitable model for the Design activity:

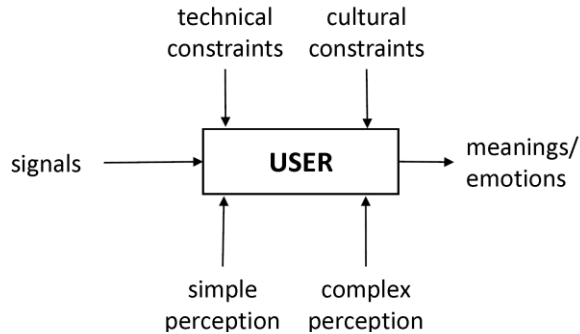


Figure 2 A model for Design activity.

In the model, besides obvious technical (including economic) constraints:

Signals: any kind of information, by any kind of sensorial channel;

Meanings/emotions: results by processing the gathered information;

Simple perception: processes activating the more ancient parts of our brain, where primary emotions arise;

Complex perception: processes activating the neo-cortex (logical and cognitive functions), rising emotions by interacting with lower levels;

Technical constraints: of course, an artefact cannot violate physical laws, as well as must take in consideration usability aspects (f.i. weight, or size), of production costs (materials, processes) and so on;

Cultural constraints: besides the basic primary feelings, common to every human, there are inherited cultural aspects allowing or preventing to accept some values and the associated metaphors.

In the following we will examine more deeply most of the above concepts, and the related implications to our Design model.

Emotions and design

Emotional systems

According to most of neuroscientists, the human brain can be schematized into three layers, referred to the seniority in the species evolution (Kral and MacLean, 1973; Striedter, 2005). The inner part (*reptilian*) is the site in which primary emotions arise, mainly related to survival (seeking, fear, anger, etc), the middle part, developed in mammals, is related to some typical maternal emotions, and the upper part (*neo-cortex*) is more related to rational and logic processes.

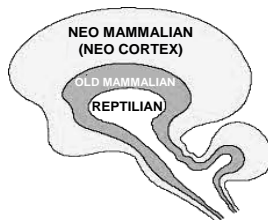


Figure 3 A scheme of the human brain structure.

Among the various models describing the neurophysiology of the emotions, we choose the more recent and simple (Panksepp and Biven, 2012).

Following Panksepp and Biven, there are seven basic emotional systems:

Seeking: makes creatures interested in exploring, and in getting excited when they get what they might desire;

Rage: aroused by frustration, tends to freedom of action;

Fear: leads creatures to run away, or, weakly stimulated, to freeze;

Panic: governs social attachment emotion, specifically for the absence of maternal care when babies;

Lust: involves sex and sexual desire;

Care: maternal love and caring;

Play: pushes young creatures to facilitate learning.

Each emotions is characterised by a specific location in the brain and by a specific neurotransmitter class exciting it.

As Panksepp and Biven (2012) suggest, *seeking* can be considered the mother of the other emotions: it is what allows us to recognize very quickly (without conscious processes) the context, reacting immediately to a possible dangers, or to positive signals, involving in that other emotional circuits, such as *fear*, *rage*, *lust*, and so on.

The various parts of the brain are interconnected and are able to influence each other; more, the neo-cortex, due to cultural aspects and personal experiences, influence the interpretation of the signals, changing their capability of raising emotions; in any case, when an emotion arises, it happens always in the specific area and through the specific neurotransmitters. So, we can consider the interpretation mechanisms from the signals to the emotions as a chain, as suggested by figure 4:

Seeking: is the basis for the interaction with the world, allowing to discover signals and then to rise other emotions;

Lust, Rage and Fear are common to any species of chordata, and are the basis for survival through reproduction, nutrition, aggression, defence, escape; proper signals can excite them (e.g. aggressive gestures, contrast in colours/shapes, 'dangerous' shapes, etc.)

Care, Play, Panic/Grief are useful to the species without autonomous offspring (as humans); proper signals rise them (e.g. smiles, smooth lines, etc.):

Any kind of structure processed by the neo-cortex, typically as metaphoric recalls (Lakoff and Johnson, 1980), can provide interpretations able to excite any of the other emotional centres¹.

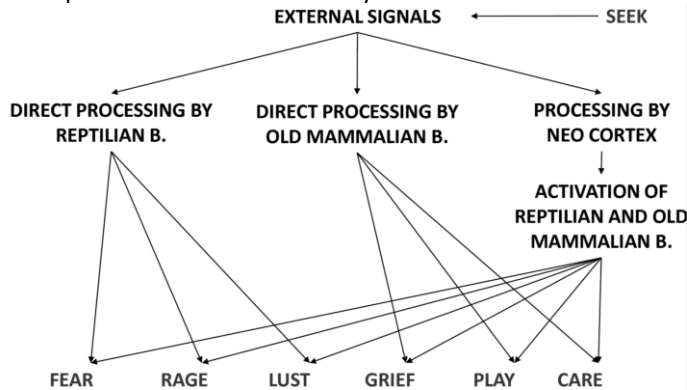


Figure 4 Paths from signals to emotions.

There are no good and bad emotions: each of them is a way in which the evolution of the species found the best organisation to survive, to grow and

¹ This fact makes more complex the interpretation of the cultural elements: in fact, while 'simple signals' accessing the reptilian and old mammalian brain can be considered pre-cultural, the way in which the neo cortex interprets metaphoric structures can be largely influenced by cultural aspects.

to spread the single species. Nevertheless, we can feel pleasant and unpleasant emotions: according to the mentioned studies, the pleasure is related to the production of dopamine and endorphin, that stimulate the peripheral system, increasing our capability to react to the environment, increasing our performances useful for the evolution. Among the primary emotions, we can consider pleasant: Seeking, Lust, Care, Play; but often the interpretation of stereotypic signals that could be unpleasant are relocated as pleasant (eg. Play allows children to simulate war, fear, etc.).

Simple perceptions

Many studies have been carried on showing the influence of the shapes on the mood of the observers, and many others have been carried on observing the emotional reactions to the colours.

Among the former, it is well known the *bouba/kiki* effect (Köhler, 1929; Ramachandran and Hubbard, 2001); asking to a number of people which of the two shapes (figure 5) is called *kiki* and which one *bouba*, more than 95% of the answers attribute *kiki* to the former and *bouba* to the latter, and the experiment has been proved independent by cultural or linguistic aspects².



Figure 5 'Kiki' and 'Bouba' shapes.

The experiment shows that there are synaesthetic relationships between the sound of the words and the shapes, and in evidence as edges are perceived as aggressive, and related to hard sounds, while round shapes are related to smooth lines and sounds. Further experiments shown that it is possible to measure the emotions related to specific shapes (Lu et al., 2012). Also the literature on the emotional effect of the colours is rich (Whitfield and Whiltshire, 1990), in particular for marketing aspects (Aslam, 2006).

Interesting works have been carried on by Ramachandran, on aspects we can easily connect to Seeking and other primary emotional status (Ramachandran and Hirstein, 1999).

2 In fact, Köhler used the terms *maluma/takete*, while the mentioned *bouba/kiki* are due to the other two authors.

Ramachandran presents nine perceptual characteristics that he verified, mainly through functional Magnetic Resonance, able to increase the production of some neurotransmitter (mainly dopamine) and to rise the corresponding emotions. Briefly:

Peak shift: exaggeration of some aspects against the balance of reality: the choice of the enhanced aspects extracts the 'truth' from many contingencies.

Perceptual Grouping and Binding: the principles described by Ramachandran correspond largely to the law of the Gestalt, and to the rules largely described by Kanizsa (1997).

Contrast: Rods and cones in the human retina are organised to emphasize the perception of edges and contours; other parts of the brain in the visual cortex respond mainly to such an extracted information; so, a line drawing or a cartoon stimulate these cells as effectively as a 'half tone' photograph. Such contrast extractions seems to be related to 'pleasing to the eye'.

Isolation: the isolation of a single perception modality before amplifying the signal in that modality.

Perceptual problem solving: to discover a signal in noise is rewarding in itself; we can get emotion in finding a solution from clues.

Symmetry: discovering symmetry is rewarding: symmetry is a typical aspect of the predators, and our eyes and brain are properly organised to detect it; but symmetry is also economy in knowledge, because the property of a part can be used to understand a whole.

Generic viewpoint: the human visual system is a Bayesian machine (roughly, we learn from experiences, and use them for predictions). Among different possible interpretations of a scene, we choose the most likely, preferring generic viewpoints, abhorring coincidence.

Repetition, Rhythm, Orderliness: regularities reduce the effort for recognition and learning.

Balance: The feelings related to this attribute have been examined pointedly and elegantly by Wassily Kandinsky (1947)



Figure 6 *Peak Shift: a Winx, an Italian successful cartoon character , in which a fairy is presented with peak shifted shapes in the feminine aspects, exciting at least Seeking; Perceptual grouping and binding: the wall clock DIY by Karlsson, in which separated elements rebuild a unique well recognised composition; Contrast: the home page of Google, with the coloured logo, a search window on a completely blank background, constitutes a strong contrast, and points out to the Seeking activity of the search; Isolation: the shape of Coca Cola bottle is a product symbol with high recognisability; Perceptual problem solving: how can Equilibrium bookcase by Malagana Design stand up? Symmetry: present in most of the human artefacts, eg. cars; Generic viewpoint: irritating panic bar in a door without the information of the position of the hinge; Repetition, Rhythm, Orderliness: modularity of the possible compositions in Fortytwo poufs by Y. Oh.*

Complex perceptions

Our brain builds stereotypes relating the emotions to perceivable elements. Gestures, postures and expressions can be connected to emotions (Darwin, 1872; Ekman, 2003). So we are able to interpret the emotional status of a person with Rage or Fear, and we recognise supposed or real leadership, shame, glory anxiety, pride, and so on. This recognition can be related to static signals (e.g. dress code) as well as to scripts (stereotypical stories, with role playing, causal and/or temporal dependencies, etc). This is what Lakoff calls *metaphor* (Lakoff and Johnson, 1980).

According to him, we consider a metaphor as a comparison between the conceptual structures of two different fields. If we take into account elements (nouns) and relationships (verbs) of the two fields, we can represent them with very simple semantic networks, and the comparison is

made clear: overlapping parts are the core of the possible metaphors, while non coincident parts are a strong basis for explorations and creativity.

According to Lakoff (2004), the political discourses by G. W. Bush after his election in 2001 were largely based on the Bible's Genesis (figure 7).

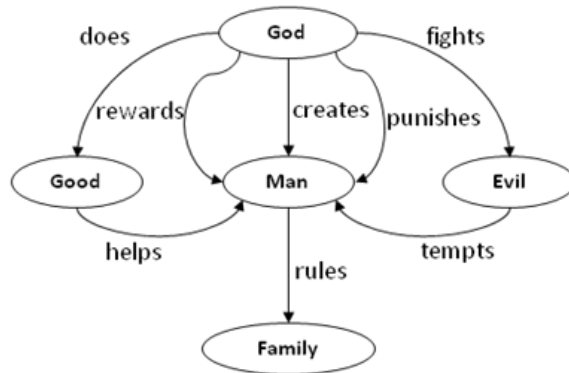


Figure 7 The foundation of a family in many religions: God created the Man, and operates the Good, fighting the Evil; God rewards the Man operating the Good and punishes the Man following the Evil; the Man build and rule a Family; when putting the word Father in the place of God, we can see that the Man on his turn, will behave as God do, toward his Sons.

This model involves many emotions, among which Rage and Fear (punishment), Care (rewarding), Panic (absence of rewarding), Seeking (temptation), and so on.

The use of this model as metaphor, in order to communicate political decisions, can be very powerful, because the acceptance of the proposed content can be accepted on the basis of the already embodied structure; using the above conceptual frame, introduced the nations as persons, and then the United States as persons willing the Good and fighting the Evil, and then introduced the notion of 'Rogue State' as personification of the Evil: so the preventive war against Iraq was fitting as a right fight against the Evil, without any concrete reason for an attack.

The various levels of our brain are just a simplified model; we have an unbelievable number of interconnections among the neurons, and there is no continuity solutions between the various levels; the different parts of the brain works in parallel, and with many retrofitting; possibly, with a growing complexity, some kind of specialisation arises, useful to a specific culture; if we study the different the evolution of the cultural values inside any

population (Hofstede, Hofstede and Makov, 2010), we discover that stereotypes and metaphors are coherent with their cultural history, and with typical customs.

The neo cortex seems to be just the 'repository' of cultural and experiential aspects: learned models and information, results of personal experiences, personal mental processes and thoughts shape day by day the brain networks, increasing our capabilities, but any process, beside conscious and rational, has to cope with the emotions, that it, any process occurring in the neo cortex interacts with the lower levels, exciting the centres related to the basic emotions; on the reverse, any process coming from the farthest body part is able to reach the central nervous system, interacting with primary emotions or with cognitive capabilities, inducing emotions.

The stereotypical structures we can recognise as product of the experience are very powerful. For example, if we look to the two pictures below, we have a lot of similar signals, but different emotions rise; we can examine figure 9 (reported below):



Figure 8 . Similar signals and different emotions.

According to the a widely spread stereotyped common sense, we could model the signals network in two different semantic nets³:

³ The example is also a demonstration of what we already said about the cultural influence on the emotions driven by the neo cortex: while the motorcyclists do not show any aggressiveness, the stereotype of a gang of violent persons, dedicated to drinking and drugs, is carried on in specific environments, non only of a particular western culture, but also of a specific social class. For sure none of the motorcyclists could consider any risk in looking at the presented picture.

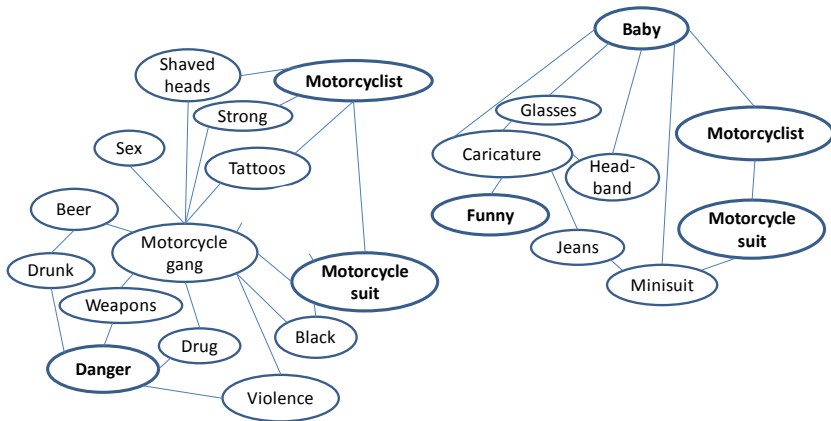


Figure 9 Two different semantic networks, for two different metaphoric interpretation of the pictures in figure 8. Many of the elements put in the scheme are not present in the pictures, but belongs to the stereotyped prejudice.

While looking the former picture, we recognise some motorcyclists with well identified motorcycle suits; they have typically shaved heads, appear strong, have tattoos, leather black suits; all those elements suggest the concept of a motorcycle gang, and the common associations to that refer to free sex, to drunkenness from beer, the use of drugs, violence, weapons: the conclusion is danger, and then Fear.

The second picture presents a similar subject, but we recognise, beside the motorcyclist and the suit, the child: in this context, the glasses, the jeans suit, the head band recall a caricature, and then we consider the occurrence as funny, inducing Play or Care.

A further more complex example could be provided by the character of James Bond, as presented in the movies played by Sean Connery.

The elements gathered in the poster of figure 10 are: an appealing man at the centre top, with a straight, determined confident look, a smoking, a smile, a gun; then many elements belonging to his way of living: beautiful scantily clad women, fighting women, a sport car, a Turkish mosque, an helicopter, an old train, some divers, a man fighting against a shark, a race motorcycle, some tropical palms, a large boat, a jet pack. The semantic network that we can build in order to relate all those items are:



Figure 10 A poster of a movie on James Bond 007.

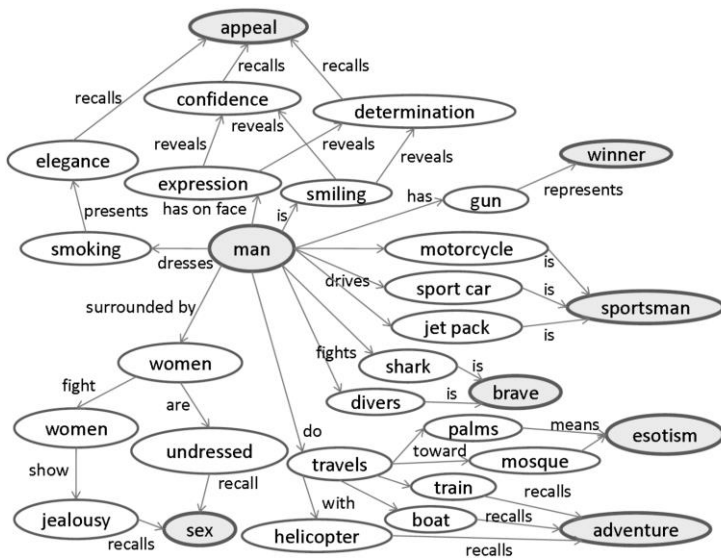


Figure 11 The network representing the elements appearing in the James Bond poster, and the possible implicit relationships.

The poster represents a man at the centre and many details around him. The man expresses with his face confidence and determination, without any fear and with a certain challenging attitude: the man is appealing. Around him, beautiful women, scantily clad, competing for him: the man is a

sexual goal. He has to cope with sport cars and racing motorcycles, but he is using also a jet pack; he is athletic. He has a gun, ready to kill, dangerous: he is a winner. He is able to face also very dangerous, fighting with divers and with sharks: he is brave.

All those associations point out that the man is a champion among the males: within a group of animals, he would be for sure the most required reproductive exemplar. The resulting emotion has for sure to cope with Lust. Fights and the gun suggests also Rage.

Those emotions are pivoted on the character of James Bond, so that any product used by him will be naturally associated with that. Rolex watches and Aston Martin become symbols of the reproductive adventurous desirable male, and, following the success of the movies, acquire those representation capability.

Examples and experiences

If Design need to move emotions, it must "tell" things stimulating emotions; it is possible to do it by targeting directly the reptilian brain or the old mammalian system, but it requires a big efforts and provides poor results: edged lines, aggressive faces, rounded shapes, soft tones, and so on can work, but are not so powerful and have many limits, in particular for complex artefacts (it is not sufficient to produce a rounded smart phone for guaranteeing success); we need more.

We need to start from the upper levels, accurately selecting metaphors we can relate to scripts able to stimulate the pleasant emotions (Care, Lust, Play, Rage, Seeking), and providing in some way the perception and the communication of such metaphors.

We are quite far from the capability to set up a method for producing 'good design', but we strongly believe that the model we built on the Emotional Design can be a valid complementing tool, able to feed lateral thinking and creativity.

Looking to the actual production of any kind of artefacts (products, interiors, communication, web, and so on) it appears that the designers used intuitively many of the described principles and techniques.,

In the following we will show and comment some examples of different artefacts, and some more conscious experiences.

Door Handles

In many courses and workshops, we presented to the students the following set of handles, asking them to qualify each product, according to a predefined grid: *gender, age, life style, social level*⁴.

The results of the experiment shown that there are specific perceptual characteristics strongly related to a stereotypical view of the potential user: the colour, the presence of curves, the thickness of the structure and the shape suggesting heaviness.

The gold coloured handles are suitable for women, while silver is for men; light structures for women and heavy for men; warm colours and light structures recall soft sensations, we can connect to Care; cold colours, heaviness and thickness recall aggressive sensations, we can possibly connect to Rage.

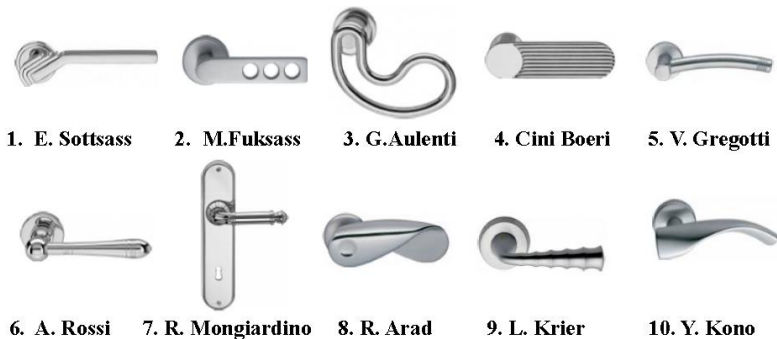


Figure 12 A set of handles by well known designers: the handles no. 1, 3, 4, 5, 6 and seven are in yellow brass.

Cars

It is really easy to compare the shape (and the angle of view) of the Miura Lamborghini with the one of a shark: the driver expresses danger and Rage.

⁴ The handles were chosen with the purpose of a proper differentiation in the shapes and a proper 'personality'. The educational goal was to make the students experienced about their bias in interpreting the suitability of a handle to a role: colours, curves and other simple perceptions were used to define the emotional character of the user.



Figure 13 A Lamborghini Miura and a shark.

Mid-complexity products

We already mentioned the vacuum cleaner *Bidone Aspiratutto*.

We can consider a different vacuum cleaner, the one of the DC series produced by Dyson (figure 14). Despite its plastic structure, it imitates science-fiction shapes, advanced technologies, sophisticated structures, and it is promoted by a man (Mr. Dyson himself), not at all appearing as a technician. The built metaphor is clear: highly sophisticated ultra-modern technology for who is able to cope with dangerous situations. Rage against dirty.



Figure 14 DC series of the Dyson vacuum cleaner: a 'ghostbuster of the dirty'.

Advertising

The video clips used in Italy to promote home cleaning products seems completely aligned on the model of the fairy tale.

By examining them, we can recognise a unique common structure that can be completely modelled through the Propp's tale structures (Propp, 1928). The model includes specific characters (the hero, the donor, the antagonist, and so on) and actions (damage, gift, fight, victory, reward). The ads spots represent always dirty = damage, cleaning product = magic mean;

housewife = hero; cleaning = fight; appreciation of a male (or of the mother-in-law) = reward; automatically, emotions are involved: the damage has to cope with Panic/Grief, the hero's leaving to Seeking, the donor to Care, the fight to Rage, the reward to Care.



Figure 15 The advertising spot of CIF for the Italian TV: in a medieval castle, it seems impossible to clean a dirty cauldron, but a hero comes with a magic mean, solve the problem, get the throne as a reward, and finally unveils him/herself: a woman! (the queen of the house: gender stereotypes are enforced by this spot).

Health Care environments

if we want to influence the emotional status of patients in an hospital, it is not sufficient to change the colours on the walls, but it is mandatory to tell (make perceivable) a metaphoric tale; paintings in a waiting room are just Seeking, while the same paintings, together with an explanation, a book for collecting comments, some personal dialogue about becomes Care (the metaphor becomes: I, good and affectionate mother, am taking care of you, you are my children, I love you, I want your sake)

Health care involves many emotional aspects in the patients, being they in a negative psychological attitude, related to fear, uncertainty, suffering, and so on. Emotional Design cannot, of course, affect the healing process, but can largely improve the psychological status, and possibly improve the effectiveness of the therapies. We mention here three done actions, some of them with measured or qualitatively verified effects.

Disguising an NMR machine. A NMR machine is an impending object, imposing to stay motionless for a while, accepting annoying noise; its use is unpleasant for adults, and more and more for children; in order to avoid failures in the operations, the children are subject to sedatives, not only calming them, but also reducing their motility. In the Cancer Centre Pausilipon in Naples, the Radiology Department Chief physician asked an artist to disguise the machine, without influencing the operational aspects: the artist covered any part of the machine with funny pictures, creating optical effects, rhythms, intriguing images. The children, during the examinations, activated their *seeking*, reducing *fear* and psychological *grief*: the result has been a dramatic reduction of sedative administration.



Figure 16 A NMR machine, and the one 'disguised' as a toy.

Waiting in health care environments. Patients spend a lot of their time in bureaucratic activities and in waiting. During both, their emotional status is very negative. Simple intervention, and often without costs, can improve dramatically the situation.

The former picture in figure 17 refers to the reception desk of the Local Health Care Unit ASL8, in Asolo, a small town in Northern Italy; beside tickets for ruling the queues, large screens to warn a call and comfortable upholstered chairs, the desk has an unusual shape: while usually the reception desks are convex, as a semicircle, with many places at the circumference for coming people and few people in the central internal part, in this case the shape is inverted, and is concave toward the people: the emotional result is very interesting: while usually the clerks are perceived as inside, and the people is outside, here the contrary is perceived; more, the desk is 'embracing' patients. *Inside* and *outside* are powerful primary metaphoric interpretation mechanisms (Lakoff and Johnson, 1980), coping with protection, refuge, and then with *grief*: the reverted concavity reduces this negative emotions; more, the 'embrace' by the desk enforces *care*.



Figure 17 A Reception Desk at ASL 8 in Asolo, and a Waiting Room at INT in Milano.

The latter picture is the waiting room of the Breast Radiology Department at Istituto Nazionale dei Tumori (a well known Cancer Centre) in Milan. This Department has been recently refurbished, changing simply the colours of walls, ceilings and floors: the represented room, for example, has orange and warm-white walls, straw-yellow floor, and warm lighting at ceiling; more, the chairs are upholstered with deep purple fabric. In other parts of the Department, the doors purple, fuchsia, acid-yellow, green constitute a colour code unusual for hospitals, and the same for walls and floors. As the whole Department, the waiting room is filled of many paintings, making the it an intriguing set of colours and shapes. The results of those intervention is a general perceivable positive emotional status crossing patients, doctors and staff. Beside some naïve observation about the quantity of smiling people in respect to other more traditional departments, non structured comments have been recorded from many patients, putting in evidence their strong *seeking* activity, positively influencing the emotional status.

Final remarks

The exposed method is far from being a rule to design artefacts. Nevertheless the authors strongly believe that the ‘collateral’ effects of the perceptual properties of the objects are the real value of the design, and a scientific knowledge on the emotions neurophysiology can be a useful tool for lateral thinking and then to creativity.

The presented studies require further investigations, and researches are on progress about the measurements of the raising emotions, in particular in non-invasive ways: studies on the relationships between emotions and physiological parameters (heart beat, skin humidity, etc.) are on progress, based mainly on the polyvagal theory (Porges, 2011).

Further researches are on progress about Emotional Interaction Design, devoted to the investigation of the ‘dynamic dialogic’ aspects on the interaction in rising emotions.

References

Aslam, M.M. (2006) Are You Selling the Right Colour? A Cross-cultural Review of Colour as a Marketing Cue. *Journal of Marketing Communications*, 12 (1), 15-30.

- Darwin, C. (1872) *The Expression of the Emotions in Man and Animals*. London: John Murray.
- Ekman, P. (2003) *Unmasking the Face: A Guide to Recognizing Emotions from Facial Expressions*. Cambridge: Malor Books.
- Hofstede, G., Hofstede, G.J. and Minkov, M. (2010), *Cultures and Organizations: Software of the Mind*. New York: McGraw-Hill.
- Kandinsky, W. (1947) *Point and Line to Plane*. New York: Dover Publications.
- Kanizsa, G. (1997) *Grammatica del vedere. Saggi su percezione e Gestalt*, Milano: Il Mulino.
- Köhler, W. (1929) *Gestalt Psychology*. New York: Liveright.
- Kral, V.A. and MacLean, P.D. (1973) *A Triune concept of the brain and behaviour*. Toronto: University of Toronto Press.
- Lakoff, G. and Johnson, M. (1980) *Metaphors we live by*. Chicago: University of Chicago Press.
- Lakoff, G. (2004) *Don't Think an Elephant*. Vermont: Chelsea Green Publishing.
- Lu, X., Suryanarayan, P., Adams, R.B., Li, J., Newman, M.G. and Wang, J.Z. (2012) *On Shape and the Computability of Emotions*. Paper Presented at the Proceedings of the 20th ACM international conference on Multimedia, New York.
- Maiocchi, M., and Pillan, M. (2009) *Design e Comunicazione*. Firenze: Alinea.
- Panksepp, J. and Biven, L. (2012) *The Archeology of the Mind*. New York: W. W. Norton & Company.
- Porges, S. (2011) *The Polyvagal Theory: Neurophysiological Foundations of Emotions, Attachment, Communication, and Self-Regulation*. New York: W. W. Norton & Company.
- Propp V.J. (1928) *Morphology of the Folktale*. Austin: University of Texas Press.
- Ramachandran, V. and Hirstein, W. (1999) The Science of Art. *Journal of Consciousness Studies*, 6, (6-7), 15-51.
- Ramachandran, V.S. and Hubbard E.M. (2001) Synaesthesia: A window into perception, thought and language. *Journal of Consciousness Studies*, 8 (12), 3-34.
- Striedter, G.F. (2005) *Principles of Brain Evolution*. New York: Sinauer Associates.
- Whitfield, T.W. and Whiltshire, T.J. (1990) *Color psychology: A critical review*. New York: General Psychology Monographs.



Autarchy: The Making of Dutch Design in Practice

Joana OZORIO DE ALMEIDA MEROZ*
VU University Amsterdam

Since the early 1990s a new term became increasingly current in the international design circuit: Dutch Design. It became strongly associated with objects frequently described as conceptual, unconventional, environmentally friendly and sober, among others. The canonical discourse takes a culturalist approach to Dutch Design, explaining Dutch Design artifacts as natural reflections of an assumedly fixed national and cultural context. In contrast, this paper explores how Dutch Design artifacts participate in creating new social formations that contradict, escape or otherwise transcend conventional accounts of Dutch culture, heritage and history. Informed by Actor-Network-Theory (ANT), it examines the social and material construction of one specific artifact, namely Autarchy (2010) by Studio Formafantasma, and how in the process of it being construed as Dutch Design it reconfigured the Dutchness of Dutch Design and the context of the nation. Autarchy thus requires the formulation of a different framework to study Dutch Design, an approach that is able to account for its involvement in Dutch material culture and its deviations from it. In conclusion, I suggest that focusing on how artifacts create their contexts rather than on contextualizing artifacts in already existing frames of reference may be a useful means to approach national design histories in times of globalization.

Keywords: Dutch design; context; materiality

Introduction

Since the early 1990s a new term became increasingly current in the international design circuit: Dutch Design. It became strongly associated with objects frequently described as conceptual, unconventional, environmentally friendly and sober, among others. Most exhibitions and publications that attempt to explain Dutch Design's traits appeal to the

* Corresponding author: **Joana De Almeida Meroz** | email: j.ozoriodealmeidameroz@vu.nl

characteristics of Dutch culture, which these accounts reduce to a mix of well-known factors: Calvinism, the artificially constructed Polder landscape, an independent spirit, and a shortage of natural materials and industries (e.g. Ramakers, 1998; Betksy, 2004; Junte, 2011). In this dominant narrative, Calvinism supposedly explains Dutch Design's simplicity, the independent spirit its recalcitrance, and the artificial landscape and shortage of industries its conceptuality. This means that, in these accounts, Dutch Design objects function merely as illustrations of established Dutch social, historical, cultural and political contexts. In other words, an assumedly stable national background is taken as a frame of reference according to which the meanings of design are derived. As such, the mainstream Dutch Design discourse can be said to take a linguistic constructionist (Hekman, 2009), or culturalist (Reckwitz, 2002), approach to materiality, where the 'artifact becomes an empty space, of interest only because of the 'meanings' that invest it with significance' (Pinney, 2005, p. 257), and functions merely as a passive reflection, or empty receptacle, of conventional history and culture.

There are two shortcomings to this culturalist approach to materiality. First, by preserving the national context, it reproduces dominant socio-political logics and power structures, leaving little room for revision and contestation. Second, it is empirically weak, since it assumes rather than investigates actual associations between artifacts and their contexts. With this in mind, in this paper I explore how Dutch Design artifacts participate in creating new social formations that contradict, escape or otherwise transcend conventional accounts of Dutch culture, heritage and history.

To this end, I rely on a body of research that has been labeled as being part of the material turn in the humanities. Joyce and Bennett (2010) characterize this research as shifting the focus from social contexts as determinant of the meanings of neutral artifacts to a conceptualization of the entanglement between objects and subjects, without falling into the trap of technological determinism. I am particularly indebted to Nicholas Thomas' (1999) investigation of how quotidian things contribute to social change. He points out that while by now it is generally accepted that technical innovations play a role in the creation of novel social forms (e.g. the printing press for imagining national communities, the railway for structuring colonial worlds), his interest lies in the role of everyday commodities in social transformation. Critical of the suggestion in Arjun Appadurai's 1986 edited collection *The Social Life of Things* that objects are passive and acquire meaning as they 'are successively recontextualized' (p. 6), Thomas emphasizes not the contextualization of things, nor how things

express social transformations, but how things change contexts instead: 'how an artifact actively 'texts' its context' (p. 7).

This paper follows on this track. While Thomas draws attention to the role of indigenous textiles in the process of conversion to Christianity in 19th-century Polynesia, here I discuss how a specific artifact, namely *Autarchy* (2010) by Studio Formafantasma, has been construed as Dutch Design and how in this process it reconfigures the notion of Dutchness of Dutch Design. To do so, I pursue Albena Yaneva's Actor-Network-Theory (ANT) perspective on design (2009), and examine *Autarchy* 'as a type of connector' whose 'scripts and incorporated programs of action compel and rearticulate new social ties' (p. 273), and hence whose specific material properties are 'related to specific ways of enacting the social' (p. 277). I find, however, her suggestion of following only 'the practices of designers rather than their theories and their ideologies' unnecessarily limiting for the case at hand. Insofar as the writing of texts and the making of images are also situated material practices that impinge upon the construction of design artifacts, here I consider the textual and visual discourses with which Formafantasma structure *Autarchy* as part and parcel of their practice.

The data used in this research was gathered from visits to Formafantasma's home and studio during the making of *Autarchy* and its predecessor *Baked* between September 2009 and April 2010, the press clippings in Formafantasma's archives, and a series of retroactive interviews between September 2010 and March 2011.

Dutch Design as reality machines

Autarchy (2010) is a multimedia installation by Andrea Trimarchi (Sicily, 1983) and Simone Farresin (Veneto, 1980), who together make up design Studio Formafantasma (figure 1). *Autarchy's* 'script' (Akrich, 1992; Akrich and Latour, 1992; Latour, 1992) can be clearly discerned in the project's promotional text: '*Autarchy* is an installation that proposes an autonomous way of producing goods and outlines a hypothetical scenario in which a community embraces a serene and self-imposed embargo, and where nature is personally cultivated, harvested and processed to feed and make tools to serve human needs. *Autarchy* pays homage to the uncomplicated, the simple and the everyday [...] *Autarchy* suggests an alternative way of producing goods in which inherited knowledge is used to find sustainable and uncomplicated solutions' (Formafantasma, 2014). At the heart of the installation is a collection of vessels produced of self-made biomaterial



Figure 1 Autarchy. Source: <http://www.formafantasma.com/autarchy-installation>.

(70% flour, 20% agricultural waste, 10% limestone) and dyed with self-made pigments, themselves obtained from drying, boiling and filtering vegetables, spices and roots (ibid). In order to communicate the narrative that the vessels are products of a 'perfect production process without waste', where the cereal sorghum 'is harvested and used to create tools, vessels and food', the function of each element in the installation—the cereal ears, flourmill, drying ovens, loaves of bread, straw brooms—is to illustrate the different steps in the process of manufacturing the vessels (ibid).

In the Dutch Design discourse, this self-referential focus that can be perceived in *Autarchy*, in which an artifact's manufacturing process can be semiotically deduced from the object's material qualities, is seen as one of the essential and distinguishing characteristics of Dutch Design. This argument can be traced back to Aaron Betsky's contribution to *Reality Machines: The Everyday Mirrored in Contemporary Dutch Architecture, Photography and Design*, and later popularized by his book *False Flat* (2004), which since its publication has arguably become *the* canonical narrative of Dutch Design. In these texts, Betsky explains that the 'Dutch have kept themselves occupied for centuries by creating an artificial reality: they regain land from the sea, they create economic, social and political systems based on their own needs, and they add value by investing and trading rather than manufacturing; they understand the importance of artificiality better than most other cultures. The whole country is a reality machine' (2003, p. 5). Thus, argues Betsky, 'the point of what one does as an artist or designer' (2004, p. 44) in the Netherlands since the 17th century, is to help viewers/users understand the artificial nature of their reality. To achieve this, design artifacts 'must reveal their own accidental, temporary, artificial and ad hoc nature' through 'the banal but revealing reflection' of their own conditions of production (2003, p. 5). In another contribution to *Reality Machines*, Pauline Terreehorst proposes that 'a connecting element between all these [Dutch] designs is that they are comments on an original, on an object that can be called both 'simple' and 'authentic'. They [Dutch designs] are never 'normal' houses, blouses, lamps or magazines, but they always refer to that everyday, simple reality' (2003, p. 11). This understanding of the Dutch Design artifact as more than a simple object and as in essence being a 'reality machine'—a self-reflexive device, fabricating narratives that reflect on its own artificiality and conditions of production—has become a permanent fixture in the Dutch Design discourse. It is better known under the term conceptual design.

We can understand the materiality of *Autarchy* as being structured as a reality machine, where its constituent parts work together to reveal different facets of the conditions of production of its vessels. As such, *Autarchy* perfectly lends itself to be interpreted as a form of Dutch Design. What I would like to explore next is precisely the role of materiality in the process through which the project—and its designers—were construed as Dutch Design and Dutch designers.

The construction of *Autarchy* as Dutch Design

Trimarchi and Farresin met in 2004 during their BA studies in communication and product design at the Higher Institute for Artistic Industries (ISIA) in Florence. Around 2005-2006, they started collaborating on limited edition multidisciplinary projects including graphics, product, performance, photography and video. After finishing their BA, in 2007 the duo moved to the Netherlands to follow the two-year Master of Design IM: Conceptual Design in Context at the Design Academy Eindhoven (DAE).

During their studies, the company Droog Design included some of the duo's design projects in its collection. In September of that same year the designers formally registered their studio in Eindhoven, where they have been living and working ever since. In October they launched *Baked*, precursor to *Autarchy*, which was presented the following year in April during Milan Design Week.

Since the beginning of their career, Formafantasma's work found much more resonance abroad than in the Netherlands. Although the international press often described them as 'Italian', it frequently qualified this national label by adding that the duo was based in the Netherlands and/or had trained at DAE (e.g. Abu Dhabi Art, 2010; Elle Decoration South Africa, 2010; Ligos and Morro, 2010; Lille, 2010; Lodz Design Festival, 2010; Spencer, 2010; Traldi, 2010). In comparison, and presumably because the duo are not Dutch by nationality, initially Formafantasma received little attention from the Dutch design institutions and press. At first, when *Design.nl*—the government-subsidised main news portal for Dutch Design—reported on their work, it did so in the context of the by-then already thoroughly internationalized Droog Design, but not as examples of Dutch Design (e.g. 2008; 2009a; 2009b; 2009c; 2009d). When the Dutch press did feature their work apart from Droog, the articles clearly positioned them as Italian designers (e.g. Edelkoort, 2010). The title of a *Design.nl* article reviewing Formafantasma's first pieces (both of which were produced and exhibited in the Netherlands) is revealing in this respect: 'Moulding Tradition and Baked

from Italy' (Dominy, 2009). Consequently, 'despite their work being exhibited extensively internationally', it has until recently 'rarely seen in the Netherlands' (Tan, 2014).

The incorporation of Formafantasma in the canonical Dutch Design discourse is, however, gradually changing. In 2012 the Vitra Design Museum Gallery held the exhibition *Confrontations: Contemporary Dutch Design*, which featured only six designers from the Netherlands—and among whom Formafantasma. The curator, Amelie Znidaric selected them because 'they do really ground breaking work in terms of material' (2013), which, the exhibition catalogue proposes, is a typical feature of Dutch Design: '[i]n a globalized world, it is not easy to find distinct national design identities. For Dutch design, however, this is not the case. Just like the oeuvre of the modernist designer and architect Gerrit Rietveld, contemporary Dutch design shows a relentless drive to experiment, an openness toward all types of materials and a formal language that derives from both. Then and today, we find [...] assemblage, recycling, reuse, do-it-yourself, and open design. Dutch designers are makers' (Vitra Design Museum, 2012, p. 2).

That same year, the Stedelijk Museum 's-Hertogenbosch (SM), which holds one of the Netherlands' key collections of Dutch jewelry and ceramics, acquired *Autarchy* (Tan, 2014). As SM's curator Fredric Baas explains, '[f]or some time now, we've taken a keen interest in design that goes beyond 'mere' product design. Formafantasma is, for me, definitely part of this development which includes critical or conceptual design; design that engages with people, society and today's pressing issues' (Baas quoted in Tan, 2014). Indeed, the museum understands Formafantasma's 'handmade utensils' such as their 'flour tableware' as 'statements about materiality and functionality' (Stedelijk Museum 's-Hertogenbosch, 2014). As Baas explains, the acquisition of *Autarchy* was the 'starting point' for developing *Prima Materia*, a retrospective exhibition on Formafantasma (their first solo in the Netherlands) that opened in February 2014 (Tan, 2014). The latest in the museum's series of exhibitions on renowned designers that previously featured Wieki Somers (2009), Maarten Baas (2010) and Scholten and Baijings (2011), *Prima Materia* unambiguously positions Formafantasma among the Dutch masters. The title of the exhibition, which was proposed by Baas, clearly situates the importance of materiality in this discursive construction of Formafantasma as Dutch designers: *Prima Materia* refers to alchemy's quest to transform raw materials into precious goods. By this, the museum suggests that 'Andrea Trimarchi and Simone Farresin do something similar as designers. An extensive research and work process results in

products and installations that raise questions about the role of industry, globalisation and sustainability' (Sellers, 2014).

These examples show that the quality of the materiality of their work was instrumental in the construction of Formafantasma as Dutch designers. By this, I do not mean to say that *Autarchy* has intrinsic elements that naturally make it Dutch Design, but rather that its material composition lends itself to be interpreted as an example of narrative, conceptual, self-reflexive design which itself is considered to be a defining characteristic of Dutch Design. As such, what I would like to suggest is that the materiality of *Autarchy* participates in the process of it being constructed as Dutch Design.

Beyond the time-space of the nation

However, if *Autarchy's* material composition allows it to be construed as Dutch Design, a so-called empirical examination of the project's material construction shows that it mobilizes foreign geographies, temporalities, techniques, traditions and concerns that literally exceed and cannot be reduced to the interpretative framework of Dutch cultural heritage on which the Dutch Design discourse is based.

'*Autarchy* is an improvement of *Baked*', Formafantasma's first project as a professional design studio, explains Farresin (2011). Upon graduating, the designers were invited to participate in the exhibition *Getting Lost* to be held during Dutch Design Week (DDW) in Eindhoven in October 2009 (Farresin, 2011). DDW is the most cosmopolitan of design events in the Netherlands, drawing influential actors from the international art-design world (e.g. curators, gallerists, journalists). Moreover, the other exhibitors were upcoming designers, bound to attract their international networks. The opportunity to create a new project and show it at *Getting Lost* was not one to pass up for the two aspiring young designers.

When they returned from summer holidays, the circumstances for designing a new project were not ideal: there were only a few weeks left before the opening, they did not have a studio/workshop space in which to work, nor the financial means to hire external expert or technical know-how. As such, Formafantasma had to improvise with what they had, what they knew, and what they could afford.

During their last trip to Sicily, they had visited the Giuseppe Pitre Ethnographic Museum in Palermo where they had seen images of the Feast of Saint Joseph, a medieval religious feast from the Sicilian town of Salemi in which the local women bake bread to use as decoration for the procession. The simplicity, intimacy and directness of these pieces had immediately

appealed to them as a starting point for a design project. Back in Eindhoven, it turned out to be the perfect candidate.

Already owning the only piece of electronic equipment required—the mini-oven in their little apartment—the designers started making try outs of the flour-salt-water paste at home (figure 2).



Figure 2 Mini-oven. Source: Andrea Trimarchi.

Searching for recipes online, Formafantasma experimented daily with different compositions, making dyes by boiling vegetables and spices on their stovetop, pressing the dough in off-the-shelf plaster molds, and baking the tests in their mini-oven. When DAE opened again in mid-September, the duo had access to the plaster workshop, so they started experimenting with pressing the dough into their own custom-made plaster molds and drying

JOANA OZORIO DE ALMEIDA MEROZ

them in the school's ceramic kilns. The dough remained difficult to work with and cracked regularly while drying (figure 3).



Figure 3 Cracked try-outs for Baked. Source: Formafantasma.

However, time was running out, so Formafantasma switched from perfecting the pieces' material properties to their visual quality. To give the raw objects a finished look, Trimarchi and Farresin used elastic straps to fasten bakery products to the vessels: 'The products are unglazed, and we feel that the band works to 'finish' the object', says Farresin. 'It adds an element that makes the object work better on a visual level, and it also makes it feel more stable, less fragile' (quoted in Spencer, 2010, p. 33) (figures 4 and 5). The straps also literally reinforced the association between the vessels and bread and as such also between the project and its origins in Salemi's medieval bread craft.



Figure 4 Baked. Source: Formafantasma.



Figure 5 Baked. Source: Formafantasma.

This was essential, particularly because *Baked*, as the project came to be called, would be exhibited in a standard cabinet that would not add any information about the story behind the project. Indeed, left to their own devices, the vessels simply looked like unglazed terracotta.

As such, turning the pieces into self-referential multi-media assemblages (flour vessels + belts + flour foods) was a means to communicate the pieces' condition of production via the pieces themselves, independent of the exhibition context. At the same time, precisely by emphasizing the connection between the vessels and the bread, and between *Baked* and Salemi's folklore, the belts also highlighted the difference between them: although *Baked* had been inspired by this tradition it was not a continuation of it but a comment on it. The belt-plus-bakery décor thus took *Baked* 'one step away from the unreflective repetition of those Sicilian folk crafts' (Edelkoort, 2010, p. 103) and one step closer to the tradition of Dutch Design and its narrative, self-referential, multi-media assemblages.

Upon visiting the show, Rossana Orlandi—who the *Financial Times* describes as 'one of the design world's most influential patrons' (Dalton, 2011) and whose gallery, according to the *Wall Street Journal* is a 'fixture during the annual Salone del Mobile design week in Milan' (Cooperman, 2011)—asked to exhibit *Baked* the following week in her gallery in Milan (Dominy, 2009) (figure 6 and 7). She also commissioned Formafantasma to create a new design to be shown at her gallery during the International Furniture Fair of Milan in May 2010 (Farresin, 2011). Formafantasma, it goes without saying, was glad to oblige (Dominy, 2009). They were not able, however, to show her what they would be exhibiting during the Milan Design Week, as she had requested, for the simple reason that the pieces did not exist yet (Farresin, 2011). Instead, the duo sent Orlandi a mood-book that showed the atmosphere of the future pieces as well as the setting in which they would be exhibited.



Figure 6-7 *Baked* exhibited at *Getting Lost*. Source: *Formafantasma*.

The mood-book (Formafantasma, 2010) reveals the cross-cultural and uncontemporaneous character of the references based on which Formafantasma developed *Autarchy*. While Salemi's medieval bread craft remained the starting point for the material, technical and aesthetic development of the vessels, Formafantasma now wished to take the project beyond a material exploration as had largely been the case with *Baked* (Ligos and Morro, 2010, p. 23), and emphasize the utopian narrative concerning the harmonious relation between nature and culture instead. Moreover, exhibiting at Orlandi provided the opportunity to create an exhibition setting to contextualize the pieces. Seeking a timeless rural atmosphere with which to communicate this story, the designers turned to the 18th century Shakers: 'Autarky [*sic*] pays homage the uncomplicated, the simple and the daily aesthetic and functionality of the domestic environment in rural shakers community. [...] The shaker manner of hanging the domestic tools on the wall is used both to desiccate[...] and display the vessels and the lamps which are or naturally dried or low temperature baked' (Formafantasma, 2010, pp. 3-5). Thus, the exhibition's display furniture—the drying ovens, the flourmill, the wooden tables, drying cabinet, bread, straw brooms—took shape as a translation of 18th century

Shaker material culture. As with *Baked*, bakery products were introduced in order to clarify the material and cultural origins of the vessels. However, given that these could be part of the scenography contextualizing the objects, it was no longer necessary to have them attached to the vessels themselves. Orlandi approved of the plan.

In November 2009 Formafantasma moved their studio into the building of a discontinued hospice along with ten other young Dutch designers, and in January 2010 started working on the project. Given that the designers were financing the project with their parents' resources, while there were improvements in the material (particularly as concerns durability) no significant investment was made in substantially changing the production process. Formafantasma produced the vessels in their studio, the display furniture was made according to their specifications by a carpenter in Eindhoven, the renowned French bakery Poilâne sponsored the project by providing loaves of rustic and decorated bread, and the straw brooms were handcrafted by Giuseppe Brunello, situated in the North of Italy (figure 8).

In sum, the demand for *Autarchy* came from Milan, the finances from Taormina and Veneto, the production process from a combination of medieval Sicilian folk craft and the online community, the aesthetics and concerns from the 18th century North American Shakers, the bread from France, and the brooms from Northern Italy. Thus, while grounded in the material culture of the Netherlands, the exploration of the project's material construction reveals that *Autarchy's* contexts extend well beyond the 'conventional culture-object space' of the nation (Pinney, 2005, p. 269). As such, although a form of Dutch Design, *Autarchy* also transcends the explanatory framework of national culture and history at the basis of culturalist approaches to Dutch Design.



Figure 8 *Autarchy* vessels in the context of Poilâne's bread loaves and Brunello's brooms. Source: Formafantasma.

Conclusion: Reconfiguring Dutchness

Elsewhere I have argued that global market forces can contribute to fostering cultural diversity in Dutch Design (Ozorio de Almeida Meroz, forthcoming). There, my concern was to examine the role of Dutch Design's increasingly transnational contexts in challenging its conservative nationalist discourse and practices. Here I sought to shift the focus from contexts to how artifacts construct the Dutchness and contexts of Dutch Design instead.

The description of the social and material construction of *Autarchy* shows how in the process of it being construed as Dutch Design it in turn has reconfigured both Dutch identity and the Dutch context. On the one hand, the materiality of *Autarchy* lends itself to be interpreted according to the dominant culturalist discourse in which Dutch Design artifacts are a reflection of a statically defined Dutch national culture. This has contributed to its—and Formafantasma's—gradual inclusion in the Dutch Design canon despite their Italian nationality. On the other hand, the investigation into the installation's material construction reveals that, while grounded in the Netherlands, *Autarchy* also transcends and thus cannot be grasped in terms of the time-space of the nation. Hence, if *Autarchy* is Dutch Design, then it

literally reconfigures Dutchness and reassembles the context of the nation according to its own design.

We may understand the materiality of *Autarchy* in terms of what Thomas has called a 'doubleness' (1999, p. 18), meaning that it is both mixed up with the material culture of the Netherlands and that, at the same time, it deviates from it. The doubleness of *Autarchy* also requires an adjustment in the predominantly culturalist interpretative framework of Dutch Design. To do this, Thomas' proposition to examine artifacts 'not just [as] expressions of a new context, but [as] technologies that created that context anew' (1999, p. 18) is useful. Describing the social and material construction of *Autarchy* has entailed *both* engaging with the history of Dutch Design *and* following the project as it moves beyond it and in so doing, reconfigures the boundaries in time and space of that history. Such a perspective, which takes us beyond either affirming Dutch Design as real or debunking it as a discursive construction, may be of use to national design historiography more generally as it grapples with the enduring doubleness of design in times of globalization.

Acknowledgement

This research is financed by the Netherlands Organisation for Scientific Research (NWO). I wish to thank Andrea Trimarchi and Simone Farresin for their patience and generosity throughout the process of this research.

References

- Abu Dhabi Art. (2010) *Studio Formafantasma*. 2010 Abu Dhabi Art Fair.
- Akrich, M. (1992) *The De-Description of Technical Objects*. In Bijker, W.E. and Law, J. (eds.), *Shaping Technology/Building Society: Studies in Sociotechnical Change*. Cambridge: MIT Press.
- Akrich, M. and Latour, B. (1992) *A Summary of a Convenient Vocabulary for the Semiotics of Human and Nonhuman Assemblies*. In Bijker, W.E. and Law, J. (eds.), *Shaping Technology/Building Society: Studies in Sociotechnical Change*. Cambridge: MIT Press.
- Appadurai, A. (eds.) (1986) *The Social Life of Things: Commodities in Cultural Perspective*. Cambridge: Cambridge University Press.
- Atelier, N.L. (2011) *The Clay Machine*. [Online]. Available from: <http://www.ateliernl.com/the-clay-machine-2008> [Accessed: 18th May 2014].
- Betsky, A. (2004) *False Flat: Why Dutch Design Is So Good*. London: Phaidon.

- Betsky, A. (2003) *Reality Machines: De kunstmatige afspiegeling van de werkelijkheid*. In Vlassenrood, L. (eds.), *Reality Machines: Het alledaagse weerspiegeld in hedendaagse Nederlandse architectuur, fotografie en vormgeving*. NAI: Rotterdam.
- Cooperman, J. (2011) *Rossana Orlandi, la Donna di Mobili*. [Online]. Available from: <http://online.wsj.com/news/articles/SB10001424053111904194604576580682164729092> [Accessed: 18th May 2014].
- Dalton, J. (2011) *Rossana in Excelsis*. [Online]. Available from: <http://howtospendit.ft.com/furniture/5739-rossana-in-excelsis>. [Accessed: 18th May 2014].
- Design.nl. (2008) *Salone del Mobile 08: Droog*. [Online]. Available from: http://www.design.nl/item/salone_del_mobile_08_droog [Accessed: 18th May 2014].
- Design.nl. (2009a) *Droog in Milan 2009*. [Online]. Available from: http://www.design.nl/item/droog_in_milan_2009?searchField=Droog%20in%20Milan%202009 [Accessed: 18th May 2014].
- Design.nl. (2009b) *Design Events Move to New York*. [Online]. Available from: http://www.design.nl/item/design_events_move_to_new_york?searchField=Design%20events%20move%20to%20New%20York [Accessed: 18th May 2014].
- Design.nl. (2009c) *Is Dutch Design Slowing Down?* [Online]. Available from: http://www.design.nl/item/is_dutch_design_slowing_down?searchField=Is%20Dutch%20design%20slowing%20down [Accessed: 18th May 2014].
- Design.nl. (2009d) *Design Miami/2009*. [Online]. Available from: http://www.design.nl/item/design_miami_2009?searchField=Design%20Miami/%202009 [Accessed: 18th May 2014].
- Design.nl. (2011) *Rolling Stone's Top 20 Designers*. [Online]. Available from: http://www.design.nl/item/rolling_stones_top_20_designers?searchField=formafantasma [Accessed: 18th May 2014].
- Dominy, K. (2009) *Moulding Tradition and Baked from Italy*. [Online]. Available from: http://www.design.nl/item/moulding_tradition_and_baked_from_italy?searchField=Formafantasma [Accessed: 18th May 2014].
- Edelkoort, L. (2010) Baked. *Bloom*. January, 100-105.
- Elle Decoration South Africa (2010) Folk Tale. *Elle Decoration South Africa*, November, 44-45.
- Farresin, S. (2011) [Interview]. 4th March 2011.

- Formafantasma (2014) *Autarchy*. [Online]. Available from:
<http://www.formafantasma.com/autarchy> [Accessed: 18th May 2014].
- Formafantasma (2010) *Autarky*. Unpublished.
- Geels, M. and Davies, P. (eds.) (2000) *Droog and Dutch Design*. Utrecht: Centraal Museum.
- Hekman, S. (2009) We Have Never Been Postmodern: Latour, Foucault and the Material of Knowledge. *Contemporary Political Theory*, 8 (4), 435-454.
- Joyce, P. and Bennett, T. (2010) *Material Powers: Introduction*. In Bennett, T. and Joyce, P. (eds.), *Material Powers: Cultural Studies, History and the Material Turn*. London: Routledge.
- Junte, J. (2011) *Hands On: Dutch Design in the 21st Century*. Amsterdam: W Books.
- Kennedy, G. (2011) *Why Italians Can (Sometimes) Be Dutch*. [Online]. Available from:
http://www.design.nl/item/why_italians_can_sometimes_be_dutch?searchField=formafantasma [Accessed: 18th May 2014].
- Latour, B. (1992) *Where Are the Missing Masses? The Sociology of a Few Mundane Artifacts*. In Bijker, W.E. and Law, J. (eds.), *Shaping Technology/Building Society: Studies in Sociotechnical Change*. Cambridge: MIT Press.
- Ligos, M. and Morro, M. (2010) Formafantasma. *Pasajes Diseño*, August, 20-25.
- Lille, E. de. (2010) Studio Formafantasma. *l'Uomo Vogue*, August, 150-151.
- Lodz Design Festival. (2010) Exhibition Catalogue, Lodz 2010.
- Ozorio de Almeida Meroz, J. (forthcoming) *Negotiating Confrontations: Cultural Diversity in Dutch Design*. Paper Presented at the Proceedings of Annual Conference Towards Global Histories of Design: Postcolonial Perspectives. September 2012, Ahmedabad.
- Pinney, C. (2005) *Things Happen: Or, From Which Moment Does That Object Come?* In Miller, D. (eds.) *Materiality*. Durham: Duke University Press.
- Ramakers, R. and Bakker, G. (eds.) (1998) *Droog Design: Spirit of the Nineties*. Rotterdam: 010.
- Reckwitz, A. (2002) The Status of the 'Material' in Theories of Culture: From 'Social Structure' to 'Artefacts'. *Journal for the Theory of Social Behaviour*, 32 (2), 195-217.
- Sellers, L. (2014) *Stedelijk Museum Hosts 'Prima Materia'*. [Online]. Available from: <http://www.libbysellers.com/news/129/> [Accessed: 18th May 2014].
- Spencer, R. (2010) *Autarky*. *Icon*, August, 32-33.

- Tan, J. (2014) *Prima Materia by Formafantasma*. [Online]. Available from: http://www.design.nl/item/prima_materia_by_formafantasma [Accessed: 18th May 2014].
- Terreehorst, P. (2003) *Van kaal tot cool: De opmaars van het Nederlands ontwerp in de jaren negentig*. In Vlassenrood, L. (eds.), *Reality Machines: Het alledaagse weerspiegeld in hedendaagse Nederlandse architectuur, fotografie en vormgeving*. NAI: Rotterdam.
- Thomas, N. (1999) The Case of the Misplaced Ponchos: Speculations Concerning the History of Cloth in Polynesia. *Journal of Material Culture*, 4 (5), 5-20.
- Traldi, L. (2010) Design Double Face. *Interni*, February, 96-97.
- Vitra Design Museum. (2012) *Confrontations: Contemporary Dutch Design*. Published on the occasion of the exhibition at the Vitra Design Museum Gallery, Weil am Rhein, 12 June – 2 September 2012. Weil am Rhein [?]: Vitra Design Museum.
- Yaneva, A. (2009) Making the Social Hold: Towards an Actor-Network Theory of Design. *Design and Culture*, 1 (3), 273-288.
- Znidaric, A. (2013) [Interview]. 27th August 2013.



Interferenze digitali. Un'estetica delle pratiche digitali a supporto del discorso di design

Elisa BERTELOTTI, Federica D'URZO and Francesca PIREDDA*
Politecnico di Milano

'Desis in The Mirror' è un progetto di ricerca nato nell'estate del 2013 per riflettere sulle pratiche di produzione audiovisiva realizzate dai membri del DESIS Network¹, quasi tutti non film maker. Le esperienze dei membri del DESIS Lab sono state messe in relazione con altre raccolte di video-interviste a film maker e artisti che, da prospettive e formazioni diverse, raccontano progetti legati all'innovazione sociale e alla sostenibilità. Il progetto rappresenta, dunque, un processo di riflessione sulle pratiche del design che includono artefatti multimediali digitali. La piattaforma digitale utilizzata per i collegamenti e le registrazioni ha facilitato e reso possibile video interviste impossibili da realizzare in presenza, ma ha comportato altri limiti connessi alla tecnologia stessa, introducendo elementi fortemente connotanti quali disturbi sonori e rumori visivi, nonché il punto di vista unico della ripresa video da webcam. Dunque, un'estetica delle pratiche digitali fondata su una nuova materialità. Il progetto nato in seguito all'indagine è un format multimediale per la disseminazione della ricerca, rivolto sia ai membri del DESIS Network, sia a un pubblico più esteso di ricercatori. Partendo dalle registrazioni delle interviste vengono elaborati testi, immagini, brevi montaggi, video che moltiplicano le modalità di fruizione, fornendo percorsi di lettura via via differenti. Nella costruzione del format non si è solo tenuto conto della discontinuità e spesso cattiva qualità delle video-interviste: le interferenze della connessione digitale sono diventate cifra stilistica del progetto e spesso elementi di transizione, funzionali al montaggio dei contenuti.

Keywords: *Format; video; design*

* Corresponding author: **Francesca Piredda** | e-mail: francesca.piredda@polimi.it

¹ DESIS (Design for Social Innovation towards Sustainability) è un network di Laboratori di Design che si occupa attivamente nel supportare e promuovere il cambiamento sostenibile. <http://desis-network.org>.

Introduzione

L'accesso alle tecnologie digitali di produzione video e dell'immagine estende tali pratiche a coloro che non hanno competenze specifiche, né tecniche né di linguaggio, espandendo le aree e le possibilità di intervento del discorso audiovisivo nelle attività di ricerca e didattica. Prima, infatti, solo alcuni laboratori ed alcune discipline ne facevano utilizzo per osservare la società (cinema e documentazione etnografici per le scienze sociali) ed esplorare la materia del mondo nel tentativo di superare i limiti dell'universo conoscibile: tecniche come la cronofotografia consentivano lo studio del movimento e hanno favorito lo sviluppo di tecniche di ripresa che producevano immagini delle quali oggi apprezziamo anche il valore estetico.

Oggi, il mondo della ricerca il mondo accademico e i ricercatori acquisiscono una nuova consapevolezza del loro ruolo nella società e si aprono a nuovi modelli di condivisione delle informazioni. Comunicare la ricerca significa da una parte dividerne processi e risultati con la comunità scientifica, dall'altra uscire dai laboratori e dalle accademie per divulgarli nei confronti di un pubblico più o meno vasto. Canali e modi di comunicare coinvolgono spesso in prima persona i ricercatori stessi e le strategie di 'mediatizzazione' (Peters, 2012) impongono la visualizzazione di concetti astratti per consentire la comprensione dell'impatto e dell'utilità dei risultati nella vita quotidiana. Il linguaggio audiovisivo acquisisce un'importanza sempre maggiore poiché consente di veicolare la complessità, comunicare in modo immediato ed essere di universale comprensione.

La ricerca di design e i processi progettuali, in particolare, utilizzano sempre di più lo strumento audiovisivo quale mezzo di esplorazione del contesto di progetto e di visualizzazione e prefigurazione delle soluzioni possibili. Spesso, però, l'utilizzo del video è spontaneo ed i risultati prodotti dimostrano la necessità di un'alfabetizzazione al linguaggio audiovisivo in questo settore, così da farlo diventare uno strumento efficace in termini comunicativi e di ricerca. 'DESIS in the Mirror' è un progetto di ricerca che ha l'obiettivo di riflettere sull'utilizzo del racconto audiovisivo nell'ambito del design: un format multimediale a supporto del discorso di design e delle pratiche del progetto.

1. DESIS in the Mirror

DESIS Network (Design for Social Innovation towards Sustainability) è una rete internazionale di laboratori di design attivamente coinvolti nel

Interferenze digitali. Un'estetica delle pratiche digitali a supporto del discorso di design

promuovere e sostenere il cambiamento sostenibile. I laboratori coinvolti (DESIS Lab) si trovano all'interno di scuole di design in trentanove paesi del mondo e partecipano a diversi tipi progetti di design e di ricerca di carattere locale, regionale e globale e in attività di *networking*. La maggior parte dei DESIS Lab sono attivi nel campo del design dei servizi o del *Product Service System*. A parte pochi casi, quasi nessuno dei laboratori ha al cuore dei propri interessi di ricerca e delle proprie pratiche tematiche legate alla comunicazione né tantomeno alla produzione di artefatti audiovisivi.

Spinti dalla necessità di esplorare i temi legati alla produzione video il gruppo di ricerca Imagis (Dipartimento di Design, Politecnico di Milano) e DESIS Network hanno promosso un progetto di ricerca, 'DESIS in The Mirror', con l'obiettivo di analizzare le esperienze di produzione audiovisiva realizzate dai membri DESIS. 'Desis in The Mirror' vorrebbe servire come terreno di riflessione e discussione e contribuire, in un secondo tempo, alla progettazione di strumenti per facilitare iniziative in campo comunicativo di designer che si occupano di innovazione sociale.

A partire da Giugno 2013 sono state condotte diverse video-interviste sia ad alcuni dei membri dei DESIS Lab che negli anni si sono confrontati con la produzione di artefatti audiovisivi sia ad alcuni artisti e cineasti che hanno raccontato, attraverso il video, storie legate a innovazione sociale e sostenibilità. Agli intervistati è stato chiesto di raccontare la costruzione dei loro progetti audiovisivi (da un punto di vista produttivo, tecnico, di processo ed estetico) e le loro riflessioni più generali sul rapporto tra innovazione sociale, produzione di storie e video.

Le video interviste sono state realizzate con Skype, quasi sempre da almeno tre località in contemporanea: le intervistatrici in Italia, Colombia e Germania si sono collegate di volta in volta con Cina, Brasile, Francia, Stati Uniti, Corea, Regno Unito, Corea del Sud, Germania, Sud Africa, Belgio, Thailandia².

² Intervista per il progetto DESIS in the Mirror a Ivan Bursztyn (Rio de Janeiro, Brasile), condotta da Elisa Bertolotti e Andrea Mendoza - 08/07/13.



Figura 1 Immagini dalla videointervista a Chakrapipat Asswaboonyalert - DESIS Thailand - King Mongkut's University of Technology Thonburi, Bangkok (Thailand) con Elisa Bertolotti e Andrea Mendoza / 24-07-2013, h. 20.00 Bangkok (Tailandia) - 15.00 Milano - 08.00 Bogotà (Colombia). I problemi di connessione hanno obbligato, ad un certo punto dell'intervista, a escludere il collegamento con la Colombia.

I problemi di collegamento per le interviste video si sono rivelati estremamente frequenti. All'inizio delle chiamate le intervistatrici provavano a tenere tutti i collegamenti video aperti per facilitare la conversazione con gli intervistati. Spesso però sono state obbligate a spegnere le proprie finestre video, rimanendo per gli intervistati solo voci lontane su schermo nero. In molti altri casi sono state costrette a chiudere le chiamate per pochi secondi, o addirittura riavviare il computer, interrompendo il flusso del discorso.



Figura 2 Immagini dalla videointervista a Joon Sang Baek (DESIS @UNIST- Ulsan National Institute of Science and Technology) con Elisa Bertolotti e Andrea Mendoza / 18-07-2013 // h. 23.00 Ulsan (Corea) - h.16.00 Milano / h. 9.00 Bogotà (Colombia). In alcuni momenti dell'intervista è stato necessario eliminare la finestra video delle intervistatrici per non appesantire

Interferenze digitali. Un'estetica delle pratiche digitali a supporto del discorso di design eccessivamente il collegamento. L'intervista video ha permesso a Joon Sang Baek di presentare uno dei suoi collaboratori e mostrare alcuni strumenti usati nella produzione dei suoi film, tra cui i suoi storyboard.

I problemi e le discontinuità dei collegamenti si ritrovano di conseguenza anche nelle registrazioni video delle interviste e nelle successive trascrizioni, che tengono memoria insieme delle difficoltà tecniche e della disponibilità da parte degli intervistati ad aspettare e trovare strategie per permettere di concludere nel modo migliore possibile le interviste. Il carattere intermittente del materiale registrato e i problemi tecnici nella registrazione audio e video sono diventati elementi fondamentali con cui confrontarsi. Ecco che le riflessioni della comunità DESIS hanno posto le basi per la realizzazione di un format audiovisivo in grado di analizzare e disseminare, allo stesso tempo, il materiale raccolto durante l'indagine.

2. Un format per il discorso della ricerca

Il primo passo per l'elaborazione del format è stato stabilire quale fosse il modo più appropriato per raccontare i punti di vista, le esperienze dei ricercatori e le modalità tramite le quali la ricerca in questione era avvenuta.

Tale tipo di racconto era riproducibile utilizzando la voce stessa degli intervistati: le registrazioni effettuate durante le videointerviste sono diventate la materia prima per la creazione di materiale audiovisivo. Questa scelta però ha portato con sé delle problematiche.

La prima è stata la lunghezza dei filmati: ogni intervista durava circa due ore, per un totale complessivo di ventisei ore di video. Ripresentare i contenuti senza una limatura era sconsigliabile, poiché avrebbero perso chiarezza. La necessità iniziale è stata riorganizzare gli argomenti in maniera tale da renderli sintetici ed efficaci. Ogni videointervista è stata analizzata tramite le trascrizioni, il materiale utile isolato e a sua volta diviso secondo due criteri: il primo, concentrato sulle tematiche, era volto a creare un percorso trasversale sintetico raggruppante le singole testimonianze degli intervistati, ripresentate poi sotto forma di dialogo; il secondo, ordinato per autore, riportava la testimonianza diretta dell'intervistato, dandogli uno spazio maggiore e permettendo un approfondimento di tutti i temi affrontati. Entrambi i racconti sono stati creati partendo da un collage di frasi ricavato dalle trascrizioni delle interviste (figure 3), tradotto poi in montaggio video.

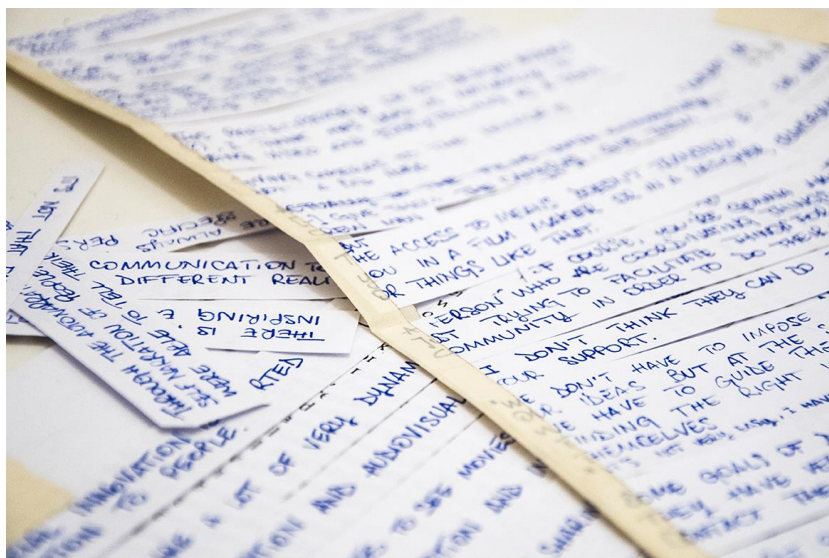


Figura 3 Collage di frasi ricavato dalle trascrizioni delle interviste.

Ogni inquadratura, realizzata tramite il punto di vista unico della webcam, era già fisicamente divisa in due piani affiancati: un piano del racconto — quello dell'intervistato — e un piano dell'ascolto — quello dell'intervistatore, co-protagonista molto spesso silenzioso della narrazione.

Questa divisione dello schermo imposta dallo strumento ha regalato due livelli d'informazione: il primo legato alle parole dell'intervistato, il secondo legato a un lato più umano, quello degli intervistatori intenti a giocare con degli oggetti, a prendere appunti, a stropicciarsi gli occhi affaticati dallo schermo.

Risolto il problema dell'organizzazione dei contenuti, vi era una seconda questione di cui occuparsi: la qualità delle registrazioni. Se da un lato l'utilizzo di Skype aveva consentito di mettere in contatto persone e luoghi lontanissimi fra loro, dall'altro aveva portato con sé una traccia evidente della sua presenza, resa visibile da fotogrammi bloccati, sgranature delle immagini, audio accompagnato dal suono delle ventole dei computer, che giravano e *sbuffavano* affaticate.

Migliorare la qualità del materiale era impossibile, poiché le interferenze erano eccessive. Allo stesso tempo, non utilizzare tale materiale equivaleva a omettere una parte del racconto. Se quindi il materiale non poteva essere

Interferenze digitali. Un'estetica delle pratiche digitali a supporto del discorso di design

né reso qualitativamente migliore, per limitazioni tecniche, né tanto meno non utilizzato, le scelte rimanenti sembravano poche: ignorare la presenza di tali limitazioni, oppure al contrario, esaltarla.

Secondo il principio di Shannon e Weaver (1949) la comunicazione può essere descritta come un passaggio d'informazioni che avviene tra mittente e destinatario, tramite un trasmettitore e un ricevitore in grado di convogliare e ritradurre il messaggio attraverso un canale. Nel momento in cui la comunicazione avviene, però, si incappa in un altro elemento, ineliminabile: il *rumore*, immanente alla comunicazione. Questa teoria, elaborata in vista dell'annullamento dell'incertezza e imprevedibilità del *rumore*, ricalca l'approccio moderno alla tecnologia, ovvero la tendenza ad annullare la presenza del mezzo, rendendolo *trasparente*.

In opposizione a quest'approccio, si colloca la *glitch art*, l'arte dell'*errore*. La base sulla quale questo movimento artistico si sviluppa, a partire soprattutto dagli anni zero, è l'esaltazione della presenza del *rumore* tramite la creazione di immagini i cui codici sono modificati in maniera casuale.

Come dice Rosa Menkman (2011), autrice del Manifesto del movimento artistico, sperimentare sulla propria pelle un *glitch* è come guardare un bellissimo, coloratissimo e complesso paesaggio d'immagini e strutture di dati inspiegabili, misteriose e ultraterrene.

Il *rumore* di cui parlava Shannon era ciò che nelle videointerviste si traduceva in immagini rovinata e audio intermittente; la *glitch art* era uno dei riferimenti che poteva servire da ispirazione per la produzione del materiale audiovisivo. Da queste premesse, l'interferenza è stata rielaborata graficamente e ritradotta in rettangoli di forme e colori diversi, a tinta piatta, in movimento frenetico sullo schermo, che si andavano a sovrapporre alle immagini, nascondendone la qualità tramite l'esasperazione dell'interferenza.

Utilizzare un *rumore* volutamente *finto* è servito a mettere ancora più in evidenza la presenza del limite tecnologico: i rettangoli colorati rappresentavano la traccia del mezzo, raccontavano il suo punto di vista.

Essi erano la sua firma, il segno della sua presenza estrapolato, rielaborato e reso protagonista. Portare l'interferenza alla luce ha contribuito, inoltre, a raccontare un lato della ricerca più nascosto: le difficoltà tecniche, derivanti anche dalla grande distanza tra i dialoganti.

Il *rumore* è stato ripreso anche a livello audio, soprattutto nella sigla di apertura, dove a un suono costante d'interferenza elettromagnetica sono stati abbinati *bip* digitali, suoni di modem in collegamento, voci sovrapposte l'una all'altra.

L'identità del format è stata sviluppata in relazione alla rielaborazione grafica dell'interferenza. È stato progettato un logo (figure 4), in linea con l'immagine del Network DESIS, che rimanda al concetto metaforico di specchio ed elementi come la sigla e i titoli di coda, il cui scopo era quello di, rispettivamente, introdurre il lavoro di ricerca svolto e riportare i crediti dell'intero progetto. Il montato è stato, inoltre, arricchito di un ulteriore livello di informazione testuale, fornita da sottotitoli e sottopancia riportanti i dati degli intervistati.

Gli output finali sono stati caricati online e sono consultabili al sito <http://desisinthemirror.imagishub.it/>.



Figure 4 Logo di DESIS in the Mirror.

L'utilizzo delle videoregistrazioni, con le limitazioni qualitative derivanti, ha fatto sì che si creasse in maniera quasi naturale un livello di racconto *digitale*: la presenza del mezzo tecnologico è stata esasperata e, riprendendo i canoni estetici della *glitch art*, l'errore digitale è diventato cifra stilistica del format e filo conduttore secondario della narrazione.

3. Discussione

Come emerge dalle interviste condotte, il bisogno di comunicare ha portato molti dei laboratori a produrre video, usandoli come strumenti per documentare, studiare, visualizzare i progetti, promuovere il dialogo, condividere e amplificare idee:

*'Design is something [where] interaction happens in time, everything that happen in time is very coherent with the logic of the movie and so immediately we thought that to represent these kind of services it could be very useful to have short movies.'*³

Le esperienze di produzione dei video da parte dei DESIS Lab vengono da necessità comunicative differenti e si confrontano poi con le possibilità produttive, competenze a disposizione e contesti specifici. Nell'esperienza dei designer che abbiamo intervistato per questa ricerca, il facile accesso alla produzione audiovisiva digitale pone il problema di misurarsi con l'occasionalità del proprio lavoro nel campo del video:

*'The access to means doesn't transform you in a film maker [...] There are more elements in the process, like education, negotiation, ethical values, knowledge, respect for what you're doing [...] So, there are the means, how I'm gonna use them now?'*⁴

Il fatto di avere a disposizione i mezzi sembra non risolvere automaticamente la questione di come usarli, sia da un punto di vista di gestione tecnica e di processo che da un punto di vista estetico:

*'I have to admit so far we have been driven more by passion and zeal, rather than by knowledge. Now the next step will be to say: we have a good story, but we need some technical input to make that storytelling effective. So I will definitely go to continue to be involved in this field, but I'm going to need a lot of support from people with the technical skills of good documentation in video and films space.'*⁵

3 Intervista per il progetto DESIS in the Mirror a Ezio Manzini condotta da Francesca Piredda e Andrea Mendoza - 11/07/2013.

4 Intervista per il progetto DESIS in the Mirror a Andrés Burbano Valdez (Bogotà, Colombia) condotta da Elisa Bertolotti e Andrea Mendoza - 18-07-2013.

5 Intervista per il progetto DESIS in the Mirror a Mugendi M'Rithaa (Cape Town, Sud Africa) condotta da Elisa Bertolotti e Andrea Mendoza- 26-07-2013 & 08-08.

'DESIS in the Mirror' vuole dunque essere un contributo alla ricerca in design, proponendo un format che possa allo stesso tempo registrare e rendere disponibili delle riflessioni in corso, dando evidenza del processo riflessivo stesso attraverso il montaggio di frammenti intesi come citazioni, nodi da evidenziare e da attivare costruendo connessioni. Contributi eterogenei sono tenuti insieme dall'interfaccia di registrazione da una parte, dalla post-produzione video dall'altra: prima lo split screen con cui vengono condotte le interviste reifica la distanza spazio-temporale e la condensa in un unico momento, nella visione sinottica del primo piano dell'intervistato che parla e del piano d'ascolto del ricercatore distratto, assorto, divertito, corrugato. Poi il montaggio mette in sequenza i frammenti, mentre la motion graphic conferisce materialità al collegamento web stesso, esasperandone le interferenze con l'aggiunta di un livello ulteriore. Entrambe le immagini ottenute dalle fasi di registrazione e post-produzione corrispondono a quella che Manovich (2001) definisce l' 'estetica della composizione', ovvero la dimensione spaziale dell'immagine, che produce senso all'interno della cornice stessa dell'inquadratura attraverso la relazione fra gli strati che la compongono.

Introdurre il livello ulteriore dell'animazione, conferisce al format un'identità dinamica che consente di rendere i contenuti immediatamente riconoscibili nel canale web e maggiormente fruibili, dal momento che gli interventi di compositing consentono di guidare l'attenzione in assenza di una regia vera e propria in fase di registrazione: nessun movimento di camera, ridotta possibilità di comporre l'inquadratura, impostazione automatica del layout dello split screen.

' We know the importance of the beauty in a movie like that. ... it was not only to record an audio or a video. It's more than that, we need to have a nice video, a nice photography, we have to improve the light and where to put the cameras, the frames and everything... It's easier to tell the message, the message becomes more important because of that. It's really, like, you can keep the attention of the audience better if you have a good quality movie than a draft one'.⁶

6 Intervista per il progetto DESIS in the Mirror a Ivan Bursztyn (Rio de Janeiro, Brasile), condotta da Elisa Bertolotti e Andrea Mendoza - 08/07/13.

Interferenze digitali. Un'estetica delle pratiche digitali a supporto del discorso di design

Il processo stesso di generazione dei contenuti (l'intervista registrata) diventa protagonista della comunicazione, viene dichiarato con forza il carattere estetico dell'esperienza raccontata e contemporaneamente del racconto stesso nel suo prodursi. La registrazione documenta il processo di ricerca, tenendo traccia anche di una dimensione qualitativa del fare ricerca: i tempi e gli ambienti, seppur in secondo piano, emergono fortemente a connotare l'attività stessa.

*'I think the main idea of what we did is to dialogue, to put people in contact, to promote dialogue. That's a way to have mutual learning. The idea is not to teach someone an experience of the other, it's only to have a communication arena where they can exchange experiences and we, in the university, are only a way to have this, we are only a communication tool'*⁷

I brevi video editati e distribuiti online sono destinati alla comunità scientifica, offrendo occasioni di dialogo anche interdisciplinare intorno al tema di indagine. Finora sono stati utilizzati, infatti, in occasione di conferenze internazionali, presentazioni e tavole rotonde⁸ contribuendo a precisare nodi problematici e favorendo la discussione fra pari.

*'You can do a good movie self-standing but usually these movies that are not so good, you can use in a not-self-standing way. You can use them as one of the tools, the communication tools, and you can have others like the platform or like a talk, interview, when you present an idea, you tell a story and then you use the short movie only to have a situation example or something like that'*⁹

7 Intervista per il progetto DESIS in the Mirror a Ivan Bursztyn (Rio de Janeiro, Brasile), condotta da Elisa Bertolotti e Andrea Mendoza - 08/07/13.

8 Tra le diverse occasioni in cui è stato presentato il format si segnalano:

- E. Bertolotti, A. Mendoza, F. Piredda, *Stories on social innovation. Filmmakers and Designers on a dialogue around the moving image practice* - Community Filmmaking and Cultural Diversity: Policy, Innovation and practice BFI Southbank, London, UK www.communityfilmmaking.com; - *Narrations and communities: building communities for making citizenship*, INSITE Workshop, 11th-15th April 2014 – c/o Officina Emilia, Modena – Italy - <http://www.insiteproject.org/>.

9 Intervista per il progetto DESIS in the Mirror a Ivan Bursztyn (Rio de Janeiro, Brasile), condotta da Elisa Bertolotti e Andrea Mendoza - 08/07/13.

La cultura del design trova un'ulteriore forma espressiva capace di mettere in relazione le esperienze e dare forma visibile al progetto, quale processo produttivo e di conoscenza.

Partendo dall'idea di evidenziare, anziché nascondere, la presenza del medium, l'immagine viene rovinata ancor di più, elaborando graficamente un codice estetico in netta contrapposizione con il 'finto' disturbo analogico. Le sgranature, le interferenze audio, i fotogrammi *paralizzati* rivendicano il loro ruolo di protagonisti della narrazione, poiché anch'essi raccontano una storia: quella della distanza fisica, quella dei limiti imposti dalla tecnologia, quella di come anche il mondo digitale, in fondo, voglia esprimere la sua materialità.

*'The reason is that you are doing something which is true, which is incredibly true, and this is what I am always trying to push with the students, with the work we are producing here, is to make something which has this, this credibility, this incredible credibility that you feel when you are meeting social innovators. And what I very much like is when people mix the truth and the fake in the video that we are proposing. So, it happens in the pictures, in storyboards, in videos that we propose them to the stakeholders involved and that they did not understand if it was true or not true, if it's something that exists or doesn't exist, not because the video is perfect, but on the contrary, because the video is unperfect.'*¹⁰

4. Conclusioni

Film, video e documentari scientifici in ambiti quali matematica, scienze biologiche e naturali, fisica, neuroscienze rendono immateriale la materia, che diventa immagine e assume un valore estetico oltre che epistemologico. Nel caso di DESIS in the Mirror, la connessione Internet digitale che ha consentito la registrazione delle video interviste produce interferenze che conferiscono matericità a immagini e a suoni: il patto comunicativo con lo spettatore si fonda sullo sguardo in macchina degli intervistati; la composizione delle finestre video moltiplica il punto di vista unico della webcam; la cornice e l'interfaccia della piattaforma assumono il compito di dichiarare il medium stesso, rendendolo 'opaco' (Manovich, 2001).

¹⁰ Intervista per il progetto DESIS in the Mirror a Francois Jegou (Bruxelles, Belgium) condotta da Francesca Piredda e Andrea Mendoza - 24-09-2013.

Interferenze digitali. Un'estetica delle pratiche digitali a supporto del discorso di design

DESIS in the Mirror è un progetto aperto, che nasce da una riflessione, si presenta come una riflessione e stimola al dialogo. Il linguaggio audiovisivo rappresenta allo stesso tempo il tema oggetto della ricerca, lo strumento e la forma espressiva con cui il dialogo viene condotto e il discorso di design va producendosi.

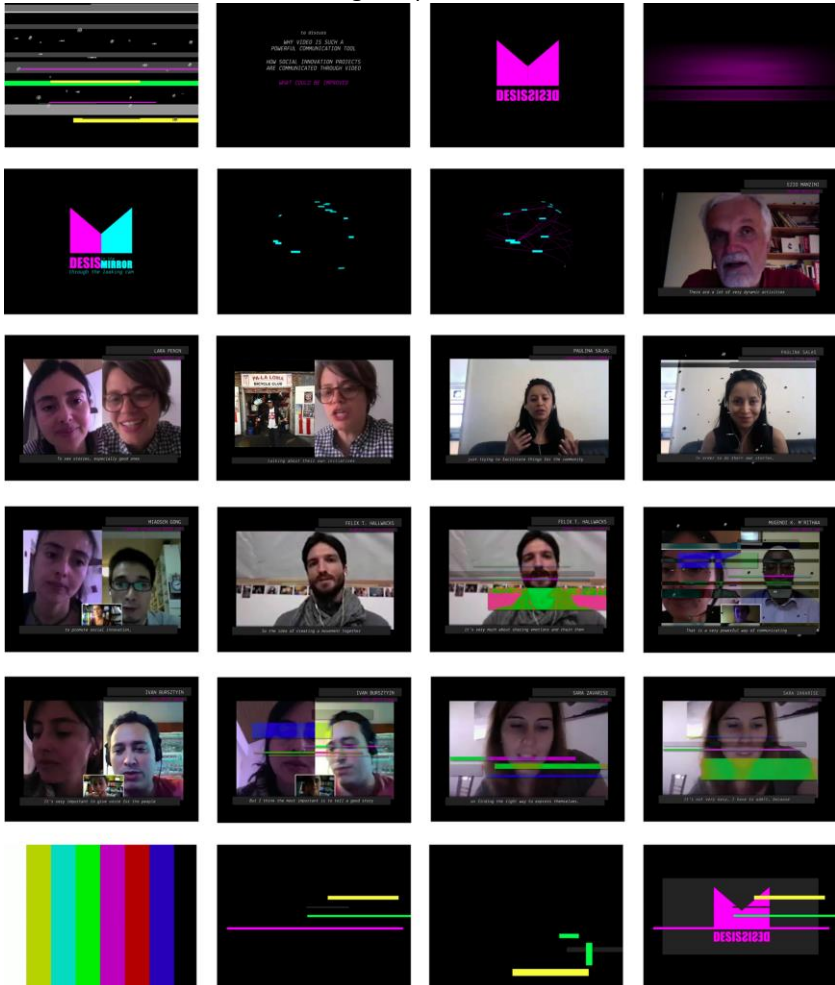


Figura 5 Fotogrammi dai video di DESIS in the Mirror.

Attribuzione dei paragrafi

Sebbene questo articolo sia il risultato di un processo di discussione, analisi ed elaborazione collettivo, la scrittura delle singole parti del testo è da attribuire a: Elisa Bertolotti (Paragrafo 1 - *DESI in the Mirror*), Federica D'Urzo (Paragrafo 2 - *Un format per il discorso della ricerca*), Francesca Piredda (Paragrafo 3- *Conclusioni*). Le autrici vogliono ringraziare Andrea Mendoza per il suo indispensabile contributo al progetto e Walter Mattana per i preziosi consigli. Un ringraziamento speciale a Chakrapipat Asswaboonyalert, Ivan Bursztyn, Andrés Burbano Valdez, Miaosen Gong, Francois Jegou, Florent Lazare, Ezio Manzini, Mugendi M'Rithaa, Lara Penin, Paulina Salas, Joon Sang Baek, Felix Tristan Hallwachs and Sara Zavarise per la grande disponibilità a condividere le proprie esperienze e idee.

Bibliografia

- Bertolotti, E., Mendoza, A. e Piredda, F. (forthcoming) *Is everybody a videomaker? Audiovisual communication in the pursuit of austerity*. Paper Presentato nei Proceedings di Cumulus Conference, More for Less – Design in an Age of Austerity, Dublino.
- Bertolotti, E., Piredda, F. and Villari, B. (2009) *La mappa qualitativa della ricerca in design: videointerviste e blog drm*. In Bertola, P. and Maffei, S. (a cura di), *Design Research Maps. Prospettive della ricerca universitaria in design in Italia*. Santarcangelo di Romagna: Maggioli Editore.
- Manovich, L. (2001) *The Language of New Media*. Cambridge: MIT Press.
- Menkman, R. (2011) The glitch moment(um). *Network Notebooks 04*. Amsterdam: Institute of Network Cultures
- Peters, H.P. (2012) Scientific Sources and the Mass Media: forms and consequences of Medialization, The Sciences' Media Connection – Public Communication and its Repercussions. *Sociology of the Sciences Yearbook*, 28.
- Piredda, F., Bertolotti, E. and Ciancia, M. (2013) *Animation as Boundary Object. Promoting cultural changes through audiovisual design*. Proceedings della Conferenza 2CO 2013 - COmmunicating COmplexity – Università di Alghero
- Shannon, C. and Weaver, W. (1949) *The mathematical theory of communication*. Urbana: University of Illinois Press.

Design Narratives and Social Narratives for Community Empowerment

Valentina ANZOISE ^a, Francesca PIREDDA ^{*b} and Simona VENDITTI ^b
^a Ca' Foscari University; ^b Politecnico di Milano

Considering Design as a set of practices that impact on the environment in which we lead our everyday activities, we assume that enacted narratives grounded on transmedia practices (formats based on audiovisual contents about communities and keeping with their surroundings) are able to support innovations stemming from local communities, as they constitute the most basic form of social life (Czarniawska, 2004). By presenting the case study of Plug Social TV, through which we experienced audio-visual languages and products in a collaborative process, we wish to discuss participatory design practices and storytelling both as opportunities for identity building and community engagement, and tools that can lead, support and amplify active communities' initiatives. By analysing the preliminary outcomes of this project, there can be identified two critical poles: on one hand, the design issue of having a strong communicative narrative structure within a participatory process; on the other hand, the lack of patterns recognition into a total fictional world, as a social issue. Our assumption is that the interdisciplinary work of designers, filmmakers and social scientists can build a setting enabling the inclusion of different kind of 'usable knowledges' (Fareri, 2009), facilitating interactions, enhancing reflexivity and generating feedback loops. Starting from the same case study, the paper presents a critical perspective on practices oriented to social innovation and on the use of storytelling in the design field and the of visual and narrative approach in social research.

Keywords: Narratives; social innovation; participatory practices; audiovisual language

Introduction

Enacted narratives are actions which are discursively constructed and undertaken, and can be considered as practices able to support innovations

* Corresponding author: **Francesca Piredda** | e-mail: francesca.piredda@polimi.it

stemming from local communities, since they constitute the most basic form of social life (Czarniawska, 2004). With the notion of *enacted narratives* we refer to the particular narratives ‘embodied’ and put into play by people, which instantiate (fully or partially) the narrative structures that narrators and listeners from the same narrative community share and can recognize as cultural facts. Tales and myths are among the highest expressions of narrative structures that circulate within a narrative community and that its members begin listening as infants and continue listening, and then telling, throughout their lives. E.g. probably most of European people know the tale of ‘Little Red Riding Hood’, and have - somehow - *enacted* this narrative structure in their childhood (i.e. transgressing rules given by adults, etc.)

From the design point of view, a sustainable innovation process is a ‘social process of learning’ (Manzini, 2003). Different languages and formats can provide support to pursue this aim, e.g. in the realm of scenario building, visualizations of possible solutions and brief narratives describing the deepest motivations for people engagement are always needed (Carroll, 1995). Indeed, the social benefit of narratives can be then identified into the ability to create imaginary worlds that can be considered as reflective layers of reality, from which the narrative structure is transferred to the current context, generating actions which are driven by individual and/or collective narrative logics (Lane, 2005).

Narratives and communities

Narratives – primarily because of their sense-making function and as privileged ‘access’ to understand how individuals structure the unknown and social change occurs – constitute powerful resources for ‘designed’ or intentional action. Moreover, they help to explain the relationships between events in a process and encode all kinds of data that are relevant for a wide range of phenomena as they are among the ‘most widely used forms of organizing human experience’ (Bruner, 1991, p. 9).

Therefore, narrative accounts are constructs that serve to ‘enable and constrain further action and further accounting, regardless of who produces them’ (Pentland, 1999, p. 721). They are especially relevant because people do not simply tell stories, but they also enact them: being not just a form of representing but also of constituting reality (Bruner, 1991). Moreover, stories provide legitimacy and accountability for people’s actions as they respond to a *narrative logic* that allows individuals to make sense out of what is happening around them and to proactively plan and act even upon

arising challenges and uncertainties. Nonetheless, although narratives do not just reflect process but also shape them, they have not equal possibilities to drive changes: dominant discourses are inscribed in societal institutions, in text and discourses, behaviours and material culture, giving them enormous material advantages, whereby alternative discourses tend to remain marginalized (Witkin, 2010). Indeed, each group's narrative privileges some voices and silences others: they are exercises of power.

Selective silencing is an unavoidable feature of narrative: finding the silent voices and revealing the sources of power in a narrative constitute one purpose of deconstruction. Moreover, the loose link between intentional states and subsequent action is the reason why narrative accounts cannot provide causal explanations, although we can come to know the reasons and the interpretations given by individuals for things happening.

The elements sketched above lead us to the importance of detecting (and supporting) narratives (either dominant or emerging) as they are the basis of the construction and reproduction of communities and collective imaginaries, i.e. a narrative community consists of – a group of people – no matter if they have ever physically met each other, whose communion is based on the sharing and understanding of a set of narratives (and narrative structures). Just a limited number is at hands to produce the stories its members share, but they are the focal pivots upon which the identities of the group are constructed, actions are fostered and events are interpreted.

Therefore, the role of communication design in building and fostering capabilities that support the understanding and construction of narrative communities, is crucial.

Audiovisual storytelling and design for social innovation

Quoting Carl DiSalvo (2009) we might say that communication design has a crucial role in the construction of publics: because of rhetorical strategies for opening up meanings and adapting them, the communication designer can find the proper forms for re-shaping the artefacts and events produced by users and communities, both tracing the conditions and the consequences of an issue.

As designers and scholars with specific expertise in audio-visual storytelling and transmedia strategies, we are experimenting the contribution of communication within co-design process together with an

approach aimed at enabling social dialogue and the build up of shared visions using the transformative power of stories.

We have been exploring envisioning and storytelling as design acts towards a community-centred communication (Piredda, 2008; Galbiati, Piredda, Mattana and Bertolotti, 2010). Referring to the term *empowerment* as the process of enabling local communities to increase their active participation in social life, developing projects for the community itself and building a more liveable neighbourhood, we can describe audiovisual storytelling as a tool for people empowerment.

The idea that storytelling can play a role in the realm of design for social innovation is the main topic under discussion within the scientific community of design at the international level being promoted by IMAGIS research team - Politecnico di Milano, Design Academy Eindhoven and MAD Faculty/LUCA within the DESIS Philosophy Talks' series on Storytelling and Design for Social Innovation (www.desis-philosophytalks.org): in Dublin (November 2013), in Eindhoven (February and October 2014), in Milan (May 2014). In these contexts we have been discussing the topic of storytelling, what we can learn from taking a philosophical perspective, focusing on the role of storytelling in the practice of design for social innovation as enabling the opening up of underexplored ranges of meanings in contemporary society. Looking at the manifold ways design is using storytelling techniques within its practices, the analysis of some examples coming from designers themselves highlights the variety of styles and forms emerging both from the professional and research realms, having stories at every single stage of the design process for collecting testimonials, creating empathy or experiencing user's points of view embedding, performing or enacting their stories, providing people with further tools for telling stories, envisioning possible solutions or speculating about the future (forecasting).

For example, in the realm of scenario building, visualizations of possible solutions and brief narratives describing the deepest motivations for people engagement are always needed (Carroll, 1995). Quoting Nik Baerten's video-statement for the DESIS Philosophy Talk Storytelling #3, 'On the one hand [stories] can be considered tools to establish a common ground for discussion; secondly, they're tools in order to gain insight into people's perspectives; and last but not least, they're tools to engage or move people.

[...] Stories could play a role bridging the existing situation, the world as it is and the world that could be, allowing people and designers as well to render tangible how they experience one and how they would like to experience the other, with hopes and fears, establishing a sense of distance.

[...] Stories enable us to establish kaleidoscopic views on how the situation could be in the future, establishing pathways of change and engaging people to use their imagination’.

Furthermore, the DESIS in the Mirror project (Bertolotti, Mendoza e Piredda, 2013) by IMAGIS - Politecnico di Milano and DESIS Network, focuses on audiovisual storytelling in particular, discussing why video is such a powerful communication tool, how social innovation projects are communicated through video and what could be improved encouraging the cross-fertilization of filmmaking and design practices. ‘Documentation and audiovisual contents are a privileged way to capture transformations’, says Andres Burbano Valdez (DESIS Colombia); ‘It is a very powerful way of communicating complex ideas to people’, as Mugendi K. M’Rithaa (CPUT DESIS Lab, Cape Town) underlines. Then, according to François Jégou (DESIS Network - STS) audiovisual storytelling is able ‘to inspire all social innovators, designers, architects, urban planners, politicians in changing the way they invent new solutions or new policies’.

Participatory video is a social interaction process, which uses audiovisual tools to enable dialogue within a community. By directly giving people the management and the control of the expressive tool, they can discuss themes and methods on how to face issues affecting the community itself.

In this field, different experiences share the use of documentaries in a social-anthropological context, but they differ from a methodological point of view since they use different and multidisciplinary techniques and approaches, often merging them together.

Participatory video is a process born to support fieldwork (Collizzolli, 2010). Nevertheless, three main elements are common and peculiar: it is a scriptless video process (audiovisual language is a key element of expression, without any definition of the subject beforehand); it is directed by a group of grassroots people; it moves forward in iterative cycles of shooting-reviewing, activating mechanisms of internal dialogue and self-awareness. Moreover, participatory video process generates both horizontal feedbacks with communities sharing similar problems all over the world and vertical feedbacks linking decision makers and the community itself.

Self-documentation and self-narration, within participatory video processes, represent a way for people to express themselves and make them able to spread their experiences as small but meaningful stories (Collizzolli, 2010). ‘As a mediation tool, the power of video was used to help resolve conflicts, achieve consensus and find a common ground for collective action. Video [...] demonstrates how powerful images can be used in documenting

realities, [...] using those realities to bring about significant changes' (White, 2003). Participatory video could enter the early stages of the design process developing an audio-visual text that claims to fit into a mainstream. Story making and video-making as participatory processes need a strategy to become scalable. They have then a cathartic role for the community itself, facilitating interaction and enabling self-expression, but, in order to pursue and widespread beyond the effective surroundings, narrative worlds have to be unfold in transmedia storytelling. It is all about opening up and expanding a storyworld across media platforms and engaging the audience within the transmedia practices as open systems of participation (Gambarato, 2013).

Since video *per se* is not enough, we are experimenting Social TV as a platform to foster feedback process between stakeholders, helping people to become free not only to arrange their daily life with innovative sustainable solutions, but also to nurture their projects step by step. Our hypothesis is that such a platform could then give them voice, make them able to share values and promote the evolution of ongoing initiatives.

Case study: Plug Social TV

Plug Social TV is an ongoing project whose aim is to experience audio-visual languages and products in a collaborative process, using participatory design practices and social media. The Social TV includes different formats, such as web-series, short documentaries and talk shows, whose plots and characters are based on real people and stories of a specific community located in a suburban area of Milan, Italy.

The word 'Social', related to this project, has a double meaning: on one hand it refers to Social Media as tools for supporting community building and co-operation, since Plug is based on digital channels and Social Media, using Facebook as the main platform. On the other hand, 'Social TV' is intended as a Community Television since it refers to a specific community showing contents of local interest.

The context in which the project takes place is that of a former industrial area which has been redeveloped thanks to some urban renewals, and that hosts a branch of Politecnico di Milano.

In recent years, a heterogeneous mix of inhabitants has populated this area: former workers of local factories, first and second generations of foreign citizens and the new community of out-of-town students. This cultural mixture has amplified the gap between the former industrial

character focusing on the past and the new international and academic identity looking into the future.

Furthermore, the introduction of such a huge educational structure into a neighbourhood portrayed by industrial ruins and with a suburban identity, has deeply modified not only the territorial configuration, but also the relationships between citizens and their local district and between permanent inhabitants and temporary city-users.

In this context, it is necessary to set up processes that are able to reflect the new complex identity of the neighbourhood, crossing cultural and generational boundaries, facilitating community relationships and driving reciprocal exchange dynamics.

The main goal of the project 'Plug Social TV' is creating a platform for dialogue and interaction which makes use of community-based narratives to express the several identities of the territory and their perception, in order to support the relationship among the neighbourhood inhabitants and the students. The model of a participatory communication strategy has the aim of offering forms and channels of expression for social groups, sharing common interests and practices.

Second aim is building a 'narrative transmedia landscape' using digital technologies and new media in order to engage people on a common narrative about their local area.

Finally, the definition of a model of partnerships with associations of citizens and local institutions is able to systematically drive citizens' actions in the direction of a more participatory local administration.

Within the process we involved the neighbourhood associations who are connected to city municipality, creating a scalable model, in order to give voice to community's needs, helping the inhabitants to understand and address issues affecting them and driving their interests for more efficient decision-making operations. We included the establishment of partnerships with local service providers and retailers considering them as stakeholders that can have an impact on the collaborative process of regeneration and empowerment of local identity and community participation.

Process

Activities started in October 2013 with a one-day workshop in which team-works of students and citizens worked collaboratively in order to explore the neighbourhood in which our University is located, thus creating a first connection and occasion of meeting.

A group of active citizens and two classes of students from the Master Degree course in Communication and Interior Design participated. As designers and researchers, we facilitated the workshop and we established partnerships with some citizens' associations who promoted the event among other inhabitants and supported workshops' facilitation.

The whole process counted three main phases: exploration of the local context, concept and creation of the story world across digital media, video production and feedbacks.

Aim of the first phase was to explore the local area and investigate the perception that citizens have of their neighbourhood, asking them to share needs and expectations. The nine mixed groups, composed by students and citizens, went out in the neighbourhood and collected audiovisual material (pictures, videos, interviews, tales from the inhabitants), they identified a narrative environment and developed a community-based storytelling idea.

The work went on in the following months: students expanded their short stories and created nine documentaries based on the material they had collected during the workshop. They presented the documentaries to the community in December, with an exhibition at the public library. During the exhibition, students and citizens met again and started discussing about the visual re-elaboration of the local area: citizens were able to see themselves interviewed, as well as the people belonging to their community of reference, they recognized their own voices and opinions in the interviews and they were able to give feedbacks telling their impressions and feelings.

The nine documentaries can be considered as mid-term results, which are able to maintain the connection between the two communities and to activate a self-recognition process through which individuals and groups can see themselves as the main characters of a common story.

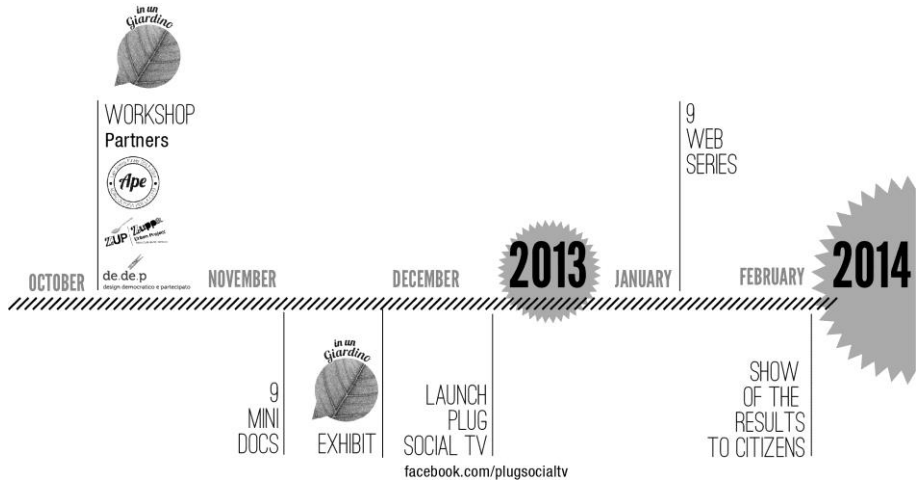


Figure 1 Plug Social TV: Timeline of activities and outputs

In order to maintain this dynamic feedback loop, students were asked to set up the online community, creating the virtual identity for the web-TV channel. They realized a brand for the web-TV, with a logo and a name (Plug) and created the profiles on different Social Networks. Facebook has been chosen as the main platform, but the system involves accounts also on YouTube and Twitter plus an official landing page.

The use of Social Media as tools and methods for sharing and discussing information as well as a way to distribute and spread contents of local interest, have already been proved successful (Lachapelle, 2011).

The use of Social Networks helped us to involve citizens into the activities, keeping them updated with news and information, giving them a place – either virtual and physical - where people of the neighbourhood can discuss, thus creating a basis for further participation and engagement.

In the second phase, students focused on the definition of the story universe (characters, actions, environments, relationships, etc.) and its distribution across several channels (online/offline) according to a transmedia strategy.

The narrative elements that have been collected from the neighbourhood are, in this second phase, re-elaborated and rearranged in order to build fictional audio-visual artefacts whose plots are based on reality. These fictional products are identified as formats that can be distributed on Social Media channels and that have a transmedia structure.

For the production phase, students developed nine web-series, which have different genre, language, tone of voice, media structure and degrees of engagement and they produced the web-series promos.

Here, we want to focus on two of the productions realized.

The first one, entitled 'Das de man' (a dialect form for 'Give each other a hand') has real people of the neighbourhood as main characters and shows stories that are directly connected to their personal experiences. Locations are real and plots of the seven episodes are based on specific themes that are identified by citizens in a co-design activity.

Each episode is produced using UGC (User-Generated Contents): citizens are taught how to use cameras and tools for video-production through online tutorials and specific workshops, so that they are able to express themselves using audio-visual languages.

This format can be considered as a hybrid between documentary and fiction in which the citizens involved can be divided in two main groups: those who have a story to tell about the neighbourhood but that are not familiar with new technologies, social networks and audio-visual productions and those who want to represent creatively their own point of view. The former group is given voice through the transformation of its stories into fiction, and the latter can find a channel for its self-expression.

Despite the non-professional form of the final product, a strong sense of belonging to a specific community of interests is activated by the recognition of real characters, locations and stories.

On the other pole we have a format ('Civico X' - 'House number X') that tells the story of an imaginary character, Mr. X, whose personal background is strongly connected to the history of the neighbourhood.

By using an imaginary story, this web-series wants to address some real community issues: the relationship between foreign and native citizens, the generation gap between young and old people, the lack of public green areas and other general themes as safety and mobility.

This is the case where it is more evident the use of transmedia in order to fill the gap between reality and fiction: some of the products that appear in the episodes are, thanks to partnerships with local retailers, produced and put into the local market. Moreover, some of the characters have their own personal profile on social networks and they actively interact with the Social TV main platform, adding details and elements to their story.

The two formats described above can be recognized as two critical poles: on one hand, the most participatory format involved citizens into the whole creation process, from the script to the production of the episodes, missing

the goal of a strong communicative narrative structure. Based on personal experiences and having a first person point of view, this format doesn't share a dramatic arc in which a character struggles and finally triumphs over adversity. Moreover, as far as a design issue is concerned, the format production process presents a lack of professional competences and produces audiovisual outputs characterized by an aesthetics that announces their bottom-up nature and reclaims a meta-narration of the process itself, which has to be enhanced (design issue).

On the other hand, there is a total fictional format, which could present a lack of patterns recognition. As far as the social issue is concerned, the format is able to speak to a wider audience rather than the citizens of the neighbourhood: the format is telling a mystery tale and is referring to universal values such as love and the fight against evil power. Even though the plot is based on historical facts and on the environmental issues affecting a specific urban area, you don't have to be a citizen of that area to understand the story: it both fascinates the public and engages people in being proactive, joining the local community, empathizing with citizens and sharing similar experiences (social issue).

Discussion

Considering Plug Social TV as a case study, Communication Design has the role of setting up the conditions so that reflective dynamics can be activated and collaborations among groups of territorial actors developed.

Therefore, our mission is to orient the communication system towards the construction of a narrative community, starting from the identification of common interests and the setting up of collaborative communication activities. The oral storytelling, together with its conceptual and visual elaboration, the collaborative production of audiovisual artefacts - both from the creative and technical point of view, the collective viewing in public spaces of the neighbourhood, the distribution through Social Networks and other web channels - which expands sharing possibilities and feedback opportunities, all represent different occasions in which social conversation can be built and carried on. Groups of citizens are both audiences and storytellers, they are, together with the designers, the main characters of narrative acts that require the selection of themes and topics to be dramatized, goals and audiences to refer to and expressive forms to be coherent with.

In this context, web-series are more than just entertaining products: they deal with hyperlocal topics enacting universal themes and values, which are discussed within the community of interests and practices that have been reinforced through the practice itself of the production of audiovisual artefacts. More than that, thanks to the narrative form, the community is now able to shape its mission and goals, building networks and gaining strength, going beyond localism. Thus, communication design takes part in the co-design process with the aim to decrease the gap between micro-narratives and mainstream.

Web-series as audiovisual products are addressing the local community as general audience and local institutions as focus target, but processes and narrative practices, from which the products come from, represent the most meaningful aspect, which can attract the audience also outside the community. They represent best practices to compare with and to amplify by networking, linking and monitoring the development, also in terms of social impact.

We can argue that local participatory experiences enabled by Plug Social TV can build a widespread network of smart community TV all over the world that is expected to develop micro-narratives beside the mainstream. Even though it is an on-going project, we are already willing to identify what could be the proper approach to evaluate the impact and the outcomes – in terms of cascades of transformations produced and processes triggered - of this activities, (e.g. the Dynamic Evaluation approach) specifically designed to follow and support the development of innovation processes, within the Emergence by Design project (MD, FP7- GA n. 284625 www.emergencebydesign.org). Moreover colleagues from MAD/LUCA in Genk (Belgium) and Università degli Studi di Verona are already asking to test this model of transmedia practice with other local communities in collaboration with local stakeholders, in order to strengthen both the social role of the academy and the relationship between the campus and the neighbourhood by building a common narrative.

The narrative process that Plug as transmedia practice is unfolding opens up new possibilities, according to one of the main characteristics of participatory video: the original goals defined at the very beginning phase, even if confirmed, often leave the stage to the brand new social and communicative aims and solutions that the community of citizens and researchers together might discover and experience along the way due to the transformative power of stories.

On one hand, Plug Social TV can be considered as a cultural attractor (Jenkins, 2006), able to set up the conditions for people engagement in meaningful experiences. On the other hand, Social TV system scalability can be possible if we consider it as a format made of practices and partnerships, which are able to complete social values with the economic ones.

That means that we can refer to the Social TV as a narrative system that enables communities (worth) and not just as an editorial product with a commercial account (value) (Jenkins, 2013).

Plug Facebook page, in fact, provides qualitative information coming not only from the insights, but also from the comments users post on videos. Thus, they highlight the most meaningful matters: 'What a thrill!' ('Che emozione!'); 'I'm so proud of living in this neighbourhood. Beautiful and precious things are happening' ('Orgogliosa di abitare in una zona dove succedono cose così belle e preziose'); 'It was nice to meeting you, Mauro! Good job, Plug, Thank you!' ('Che bell'incontro, Mauro! Bravi, Plug, Grazie!'); 'Great!' ('Fantastico!'); 'Ahah, that's me and Micia [in the video]' ('Ahah, ci siamo anche io e la Micia').

Expected results and next steps

The next step of this ongoing project is the production of the web-episodes together with citizens and partners, developing the participatory process throughout the audiovisual pipeline and according to the transmedia strategy. We assume that the different genres of the series themselves will, in the next future, be able to activate different communicative patterns and manifold expectations, propping up narrative acts and enabling different nuances and approaches to participation and engagement.

But how can we actually keep on monitoring the engagement? We must consider both quantitative and qualitative results: by the end of February, after the publication of the web-series promos, Plug Facebook Page had more than seven hundred 'likes' and Plug Youtube channel counted about two thousand views. Almost a half of Facebook fans were actually active users, liking, sharing and commenting posts and videos.

What we can consider as a qualitative result is the fact that the most commented and shared contents are those videos in which the presence of the community is more evident: we can notice more interest towards those clips in which citizens are the main characters of the story.

Conclusions

We concentrate on the three key features of Transmedia Practice (Dena, 2009): first, the creation of a story world towards the construction of a complex 'mythology' (Jenkins, 2009); second, the distribution of content on different media with the consequent blurring of boundaries between fiction and reality; third, the audience engagement, which allows people to participate into meaning making processes becoming aware of their main role in the media landscape (Ciancia, 2013).

Putting the project into practice requires a large productive effort, that we are able to face thanks to the collaboration between students and citizens. The business model can be sustained merging skills and resources, which are already available within the community: partnerships, product placement activities, sponsorships, service providing, stakeholders involvement, crowdfunding and crowdsourcing initiatives.

However, the final result cannot reach a high quality aesthetical standard: the online spread of UGC (User-Generated Contents) gets people used to videos and products realized and distributed online despite a lack of literacy that broadcasting editors would never distribute on mainstream channels. Therefore, it is necessary to keep track of the process triggered and to collect those practices, which are able to communicate and give value to the social and productive context in which the project is considered as a meaningful social experience.

The collaboration between professionals and non-professionals, then needs to be designed: we need to document the process of engaging citizens and making them become protagonists (both as main characters of the story and videomakers). We have to film people filming themselves in order to record the self-narration process, to provide them further materials for self-expression and self-reflection, and to amplify the project itself and the framework we are developing (meta-cinema, meta-TV).

References

- Bertolotti, E., Ciancia, M. and Piredda, F. (2013) *Animation as Boundary Object*. Paper Presented at the Proceedings of the Communicating Complexity Conference, Alghero.
- Bertolotti, E., Mendoza, A. and Piredda, F. (2013) *Is everybody a videomaker? Audiovisual communication in the pursuit of austerity*. Paper

- Presented at the Proceedings of the Cumulus Conference, More for Less – Design in an Age of Austerity, Dublin.
- Bruner, J. (1991) The Narrative Construction of Reality. *Critical Inquiry*, 18 (1), 1-21.
- Carroll, J.M. (1995) *Scenario-Based Design: Envisioning Work and Technology in System Development*. New York: John Wiley and Sons.
- Ciancia, M. (2013) What is Transmedia? Projects and Thoughts beyond the Buzzword. Paper Presented at the Proceedings of the 19th International Symposium on Electronic Art, ISEA2013, Sydney.
- Collizzolli, S. (2010) *Il Video Partecipativo dalla comunicazione sociale alla socializzazione della comunicazione*. PhD Thesis, Dipartimento di Sociologia. Padova: Università degli Studi di Padova.
- Czarniawska, B. (2004) *Narratives in Social Science Research*. London: Sage.
- Dena, C. (2009) *Transmedia Practice: Theorizing the Practice of Expressing a Fictional World Across Distinct Media and Environments*. PhD Thesis, Sydney, University of Sydney.
- DiSalvo, C. (2009) Design and the Construction of Publics. *Design Issues*, 25 (1), 48-63.
- Fareri, P. (2009) *Rallentare. Il disegno delle politiche urbane*. Milano: Franco Angeli.
- Galbiati, M., Piredda, F., Mattana, W. and Bertolotti, E. (2010) *Envisioning the City: A Design-Oriented Communication Process for a Sustainable Urban Transformation*. Paper Presented at the ESA Sociology of Culture Midterm Conference: Culture and the Making of World. Available at SSRN: <http://ssrn.com/abstract=1692118>.
- Gambarato, M.R. (2013) Transmedia Project Design: Theoretical and Analytical Considerations. *Baltic Screen Media Review*, 1 (1), 80-100.
- Jenkins, H. (2006) *Convergence Culture: Where Old and New Media Collide*. New York: New York University Press.
- Jenkins, H. (2009) *The Aesthetics of Transmedia: In Response to David Bordwell (Part One)*. [Online] Available from: http://henryjenkins.org/2009/09/the_aesthetics_of_transmedia_i.
- Jenkins, H., Ford, S. and Green, J. (2013) *Spreadable Media. Creating Value and Meaning in a Networked Culture*. New York: New York University Press.
- Lachapelle, P. (2011) *The Use of Social Networking in Community Development, CD Practice*. [Online] 17, Community Development Society. p. 2. Available from: <http://www.comm-dev.org/index.php/publications/cd-practice>.

- Lane, D. and Maxfield, R. (2005) Ontological uncertainty and innovation. *Journal of Evolutionary Economics*, 15 (1), 3-50.
- Manovich, L. (2001) *The Language of New Media*. Cambridge: MIT Press.
- Mendoza, A., Bertolotti, E. and Piredda, F. (2013) *Is everybody a videomaker? Audiovisual communication in the pursuit of austerity*. Paper Presented at the Proceedings of the Cumulus Conference, More for Less – Design in an Age of Austerity, Dublin.
- Pentland, B.T. (1999) Building process theory with narrative: From description to explanation. *Academy of Management Review*, 24 (4), 711-724.
- Piredda, F., (2008) *Design della comunicazione audiovisiva. Un approccio strategico per la 'televisione debole'*. Milano: FrancoAngeli.
- Star, S.L. and Griesemer, J.R. (1989) Institutional Ecology, 'Translations', and Boundary Objects: Amateurs and Professionals in Berkeley's Museum of Vertebrate Zoology 1907-39. *Social Studies of Science*, 19 (3), 387-420.
- White, S.A. (2003) *Participatory Video, Images that Transform and Empower*. London: Sage.
- Witkin, S.L. (2010) A discourse perspective on evaluation. *Culture & Society*, 1 (1), 109-122.

Today's culture jamming aesthetics: an investigation to understand the consumption of visual resistance

Andréa POSHAR*

Politecnico di Milano

What was once characterized by high barriers between the ruling culture and subculture is today marked by a constant flow of techniques, tools and practices exchanges. Such flows have influenced the behaviour and the relationships of their actors, i.e., culture jammers and designers. By observing the consequences of these flows, that is the responses, (re)actions, aesthetics and consumption, this paper aims to investigate the commodification process, the counterculture movement, and culture jamming. The gap opened between jamming and mainstream culture makes us wonder what the designer's role is and how important it is within this process. To exemplify our theory, subverted graphics, as for instance billboards and magazines, will be used as the main object of analysis of this ongoing research.

Keywords: Consumption; culture jamming; design; graphic design

Introduction

Since the Impressionism movement, new artistic styles have been established through aesthetic upheaval. As an insurgency against visual rules established by traditional art, movements like Futurism, Cubism or Constructivism rejected all previous traditional art practices, methods and tools. Like many others, for instance De Stijl and Bauhaus, these disruptive movements defended visual art as a practice for social, economical and political purposes.

Generally considered as subversive movements, these anti-conventional art practices influenced design's practices as well. Sorge (2012) argues that these practices in graphic design and visual communication were, until very

* Corresponding author: **Andréa Poshar** | e-mail: andrea.poshar@polimi.it

recently, all variations of what was generally considered to be a *visually aggressive rebellion*.

Artistically speaking, to be *visually aggressive* is to 'respond' against the conventional development of visual patterns, that is, to create a new aesthetic over the traditional ways of producing a piece of art. One example of it is the abstract art, which disrupts the traditional shapes of squares, rectangles and rounded shapes defended by Cézanne many years ago.

Regarding graphic design, to be *visually aggressive* is not only to deform traditional shape patterns, but also to re-shape the already existent image: for example, the *visual assaults* made over billboards exposed in urban public space.

This is not a new phenomenon, but it became better known and studied at the end of the '70s, with the rising of political crisis and the development of new media – color TV, radio, specialized magazines and years later, digital media.

One of the visual aggressive movements to influence the most graphic design was culture jamming. This '80s movement knew how to use the techniques and practices created by designers for the development of their own particular aesthetic.

For many years, jammers have created a visual impact going against what they used to believe were their worst social enemies: political/capitalism flaws, visual pollution, public space manipulation and consumerism.

Mainly working with bricolage¹, jammers conducted changes mostly in advertising images, compromising their visual 'legitimacy' and modifying their meaning. By retaking billboards, the one-way communication of ads was altered into an interchange of ideas and images.

It is clear that at their very beginning, jammers had a straight visual political language; however, their *modi operandi* seems to have changed.

Even though many of the well-known jammers of today seek to convey political visibility and criticism, others seem to have a completely different objective. Nowadays, culture jamming is also being produced and being sold by multinational brands and/or international art galleries. In short, all these works are being created to be part of what jammers go against> mainstream dominant culture.

1 Bricolage is a French word that means, 'tinkering'. Is the construction or creation of a work from a diverse range of things that happen to be available, or a work created by such a process. A word with a closer meaning could be 'remix'.

Today's culture jamming aesthetics: an investigation to understand the consumption of visual
resistance

With this paper, I intend to highlight a new approach of analysis of counterculture's aesthetics and consumerism within contemporary society. In my opinion, there is a lack of boundaries and limits within fields that years ago would have been impossible to merge, as counterculture and mainstream (Calabrese, 1987). By using OBEY as an example of this dichotomy, I will be able to show and prove that jammed images, by being exposed in public spaces as 'advertisements', are also subjected to be consumed as one of them.

To take *OBEY* as an example will enable me to analyze the changes in the use, function, language and visual identity of counterculture.

This paper tries to comprehend current culture jamming not only as an artistic or political movement but also as a movement that is under a process of re-signification and commodification. Within this, I am trying to demonstrate the importance of the designer's work and their role in the transformation process of counterculture in a commodity, once it has been identified as a good source of inspiration for the guerrilla marketing. The ongoing investigation may shed light on aspects not yet perceived in communication design.

(Re)Producing Images

According to Walter Benjamin (1955), in times of great changes, the existing form of humanity also changes and, as a consequence, the sensorial perception regarding images as well. This means, the way in which men are used to perceive their environment and the medium in which these changes occur are altered not only naturally, but also historically.

The time of the great invasions is one example of these perceptions changes, to quote the author. The 'industry' of art, which had emerged with the Lower Empire, had not only a different method of practice and value, but also a completely different perception from the art produced in the Antiquity.

The issue to stress here is that, even though the knowledge of perception was broad, it had also its limits. This limitation consisted in the fact that many scholars from that time were 'contenting' themselves with a very strict and formal analysis.

Currently, these conditions are somehow favorable to understand and to analyze: the development of different techniques of images (re)production has drastically changed the perception of society and, within this, the social conditions of consumption. I.e., images are no longer produced as a unique

and high valued object, but rather than that, images nowadays are being produced to be multiplied and to be accessible.

Hence, for Benjamin (*ibid*) to reproduce an image is to declare its freedom under the traditional domain. The problem is that, at the same time, it is a declaration of a dependency to a system of techniques and practices of reproduction - to reproduce or to multiply an image is not only to break with tradition, but also to place the image inside the culture of masses.

This, according to the author, generates a crisis related to 1) The unstoppable consumption of these images, and 2) The loss of value and the aura of these images, which means, of their authenticity.

At the beginning of the 19th century, the technical reproduction of images had reached such a high level that it begun to transform not only the totality of works of art from prior eras and submit their effects to deeper modifications, but also to win its own place among the artistic processes (Benjamin, 1955).

Within this, another crisis among the system of images reproduction started to grow: oppositional artists had utilized their work to inspire, offend, and enrage audiences to awake from the massive production of images and the 'unconscious' consumption of them (Clark *apud* Darts, 2004, p. 319).

According to Darts (2004), by enraging the audience and calling attention to social, political and cultural flaws, artists are able to expose society to itself and to the world they are attempting to cultivate together:

From gay activists to Guerrilla Girls, Dadaists to Debord, Conceptualists to Culture Jammers, socially engaged artists have repeatedly addressed and redressed issues of sociopolitical and cultural significance, and in the process, undermined our ability to function within a dysfunctional world (Dart, 2004, p. 319)

This means that, while individuals develop 'shortcuts' in images production processes (trying to make them even more accelerated), they break the bound with the human centered processes that nowadays society is trying to 're-cultivate'.

For Argan (1993, p. 4)², 'Western thought, structurally objectifying, objectifies things, people, the whole reality'. This 'reduction' of the images

² Free translation of: 'O pensamento ocidental, estruturalmente objetivador, objetiva as coisas, as pessoas, a realidade inteira' (Argan, 1993, p. 4).

Today's culture jamming aesthetics: an investigation to understand the consumption of visual
resistance
production happens due to the loop of technology development and improvement, to the fast progress of mass media and to the increasing of consumerism stimulated by the capitalism system - as previously defended by Benjamin (1955).

This guides us to the idea of culture industry [*Kulturindustrie*] proofed by Adorno (1991).

Considered as a consequence of the development of modern society itself, the *culture industry* is related to aspects of industrialization, the growing of science, consumption and social massification.

This discussion around the *culture industry* commonly distinguish issues related to the mischaracterization of the concept of art (in which we can include also design), the dominant culture and the disposal of the individuals who are turned into consumers.

It is known that mass culture is carried out mainly through information and communication systems and, with these, a tremendous amount of images is created generating an endless 'problem' in which (states) Argan states:

Mass culture [...] is the only culture in a heavily industrialized world for economic and technological needs, aims at a maximum of standardization or uniformity of products (Argan, 1993, p. 9)³

For the author (ibid), to accept passively the massive production of images and their consumption directly reflectes on the development of the environment. I.e., the bombardment of images to which people are put through, especially in public spaces is the consequence of a passive tolerance - a lack of active (re)action of the majority of the society which allows the appropriation of public spaces and images proliferation by the mainstream media.

In short, visual mass communication should not simply be one-way but, instead, should stimulate the communication of individuals among themselves and the environment.

3 Free translation of: 'A cultura de massa não tem em si uma qualificação política; é a única cultura possível em um mundo fortemente industrializado que por necessidades econômicas e tecnológicas, tem em vista um máximo de padronização ou de uniformidade dos produtos' (Argan, 1993, p. 9).

One of the main examples regarding this massive production of images is advertising: a field in which the visual predomination on urban environment encourages a disproportionate, repeated and exaggerated need for a certain product.

Furthermore, it is clear that among mass culture we can identify those who do not question or argue about their situation, but we can also recognize that a part of this society does not accept the idea of having their existence subjugated to a manipulated community: 'The attempt by some groups to hegemonize and manage their interest in mass culture is undoubtedly a major cause of anxiety and danger for others' (Argan, 1993, p. 10)⁴.

It is necessary to clarify that what I understand and interpret by 'others', mentioned by Argan, is the minority of society who must subjugate themselves to the rules dictated by a dominant culture: subculture.

Subverting in period of crisis

According to Walter Benjamin (1955), in times of great changes, the existing form of humanity also changes and, as a consequence, the sensorial perception regarding images as well. This means, the way in which men are used to perceive their environment and the medium in which these changes occur are altered not only naturally, but also historically.

The time of the great invasions is one example of these perceptions changes, to quote the author. The 'industry' of art, which had emerged with the Lower Empire, had not only a different method of practice and value, but also a completely different perception from the art produced in the Antiquity.

The issue to stress here is that, even though the knowledge of perception was broad, it had also its limits. This limitation consisted in the fact that many scholars from that time were 'contenting' themselves with a very strict and formal analysis.

Currently, these conditions are somehow favorable to understand and to analyze: the development of different techniques of images (re)production has drastically changed the perception of society and, within this, the social conditions of consumption. I.e., images are no longer produced as a unique

4 Free translation of: 'A tentativa de alguns grupos para hegemonizar e gerir o seu interesse na cultura de massa é, sem dúvida, uma das principais causas de ansiedade e perigo para os outros' (Argan, 1993, p. 10).

Today's culture jamming aesthetics: an investigation to understand the consumption of visual
resistance

and high valued object, but rather than that, images nowadays are being produced to be multiplied and to be accessible.

Hence, for Benjamin (ibid) to reproduce an image is to declare its freedom under the traditional domain. The problem is that, at the same time, it is a declaration of a dependency to a system of techniques and practices of reproduction - to reproduce or to multiply an image is not only to break with tradition, but also to place the image inside the culture of masses.

This, according to the author, generates a crisis related to 1) The unstoppable consumption of these images, and 2) The loss of value and the aura of these images, which means, of their authenticity.

At the beginning of the 19th century, the technical reproduction of images had reached such a high level that it began to transform not only the totality of works of art from prior eras and submit their effects to deeper modifications, but also to win its own place among the artistic processes (Benjamin, 1955).

Within this, another crisis among the system of images reproduction started to grow: oppositional artists had utilized their work to inspire, offend, and enrage audiences to awake from the massive production of images and the 'unconscious' consumption of them (Clark *apud* Darts, 2004, p. 319).

According to Darts (2004), by enraging the audience and calling attention to social, political and cultural flaws, artists are able to expose society to itself and to the world they are attempting to cultivate together:

From gay activists to Guerrilla Girls, Dadaists to Debord, Conceptualists to Culture Jammers, socially engaged artists have repeatedly addressed and redressed issues of sociopolitical and cultural significance, and in the process, undermined our ability to function within a dysfunctional world (Dart, 2004, p. 319)

This means that, while individuals develop 'shortcuts' in images production processes (trying to make them even more accelerated), they break the bound with the human centered processes that nowadays society is trying to, 're-cultivate'.

For Argan (1993, p. 4) [2], 'Western thought, structurally objectifying, objectifies things, people, the whole reality'. This 'reduction' of the images production happens due to the loop of technology development and improvement, to the fast progress of mass media and to the increasing of

consumerism stimulated by the capitalism system - as previously defended by Benjamin (1955).

This guides us to the idea of culture industry [*Kulturindustrie*] proofed by Adorno (1991).

Considered as a consequence of the development of modern society itself, the *culture industry* is related to aspects of industrialization, the growing of science, consumption and social massification.

This discussion around the *culture industry* commonly distinguish issues related to the mischaracterization of the concept of art (in which we can include also design), the dominant culture and the disposal of the individuals who are turned into consumers.

It is known that mass culture is carried out mainly through information and communication systems and, with these, a tremendous amount of images is created generating an endless 'problem' in which (states) Argan states:

Mass culture [...] is the only culture in a heavily industrialized world for economic and technological needs, aims at a maximum of standardization or uniformity of products (Argan, 1993, p. 9)⁵

For the author (ibid), to accept passively the massive production of images and their consumption directly reflectes on the development of the environment. I.e., the bombardment of images to which people are put through, especially in public spaces is the consequence of a passive tolerance - a lack of active (re)action of the majority of the society which allows the appropriation of public spaces and images proliferation by the mainstream media.

In short, visual mass communication should not simply be one-way but, instead, should stimulate the communication of individuals among themselves and the environment.

One of the main examples regarding this massive production of images is advertising: a field in which the visual predomination on urban environment encourages a disproportionate, repeated and exaggerated need for a certain product.

5 Free translation of: 'A cultura de massa não tem em si uma qualificação política; é a única cultura possível em um mundo fortemente industrializado que por necessidades econômicas e tecnológicas, tem em vista um máximo de padronização ou de uniformidade dos produtos' (Argan, 1993, p. 9).

Today's culture jamming aesthetics: an investigation to understand the consumption of visual
resistance

Furthermore, it is clear that among mass culture we can identify those who do not question or argue about their situation, but we can also recognize that a part of this society does not accept the idea of having their existence subjugated to a manipulated community: 'The attempt by some groups to hegemonize and manage their interest in mass culture is undoubtedly a major cause of anxiety and danger for others' (Argan, 1993, p. 10)⁶.

It is necessary to clarify that what I understand and interpret by 'others', mentioned by Argan, is the minority of society who must subjugate themselves to the rules dictated by a dominant culture: subculture.

The culture of visual rebels

It is clear, affirms Önal (2005), that in every era it is easy to find activists who are against dominant power and controlled images in public spaces. Culture jamming, for instance, is one of these 'mass dissent' groups defended by Eco, in which it is possible to clearly observe (and analyze), the guerrilla warfare:

In a society of heat, light and electronic poltergeist – an eerie otherworld of 'illimitable vastness, brilliant light, and the gloss and smoothness of material things' – the desperate project of reconstructing meaning, or at least reclaiming that notion from marketing departments and P.R. firms, requires visually-literate ghostbusters. Culture jammers answer to that name' (Dery, 1993, p. 7).

In accordance with the Culture Jammer's Network Statement (Dery *apud* Lamb, 2003), the main aim of culture jamming is to become what civil rights were in the 60's, feminism in the 70's and environmental activism in the 80's: a change in the way society interacts with the mass media and the way meanings are produced.

Culture jamming is a type of subversion. It is a visual response to mainstream cultural institutions, especially the ones dealing with visuality in public spaces – for jammers, it is public spaces appropriation and dominance.

6 Free translation of: 'A tentativa de alguns grupos para hegemonizar e gerir o seu interesse na cultura de massa é, sem dúvida, uma das principais causas de ansiedade e perigo para os outros' (Argan, 1993, p. 10).

The movement, as Eco's guerrilla warfare proposal, being partially 'artistic terrorism' and partially critical, creates a disorder into the signal on the regular visual message of the image (Dery, 1993).

Based on graffiti, modern art and do-it-yourself punk philosophy, culture jamming uses billboards as its main medium. With posters, they re-create the messages by 'acting' over them with visual 'attacks' and subverting the language of advertisings - especially the ones related to fashion and fast food.

In other words, culture jamming characterizes itself as an anti-consumerism movement and its main purpose is to expose and question the implications related to the consumption and appropriation of public space by advertising agencies.

According to many scholars, like Dery (ibid) for instance, the origin of the movement is characterized by a historical background that includes the aesthetic of Russian *defiance*, 60's radical journalism, beatnik culture, subcultural bricolage and *détournement*.

The root of *détournement* itself relies on the medieval ceremonies where the social order was inverted and the authorities paraded around in costume, revealing their 'natural persona', i.e., the real and true intention and nature of that particular person⁷.

This is exactly the purpose of culture jamming: to reveal the hidden message in advertising and to reverse the hierarchical relation between meanings created by the mainstream culture. 'Instead of allowing for meanings to be dictated from the corporation down, it aims for them to move from the people up' (Lamb, 2003, p. 4).

We are a global network of artists, activists, writers, pranksters, students, educators and entrepreneurs who want to advance the new social activist movement of the information age. Our aim is to topple existing power structures and forge a major shift in the way we will live in the 21st century.

Figure 1 *The Media Foundation*. Source: <https://www.adbusters.org/about/adbusters>.

But, after all, who are these jammers?

7 http://www2.fiu.edu/~mizrachs/Culture_jamming.html.

Today's culture jamming aesthetics: an investigation to understand the consumption of visual resistance

In my opinion, they may be described as dissatisfied and frustrated individuals with a feeling of failure towards their representative government, the capitalism system and the advertising massive domination. Among them, it is possible to find visual artists, designers, activists, writers, scholars and students. I.e., a part of a society that is critical, active and able to create and to develop the tools (materials, techniques and practices) to express themselves.

In short, this means that society itself is stimulated to create its own ways of expression (considered by the jammers as manifestos), using public spaces and billboards as the main support to do so.

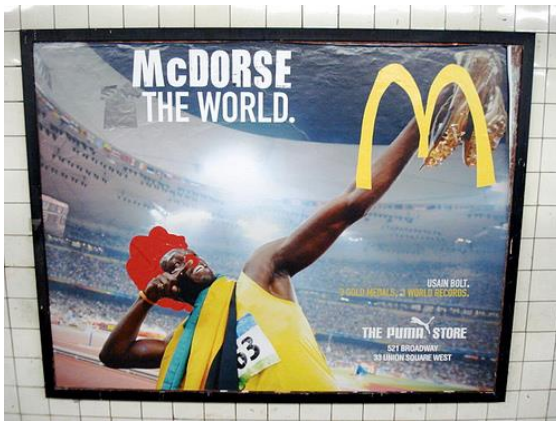


Figure 2 *Poster Boy jammed poster.* Source: <http://www.mymodernmet.com/forum/topics/does-street-artist-poster-boy>.

Culture jamming, affirms the American Center for Communication and Civic Engagement⁸, presents a variety of interesting communication strategies that 'play' with the branded images and icons of consumer culture to make society aware of their surrounding issues and cultural experiences that capture their attention.

Using techniques of *bricolage*, *assemblage*, *collage* and cut up to subvert billboards, jammers paint and mount new messages over the exposed posters.

8 <http://depts.washington.edu/ccce/polcommcampaigns/CultureJamming.htm>

The American jammer *Poster Boy* is a clear example of this. Ripping the billboards and painting over them, he generally uses the context of the original image to develop a new one.

With a 'raw' technique, if I may put it this way, *Poster Boy* cuts up all the billboard's original images and with a homemade glue, he pastes the new images, previously prepared by him.

Like an onion, he 'peels' all the visuality of determined billboards, to then work above the subverted image, creating with this 'new' visual layer a new message, mostly with a political and ironic attitude in accordance with what was exposed.

Giroux (*apud* Haiven, 2007) argues that it is the task of activists, artists, cultural producers and public space intellectuals to struggle and to transform culture, to reinvent, restore and defend public spaces against dominant culture's misappropriation.

Combined with a social justice spirit, the author puts his faith into culture jammers to (re)take public spaces.

According to the author, 'this might be a very important experience in the sense that not only demands acts of imagination beyond those ascribed by the mainstream consumer culture, but also invites an imagination of the *public* [space] and forms by which learners can address and change it' (*ibid*, p. 107).

The turning point

All acts of *visual sabotage* require an array of techniques that contribute to a distinctive style that culture jammers use to reclaim authority from the original image-makers.

Within this, it is crucial to highlight the importance of graphic design in culture jamming since it is clear that the plurality of the techniques developed by jammers were borrowed also from this main field.

Some of the jammers, for instance, employ the knowledge of technicians to implement such complex plans as rewiring neon lights. Others, just use simple technical approaches as spray paint and wheat paste (Lamb, 2003).

Although the techniques and the aims that culture jammers employ are different one from another, the results, aesthetically combined, stand out, and are easily identified by anyone who is **not** a part of the counterculture.

Curiously, all of these techniques used to reclaim power and authority from the advertising agencies turn out to be identified by society and, in a way, to create a specific identification within certain individuals.

Today's culture jamming aesthetics: an investigation to understand the consumption of visual
resistance

This means that, inside the mainstream it is possible to identify individuals that, somehow, are also dissatisfied with society:

Interestingly, this style is gaining popularity in the design world as advertisements that imitate the style of subvertisements are winning awards in the advertising industry. Although both might consider their relationship to be parasitic, the ad industry and culture jammers actually share an odd symbiotic relationship. Jammers rely on the techniques of advertisement [...] while the ad industry has capitalized on the anti-ad hipness culture jamming promotes (Lamb, 2003, p. 31).

Through this perspective, I am able to affirm that the aesthetics of the counterculture are being used as part of a strategy of the dominant culture.

For Michel de Certeau (2010), 'strategies' are the main structures that characterize positions of power and attempt to force patterns over individuals: dominant culture, capitalism system. He defines strategy 'as a calculus of force relationships when a subject of will and power (a proprietor, an enterprise, a city, a scientific institution) can be isolated from an environment' (ibid, p. 19).

Within this case, the advertising is part of the strategies.

Nevertheless, while at the same time De Certeau explains the strategies that the dominant culture uses to maintain and keep control over society, he (ibid) also argues about the 'tactics', that is, the re-actions and answers from those without power: counterculture.

For the author, tactic 'it is dispersed, but it insinuates itself everywhere, silently and almost invisibly, because it does not manifest itself through its own products, but rather through its ways of using the products imposed by a dominant economic order' (De Certeau, 2010, p. 22).

Hence, while counterculture makes use of technique and practice developed by dominant culture to create its own visuality, visual communication agencies are being placed as an operator and the responsible for the commodification of culture jamming. I.e., the responsible to transform culture jamming into a mainstream product.

According to Kopytoff (1986), to commodify is to transform any service or object with no monetary value into a transaction that involves the exchange of value of an object for money.

In this sense, a commodity is a thing that turns out to have an economical value and that can be exchanged: 'Anything can be bought for money is at the point a commodity, whatever the fate that is reserved for it after the transaction has been made' (ibid, p. 69).

Not as fixed as a unitary status, commodification must be seen as a process of social transformation that involves a succession of phases and changes in status:

We can accept [...] that the human mind has an inherent tendency to impose order upon the chaos of its environment by classifying its contents, and without this classification knowledge of the world adjustments to it would not be possible (Kopytoff, 1986, p. 70).

From this perspective, Kopytoff (ibid) argues that the production of commodities is a cultural and cognitive process. This means, that commodities must not only be produced materially as things but also culturally marked as being a certain kind of thing:

The natural world of singular things must be arranged into several manageable value classes - that is, different things must be selected and made cognitively similar when put together within each category and dissimilar when put into different categories (ibid, p. 70).

Sarah Banet-Weiser⁹ defines the commodification of subculture as 'commodity activism'. In other words, the process by which social action is understood through the ways it is mapped onto merchandising practices, market incentives, and corporate profits.

For the author, there are different forms of commodity activism. The *Dove Real Beauty* campaign or the work of celebrities that represents causes such as *The Ice Bucket Challenge* are some of the examples:

Commodity activism can be an important form of social activism, **if the goals of such activism are not primarily organized around the accumulation of profit or building a corporate brand** (Banet-Weiser, ibidem).

9 <http://henryjenkins.org/2013/04/thinking-critically-about-brand-cultures-an-interview-with-sarah-banet-weiser-part-two.html#sthash.DcAE0BFu.dpuf>

The point to stress here is when the goal of commodity activism is **not** the activism itself. In these situations, she claims, commodity activism rather than challenge existing structures in social, economic and cultural realms, creates and sustain inequalities.

Debord (1968, p. 24), the most significant member of the Situationist movement, wrote: 'capital is accumulated to the point where it becomes an image'. Within this statement, the author expresses the idea that the relationship among society and images normalizes and standardizes a specific order of life in this context.

But, if we think the opposite of Debord's statement, we can affirm that images nowadays are being accumulated until the point where they become a capital.

Now, with that been said, it is possible to understand the re-signification process of counterculture's aesthetic into a strategy of consumption or, in a better sense: from a semiotical guerrilla warfare defended by Eco (1976) to a process of guerrilla marketing, carried out by current visual communication agencies.

OBEY the giants

Among all examples of commodification of culture jamming, *OBEY* is one of the most illustrative cases.

Just like Andy Warhol, the American designer Shepard Fairey started to create and spread, in 1989, stickers and billboards with the slogan '*OBEY The Giant*'.

These stickers were inspired by the image of the American wrestler André, The Giant, and even though the wrestler had no connection with Fairey, he turned out to be the iconic symbol of Fairey's work:

Outside the wrestling world, André was memorialized by Shepard Fairey in his sticker-campaign called '*André The Giant Has a Posse*' [...] which was an artistic effort to simulate a spontaneous cultural outpouring over André's iconic status.¹⁰

10 http://www.thegiant.org/wiki/index.php/Andr%C3%A9_the_Giant.

According to his manifesto, *OBEY*'s work is an attempt to stimulate curiosity and make people wonder about their environment and the dominant culture of advertising images and standardized beauties:

Because people are not used to seeing advertisements or propaganda for which the motive is not obvious, frequent and novel encounters with *OBEY* propaganda provoke thought and possible frustration nevertheless revitalizing the viewer's perception¹¹.

As the years went by and with a well defined visual style, Fairey started to extend his work to the mainstream culture. Particularly, Fairey (1) started to create his own clothing line, (2) designed visual communication for pop and rock bands and (3) created the visual identity for the American presidential political campaign of Barack Obama, in 2008.

Nowadays, Fairey may not be jamming the walls, but he is jamming counterculture's system. This means, he is transforming counterculture's aesthetic into a product. Fairey defends his position by saying that by using the aesthetic of counterculture his main goal is to criticize dominant culture - contradictory fact while being part of it.

Assuming this position, it is clear that Fairey is not producing a jamming and a commodity activism, but he is commodifying the aesthetics of a *sub world*. I say this not to criticize Fairey's work, but to understand his role in visual communication, in culture jamming, and in the commodification of countercultural aesthetics.

These new economic, political and social flows between the dominant culture and subcultures, that are expressed and developed with particular aesthetics, need to be investigated.

11 http://www.thegiant.org/wiki/index.php/Obey_Giant#History.

Today's culture jamming aesthetics: an investigation to understand the consumption of visual resistance



Figure 3 Shepard Fairey pasting OBEY billboards. Source: <http://www.thegiant.org/wiki/images/0/00/ObeyGiant.jpg>



Figure 4 Promotional image. Source: http://www.backyard-shop.com/img/blog/Obey__Streetwear_mit_Statement_1285.jpg

A further example can help to better understand the commodification of culture jamming: the Canadian magazine *Adbusters*. Despite being one of the most representative magazines related to counterculture movements, *Adbusters* magazine has demonstrated some changes in its discourse and position during the past few years.

Even though *Adbusters* characterizes itself as an activist and anti-advertising magazine, there is a contradictory fact that needs to be highlighted: the magazine has been 'tirelessly' promoting culture jamming to the mainstream, leading exactly against their main philosophy.

The section 'About us' in the *Adbusters* web page is one example of this paradoxical behavior:

***Adbusters* is a not-for-profit [...] magazine** concerned with the erosion of our physical and cultural environments by commercial forces. Our work has been featured in hundreds of [...] mainstream newspapers, magazines, and television and

radio [...] Adbusters is an ecological magazine, dedicated to examining the relationship between human beings and their physical and mental environment. **We want a world in which the economy and ecology resonate in balance. We try to coax people from spectator to participant in this quest. We want folks to get mad about corporate disinformation, injustices in the global economy, and any industry that pollutes our physical or mental commons¹².**

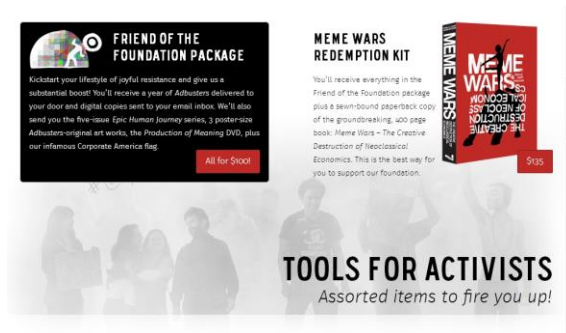


Figure 5 Adbuster's Culture Shop. Source: <http://subscribe.adbusters.org/>

It is almost impossible to 'get mad about corporate disinformation, injustices' if the Adbusters corporation is doing exactly the same: creating and selling products (kits and boots) to 'provide' jammers with 'better' tools.

So, insisting on an ambiguous and disconnected attitude, they avoid advertising although they do it with their 'brand'. 'The Adbusters jam represents the politics of the gesture in which revolutionary acts and culture jamming are prized for they own sake' (Haiven, 2007, p. 100).

Amanda Lamb (2003, p. 35) argues that meanwhile the difference between the aesthetic of a subvertisement and the one of an advertisement is narrowing, so is the gap between the individual who produces advertisements and the one who subverts them: 'Culture jamming has active recruitment techniques which appeal to professionals who work in the industry in order to persuade them to use their talents for a 'greater' cause'.

This trend happens in the framework of a dominant culture whose individual is now wearing a T-shirt with a political slogan against capitalism

12 <https://www.adbusters.org/about/adbusters.>

Today's culture jamming aesthetics: an investigation to understand the consumption of visual resistance
or is buying an expensive subverted poster that directly from the street is hanging on the wall of his house. About this kind of society Elliot states:

As people consume the commodities or image-objects of the spectacle they become part of the spectacle, making rebellion against is hard. Even the most radical gesture gets recuperated into the spectacle and turned into a commodity, negating its subversive meaning. It is a question not of elaborating the spectacle of refusal, but rather of refusing the spectacle. Everything becomes a commodity [...] Rebellion is sold back to us as an image that pacifies us (Elliot *apud* Lamb, 2003, p. 37).

From this point of view, it is possible to observe that unconsciously, these mainstream's individuals may be one of the agents that merge these two different fields, which rely over design activism: 'the term 'activism' is meant to emphasize design activism's kinship with political activism and anti-movements of various sorts: anti-capitalist, anti-global, and so forth' (Markussen, 2013, p. 1).

According to Markussen (*ibid*), design activism has been interpreted in the light of practices invented by certain art movements such as 'social interventionism' and 'community art'. For instance, it has been pointed out that the subversive techniques used in contemporary urban design activism draw more or less deliberately upon practices of art production that were introduced by the Situationists in the 1960s – the same techniques taken by jammers.

Furthermore, activists, jammers, visual artists and/or individuals are key part of current culture jamming. Each of them is using public space and design and arts techniques to express themselves against a system they believe is failing. It is important to observe and analyze their role, what and who specifically they are trying to reach with their statement and, moreover, if they carry out critical or aesthetical strategies to stimulate consumerism and not social changes.

Concluding remarks

It is clear that culture jamming appeared as a counterculture movement that fought against the control of advertising over public space. As a response to this 'invasion', culture jammers visually attack billboards aiming to subvert their meaning: by taking control again of the billboard, ripping it apart and pasting new parts, jammers' main objective is to refigure it.

With political and critical message, culture jammers have always been concerned to call the attention for the abuse of commercial images and 'the growing numbers of observers content that the dominant public of our time has shifted from citizen to consumer'¹³.

The mainstream culture is not concerned with social issues and values, therefore, culture jamming created an array of tactics that criticizes the brands and their images. Within this, jammers intend to make society aware of it.

Nevertheless, although nowadays we are able to continue to perceive jamming activities, we are also able to observe changes within it. One of these changes, for instance, relates to the jammer itself. I.e., some of the jammers are merging counterculture aesthetics with the mainstream.

Consciously or not, their aim now is not only to criticize dominant culture, but also to commercialize and bring their work to this level of production.

By doing this, jammers 1) Lose their political discourse which mislead to a consumerism attitude, 2) start to 'design activism' in clothing, objects and/or 'unique' pieces of art (once a street billboard) in international art galleries.

Within this scenarios, culture jamming turns out to be a commodity and the role of their actors tends to merge and/or blur. I.e., those responsible for the commodification process and aura loss (Benjamin, 1955) of culture jamming are jammers itself and designers as well.

Nowadays, in an unstoppable exchange of tools, practices and methods, jammers and designers occupy the same position regarding counterculture aesthetics. This means, jammers produce and design products while designers develop manuals, books and objects to improve this social movement.

Furthermore, it is necessary to wonder about the role of the jammer and the designer and also the flow between them. It is also required to question all the layers of cultural production, specifically because, by removing objects from their 'safe' ordinary context and remaking them (semiotic guerilla warfare, Eco, 1972), jammers and designers create a cycle of consuming-producing-consuming of images.

The dynamics of the jammer and designer are now similar.

Moreover, commodification process of culture jamming not only creates a new exchange of visual aesthetics but also affects their production,

13 <http://depts.washington.edu/ccce/polcommcampaigns/CultureJamming.htm>.

Today's culture jamming aesthetics: an investigation to understand the consumption of visual resistance especially, by being absorbed by mainstream areas such as art galleries, advertising, fashion, etc.

These changes also affect how society behave in front of subverted posters: once their aesthetic is absorbed by the dominant culture and transformed into a commodity, there is nothing unexpected or to criticize any more. Jamming turns out to be something 'normal' after a time.

If both, jammers and designers are merging their cultural production – subculture and dominant culture, respectively – it is hard to disagree with Haiven (2007, p. 107), who claims that 'culture jammers should assume the products of their work *itself* will have any substantial effect on the broader public. There will be extremely few who will walk by a jammed ad or billboard [...] and reevaluate global capitalism or their life practices' once it will be normalized and standardized from design field.

Maybe it does not matter how far at the margins a movement is located and how close to counterculture it. It is still under the umbrella of a mainstream system that, since it is part of our culture, it is impossible to get out of.

References

- Adorno, T.W. (1991) *The culture industry: selected essays on mass culture*. [Online] Available from: <http://www.public.iastate.edu/~carlos/607/readings/adorno.pdf> [Accessed: 25th May 2014].
- Argan, G. (1998) *Crise da arte, crise do objeto, crise do design*. [Online] Available from: http://documenta_pdf.jmir.dyndns.org/Argan.cidade_cap.17.pdf [Accessed: 17th May 2014].
- Benjamin, W. (1995) A arte na era da reprodutibilidade técnica. [Online] Available from: http://ideafixa.com/wp-content/uploads/2008/10/texto_wbenjamim_a_arte_na_era_da_reprodutibilidade_tecnica.pdf [Accessed: 19th October 2014]
- Calabrese, O. (1987) *A Idade Neobarroca*. Lisboa: Edições 70.
- Certeau De, M. (2010) *L'invenzione del quotidiano*. Roma: Edizioni Lavoro.
- Darts, D. (2004) *Visual culture jam: art, pedagogy, and creative resistance*. [Online] Available from: <https://steinhardt.nyu.edu/scmsAdmin/uploads/001/665/VisCultJAM.pdf> [Accessed: 19th October 2014]

- Debord, G. (1968) *The society of the spectacle*. [Online] Available from: <https://archive.org/details/TheSocietyOfTheSpectacle> [Accessed 20th October 2014].
- Dery, M. (1993) *Culture jamming: hacking, slashing and sniping in the empire of sign*. [Online] Available from: http://markdery.com/?page_id=154 [Accessed: 17th May 2014].
- Eco, U. (1976) *Towards a semiotical guerrilla warfare* [Online] Available from: http://www.kareneliot.de/downloads/UmbertoEco_Towards%20a%20Semiological%20Guerrilla%20Warfare.pdf [Accessed: 17th May 2014]
- Fuad-Luke, A. (2009) *Design Activism: beautiful strangeness for a sustainable world*. London: Earthscan.
- Haiven, M. (2007) *Privatized resistance: Adbusters and the culture of Neoliberalism*. [Online] Available from: https://www.academia.edu/1474860/Privatized_resistance_AdBusters_and_the_culture_of_neoliberalism. [Accessed: 25th May 2014]
- Hedbigge, D. (1979) *Subculture: the meaning of style*. England: Methuen & Co. Ltd.
- Hedbigge, D. (1999) *The function of subculture*. In During, S. (eds.), *The Cultural Studies Reader*. New York: Routledge.
- Kopytoff, I. (1986) *A social biography of things*. [Online] Available from: http://www.english.upenn.edu/~cavitch/pdf-library/Kopytoff_CulturalBiography.pdf. [Accessed: 17th May 2014]
- Lamb, A. (2003) *Pop will eat itself: culture jamming and the battle over corporate media control*. [Online] Available from: <http://www.utc.edu/departamental-honors/pdfs/lamba.pdf>. [Accessed: 17th May 2014].
- Markussen, T. (2013) *Design activism: enacting design between art and politics*. [Online] Available from: <http://www.nordes.org/opj/index.php/n13/article/viewFile/102/86>. [Accessed: 17th May 2014].
- Markussen, T. (2012) *The disruptive aesthetics of hijacking urban space*. [Online] Available from: <http://www.aestheticsandculture.net/index.php/jac/article/view/18157>. [Accessed on 20th October 2014].
- Moles, A. (2004) *O cartaz*. *Coleção 74*. Rio de Janeiro: Ed. Perspectiva.
- Önal, B. (2005) *Subvertising versus advertising: a semiotical analysis of the culture jamming act*. [Online] Available from:

Today's culture jamming aesthetics: an investigation to understand the consumption of visual
resistance

<http://www.thesis.bilkent.edu.tr/0003044.pdf>. [Accessed: 01th May
2014].

Sorge, J. (2012) *Pretty ugly*. Berlin: Gestalten.



Unpleasant Design. Designing Out Unwanted Behaviour

Gordan SAVICIC^{*a}, Selena SAVIC^b

^a Haut École d'Art et Design; ^b Instituto Superior Técnico/École Polytechnique Fédérale de Lausanne

Unpleasant Design is an aggregation of techniques and strategies in urban design where social control is an inherent property of objects and places. Unpleasant Design research recognizes the growing desire for controlled environments amongst different authorities but it also accounts for the way citizens react to it. Unpleasant Design is manifested in the form of 'silent agents' which manage the behaviour of people without explicit presence of officials. Unpleasant Design is principally about the relationship of space, design and social interaction. Thus, it is not aimed at harming users of public space in general. Unpleasant Design usually discriminates against particular social groups in order to allow for another to exist. These groups are not always threatening our security, they are sometimes simply a minority or powerless (the teenagers, the poor, marginal groups). We continuously look for qualifiers for something to act as unpleasant. Our data is an accumulation of field observations of deployed technologies; interviews with scholars and practitioners in the field of urban design. It also includes case studies of particular applications of Unpleasant Designs. Seeking to reveal power structures beyond surveillance and social control in designed interactions, we offer a critical perspective on emerging design patterns.

Keywords: *Unpleasant; design; behaviour; public space*

Introduction

The observation of *Unpleasant Design* implementations in our surrounding is an activity that came out of everyday experience with increasingly estranged urban spaces. From taking numerous photographs of benches, ledges, handrails and sidewalks we became more and more aware of current trends in urban furniture design and restrictive technologies in public space. We gathered a myriad of bench designs that prevent sleeping

* Corresponding author: **Gordan Savicic** | e-mail: gordan.savicic@hesge.ch

or long term occupation; stone patterns that were used as surface finish to prevent sleeping or even sitting on ledges, planters and under staircases; the increasing trend to equip continuous flat surfaces, including bench sides with anti-skating obstacles. After recognizing some basic principles, we extended the object of our study to all senses: lighting, sounds, ventilation systems, pavement structures and even the choice of particular plants became part of the speculation. We combined these with an observation of the demographic structure that was using these spaces.

For instance, the permanent illumination of hallways and corridors of social housing blocks throughout Dutch cities is an example of designing for particular audiences. Strongly illuminated throughout the entire night, there is very little activity to facilitate in its corridors. Illumination was used here to deter suspicious and unwanted behaviour that could easily occur in darkness (Narisada and Schreuder, 2004, p. 45). Such disowned corridors with low-income tenants are often prone to antisocial or even criminal behaviour (Newman, 1972). However, besides the need to create a 'defensible' space, there is an expectancy of a certain level of intimacy in a residential environment which this strong illumination works against.

Although disowned corridor design was found to be harmful for the community (Pruitt-Igoe iconic example) the problems of concentrated social disadvantage are much more complex and cannot be addressed only by the physical characteristics of a building (Lens, 2013).

The Nobel Prize winning author Ivo Andric describes such conflict with the illumination process in his 'Bridge over Drina'. The event revolves around a certain lantern, installed by the newly established Austro-Hungarian authorities at the end of the 19th century. The lantern was illuminating a spot on a bridge where people used to gather at night; sitting, talking, singing and smoking in darkness. By taking away the comfort of darkness, the authorities were not only aiming to modernize the old Kasbah but also discourage behaviour that would normally not occur in the light. Little by little, the residents got used to the lantern. Although it altered their behaviour slightly, as they became more aware of their actions and used to this new visual setting, the light didn't have a substantial impact at residents' night habits. This speculative description of an urban development is a symbolic starting point for our research in the complexities around *Unpleasant Design*.

Definition of Unpleasant Design

Unpleasant Design research examines the relationship between space, design and social interaction. It focuses on urban phenomena in which social control is inherent in the design of objects. This aggregation of design processes and tools is aimed specifically at making people uncomfortable or interfering with their use of public space. The implementations range from architectural interventions within the built environment, to electronic devices modifying and diffusing into our lived environment. *Unpleasant* implementations play a significant role in the way we perceive and engage with public space.

The applications vary from subtle implementations (such as the buzzing 'Mosquito' sound that puts off young people) to more radical and broader manifestations, such as Haussmann's reconstruction of Paris, to name a historical example. The latter allows for a speculative argument that the broadening of streets was intended to facilitate troop movement and prevent easy blocking of streets with barricades (Douglas, 2008; Jordan, 1995). Thus, the detailed physical planning executed a code of social conduct and can be clearly traced back to governmental interest in social control.

In our research, we look for qualifiers for something to act as *unpleasant*. The first to study are material structure and properties of unpleasant applications. Cold and polished surfaces or obfuscated edges allow to propose a taxonomy of objects which carry an *unpleasant* factor for human experience. Secondly, there are certain shapes that are recurrent. Oval and round shapes are found in urban structures preventing sleeping, sitting, littering, skating and similar activities. Finally, perhaps the most enlightening aspect is to look into subversion and misuse of these urban manifestations. Small interventions often reveal the immediacy of *unpleasantness* and emphasize its authoritative character. Dan Lockton states that the bottom line of unpleasantness can be determined by the designer him or herself – if they would not be happy being the recipient of their own designs, then the design is probably *unpleasant* (Savicic and Savic, 2013).

Unpleasant Design research takes account of so-called 'silent agents' that manage behaviour in public space, without the explicit presence of authorities (security, police etc.). These 'agents' are materialised in objects and installations which ensure that control is enforced in the environment; through the design of urban spaces, urban furniture and communication strategies. The 'silent agents' not only restrain unwanted use of space, but

also prevent interactions between the authorities and citizens. Leaving no space for discussion and disobedience, unpleasantly designed objects quietly prevent social disturbance or disorder.

Very often, *Unpleasantness* is an immediate reaction to a problem - added on top of existing structures to address a specific issue or unwanted behaviour. However, *Unpleasant Design* is developing in an integral direction, being at the centre of the design brief and not just an added function. Contemporary urban design discourse is increasingly centred around deterrent functions and less around physical comfort or creating a sense of place.

A perfect example hereby is the Camden bench, developed by Factory Furniture and recently installed at several locations in the London borough of Camden. After a history of problematic seating, the bench was designed to address 28 design issues when it comes to preventing unwanted use (Factory Furniture, 2013). These issues are communicated as 'contemporary street seating needs': to deter rough sleeping, drug dealing, bag theft, to reduce littering, easy to relocate, and so on. Such a list of contemporary seating needs assumes that contemporary urban design is more about prevention than encouragement and that marginal misuse is more likely to be in focus than major use. Additionally, it assumes a bad intention behind potential users, breeding a relationship of mistrust between designers, users and city councils. The fact that this design feature is at the front of product description on the Factory Furniture's website gives an idea about their interests and users they target with design.

This brings us to one of the main characteristics of *Unpleasant Design* strategies which is targeting specific social groups and acting at specific demographic layers. Teenagers, substance misusers and homeless people are frequently official reasons for unpleasant installations in public space. The language of *Unpleasant Design* is always ambiguous. It helps some while being less merciful to others. *Unpleasant Design* is not aimed at simply harming the users of public space in general. We all want our parks and streets to be pleasant. But in order to make them more pleasant for the majority of people, we have to make the space unpleasant for some marginal groups. These groups do not always threaten our security, sometimes they are simply a minority or powerless.

Finally, *Unpleasant Design* is characterised by a perverted user-centric approach. It treats the design object from an anti-user perspective, resulting in a design brief which examines restrictions as core design problems. As we have seen with the example of the Camden bench, its most important

feature is not usability (although designers claim it features more inclusive seating, encouraging social interaction; see Unpleasant Design Team, 2013b) it is unusability by clearly defined (mis)users.

From a historical perspective, the relation between designer and user has not taken this path before. We can trace the beginnings of usability and user-centred design to the post World War II period, with the study of design ergonomics and human-centred design research (Dreyfuss, 1960). The observation of potential positive influences of design on user experience was systematically pursued. With the introduction of ethnographic methods, the human focus was even more stressed, placing people in the middle of design (Koskinen et al., 2011). Contrary to this, *Unpleasant Design* places authority in the middle and makes sure people do not cross limits set by it.

While some *Unpleasant Design* solutions are employed by the city authorities, others are installed by corporate security and management systems. Very often, the borderline between the public and private interest isn't clear. In the past decades we can observe that governmental efforts to enhance public space have been replaced by private developers; transforming open space into privatized zones of interest (Francis, 1988; Minton, 2009). Through a collection of texts, photographs and designs, we aimed at recognising this nascent discipline within contemporary design taxonomies.

The language of Unpleasantness

As we have briefly suggested above, there are some overarching patterns to *Unpleasant Design* manifestations in the city. They could be most generally grouped into surface treatment, shape modifications (curves, angles or slopes) and sensory interventions (like light, sound, touch, smell). It is interesting to set this list against the list of elements identified by Whyte (Whyte, 1980) which constitutes a successful public space. According to Whyte, 'what makes a place work' is (1) sitting, (2) food, (3) retailing, and, in the case of indoor public spaces, availability of (4) toilets.

We will briefly explain each of Whyte's elements, thus setting the ground for *Unpleasant Design* to be introduced within them. One should note the fact that Whyte's research was conducted some 40 years ago, thus some ideological changes in the view of the role and desired character of public space exist. Nevertheless, many of his observations are quite contemporary and can be applied today as well.

Sitting

Sitting is the most important element for Whyte and it is easily attainable. 'People sit mostly where there is place to sit'. However, people also like to be able to choose where they will sit. Thus they will prefer a place that is more socially comfortable (close to other people or at a distance, with a preferably good overview of activity around) over simple physical comfort. 'What attracts people most, it would appear, is other people' (Whyte, 1980, p. 19). Sitting has to provide something to observe or participate in.

Food

Availability of snacks and fast food is a cause for, but also an effect of lively social life on the street. Street vendors of snacks and drinks recognise places that 'work', which in turn makes them even more popular.

Retailing

Shops and small services (sewing, knitting, shoe fixing, tourist services) are key continuous attractions in public space. They bring additional pedestrian flow while enriching the street front with diverse activities. Retailing for Whyte is an opposite of offices or banks which have a tendency to render the space sterile and estranged. He argues for turning commercial spaces on the pedestrian level into a mandatory zone for retail.

Toilets

According to Whyte, the existence of toilets has a considerable effect on people's shopping patterns. Toilets act as yet another attraction within the pedestrian walking path, both indoor and outdoor.

As we have discussed already, the intention behind *Unpleasant Design* is to make places functional for certain kinds of audiences. The problem of *Unpleasant Design* is exclusion. This is how *Unpleasant Design* targets its anti-audience.

The sitting problem

Each of Whyte's key aspects of sitting in public space is addressed by *Unpleasant Design*. Firstly, it is possible and confirmed in practice to remove seats from public space altogether. For example, the Camden bench was commissioned after the council repeatedly denied the public from sitting in the streets and squares of the borough, by removing public benches. With

reduced quantities of sitting places, the sitting choices are qualitatively impoverished as well.

Contemporary urban seating is often arranged in distanced configurations. They end up being too close for people who don't sit together and too far for the ones who are engaged in a conversation. This is one of the proofs social comfort is usually the smallest concern when *unpleasantness* is designed into an otherwise functional object.

A central armrest is another feature with an impact on social comfort. Besides preventing rough sleeping, it assigns each person on the bench a specific amount of space and puts a limit on possible sitting configurations on the bench.

Waved surfaces are another link in the chain of inventions around public benches. Not only does it make it uncomfortable to sleep on, it renders the surface dangerous for skaters.

The food problem

One of the consequences of people's presence on the streets, especially when they are eating in public, is littering. To address this problem, city authorities would normally put up bins in most frequented streets and squares. These bins became a target themselves for concentrated litter, often overfilled or used as a surface to leave garbage. Thus, the new bin design in many cities includes a very small opening for throwing articles in while the top is curved or inclined to prevent anything from being put there.

The retailing problem

A well known side effect of popularity of retail streets are posters and commercials. They are usually glued to dedicated surfaces, outgrowing this space quickly when no control is imposed on them. What typically works against this phenomenon is a rippled surface finish that deters sticking and gluing to such a surface. It is often applied on garbage bins and traffic poles (Unpleasant Design Team, 2013a). Other examples of unpleasant surfaces include rich graphical patterns which make tags and scribbles hardly noticeable. Berlin metro seating is covered with such patterns, while windows are decorated with an ornament representing Berlin's landmark, the Brandenburg Gate. While most people would think that this is a touristic emphasis, it was actually deployed to discourage glass etching by graffiti taggers.

The most unpleasant surface to touch are handrails coated by sanding paper-like lacquer. A speculative interpretation of this measure is that it is

used to prevent suicides (Unpleasant Design Team, 2011b). Found on a very tall bridge in Vevey, Switzerland, this material is supposed to discourage the jump, when the contact with the railing is designed to be utterly unpleasant.

The toilet problem

Public toilets are a contested topic, often rendered dysfunctional by inappropriate use and maintenance. Because they provide basic privacy, they are a known target to drug addicts who use them as a hideout.

Different city authorities deal with it differently; some provide a trash bin for syringes nearby, some install particularly coloured lights to render veins invisible. Blue neon lights were successfully used in public bathrooms and publicly accessible toilets (BBC News, 2003). Because veins are harder to see, it is expected that drug users will stop using these bathrooms for the aforementioned purpose.

Expanding Whyte's observations

Other examples of light use are as interesting. For instance, the Japanese Keihin Railway company experimented with blue lights at metro stations to prevent suicides. Triggered by high rates of suicides and supported by some psychological experts, these installations are supposed to have a calming effect on people (Demetriou, 2009; Saldaña, 2011). While blue light in this case targets people in a particular state of mind (at the edge of committing suicide in impulse) a resident's association in Mansfield, UK used pink lights against the contested problem of teenage loitering (BBC News, 2006). Whether or not the reasons for this speculative measure were justified, the lights supposedly highlight skin blemishes (a technique traditionally used by beauticians (Robinson, 2009)) thus targeting the whole generation of people whose hormones are changing with puberty.

Another biological characteristic of young people is target to other forms of unpleasant inventions. A high frequency buzz (17,4KHz) is employed to keep away teenagers from gathering in shopping malls, street corners, courtyards and to prevent so-called 'anti social behaviour'. 'Mosquito', as this device is called, targets specifically the population under the age of 25 due to their hearing abilities. Unlike their older cohabitants, the young population should be able to hear the repelling sound buzz at 5 dB above background noise levels (Unpleasant Design Team, 2011a).

Extending unpleasant applications to technology, contemporary surveillance techniques deserve some attention. Simple video surveillance systems are enhanced with facial recognition and motion tracking,

rendering extraordinary discrimination possibilities. The discriminatory practices developed in CCTV operator rooms (Graham and Marvin, 2001) was in this way integrated in CCTV systems to target and track specific individuals by the colour of their skin or the way they walk. The latter is particularly addressed by gait recognition technique, using satellite imagery to recognize and trace a person by the way they walk (Sanders, 2002).

Procedures and findings

Every design process, both from a technical and from an aesthetic perspective, is ideological (Dunne and Raby, 2001). Hence, its features, structures or methods of operation, in which a user interacts with it, can be controlled. Our exploration of the *Unpleasant Design* phenomenon often took the form of observations in public space, recording the way it affected users and the way users attempted to overcome it. We took numerous photographs of these sites and grouped them into categories depending on the senses they affected and behaviours they typically addressed. Finally, we came up with two general groups: 'devices' and 'objects', determined by the kind of agency they exert over the users. Devices are systems that are able to broadcast or record information which can be used to condition people in public space. Different light and sound installations as well as surveillance systems described above belong to this group. Objects are installations, interventions and adaptations of regularly found urban furniture which discourage particular uses and misuses. Benches are most often target to such interventions, or a complete redesign. Obstacles are often used against skaters. Surface treatment can address posters and stickers, suicide or high heels.

Early on in our study, we encountered similar initiatives that shared their collections on blogs and web pages (Dan Lockton's *Design With Intent*, Survival Group's *Antisites*, etc.) with great examples of *Unpleasant Designs*. Some also set up solid taxonomies. What began to interest us then, was an overall strategic view of the development of *Unpleasant Design*; is there or can there be something like a school of thought for '*unpleasantness*'? Who prescribes *unpleasantness* to spaces, and who receives it? Who is profiting from it the most and which groups are mostly its targets?

To learn more about these questions, we conducted an interview series with scholars, experts, artists and designers who were in some way knowledgeable about *Unpleasant Design*. Dan Lockton, a scholar researching application of persuasive design for social and environmental

benefit, talked about potential uses of *Unpleasant Design* solutions for behavioural change. Yasmine Abbas, a researcher particularly interested in 'neo-nomadism' elaborated on challenges people with a mobile life style have to face in contemporary urban environment and to what extent they can contribute to places. We also interviewed people who can be identified as '*Unpleasant Designers*'. Designers who are actively involved in coming up with *Unpleasant Design*, restrictive and persuasive artifacts. From Factory Furniture, a design office based in London, we learned about their design process, restrictions they encounter and sources of inspiration.

An insightful way to identify *Unpleasant Design* is to look at resistance techniques used by its target social groups, urban activists and citizens in general. Through direct contact with some of these groups we learned about their strategies and points of view. We then poured these findings into a call for participation in a design competition, for which we received several intriguing submissions.

In our research of *Unpleasant Design*, we tried to go beyond cataloging and collecting existing designs. We also decided not to focus on designing counter-unpleasant applications. Instead, we decided to try a psychological technique of role-playing to better understand the underlying tactics and recipes for unpleasantness. We applied this approach at a series of workshops we taught, using *Unpleasant Design* to discuss more general questions about reclaiming public space. The role playing technique relies on our ability to imagine and act out behaviours that are not always in line with our own point of view. While playing a role, we put ourselves in the shoes of the other and imagine what they would do in a particular situation.

In our case, we imagined various roles; we switched between city counsellors and real estate developers, from conservative citizen associations to senior residents. Those protagonists would act against a certain social group or behaviour that had a particularly harmful impact on our activities.

Conclusions

With *Unpleasant Design* tools we can address some of the issues that arise around the management, control and sharing of public space. To a certain extent, unwanted behaviour can be 'designed out'. However, the cold mechanism which lies behind these agents might play well on turning the problem invisible, but will fail in solving the root of the problem in the long run. They only address the consequences (homelessness) and not the

root (career break, domestic violence, substance misuse, psychological problems, etc.) (Shelter England, 2014).

To the contrary, as the research of Dan Lockton shows, it is more sustainable to promote positive behaviour by design (Lockton, Harrison and Stanton, 2012). This was already clear to Whyte, who argued for a kind of spatial self-regulation, or the simple presence of people to discourage suspicious and undesired behaviour (Whyte, 1980, p. 63).

Historically, we can recognize two parallel intellectual traditions in thinking about management and use of public space. They are two opposing forces in the 'battle' for safe and pleasant space. On one hand, we have the writings of Jane Jacobs, promoting a network of voluntary controls amongst people themselves (Jacobs, 1961). On the other hand, it is the feeling of ownership amongst neighbours that leads to well managed, and defensible places (Newman, 1972). The principal difference between these traditions is their view of strangers. In Jane Jacobs' opinion, the presence of strangers on the street promotes normality and reduces suspicious behaviour. Newman on the other hand describes strangers as uninterested to contribute to places thus possibly the protagonists of suspicious behaviour themselves. They so become a legitimate target to *Unpleasant Designs* and the like.

From these two reference points to today, we can observe a change in discourse about public space and what it should stand for. When we look at the language of *'The Social Life of Small Urban Spaces'*, it is clear that the idea of accessibility and equity in public space has changed, inclining towards more restrictive and discriminative policies. Today, it is accepted in practice and theory that one has right to design for particular social groups, that the shopping malls have the right to protect themselves from loiters and the poor (the non-clientele) and that 'irrational' use of public space (sitting too long, or even worse – sleeping) is absolutely a no-go. This wasn't as black and white in the past as mixed use of spaces was considered a positive sign – it meant that the space served its democratic purpose – all people. Although Whyte's view of homeless and poor can be considered somewhat benevolent, his points of view and recommendations for developers were adopted by the city planning councils.

When social incompatibilities occur, *Unpleasant Design* addresses them in a persuasive manner. We should acknowledge that design outcomes depend largely on target users. The perceived level of coercion depends on perceived level of control (Savicic and Savic, 2013). Dan Lockton believes *Unpleasant Design* is usually unaware of its outcome. 'In the same way that someone who puts out mousetraps to kill house mice doesn't necessarily

'hate' mice, someone who puts spikes on a wall to stop people sitting there doesn't necessarily 'hate' people. There's a problem, and they're trying to solve it.' (Savicic and Savic, 2013).

Unpleasant Design is mostly the industry response to the current situation, aiming at getting us to the preferred situation through a shortcut. The artifacts are not particularly considered from a design perspective. With this text we have tried to trace its outputs and give a structure to the growing body of *Unpleasant Design* examples. We hope this will contribute to *Unpleasant Design* knowledge. Whether the effect of *Unpleasant Design* is positive for public space or not, knowledge in this field will contribute to better informed decision making on the side of city authorities, as well as citizens.

References

- BBC News (2003) *Blue light to stop drugs-users*. [online] BBC NEWS. Available at: http://news.bbc.co.uk/2/hi/uk_news/england/cambridgeshire/3147170.stm. [Accessed 6 Jan. 2012].
- BBC News (2006) *Pink lights show up spotty youths*. [online] BBC NEWS. Available at: http://news.bbc.co.uk/2/hi/uk_news/england/lancashire/6197652.stm. [Accessed 8 Jan. 2012].
- Demetriou, D. (2009) *Blue lights installed in Tokyo train stations to stop suicides*. [online] The Telegraph. Available at: <http://www.telegraph.co.uk/news/worldnews/asia/japan/6578256/Blue-lights-installed-in-Tokyo-train-stations-to-stop-suicides.html>. [Accessed 17 May 2014].
- Douglas, C. (2008) Barricades and boulevards: material transformations of Paris, 1795-1871. *Interstices: A Journal of Architecture and Related Arts*, 8 (1), 31-42.
- Dreyfuss, H. (1960) *The measure of man: Human factors in design*. Hoboken: John Wiley & Sons.
- Dunne, A. and Raby, F. (2001) *Design Noir: The Secret Life of Electronic Objects*. Bsel: Birkhäuser.
- Factory Furniture (2013) *CAMDEN Bench | Factory Furniture*. [online] Available at: <http://www.factoryfurniture.co.uk/products-camden-bench.php>. [Accessed 7 May 2014].

- Francis, M. (1988) Changing Values for Public Space. *Landscape Architecture*, 78 (1), 54-59.
- Graham, S. and Marvin, S. (2001) *Splintering urbanism: Networked Infrastructures, Technological Mobilities, and the Urban Condition*. London: Routledge.
- Jacobs, J. (1961) *The Death and Life of Great American Cities*. New York: Random House.
- Jordan, D.P. (1995) *Transforming Paris: the life and labors of Baron Haussmann*. New York: Free Press.
- Koskinen, I., Zimmerman, J., Binder, T., Redstrom, J. and Wensveen, S. (2011) *Design research through practice: from the lab, field, and showroom*. Waltham: Morgan Kaufmann/Elsevier.
- Lens, M.C. (2013) Subsidized Housing and Crime: Theory, Mechanisms, and Evidence. *Journal of Planning Literature*, 28 (4), 352-363.
- Lockton, D., Harrison, D. and Stanton, N.A. (2012) Models of the user: designers' perspectives on influencing sustainable behaviour. *Journal of Design Research*, 10 (1), 7-27.
- Minton, A. (2009) *Ground control: fear and happiness in the twenty-first-century city*. London: Penguin Books.
- Narisada, K. and Schreuder, D. (2004) *Light pollution handbook. Astrophysics and Space Science Library*. New York: Springer.
- Newman, O. (1972) *Defensible space; crime prevention through urban design*. London: Palgrave Macmillan.
- Robinson, O. (2009) *Mansfield residents tackling gangs of youths with pink lights that show up spots*. [online] This is Nottingham. Available at: <http://www.thisisnottingham.co.uk/Putting-squeeze-teens-spot/story-12196483-detail/story.html>. [Accessed 22 Dec. 2011].
- Saldaña, M. (2011) *Tokyo's 'Human Accidents': Jinshin Jiko and the Social Meaning of Train Suicide*. [online] Anthropology Honors Projects. Paper 10. Available at: http://digitalcommons.macalester.edu/anth_honors/10. [Accessed 22 Dec. 2011].
- Sanders, J. (2002) *Gait recognition could identify humans at a distance*. [online] Available at: <http://gtresearchnews.gatech.edu/newsrelease/GAIT.htm>. [Accessed 17 May 2014].
- Savicic, G. and Savic, S. (2013) *Unpleasant design*. Belgrade: G.L.O.R.I.A.
- Shelter England (2014) *What causes homelessness? - Shelter England*. [online] Available at: http://england.shelter.org.uk/campaigns/why_we_campaign/tackling_ho

melessness/What_causes_homelessness#_ednref3. [Accessed 7 May 2014].

Unpleasant Design Team (2011a) *The mosquito device | un-pleas-ant de-sign·*. [online] Available at: <http://unpleasant.pravi.me/mosquito/>. [Accessed 17 May 2014].

Unpleasant Design Team (2011b) *Unpleasant to touch | un-pleas-ant de-sign·*. [online] Available at: <http://unpleasant.pravi.me/unpleasant-to-touch/>. [Accessed 17 May 2014].

Unpleasant Design Team (2013a) *Anti-sticker ripples | un-pleas-ant de-sign·*. [online] Available at: <http://unpleasant.pravi.me/anti-sticker-ripples/>. [Accessed 17 May 2014].

Unpleasant Design Team (2013b) *Interview with Factory Furniture Design Team*. [online] un-pleas-ant de-sign·. Available at: <http://unpleasant.pravi.me/category/research/interviews/>. [Accessed 7 May 2014].

Whyte, W.H. (1980) *The Social Life of Small Urban Spaces*. New York: Project for Public Spaces Inc.

When Human Body Meets Technology: The Designer Approach to Wearable Devices

Venere FERRARO*, Matteo O. INGARAMO

Politecnico di Milano

The huge impact of emerging technologies has been changing population's capabilities (physical, sensorial and cognitive) and lifestyle (works, leisure, living and social interaction).

Currently there is a great inclination to modify sport and well-being concept by changing the technology in 'wearable'. Wearable technology represents a potentially large and rapidly increasing research and development area, involving several cross-disciplines such as biology, physiology, physics, chemistry, micro-nanotechnologies and material sciences, industrial sectors like medical devices, electronics, microchips, textile, telecommunications and engineering disciplines. Such devices can perform functions such as sensing, communications, navigation, decision-making or actuation.

The paper will describe an approach that is the result of a combination between different approaches (design thinking, participatory design and ergonomics). The effectiveness of such an approach is shown through case studies. The text will picture the role of technology in human body changing and perception, the ergonomics, the wearability issue for a better approach in designing wearable devices, a succession of inspirations for new products and that can be interesting for designers because it brings people and their experiences together at the core point of an innovative approach.

Keywords: Paper format; instructions; use of template

Introduction

Wearables refer to a class of devices really integrated in daily life, used all the time, wherever the user goes. There is an important distinction to be made: wearable has to be actually *worn*, and not just carried or held. A wearable needs to both work and look good and be worn in the same way

* Corresponding author: **Venere Ferraro** | e-mail: venere.ferraro@polimi.it

the user wear clothing in order to achieve the paradigm *anytime, anyplace, by anyone* (Marculescu, 2003).

Although there is a wide range of commercial wearable devices there are few products, which truly become ubiquitous and accomplish end-user real needs.

User doesn't really understand the advantages of wearing such a device and mainly he feels uncomfortable and perceives a sense of alienation wearing it. This happens because wearables are not thin, flexible, adaptable, attractive and appropriate for housing the body yet. In order to become wearable in the same way of a t-shirt or pants, they have to be designed to be *worn on the body*.

The expression wearable device refers to electrical or mechanical systems, which are worn on the human body by means of incorporation into items of clothing, or as an additional apparatus, which is fixed, by straps or harnesses.

This kind of device is made up of 'wearable' sensors. Wearable sensors and systems are defined, as wearable sensors/actuators and sensor-based communicative systems that can monitor and/or stimulate, and/or treat, and/or replace biophysical human functions.

Due to the intimate interaction between technologies and human body, the mobile electronic devices has created the potential for wearable technologies which are mostly embedded into garments or accessories that function constantly and are worn comfortably on the body. Although wearable technologies are seen as solutions to create a more comfortable usage of technology, the designers should approach embedding technologies on human body in different levels which are both physical and social.

Starting from the human and spreading to the society, the wearables should be taken as interfaces which are not only the most intimate artefact to the human body but also the first surface which they are in contact with others and the environment. While filling the gap between technology and human body, wearable technology also introduces new social concerns, as it can mediate the ways in which a person is perceived by others, interacts with others, and manages his/her own physical space.

Besides, new technologies simulate body functions and strengthen the organic features. Clothing and prosthesis are instruments thanks to which body redesigns itself. For this reason the wearable should be not an overlapping structure or close architecture but an enveloping film, 'a second skin'.

The human which is the main actor of the social life is now surrounded by numerous technological devices which enable him to connect, discover and learn in every condition and place.

The contact with digital technologies changes human body. It becomes a fluctuant body, which crosses the border and enlarges its perception. Technology that invades the body transforms the clothes, accessories and ornaments. The body's limits dissolve and it becomes expression of the technologies.

'Wearable Computing' as a technology deals with computer systems worn as unobtrusively as clothing.

The development of a wearable requires a study on placing objects on the human body with regards to mass, size, shape, mechanical properties.

In the design of wearable device the main issue to face is wearability that literally means ability to wear and concern the physical shape of wearables and their active relationship with the human form. Designer has to address the big challenge to shape the technology in a desirable and acceptable way for the user. For these reasons it is necessary to create a shared language thanks to which designer is able to communicate with researchers coming from the relevant areas of expertise. He has to understand the complexities of such a class of products and have the skills to talk with competence with a disparate mix of background involving ergonomics, textiles, manufacture, engineering, medicine.

Technology and human body

Today the technological progress has extended the capability of the senses of the human being, that moves towards a stimulation and extension of the sensoriality. Sensorial experience has become now an integral part of whatever type of planning that involves technology. The universe of machines, of ICT and of biotechnology has produced new ways to perceive the surrounding reality and the frenetic development of science, strengthened by technological application, has given life to new and unexpected scenarios and possibilities. The development of medical science in the field of bioengineering, of aesthetic surgery and biogenetics, has brought into question the own organic nature of the human being, paving the way to the advent of a hybrid being with inedited characteristics, technologically characterized. In this point of view the body becomes the surface to interpret, to sign, and appears as a construction, resulting from a project, fruit of a strategy: being a artefact.

Clothes, products that we wear, become prostheses of the skin, of its seductive and communicative power. In this way is not clear anymore where the body ends, or which barrier distinguishes the diversity. On the surface goods meet biology and anatomy.

The body itself becomes always more technological: from the wearable computer of 'intelligent clothes' to the incorporated computer (display on the retina). The body becomes by itself expression and representation of innovative images and functions through technology.

The continuous technological development brought to the birth of the wearable that, being a construction surrounding the body, on the body, of the body, should be really as a second skin.

By being a second skin wearable device destabilizes the barriers between body and clothes and becomes cloth, while the cloth, textiles and objects become more and more similar to the body and imitate its characteristics of portability.

Technology has always had a role in extending capabilities in work, leisure, social and recreational events, and in our journey into, through, and from these worlds. We live in an era characterised by new media, low-cost computing power, client server architecture, miniaturisation, and high volume data storage. In this new scenario, technology exists in interaction with their surroundings and can't be anymore considered as an isolated aspect.

The development of always more sophisticated technologies, guaranteed by the vertiginous progress of science in the fields of transmission of information on one side, in the field of bioengineering and biogenetics, and in general of medical science applied to the manipulation of the individual, has comported a real and proper perturbation of the constitutional dimensions of the human existence.

The human being assumes individuality deeply influenced by technology because media has permeated its natural barriers with the external world.

In a constant flow of information that determine human being essence, the corporal container reevaluates itself through technology itself, in pursuit of new standards of perfection and uniqueness, what ends up resolving itself only through forms of homologation.

The body becomes a working machine that tents to the world of prostheses, and to instruments that dilate the moving, manual, intellectual capacities and its senses.

It is a body to reconsider and by consequence all what has been in contact with it, is deemed to evolve always more towards a system of

corporal prostheses, able to elaborate data, and to supply services. The clothes and accessories are always more populated by bits able to guarantee our wellness, our health, to represent us and to make us communicate easily (W. Whitman: body electric).

These changes have a deep impact on designing wearable technologies and have to be faced through an user centred approach because it makes designer aware of user needs. Designers have to take in account of how to avoid potential sense of alienation towards technology that requires to be converted in product requirements by meeting user expectations.

Hereafter with the term needs authors will refer to the set of goals, purpose and objectives of end-user. Understand, meet and analyse user needs in design process means to answer questions such as:

- Who is the final user (gender, age etc..)?
- In which contest the product will be used?
- What do users want to accomplish using the product (requirements and features)?
- What are their overall goals?
- What do users need from the system to accomplish these goals?

The approach to wearable devices

When designing wearable technologies to understand the needs of potential users/consumers become crucial.

Wearable devices as a technology deal with computer systems worn as unobtrusively as clothing. As such, wearables further effect the person's interaction with his own body bus also with the world.

Consequently technology has to be shaped by consumer choices also in term of social impact, for example workers wearing special glasses with a screen attached to them get a different perspective on their surroundings and as a consequence they treat it differently and behave in it in a different way.

In this sense, in order to succeed in wearable field, researching user needs, (in term of requirements of the final product) and focus on social impact by insisting on a human centric design is essential.

This is an approach typical of the user centered design (UCD) a design philosophy where the end-user's needs, wants and limitations are a focus at all stages within the design process and development lifecycle. Products developed using the UCD methodology are optimized for end-users and

emphasis is placed on end-users needs and expectations from the final product. (International standard ISO 13407)

In an UCD approach, users appear as the ultimate experts, those who can properly assess design prototypes, propose changes, and ultimately, integrate end-products within their routines. For many years product designers have been aware of how important users are within the design process. Incorporating the 'wearer' into the design process will be essential for designing appropriate wearable systems, which are acceptable to people outside the 'wearables' community.

Young designers need to know an approach, which is able to identify the right relationship between the user and the wearable device, especially in the project with features, such strong social value, use of innovative materials and technologies, and finally significant impact on quality of life.

Creating wearable computers that fit well on people's bodies is not easy to do. This is because our bodies are soft organic shapes and are constantly moving. The internal components to any computer contrast that with hard rectilinear shapes. Resolving this conflict between human bodies and computer components takes some work but it can be done. The development of the wearable device design needs to accomplish the requirements of comfort and adaptableness connected to the anatomy of human body. To focus on end-user's needs designer has to look at the relationship between design and the body, addressing the implications of anatomical features shape, physiology and psychological impact wearables.

For a design methodology to claim that it is inclusive or universal it must address the real requirements of the body from the outset not design for the technology then place it in a softer shell. It is the impact of our anatomy on our shape more correctly termed morphology and consequent physiological effects as a result of our environment (whether that is a building, the outdoors or our clothing) and what we do there, that affects our needs and us. Anything a designer does should take into account our anatomy and its impact on our physiological needs. The form follows the function is a principle associated with modern architecture and industrial design in the 20th century. The principle is that the shape of a building or object should be primarily based upon its intended function or purpose. This classic phrase 'form follows function' is very well known in design, but its origins are essentially from biology. If we look at the body, we can see that form follows function. The knee allows movement only in one direction. I can flex and extend, whereas a more mobile joint like the shoulder allows for greater movement; but with that comes a greater vulnerability it is more

likely to dislocate than the knee. Looking at the inter-relationship between the body and smart clothing or wearable technology is an essential part of the design process, not just in terms of fit but of how the wearables affect the body's ability to function. To fully understand the needs of the end-user, in the field of wearable devices, a designer should have some knowledge of human movement and of human physiology. It is also important to recognise that a sport or occupation can affect the body; indeed, that wearing anything can affect our function and, a longer period, lead to physical changes in our body. These aspects require a study about the ergonomics and 'wear' 'ability'.

International Ergonomics Association (2000) provides the following definition:

Ergonomics (or human factors) is the scientific discipline concerned with the understanding of interactions among humans and other elements of a system, and the profession that applies theory, principles, data and methods to design in order to optimize human well-being and overall system performance.

Therefore, the study of the anthropometric measures of the human body and of the equilibriums between the various zones of the body, becomes essential. The other issue to deal with is 'wearability'. Wearability literally means ability to wear and concern the physical shape of wearables and their active relationship with the human form. All the kinds of design is around the man, his physical and psychical abilities, his limits and necessities, and the type of activity he has to face. Every time, the user is the starting point of a project. In this field much more than in all design processes these aspects get necessary and fundamental. The study of the anthropometric measures of the human body and of the equilibriums between the various zones of the body, becomes essential. The target is to define the interaction between the human body and the wearable object, by trying to figure out a flexible shape without interfering with human motion. Wearable products need to fit the three-dimensional shapes of the dynamic human body. A designer has to design a wearable computer, which is able to fit the human body and designing the component placement on a printed circuit board to meet the complex and organic shape of the computer shelter. The goal is the exploitation of the device as a natural and consolidated form of contact between the body and the object. In this case the interface is expressed as a place of exchange of physical information moving from one place to another. Inserting the device in a common context, like clothing, the

function of monitoring becomes more understandable because the user reacts in a usual way. Also, it is possible to have continuous and long-term contact between the body and the clothing. The aspects that complete a wearable system with the necessary characteristics are principally focused on the dimensions of the body part and the user, with notable individual and cognitive variables. The brain perceives the presence of the sensors much more than the body, and such perception is modified according to multiple reasons, tied to the physical state and the development of the body. This perception is also associated with variations in dimensions and form so the human body is taken as a whole in order to create the accessibility of the object on it. Designing a wearable system needs to find inspiration from the human body, in respect of the many ways that form follows the function. Designer's objective is to achieve an 'anatomically correct design'. A wearable is a second skin for the human body, a protection shell, a housing that changes body shape. The wearables fix body silhouette inhibiting or making easier movements and postures through ergonomic and enveloping shapes. The target is to define the interaction between the human body and the wearable object, by trying to figure out a flexible shape without interfering with human motion. It's fundamental for a product in close contact with human body to be totally adaptable to human anatomy. From this point of view, the wearable is not an overlapping structure or close architecture but an enveloping film, 'a second skin'. A wearable needs to be designed to be worn on the body according to the principle the form follows the function.

The Institute for Complex Engineered Systems (ICES) developed a study about this topic, 'Design for Wearability', by outlining a design guideline for wearable products. The wearability parameters set by the Institute of Complex Engineered System (ICES) are:

- formal language: the way the different shapes blend with each others;
- size: cross section variation of human body;
- human movement: the way the form of body changes with simple motion;
- unobtrusivity: body areas less obtrusive for wearable products.

They also found the most unobtrusive areas for wearable objects: collar area, rear of the upper arm, forearm, rear, side, and front ribcage, waist and hips, thigh, shin, and top of the foot (see figure 1).

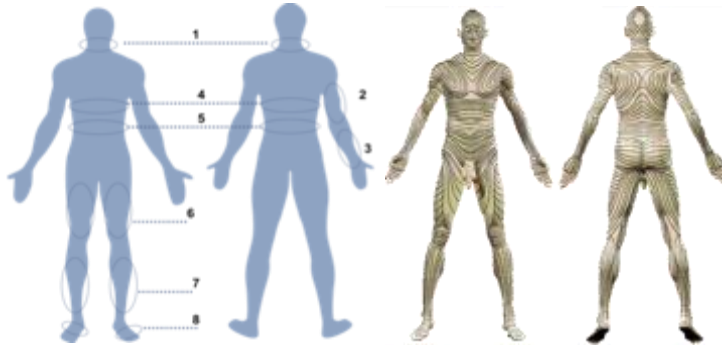


Figure 1 *Ri-elaboration of unobtrusivity areas by Gemperle at al. (left) Langer's Lines (right).*

Starting from these studies we have identified a surgical theory, which provided a scientific approach to wearables. We believe that the identification of design guidelines could be improved by matching the unobtrusive areas with Langer's Lines. A Langer line, called also *cleavage lines*, is a term used in medical field to define the direction within the human skin along which the skin has the least flexibility. The direction of these lines is very important for surgical operations.

Surgeons during operation cut the body in the direction of Langer's lines, because these types of incisions generally heal better and produce less scarring (see figure 1 on the right).

A user-needs driven design methodology is proposed. It addresses a breadth of technical, functional, physiological, social, cultural and aesthetic considerations that impinge on the design of clothing with embedded technologies, that is intended to be attractive, comfortable and fit for purpose for the identified customer. If a product does not look good or work, the customer will not be satisfied. Form embraces aesthetic concerns and the importance of respecting the culture of the end-user, and Function embraces the generic demands of human body and the particular demands of the end user or activity. In order to aid decision-making, the design process requires an overview of the profile of the target customer in terms of gender, age group, and an indication of the proposed category of smart textile product to be developed. Successful wearables design is the result of designers becoming thoroughly conversant with the culture, history and tradition associated with the particular end-use or range of activities. A design that is considered attractive for a wearer from one community or age group may be totally unacceptable for another. Concerns social and cultural

issues, historic context and tradition, corporate and work culture, participation patterns and levels, status, demographics, and the general health and fitness of the wearer will impinge on the design of smart clothes and wearable technology. An investigation of the lifestyle demands of the wearer, in terms of behaviour, environment and peer group pressure is needed to provide an awareness of both clothing requirements and the application of emerging wearable technologies that have appropriate functionality and true usability for the identified user.

This is an approach typical of design thinking 'a creative human-centered discovery process followed by iterative cycles'. In other words, design thinking is human-centered innovation. Design Thinking has been considered the quickest organizational path to innovation and high-performance, changing the way creativity and commerce interact (Brown, 2008)

Design thinking shapes the design process in five phases but the core objective is to gain empathy with and identify the specific needs of individuals (e.g., Kembel, 2009).



Figure 2 Design Thinking approach.

Nobody can design without paying attention to user needs. For this reason concepts should be realized, (prototype, mock-up, three-dimensional or computer model) if the need is truly fulfilled, the design is legitimately evaluated, and the design activity have been purposeful and worthwhile.

According to the authors a designer can approach a wearable using design thinking approach and applying to the project development two useful tools:

- Unobtrusive areas found by Carnegie Mellon
- Langer Lines

Case studies

Hereafter three projects developed in a workshop by students of Master Degree in Fashion Study at School of Design of Politecnico di Milano will be described. The projects showed the application of the approach described by the authors.

1. A safety suit for kids
2. A t-shirt for runner
3. A shirt to practice box.

The students were asked to design an advanced product for sport and or safety exploiting the potentiality of wearable technology.

All the project were developed following the design thinking approach and using the guidelines to achieve wearability:

Understand: Students carried out an analysis to figure out needs and requirements from the end-users. All the projects were developed just in four weeks so they had limited time for the ethnographic research. The teachers (authors of the presented paper) suggested to carry out a preliminary bibliographic research and then to interview at least ten persons. The interviews were framed through a questionnaire with the aim to understand the profile of the user for whom the project would have been designed (men, women, babies, runner, amateurs, boxeurs etc..) the purpose (safety, self-improvement, training, competition, self-motivation) and the occasion of the use.

Define: After the analysis of the context and the interviews they set the product requirements (brief) and check with users they interviewed if those requirements met their expectations.

Ideate: A brainstorming session helped students to develop their idea. They designed both the device taking in account body shapes and unobtrusive areas.

Prototype: Students were asked to create a mock-up in order to show the wear-ability of developed projects. Making a real prototype gave them the ability to immediately test and see the results during the design process while trying the prototypes on their own bodies. Indeed because of lack of time they could not test the results on the final user.

1. A safety suit for kids.

With this product students wanted to respond to parents needs to live the holidays at the seaside serenely and happily. In summer, when little kids try to learn how to swim, parents are always afraid of hazardous situations.

Parents need to be sure that their baby is safe in every moment. With the interview the students understood that the user in this case was both the parents and the baby. Indeed, the product consists of different interactive devices.

The first item is located inside the baby's swimsuit and it consists of two piezoelectric sensors placed in a specific band at the base of the breastbone. Isolating silicon protects them. Their function is to monitor the heart rate, estimating the little mechanical stresses, and the respiratory frequency, evaluating the variation of chest's circumference. The values, gathered by the sensors, are transmitted through Bluetooth technology to a waterproof solar bracelet and eventually to a smart device (as smartphones, tablets) with a specific application. The bracelet emits sounds and vibrates in case of emergency (not normal values), while a buzzer, integrated in the swimsuit, emits an acoustic signal as an alarm.

Another inserted device is a GPS receiver, placed in the same band of other sensors that recognize the baby's location when activated using the specific application. The location data transmitted can be displayed on a map in the application. Finally following the unobtrusive area they placed the entire electronics component on the ribcage.



Figure 3 Safety suit.

2. A t-shirt for runner

The t-shirt here described was designed for runner amateur and especially for those users who need motivation to do exercise. In this case study, some students of the group represented the users.

They designed a t-shirt with a portion made up of LED lights with the purpose to light up progressively according to the amount of calories burned, gradually displaying a predefined colour on the fabric.

They created an article of clothing that also comes with a world of services behind it, starting from a dedicated area on the brand's website that will serve as a tracking record of the progresses made so far by the user, keeping track of the miles run and of how many calories they have burned in addition to showing how much of the led colour present on the article of clothing they have 'unlocked' up to this point.

The colour will, at first, be common to all clothes but, once fully completed, the customer will be able to unlock another one and download it into the device present in the clothes by plugging it into their computer and syncing it with their account. This way the colours will not only be a mean of auto motivating oneself, but also a way to show others how much progresses they have made so far (social impact)

The t-shirt is realized with a removable device that's easy to recharge and makes the garment easy to clean. The whole is able to track how many km users have run and how much kilocalories they have burned, comparing those info with other runners in the same area.

The product was designed with different layers:

- philips' lumalive:
- led fabric that can display a vast arrange of color gradation
- lightweight enough not to be a hyn drance when running
- thin silicon strips printed onto flexible materials that will measure metabolism and performance using embedded sensor

In the development of the product and the realization of the mock-up they were smarts and placed the 'technology' not only following the langer lines but also along the stitching.



Figure 4 T-shirt for runners.

3. Boxing t-shirt for beginners

Through the analysis of box sport and the interviews students understood that due to the speed of the training, one of the problem notified during the box training is the capability of recognize the exactly place where the punch has been done. The identification of the punched areas is an important aspect because some of them are forbidden. So, they developed a t-shirt with light system and pressure sensors. Through a pressure system the t-shirt changes colour in the specific area in which you punch it. The aim of the t-shirt is to help the boxer to improve his/her skills during the training.

The pressure sensors are sewed within the fabric on front of the t-shirt. The graphic of the garment helps to identify permitted areas and to avoid the forbidden one. The training starts by switching the circuit. T-punch design was thought to be fully wearable. Indeed the printed layer of Elastolite is designed following the natural curves of the body, allowing and facilitating the movements during the sport activities.

When human body meets technology: the designer approach to wearable devices

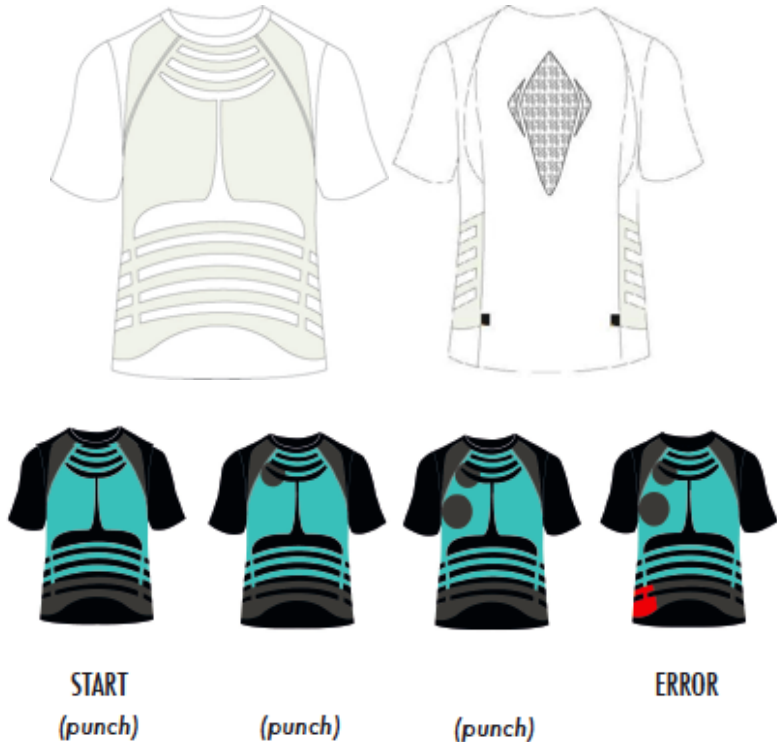


Figure 5 T-punch shirt.

Conclusions

While emerging technology is rapidly getting intimate to the human body in shape of various electronic devices, wearable technology can be a medium to facilitate the integration. The designers of the future technologies should consider the fact that human body is not a singular being but exists with its surrounding and its inner system. To bridge the gap between in and out, wearable technologies can provide solutions where technology is not any more arisen with a hard cover, but as flexible displays on the human body. By giving the intelligence to our garments, they could behave as covers, which obtain an optimum behaviour and increase the quality of life. Therefore, in this experimental study we observed that user

centred design approach could help the designers to better understand the needs of user, whose behaviour is influenced by emerging technologies.

Combining user needs with social needs can bring new perspectives to the role of technology in daily life. The nature of innovation changes: the sphere of technologies and forms bends with sphere of signifies and experiences. Designer, which is a bridge between the technology and the user in order to create user-friendly interfaces, needs to consider the social, cultural and personal changes. By keeping the user in the centred and doing research about social trends and how society is changing designer should be able to generate solutions not only tangible like new aesthetical look, but also focus on intangible values which are felt by experiencing. He needs to be aware of how to turn negative side effects of technology into positive ones, designing more human friendly interfaces and products.

References

- Brown, T. (2008) Design Thinking. *Harvard Business Review*, 86 (6), 84.
- Gemperle, F., Kasabach, C., Stirovic, J., Bauer, M. and Martin R. (1998) Design for Wearability. Paper Presented at the Proceedings of the 2nd IEEE International Symposium on Wearable Computers.
- Kembel, G. (2009) *Awakening creativity*. [online] Available at http://fora.tv/2009/08/14/George_Kembel_Awakening_Creativity, accessed June 28, 2012. [Accessed: 31th December].
- Marculescu, D. (2003) Electronic textiles: A platform for pervasive computing. *Proceedings of the IEEE*, 91 (12), 1995-2018.

Per una sperimentazione materica postdigitale. Oltre i bits, i nuovi atomi

Chiara SCARPITTI*

Seconda Università degli Studi di Napoli

Il contributo proposto riguarda la nuova possibilità che il designer ha di mescolare mondo digitale e mondo materiale e di tracciare un punto di vista nuovo sulle pratiche costruttive della progettazione contemporanea. A metà strada tra un'elaborazione digitale dell'artefatto e uno studio materico sull'oggetto fisico, l'obiettivo è quello di rispondere alla necessità di una esplorazione diversa del digitale, che considera anche gli aspetti estetici, poetici e antropologici delle tecniche e dei materiali che esso adotta.

Riguardo al futuro di questo nuovo scenario prasseologico, una delle sfide progettuali più interessanti sarà quella di indagare materiali e tecnologie digitali secondo una sensibilità empatica che mira a riflettere sulle loro qualità percettive al fine di ampliarne il senso. Si tratta in pratica di lavorare sul digitale per mezzo della materia, miscelando la cultura materiale con la cultura digitale, che è in grado di offrire incessantemente nuove informazioni e possibilità connettive. Questa prassi progettuale, tutta ancora da esplorare, suggerisce una fusione organica tra materiale e immateriale, che supera la nozione classica di digitale e al contempo oltrepassa i confini materiali dell'oggetto. Gli esiti di tale commistione transdisciplinare, potranno condurre all'elaborazione di teorie innovative, modelli organici e processi ibridi, concepiti a loro volta come strumenti per la comprensione di nuove pratiche e conoscenze.

Keywords: *Digitale; postdigitale; materia; processi produttivi*

Introduzione

La sua capacità di tessere relazioni fa del Design una disciplina del tutto originale e anti settoriale in grado di cogliere le potenzialità inesprese ai confini dei singoli saperi e i connubi possibili che si celano tra i territori separati delle conoscenze.

* Corresponding author: **Chiara Scarpitti** | e-mail: chiarascarpitti@gmail.com

In questa direzione transdisciplinare, il design si fa strumento per l'esplorazione di nuovi modi di costruire artefatti, elaborare progetti, ibridare pratiche.

Quest'approccio sensibile e multiforme del design, indice di una più atavica complessità legata alla natura dell'uomo e delle cose che lo circondano, è espresso efficacemente in numerosi scritti di Branzi attraverso la metafora del pulviscolo, privo di unità e confine, manifesto riflessivo di una natura umana anch'essa imprevedibile e indecifrabile. 'Il mondo degli oggetti è l'effetto evidente di un'energia produttiva policentrica, debole e diffusa, che non costruisce cattedrali, ma produce un plancton dinamico, una linguistica fatta di miti e di decori' (Branzi, 2005 p. 153).

In linea teorica, dunque, con questa caratteristica di relazionalità il designer si profila essere un operatore intermediario, che si pone in una sorta d'incrocio interdisciplinare, tra capacità progettuale, conoscenza dei materiali e dei processi e usi del digitale. L'interconnessione tra mondi fisici e mondi digitali attraverso il progetto definisce dunque una nuova possibilità del fare design, più contemporanea e quanto mai necessaria. Una modalità che indaga il digitale con gli strumenti della materia, può collocarsi in questo senso a metà tra luogo di elaborazione teorica dell'artefatto e spazio per una nuova esplorazione del progetto, intesa come possibilità d'indagine sperimentale ibridante.

Infatti, se da un lato la materia, con le sue possibili trasformazioni e modellazioni, offre al progetto sensazioni tattili e interazioni corporee, dall'altro, le nuove tecnologie digitali, con le loro capacità espressive, rendono fruibili tutta una serie di modalità di visualizzazione altrimenti ignorate.

Con lo sviluppo di questi intrecci operativi è possibile, dunque, scorgere una nuova dinamica del progetto, scandita da un doppio binario temporale: da un lato un tempo lento, più conforme al ritmo dell'uomo e dei processi naturali, e dall'altro, un tempo veloce più vicino alle tecnologie digitali e ai flussi della comunicazione cibernetica.

1. Internet of Everything: uno scambio tra reale e virtuale.

Negli ultimi decenni le nuove tecnologie digitali hanno introdotto nuovi modi di lavorare all'interno del sistema produttivo e hanno profondamente modificato i luoghi, i tempi, le interazioni con le persone.

A testimonianza di questo cambiamento epocale, nell'aprile del 2012,

Per una sperimentazione materica postdigitale. Oltre i bits, i nuovi atomi

l'Economist dedica una copertina proprio a quest'ondata tecnologica, intitolandola *The Third Industrial Revolution*. L'immagine raffigura un uomo che, in maniera autonoma, progetta e produce direttamente dal computer, comodamente seduto a casa. Sopra e intorno a lui, una moltitudine di aerei, città, fabbriche, oggetti di ogni genere, a simboleggiare le possibilità infinite della nuova rivoluzione digitale.

Questo cambio di paradigma nella relazione tra l'uomo e gli oggetti, è rafforzato ancor di più dallo sviluppo del web, che nei prossimi anni vedrà il passaggio dall'*IoT (Internet of Things)* all'*IoE (Internet of Everything)*.

Nell'*IoE*, che in alcuni casi è già realtà, convivono il mondo umano, quello naturale, quello dei dati e il web in un'unica esperienza di vita. 'The Internet of Everything (IoE) brings together people, process, data, and things to make networked connections more relevant and valuable than ever before — turning information into actions that create new capabilities, richer experiences, and unprecedented economic opportunity for businesses, individuals, and countries' (Cisco, 2013).

Ma, oltre alle opportunità economiche e creative dell'*Internet of Everything*, uno degli aspetti più interessanti è lo spostamento di valore che passa dagli oggetti fisici, in sé definiti, alle relazioni, sempre aperte, che collegano l'intera rete, tra cyberspazio e realtà fisica. Il design, immerso anch'esso in questa dimensione relazionale così complessa, si trova a compiere così un nuovo percorso di ricerca, mescolando digitalità e materialità, realtà intangibile e oggettualità concreta.

Una testimonianza di questa nuova pratica operativa è ad esempio il progetto formativo, nato nel 2013 come Master di Primo Livello, che s'intitola *Relational Design*. Il master *Relational Design*, il cui sottotitolo è 'progettare per un mondo in costante mutazione', oltre a dichiarare con forza nel proprio manifesto di studi l'importanza del termine relazione, pone più volte al centro del suo programma i concetti di transdisciplinarietà e transmedialità.

In questo nuovo progetto culturale, guidato dall'Accademia Abadir di Catania e da Stefano Mirti, curatore e docente torinese di design contemporaneo, la capacità di collegare mondi fisici e al contempo digitali è intesa come una nuova e fondamentale competenza per il designer del futuro, tant'è che l'intero progetto è costruito su di una fitta rete di collaborazioni tra imprese, designer, studiosi, in luoghi diversi, secondo una doppia modalità di fruizione online e offline

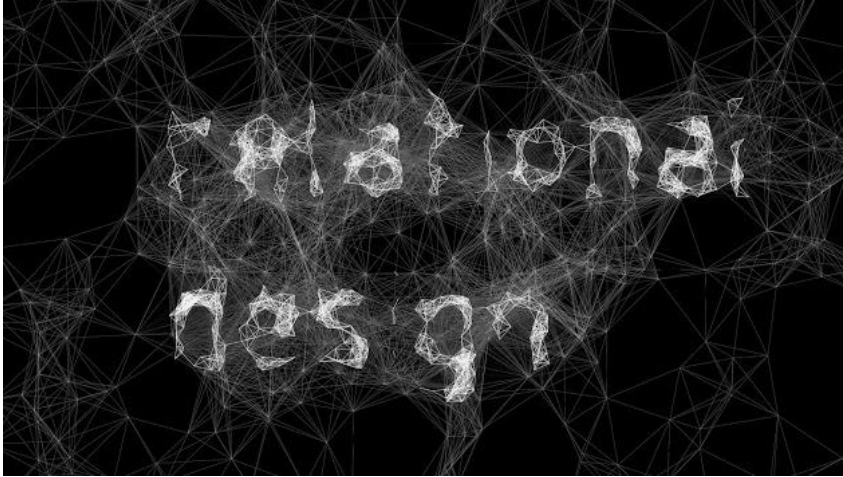


Figura 1 logo del Master Relational Design. Available from: <http://www.relationaldesign.org>. [Accessed: 10th April 2014].

1.1 Dal digitale al postdigitale

Se dunque il XX secolo era l'epoca della produzione materiale degli oggetti, come si configura il secolo attuale? E, se la materia fisica si ibrida sempre più con una componente digitale, quali sono le nuove modalità attraverso cui l'uomo trasforma il mondo e lo plasma?

Reale e digitale si stanno sempre più unendo in un'unica nuova realtà, che assorbe integralmente le nuove tecnologie digitali e fonda se stessa a partire da questa nuova mescolanza ibrida. La graduale digitalizzazione sta coinvolgendo sempre più l'intero macrocosmo e inizia a includere, di fatto, anche la sfera delle scienze naturali. E' chiaro che parlare unicamente di 'digitale', suona un po' come trattare una nozione che la società attuale ha già metabolizzato e assorbito in un momento storico precedente. In una visione futura, quando l'*Internet of Everything* sarà realtà effettiva e l'elettronica avrà ormai permeato tutto ciò che ci circonda, il digitale sarà considerato requisito naturale.

Nicholas Negroponte, autore del bestseller planetario *Being Digital* e fondatore del prestigioso *Media Laboratory* di Boston, è stato il primo a parlare di un superamento del digitale. 'The Digital Revolution is over... Like air and drinking water, being digital will be noticed only by its absence, not its presence... Computers will be a sweeping yet invisible part of our

Per una sperimentazione materica postdigitale. Oltre i bits, i nuovi atomi
everyday lives: We'll live in them, wear them, even eat them.' (Negroponte, 1999).

Nell'ultimo decennio, l'espressione è stata usata anche in ambito artistico, a indicare diverse correnti di ricerca che adottavano tecnologie analogiche, antecedenti al digitale, insieme a quelle elettroniche, attraverso un uso consapevole dei media e un recupero di una dimensione materica.

‘La parte più rilevante dell'arte neotecnologica, cioè quella legata alle tecnologie digitali, sembra ormai trovarsi a un punto di svolta, e tutto fa pensare che la produzione artistica stia entrando in una fase postdigitale, o postelettronica’ (Bolognini, 2008 p. 7). Con queste motivazioni, nel 2008 Maurizio Bolognini pubblica il libro *Postdigitale* che, mediante una serie d'interviste, compie una riflessione critica sull'uso innovativo dei nuovi media da parte delle ricerche artistiche più avanzate.

Tuttavia, recuperare alcune tecniche o strumenti risalenti all'origine del digitale e rielaborarli in chiave critica, in relazione alle tecnologie contemporanee, non significa guardare nostalgicamente al passato. In una logica lontana da un uso compulsivo e aspecifico della tecnologia di massa, il postdigitale fa un uso critico dei media, per meglio comprendere il presente e immaginare il futuro.

1.2 Oltre i bits, i nuovi atomi

Nel libro *The Future of Art in a Postdigital Age*, Mel Alexenberg definisce il postdigitale come una forma d'arte che ‘address the humanization of digital technologies through interplay between digital, biological, cultural, and spiritual system, between cyberspace and real space, between embodied media and mixed reality in social and physical communication...between visual, haptic, auditory, and kinesthetic media experiences...through participation, interaction, and collaboration’ (Alexenberg, 2011, p. 11).

Anche in questa definizione, l'ibridazione tra realtà concreta e dimensione elettronica è tangibile, così come l'esplorazione di territori biologici, legati al corpo umano e ai sistemi naturali. Un esempio chiarificatore di questa contaminazione tra digitalità e materia ci è suggerito dalla designer israeliana Naomi Kizhner, che nel 2013, ipotizzando uno scenario futuro dove scarseggiano le risorse energetiche, ha progettato dei dispositivi che sfruttano l'energia del corpo umano per la sopravvivenza. Mischiando oro, biopolimeri e conduttori elettrici, questi nuovi oggetti, innestati nella pelle, sfruttano l'energia elettrica presente nel nostro corpo e invitano una riflessione sulle possibilità d'interconnessione tra digitale e biologia.

Da un lato, infatti, il digitale è assorbito completamente dalla realtà fisica e acquisito come parte integrante, trasformando la materia in qualcosa di ibrido. Dall'altro, alla luce della nuova convergenza scientifica NBIC (Nanotechnology, Biotechnology, Information Technology, Cognitive Science), il digitale invade sempre più il dominio delle scienze naturali.

Attraverso lo sviluppo di oggetti interattivi, delle macchine biologiche, attraverso la modifica della materia fisica, mediante la nanotecnologia, e degli organismi viventi, mediante la genetica e le biotecnologie, tutto sta cambiando. Già nel 2004 Negroponte presagiva un 'cambio di stato della materia', attraverso il passaggio 'dagli atomi ai bits' (Negroponte, 2004 p. 4), ma ora e nel futuro prossimo, ci troviamo di fronte a un'ulteriore evoluzione. Esempi di questa evoluzione sono oggetti interattivi in grado di modificarsi in base all'ambiente circostante, robot che iniziano a muoversi come esseri umani, parti del corpo artificiali che funzionano grazie a componenti elettriche.

Diverse sono le mostre proposte in passato che analizzano questa dicotomia tra materiale e digitale, col fine di tracciarne un racconto organico e non inconciliabile che metta in relazione questi due mondi. Per ricordarne solo alcune, citiamo: *After the Bit Rush: Design in a Post Digital Age* a cura di Unfold e Lucas Maassen tenutasi ad Amsterdam nel 2011; *AnalogicoDigitale* a cura di Stefano Maffei e Stefano Micelli esposta durante il Salone del Mobile di Milano nel 2012; *Audhocracy* a cura di Joseph Grima tenutasi a New York nel 2013; *Out of Hand: Materializing the Postdigital* esposta presso il MAD Museum di New York nel 2013.



Figura 2 Energy Addicts. Naomi Kizhner. 2013 Available from: <http://www.dezeen.com/2014/08/06/naomi-kizhner-energy-addicts-jewellery-human-electricity-production/> [Accessed: 7th August 2014].

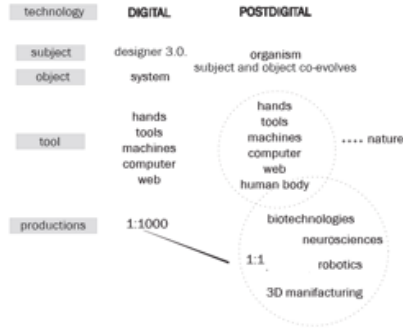


Figura 3 schema elaborato dall'autore come studio del passaggio verso il postdigitale.

1.3 Per una rivalutazione della materia nelle pratiche costruttive digitali

Nell'era postdigitale ogni cosa può essere uno strumento, dall'aria che si respira, alla luce, al suono della voce, alle onde cerebrali, agli organismi biologici. Mediante le nuove tecnologie, corpo umano, natura e materia si uniscono, creando una miriade di nuove possibilità esplorative. A supporto di ciò, nel 2013 Kevin Kelly scrive il libro *Cool Tools – A catalogue of possibilities* nel quale, sotto una miriade di categorizzazioni differenti, tra cui materiali, tecniche, attrezzi, vestiti, sostanze chimiche, cibo, piante, fenomeni naturali, illustra alcune modalità interessanti per la trasformazione della realtà, ciascuna con un link di riferimento al web. 'A third industrial revolution is stirring - the Maker era. In this era the digital is embodied by the physical, producing a hybrid of intense virtuality embedded in high-tech physicality, a new matrix for civilization' (Kelly, 2013, p. 3). Il libro, dalla grafica pop e coloratissima, sembra un'agenda di ricerca personale su cui ad ogni pagina sono annotate informazioni utili, immagini ritagliate, link interessanti. Tutto è alla portata di tutti, tra tecnologie digitali e manuali, in una visione di condivisione universale delle innovazioni e delle nuove pratiche del DIY-Do It Yourself.

E' in questa prospettiva che una riflessione critica riguardo al significato della materia, e alla sua manipolazione all'interno di un processo digitale, sembra essere un passaggio imprescindibile. La cultura materiale può, infatti, aiutare il design a comprendere meglio la sovrapposizione tra materiale e digitale, attraverso uno studio delle dinamiche percettive ed estetiche della realtà fisica.

Attraverso la cultura materiale si accede spontaneamente a una comprensione più profonda del progetto, della sostanza di cui è fatto, delle forme che lo compongono. Un tipo di comprensione, che se fosse lasciata allo strumento esclusivo del digitale, sarebbe impossibile. 'Il tattile, il relazionale e l'incompleto fanno parte dell'esperienza fisica che si vive nell'atto manuale di disegnare. Il disegno simboleggia una gamma di esperienza più ampia...così come l'atto del suonare uno strumento, l'esplorazione all'infinito delle misteriose qualità di un certo accordo. Il difficile e l'incompleto dovrebbero essere eventi positivi nella nostra attività intellettuale; dovrebbero stimolarci, come non possono fare la simulazione e la manipolazione digitale facilitata di oggetti già completi'(Sennett, 2008 p. 50).

Il principio estetico e compositivo d'indeterminatezza che contraddistingue la parte umana delle cose e che contiene in sé i criteri d'imprevedibilità, imperfezione, viene in questo senso sempre più adottato come linguaggio estetico in grado di ibridarsi e rafforzare il significato dei mezzi digitali adoperati.

Un esempio che va in questa prospettiva progettuale di materializzare l'immateriale e di rendere visibili le clouds di dati che avvolgono le persone, le cose e la realtà intera che ci circonda, è il progetto Ready to Cloud, presentato al Fuori Salone del Mobile di Milano del 2013. Il progetto transmediale, a cura di Susanna Legrenzi e Stefano Mirti, più che esprimere un modello chiuso, invita a una riflessione nuova e parallela all'interno di due realtà temporali diverse, la materialità delle cose e l'immaterialità della rete. Il progetto ambiva a restituire fisicamente agli spettatori l'immagine di nuvola cibernetica, di rete iper-connettiva, attraverso la creazione performativa di una nube vera e propria di vapore acqueo nelle strade della città in precisi luoghi e orari, come una metafora dei flussi invisibili del web.

L'evento è interessante nella misura in cui ha saputo cogliere con sensibilità l'immaginario estetico del digitale, provando a metterlo in relazione con la materia fisica dell'acqua, e creando un'occasione di riflessione sul rapporto tra reale e digitale, in una logica di design-fiction poetica e affascinante. 'The most difficult challenges for designers of electronic objects now lie not in technical and semiotic functionality, where optimal levels of performance are already attainable, but in the realms of metaphysics, poetry, and aesthetics...'. (Dunne, 1999, p. 20) Come sostiene Antony Dunne, è necessario che il design risponda a un'esplorazione diversa del digitale, attenta anche agli aspetti poetici e antropologici delle tecniche e dei materiali digitali che adotta. Il design prova ad andare oltre la tecnica,

Per una sperimentazione materica postdigitale. Oltre i bits, i nuovi atomi per pensare al progetto nella sua interezza e al messaggio che desidera restituire alla società. L'essere stesso del nostro corpo fisico all'interno del processo tecnologico, crea un'innumerabile serie di possibilità esplorative, che generano un circolo virtuoso d'innovazione inaspettata. L'intelligenza tecnica si sviluppa anche attraverso la facoltà dell'immaginazione, che però è facilitata da un tempo più lento di riflessione e da un insieme di pratiche sperimentali che usano anche la materia fisica per esprimersi. Riguardo al rapporto con la materia, l'antropologa Eleonora Fiorani scrive 'la partecipazione ad essa è un modo di integrarci alla natura, al mondo delle cose che noi stessi abbiamo costruito. E' rimembranza della materia prima, di cui siamo fatti. Il suo carattere utile di materiale e il suo ruolo simbolico sono veicolo di socializzazione, luogo della costruzione delle strutture sociali, motivo d'infinita narrazioni.' (Fiorani, 2000, p. 14).

Ma questa sensibilità non ritorna romanticamente a un uso tradizionale della materia, così com'è, ma piuttosto la reinventa, attraverso un'ibridazione ingegnosa delle nuove tecniche manifatturiere e processuali.

E' in questo senso che il processo postdigitale può configurarsi come un sistema aperto di scambio, dove fare e pensare coesistono. In un'ottica di ri-significazione del digitale, il designer può compiere, quindi, un percorso sperimentale di ricerca molto interessante. All'interno di quei confini sottilissimi che dividono il visibile dall'invisibile, l'energia dalla materia, il reale dal virtuale, il software dall'hardware (Dunne, 1999. p. 17), il progetto può farsi portavoce di una rinnovata istanza materiale.

References

- Alexenberg, M. (eds.) (2011) *The Future of Art in a Postdigital Age*. Bristol: Intellect Press.
- Anderson, C. (2010) *In the Next Industrial Revolution, Atoms Are the New Bits*. [Online] Archivio WIRED Magazine. Available from: http://www.wired.com/magazine/2010/01/ff_newrevolution/all/1, accessed 4 June 2010. [Accessed: 15th April 2014].
- Bolognini, M. (eds.) (2008) *Postdigitale. Conversazioni sull'arte e le nuove tecnologie*. Roma: Carrocci.
- Branzi, A. (2005) *Il declino degli oggetti*. In La Rocca, F. (eds.), *Il tempo opaco degli oggetti*. Roma: Franco Angeli Editore.
- Cisco (2013) *Internet of Everything*. [Online] Available from: <http://www.cisco.com/web/tomorrow-starts-here/index.html>. [Accessed: 15th April 2014].

CHIARA SCARPITTI

- Dunne, D. (eds.) (1999) *Hertzian Tales. Eletronic Products, Aesthetic Experience, and Critical Design*. Cambridge: MIT Press.
- Fiorani, E. (eds.) (2000) *Leggere i Materiali*. Milano: Lupetti Editore.
- Kelly K. (eds.) (2013) *Cool Things. A catalog of possibilities*. Hong Kong: KK Publisher.
- Negroponete, N. (eds.) (1998) Beyond Digital. [Online] *Archivio WIRED Magazine*, 06.12.1998. Available from: <http://archive.wired.com/wired/archive/6.12/negroponete.html>. [Accessed: 5th April 2014].
- Negroponete, N. (2004) *Essere digitali*. Milano: Sperling & Kupfer.
- Sennett, R. (2008) *L'uomo artigiano*. Milano: Feltrinelli.

SECTION V

New and Responsible Socio- Technical Paradigms



Anticipating and Responding to Challenges Regarding Digital Technologies and Valuing

Barbara ANDREWS^a, David HAKKEN^{*b} and Maurizio TELI^c,
^a Cultural Practices; ^b Indiana University; ^c University of Trento

This paper draws on the premise that the current economic crisis is mainly a crisis of ideas about values, value, and processes of valuation. We articulate our perspective as of a theory of these things that is able to support the investigation of digitally informed social practices pre-figurative of new forms of social formation reproduction. Locating ourselves in dialogue with ethnological theories of value(s), we show how an articulation of nominal, ordinal, and ratio values allows us to see the distortion consequent to the market-based dominance of ratio forms of valuation as one of the key aspects threatening social life.

Drawing upon traditional Marxian accounts of value and STS, these perspectives give a new sense to the distinctions among use value, exchange value, general value, and surplus value. We point to contemporary Marxist thinking as a source of inspiration, particularly its ability to stress concepts like freedom, love, and struggle, as key values in rebuilding the common and the commons.

Keywords: Valuation; digital technologies; commons; devices

Introduction

This paper contributes to clarifying the human values challenges and opportunities related to Digital Information and Communication Technologies (DTs). It is part of a book project, tentatively entitled, *On Value(s) and the Making of Cyberspace: Common Devices?* currently before the Routledge Press US Editorial Committee. The project presumes that it should be possible for humans to build an alternative future by supporting expanded use of digital technologies that have certain specific, chosen social affordances. The book and this paper draw upon STS (Actor Network Theory in particular) and neo-Marxist theories.

* Corresponding author: **David Hakken** | e-mail: dhakken@indiana.edu

Our fundamental contention is that values and valuation practices are central to the social change we humans need. More specifically, among the steps necessary to pursue our program is to identify values that 1) reflect actual digital practices that, if taken together, 2) could provide the basis for deeply transforming current social formation reproduction, if 3) fostered via alternative valuation processes. For our purposes in this paper, we also take as given the idea that current social reproductive arrangements are hopelessly contradictory and have no long-term future.

Here we wish to focus on a series of STS-based theoretical clarifications that explain why value(s) are important to our project. We want to engage and clarify the ongoing critique of contemporary practices regarding value, values, valuing, and 'valuing.' This critique has been prompted by efforts to come to terms with new forms of labor emerging in digital practices (e.g., playbour) as well as the widely perceived need to overthrow neo-liberalism's reductive focus on markets as *the* source of value(s). A second impetus concerns social program alternatives to neo-liberalism, like current discussions of the social economy and efforts to establish commons and use commons-based concepts and practices. We leverage the work done in the social sciences on common pool resources, commons-based peer production, and the common. Third, we offer a critique of framings of the relationship between values and digital things that are put strictly in terms of the consequences for values of digital technologies, and a reframing in STS terms of co-construction, that complement this with attention to how social practices of valuation frame DTs. Here we model our work on Michel Callon's concept of devices (et al. 2007), although we shift away from market devices to non-market, often common, devices. Finally, we clarify why there is a pressing need to move beyond the critique of current social formation dynamics likely to foster ever-expanding degrees of crisis and to see a new approach to values as a central enablers of alternative futures.

Our book goes on to explore how this theoretical shift could and should lead to a renewed set of human values aligned with certain digital technology uses. But that is not in the scope of this paper.

The Critique of Current Valu(es)ing Practices

We begin by attending to a feature of current 'valuing,' namely the problem of the cloudy relationship between specific values and value in general. An account is needed of the implications of the rise of *a general sense of value*, as manifest in, e.g., the rise of money. This has displaced the *attainment of multiple specific values* in the reproduction of human social

Anticipating and Responding to Challenges Regarding Digital Technologies and Valuing formations. We need a more trans-cultural, general ethnology of value(s)—that is, of how valuing replaced ‘values-ing.’

Before moving to this task, we have to offer a caveat about the language necessarily used in articulating developmental or historical theorizations of this values-related complex. To communicate effectively, let alone persuasively, any generalizing theory of cultural process must be expressed in words whose meanings are generally well understood. However, ‘everyday’ word usages carry a wide variety of connotations, due to the multiple ways that many words are typically used, leaving considerable scope for misunderstanding. This is especially true, as Harvey (2010) reminds us, of words like ‘value’ that are used in general senses. Thus, we need to exercise greater than normal care in the way we use value words.

Graeber is one of several anthropologists who have followed Appadurai’s (1986) call for renewed efforts to explain changes in valuing culturally, to address why dominance in social practice is achieved by some specific values and their various embodiments and not others; further, to account for the diverse ways that in practice cultures come to treat some culturally constructed things as important, while not others. Taken together, these scholars’ efforts have refocused comparative anthropological discourse on things and how some things become commodities. They have developed notions that are illustrative across wide swathes of human cultures.

Being self-conscious about how we use language, and following Graeber, an initial, specific ‘value’ can be defined generally, as the kind of thing toward which human behavior, both physical and verbal, is often oriented. We note that, besides ‘a value’ being a thing of orientation, ‘value’ can also be used as a verb, one that emphasizes that people think of some things as good; that is, as things to be (and that are) ‘valued.’ In societies in which money plays an important role, however, the term ‘to value’ also has often been given an additional meaning denoting *how much* something is ‘worth,’ in terms of other things, or in terms of a general medium of exchange, i.e., money. Because in English terms like ‘worthiness’ have other multiple associations, we can’t simply substitute ‘worthiness’ for ‘value’ to make our points. We are forced to articulate theories that distinguish between ‘values’ and of ‘value.’ We also need ways to communicate our collective of meanings by additional linguistic maneuvers—e.g., by finding a way to highlight value(s) polymorphous character, as by talking of ‘valuing’ as well as ‘valuing.’ Only in this way can we be clear when we are talking about

general processes of valuing/valu(es)ing as opposed to talking specifically about, e.g., how much something might command in a market.

The Ethnology of Values and Digital Mediation

The renewed discourse on values within anthropology to which Graeber and his colleagues have contributed has arisen at the same time as the spread of the use of digital technologies (DTs). We think these are linked, sometimes directly, as in the idea that non-instrumental online interactivity changes political economy (e.g., posting a video on YouTube). Some scholars (e.g. Scholtz, 2012) see a tendency for 'playbor,' a combination of play and labor, to displace traditional labor, and they go on to argue that such posting should be rewarded with a wage. Renewed disciplinary attention to values and digital mediation may also be connected indirectly, through a larger change process, such as 'globalization.' (Sassen, 2001). Such ideas about DTs and valuing are recent, specific examples of arguably one of the more dominant tropes of the late Twentieth and early Twenty-first Centuries: That there is a causal connection between computing and general or even fundamental social change, a presumption informing multiple current 'memes.'

In our view the new attention to values is a manifestation of this ongoing popular and scholarly discussion about the relationship between computing and general socio-cultural change. We wish to extract from this new anthropology of values ideas about how to talk about how valuing is done by cyberians, the residents of today's ever more digitally mediated social formations (Escobar, 1994). While this academic value discussion is important, it is unfortunately often marked by facile, claims that need deconstruction, like the idea that computing itself *causes* substantial change in society and culture. An example is the idea that a specific form of computing 'changes everything,' as Tapscott and Williams (2011) effusively contend is the case for peer production.

Such claims typically ignore the important social and cultural antecedents that shape particular forms of computing/uses of computers; hence, the claims should be seen as a form of technological determinism.

In theorizing a very different sense of value, Graeber distances himself from what is normally presumed in the discourses of formal economics about digital mediation and echoed in ludo-capitalist notions like playbor. Academic discourses on play-related change in values/value production can, like popular talk, get quickly mired in nostrums, hype, or misleading metaphors. Graeber's more recent book on *Debt* (2011) is an effort to

Anticipating and Responding to Challenges Regarding Digital Technologies and Valuing extend his value theorization more broadly as a means to avoid such generalizations and to get more specific about value theory.

In introducing *Toward an Anthropological Theory of Value*, Graeber describes his initial intent as wishing to contribute to anthropological theories of value; that is, theories aiming to account generally for how cultures ‘...define what is beautiful, or worthwhile, or important...[these theories should help us] see how meaning, one might say, turns into desire’ (2001, p. ix).

Instead of a generating a new, general theory of valuing, we want to develop, in the light of existing theories,

1. A specific account of valuing among contemporary human beings whose social formations are substantially computered in order to articulate
2. A new approach to values, one related to but surpassing current valuing and appropriate to a fulsome cyberspace life-way.

On Why a New Value Theory is needed

Our account builds on Graeber’s framework, suggesting answers to specific value questions, similar to the way he accounts for diverse cultural systems of valuation. Like Graeber, we want a theory of contemporary valuation that can serve activism. We want this both because we value activism, but also because we see the contemporary crisis in social formation reproduction (SFR) linked to a contemporary crisis of valuation. That is, current notions of what is valuable and how to get it undermine more than they support the reproductive requirements of the social formations through which we become human and renew our humanity. *A new theory of value is needed because of substantial evidence that current value practices no longer work well enough.* A new understanding of valuation is a necessary component of developing an alternative to the current, crisis-ridden dynamics of SFR.

Graeber frames valuing as the type of practice that occurs ‘when meaning turns into desire.’ Our focus, too, is on practices—that is, on what people do when they act—because practices say a great deal about what they ‘really’ value—at least as much, often, as does what they say (for a recent update on practice-based perspectives, see Corradi et. al., 2010).

Again, we are interested in the ultimate implications of these practices for the reproductive dynamics of current and future social formations.

A Theory of Value Practices: Nominal, Ordinal, and Ratio Forms of Valuing

What kind of thing is a value such that its character can change fundamentally, and that this change both reflects and alters the way that the social formation around it is reproduced? Intimately connected to the capacity to impose a cultural order on the world—that is, to culture—is the tendency to identify things that are worthwhile, meaningful. Let us start by suggesting that ethnologically relevant distinctions can be drawn among the types of valued ‘things’, or valuables.

First, one can identify and distinguish from each other *the things cherished in any particular culture*. We call these things ‘nominal’ or basic, ordinary valuables. Nominal values all share the quality of being valued, but nothing can be derived from this condition about the relationship among values. ‘Freedom,’ ‘duty,’ and ‘hope’ are, in contemporary ‘Western’ societies, in large part nominal values in this sense.

As a type, nominal values can in turn be distinguished from *ordinal values, those that are related to each other in a hierarchy*. Ordinal values are the type of valued things that people’s actions and words suggest are generally held to be in ‘more or less valuable’-type relations to each other, one thing valued in relation to other things valued. Wampum among the Iroquois, and honey to the BaMbuti ‘Pygimes’ are examples of these ‘greater than’ (>), ordinal valuables. It becomes possible in a social formation to identify where one value fits in relation to at least some other values. We can speak of these values as becoming ordinal, valuables being ‘ranked.’ A contemporary cultural example is that we value means of survival more than means of diversion—food as opposed to TV.

In turn, ordinal values can be distinguished from *the class of valuables not only ranked in relation to others as more or less valuable but which one can also be equated, are measurable* in relation to each other. These are *ratio* (also sometimes called interval) values; that is, they involve valued things whose degree of being valued can be *measured*, in terms of something used for such comparative purposes (e.g., money; Graeber, 2011). If an apple costs 20 cents and an orange 40, we take this to mean that the apple is half as valuable as the orange.

Nominal and ordinal valuing are practices that seem to be widespread, arguably of universal importance in human social formations. Graeber’s ethnology of values is an extended demonstration of this point. However, ratio values are important in only *some* social formations. Those in which valuing institutions of the ratio-type have reached a modicum of

Anticipating and Responding to Challenges Regarding Digital Technologies and Valuing developmental complexity typically also have something like ‘money,’ a substance in terms of which the value of multiple other things is articulated. Ratio value can be measured by things like currencies, or by other units of account in economic transactions (Graeber, 2011). It is in such social formations that one finds talk of ‘value’ in the abstract, as a singular thing, as opposed to specific, concrete values.

Implications of Ratio Value for Social Formation Reproduction

Societies in which this singular, ratio notion of value has become important are different from those in which it is not. To develop a full account of the implications of this difference, we would first need to explain how ratio value came to be developed and dominant. Such an account would suggest bridging between Graeber and the work of substantivist economic anthropologists such as the Marshall Sahlins of *Stone Age Economics* (1972). We intend something less ambitious but to us more important: to link our contemporary muddles over digital technologies and social change to the dominance of ratio valuing.

While it may be a commonplace to claim, ‘everything has its price,’ the importance of ratio value institutions, of valuing as opposed to ‘valuing,’ actually varies. Sometimes they mediate only a small portion of the aspects of a social formation’s reproduction, and sometime a very large portion, but never everything; at least, not so far. Here is an introductory economics course illustrations of the lumpiness, the incompleteness, of ratio valuing: Humans value clean air, but it is difficult, even in a contemporary ‘Western’ social formation, to equilibrate—to compare in terms of a ratio—the value of clean air with, say, a piece of chicken from a supermarket. We value air nominally, while the chicken’s value is established in terms of ratio. Nonetheless, it seems reasonable to posit a continuum of social formations that become increasingly mediated by ratio valuing. Thus, a social formation in which individuals and/or their families, clans, or tribes, produce most of what they consume would be on the lesser end of such a continuum, whereas social formations in which most people get what they need by buying it with wages would be closer to the greater end. Since the more recent the emergence of a social formation, the more likely it is to be located toward the greater end, our continuum would reflect a path-dependent history that has led to increased ratio-type valuing.

Our intent is to show how going down this value-lens analytic road provides purchase on how, why, and to what extent recently-emerged

computing's connection to SFR is heavily mediated by ratio valuing. To enable new values (like those implicit in some forms of computing) to have a greater impact on SFR, it is necessary to decrease ratio value mediation.

What kinds of things follow from increasingly valuing in ratio terms? Marx's argument in *Capital* (1871) for the importance of the commodification of labor can be rephrased in our terms, to stress how the mediation by ratio value of the capacity to do work is a key development in social formation type. Such mediation is the feature that distinguishes 'capitalist' from other social formations, including those with large markets in lots of other things but not labor, as in peasant societies. Moreover, as Graeber (2011) shows, this way of bringing human life into the system of equivalence is often accompanied by extreme violence, one of the reasons why the capitalization of social formations has been contested so often. On our continuum, a social formation in which labor power and human beings are a commodity would be nearer to the greater end, more thoroughly mediated by ratio valuing than one in which this was less the case.

This analysis can be summarized in the following propositions:

- All social formations deploy nominal values; that is, they 'values'/have valuables.
- Most, probably all, social formations, deploy ordinal values, too; that is, some valuables are more centrally implicated in social formation reproduction than are others.
- *Some* social formations deploy ratio values; that is, a selection of things more valued are 'connected' in ways that make it possible to specify social consensuses of 'equitableness' (measurability among them beyond interval scaling).
- In some social formations, which have much ratio valuing, the capacity to do work is itself brought into these measurable, equating systems. These are social formations in which labor, or the human capacity to do work, has been commodified.

Marx himself went a step further, by arguing that the creation of many of the things valued in ratios is controlled by a small proportion of the population, so ratio valuing disadvantages the rest of the population. To survive, this remainder must select how to get a sufficiency of the things needed to reproduce themselves and their families on a day-to-day basis from a practice array more limited than previously. This is, for example, the situation of peasants after enclosure of a commons. To put it succinctly, 'getting a living' becomes necessary in order to 'have a life.'

Anticipating and Responding to Challenges Regarding Digital Technologies and Valuing

In our terms, ratio valuing has become the dominant moment in SFR. Computing has been integrated into SFR, so ratio valuing exerts a direct influence on computing. As computing has become more central to cultural and social reproduction at the same time as commodification has gone even further (as in., e.g., neo-liberalism), it would appear to have become integral to the general processes of commodification. To demonstrate, then, that computing in general (or that ‘web 2.0’ or ‘social computing’ form in particular) *causes* fundamental social change, one would have to establish that the opposite was true, to show how computing has, say, resisted a long-established trajectory of change in the basic dynamics of SFR, how it has displaced (rather than reinforced) the penetration of ratio valuing.

On Value and Creating Social Relations

How is one to investigate such fundamental, causative social reproduction processes? To address this issue, we turn to Actor-Network Theory (ANT). ANT provides a more precise analytic language to explicate the imbrications in social relations of value and valuation practices. Via both historical and geographical comparisons, combining ANT and Graeber’s perspectives enables us to identify the dynamics leading to increases in ratio valuing.

Of course, value reproduction is always extended, never simple. We wish via ANT to make valu(es)ing material, which requires two theoretical paths. First, we reapply ANT analyses that provide empirical approaches to the problem of the different modes of knowledge production—that is, the collective definition of what is true. These analyses underline how material objects participate fully in such process. The other path deploys Nancy Munn’s conceptualization of the role ‘things of value’ as the entities that transform the invisible potential of people into concrete objects. Munn’s approach stresses how value is the result of the work needed to realize the invisible potential of material things.

In ANT, material objects participate fully in the flux of social life (Latour, 1992). Objects are part of social life, and can be both powerful enough to *affect* the behavior of other (both human and non-human) participants and also weak enough *to be affected by* the behavior of other (human and non-human) participants. ANT also shows how material objects carry cultural meanings and moral prescriptions—that is, how such objects can define the set of possible worlds compatible with the objects themselves, via being used by other participants (Akrich, 1992). Participants values unfold only in the relationships between the object-participant and the other objects or human beings populating social life. This offers a useful lens through which

to identify how values are transmitted. This is clear in the example Callon and Muniesa present in the case of supermarkets: the full chain is organized not only to provide goods with prices but also to allow a calculation by the buyer on the basis of her attachment to a specific good. Within the supermarket, is the whole set of socio-technical arrangements that translate calculative capacities.

Munn's main point is that activity itself is the process through which the invisible potential of a person or thing becomes concretely visible—that is, that value emerges from social activity (1992). Material objects, although they do not exhaust it, are the medium of such manifestations, that value is socially attributed to human action through the mediation of material objects. The practice of individual weapon appropriation in ancient warfare can exemplify and clarify the circulation of value attribution. In individual fighting during face-to-face battles, the person killed was often robbed of his sword, shield, etc. Such equipment was particularly valued if connected to famous warriors, the ordinal rank of the killer being increased by the possession of the sword itself. The sword actually mediates among the value of the defeated warrior, the time the sword was won, and the time it is displayed. In particular, Munn illuminates how it is through the circulation of things of value that humans extend their ability to influence others in space and time.

A basic ANT concept that closely resembles Munn's perspective on the circulation of valued things is the 'immutable mobiles' of Bruno Latour (1987). Common to both Munn and Latour is a focus on how the distributions of mobilized time, energy, and intelligence act as the underlying equilibrating elements among artifacts (including commodities). Together they show how things of value/immutable mobiles enable assessment of the importance of what people do to create social relations. The empirical tasks then become 1) to describe the forms of social relations connected to the dominance of particular things of values and 2) if durable, to figure out what makes the given social relations have this quality.

Understanding the Rise of Ratio Valuing and inverting it to rebuild the Commons: On Freedom, Love, Struggles, and Other Values to Be Valued

Our globalizing world is increasingly recognized as a common one, in which, for example, the environment must be managed globally. The commodities that we sell and purchase travel more and more widely and are regulated by transnational agreements. Negri and Hardt (2011) describe

Anticipating and Responding to Challenges Regarding Digital Technologies and Valuing this world as one that is losing much of its 'outside.' That is, the physical aspects of life are increasingly shared. Life is more inclusive, actions in one location mobilizing elements (forms of knowledge, material products, technical solutions) in others.

What about values? Are there emergent ones that point toward a world based on shared criteria, like justice and commonality? While, as Callon (1998) argues, contemporary economics is the study of how 'market devices' extend ratio valuing, there is another economics that charts a path toward shared interval and nominal values, 'common devices' that promote justice and commonality.

Before moving to the task of how to promote the reorientation values, institutions, and measures to make viable extended SFR, we want our theory of value(s) to demonstrate historically the existence of human value inclinations inclined toward collaborative liberation. For this, we turn to the Autonomous Marxist reorientations of value(s) theory in Negri's and Hardt's *Commonwealth* (2011). They support value(s) practices that promote liberation of the working class, the exercise of freedom by free subjects, and forms of love that do not transform into hate. They reframe the working class more broadly as 'the multitude,' locating the historical privilege of agency in 'the poor.' The issue of social change is not structural—i.e., which class has agency—but one of action—who is engaged in *making* the multitude. Values mobilize action in relation to the actual configurations of bio-power in a particular social formation.

Negri and Hardt also reframe the values of freedom and love along the same lines. In capitalism, the defining use of bio-power is the transformation of people into commodities. Hence, the main political struggle is to de-commodify the world, by creating a world of shared values and the sharing of their pursuit of a common world, in a Foucaultian 'bio-political' event. The encampment strategy of the Occupy Movement may be an early form of breaking the constituted power over spaces through the physical presence of living bodies, opening up scenarios for alternative uses through obviating their ratio valued form. Through the creative destruction of boundaries and commodity framings, overflowing bio-political power enables the extension of SFR.

For Negri and Hardt, the multitude can only extend SFR if the value of freedom has priority over power. Yet in order to see if SFR is oriented toward liberation rather than some new hierarchy, we need criteria. This is the contribution of Negri and Hardt's re-conceptualization of the third priority; love, which they frame as enabling thinking and acting in

association with other human beings. Evoking Spinoza, they frame *amour*, the desire affirmed through reason, as the desire for association and a common future.

Conclusions

In sum, we argue that all social formations value; in many, some valuables are more centrally implicated in social formation reproduction than others. In some of these latter, ranked value becomes the basis of equitable, ratio values; and in some of these last type, basic human life activities are brought into the equivalence system where life itself becoming a commodity. While drawing upon traditional Marxian accounts of value, these perspectives give a new sense to the distinctions among use value, exchange value, general value, and surplus value. The main conclusion we draw is that the centrality of ratio valuing to value in general creates the need to return to nominal and ordinal valuing in the effort to extend SFR capacity in the future and also the need for an intellectual effort to identify real practices that de-ratio valuing (at least some of which can be seen in certain digital practices).

To be extended, SFR must be focused on a range of valuables, ones that better reflect the actual freedom and love of real Actor Networks. Having identified the kind of things that new valu(es)ing processes need to be capable of. In our book we go on to consider what these values might be, especially they ways they might fit together. We refrain from the pure Utopianism of trying to say what they will be, recognizing that, as long held by Marxists, these can only emerge in the struggle. Still, we build on our discussion of what they might be to suggest forms of institutions and measures that can guide us toward realizing them. By reinforcing both freedom and love via such valuables, institutions and measures can be constructed that afford positive change in the dynamics of SFR.

References

- Akrich, M. (1992) *The de-description of technical objects*. In Bijker., W. and Law, J. (eds.), *Shaping technology/building society*. Cambridge: MIT Press.
- Appadurai, A. (1986) *The Social Life of Things*. Cambridge: Cambridge University Press.
- Callon, M. (1998) *The Laws of the Markets*. London: Blackwell.

- Anticipating and Responding to Challenges Regarding Digital Technologies and Valuing*
- Callon, M. and Muniesa, F. (2005) Peripheral Vision: Economic Markets as Calculative Collective Devices. *Organization Studies*, 26 (8), 1229–1250.
- Corradi, G., Gherardi, S. and Verzelloni, L. (2010) Through the Practice Lens: Where Is the Bandwagon of Practice-based Studies Heading? *Management Learning*, 41 (3), 265-283.
- Escobar, A. (1994) Welcome to Cyberia. *Current Anthropology*, 35(3), 211-231.
- Graeber, D. (2001) *Toward an Anthropological Theory of Value*. New York: Palgrave Macmillan.
- Graeber, D. (2011) *Debt*. New York, New York: Melville.
- Gudeman, S. (2012) *Economy's Tension*. New York: Berghahn Books.
- Harvey, D. (2010) *The Enigma of Capital*, Oxford: Oxford UP.
- Latour, B. (1987) *Science in Action*. Cambridge, MA: Harvard UP.
- Latour, B. (1992) *Where are the Missing Masses?* In Bijker, W. and Law, J. (eds.), *Shaping Technology/Building Society*. Cambridge: MIT Press.
- Marx, K. (1995 ed. or. 1867) *Capital, Vol 1*. Oxford: Oxford UP.
- Maurerer, B. and Schwab, G. (2006) *Accelerating Possession*. New York: Columbia.
- Munn, N. (1992) *The Fame of Gawa*. Durham: Duke University Press.
- Negri, A. and Hardt, M. (2009) *Commonwealth*. Cambridge: Harvard University Press.
- Marshall, A. (1972) *Stone Age Economics*. Piscataway: Aldine Atherton Publisher.
- Sassen, S. (2001) *The Global City*. Princeton: Princeton UP.
- Scholz, T. (ed.) (2012) *Digital Labor: The Internet as Playground and Factory*. New York: Routledge.
- Tapscott, D. and Williams, A. (2006) *Wikinomics*. New York: Portfolio.



Citizens' veillance on environmental health through ICT and genes

Annibale BIGGERI^{*a} and Mariachiara TALLACCHINI^b

^a University of Florence; ^b JRC/IPSC - Ispra, Italy

In the last decade three different phenomena have merged: the widespread use of ICT devices to collect and potentially share personal and scientific data, and to build networked communities; biobanking for genomics, namely the organized storage of human biological samples and information; and the collaboration between scientists and citizens in creating knowledge—namely peer-production of knowledge— for shared social goals.

These different forms of knowledge, technical tools, and skills have merged in community-based scientific and social—as well as legal—initiatives, where scientists-and-citizens use genetic information and ICT as powerful ways to gain more control over their health and the environment.

These activities can no longer be simply qualified as epidemiological research and surveillance. Instead they can be framed as new forms of citizens' participatory 'veillance': an attitude of cognitive proactive alertness towards the protection of common goods. This paper illustrate two Italian case-studies where citizens and scientists, by making use of both ICT and biobanking, have joined with the goal of protecting environmental health in highly polluted contexts.

Keywords: *Veillance; ICT; genomics; health and environment*

Introduction

In the last decade three different phenomena have merged: the widespread use of ICT devices to collect and potentially share personal and scientific data, and to build networked communities; biobanking for genomics, namely the organized storage of human biological samples and information; and the collaboration between scientists and citizens in creating knowledge—namely peer-production of knowledge— for shared social goals.

* Corresponding authors: **Annibale Biggeri** | e-mail: abiggeri@disia.unifi.it

These different forms of knowledge, technical tools, and skills have merged in community-based scientific and social —as well as legal— initiatives, where scientists-and-citizens use genetic information and ICT as powerful ways to gain more control over their health and the environment.

These activities can no longer be simply qualified as epidemiological research and surveillance. Instead they can be framed as new forms of citizens' participatory 'veillance': an attitude of cognitive proactive alertness towards the protection of common goods. This paper illustrates two Italian case-studies where citizens and scientists, by making use of both ICT and biobanking, have joined with the goal of protecting environmental health in highly polluted contexts. These are the 'Fondazione Bioteca Sarroch' (Cagliari, Italy) near an oil refinery plant, and the project 'PM2.5 Firenze' for the control of particulate matter in the city of Florence. In both situations, citizens —scientists and lay-experts— started a knowledge-based initiative to re-establish some fundamental rights, after these have been infringed (or are at risk of being infringed), by 'privately' producing valid and more transparent knowledge to complement, but sometimes to contrast with official, institutional knowledge.

Surveillance and epidemiology

Even though practices of surveillance in relation to morbidity and mortality have been applied for several centuries, the modern concept of surveillance, as a branch of epidemiology, dates back to the 19th century and developed only in the second half of the 20th century into a complete discipline within public health.

Moreover, the contemporary concept of 'public health surveillance' has changed over time as an attempt to draw the boundaries from other uses of the word 'surveillance,' where power implications are more apparent (Subramanian, 2003). In the 20th century the concept of surveillance as the monitoring of disease occurrence in populations was developed in contrast to surveillance meant as close observation of persons exposed to a communicable disease in order to prompt isolation and control measures.

Also, while the attempt was made to maintain the concept relatively 'neutral' towards its potential policy outcomes, at the same time the policy need existed to frame surveillance as the factual basis for 'rational decision-making,' namely information for action (e.g., in allocating resources, in choosing priorities, in predicting future needs) (Declich and Carter, 1994, p. 289).

However, as methods and measures in public health have often been developed, especially in the field of infectious diseases (Gainotti et al., 2008), in connection with legal acceptance of compulsory measures and strong limitations of fundamental rights, a more direct and active involvement of the public was deemed necessary.

These attempts to make public health needs more compatible with human rights and democratic procedures have led to participatory epidemiology, the application of participatory methods to epidemiological research and disease surveillance. Participatory epidemiology is based on conventional epidemiological concepts, but uses participatory methods to solve epidemiological problems. The practices related to lay expertise, and especially expert patients, have thus merged with the dynamics of participatory surveillance.

From surveillance to veillance

The modern imaginaries about surveillance have been inseparable from top-down visions of power and control. From Bentham to Foucault, the Panopticon has represented the default image and meaning for surveillance activities (Foucault, 1995). David Lyon has defined surveillance as 'the focused, systematic and routine attention to personal details for purposes of influence, management, protection or direction' (Lyon 2007, p. 14).

Typically, surveillance refers to activities enabling governments or corporations to manage a population. Also, this conception of surveillance involves an asymmetry in power as one characterizing institutions and super-individual entities.

Traditional surveillance has developed towards the State surveillance in the modern age, and has then moved towards a broadly 'policed' society, to a bureaucratic collection of personal information for various law and rights enforcement purposes, to surveillance for social planning and in relation to the welfare state and, as said, in public health activities.

Although individuals are supposed to be trapped by the gaze and unable to escape its pressure, traditionally forms of resistance to surveillance have been developed. The concept of what has been called 'sousveillance', namely surveilling from below, has been applied to situations where the weakest part of a relation/interaction has the chance to redirect the gaze back, thus producing an inverse surveillance: the watched watching the watcher.

Indeed, the massive availability of inexpensive ICT devices, from wearable sensors to smart phones to social network platforms, has radically

altered this big single gaze: by fragmenting and multiplying it into a kaleidoscope of ubiquitous technological 'eyes' colonizing public and private spaces; by adding a more horizontal dimension to the vertical one; by decoupling the source of information from visual surveillance. Even though State surveillance has only become stronger, more pervasive and networked and more diversified as to the means applied, the changes brought about by new forms of 'lateral' surveillance enabled through individually usable technology remain ambiguous as well.

All these changes have been the object of surveillance studies for more than a decade, revealing continuities and new dynamics (Marx, 2002) mostly enabled by technologies. First of all, the means through which surveillance can take place have completely superseded the visual reference and include all data, from biology to biography, while 'seeing' increasingly assumes the meaning of 'seeing through' (Marx, 2002), seeing forward, and making forecasts. Second, everybody can perform surveillance on everybody else and can be observed through small or completely undetectable tools. Moreover, a general ethos of self-surveillance can be observed that has blurred the line between the surveilled and the surveillant.

Surveillance and participation

More and more, in order to understand it as a dynamic process, surveillance has to be examined in the context of the power relations they produce (Huey and Fernandez, 2009). Indeed, an additional characteristic of new surveillance is participation in surveillance, and the resulting ambiguous boundaries between voluntary and involuntary surveillance.

Disguised forms of 'voluntarily' participating in surveillance are not new. However, the softer and less invasive quality of current surveillance techniques has contributed to blurring the lines between a full and an attenuated awareness of providing information to a third party, and to the idea that even unconsented data collection can be seen as participation in surveillance. The idea of making surveillance participatory has been framed in different ways and given different meanings, with surveillance merging self-surveillance, and with various degrees of (un)intended contribution integrating the scene (Albrechtslund, 2008). In the concept of 'participatory surveillance' individuals are not just disciplined, but take active part in their own surveillance, even more by continuously contributing with information to databases.

Framing surveillance as participatory has been a formula to suggest its democratized character, and to distract attention from the actual subjects empowered by surveillance and from their goals: who is in control of them and which those are.

Not all forms of participation are alike, and the mere participatory nature of surveillance does not justify its overall legitimacy. Participation *per se* is not a significant sign of a paradigm change in surveillance if the powers involved are not re-considered, re-balanced, and re-legitimized. In this respect making surveillance participatory as to its means does neither imply that its goals are disclosed to, known and controlled by participants, nor that they can be justified in terms of the socially recognized rights and values. A paradigm shift requires that surveillance activities are framed and performed through participation to achieve some common good that can hardly be achieved with more traditional forms for rights implementation.

The (often combined) fields of health and of consumer protection are amongst the most frequent domains for citizens to engage in surveillance. Two broad categories of surveillance can be envisaged. One consists of those forms of self-surveillance for self-help purposes. Historically, these initiatives have often concerned patients with chronic diseases. People are empowered by becoming experts in managing their own disease, through the use of ICT sensors and by communicating and sharing data and experiences in dedicated social networks (Weitzman et al., 2013).

Empowering communities through participatory veillance

However, a different category of surveillance requires more attentive consideration as to the powers, the rights, the means, and the goals involved. These other forms consist of collaborative monitoring and self-monitoring of certain information in order to generate some change. These activities have been mostly interpreted as forms of *sousveillance*, even though some of them lack the symmetric element of community members being observed by an authority or corporation.

The expression participatory 'veillance' is introduced here to refer to an attitude of cognitive proactive alertness towards the protection of common goods.

Efforts by communities to monitor industry's effects on air quality have been amongst the most widely performed activities of this type of participatory surveillance. Communities have used a variety of strategies and devices to watch the environmental impacts of neighboring industrial facilities (Ottinger, 2010). In the connection between environmental

conditions and privately-performed participatory veillance, the seemingly separated domains of health and political powers in democratic societies merge. While environmental monitoring is performed to protect public health, this form of cognitive awareness has become a strategy for the political empowerment of a community, undertaken with an eye to intervention (Ottinger 2010, pp. 221-222).

The two cases presented here below allow reflection on some possible elements for considering citizens-based surveillance activities useful and legitimate.

What seems to characterize both examples is the combination of several factors not systematically connected in other similar experiences. First, while population genetics has been deployed together with the biobanking of human biological samples and information, so far biobanks have been used (at least in epidemiology) as an instrument for better understanding of genetic diseases and their distribution in specific populations. Biobanks have not been established as instruments for surveillance on third parties' behavior.

Second, environmental data and genetic knowledge merge as correlates for supposed associations between levels of pollutants and genetic modifications potentially leading to diseases.

Third, the forms and the subjects of knowledge production-and-use involved in these activities aim to generate knowledge and power. Indeed, the specific empowerment fostered by environmental and genetic surveillance depends on the meaning of the gathered data. Knowledge generated through direct collaboration between scientists and citizens is both trusted by participants and relevant for authorities (and industry) (Ottinger, 2010).

ICT aggregating data about individuals to create populations that can be acted on are critical in transforming data into interventions; and social networks, not only give interested people the ability to connect to each other and with scientists, but also to transform rarefied scientific activities into social movements.

Finally, unrelated citizens from different places are learning very quickly how to use knowledge and technology as forms of power. While in the first case (Sarroch) the population was guided and encouraged by authorities to take advantage of environmental and genetic knowledge, in the second case (Florence) citizens started the initiative: and the tendency is towards more complete citizens' control over both the techno-scientific and the political dimensions.

The Fondazione Bioteca Sarroch

In 2006 the Municipality of Sarroch (Sardinia, Italy), which hosts a power plant and the second largest European oil refinery and petrochemical park, promoted the Sarroch Environment and Health Project. The project encompassed a complex set of epidemiological investigations and surveillance intended to identify and quantify the environmental health risk for the resident population. In fact, the industrial estate produces a complex mixture of air pollutants, including benzene, heavy metals and polycyclic aromatic hydrocarbons.

The project (six-year duration and one million Euros spent) was launched and involved the Sarroch Municipality, several universities, the Cancer Prevention Institutes, and a non-profit epidemiological organization (Cooperativa Epidemiologia e Prevenzione).

A fixed air quality station was set up and several monitoring campaigns took place. Three large surveys on respiratory disorders in childhood, two panel studies on asthmatic children, and a bio-molecular study of DNA adducts were conducted; a study of cardiovascular effects of industrial noise on the adult population was recently completed. Also, detailed reports of the health profile of the population were published on 2006 and 2013.

The pollution in the Sarroch area was precisely characterized. The first phase of the project was dedicated to air quality and gaseous pollutants responsible for respiratory disorders. Epidemiological and environmental surveillance of benzene and polycyclic aromatic hydrocarbons (PAH), metals and other constituents of the mixture of pollutants in the area required a different study design. Due to the small size of the population (around 5,000 people) traditional cohort studies have a very low statistical power.

Therefore, in the second project phase, the research team decided to dedicate all efforts to design a biomonitoring study – to characterize the population exposure spectrum and to quantify selected molecular risk indicators. Since 2008 the study documented an adverse effect on children's respiratory health of the mixture of air pollutants in the area, notably sulfur dioxide hourly peaks above $100 \mu\text{g}/\text{cm}^3$. The Sarroch scientific results were not challenged by industry; instead, they were discussed in both a scientific and a civic context. The data supported the request for stricter rules on emission reduction that the Ministry adopted in its revised authorization (Autorizzazioni Integrate Ambientali, AIA) issued in February 2009. The implementation of the new rules produced a significant reduction of the yearly emissions of sulfur dioxide: since 2009, only five episodes of higher peaks in four years of monitoring were registered by the Sarroch

Environment and Health Project. Moreover, as a consequence of the new policy and of industry compliance, the time trend of ambient concentrations for this pollutant showed important reduction from 2009 onward.

Since the beginning, the research group launched several initiatives aimed to improve communication and participation from the Sarroch community. The original research group, mostly composed of epidemiologists, was enlarged to include experts on communication and participation, sociology of science, law, and ethics.

The project was welcomed with a high participation rate (above 90%) in the surveys. On December 2009 the idea of setting up a public biobank was discussed by the Municipality and the researchers, and was presented to the population. The biobank represented a techno-scientific tool to monitor the population health/exposure and to check the results on DNA adducts over time. It was also considered a transparent form of veillance on industry behavior.

The biobank was planned to be physically located in the Sarroch village. It was immediately clear that mainstream visions and existing regulations for biobanks could not meet the needs and goals of the Sarroch case. The project is framed as a civic initiative; it looks at population health and collective well-being; no individual benefits are expected besides empowering the community in its struggle for a better environment.

The main shift concerned the current understanding of biobanks, conceived to favor researchers' needs and commercial exploitation of genetic materials and information. Inherent in the concept of Bioteca—the Italian word evokes 'public library' (biblio-teca)—is its public destination: an independent foundation, collectively owned by citizens, and located not within a scientific institute, but in the center of the village. On August 4th, 2010, the Municipal Council approved the by-laws of the Bioteca Foundation and the new body was officially recognized on August 27th, 2012.

The by-laws of the Bioteca Foundation state that environment and health are a collective endeavor, and that the biological samples supplied by the exposed population are stored for research aimed to improve population well-being in a clean environment. Citizens are by definition entitled to be members of the initiative, but they are asked to formally give their adhesion to the Bioteca Foundation, and through time they can contribute, by agreeing to *ad hoc* informed consents, to specific research.

Therefore, citizens can freely participate with different degrees of engagement. They can adhere to the project as such and then they can

provide their informed consent to specific research. Moreover, the use of the biological materials stored in the Bioteca must be negotiated with citizens' consent every time (Biggeri, De Marchi and Tallacchini, 2011; De Marchi, 2011).

The planned ICT platform is meant to add a further dimension to participation. It will provide citizens with direct access to their data and signed documents, to research and publications, to local and non-local education initiatives, to shared spaces for discussion.

The project aims to combine scientific evidence and civic will to care for a cleaner environment and more strict emission levels.

Some unintended, but interesting, outcomes were the consequence of the existing mismatch between academic and socially-engaged science. On February 27th, 2013, the scientific journal *Mutagenesis* made available online a paper showing evidence of genetic damage in schoolchildren from Sarroch (Peluso et al., 2013). The paper, signed by most researchers involved in the Sarroch Environment and Health Project, was presenting results of the survey conducted in Sarroch and in a reference village in May 2007. The published results had been already included in the report of May 2008 for the Ministry of Health which had led to major improvements.

Surprisingly, the time required for the bureaucratic procedures and for publication of the international scientific review article have turned out to be very different: while the Sarroch Environment and Health Project obtained a prompt response and encouraging results from the Health Ministry and from industry, the scientific article only appeared four years later, after the environmental and health situation had already substantially improved.

As soon as the article in *Mutagenesis* was published and national newspapers covered the news of dangerous pollution in Sardinia, the public prosecutor in Cagliari (Sardinia's main city) threatened to start a lawsuit against industry (Lissia, 2013). The misunderstanding was resolved, but the lesson to be learnt is that academic science and socially-engaged science requires mutual adjustments. Perhaps a different (wider/wiser?) use of social media by scientists (especially when involved in social activism) may prove useful in updating old-fashion scientific procedures.

The veillance activities performed in Sarroch, though primarily supported by researchers and administrators, acted as a powerful tool to improve the environmental and health situation in Sarroch. This was not the simple effect of the validity of science, but rather the result of how knowledge, technology, and the law can co-produce new ways to complement more traditional legal means with soft enforcement tools. The

Bioteca may provide citizens with further preventative instruments to maintain healthy conditions. The existence of the physical structure and the planned implementation of an ICT platform as its virtual representation and as a civic space have the potential to establish a stronger sense of connection amongst citizens, and to make the project adaptable and exportable to other communities with similar conditions.

At the same time, at least in the Sarroch experience, the sense of having created a powerful tool surveillance has become scary for the Municipality, afraid of losing votes and political control of the initiative – for instance, if the employment rate decreases due to higher costs for industry. What is interesting in this political reaction is that, while most results were obtained before the Bioteca had been established, this single event has radically altered the overall *Gestalt*. What formerly appeared as traditional epidemiological research is now perceived as a permanent gaze on industry behavior.

Environmental and genetic veillance in Florence

The Sarroch experience has rapidly become a source of inspiration for other initiatives where citizens have taken the lead in proposing environmental and genetic participatory veillance.

In 2012 a single citizen with the aid of two lawyers decided to set up an air quality monitoring station for particulate matter (PM_{2.5}) in the city of Florence. He placed the monitor in his home courtyard and started a dedicated website where online real-time data on PM_{2.5} ambient concentrations are shown.

Epidemiological studies have established that a correlation exists between PM levels and respiratory chronic diseases such as asthma, bronchitis, emphysema, as well as cardiovascular diseases and tumors. Moreover, as to its indirect effects, particulate matter is the vector for highly toxic substances such as polycyclic aromatic hydrocarbons.

Smaller particles are more dangerous for human health as they penetrate deeper in the respiratory system. This is why environmental monitoring is performed for particles with a diameter of less than 2.5 µm (PM_{2.5}).

While scientists mostly agree that the limit for PM_{2.5} concentration should not exceed 10 µg/m³ as annual average, the accepted levels vary in different countries and according to different institutions. While WHO established a health effect threshold of 10 µg/m³ for PM_{2.5}, the EU accepts higher levels, hardly justifiable from a scientific perspective.

Florence is one of the Italian areas where European Union air quality standards are not met. The most recent epidemiological data (EpiAir Project, funded by the Ministry of Health, for the period 2006-2009) reported that the EU limit of 50 $\mu\text{g}/\text{m}^3$ of PM_{10} particles for a maximum of 35 days per year had been exceeded by an average of 59.5 days per year—which accounts for one additional death per semester.

Citizens lost confidence in the data produced by local authorities. Data appeared clearly unreliable after most sensors were removed or relocated in areas where pollutant levels were clearly lower than in most parts of town. The main monitors have been located far from polluted areas, namely in the Giardino di Boboli at Palazzo Pitti, and in the garden of the Istituto Agronomico per l'Oltremare. Only one monitor was validly located, though in an area with lower population density.

Despite several meetings and repeated requests, the Regional Environmental Protection Agency (ARPAT) did not restore the air quality monitoring network. On the contrary, the environmental monitor set up by the individual initiative respected the currently validated methods for background monitoring. It was located in the center of the residential area (ZTL), close to the railroad station.

The overall rationale of the project is to complement the existing inadequate institutional monitoring system, and to plan a biomonitoring study. The design is a matched cohort study in which each resident in the monitor neighboring area is matched to between two and four controls living in an area with low PM exposure, chosen to be amongst relatives and friends of the resident – i.e. matching by gender, age, and social class.

The website, built to display the data, and to aggregate and connect citizens around the initiative (<http://www.pm2.5firenze.it/>), shows the graphs of automatic updates for 2-minutes, hourly, daily, weekly, and monthly values, and it compares them with those provided by the ARPAT Air Quality Network. Citizens are in charge of managing the monitoring system, while the scientific part of the study is performed through collaboration with scientists belonging to a non-profit organization (Impresa sociale Epidemiologia e Prevenzione), controlled and crowd-funded by committed citizens.

The monitor analyzes a variety of plots corresponding to several issues on air pollution, and compares the data with those produced by the ARPAT network. Some scientific publications are currently using the data provided by the monitor to critically assess the coverage of the ARPAT, and to discuss the effectiveness of the policies adopted by the Florence Municipality.

The data obtained by citizens and researchers showed that in Florence, in the first months of 2013, the European Union limits for PM_{2.5} have been exceeded, with a long period of very high concentrations during the trimester December 2012 – February 2013 (six consecutive weeks above the limit of 25 µg/m³).

Due to the NGO Legambiente's direct involvement (www.legambiente.it), in 2010 a court trial was already started against the city mayor, the mayors of the surrounding municipalities, and the governor of the Tuscany Region. While the first phase of the trial ended with an order of acquittal, the appeal phase started in November 2014.

Making participatory veillance proactive and legitimate: beyond 'rights from wrongs'

Residents of polluted communities have struggled to influence industrial behavior by veilling on the environment for a long time. However, several surveillance technologies and different sources of knowledge—environmental sciences, epidemiology, genetics, etc.—have become available to citizens that expanded their abilities. The sharing of data through ICT platforms and interactive websites is proving crucial in changing the meaning, the scope, and the scale of citizens' initiatives. Moreover, the rapid development of sensors collecting and connecting data from the environment and the body is increasingly enabling Do-It-Yourself practices.

The cases of Sarroch and Florence are different in the way they have been conceived: the Sarroch project was launched by researchers and the municipality, acting to raise civic awareness and commitment, and to enable the population to be involved in the project; the Florence initiative was driven by a citizen, looking for scientific advice, but determined to keep control of the process.

While knowledge and technology become pervasively distributed, the situation is in flux. These private forms of veillance call for a scrutiny of their legitimacy. The goals that citizens' veillance activities are aimed at have to be legitimate in themselves, legitimate as to the technical means used to pursue them, and transparent also in the way they are funded (Bindi, 2014). The cases illustrated seem to (implicitly) derive their legitimacy from the need to restore a 'right' after a 'wrong' had happened. They both connect to contexts where rights have been denied, namely where institutional and legal mechanisms were not strong or reliable enough to grant citizens' rights.

Indeed, a possible rationale for legitimate participatory veillance may depend on its contributing to re-establish lawfulness; while the means adopted should not infringe other individual or collective rights. Thus conceived, participatory veillance projects led by citizens have the potential to become complementary (and hopefully preventative) means for law implementation where citizens' rights are at risk of being violated and are difficult to restore.

References

- Albrechtslund, A. (2008) Online Social Networking as Participatory Surveillance. [online] *First Monday*, 13 (3). Available from: <http://www.uic.edu/htbin/cgiwrap/bin/ojs/index.php/fm/article/view/2142/1949> [Accessed: 17th May 2014].
- Biggeri, A., De Marchi, B. e Tallacchini, M. (2011) La Bioteca di Sarroch: uno strumento civico per la tutela della salute umana e ambientale. *Ecoscienza*, 2 (3), 16.
- Bindi, G. (2014) Misuriamo lo smog. *Terra Nuova*, 296, Luglio-Agosto. Available from: <http://www.aamterranuova.it> [Accessed: 22nd August 2014].
- De Marchi, B. (2011) La bioteca di Sarroch: comunicare con i fatti. *Epidemiologia & Prevenzione*, 35 (3-4), 243-44.
- Dershowitz, A.M. (2004) *Rights from Wrongs: A Secular Theory of the Origin of Rights*. New York: Basic Books.
- Foucault, M. (1995) *Discipline & Punish: The Birth of the Prison*. New York: Vintage Books.
- Gainotti, S., Moran, N., Petrini, C. e Shickle, D. (2008) Ethical Models Underpinning Responses to Threats to Public Health. *Bioethics*, 22 (9), 466-476.
- Huey, L. and Fernandez, L.A. (eds.) (2009) Special issue: Surveillance and Resistance. *Surveillance & Society*, 6 (3), 199-351.
- Lissia, M. (2013) Alterazioni del Dna, allarme per i bambini nell'area di Sarroch. *La Nuova Sardegna*, 14th May. Available from: <http://lanuovasardegna.gelocal.it/cagliari/cronaca/2013/05/14/news/alterazioni-del-dna-allarme-per-i-bambini-nell-area-di-sarroch-1.7061009> [Accessed: 17th May 2014].
- Lyon, D. (2007) *Surveillance Studies: An Overview*. Cambridge: Polity.
- Marx, G. (2002) What's New about the 'New Surveillance'? Classifying for Change and Continuity. *Surveillance & Society*, 1 (1), 9-29.

- Ottinger, G. (2010) Constructing Empowerment through Interpretations of Environmental Data. *Surveillance & Society*, 8 (2), 221-234.
- Peluso, M., Munnia, A., Ceppi, M., Giese, R.W., Catelan, D., Rusconi, F., Godschalk, R.W. and Biggeri, A. (2013) Malondialdehyde–deoxyguanosine and bulky DNA adducts in schoolchildren resident in the proximity of the Sarroch industrial estate on Sardinia Island, Italy. *Mutagenesis*, 28 (3), 315-321.
- Subramanian, M. (2003) Epidemiology and Surveillance, Global Perspectives in Health, vol.I. *Encyclopedia of Life Support Systems*. Available from: <http://www.eolss.net/Sample-Chapters/C03/E1-14-02-03.pdf> [Accessed: 17th May 2014].
- Weitzman, E.R., Kelemen, S., Quinn, M., Eggleston, E.M. and Mandl, K.D. (2013) Participatory Surveillance of Hypoglycemia and Harms in an Online Social Network. *JAMA Internal Medicine*, 173 (5), 345-351.

The Corporation and the Panchayat. Negotiations of knowledge in an Indian Technology Park

Elena BOUGLEUX*

University of Bergamo & Max Planck Institute for the History of Science

South East of Bangalore, Karnataka, India. This is the location of the technological and industrial district known as Indian Silicon Valley, identifying the area around Electronics City. A new suburb of Bangalore, E-City has been dramatically developing in the last twenty years, experiencing an expansion so fast and intense to call for a redefinition of the legal and administrative competences required by its management. E-City has been chosen by the majority of international corporations as a location of their Indian branches. E-City is also the location of the Research & Development Department of the US based corporation where I developed my fieldwork. The paper describes the reasons, both scientific and economic ones, that led the corporation to delocalize its R&D in India, and the long-term effects that such decision is bearing on the entire territorial, human and urban development. E-City administration, shared among the traditional institution of Panchayat and the association of industry managers, has entered into a conflicting phase with the City Council of Bangalore, about crucial matters like primary resources management and distribution. The paper stresses how the processes of knowledge production, management and transfer cannot be understood within predefined disciplinary bounds, being strongly affected by local socio-economic constraints that make them useful, effective or im/possible.

Keywords: Corporation; information technology; development; ethnography

Introduction

My research moves from the need of focusing on the contexts that allow, enforce and make possible the challenges of scientific and technologic development, taking into account not only scientific skills and

* Corresponding authors: **Elena Bougleux** | e-mail: elena.bougleux@unibg.it

technical competences, but also investigating external and contingent factors, like social environment, economic constraints and cultural biases, that actually make scientific research useful, other than possible. This is the reason why I have been developing my recent fieldwork in the Research & Development Department of an international corporation, one of the ten largest corporate enterprises worldwide.

The corporation is a multilayered and multifunctional subject, with multiple areas of action and a strong capability of shaping the contexts where it establishes its activities. Large corporations have been traditionally developing the applied research they need within their own facilities: researchers with a basic academic education in Science or Technology are selected and hired with the perspective to be the trained internally, in order to adapt their research profiles to the required corporate needs and directions. The presence of Research & Development Department (R&D) within the corporate environment isn't therefore a new contingency. Despite this, the study of the corporate R&D contains a few peculiarities that I will discuss later in the paper.

In the last twenty years though, a brand new element has arisen in the research policies of the largest world corporations: the delocalization of the R&D in the so called 'emerging countries'. While the delocalization of industrial plants and production processes can be rather easily explained in the framework of the best-cost policies, that is to say the lowering of production costs and salary control, the delocalization of the R&Ds is a more recent, more delicate, and non immediate process to explain.

My research has followed the process of delocalization of the R&D in India, enacted by the corporation under my focus since 2000. The corporation (that I will call Oil&Techno in the following) has significantly invested in the start of several R&Ds worldwide, the most prominent of which is located in Bangalore. The Bangalore R&D is now fully working, and it represents the most effective research facility of the corporation outside the US. What has made such success possible? What have been the specific reasons that transformed the Indian R&D in a lively and productive reality?

Which differences can be spotted with respect to other R&Ds, opened by the corporation with the same goal, and still resulted as much less efficient and productive? I want to discuss whether there is anything like a context depending reason of success, and whether such dependence can be significant even for a standardized and global subject like the corporation.

During my fieldwork, started in 2009, I had the occasion of following my colleagues and informants, researchers and employees from the

corporation, outside the corporation buildings and laboratories. Despite my research specifically focused on the research process taking place in the corporation's labs, I could not avoid including in my observations also personal trajectories and life histories, and expanding the gaze from mere research processes to a wider consideration on people and research networks. What has progressively emerged is the presence of a strong and wide network connecting the large community of IT workers employed by different companies, a powerful network structured over working topics but still based on informal relations.

IT workers and their networks are a main emerging social feature in present Bangalore scenario. Outside the Research & Development Department of the Oil&Techno there is actually an entire developing world of IT informal research, people and activity. Therefore, the physical location of the R&D has turned to be a key element of my fieldwork, that needs being treated thoroughly. This is the turning point where the concept of the Technology Park enters into my interests. Indeed, a well-defined area of the southern periphery of Bangalore has been renamed in the last decades as Electronics City. Technological infrastructures and office facilities have been created from scratch with the clear purpose to attract industries and companies from India and from abroad to open their branches in this new favourable environment. Numerous companies have accepted the challenge, and the increase in working opportunities have created the conditions for the convergence of many IT young professionals, chasing in Electronics City the best opportunities for their careers.

The development of Electronics City doesn't reproduce the standard patterns characterizing the setup of a Technology Park: typically these are results of organized and structured process, as can be observed in many contexts in the west and non-western scenarios (cfr. Doha and Hong Kong examples). The lacking of a real urban planning, the more or less spontaneous circulation of people and information, and the underlying competition among the companies sharing the spaces of Electronics City don't contribute to shape the classic profile of the cooperative environment in a Science and Technology Park. Nevertheless, the occurrence of a sequence of unrelated events has created the conditions for the emerging of a scenario where the relevance of the individual company is progressively resized with respect to the importance of the overall background context.

The large majority of IT workers gathering in E-City for job-related reasons consider themselves more as citizens of such newly created city

environment than as employees of a specific Indian, or even less so, foreigner company. The physical proximity of many productive plants, as well as that of laboratories and IT firms, creates the premise for the emergence of a strong informal network that actually escapes company planning and organizational patterns. The increasing density of people commuting daily to E-City generates new needs and requests of services, connected both to daily life, such as food, sport, entertainment and health, and to technology light topics, such as phone services and wi-fi external coverage, that have triggered the development of newer E-City features.

The Technology Park arises therefore as an unplanned outcome from these scenarios, a sort of side-effect induced by a series of unrelated investments, events, trajectories, people's requirements, and follow-ups.

Let's therefore analyse this developing scenario in some more detail.

Research in the corporation

What does it mean to develop scientific research in the context of a corporation? What are the main structural and relational features that distinguish an academic laboratory from one embedded in a corporate environment? Is it possible to identify specific procedures, workflows and knowledge transfer patterns characterizing one or the other possible research endeavour? Let's briefly summarize a few evident issues at stake in the context of corporate research, pointing out the relevant discrepancies with traditional academic research laboratories; then I'll try to evaluate the potential effects that these discrepancies can have on research outcomes.

As a first theme, it's necessary to specify that the research performed in corporate environment is always applied research. Applied research requires a close vicinity and a strict interlink of the entire research process, from its very early stages, with its material output, meant as a deliverable, an object, a finite device. Applied research is aimed at answering concrete questions, rather than investigating theoretical matters, and in this sense it can be thought as a converging form of intellectual enterprise. Applied research doesn't have to speculate on the basics foundations of knowledge, and it's not supposed to produce new science; rather, it has to confidently rely on existing science paradigms and existing semi-finite technological procedures, in order to be able to complete them and therefore achieve its material results. Applied research is a transformative process from a not-so theoretical stage of knowledge to stage that is even less so. The overall task

at stake in corporate applied research is the transformation of existing devices into customized, optimized ones.

The very concept of applied and customized research calls into the game the role of the customer, the hypothetical external user that one day will benefit from the effort of the research challenge (in change of money, as the results of applied research are market products). The role of the external customer is indeed not so hypothetical, since its presence is quite strongly materialized in the labs' common imaginaries by the occurrence of strict deadlines. The customers' requirements are the pretext used by the corporation for is the imposes severe and frequent

The picture appears quite different from what observed in academic or independent research contexts, where deadlines arise and fall, depending only on links with other academic structures and their research time constraints. The main difference with the academic environment consists on the fact that the corporate labs' deadlines are pushed by market agreements, by demands from the customers and by fluctuations of money value. The corporation plans its selling strategies on the basis of detailed schedule agreements with its customers, so that the timing of all processes isn't a matter that can be any longer negotiated at the level of laboratory life.

Corporation's customers are both public subjects, as governments and states, and private ones, as other corporations: they very pay their maximum attention to the best social and economic contingencies that can be achieved when they sign a contract with a deadline agreement (Wilkins, 2005). This means that not all deliverables are suitable to be sold or bought at every time. Deadlines emerge eventually as the result of thorough cross considerations of external constraints that don't bear any real connection with the research contents and contexts.

All these issues contribute to shape a very stressful working environment. The competition among similar labs dedicated to the same productions turns to be very pronounced, and consistent economic incentives are given to those showing the best productive rates. Moreover, awards and public (though internal) recognitions are granted to the employees with the aim of trying to balance and compensate the impact of such demanding working environment. A main consequence of the stressful working conditions in the corporations is the rate of abandoning and volunteer job quitting, that is rather high in Electronic City. On the other hand, the large job offer ad the rather easy conditions under which a new

qualified job can be found make the circulation of employees and researchers very lively and fluent, creating a real problem of data protection and research security among the companies in open regime of competition.

I would say that this is the most prominent feature of Electronics City as a would-be Technology Park: the community of ideas and perspectives arises exactly from the element of little company loyalty performed by the employees. Often quitting and changing their positions, they materially create the conditions for an exchange and an unplanned transfer of knowledge and competences, that eventually results as an enriching feature for all the players involved in the process. In fact, as a specific company may suffer the loss of a set of protected information, it may also gain unexpected advantage from the implicit extra competencies brought in by new employees coming from previous working experiences.

On the economic side, the most effective strategy enacted by the corporations to try to prevent the frequent job quits is to pursue a policy of high salary, increasing the salary offer when the risks of abandoning results more severe. So, being not so strongly tied with the job ends up being a favourable conditions, allowing the employees to receive more incentives to remain (Bougleux, 2012a).

One more interesting outcome of the unplanned circulation of knowledge and competences is the frequent birth of spin-offs and new small IT enterprises, set up by entirely Indian teams, made of people that benefitted of intense training in IT sector and international perspective acquired during their jobs for international corporations. If such unplanned circulation among the companies operating in E-City could at a first sight be considered as bearing a negative backlash on companies production, the increasing number of international productive realities that still keep the initiative to settle in E-City speaks indeed of an opposite scenario. The working, economic and social condition characterizing E-City are still considered highly favourable. So let's describe them in some more detail.

Beginning and Short History of Electronic City

Karnataka State Electronics Development Corporation Limited (Keonics) is a publicly owned company born in 1976 with the objective of promoting electronics industries in Karnataka. Its profile shows both private and public features, holding a relevant role in the public policy and largely accessing to public funds, as well as being oriented to create attractive working

conditions and guarantee a good cooperation environment for private partners.

According to its own historical narration Keonics 'promoted the development of electronic industry in the State [of Karnataka] and to create infrastructure for the rapid growth of electronic industries [...]. It was envisaged to function both as manufacturer and as a facilitator as well as catalyst for the development of electronic industries and accordingly classified as development enterprise' (Keonics website).

The first land spot of less than 1,5 km² was acquired by Keonics not far from the city limits of Bangalore at the time, and something in between a village and a small suburb dedicated to host technology infrastructures was firstly founded. An independent urban reality called Electronics City started existing slowly and progressively, from what was initially only a series of technologically well-equipped new buildings. In the last twenty years though, Bangalore city expansion has dramatically changed the landscape of surrounding areas. Closer suburbs were included in the city borders one after the other, allowing Bangalore to reach the present population of over eight million citizens. At the same time, as E-City was gaining more and more relevance as a technology hub, a number of innovative Indian laws started promoting the role of local institutions as the new subjects in charge of fostering local development. E-City found itself in the proper and opportune conditions to acquire a legal and formal status. It increased in relevance, population and especially in average income, and these factors created the conditions for the start of an institutional dialogue with the city of Bangalore. The dialogue hasn't always been simple, touching crucial topics such as the regulations on land exploitation, and the administration of basic resources, as water and electricity.

The development of E-City in terms of technical structure can be shortly summarized in three steps. A first step of the city development has been characterized by the arrival of IT companies, both Indian like Wipro and Infosys, and foreigners like HP and Siemens, that during the Eighties were hosted by Keonics and shared or hired its IT infrastructures.

A second step, started approximately in the early the Nineties, can be identified with the first start of direct manufacturing of IT components by Keonics. E-City made technological products were mainly destined to the communication sector, like phones and wireless devices. For ten more years, thanks to agreements with international partners engaged in highly developed IT manufacturing (including the Italian Marconi), E-City started

developing components for its own customized communication network. A fast web network was launched in the late Nineties, trying to solve one of the worse Indian technology problem, the poor speed of the web connections. The second step developed simultaneously to the implementation of the first one, i.e. the quite lively activity aimed at attracting new companies with always new and dedicated infrastructures. Indeed an increasing number of world large companies set up to open their Indian branches in E-City, including the corporation where I developed my fieldwork.

A third step has been characterized by the beginning of the large scale commercialization of IT products labelled Keonics & E-City, starting a process of transfer of the 'Karnataka model' to other bordering Indian States, such as Kerala and Andra Pradesh. The Karnataka model is a short way to call a comprehensive process of going digital, involving production, education and institutions. The Karnataka model is strongly relying on the much smaller E-City model, as an example to trigger the development of an entire city through experiences of digitalization such as e-learning and e-government. The effectiveness of these attempts is still to be validated and analysed.

The latest regional government initiative to implement E-City dynamics has been the sponsoring of training and education activities, trying to promote the local development of careers and specialized professional profiles. The lack of strong education institutions is maybe the feature that so far has mostly prevented E-City from being considered a Science and Technology Park under every respect. The federal government initiative to promote the opening of schools and colleges in the district is aimed at filling such existing real gap.

Presently, the education offered in E-City high schools is basically technical: main topics available are programming languages, hardware and networking administration, data management for different work environments, including medical and public administration.

A strong emphasis is laid on the quality of the educational paths offered in E-City. Schooling is offered from early years, from pre-school and primary school institutions aimed at attracting young employees to move to E-City with their families, and possibly settle down there. The school system is designed according to Asian and European higher standards, promoting South Korean mathematics teaching methods, as well as Montessori approaches for pre-school younger classes. But higher education profiles offered in E-City can't really compete with those provided by academy or

traditional scientific institutions in the larger Indian Higher Education scenario, like the Indian Institute of Technology and the University of Madras. Both these institutions represent high standards of superior education of contemporary India, and at the same time they embody the legacy with history, being founded during the colonial times by the British administration. Let's therefore investigate the relevance of tradition and legacy from the past, describing one more important traditional institution, and its relevance for our discourse and across Indian history.

Panchayat, the (former) Council of Five

Panchayats are traditional form of local government, that had historically both executive and judicial functions. Land was distributed to the peasants by the Panchayat, that was also responsible for taxes' collection on behalf of the government. The Panchayat could then keep a share of the collected taxes for itself and the village (Nehru, 1964).

History of Panchayats is ancient as India: they existed before the arrival of the Mughal Empire, they were considered highly important and endowed with a variety of tasks, spanning from justice administration and controversies solving, to providing free education. The relevance of the Panchayats emerge if we take into consideration the numerous political phases and transitions that characterize Indian history: local forms of government and organizational structures had more chances to survive to the political changes, to new rulers and new sets of laws, being directly interfaced with the needs and requirements of the population, and preserving their fundamental complicity with it.

In the late XVI century the Mughal Empire introduced the role of the tax collector as someone who didn't belong to the community, subtracting this relevant function to local control. During the XVIII century the East India Company worsened the separation between the community and the administration of its own resources, eroding some more the role of Panchayats with the introduction of an authority in charge of keeping the local population registers, therefore the tracks of how much each family and village owed to the state in terms of produced wealth.

After the Mutiny (1857) the British Rule started to invert the process of Panchayats' relevance suppression, limiting their powers but still leaving them to be established and develop when local communities required it. In Gandhi's vision, Panchayat had the function to maintain, spread and also

teach democracy at a local level, instilling the sense of representation and control over the rulers that had been frustrated in the decades of the British Empire. Gandhi faced many opponents in this respect, who supported the idea that rural institutions were a legacy from the traditional past, that new independent India had to get rid of. The existence of Panchayats was eventually inserted in the Constitution of independent India only in the section dedicated to the general principles, without any reference to its functions nor to its position in the context of the federal asset of the republic (Metcalf and Metcalf, 2004).

Since the Seventies, several laws and resolutions have been approved by the Indian Parliament in the direction of re-attributing some core functions to the Panchayats, until their final reintroduction as possible local government organizations. In the context of contemporary India, centralized decisions taken in favour of structures aimed at de-centralizing political decisions represent a surprising and unprecedented event.

The new organisms, Gram Panchayats, are elected in proportion to the number of inhabitants of the village, after an authorization to their formation released by the local closest federal authority. The Panchayat keeps its historical name but its members may be more than five, and at least one third of them must be women. At least in principle Panchayat elections are independent from political lists, and as it happens for general elections, all castes and tribes must be fairly represented. They remain in charge for five years and their responsibilities and duties are to be negotiated with the federal authority. According to local requirements and needs, they are organized in structures of increasing size and responsibility, eventually interfacing directly with the regional government. In 1992 a government resolution empowered Panchayat with the extra relevant role of 'local development promoters', endowed with a list of precise tasks including industrial promotion (Metcalf and Metcalf, 2004).

Due to the federal structure of Indian republic, the relevance and tasks and density of Gram Panchayat varies significantly according to the regions. In Karnataka the relevance of the Panchayat is particularly high, being almost six thousands spread on several administrative levels.

In 1997, Keonics passed the control of the IT infrastructure over to an elected assembly representing active industries, Electronic City Industry Assembly, which was configured as a village Panchayat, i.e. corresponding to the smallest village-level local organization.

Electronic City is one of the 240.000 Gram Panchayats in present India.

At this stage of the events, the development of the City Bangalore starts overlapping with that of E-City. In the last decades, Bangalore has experienced a huge growth in terms of population, extension, services and job offers especially in the IT-related sectors of the job market. The city limits have progressively expanded in the direction of E-City until today's situation, when it is virtually impossible to distinguish Bangalore from its former suburb. As a consequence of its expansion, the city of Bangalore has acquired the status of Large Metropolitan Area, newly named Greater Bangalore, according to Indian rules applying to metropolis with over one million citizens. In 2012 the Council of Greater Bangalore has voted the inclusion of Electronic City in its metropolitan area, and here we place the start the next step of our discussion.

Intersections

Electronic City Gram Panchayat has immediately opposed its refusal, still holding, to the inclusion in Greater Bangalore metropolitan area. The ultimate decision on the legal status of E-City will be eventually taken by federal authorities, but as the controversy develops we can observe a few topics acquiring general relevance in our perspective.

The opposition of E-City creates the premises for an unprecedented kind of alliance between a traditional rural institution and an association of rampant industry IT managers. How was this possible? Bangalore has been building its modern image over the idea that technologic development has the power to drag along the citizen's emancipation. A widely diffused rhetoric connects the high average income of the Bangalore residents to the overtaking of the traditional forms of production characterizing the entire metropolitan area, now devoted to services and tertiary economic sectors. Bangalore is the effective capital of the Indian Silicon Valley, and E-City is perceived as just its engine. The inclusion of E-City into Bangalore metropolitan area is a fact that is already taken for granted, not a topic to be put under question by the vast majority of people living in the metropolitan area, and also in the rest of India.

The opposition to the inclusion posed by E-City Panchayat opens a space for discussing the general role of institutions in fostering processes of technological development. On one side, local forms of government are still perceived as a legacy from the tradition, keeping their relevance only in those issues where a close vicinity with the population may result in a more

specific capability of interpreting needs and understanding specific local features. On the other, technological development is the main factual and rhetoric topic used by all political sides for launching India into modernity, bridging the gaps between rural and metropolitan areas, connecting IT Indian professionals with the rest of the world: therefore, technological development is typically perceived as a non-local issue. Finally, recent laws have involved local and small administrative structures like the Panchayat in the non-local issues of development. Clearly, something more has to be unravelled about the relation between modernity and locality.

The official reason for the oppositions claimed by the Gram Panchayat are indeed clearly stated, and can be traced both in the deposited and public documents: the taxes collected in favour of the Greater Bangalore Council would be higher than those owed to the local Panchayat. In change of the higher costs, the metropolitan area would guarantee to E-City an efficient water distribution, preventing office buildings and facilities to run out of water, not just in the dry season, as it happens on almost regular basis. It would also guarantee an adequate electricity supply. E-City electricity consumes are higher than city averages, for obvious reasons: on the other hand there is an on-going polemics in E-City about the waste of public power performed by Bangalore public administration for non-relevant reasons, such as monuments and public buildings nightly illumination.

The construction of main roads and related infrastructures connecting the two cities has been founded so far by Bangalore City Council, showing the existence of good background relations; but a most recent episode in the political clashes was the refusal opposed by Bangalore City Council to the request of planning a new airport construction closer to E-City, being the existing one located north-east of Bangalore, distant over two hours drive. On the whole, the administration of resources results to be a crucial controversial ground, reproducing a well-known dynamics between local and centralized institutions.

Conclusions

Finally, I want to pose a more relevant consideration on the circumstances that might foster the enhancement of science and technology. The question at stake here is whether a Science and Technology Park is the most suitable infrastructure for pushing forward such development, and whether programmed cooperation and interaction among different institutions turn up to be scientifically productive in the

long term. In my observation of the Indian context, I have noticed a rather different, though effective, process. As previously underlined, the interchanges and cross communications in E-City take mainly place in a spontaneous and unorganized way; the evolution of such a picture is possibly realizable only in specific social contexts, like the Indian contemporary one, and cannot be considered properly as models. All networks and informal relations in E-City are made possible by a certain lack of central efficiency (and lack of trust in them) and, at the same time, by a very fast growth in population, opportunities and money. This rapidly changing scenario can be better understood with a nonlinear and maybe complex explanatory pattern, fitting perfectly an unplanned development process. In this effective, though simplified picture, the Panchayat and the association of corporate managers seems to play the same game in opposing the slow gigantic bureaucratic administration in India, including that of a would-be Technology Park.

References

- Bogleux, E. (2012a) *Soggetti egemoni e saperi subalterni*. Firenze: Nardini
- Bogleux, E. (2012b) *Sviluppo globale e opportunità locali: A scuola di tecnologia per conto di una multinazionale. Descrizione di un caso di studio a Hyderabad, India*. In Cianci, E. (eds.), *Epistemologie in Dialogo? Contesti e costruzioni di conoscenze*. Rimini: Guaraldi.
- Bogleux, E. (2012c) Trasferimenti di conoscenza e sviluppo dei mercati globali. La negoziazione delle competenze scientifiche e tecnologiche nel contesto di una realtà mediorientale. *Archivio Antropologico Mediterraneo*, XV, 14 (2), 5-14.
- Keonics (2014) Karnataka State Electronic Developing Corporation Limited website. www.keonics.in/index/history.php. [Accessed : 10th March 2014].
- Metcalf, B. and Metcalf, T. (2004) *Storia dell'India*. Milano: Mondadori.
- Nehru, J. (1964) *The Discovery of India*. Calcutta: Signet Press.
- Wilkins M. (2005) *Multinational Enterprise to 1930. Discontinuities and Continuities*. In Chandler, A.D. and Mazlish, B. (eds.), *Leviathans: Multinational Corporations and the New Global History*. Cambridge: Cambridge University Press.



From physical to digital. A new way of interaction with an Integrated System of smart appliances

Silvia D. FERRARIS*, Lucia RAMPINO
Politecnico di Milano

As ICT is invading the realm of everyday objects, many products are becoming always more interactive and smart. This trend makes product designers wonder about the meaning and potentialities of this new man-machine interaction. While a first phase of products' digitalisation has seen the arising of 'smart' concepts, that were not successful (such as the refrigerator that sends you a message because your milk is spoiled), today we are witnessing the development of promising concepts of interaction between digital interfaces and industrial products. In this article the authors present, as an example, a prototype of interface developed and tested within the Research Programme 'Sviluppo di un sistema integrato di nuovi elettrodomestici a ridotto consumo energetico', cofunded by the Italian Ministry of Production. The aim of the Design researchers was to transfer part of the physical interaction, that typically occurs within domestic appliances, to a digital interface able to control the whole Integrated System of Appliances. The assumption was that it could lead to an advantage, in terms of energy optimisation, by making users aware of their consumption. The challenge was to make this interaction both pleasurable and functional. The research brought about some crucial issues, that will be discussed in this paper.

Keywords: Product interaction; data visualisation; smart products

Introduction

In the late 80's the debate about the dematerialisation of practices and media, deeply concerned who deals with product design matters.

At the beginning of that debate, the general thought was that many physical products would be eventually substituted by immaterial contents

* Corresponding author: **Silvia D. Ferraris** | e-mail: silvia.ferraris@polimi.it

(Manzini, 1990; Negroponete, 1995; Destrouzos, 2001). But if we go back at reading such essays, we will find that predictions were at the same time right and wrong. They were right because the switch from physical to digital matter really took place (just think of the changeover from mail to email).

They were wrong because this switch did not mean a dematerialisation of our world. One example over all: in the Nineties Negroponete (1995), just like many other IT experts, was suggesting that in the future printed books would be substituted by files. That is true, books printed on paper are slowly disappearing (even though maybe less slowly than predicted), while they are still edited in their digital form. However, they are not read on computers, they are read on tables or electronic book readers. These last ones in particular, are brand new physical products that did not reach a wide market until the need to read electronic books arose. Therefore, dematerialisation is a real phenomenon that is taking place, but it does not implies that less products are needed and manufactured. On the contrary, the management of this new and abundant 'digital matter boosts the development of new products (such as the e-book reader) and makes old products become 'smart' (by mean of sensors and interfaces that enhance their functions).

This trend is so in vogue that today technology-experts speak with enthusiasm of the 'Internet Of Things' (Stephenson, 2012; Brynjolfsson and McAfee, 2014) referring to a world where all things will be smart and connected in order to serve at best our needs and wishes.

In this perspective, the focus of this paper is on the trend of adding digital interfaces to existing products (more in details, to domestic appliances) in order to make them 'smart'. Such a trend makes product designers wonder which are the potentialities and the advantages from the user point of view and in which ways this new ICT content changes the way these products are perceived by users.

While a first phase of products' digitalisation has seen the arising of 'smart' concepts, that were not successful (such as the refrigerator that sends you a message because your milk is spoiled), today we are witnessing the development of promising concepts of interaction between digital interfaces and industrial products. We believe that this progress is reached when engineers and designer cooperate from the very beginning to the development of products that are not just technically feasible but also useful (Ferraris and Maiocchi, 2005). In other words, innovation should be driven by design and technology together, not by technology alone (Rampino, 2012). Indeed a first phase of products' digitalisation has seen

From physical to digital.

A new way of interaction with an Integrated System of smart appliances
the arising of 'smart' concepts, that were technically feasible but were not successful on the market (the field of home automation is full of examples).

The effort today is to merge technical possibilities with users' needs and requirements. This is exactly the aim of the Project presented hereafter.

Designing the innovative interface of an 'Integrated System of Domestic Appliances'

The Research Programme 'Sviluppo di un sistema integrato di nuovi elettrodomestici a ridotto consumo energetico', ('Development of an Integrated System of new energy efficient Domestic Appliances') co-funded by the Italian Ministry of Economic Development, started in 2009 and is now coming to the end. The body in charge of the Research is Whirlpool Europe, global manufacturer of domestic appliances, while eleven companies and five research centres are partners, one of them being the Design Department of Politecnico di Milano and the others being Engineering Dept. of the same Athenaeum.

Programme aim

The Programme general objective was to design, prototype and test a smart system in which the following elements would be integrated: the smart appliances (that are traditional appliances able to connect to the System to optimise the energy consumption); the renewable energy sources (such as solar panels); and not-smart appliances that can be integrated through the use of smart plugs (i.e. an iron).

The enlarged project team was made up of mechanical, energy and computer engineers, ICT experts and designers. Among those, two companies (Whirlpool and Genius) and two research teams (the ICT experts of Cefriel and the Design team of Politecnico di Milano) were involved in the making of the prototype.

The final aim was to enable the user to interact with the prototype of the Integrated System so to test if it would help him/her to achieve an optimal overall management of his/her domestic energy consumption.

Specific design aims and process

The specific task of the Design Researchers (DR) was firstly to understand all the potentialities of the new Integrated System, in order to

design the interface of the Smart Display that would mediate the interaction between System and user.

In the original description of the Research Programme (that was written back in 2008), it was not defined how this interaction would take place. Actually the Programme was open to any kind of innovation. Then, during the development of the Programme (from 2009 to 2013), new devices - tablets and smart phones - reached the market and spread successfully all over the world: for instance, Nielsen, a leading US based global information company, in June 2012 provided market research reports that from May 2011 to May 2012 smartphone penetration has gone up 34 percent and tablet adoption is up 400 percent. This trend developed people's skill of using touch screens and software even embracing those who were not using computers yet. Thanks to this scenario, in February 2010, when the design of the user interface begun, it was considered very reasonable to use a tablet as a support. After taking this decision, the design process of the interface could start. It was made up of the following 3 steps:

- Analysis on the state of the art;
- Design phase;
- User test.

Through all these phases, the DR team interacted with the engineering partners of the Project involved in the making of the prototype. This collaboration was essential for designers to deeply understand the System potentialities and transfer them to the interface.

State of the Art

The idea of connecting domestic appliances in a system in order to save resources is widely explored nowadays, in particular from the point of view of electric energy in the field of research that goes under the name of 'Smart Grids'. A Smart Grid is an electrical grid that uses communications technology to gather consumption information and display them to the final user. The aim is to improve the efficiency, reliability and economics of the production and distribution of electricity. Not surprisingly, it is a research topic on which both local Governments and EU are making huge investments (www.smartgrids.eu).

In the first step of the design process, we surveyed the state of the art on this subject, with particular regard to the interface contents and elements.

The survey analysed 21 interfaces of smart-homes and services based on smart grids (i.e. Intelligy by Millennium Electronics, www.intelligy.com.au/system-components.php#intelligy-display; Chorus by Green Energy Options (GEO), www.greenenergyoptions.co.uk/support/chorus-support/choruspv/; SmartMonitoring by AlertMe, www.alertme.com/try_the_demo).

All the analysed interfaces have similar homepages: they display a set of basic data on consumption (i.e. daily average consumption of energy) and status of the system and its components (in smart homes the systems might also include other sub-system such as security systems, entertainments, etc.). Then, they display a set of icons that let the user access more specific data (i.e. records of historic data on energy costs and/or consumption). Some good examples were found for the representation of consumption data, but no one for the representation of the system of appliances.

After the analysis of the already developed Smart Grid interface, it emerged that three were the design challenges to face:

- how to represent the Integrated System, so that users would identify it, appreciate it and be intrigued to use it;
- select the contents (basic data and extra information) and interaction elements (icons, feedbacks, etc.) of the new digital interface;
- find the best way to transfer the typical physical interaction with home appliances (i.e. turning a knob of the washing machine) to a digital interface.

Design phase

Challenge 1: to represent the System

As already said, none of the analysed examples displayed a conceptual visualisation of the System. Therefore, the DR team decided to visualize the System for what it is: a group of single appliances connected together to create an extra entity. The connection makes the relationship; the relationship makes the system. For this reason the System is visualized through the icons of the smart domestic appliances graphically connected with a line to a bigger System Icon representing the home 'Real time total consumption'.

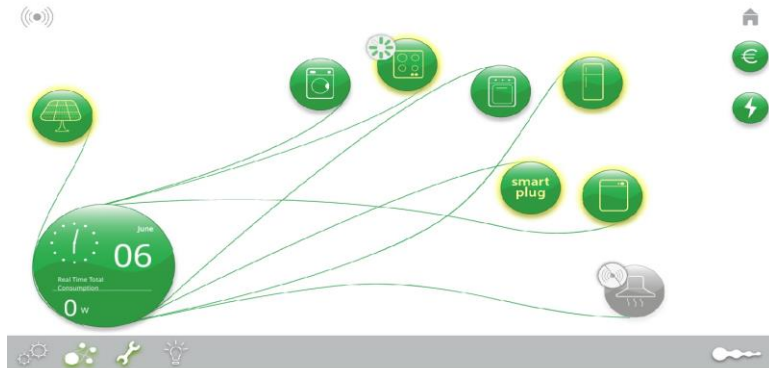


Figure 1 homepage

The homepage visualization (figure 1) aimed at simplicity. For this reason, very few data are present on it: date, time and 'Actual total estimated consumption'. Still, the homepage communicates much more information without the usage of words or numbers. The appliances icons can be in three status:

- grey means: 'the appliance is not connected to the System';
- dark green means: 'the appliance is connected but not in use'
- light and luminescent green means: 'the appliance is connected and in use'.

In case of appliances that have cycles of use (i.e. the washing machine), such cycles are represented by a small rotating wheel.

Other information are easily available through icons: the costs, the electric consumption and a set of functions that regards the interaction with the System (i.e. the historical data of consumption) and are placed in a grey task bar below. By these design choices, the DR team managed to get in a single view the 'idea' of an Integrated System of appliances and its status at the moment.

This design choice proved to be effective. Indeed, through the usability test (see paragraph 'User Test'), users immediately understood the meaning of the visualization and appreciated its simplicity.

Besides that, the DR team was aiming to give the user the feeling of interacting with an 'eco-efficient' System. As for the general aim of the Project, 'eco-efficient' was referring to the fact that users would be saving money and energy by optimizing the consumes, selecting the best timing of energy supply (concept at the base of any smart grid projects). Thus, the

interface should encourage consumers to use a smart approach to energy consumption.

In this perspective, the DR team chose to apply white and green colours as a basic tint for the interface. While green is a typical but extremely effective choice for any *sustainable looking* project, white colour refers both to the category of white domestic appliances and to the current trend of product design aesthetic started by Apple that expresses values of simplicity together with high quality.

Furthermore, the DR team designed the System with sinuous lines and a casual layout of the icons, so that it could resemble a biological body, with no direct reference to any specific vegetable or animal. The DR team thought that an abstract representation could transfer the feeling of 'eco-efficient' without using any naïve representation of trees, flowers, jellyfishes or any other living beings that had the kind of shape that was necessary to the project.

The result, as shown in figure 1, is a simple interface with a basic white canvas and green elements.

Challenge 2: to select the contents and interaction elements of the new digital interface

The main issue about selecting the contents of the System Interface was to pick the only ones interesting to a general user. Particular concern was about numbers and values that refers to energy consumption. Indeed, many users might not be familiar with data based on watt or kilowatt-hour, thus they might not be able to evaluate consumption performance of a single appliances or whole System, if expressed only by watts.

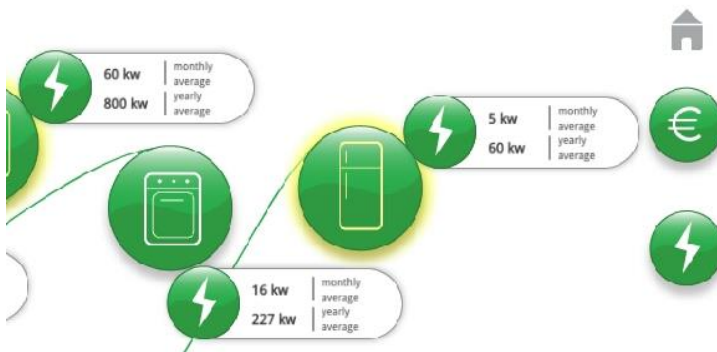


Figure 2 visualisation of energy consumption with data comparison.

To face this issue, the DR team decided that any single data about energy consumption would be shown by comparison to an average data. For instance, on the homepage the users can select the icon 'Energy' (a lightning) and they will get the monthly and yearly average consumption of any appliance (figure 2). The same approach was chosen to cost consumption data. This approach is applied in some case studies analysed during the state of the art of smart grid interfaces (among the previously mentioned examples see www.alertme.com). It was positively evaluated during the user test. In particular, the comparison of data was considered very interesting when reading the historical data, which were very appreciated by test users.

About the graphic elements of interface (such as icons), the DR team decided to use existing ones as much as possible, even copying those of Whirlpool's products. This choice was due to the necessity of making the interface intuitive and easy to use. The DR team knew that the main problem for the user would be to interact with a System that actually is an *immaterial entity* made of *physical products*, placed in different part of the house. Therefore the effort was to design an interface that at least had very common graphic elements of interaction. The only icon that has a brand new design is the 'historical data' icon (down right in the homepage, figure 1), because we could not find a largely recognised icon for this subject.

Challenge 3: to transfer the typical physical interaction with home appliances to a digital interface

This last challenge raised several design questions at the very beginning of the project. As part of the overall System, the DR team was asked to design the specific interface of the four appliances that would be part of the final prototype: fridge, oven, cooktop and washing machine. In the Project, four Whirlpool smart appliances were chosen because they were already developed at the level of prototypes. Therefore, the DR team had both the products (with their interfaces) and the instruction books to start from.

The first question was if the digital interface should or not be as much as possible similar to the product interface. This issue was a matter of discussion with the engineering partners. There were two main options to take. One option was to create a 'general' digital interface for each smart appliance so that it could work for any product that would be connected to the System in the future. That would allow Whirlpool to give, for instance, the same digital interface to different smart appliances. In this scenario, the user should learn only once how to use the digital interface to interact with

From physical to digital.

A new way of interaction with an Integrated System of smart appliances

the smart appliances, and then buy and change smart appliances with no need to learn every time a new digital interface. On the other hand, the digital interface would not be similar to that of any specific product. Thus, for example, the generic digital interface of the fridge would differ from the physical product interface. This could mislead the user interaction. Indeed, even if the functions are very often the same (think about a typical washing machine knobs) they change from product to product in the way they are displayed or called or described by icons.

Therefore the DR team decided to make any effort possible to transfer the four product interfaces to the digital interface making them as similar as possible. This choice means that the digital interface has to change every time a smart appliance is substituted in the System. Plus, of course, any new smart appliance would require the implementation of its own digital interface too. This is economically not very smart, but perhaps it would make the manufacturer put more effort in the alignment of products interfaces.

To repeat the product interface onto the design of the digital interface was not easy at all. The four products represent very different problems to face.

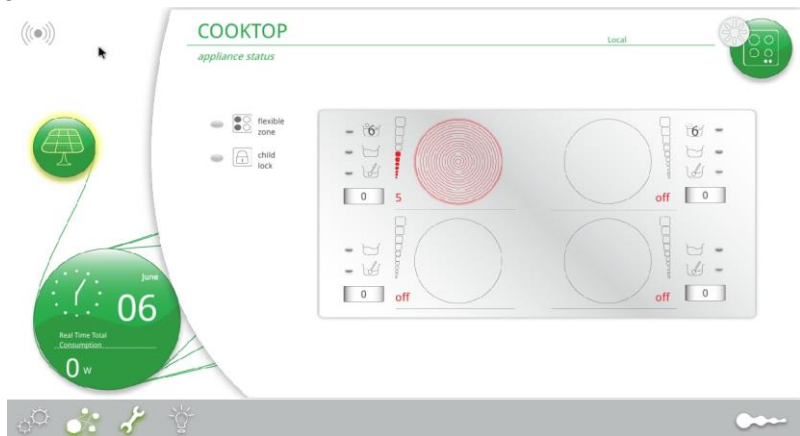


Figure 3 Cooktop digital interface.

The fridge and cooktop were the simplest. Indeed, the fridge has few functions to interact with and, the cooktop, for security reasons, cannot be activated by a remote control. Therefore the product digital interface has just an informative aim.

The DR team developed two interfaces that display a general layout of the product and the functional icons (designed exactly as the ones on the product). This way the users immediately recognizes the layout and functions. For instance, the cooktop digital interface (figure 3) shows which fire is on, its level of temperature and, if any, the cooking time set. Also it shows if the 'flexible' or 'child lock' functions are on.

Oven and washing machine were much more challenging. They can be operated by remote control and have a new function to display that was called 'green/comfort option' (it enables the user to let the System choose the best time to run a cycle and requires a time to end by; or it enables the user to set the mandatory starting time of the cycle). Choosing 'green' or 'comfort' might result in a different value of the 'estimated consumption' that appears down left in the digital interface, where the green option will result in a saving of money. This option was designed to reach the Project aim, that is to help the users prefer green options in the use of the System.

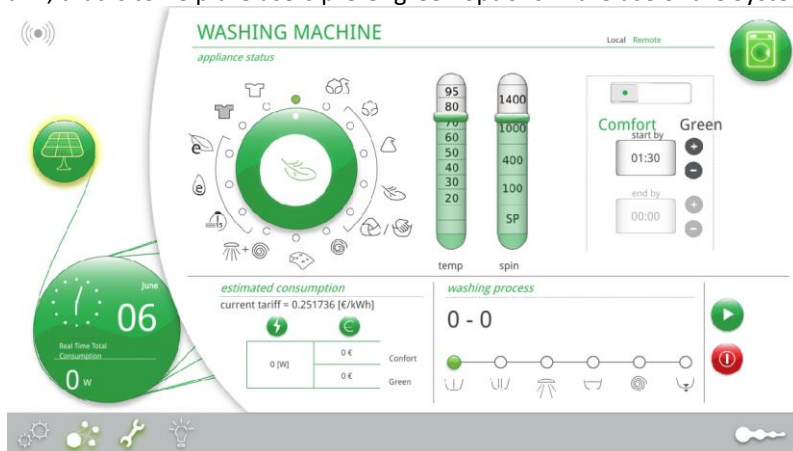


Figure 3 Washing machine digital interface

So, looking at the washing machine case, typically the user interacts with a physical knob, around which are displayed a number of icons, with a clear meaning of 'rotating to select' and a physical and sound feedback to the action. On the tablet, there would be no need of a wheel to select washing programs or temperatures. The selection could be achieved in a different way, for example by shifting a slide bar (option that requires less space on the screen area, for instance). In this case, the non-correspondence between the function and two different layouts should be fulfilled by the user.

From physical to digital.

A new way of interaction with an Integrated System of smart appliances

For this reason, this option was discarded. Indeed, it is exactly the opposite features that make interfaces easy and pleasurable to use: steadiness and constancy of references (Nielsen and Loranger, 2006) .

The resulting digital interface was very much a mix of functions similar to the product (washing cycle setting wheel, temperature and spin sliding bars and washing process line) and new functions (green/comfort option and estimated consumption). These functions were displayed so to follow the users process of interaction: first select the cycle, then the temperature, then the spin, the green/comfort option, then check the estimated consumption, in case change any option and click start. The 'washing process' is only an informative visualisation.

User Test

The last task of the Project was the test for assessing the usability of the interface prototype. The task was planned in two phases: a preliminary test (PT) and a laboratory test (LT).

Methodology

The PT was held at the Design Department of Politecnico di Milano. It aimed at checking the level of understanding and user-friendliness of the interface.

Ten test-users interacted with a tablet where the Smart Display was uploaded. The tablet was not connected to the Integrated System of smart appliances. So, in this phase, the testers tried the accessibility of functions and information, but not the feedbacks from the System. At the end of each session, the test-users filled out a questionnaire and gave free comments. The results were analysed to check if any major change was necessary to the Smart Display before the LT. The test was positive and resulted in a list of recommendations for the LT phase.

The LT was held at the Whirlpool headquarter (Cassinetta, VA, Italy) where the System prototype is set. It aimed at checking the ease of interaction with the System through the interface. Four test-users interacted with a tablet where the Smart Display was uploaded and connected to the System of smart appliances. So, in this phase, the testers tried both the accessibility of functions and information and the feedbacks from the System. At the end of each session, the test-users were interviewed by the Design researchers, who followed a questionnaire to collect comments.

Both tests were based on four phases of evaluation:

- ‘at first sight’: feedbacks on the soft values of the interface;
- ‘trying to use the interface’, identification and test of functions
- ‘clarity of the interface’, comments on communicative efficacy of graphics and navigation mode;
- ‘utility of the system and interface’, more general comments on the validity of the Project.

The results of the two test phases were integrated and analysed. Some major feedback regards the design issues.

Results

Regarding the representation of the System in the home page, the test users response to the question: ‘is it clear what it represents?’ was completely positive. Also the question about the understanding and accessibility on the interface *in general* was positive. Still, some feedbacks highlighted some improvements that are important to consider. The answer to the question: ‘did you feel like you were interacting with an ecologic System?’ was not completely positive. Two options to solve this point could be: on one side, to add images that refer to nature (i.e. drawings of leaves) or, on the other, to enhance the perception of interacting with a green System by abstract means. This idea was not implemented in the prototype, but it could be in the future. Indeed the prototype displayed the icons in a static layout on the screen, but in the future development icons could be floating up and down in reference to the consumption of energy. Also the connecting lines could represent the passing of energy in a direction: from the System to the appliances or from the solar panels to the System. This way it would be highlighted the presence of green energy that comes from solar panels (or other green system of the house). The DR team believes that if these effects were implemented, the System would look more ‘alive’ and metaphorically representing what is going on. If the users thought the system to be constantly active, they might be more involved in interacting with it and trust its role in the optimization of home energy consumptions.

Of course, such an implementation would require a more complex software engineering to support it. That being said, the representation of the System of appliances proved to be effective.

Regarding the four appliances interfaces, the design decisions proved to be very positive during the user tests. The only comment to consider is that users were intrigued by the possibility of interacting with some functions (such as turning on a ring of fire of the cooktop) and felt sorry not to be able

to do it. This can be taken as a hint: users seemed interested by the opportunity of interacting with such products with a remote control, even if nowadays security regulations do not allow this interaction to take place.

On the washing machine, the user test gave two different feedbacks. As for the functions that are already known and similar to the product, the interaction was perfectly easy and intuitive. While the green/comfort option was considered a very interesting function that needed extra information to be understood at the first use. The advantage of a digital interface is, indeed, that adding extra information is possible and simple to do. This suggestions applies also to another note received by test users, that is to have information about the washing cycles (i.e. not all user are familiar with the icons, no matter how common they are already). Indeed this is one of the advantage of interacting with a tablet. The users can read the information about washing cycles, or any other hint and tip that the System suggests, sitting comfortably on a chair rather than leaning on the front of the washing machine where the interface usually stands. This means that users might spend more time interacting with their smart appliances.

Regarding the results on the choice of contents and interaction elements of the Smart Display, we can say that the icons and actions were clear when they were already know ones, while they need an explanation if they are new icons and functions. For instance regarding the 'historical data' icon, during the test, users had to try it to find out what it was at the first use. Then, they all agreed both on the clearness and usefulness of the historical data. Regarding the contents, all users commented that they would enjoy having even more information on the Smart Display, such as: details about usage of the their appliances, understating about how the System works, hints about washing machine cycles, or any other data they might found out about their domestic appliances and use of the System.

Conclusion

The development of the new interface for the interaction with a System of smart appliances let the Design Researchers achieve different levels of result.

Some of them are 'context specific', and regard the quality of the designed interface and the improvements that could be made to enhance it, as described in the paragraph on the results of the user test. These results could be useful to other design groups facing the challenge to design a similar interface, in the same way the interfaces we surveyed in our State of

the Art were useful to our design project. In particular, the recommendation to visualise the System is certainly very useful and applicable to many similar cases.

Others results are more general and refer to the way the interaction with the interface of the System changed the perception of the appliances by users. Indeed, beside the feedbacks on the interface quality, the DR team realised that users, who typically do not ever read appliances' instruction books, stated to be interested in deepening the knowledge of their domestic appliance functions and efficiency by interacting with the smart display. It seems that a digital interface could give to the appliances a conceptual identity that users did not perceive before. A new perception of the product would arise: it would not be just a 'machine that makes the job', but a entity to interact with it, besides the job itself. The DR team believes that this is a new value that is worth developing.

This could lead to a higher interest of users for smart appliances because they build a more personal and interactive relationship with them. This is certainly a field worth studying both for researchers and manufacturers.

References

- Bauerlein, M. (2011) *The Digital Divide: Arguments for and Against Facebook, Google, Texting, and the Age of Social Networking*. New York: Tarcher.
- Brynjolfsson, E. and McAfee, A. (2014) *The Second Machine Age: Work, Progress, and Prosperity in a Time of Brilliant Technologies*. New York: W. W. Norton & Company.
- Dertouzos, M.L. (2001) *The Unfinished Revolution. Human-Centered Computers and What They Can Do For Us*. New York: HarperCollins.
- Diani, M. (1988) Immateriality Takes Command. *Design Issues*, 4 (1/2), 6-11.
- Ferraris, S. D. (2006) *Developing New Products in the field of Home Automation. Methodological overview and pilot scheme*. Paper Presented at the Proceedings of The 1st International Design Management Symposium, Shanghai.
- Ferraris, S.D. and Maiocchi, M. (2005) *L'invasione degli infoprodotti. Riflessioni di design per una tecnologia domotica dal volto umano*. Roma: Aracne Editrice.
- Macchi, G. (1996) *Solid side. The search for consistency in a changing world*. The Netherlands: Inmerc BV.

From physical to digital.

A new way of interaction with an Integrated System of smart appliances

- Manzini, E. (1990) *Artefatti, verso un'ecologia dell'ambiente artificiale*. Milano: Domus Academy.
- Moles, A.A. and Jacobus, D.W. (1988) Design and Immateriality: What of It in a Post Industrial Society? *Design Issues*, 4 (1/2), 25-32.
- Negroponte, N. (1995) *Being digital*. New York: Vintage Books.
- Nielsen, J. and Loranger, H. (2006) *Prioritizing Web Usability*. Thousand Oaks: New Riders Publishing.
- Rampino, L. (2012) *Dare forma e senso ai prodotti*. Milano: Franco Angeli.
- Scoble, R. and Israel, S.P. (2014) *Age of Context: Mobile, Sensors, Data and the Future of Privacy*. Norfolk: Brewster Press.
- Stephenson, W.D. (2012) *SmartStuff: an introduction to the Internet of Things*. Ebook.



Grounded Reflexivity: an approach to the polysemy of Responsible Research and Innovation

Robert GIANNI* and Philippe GOUJON
University of Namur

RRI could represent a chance or a danger according to the fact that we consider it to be a contradictory conception or a complementary one. If on the one hand we could think about it as an umbrella term that represent itself a framework for research and innovation, on the other hand the danger is that RRI can be framed by one of the different subsystems that it should include, so adopting a reductive way and contributing to exacerbate the contrasts instead of solving them. The two supposedly clashing logics of responsibility and innovation should be considered as interconnected. This put in evidence the importance of an institutional implementation of RRI, that is, a frame that includes the different aspects (economical, juridical, moral) based on a social and reflexive participation.

Keywords: *Responsible research and innovation; rthics; participation; social RRI*

Introduction

The aim of this essay is to dig into the apparent contradiction of RRI in order to show how it is the fruit of a reductive perspective. We will briefly introduce the problems connected to RRI in practice and theory to then suggest that most of them are false dilemma. In order to demonstrate our hypothesis we will try to propose a different understanding of the two terms at stake. First with Parsons we will put in evidence how economy needs to be considered as a subsystem of society together with other subsystems to which it is equal. This will also show how every subsystem is at the same distinguished and connected with each other. Then, analysing the responsibility concept through Ricoeur we will highlight how also

* Corresponding author: **Robert Gianni** | e-mail: robert.gianni@unamur.be

responsibility embeds different acceptations that throughout history and for several reasons have been mostly forgotten. Responsibility will turn out to be the one side of a coin named justice the other side of which is represented by freedom. Accordingly, we suggest considering responsibility and freedom in a complementary way.

Translating the interconnections between different subsystems and different acceptations into ethical terms means that different normative sets are interlaced with an equal weight, making RRI a representative frame for society, more precisely an ethical frame. But ethics is a frame that needs to be handled and maintained by means of political action. Thus a RRI political approach shall facilitate and strengthen communication between different subsystems. So to speak, we will propose three key issues for the implementation of RRI as a frame. These are participation, reflexivity and the reference logic that is a social one. We will finally suggest that only institutional bodies can carry out the task of enacting and enhancing such a process.

The EU seeks to become a genuine Innovation Union in 2020 striving for excellent science, a competitive industry and a better society without compromising either on sustainability goals or on ethically acceptable and socially desirable conditions. Europe thus needs to develop a normative and comprehensive governance framework for Responsible Research and Innovation (RRI).

However, this raises new questions regarding the relation between technical development and society that are often hard to deal with. This matter has been demonstrated by various cases in recent history, for instance, the research on genetically modified organisms (GMO), where the resulting controversies and ethical issues had a broad resonance in society and generated serious economical counter-effects.

Consequently, the societal challenges accompanying this kind of research cannot any more be addressed only by the research community, but also need to include a societal perspective (Lund Declaration, 2009). What appears difficult on paper shows to be even harder in practice.

The first and most basic question regards exactly how to conceive a responsible kind of innovation? As understood by recent projects and literature (GREAT Project, Responsibility Project, Res-Agora Project; Owen et al., 2013), responsible innovation seems to be a paradoxical conception, given the fact that the couple appears to pertain to two different and opposite rational spheres (Habermas, 1984).

In fact, on the one hand innovation is usually intended as a flow running through technological developments, based on a strategic approach to progress, aimed at marketing or develop marketable products and processes. On the other hand, responsibility, although facing different ranges of understanding given the polysemy of the term, is generally conceived as an ethical matter related to the potential consequences that may occur with innovation. This implies somehow that responsibility, and therefore ethics, is understood to represent a limit to innovation. The main difficulty stands then in conceiving an innovation process that could be responsible in terms of consequences without hampering the marketization or technological development.

We believe that in reality, although being distinguished, they do not stand as opposite, but that a reductive perspective on the question tends to places them into a clash. On the contrary the mistake lies exactly in keeping this opposition alive through different means. The current evaluation tools (e.g., risk assessment), by which responsibility is embedded more or less in research, tend to maintain this opposition either implicitly or explicitly.

Indeed one of the characteristics and at the same time the complexities inherent RRI stands out in its poliedric capacity of merging together issues apparently disconnected when not contradictory. But these fields should be intended as collaborative and not conflicting. Under the label of RRI different fields can be included such as the juridical, the economic or the moral one. Such a poliedric attitude is promoted and guaranteed from two factors. The first one, as we have hinted already, that it has to keep together in a harmonious way opposite logics as the one pertaining to research or innovation and responsibility. The second one is provided by the polysemy embedded in responsibility itself, where the term responsibility can mean different things and address different aspects of research and innovation (Owen et al., 2013).

I)

An innovation always occurs in and for a social system, where it can be placed, or sold, but more generally adopted and used (Godin, 2014). Of course it can also be rejected by some parts of society at a certain specific moment but still the innovation will be 'present' and can't be cancelled. The empirical problems rise from the fact that some recent innovation were exactly rejected by large parts of society for safety, moral or ethical reasons.

What is usually contested in these occasions is the fact that those innovation will not contribute to improve the well-being of society in general but only of few, endangering societies from reproducing the conditions of their own subsistence. Those attempts of innovating were then claimed to be unjust because they were considered to be non-ethical.

Our hypothesis is that the mistake lied and still does in conceiving an innovation only from the market perspective (and furthermore failing in understanding what the market represents (Pavie, 2014) and this mistake can be solved only at an institutional level.

In order to help us defining why and in which way, we need to understand the poliedric character of RRI that is, the interconnected nature of the subsystems participating to it. In order to do so we will refer briefly to a text by Parsons where the American sociologist stresses out the importance of a complementary approach of social systems especially with regard to economy and society.

In the 'Marshall Lectures' (Parsons, 1991), Parsons tries to highlight how the logic of economy cannot be conceived independently of society in which is embedded. Starting from its general understanding of social systems and subsystems, Parsons shows how the most inclusive one, of which all the others represent sub-spheres, is society. According to Parsons a society *'is not only itself a social system, but even more important it is a complex network of subsystems, not only on many different levels of inclusiveness from its total economy to a single family, but also cross-cutting each other. Thus the 'engineering profession' as subsystem of a modern society cross-cuts the differentiation between economy and 'polity'; it participates in both'* (Parsons, 1991, p. 13).

Within society then we find structural differentiations, that he calls *subsystems*, and actual differentiation that he defines not through ontological categories but through the sociological label of *roles*. Without the need to go in depth in the preconditions for a system to work, it is important to highlight how Parsons stresses the necessity for subsystems *'to maintain their boundaries, but at the same time to adapt to the situation outside the boundaries'* (Parsons, 1991, p. 15) and the fact that, *'the value-system of a subsystem of a society is a differentiated variant of the general value-system of the society'* (Parsons, 1991, p. 25).

Following this framework, Parsons proposes to treat the economy as well as the other fields, thus to consider it as one subsystem of a more inclusive system (society) that follows certain specific 'variables' but relies on the same general parameters. In his understanding, economy, as every

other subsystem, wouldn't survive if it wasn't for its relational nature (based on action and sanction both internally and 'amongst other subsystems) and if it wouldn't follow also external extra-economic criteria (input). Parsons explanation tends to stress the functional role of subsystems, showing, for instance, how economy has to rely on both, internal and external, relational criteria.

Thus, following Pareto's assumptions, Parsons believes that economic efficiency, for instance, is a general parameter common to many subsystems. Economic efficiency, *'must be regarded as a function of all of the basic social system variables[...] A relational quantity must be treated as a function of all the terms of the relation, not just one or two of them'* (Parsons, 1991, p. 19). As well non-economic factors *'are not the resultants of the operation of one or more sets of 'non economic' variables whereas the economic aspect is the resultant of a different and independent sets of variables'*(Parsons, 1991, p. 16).

Instead, Parsons shows how economy as a subsystem always have to rely on factors that are non-economic ones.

Of course this understanding is not meant to underplay the crucial role that economy plays in a society. Parsons is quite clear when he confers economy a special character due to the importance that it assumes in highly-differentiated societies as the Western democratic ones. Parsons, justifying this perspective by mean of his functionalistic frame, explicits how this interconnection is not at all unbalanced on one side, but how also other subsystems are partially built on some sort of economic logic. In short, what Parsons helps us to understand, even if in a functionalistic way, is the fact that different fields can survive and evolve only thanks to their interdependence in a societal system that is the only reasons for which they were created and for which they make sense. In Parsons' perspective all these subsystem are institutionalized with specific goals and relying on a distinctive logic. Thus, an economic institution will have to follow some profit-oriented goals in order to fulfil its very nature. At the same time however, this same institution must not disregard its interdependent nature. As showed also by other economists (Bowen, 1953; Pavie, 2014; Piketty, 2014), a company exists because society needs it and accepts it. Therefore every development in the economic sector must always rely on a normative and social presupposition even if by infringing it. For Parsons this two-folded nature of institution is crucial. On the one hand they have be distinguished and follow their own purpose. At the same time they have to

be able to communicate and to be influenced, to a certain extent, by other spheres. The balance between this double-nature of institutions shouldn't be undermined.

II)

If Parsons shows us the importance of putting in evidence the interconnected and complementary nature of different subsystems among distinguished fields, Ricoeur was able to achieve a similar result with his genealogical analysis of the concept of responsibility.

In his famous essay on responsibility Ricoeur highlights how the concept of responsibility is well fixed in the classical juridical dimension but how at the same time seems to not have an external correspondence, a philosophical ancestor to look at. According to Ricoeur if we want to find such a predecessor we need to shift our attention from the root of '*respondere*' to the one of '*imputare*', to go out from the juridical field into the political one. For Ricoeur, although this acception maintains the basic and classical character of accountability (to account someone of something), it also embodies a more sophisticated nuance that is the necessity and possibility to ascribe an action to someone. Without recalling extensively the precise genealogical explanation provided by Ricoeur, what the French philosopher puts in evidence is the double movement between an action and an actor within society. If on the one hand the actor commits an action for which he will be held accountable, on the other hand this action needs to be ascribed to him. What seems to be a tautology in reality unveils an aspect that is quite surprising, that is the openness of such a conception.

As we know the major problem with RRI is the fact that it requires to assign responsibility for something that has not been yet conceived. Who could we account the responsibility to if the action and the result of it are not known? All that cannot be ascribed directly to an actor represents, according to Ricoeur's reconstruction, an external area that cannot undergo the criteria of accountability but will still be under the responsibility frame in the sense that consequences will happen. Accordingly, responsibility needs to be considered as something more than a mere compensation of damages by a specific actor, but rather as a load that needs to be ascribed to every agent. As we will see this weight is what makes freedom possible.

This antinomy between two causalities that was brought about by Kant (Kant, 1955), appeared as a puzzle to many after him. Ricoeur indicates two main ways in which this contradiction was 'developed'.

The first one can be found in Kelsen (Kelsen, 2009), that considered only some parts of Kant's production and resolved the antinomy with the acceptance of retribution (economic-juridical), cancelling the one of attribution. A development that Ricoeur defines as such: *'This process of disposal, basing itself only on Critique of Practical Reason, falls, in Kelsen, for instance in his 'Pure Theory of Law', in a total moralization and juridicalization of imputation. At the end of this process, we can affirm that the idea of accountability (of a fault) has supplanted the one of attribution'* (Ricoeur, 2007, p. 20).

This understanding concurred to a reductive development of responsibility, ending in a scenario where too often responsibility has been reduced to its legal or economic side at the detriment of its ethical side.

However, there is another author that had a different idea and that could serve our purposes. According to Ricoeur, Hegel was fully aware of the contradiction expressed in Kant's dichotomy of morality and necessity (Hegel, 1991). At the same time he was also conscious of the reality of such a statement and the importance of maintaining them together. For Hegel, it was impossible to distinguish clearly between the intention of an actor and all the consequences of an action. The space between what I can control and all the other indirect consequences cannot be covered by an anticipatory effort of the actor. In Hegel this gap is bridged passing from the moral dimension to the ethical one, where all the different factors and actions undergo one wider frame, society. For Hegel, the possibility and the responsibility of an action cannot be ascribed if it's not the fruit of a free choice, but this means that this freedom shall be presupposed and guaranteed by societal institutions. Freedom, in Hegel's understanding, is never only a legal or a moral freedom but it's the result of different freedoms that have to be conceived in a complementary and dialectic way.

Thus, if to talk of responsibility means to talk of freedom, and if freedom is a complementary approach to society (Honneth, 2014), it is logic to conceive responsibility, as in Hegel, according to a broader complementary frame. To be responsible means to be free to act in a society where my actions are strictly interconnected with the one of the others. The degree of my responsibility is then directly proportioned to the one of my freedom. Of course in a firm or in a lab, the amount of freedom cannot be a full-scale one. Thus, also the degree of responsibility will be proportioned. But as shown by the empirical investigations carried out by Xavier Pavie, this relation and its widening can be fostered by a closer collaboration between

different social spheres be them public or private (Pavie, 2014). If we conceive freedom only as a mere legal one then also responsibility could not be conceived differently.

But responsibility, as well as freedom, far from being reducible to its legal or economic frame, contains several different nuances according to its time line, its space, matrix and the capability of being humanly understood (Vincent et al., 2011; Owen et al., 2013; Jonas, 1984). A clear distinction between these layers and their effects can unlikely be drawn unless specific, small cases.

To summarize, we have seen how responsibility embeds a two-folded relation with society based on attribution and retribution. We are only able to re-tribute someone or something if we are already been 'at-tributed' the liberty of doing so.

Given that liberty shouldn't be shrunk to its legal side, then also responsibility cannot be reduced to a legal matter but needs to be conceived in a wider frame that takes into account all the different understandings and most of all the different normative stands.

The question that rises logically is then, if there are other sides of responsibility, if there are other normative stands that contribute to define responsibilities, how do we cope with them? How do we make different normative settings communicate and harmonize with each other?

Recalling the functional perspective that we saw in Parsons and translating it into responsible terms could already be an answer from a theoretical point of view. Different subsystems are distinguished but always interconnected, and this appears to be true also for responsibility; we can never completely disentangle the different sides from one another.

But this answer would create some difficulties when connected to clashes of norms that functionalism fails in addressing. Besides, showing that differences need to be kept together and handled in a complementary way doesn't tell us much about how to do it in practice.

Therefore what we briefly need to follow here is a practical path, we could say a political one, in order to go beyond RRI as an ethical frame and reach the political level.

One of the most tackling issues in a frame for responsibility is exactly the one of finding a shared platform for clashing views and normative backgrounds, and this cannot be associated neither with a mere individualistic perspective nor to a generic collective one, but need to be addressed by a social, highly-differentiated perspective.

Such a process should take participation as a main tool. Participation is considered nowadays to represent the main tool in order to legitimate political decisions. Any decision having social repercussions cannot be taken in a justified mode without taking into account the context that will have to cope with the outcomes. Apart from the recent events we mentioned leading political legitimacy in the direction we now know, we should at least admit that a shared approach surely provides decision-makers with more knowledge than they could have on their own (Fung, 2006). In fact they may lack some kind of awareness or competences that a wide participatory approach can fulfil.

The genuineness and efficacy of this idea depends without any doubt on who, how participates, and what is the link between participation and the decision-making process. It goes without saying that are three layers strictly connected and dependent on each other.

As shown by Arnstein and Fung (Arnstein, 1969; Fung, 2006), participation can have different depths according to which level the decision-making process will be influenced by the participants' opinions.

According to Archon Fung for instance, there are six main modes of communication in participatory settings that can be divided according to the influence they are going to have in the decision making process. Unfortunately, most of the practical examples of similar attempts maintain a considerable distance between decision-making and bottom-up contribution. *'The vast majority of those who attend events such as public hearings and community meetings do not put forward their own views at all. Instead, they participate as spectators who receive information about some policy or project, and they bear witness to struggles among politicians, activists, and interest groups'* (Fung, 2006, p. 68).

Participation in this sense is reduced to communication, consultation, or we could say with Lazzarato, advertisement (Lazzarato, 1997).

What Fung aims to highlight is the fact that although participation is frequently adopted as a legitimating tool is too often exploited as such, not favoring any concrete influence in the decision-making process. Therefore participation has to be handled according to certain specific features in order to make it effective and real.

Besides, often stakeholders are admitted to participate but they are not solicited to overshoot the boundaries given by a specific frame. This frame can vary, being a legal an economic or even just a moral one. The frame shapes not only who is going to participate but also the way in which they

are going to eventually contribute. With regard to the former, Michael Walzer has lucidly highlighted how associations, or figures usually identified as participants, have to withstand preconditions that limit the access to a vast majority or, even worse, to not 'well intentioned' actors (Walzer, 2006).

But what counts for us more than the quantity, given that RRI could overcome this to a certain extent, is the quality of participation, that is, the way in which agents are called for participation.

A good participation instead needs as well a proportional level of reflexivity concerning the necessary questioning of the frame.

If on the one hand we have a so-called first-order reflexivity (Lenoble and Maesschalck, 2003) that represents the possibility of reflection on specific issues that come about in research and innovation, on the other hand this basic form of reflexivity could not be considered as sufficient. Therefore we would need something resembling a second-order reflexivity, one that reflects on the very condition that allowed the reflexivity itself (funding, expectations, policy frames, etc.) In fact, reflexivity on specific external issues is often accomplished in a direct and perhaps simple way. In fact in practice this direct way of reflecting hides and relies on a complex background that is something more abstract but at the same time really concrete in its intrusiveness.

This background is represented by all those constraints that play a role in the development of research and innovation. Of course they could be of different kind, and they could involve different underlying paradigms. They can be labelled under some sort of rationalistic understanding of the relation between science and society, privileging risk assessment structures and taking into account only predetermined normative settings. Or they can dismiss ethics considering it as an option amongst the others.

What it is common to all the nuances present in such 'backgrounds' is the fact that they ignore contextual reasons for developing decisions that will concern the context itself. Thus, not only we fail from a logical and practical perspective, but we also dismiss the very sense of what RRI should be. If we want to avoid inefficacy or political illegitimacy, it is not by reducing norms' construction to a predetermined asset of rationalistic mechanism that we are going to achieve this result. If the shift from ethics to responsibility doesn't want to disregard all the expectations that it carries, we need to focus on this 'thick' aspect of a reflexive participation. If it is true what John Dewey asserts, '*that the man who wears the shoe, not the shoemaker, knows best where it pinches*' (Dewey, 1981, p. 264), then

participants need to be put in the position to reach the kind of freedom that only a second-order reflexivity brings about.

In this sense perhaps we need something else, something more than a reflexive participatory process. In fact participation could as well, as demonstrated by Fung, be handled in different ways not all responding to the legitimacy necessity they claim. Reflexivity on the other hand could remain in a self-centred perspective not paving the way to something like a decision that could contribute to improve the well-being of society.

What we need then is a common objective or background to think about when we enact a reflexive participation. This background is what René von Schomberg indicates in a societal perspective. *'Economic prosperity and the anticipation that innovation yields positive anticipated impacts (such as the creation of jobs and growth) crucially become dependent upon the social context. The idea is clear; to steer the innovation process toward societally-beneficial objectives. [...] The Lund Declaration defines a type of justification for investment in research and innovation toward particular positive outcomes and underlines a justification for research and innovation beyond purely economic terms.'* (Owen et al., 2013, p. 59)

What we need is to settle a participatory process that can be aware of all the constraints and frames that our societies already embody. A critical reflexive process on these constraints can guarantee the level of freedom necessary for playing a role in the decision-making process. At the same time this reflexivity needs to depart from the values and norms that are already embedded in our societies through forms of institutions (Fung, 2012). What we would need in this sense is a relation, following Durkheim and Honneth, *'institutionally equipped with discursive mechanisms that allow participants to influence the interests of the others and thus gradually give shape to the overall cooperative aims of the group'* (Honneth, 2014, p. 219). Institutions are, to use Parsons' definition, *'the ways in which value-patterns of the common culture of a social system come to be integrated in the concrete action of its units through the definition of role-expectations and the organization of motivation to their fulfilment'* (Parsons, 1991, p. 39).

Are these institutions that express all the norms and values that are historically important for us. And the role of these institutions is both to express those very distinctive values and to articulate with other institutions in order to maintain and foster a social well-being. Social pathologies, as well as most of the problems connected with RRI rise when an institution is

not able to pursue its own logic and goals or to articulate with others (Dewey, 1969).

If we want to implement RRI and its role in society then we should consider RRI for its nature: a framework that facilitates the articulation of different normative sets within a society with the aim of fostering the social level of wellbeing.

Only if we will consider RRI as an ethical frame, one that is able to include all the different sub-systems like economy, law and morality in a balanced way we will be able to develop a real Responsible Research and Innovation.

References

- Arnstein, S. (1969) A Ladder of Citizen Participation. *Journal of the American Institute of Planners*, 35 (4), 216-224.
- Bowen, H. (1953) *Social Responsibilities of the Businessman*. New York: Harper.
- Dewey, J. (1969) *The Ethics of Democracy. The Early Works of John Dewey, 1882-1898*. Carbondale: Southern Illinois University Press.
- Dewey, J. (1981) *The Public and Its Problems*. Vol. 2. *The Later Works of John Dewey, 1925-1953*. Carbondale: Southern Illinois University Press.
- Fung, A. (2006) Varieties of Participation in Complex Governances. *Public Administration Review*, 66 (1), 66-75.
- Fung, A. (2012) Continuous Institutional Innovation and the Pragmatic Conception of Democracy. *Polity*, 44, (4), 609-624.
- Godin, B., (2006) The Linear model of innovation: The Historical Construction of an Analytical Framework. *Science, Technology, and Human Values*, 31 (6), 31, 639-667.
- Grinbaum, A. and Groves, C. (2013) *What Is 'Responsible' about Responsible Innovation? Understanding the Ethical Issues*. In Owen, R., Bessant, J. and Heintz, M. (eds.), *Responsible Research and Innovation: Managing the Responsible Emergence of Science and Innovation in Society*. Chichester: Wiley.
- Habermas, J. (1984) *Theory of Communicative Action*. Boston: Beacon Press.
- Hegel, G.W.F. (1991) *Elements of the Philosophy of Right*. Cambridge: Cambridge University Press.
- Honneth, A. (2014) *Freedom's Right. The Social Foundations of Democratic Life*. Cambridge: Polity.

- Jonas, H. (1984) *The Imperative of Responsibility: In Search of an Ethics for the Technological Age*. Chicago: University of Chicago Press.
- Kant, I. (1955) *The Critique of Pure Reason*. Chicago: Encyclopædia Britannica.
- Kelsen, H. (2009) *Pure Theory of Law*. Berkeley: University of California Press.
- Lazzarato, M. (1997) *Lavoro Immateriale. Forme di vita e produzione di soggettività*. Verona: Ombrecorte.
- Lenoble, J. and Maesschalck, M. (2003) *Toward a Theory of Governance: The Action of Norms*. The Hague: Kluwerlaw.
- Owen, R., Bessant, J. and Heintz, M. (eds.) (2013) *Responsible Research and Innovation: Managing the Responsible Emergence of Science and Innovation in Society*. Chichester: Wiley.
- Parsons, T. (1991) The Integration of Economic and Sociological Theory. 'The Marshall Lectures'. *Sociological Inquiry*, 61 (1), 10-59.
- Pavie, X., Scholten, V. and Carthy, D. (2014) *Responsible Innovation. From Concept to Practice*. London: World Scientific.
- Piketty, T. (2014) *Capital in the Twenty-First Century*. Cambridge: Harvard University Press.
- Ricoeur, P. (2000) *The Just*. London: The University of Chicago Press.
- Vincent, N., van de Poel, I. and van den Hoven, J. (eds.) (2011) *Moral Responsibility, beyond free will and determinism*. Dordrecht: Springer.
- Vincent, N. (2011) A structured taxonomy of Responsible concepts. In van de Poel, I. and van den Hoven, J. (eds.), *Moral Responsibility, beyond free will & determinism*. Dordrecht: Springer.
- von Schomberg, R. (2013) A Vision of Responsible Research and Innovation. In Owen, R., Bessant, J. and Heintz, M. (eds.), *Responsible Research and Innovation: Managing the Responsible Emergence of Science and Innovation in Society*. Chichester: Wiley.
- Walzer, M. (2006) *Passion and Politics: Toward a More Egalitarian Liberalism*. Yale: Yale University Press.



La valutazione delle prestazioni urbanistiche dei parchi scientifici e tecnologici: alcuni casi italiani a confronto

Giampiero LOMBARDINI*
Università degli Studi di Genova

Osservati da un punto di vista della pianificazione urbanistica e dei loro impatti sul territorio, i parchi scientifico tecnologici costituiscono un caso del tutto specifico di innovazione urbana. A seconda della loro localizzazione, della loro struttura e dei loro rapporti con il contesto urbano e regionale di riferimento, essi infatti producono impatti diversi sull'economia della città e sulla sua morfogenesi. L'impatto è tanto più incisivo quanto più i PST risultano innovativi e collegati alle reti lunghe dell'economia. Suddividendo i casi di studio in due categorie generali (i PST di 'nuovo impianto' e quelli sorti attraverso operazioni di riqualificazione di antiche aree di industrializzazione), si possono osservare gli effetti che essi hanno indotto ed inducono sul territorio: modifica dell'immagine urbana, riassetto delle strutture viarie e di collegamento, diffusione sul territorio circostante di attività indotte, riqualificazione urbana e degli spazi pubblici. La stessa organizzazione interna dei PST è decisiva per orientare il cambiamento urbano in determinate direzioni (riqualificazione urbana vs isolamento). Gli assets esaminati riguardano l'ambiente, le infrastrutture e la mobilità, l'assetto urbanistico (tipo di insediamento, rapporti con il contesto urbano e territoriale, prestazioni in termini di dotazioni di spazi e servizi pubblici), l'economia urbana / territoriale.

Keywords: *Parchi scientifico-tecnologici; pianificazione territoriale; valutazione territoriale; economia urbana*

Introduzione

I parchi scientifico tecnologici si possono collocare, da un punto di vista della loro analisi e valutazione economico-territoriale, nell'ambito del più generale campo delle politiche di governo del territorio orientate allo

* Corresponding author: **Giampiero Lombardini** | e-mail: g.lombardini@arch.unige.it

sviluppo socio-economico del territorio. Considerandoli sotto questo profilo, essi possono essere inquadrati come uno strumento potenzialmente in grado di influire (positivamente) sulle traiettorie di sviluppo economico urbano e regionale. A loro volta le traiettorie di sviluppo economico di una base economica urbana sono vincolate da sentieri di sviluppo in buona misura determinati dalle scelte operate nel passato e dalla storia economica che ha caratterizzato i diversi contesti regionali. Il passato si manifesta sia attraverso la materializzazione di strutture e capitale fisso investito che può fungere sia da vincolo che da motore per l'innovazione e la localizzazione sul territorio di nuove funzioni, sia attraverso l'organizzazione istituzionale e sociale che è frutto, in un determinato contesto temporale, di processi di lungo periodo.

In questo quadro, i parchi scientifico tecnologici possono essere interpretati come politiche urbanistiche che, attraverso il superamento dei vincoli esistenti e al contempo sfruttando le favorevoli condizioni locali, promuovono lo sviluppo di una regione urbana. Tuttavia il loro reale impatto sulle condizioni economiche e sociali locali, dipende da quanto essi siano in grado di catturare e sfruttare i vincoli di contesto, inserendosi in settori economici e istituzionali che hanno alle loro spalle una consolidata storia di successo. Infatti, l'ipotesi che sottende questo contributo, è che i parchi scientifico tecnologici non possono essere pensati come mere operazioni di localizzazioni di strutture atte a generare innovazione: senza legami forti con il contesto locale da un parte e con le reti lunghe dell'economia, infatti, l'esito di tali operazioni non potrà che essere negativo o comunque poco rilevante per le economie locali. L'aspetto sul quale si concentrerà maggiormente l'attenzione è quello della localizzazione urbanistica, vista come presupposto fondamentale per creare condizioni di successo.

Il contesto: città in contrazione (*shrinking cities*)

E' noto da tempo che uno dei modelli interpretativi attraverso cui leggere il fenomeno del declino urbano in regioni di vecchia industrializzazione sia quello dell'*urban shrinkage*. In realtà, non si può parlare di un vero e proprio modello, essendo esso basato sostanzialmente su alcune evidenze empiriche e non su uno schema logico di rappresentazione del fenomeno. Le situazioni per le quali si parla di *urban shrinkage* sono le più variegate: si va dai casi delle città dell'Europa orientale investite dalla crisi produttiva seguita al radicale cambiamento della struttura delle economie di quelle regioni dopo il crollo del Muro di Berlino,

ai casi di deindustrializzazione della *Rust Belt* americana, fino ai casi di declino industriale e demografico di alcune città dell'Europa occidentale. Si tratta di una casistica alquanto eterogenea, che non consente di delineare un modello univoco di interpretazione: diverse sono le condizioni economiche di partenza (sia a livello macro che a livello micro), diverse erano le basi economiche urbane di partenza, diverse le capacità di risposta istituzionale e politica rispetto alla crisi.

La rassegna di casi ad oggi più completa (OECD, 2012), oltre a fornire un primo tentativo comparativo dei diversi casi di *shrinkage*, pone al centro della discussione (e dell'interpretazione del fenomeno) il cambiamento demografico: esso può essere il risultato di processi di suburbanizzazione, come anche di perdita di posti lavori in conseguenza di crisi produttive più o meno estese. In ambedue i casi gioca un ruolo determinante la cosiddetta 'globalizzazione' (Dickens, 2003), che muovendo rapidamente capitali a livello globale, provoca repentine quanto irreversibili crisi nelle economie locali. I cicli distrettuali del prodotto si accorciano e le relative filiere produttive sono sempre più soggette a crisi strutturali, soprattutto nei casi dove le capacità di innovazione e riconversione siano ridotte o incontrino limitazioni nei quadri istituzionali. Tuttavia una lettura meramente quantitativa della crisi urbana interpretata solo dal punto di vista demografico appare di scarsa utilità, soprattutto nel momento in cui si tenta di dare una risposta in termini di politiche urbane. Il declino urbano non è un fatto nuovo od inconsueto nella storia urbana: mentre le strutture fisiche delle città sono connotate dalla lunga durata (Chandler e Fox, 1974), le crisi urbane hanno continuamente attraversato la storia delle città (Mumford, 1961). Lo *shrinkage* urbano è in realtà un fenomeno che va interpretato in una prospettiva multidimensionale: al declino urbano concorrono diversi fattori: oltre al cambiamento demografico, occorre considerare la base economica urbana a partire dalla quale la crisi si è manifestata, il ciclo di vita del prodotto e delle filiere produttive della regione urbana, ai processi di terziarizzazione, alle condizioni al contorno ('sociali') delle economie urbane: capacità di innovazione, capacità istituzionale, coesione delle comunità locali.

L'*urban shrinkage* può interpretarsi non tanto in quanto manifestazione di una 'crisi', quanto come momento di cambiamento di un'economia urbana. Ad una crisi demografica ed insieme economica, possono seguire percorsi diversi di sviluppo urbano. Lo *shrinkage* è legato a complessi fenomeni di concentrazione e delocalizzazione di attività urbane, raramente controllate o controllabili a livello locale. Molto più spesso tali fenomeni

sono legati a processi esogeni, cui in qualche modo le comunità locali devono far fronte. Facendo riferimento alla letteratura in argomento (Pallagst, 2009) le determinanti dello *shrinkage* fanno riferimento (spesso in modo combinato) ai seguenti fattori:

- Transizione demografica
- Suburbanizzazione
- Declino economico
- Deindustrializzazione
- Delocalizzazione
- Crisi sociali / istituzionali

Le traiettorie di sviluppo urbano: l'interpretazione secondo il modello della *path-dependence*

Descrivere un processo di declino urbano solo attraverso la rappresentazione che di esso ne fornisce il modello dell'*urban shrinkage* non risolve molti dei problemi interpretativi di fondo (ossia le dinamiche 'strutturali' del processo), risolvendosi esso in una mera, ancorché articolata, descrizione del fenomeno urbano. Tra i molti modelli strutturali che possono in qualche modo tentare di spiegare le dinamiche di fondo del processo di urbanizzazione, può risultare di un certo interesse quella legata alla teoria della *path-dependence*.

La teoria della *path-dependence* nasce per spiegare alcuni meccanismi di tipo economico organizzativo. L'osservazione prende le mosse dalla storia della tecnologia: quando una tecnologia (o uno standard) si diffonde largamente, può risultare difficile che se ne affermi in seguito una nuova e diversa. In questi casi, infatti, gli utilizzatori potrebbero restare ingabbiati, 'chiusi dentro' (*locked-in*) la tecnologia o il modello tecnologico corrente e abituale e questo anche nel caso in cui vengono offerte loro delle alternative potenzialmente superiori. Questo argomento è stato originariamente formulato da Brian Arthur, uno studioso delle scienze della complessità, che lo ha illustrato e provato in termini matematici osservando le dinamiche di particolari processi detti a 'rendimenti crescenti' e a 'feed-back positivo' (Arthur, 1994). Alcune delle implicazioni economiche (ed organizzative) di maggiore rilievo degli studi di Arthur sono state successivamente proposte e sviluppate in seguito dallo storico dell'economia Paul David e hanno preso il

nome di ‘teoria della dipendenza dal percorso’, con applicazioni nel campo storico di concetti, modelli e metodologie della dinamica dei sistemi (David, 2007).

La storia della ‘resistenza’ nel tempo di una scelta sub-ottimale venne utilizzata da David, allargando il campo alla storia economica e alla teoria dell’organizzazione, per illustrare che potrebbero essere stati proprio gli elevati costi collettivi di *switching* a ‘bloccare’ la collettività su questo standard inefficiente: le scelte di oggi sono condizionate da quelle di ieri. Dipendono dal percorso, appunto. L’articolo originario di David (1985) raccolse anche l’interesse di illustri biologi evolucionisti (Gould, 1991), che vedevano in questo caso un esempio di come nella storia dell’evoluzione (contrariamente a quanto affermato dal pensiero evolucionista *mainstream*) si ramifichino di frequente dei percorsi nei quali la selezione e l’adattamento non producono necessariamente la scelta ottimale, bensì un ottimo di secondo grado. David spiega il dominio della persistenza di scelte sub-ottimali (prodotti o processi) in base a tre fattori chiave: effetti rete indiretti, economie di scala e costi di *switching* (quasi-irreversibilità degli investimenti iniziali).

La dipendenza dal percorso nel senso ‘forte’ originariamente indicato da Arthur e da David appare poco plausibile: non si conoscono casi ben documentati in cui un sistema economico abbia liberamente adottato in modo irreversibile uno standard chiaramente subottimale pur in presenza di un’alternativa socialmente preferibile. D’altra parte, però, forme non irreversibili di *lock-in* e di dipendenza dal percorso sono invece frequenti, specie quando il differenziale di efficienza tra la scelta su cui il sistema è bloccato e quella concorrente non è elevato. Piuttosto che come una tendenza irreversibile capace di indurre il sistema verso lo standard ‘sbagliato’, la dipendenza dal percorso si manifesta in modo molto più evidente attraverso una spinta verso nuovi modelli compatibili con quelli precedenti. Infatti le innovazioni compatibili riducono i costi di *switching* per gli utenti, minimizzando gli eventuali effetti di *lock-in* insiti nello stato preesistente. Più in generale, è più corretto di parlare di ‘miglioramento vincolato dal percorso’ (*path constrained amelioration*: David, 2007), riferendosi ai vincoli ereditati dalle scelte passate che delimitano e indirizzano il raggio di azione degli operatori economici.

Nell’ambito degli studi sulle trasformazioni dei sistemi urbani il concetto di *path-dependence*, laddove lo si volesse impiegare quale modello interpretativo, non presuppone meccanismi di tipo deterministico (il ‘dover essere’ di tipo organistico), ma piuttosto di tipo evolutivo: il futuro dello

sviluppo urbano ci appare incerto, condizionato certo dal passato, ma assolutamente non determinato, anzi influenzato da variazioni che possono essere inizialmente anche di modesta rilevanza.

Il modello ci dice che il futuro dipende dalle condizioni iniziali, che sono endogene, oltre che da una serie di variabili esogene. Il cambiamento, inoltre, è cumulativo e incrementale, raramente radicale e rapido. Le condizioni istituzionali, sociali e tecnologiche concorrono a determinare la 'risposta' di una città o di un sistema urbano alle sollecitazioni esterne (Martin, 2010). Nel modello concettuale di *path-dependence* applicato al campo delle trasformazioni territoriali è fondamentale, anche in questo caso, il concetto di *lock-in*. Esso corrisponde ad una sorta di scelta obbligata, o comunque di scelta strategica, dettata dal restringimento del campo delle possibilità di trovare alternative soddisfacenti. La scelta è legata ai costi di transizione (*switching-cost*) da uno stato ad un altro (es.: da una tecnologia ad un'altra e soprattutto da una scelta localizzativa ad un'altra).

Martin and Sunley (2006) hanno ipotizzato 5 possibili modalità perché si generi un nuovo sentiero di sviluppo urbano, da una pre-esistente situazione di stasi / crisi:

1. Creazione locale di nuova conoscenza e innovazione
2. Eterogeneità e diversità del tessuto istituzionale, scientifico, sociale
3. Diversificazione tecnologica
4. Upgrading dei settori industriali esistenti (rigenerazione dei cicli di vita dei prodotti)
5. Nuove localizzazioni

Nell'ambito dello sviluppo urbano assume in questa prospettiva una rilevanza decisiva il capitale fisso che in modo incrementale è andato stratificandosi e consolidandosi nella città (non solo come accumulo di beni e capitali, ma anche come configurazione spaziale). Esso può costituire, rispetto a potenziali scelte localizzative, un'opportunità come anche un insormontabile ostacolo (quando i costi si rilevano troppo elevati per modificare una struttura urbana e renderla «adatta» ad ospitare nuove funzioni/attività). Le scelte future sono limitate dagli investimenti passati (Redfearn, 2009). Investimenti che non superano la soglia dello *switching cost*, sono destinate ad essere (quasi) totalmente inutili.

La territorializzazione dello ‘sviluppo’ economico

Negli ultimi decenni uno dei principali obiettivi di coloro che si occupano del governo del territorio è stato lo sviluppo socio economico, declinato ora secondo il paradigma della coesione sociale ora invece secondo quello della sostenibilità. Nel corso degli anni si è cercato sempre più di localizzare sul territorio lo sviluppo, prendendo come area di riferimento i sistemi territoriali: si è iniziato a parlare, quindi, di sistemi locali del lavoro, di sistemi turistici locali, di sistemi locali per l'innovazione, ecc. Il principio guida delle politiche è stato quindi il tentativo di organizzare per ogni sistema, sia dal punto di vista istituzionale (*capacity building*) che da quello degli interventi sul territorio, la valorizzazione del proprio territorio tale da far sì che, in tale prospettiva, assumessero sempre più importanza gli elementi relazionali, il raggiungimento di una elevata cooperazione tra attori pubblici e privati e l'innovazione. Obiettivo finale è l'innalzamento della qualità della vita e dell'attrattività del territorio. Le modalità di raggiungimento di tali obiettivi variano a seconda delle caratteristiche intrinseche di ogni sistema e delle scelte strategiche effettuate.

Al fine di rendere il territorio sempre più competitivo ed attraente da un punto di vista economico, molte politiche di sviluppo hanno assegnato un ruolo preminente all'innovazione. Gli ultimi venti anni si sono caratterizzati da un susseguirsi di processi innovativi, i quali si distinguono per almeno tre aspetti: il ruolo prevalente della conoscenza incorporata in capitale materiale ed immateriale, il combinarsi dei cambiamenti organizzativi a quelli tecnologici incorporati in beni strumentali, la pervasività in contesti locali e globali del fenomeno innovativo declinato in termini tecnico-organizzativi.

La competitività viene sostenuta da un'innovazione di tipo incrementale e di prodotto. L'innovazione radicale crea una discontinuità tecnologica ed è fortemente influenzata da uno stretto rapporto tra ricerca e applicazione tra mondo scientifico e mondo produttivo, e dalla possibilità che si realizzino scambi (di *knowledge* e di *expertise*) infra-settoriali. Il ruolo svolto dai Parchi Scientifici e Tecnologici è stato spesso considerato con scetticismo in letteratura, anche perché si basava su un modello di innovazione lineare per il quale la conoscenza scientifica si sarebbe potuta trasferire senza problematicità dall'università al parco per essere sviluppata. Essa è invece un complesso processo non lineare, che implica azioni e reazioni di feedback e la generazione di sinergie tra operatori diversi in un sistema di rete e perciò di virtuale perfetta interdipendenza.

La creazione, l'operatività e la performance dei diversi Parchi presentano diversità funzionali e differenti modelli organizzativi e si trovano tuttora al centro di animate discussioni e analisi critiche che spaziano dalla natura dei parchi stessi ai fattori critici per il loro successo, dal rapporto che si può configurare tra locale e globale alla loro effettiva capacità in quanto fattori di sviluppo socio-economico sul territorio. Il dibattito è stato stimolato proprio dal diffondersi di queste strutture, cresciute numericamente in modo davvero sensibile negli ultimi decenni in tutto il mondo. In Phan et al. (2005) viene sottolineato l'interesse dei policy makers e dei leader di settore verso questioni relative alla formulazione delle strategie da parte delle organizzazioni che gestiscono i parchi scientifici e gli incubatori. Ma tali autori segnalano uno scarso approfondimento accademico di questi temi, adducendo, come spiegazione, che le entità fondatrici (università e autorità locali/governative) sono enti non-profit e quindi poco propense ad occuparsi di temi di efficacia ed efficienza. Inoltre, i parchi sono spesso il risultato di partnership pubblico-private, il che significa che una pluralità di stakeholder ha enorme influenza sulla mission e sulle procedure operative.

I parchi scientifico tecnologici come motore dello sviluppo economico regionale

I parchi scientifici e gli incubatori nascono come motori per lo sviluppo economico di un territorio. Molta letteratura economica li interpreta tra gli strumenti per la creazione di posti di lavoro, e per favorire le interazioni tra università ed imprese. Casi di successo a noi vicini come il 'distretto tecnologico' di Cambridge nel Regno Unito, e meno vicini come il *Research Park Triangle* in North Carolina, la Route 128 in Massachusetts e la Silicon Valley in California (Castells e Hall, 1994; Saxenian, 1994), hanno spinto i governi di gran parte del resto del mondo a replicare tali modelli.

Va inoltre considerato che non esiste un unico modello di parco scientifico e che ogni parco va contestualizzato ed inserito in un ambiente specifico ove i bisogni possono essere diversi. Per esempio dall'analisi di Bakouros et al. (2002) emerge che i parchi scientifici della Grecia differiscono per le tipologie di legame con le università ed anche per i settori industriali in cui si sono specializzati. Non mancano poi casi di parziale insuccesso. Per esempio, Ratinho e Henriques (2010), si focalizzano sui fattori di successo dei parchi scientifici in Portogallo e concludono che ad oggi il loro contributo alla crescita economica del Paese è stato modesto.

D'altro canto, in zone differenti, i ricercatori rilevano casi positivi. Lofsten e Lindelof (2002) propongono un confronto longitudinale tra imprese svedesi insediate e non nei parchi scientifici. L'analisi dimostra che l'esperienza delle imprese insediate in un parco è diversa (in senso positivo) da quelle insediate fuori da un parco. In particolare ciò emerge rispetto a questioni di marketing e di innovazione.

Analisi esistenti individuano come elementi essenziali per il successo di un parco la capacità di innovare, la location, le opportunità di *networking*, presenza di skills imprenditoriali, esperienza nell'*international business*, l'accesso a maggiori risorse finanziarie (Watkins et al., 2006). I criteri di valutazione dovrebbero essere allineati con la mission del parco scientifico, con l'impegno dei maggiori *stakeholders*, con le condizioni economiche e regionali, con le forme giuridiche (consorzi, società per azioni, ecc.), con la natura della base di competenze scientifiche disponibili presso i centri di ricerca, ed infine con i cicli di vita dei parchi (Bigliardi et al., 2006).

Il caso di studio: il Ponente Genovese

Il territorio che, a partire dall'asse della Valpocevera (perpendicolare alla costa) arriva fino a Voltri, ha visto storicamente, a partire dall'Ottocento, il più grande processo di industrializzazione della Liguria con la creazione di uno dei più significativi poli industriali a livello nazionale.

L'area, costituita dai fondovalle vallivi ricchi di acque e dalle piane costiere contigue, fu a partire dal XIX secolo sede di impianti tessili e ferriere, che qui poterono sorgere grazie all'abbondanza di acque e alla forte energia del rilievo impressa dalla particolare configurazione morfologica.

Con l'avvento della prima industrializzazione, questi fattori preesistenti costituirono la base sulla quale si sviluppò il primo ciclo di industria pesante, legata alla siderurgia, alla meccanica e alla cantieristica. Un ruolo rilevante fu giocato anche dalla contiguità con il porto e con il nascente porto industriale di Sampierdarena, come anche dall'asse della Valpocevera che costituiva il principale canale di comunicazione tra la costa e l'area padana.

Il processo di industrializzazione procedette per espansioni successive a filo di costa, dove si svilupparono le attività che vi trovarono le idonee convenienze localizzative (cantieristica, logistica e stoccaggio). Va considerato che a quel tempo tra i principali fattori localizzativi vi era quello della distanza (secondo un modello à la Weber) e dei relativi costi di trasporto sia rispetto ai mercati delle materie prime che a quelli di sbocco: in tal senso, il porto di Genova si veniva a configurare come luogo privilegiato

ove stabilire la sede di molte attività produttive, specie quelle più pesanti e quelle legate alla prima lavorazione delle materie prime (produzione di semi-lavorati).

Alla prima metà del Novecento, l'area consolida la sua vocazione industriale 'pesante', grazie anche ai primi massicci interventi dell'industria di Stato. Le economie di agglomerazione e le relative economie di scala, portano ad una notevole espansione delle aree produttive e al consolidamento delle attività di base. L'intera economia urbana (e in buona misura anche quella regionale) è condizionata e legata inestricabilmente alle attività ivi consolidate: porto, cantieristica e industria di prima lavorazione costituiscono la struttura economica dell'area.

Nel secondo Dopoguerra si avvia il processo di seconda (o forse sarebbe più corretto dire terza) industrializzazione, dove un ruolo centrale viene giocato dall'industria di Stato e quindi dalle Partecipazioni Statali: alla cantieristica (Fincantieri), alla siderurgia (Italsider) e alla meccanica (Ansaldo), si affiancano la chimica (lavorazione prodotti petroliferi), l'elettrotecnica e l'elettronica. Tuttavia gli stessi meccanismi alla base del 'successo industriale' genovese portano con sé gli elementi che ne determineranno la crisi irreversibile che interessa l'intero comparto a partire dalla metà degli anni Settanta: l'eccessiva dipendenza dagli investimenti statali, la rigidità intrinseca dei grandi poli industriali basati sulla produzione di grandi quantitativi ma collocati a valle dei cicli produttivi (quelli a minor livello di innovazione), l'enorme impatto ambientale legato sia alla produzione che all'occupazione di estesissime aree, di fatto non sostenibile nel lungo periodo, data anche la stretta contiguità del tessuto urbano che nel frattempo si era sviluppato proprio a ridosso degli stabilimenti stessi.

Pertanto con gli anni Ottanta, Genova entra in una fase di declino industriale, legata sia alla mancanza di investimenti da parte dello Stato in comparti produttivi che subiscono la concorrenza dei mercati esteri emergenti, sia alla scarsa propensione locale all'imprenditorialità, sia infine alla mancanza di quel tessuto di medie e piccole imprese che nel frattempo, invece, andavano formando la fortuna del modello della Terza Italia. Un ruolo chiave nel declino industriale genovese gioca anche l'impronta lasciata sul territorio dai cicli di industrializzazione sedimentatisi nel tempo: la dismissione, la bonifica e la riconversione diventano estremamente onerose. Inoltre il venir meno delle convenienze localizzative legate alla distanza e alle rotture di carico (dal momento che si affermano ben altri modelli organizzativi di impresa attenti ad altri fattori strategici di localizzazione)

portano al progressivo (e rapido) abbandono di molti insediamenti produttivi. L'intero arco costiero tra Volti e l'asse della Valpocevera diventa progressivamente un'area caratterizzata da diverse condizioni ed intensità di utilizzo, costituita da aree dismesse, aree sotto-utilizzate, aree ancora produttive e (molto parzialmente) aree riconvertite. Configurandosi come un unitario nastro produttivo lineare a filo di costa, il problema delle relazioni tra il retrostante tessuto urbano e le ipotesi di riconversione e riutilizzo diventa uno dei temi centrali non solo dell'economia ma anche dell'urbanistica genovese.

Il Ponente genovese di fronte al cambiamento: i vincoli *lock-in* e le potenziali innovazioni

La situazione di stasi o comunque di forte rallentamento dei processi di riuso e rigenerazione urbana nelle Aree di Intervento del Ponente genovese (ora denominate dai più recenti piani urbanistici comunali 'Distretti di Trasformazione') induce ad interrogarsi su quali siano i vincoli che impediscono il rinnovo urbano e quali eventualmente le opportunità presenti comunque nell'area e nella società locale affinché invece possa essere invertita tale tendenza. Partendo dai presupposti teorici discussi nella prima parte relativamente ai fenomeni di *shrinkage* e soprattutto di *path-dependence*, si possono ricavare alcuni elementi interpretativi di fondo che fanno riferimento a tre ambiti fondamentali: il cambiamento demografico, la struttura economica, l'assetto fisico dell'area per come è venuta determinandosi sulla base delle successive sedimentazioni di opere e manufatti. Da ciascuno dei tre ambiti emergono sia i vincoli al cambiamento (quelle condizioni economiche, sociali o fisico-spaziali, cioè che determinano alti costi di transazione, *switching-cost* e quindi processi di *lock-in*), sia, per altro verso, opportunità che possono costituire la base per immaginare scenari anche sensibilmente diversi da quelli in atto e/o prefigurati dalle scelte pianificatorie.

Per quanto attiene alla componente demografica, se da un lato gli alti indici di vecchiaia e lo scarso tasso di rigenerazione costituiscono un limite molto stringente per immaginare scenari di tipo espansivo, dall'altro il mantenimento su livelli costanti del saldo naturale che perdura ormai da quasi due decenni è il segno di una stabilizzazione della popolazione. Il saldo migratorio positivo costituisce invece una potenziale risorsa sulla quale poter investire. D'altra parte tale componente migratoria non è composta solo da stranieri, ma le attività formative di alto profilo (sia nel campo

Universitario che in quello della ricerca di base e di sviluppo interne alle aziende o ai centri di ricerca) sollecitano un continuo rinnovamento delle popolazioni urbane classificabili come *city users*, che potenzialmente però potrebbero essere attratte da prospettive di stabilizzazione, laddove si creassero le opportunità di impiego qualificato. Impiego qualificato che peraltro è una costante dell'economia genovese (anche se oggi si attesta su soglie quantitativamente più basse rispetto a due decenni fa), connotata, anche per la presenza di consolidate attività portuali, da un elevato livello di internazionalità. Per quanto riguarda la struttura economica, invece, se da un lato la scarsa propensione all'imprenditorialità e il sottodimensionamento rispetto ad altre realtà della componente costituita dalle PMI costituiscono fattori limitanti, dall'altro non va trascurato il fatto che le medie e grandi imprese ancora radicate sul territorio genovese (Ansaldo, Fincantieri, filiera dell'elettronica e dell'elettro-medicale) possono costituire la base per la creazione di nuova impresa e per politiche di spin-off.

Il caso del parco scientifico tecnologico di Erzelli a Genova

La collina di Erzelli, sita tra i popolosi quartieri di Sestri e Cornigliano del Ponente cittadino nei pressi dell'uscita autostradale di Genova Aeroporto, è divenuta negli anni sinonimo di marginalità urbana e compromissione ambientale conseguentemente all'utilizzo della vasta area pianeggiante sulla sua sommità per attività logistiche connesse al porto, ossia deposito e manutenzione di containers.

Già dalla seconda metà degli anni '90 il Piano Territoriale regionale di Coordinamento degli Insediamenti Produttivi, vigente sull'area ad integrazione del Piano Urbanistico Comunale, ha destinato la spianata di Erzelli alla realizzazione di un 'parco scientifico tecnologico': luogo ove, sull'esempio di consolidate esperienze internazionali, la presenza di attività di ricerca di base, ricerca applicata e produzione, accompagnata dalla qualità degli insediamenti, potesse creare le condizioni ideali per favorire l'integrazione dei saperi e la creatività, la sinergia tra teoria e prassi produttiva e, in ultima analisi, l'eccellenza in un settore trainante dello sviluppo del territorio.

Nel maggio 2004, Genova High Tech - la società per azioni costituita nel 2003 con l'adesione di molti imprenditori del settore high-tech - ha presentato una richiesta per l'avvio del procedimento di accordo di

programma al fine di realizzare sulla spianata di Erzelli il progetto di un parco scientifico tecnologico.

Il progetto ha avuto diverse modifiche negli anni, ma ha mantenuto alcune costanti: in primo luogo l'integrazione tra mondo produttivo ed Università (con la progettata rilocalizzazione della sede di Ingegneria e la previsione di insediamento di diverse imprese di livello internazionale, tutte operanti nel campo high-tech), l'integrazione tra funzioni diverse (residenza a fianco dei Dipartimenti universitari e delle imprese), la riqualificazione ambientale dell'area, mediante la realizzazione di un esteso parco urbano.

L'idea alla base del *Master plan* è quella di sfruttare, concentrandole, diverse competenze tecniche e scientifiche, ad oggi disperse spazialmente nel frammentato tessuto produttivo genovese, contribuendo a riposizionare l'economia 'produttiva' genovese nel contesto nazionale e internazionale, tentando di garantire con tale operazione, le basi per lo sviluppo dell'innovazione.

Al di là di tali principi ispiratori, il progetto si è scontrato con alcune questioni rilevanti, che si potrebbero inquadrare in uno dei processi di lock-in citati nei paragrafi precedenti, ossia di 'strozzature' insite nel sentiero di sviluppo locale e che mettono a rischio la realizzabilità dell'operazione. Si tratta da un lato di condizionamenti di carattere fisico (accessibilità, rapporti urbanistici con il contesto urbano circostante, dimensionamento delle diverse funzioni) che di condizionamenti economici (vantaggi / svantaggi delle singole operazioni di ri-localizzazione sia delle sedi universitarie che delle imprese), sia infine di limiti istituzionali (lentezza e complicazione delle e nelle procedure decisionali).



Figura1 Il progetto per l'area di Erzelli.

Come ricaduta inevitabile di tali condizionamenti, il dibattito e le controversie si sono ben presto concentrate quasi esclusivamente sugli aspetti economico-finanziari dell'operazione, dal momento che tutto l'intervento viene a basarsi sulla disponibilità di (cospicue) risorse pubbliche per dare avvio alle principali ri-localizzazioni (specie quelle delle sedi universitarie). Tale dibattito ha contribuito a rendere il confronto monotematico, quando invece l'operazione avrebbe richiesto un respiro più ampio di valutazione, andando a considerare gli aspetti di efficienza localizzativa delle funzioni, l'accessibilità, le effettive ricadute in termini di esternalità positive dell'intervento sui quartieri limitrofi e sulla città in generale, sugli orientamenti da adottarsi al fine di garantire i presupposti territoriali di quei processi di innovazione che erano (e restano) alla base delle intenzioni progettuali.

Conclusioni

Il caso del costituendo parco scientifico tecnologico di Erzelli costituisce un interessante caso di studio se inserito nel più ampio contesto dell'economia e del territorio genovese. La componente high-tech della base economica cittadina è infatti da tempo consolidata e soprattutto è consolidata una forte propensione all'innovazione, anche in settori ad alta tecnologia. Appartiene al sentiero di sviluppo urbano genovese la capacità di rigenerarsi in modo ciclico a partire dalle precedenti attitudini e funzioni imprenditoriali. Lo stesso processo di shrinkage (traumatico sotto il profilo demografico e ancor di più sotto il profilo dell'occupazione) ha, tra i pochi aspetti positivi, quello di aver liberato numerose aree dismesse alla città, che possono costituire una risorsa fondamentale per la rigenerazione urbana (non solo economica). Dall'altro lato, appaiono evidenti e non sono stati sufficientemente analizzati nel processo di costruzione del progetto gli elementi di criticità generatisi a partire dai costi (non solo economico-finanziari) della trasformazione, derivanti a loro volta, in buona misura, da soglie rese molto elevate dalle condizioni maturate nei precedenti cicli di sviluppo, che hanno sedimentato sul territorio notevoli elementi di criticità (strozzature infrastrutturali, costi delle trasformazioni, degrado diffuso, limiti di capacità istituzionale, limiti della finanza pubblica). In ogni caso, vanno ancora approfondite e rese operative le sinergie tra Università (e quindi mondo della ricerca, orientata soprattutto alla ricerca di base) e aziende, dalle quali dovrebbero scaturire quei processi di innovazione che in qualche misura sono alla base della scelta strategica di realizzare un parco scientifico

nella realtà genovese. Il dibattito ristretto alla sola dimensione della fattibilità (convenienza) economica dell'intervento, ha lasciato in secondo piano una valutazione che dovrebbe invece essere ripresa sui meccanismi generativi dell'innovazione, che dovrebbero essere il vero fulcro di tutta l'operazione e che si dovrebbero legare alle traiettorie di sviluppo urbano ed agli elementi sui quali fondare delle capacità rigenerative.

Bibliografia

- Arthur, W.B. (1988) *Urban Systems and Historical Path Dependence*. In Ausubel, J.H. and Herman, R. (eds.), *Cities and Their Vital Systems*. Washington: National Academy Press.
- Arthur, W.B. (1994) *Increasing returns and path dependence in the economy*. Ann Arbor: University of Michigan Press.
- Audirac, I. (2009) *Urban shrinkage and fast metropolitan growth*. In Pallagst, K., Aber, L., Audirac, I., Cunningham-Sabot, E., Fol, S., Martinez-Fernandez, C.M., Moraes, A., Mulligan, H., Vargas-Hernandez, J., Wiechmann, T. and Wu, T. (eds.), *The future of shrinking cities: problems, patterns and strategies of urban transformation in a global context*. Berkeley: Center for Global Metropolitan Studies.
- Bakouros, Y.L., Mardas, D.C. and Vrsakelis, N.C. (2002) Science park, a high tech fantasy? An analysis of the science parks of Greece. *Technovation*, 22 (2), 123-128.
- Bigliardia, B., Dormiob, A.I., Nosella, A. e Petronic, G. (2006) Assessing science parks performances: directions from selected Italian case studies. *Technovation*, 26 (4), 489-505.
- Calafati, A. (2007) La città come 'sistema progressivo': evoluzione strutturale e sviluppo economico. *Scienze Regionali*, 6 (3), 83-112.
- Castells, M. and Hall, P. (1994) *Technopoles of the World: The Making of Twenty-First-Century Industrial Complexes*. London: Routledge.
- David, P.A. (2007) Path dependence: a foundational concept for historical social science. *Cliometrica*, 1 (2), 91-114.
- Gleaser, E. (2011) *The Triumph of the City*, New York: Penguin Press.
- Hansson, F., Husted, K. and Vestergaard, J. (2005) Second generation science parks: from structural holes jockeys to social capital catalysts of the knowledge society. *Technovation*, 25 (9), 1039-1049.
- Lofsten, H. and Lindelof, P. (2002) Science Parks and the growth of new technology based firms - academic-industry links, innovation and markets. *Research Policy*, 31 (6), 859-876.

- Martin, R. (2010) Rethinking Regional Path Dependence: Beyond Lock-in to Evolution. *Economic Geography*, 86 (1), 1-27.
- Martin, R. and Simmie, J. (2008) Path Dependence and Local Innovation Systems in City-Regions. *Innovation: Management, Policy and Practice*, 10 (2/3), 183-196.
- Martinez-Fernandez, C., Audirac, I., Fol, S. and Cunningham-Sabot, E. (2012) Shrinking Cities: Urban Challenges of Globalization. *International Journal of Urban and Regional Research*, 36 (2), 213-225.
- Pallagst, K., Aber, L., Audirac, I., Cunningham-Sabot, E., Fol, S., Martinez-Fernandez, C.M., Moraes, A., Mulligan, H., Vargas-Hernandez, J., Wiechmann, T. and Wu, T. (eds.) (2009) *The future of shrinking cities: problems, patterns and strategies of urban transformation in a global context*. Berkeley: Center for Global Metropolitan Studies.
- Phan, P.H., Siegel D.S. and Wright, M. (2005) Science parks and incubators: observations, synthesis and future research. *Journal of Business Venturing*, 20 (2), 165-182.
- Ratinho, T. and Henriques, E. (2010) The role of science parks and business incubators in converging countries: Evidence from Portugal. *Technovation*, 30 (4), 278-290.
- Saxenian, A.L. (1994) *Regional Advantage: Culture and Competition in Silicon Valley and Route 128*. Cambridge: Harvard University Press.
- Soja, E. (2000) *Postmetropolis: critical studies of cities and regions*. Oxford: Blackwell.

Digital Makers: an Ethnographic Study of the FabLab Amsterdam Users

Irene MALDINI*

VU University, Amsterdam & Universidad de la República, Uruguay

The popularization of digital fabrication tools at a domestic level and through the proliferation of maker labs or spaces is said to put the process of manufacture in the hands of the masses. This phenomenon has had ample repercussion in the media; analysts are announcing that anyone interested can make instead of buying what they need or want, indicating that the boom of participation has arrived to the realm of material objects. The future of digital fabrication depends, as in any emergent technology, on both technical developments and the utility found by its users. This ethnographic study of digital makers (users of the FabLab Amsterdam) explores the later, adding a feet-on-the-ground perspective to this discussion. It suggests that these tools are empowering creative people, improving the accuracy and widening the scope of their projects. On the other hand, it also points out that the emergence of an alternative model of consumption based on connected production at a domestic scale described in the media may not be aligned to the current state of affairs.

Keywords: DIY; digital fabrication; fabLab

Introduction

Our hero has broken his glass. It was a present from his parents, a special glass created in distant lands and distributed overseas together with many others of its kind. The ‘empowered consumer’ decides therefore to create a new one; he accesses an online repository of virtual objects and personalizes his own model, he goes on saving his file and walking to the nearest FabLab (a digital fabrication laboratory) to get it done. In an almost magical move, the mustached store attendant materializes his creation and now our hero stares at it calmly, with a satisfied look.

* Corresponding author: Irene Maldini | e-mail: irene.maldini@gmail.com

The story of the animated cartoon *Full Printed* - created by *Nueve Ojos* for the exhibition *Laboratori de Fabricació* in Barcelona – seems to portray a vision of the future, but it actually shows a vision of the present. The new role of our hero as a ‘maker’, ‘prosumer’ or ‘co-designer’ that uses online objects repositories, virtual customization and digital fabrication tools to get his cup done is contrasted to his somehow passive former role, when receiving his mass-produced present. Implicit in this story is the possibility, provided by new technologies, for consumers to substitute traditional consumption of mass-produced objects by on-demand creation and manufacture of personalized artefacts (e.g. Atkinson, 2011; Avital, 2011).

The popularization of digital fabrication tools and communication technologies are indeed making possible new modalities of production, leading analysts and scholars to announce a new industrial revolution (e.g. Anderson, 2010). The emergent model is expected to radically transform current production chains; some argue that designers will move on to the position of the meta-designer, creating platforms for consumers to shape their own goods (e.g. de Mul, 2011). Others believe that factories will come back to urban centers and be fragment into a series of backyard workshops and the whole distribution system of goods will be replaced by growing amounts of travelling data (e.g. Birtchnell and Urry, 2012). This article argues that these predictions are mainly based on the technical possibilities provided by new technologies, but they tend to ignore the actual interests of their users. The perspective of a substitution of our production and consumption model with a new system may be simplifying this phenomenon and overlooking actual practices and its nuances.

Researcher in digital fabrication Catarina Mota has argued that ‘a widespread adoption of personal digital fabrication will depend on tools, designs and motivation. Whereas access to tools and designs for production are the essential material conditions, motivation to use them is the elusive last link without which the previous two could be rendered meaningless’ (Mota, 2011, p. 280). The author pointed out in 2011 that early adopters of this technology could be categorized in two groups: ‘technical hobbyists’ and ‘designers and artists’ (ibid., p. 284). This study suggests that these categories still prevail; it describes how digital tools are enabling new creative processes and later focuses on the activity of a few independent makers, amateurs, or DIYers in order to explore the potential of these practices as a way of consumption.

Method

This ethnography is based on three actions: participant observation, online survey, and in-depth interviews with selected participants. The study was developed in 2012 in the context of the FabLab Amsterdam, a laboratory of digital fabrication where makers can walk in and use laser cutters, 3D printers, milling machines and other CNC technologies free of charge. The lab is run by Waag Society, institute for art, science and technology; an NGO that is directly involved in this research project.

The FabLab Amsterdam has a leading place within the FabLab community, together with the FabLab Barcelona it has served as an example for the worldwide community and has promoted the FabLab concept in general, supporting similar initiatives abroad. This specific lab was established in 2007 and has been continuously open since then; the sustaining arguments to select it as a case study (expecting that the findings can be somehow generalized) are its central location within the city, its accessibility to the general public, and its relatively long trajectory.

Digital fabrication tools and creative professionals

During the stage of participant observation in the lab it was noted that most of its users are students and professionals in architecture, art and design using digital tools to explore or develop creative projects. This was confirmed by the online survey, which was completed by 190 former and current users; more than half of the respondents studied or worked in design, others worked in art, architecture and engineering; only 23 individuals were not related to art, design or IT. Many of the creative users were not producing final pieces or objects but rather experimenting with these technologies or making tests and mock ups.

When asked about the results of their work at the FabLab, their responses included 'tests for an art piece, produced for the artist I work for', 'a test for an assignment for a private client', 'competition art in public space', 'for an Artist-in-Residency project', 'for my graduation I had to design fabrics', '*maquettes*', etc. Fig. 1-3 show end-products resulting from this kind of projects, these outcomes were shared at the FabLab Amsterdam online platform.

IRENE MALDINI



Figure 1 'Laser cut leather' by R.J.Ward published in 2014. Available online at <<http://fablab.waag.org/project/laser-cut-leather>>[May 2, 2014].

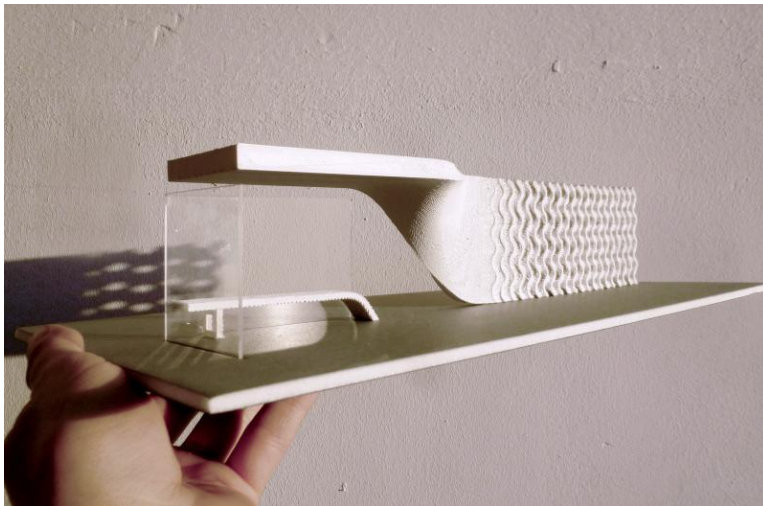


Figure 2 3D-printed model (scale 1:35) of 'Busstobject' by Ivo Jelinek published in 2013. Available online at <<http://fablab.waag.org/project/busstobject>> [May 2, 2014].



Figure 3 'Parametric furniture' by Jens Dyrvik published in 2012. Available online at <<http://fablab.waag.org/project/parametric-furniture>> [May 2, 2014].

The survey and participant observation of this study indicate that digital fabrication tools provide a means for creative professionals to:

- receive quick feedback on their ideas through easy materialization in intermediate stages of the creative process, arguably generating design practices that are closer to that of art (e.g. using unexpected outcomes as a start point) and crafts (direct trial and error rather a controlled and planned process of creation).
- modify their pieces without having to start from scratch.
- produce accurate material results with no need of developed manual skills or big efforts.
- replicate their work in order to directly produce copies or short series of objects.

In one word, this technology makes creative practice *easier* in many aspects and that is a core motivation for students and professionals to embrace it.

Digital fabrication tools and DIY

The second stage of this ethnography involved in-depth interviews with a selected group of individuals who had used the machinery at the FabLab not as professionals (to work on creative assignments or artefacts that would be used by others) but as a means to create objects for their own use (at some extent, as ‘consumers’). From the 190 respondents of the online survey, only 11 participants met this condition and were willing to be interviewed. The predominance of artists and designers among FabLab users may be easily explained by their role as ‘early adopters’, but this article argues that time will not necessarily bring a widespread adoption of personal digital fabrication for consumption practices. The disparity between the usage of these technologies by professionals and consumers is explained here by a difference in motivation and practicality.

Table 1 shows an overview of the participants of this study that used digital fabrication tools as a means of ‘consumption’. Although not all of them are amateurs, they have all found in digital tools an alternative to meet their needs of objects as users, and therefore their projects are useful to foresee some characteristics of digital DIY based on the actual appropriation of these technologies.

Table 1 Overview of the FabLab users interviewed for this study that used digital fabrication tools as a means of ‘consumption’ (digital DIY).

Maker	Object	Materials	Manufacture process	Alternative to digital fabrication
Frank	Mould for stencils	Cardboard	Laser	Traditional DIY
Jeroen	Spice rack	Plexiglas	Laser + assembly	None or traditional DIY
Mickael	Stamp	Rubber	Laser	Traditional DIY
Alex	Part of a suitcase	Foam	Milling	None or traditional DIY
Rob	Key rings	Leather	Laser	None
Suzanne	Jewellery	Plexiglas, wood	Laser	Traditional DIY
Floortje	Animation machine	Paper	Laser	Traditional DIY (less quantity)
Jorn	Lamp	Laminated wood, plywood	Laser + carpentry	None
Rogier	Door	Plywood	Milling + carpentry	Second-hand purchase
Boy	Tap washers	PLA	3D printing	None

Ed	Lamp base	PLA	3D printing	Traditional DIY
----	-----------	-----	-------------	-----------------

Overall, digital fabrication tools have empowered the interviewees of this study by improving or enabling their DIY projects, such as Mickael's stamp in fig. 4 and Rob's key rings in fig. 5. Frank and Floortje, for example, would have otherwise used scissors to manufacture their mould for stencils and animation machine. The laser cutter allowed them to get more detailed results, it also saved them time and resources in the process of creation and it led them to produce copies of their work. For other interviewees, the opportunity of using these novel tools was one of the main reasons to create their artefacts, as in the case of Rob, Jorn and Suzanne. The accuracy and flexibility of digital fabrication tools allowed Boy, Mickael and Alex to create very specific objects with high precision, a result that would have been extremely difficult with traditional tools.



Figure 4 Stamp by Mickael, laser-engraved at the FabLab Amsterdam in 2011.



Figure 5 Key rings by Rob, laser-engraved at the FabLab Amsterdam in 2012.

For most of the interviewees of this study the process of creation and manufacture was far from easy. To begin with, they needed to learn to work with design software and/or digital fabrication tools; furthermore, the iterative process of creation (with intermediate mock ups or try-outs) happened to be slower than expected. On the other hand, these practices improved their understanding of the visual, functional and constructive requirements of their artefacts; as a result, they became a sort of expert in the very particular problem or issue they were working on. Their involvement and dedication embedded the results with the satisfaction and pride of overcoming a challenge. All these factors plus the possibility of producing copies of their work relatively easily motivated Jeroen, Rob, Jorn and Rogier to transform their digital DIY projects into businesses.

The characteristics of these projects lead to the conclusion that digital fabrication tools are widening the possibilities of DIY practices by improving the accuracy of the outcomes, by enabling an iterative process of creation that saves time and resources for specific projects with strict requirements and by supporting the manufacture of short series of objects. These advantages and the necessary dedication, involvement and learning process often motivate makers to transform their DIY activities into businesses, turning consumers into entrepreneurs.

Will the maker substitute the consumer?

Can we therefore consider digital DIY as a growing consumption practice that may at some extent substitute the traditional mass production chain? This study points out that this is not likely to happen. The digital DIY objects analyzed here respond to very specific needs or motivations that were not subject to be met by mass-produced artefacts.

During the interviews, participants were asked: What if digital fabrication tools were not available? How would you have gotten your object(s)? The last column of Table 1 'Alternative to digital fabrication' summarizes their answers. None of the respondents considered to buy a product instead simply because that was not possible; these findings suggest that digital DIY is either substituting traditional DIY or enabling the creation of objects that were not possible before. The availability of ready-made solutions for their needs or desires would have certainly discouraged the dedication and effort required for this activity.

In the previous sections we have seen how digital fabrication tools are used by creative professionals and makers with specific needs or desires because they simplify or enable their practices. The fact that none of the respondents used these technologies to manufacture objects that could be produced at a factory and sold at a shop is not surprising, but easily explainable by the comparative effort and involvement needed. In an era when consumers of western economies have a great variety of goods available at very low costs, digital DIY practices do not seem appealing for simple practical reasons.

In general terms this study suggests that, when used for DIY, digital fabrication tools are certainly contributing to the development of a more diverse and heterogeneous universe of personalized objects. However, we do not see this as a consequence of the substitution of the 'homogeneous' mass-produced artifacts. On the contrary, we argue that digital fabrication tools are complementing traditional 'mass-consumption' by allowing users to meet more specific needs or desires.

Conclusion

This article started describing some of the expectations of analysts on the effects of a widespread use of digital fabrication tools. A scenario that has had a prominent influence in media is the broad appropriation of this technology by consumers, substituting traditional mass production and consumption.

The ethnographic study of the FabLab Amsterdam users aimed to develop a different perspective, starting from the actual appropriation rather than the technical possibilities of the machinery. This approach allowed differentiating two general user categories: creative professionals and DIY practitioners. The overall conclusions are that digital fabrication tools are empowering creative professionals by making their work easier, more accurate and replicable, what may explain the popularity of these tools within the group. The usage of this technology for DIY, however, is following a slower development. These tools are in fact enabling new DIY practices, but we argue that these do not tend to substitute mass production and consumption but to complement them, resulting in a more diverse material culture responding to a variety of desires and needs.

Acknowledgement

This article is an outcome of the project 'Object-User Relationships in Open Design Dynamics' of VU University Amsterdam and Waag Society, funded by the program Embedded Research 'Creative Industries' of VU University. I am grateful to Javier Gimeno-Martínez, Ginette Verstraete and Frank Kresin for their supervision and support and to the FabLab Amsterdam users for their time.

References

- Anderson, C. (2010) The new industrial revolution. *Wired Magazine*, 18 (2), 58-67.
- Atkinson, P. (2011) *Orchestral Maneuvers in Design*. In Van Abel, B., Evers, L. and Klaassen, R. and Troxler, P. (eds.), *Open Design Now, Why Design Cannot Remain Exclusive*. Amsterdam: BIS Publishers.
- Avital, M. (2011) *The Generative Bedrock of Open Design*. In Van Abel, B., Evers, L. and Klaassen, R. and Troxler, P. (eds.), *Open Design Now, Why Design Cannot Remain Exclusive*. Amsterdam: BIS Publishers.
- Birtchnell, T. and Urry, J. (2013). Fabricating Futures and the Movement of Objects. *Mobilities*, 8 (3), 388-405.
- Mota, C. (2011) *The Rise of Personal Fabrication*. Paper Presented at the Proceedings of the 8th ACM Conference on Creativity and Cognition.
- de Mul, J. (2011) *Redesigning Design*. In Van Abel, B., Evers, L. and Klaassen, R. and Troxler, P. (eds.), *Open Design Now, Why Design Cannot Remain Exclusive*. Amsterdam: BIS Publishers.

Collective decision making on risk management and sustainable manufacturing of nanomaterials and the role of decision support tools

Ineke MALSCH^{*a}, Vrishali SUBRAMANIAN^b, Elena SEMENZIN^b, Danail HRISTOZOV^b and Antonio MARCOMINI^b

^a Malsch TechnoValuation; ^b Ca'Foscari University

The paper presents the methodology and preliminary results of a study aiming to contribute to understanding mental models on management of uncertain risks and sustainable manufacturing, and to understanding the existing tools used within this context as a source of capabilities and potential adaptation. Central research questions are: What criteria are determining factors in collective decision making on risk management and sustainable manufacturing of nanomaterials? And what role can a decision support tool play in distributed cognition regarding such collective decision making? The paper analyses a survey among 13 participants in the SUN project and describes how a respondent population was chosen for a series of semi-structured telephone interviews conducted from January until March 2014 with decision makers from mainly European industry and regulators involved in risk management and sustainable manufacturing of nanomaterials.

Keywords: Nanomaterials; decision support; risk management; sustainable manufacturing

Introduction

Nanotechnology has the potential to address pressing societal problems through its applications in information technology, energy production, environmental protection, biomedical applications, food and agriculture (Koehler and Som, 2008). However, nano-Environmental Health and Safety (EHS) implications are difficult to predict and regulate since our understanding is constrained by substantial knowledge and data gaps.

* Corresponding author: Ineke Malsch | e-mail: postbus@malsch.demon.nl

While research to understand the environmental and human health impacts proceed slowly, industry and regulators need to make near-term decisions about nano-EHS. The project on Sustainable Nanotechnologies (SUN, www.sun-fp7.eu) aims to develop a software Decision Support tool (SUNDS). SUNDS should support decision makers in industry, regulators and insurance companies in:

- Estimating Nano Objects, their Agglomerates and Aggregates (NOAA) risk for workers, consumers and ecosystems in each life cycle stage;
- Estimating the environmental impact of NOAA-enabled products along their lifecycles;
- Evaluating to which extent the available technologies could reduce the risk (including cost-effectiveness evaluation).

SUNDS will be based on a Multi Criteria Decision Analysis (MCDA) computer programme. SUNDS will be based on a conceptual framework for measuring and monitoring sustainable nanotechnology, including empirical indicators, and stakeholder values. The development of SUNDS is underpinned by a comprehensive user engagement methodology that aims to understand mental models of decision making on management of uncertain risks and sustainable manufacturing, and the existing tools used within this context for potential adaptation. In the second stage, user engagement will also be used to seek feedback on the MCDA framework criteria, as well as other capabilities and features of the DSS user interface. Finally, user values will be elicited to analyse chosen ENM case studies using SUNDS.

This paper discusses the methodology used in a survey among 13 partners in the SUN project and a series of 27 semi-structured telephone interviews held in the first instance to identify the needs of industry and regulators regarding SUNDS design.

Central research questions of the study are: What criteria are determining factors in collective decision making on risk management and sustainable manufacturing of nanomaterials? And what role can a decision support tool play in distributed cognition regarding such collective decision making?

Study Design

The overall study design is based on mental modelling theory. This is a psychological theory according to which individuals observe and act in the world based on more or less correct 'mental models' they have formed of reality. Different concepts of mental models have been proposed, as well as different methods for investigating them (e.g. Morgan et al., 2002). The International Risk Governance Council (IRGC) has convened a meeting on the application of the mental modelling approach to nanomaterials. IRGC references the mental models approach implicitly in a white paper on nanotechnology risk assessment (IRGC, 2006, p. 57).

For the aim of the present study, a decision analysis based mental models approach appears most suitable (c.f. Wood, Bostrom, Bridges and Linkov, 2012). In this method, a (multidisciplinary) expert model or influence diagram is compiled that focuses on the influence of factor X on factor Y, investigates the probability or magnitude of this influence, and compares expert with lay person knowledge. The original expert model can be compiled through a group modelling session, literature / peer review or other methods. Lay beliefs are solicited through semi-structured interviews that are mapped by the analyst onto the expert model followed by analysis of the mapping. In a third round, the frequency of occurrence of the lay beliefs in the target population are assessed through a survey with closed questions. The metrics to analyse lay beliefs are completeness, similarity and specificity. The outcomes are an expert influence diagram, characterisation of lay mental models, and comparison between the two.

For the present study of desired capabilities of SUNDS and relative weights of SUNDS criteria, this method will be adapted somewhat. The study will not compare expert and lay mental models, but the mental models of different groups of experts in particular domains of risk management: risk assessment specialists developing the contents and criteria for the SUNDS tool and decision makers in industry, regulators and insurance companies that attribute different weights to different types of criteria. None of them is a lay person, but each has different (overlapping and complementary) expertise relevant to decisions on risk assessment and management. The expert model in question is the SUNDS decision framework rather than a drawn influence diagram.

Methodology

This paper reports results of two rounds of the study consisting of a survey among 13 participants in the SUN project and of 27 semi-structured telephone interviews with industrialists and regulators responsible for nanomaterials that were held in the period January-April 2014.

Survey

During the kick-off meeting of the SUN project, 29-30 October 2013, the participants were asked to fill in a short qualitative scoping questionnaire exploring the potential need for decision support tools. The questionnaire was handed out to 58 participants in total, including organisers and support staff. Thirteen responses were received either on paper, through an online questionnaire or by e-mail. This constitutes a response rate of 22%. The survey questionnaire is included in Annex 1.

Semi-structured Interview Questionnaire

For the questionnaire, relevant decision makers were selected from the larger population that had been identified in earlier projects as discussed below. Persons whose e-mail addresses could be retrieved were asked for their cooperation in a semi-structured telephone interview of 30-45 minutes. The indicative questions were sent before the interview and the transcript was sent to the interviewee allowing him or her to make corrections or add information. The corrected transcripts were then analysed as background information to identify elements of mental models of decision making regarding risk management and sustainable manufacturing of nanomaterials. The questionnaire is included in Annex 2 below.

Survey results

Of the thirteen respondents, two worked in SME's, four in large industries, and seven in higher education institutes or public research organizations. Two respondents had a senior management position, five were group leaders /middle management, and four were researchers. Two did not answer this question. The number of respondents is too small to make any statistical inferences.

Decisions taken regarding producing or using nanomaterials

Respondents report four types of decisions they have taken on producing or using nanomaterials: on marketing or production of a particular nanomaterial, on laboratory safety and on selecting a particular nanomaterial in risk assessment studies. One large industry has taken a decision on marketing. Three large industries and an SME have decided on production processes. Three public research organisations and an SME have taken decisions on priorities in risk assessment. Four public research organisations have decided on laboratory / occupational safety.

Required information

The industrial marketing decision was based on qualitative risk assessment parameters. Industrial production decisions were based on toxicity & risk information and quantification of sustainability, or in two cases advice from external partners. Academic decisions on laboratory safety were based on physical-chemical properties and Materials Safety Data Sheets (MSDS) from suppliers (in two cases), in house characterisation (in two cases), procedural and technical information on the planned experiment and equipment, regulatory guidelines in place, the precautionary principle and external expert advice. Academic and SME decisions on priorities in risk assessment studies were based on how much of the nanomaterial was used in products (two cases), exposure potential, environmental impacts, personal preferences and state of the art. Information used came from literature and the internet, or included qualitative data.

Decision criteria

Three decisions were based on the precautionary principle (marketing and production in industry, laboratory safety in academia). Health and safety at work guided other decisions on laboratory safety. Available information, technical options and costs also influenced decisions. Academic and SME decisions on priorities in risk assessment studies were based on the availability of the material (two cases), scientific aspects and exploitation potential. In one case a multi-stakeholder team decided on risk assessment priorities.

Self-assessment of decision

The industry that decided not to market a CNT-nanocomposite would - given the current state of the art - have allowed marketing under specific safety conditions. Two other industrial companies deciding on production, two academic institutions deciding on laboratory safety and one on priorities in risk assessment were positive about their decision and its outcomes. One academic institute preferred improving MSDS or risk phrases for nanotech raw materials, and the other intended to review after the research protocol has been conducted. One academic group working in risk assessment would prefer more knowledge about production and tools, and one SME on the use of the nanomaterial in products. One risk assessment specialist preferred hypothesis driven research to screening a random set of nanomaterials, as sometimes happened.

Decision making process

One large and one small company based decisions about technology selection or optimization in producing nanomaterials on safety, simplicity and costs. One large company used established chemicals risk assessment methods with adapted methods to quantify nano-end points. Another company used holistic analysis, market research and stakeholder discussion. One academic laboratory deciding on lab safety would inform everyone about safety issues before consent, another resorted to empirical decision making on risks. A research group setting priorities in risk research based this on experience, knowhow and process scalability. Three academic groups and an SME did not consider this question relevant to them.

Use of software tools

Most respondents don't use any software tools for technology selection or optimization. The three who use such tools made the following comments. One large industry respondent commented: 'Yes, the risk-vs-benefit is assessed on levels of economic, ecological, societal indicators. However, very detailed inputs are required and only comparative assessments are possible.' Another large industry respondent wrote: 'LCA software and database. Using open LCA software with specific data and ecoinvent data. Support can be better for ecoinvent.' A participant from a HEI/ Public Research Organisation remarked: 'We are going to support experimental activity with computational tools, but they are not available at the moment'.

Interest in decision support tools

Seven respondents were interested in using a decision support tool, five were not and one did not answer this question. Positive respondents were interested in the characteristics of a decision support tool listed in the table in Annex 2.

Discussion

The aim of this scoping exercise was contributing to targeting the SUNDS decision support tool to the professional needs of the companies, research institutes and government bodies represented during the SUN kick-off meeting. This aim was specified in two sub-goals:

1. Defining the scope of the literature review enabling us to identify a preliminary list of desired SUNDS capabilities, and
2. Expanding the list of interview candidates through snowballing (the qualitative social science research method).

From the responses, it appears that there may be more interest in a decision support tool in industry and perhaps government bodies such as authorities, notified bodies and inspectorates who have to verify compliance with regulations, and / or policy making bodies (ministries, European Commission). The latter were not represented among the respondents, only suggested as other organisations that could be interested in a decision support tool. Whether or not such organisations would be interested in a decision support tool should be investigated further. A decision support tool appears to be less relevant to academic institutions, even though some academic respondents expressed interest. Some suggestions for literature and existing relevant decision support tools were made, as well as some suggestions for organisations that could be approached for interviews.

Semi structured interviews

The selection of target populations and the design of the semi-structured interview questionnaire were based on the outcome of the survey among SUN partners. The methodology for determining the target populations is presented below, but the interview material is currently being analysed.

Determining the target populations for the interviews

Internet and literature searches indicate that companies in all phases of the value chain exist that are explicitly handling nanomaterials. ObservatoryNano (2011) identified 1540 different nanocompanies in Europe. Nanowerk's online database includes 2106 commercial companies active in business to business activities in nanotechnology worldwide. This includes 307 nanomaterials suppliers, 305 in biomedicine and life sciences, and 1297 in products, applications, instruments and technologies. The Nanosafety Cluster compendium 2013 includes details of all partners in current and finished EU funded projects on nanosafety. This includes at least 26 large industries and SMEs manufacturing or working with nanomaterials. For the purpose of our study, we can take the industrial population to consist of those companies presented in at least one of these databases with activities related to manufacturing, processing or marketing nanomaterials and products containing nanomaterials in Europe. It is safe to assume that this would amount to around 800 companies. A proposed categorisation of relevant companies is: R&D&I, nanomaterials producer, chemistry & (other) materials, intermediary products, end products, marketing and waste processing. Large companies as well as some SMEs may cover more than one category in the value chain of nanomaterials. This value chain is accompanied by services and instrumentation providers and interest associations.

In addition, University College Dublin (NUID-UCD) has compiled a database of participants in nanotechnology related events including contact persons for around 200 government organisations active in regulation of nanotechnology in Europe. This includes ministries, the European commission, notified bodies / inspectors / authorities, and international organisations (c.f. Malsch, 2013). Other contact persons include the SUN Advisory board, the contacts list of NANoREG and contacts of earlier projects. Within the general category 'Regulators', three subcategories of organisations may be distinguished: national policy makers (ministries), bodies that implement policies (notified bodies, inspectors, authorities etc) and trans- and international bodies where regulations are coordinated (e.g. EC, OECD). Another categorisation is by policy area (Chemicals safety, occupational health and safety, health / consumer protection and environmental protection).

For the present study, fourteen decision makers in two associations and eleven companies producing nanomaterials, chemicals & materials,

intermediary products and end products have been interviewed, in SMEs as well as large companies. These kinds of companies are most likely to be interested in decision support for risk management and safe manufacturing of nanomaterials. For reference, a decision maker in a nano-instrument business was also interviewed. The companies were headquartered in Belgium, Germany, Greece, Italy, UK and USA. Most companies were involved in SUN or other EU funded projects in the Nanosafety Cluster.

Thirteen regulatory decision makers including seven national and international policy makers, and six authorities and risk assessors have also been interviewed. Chemicals safety, Health/consumer protection and environmental protection have been covered. The interviewed persons came from Canada, Malta, the Netherlands, Switzerland, the UK, the USA, European Union bodies and an international organisation.

Conclusions

Despite 'sustainable nanotechnology' being a buzzword, there are no understanding of how nanotechnology stakeholders manage the risks associated with ENM (Subramanian et al., 2014). This paper reports on the methodology used to determine how collective decisions are taken on safe and sustainable manufacturing of nanomaterials, and what role software decision support tools could play in this process. This research is expected to shed insight on the appropriate technical tools and social means of risk management in the decision making community that faces high degree of uncertainty.

In the first two rounds of this investigation, 13 survey responses and 27 interviews were held to collect insights on how decision makers in large and small companies, industry associations, regulatory policy makers, authorities and risk assessors take their decisions. The survey among 13 partners in the SUN projects resulted in a list of features to include in a software decision support tool including risk assessment, ecological, economic, societal and technical specifications.

Analysis of databases of companies and regulators involved in nanomaterials developed in other projects suggests that there may be around 800 European companies that manufacture or apply nanomaterials in the value chain, and around 200 regulatory bodies that are involved in regulation of nanomaterials. These are taken as an estimate of the target

populations for our continuing study on mental models in collective decision making on safe and sustainable nanomaterials.

Annex 1: Survey

Dear participants,

Please fill in the attached questionnaire and contribute to a key aim of the SUN project: to develop a Decision Support System for practical guidance towards sustainable nanomanufacturing (SUNDS) (see Pert diagram below, SUN DOW part B, p 19). We - the partners engaged in WP 8, T8.1: Malsch TechnoValuation, University of Venice and University of Limerick - need your ideas and suggestions to help us target this tool to your professional needs and the needs of the companies, research institutes and government bodies you work for. This preliminary questionnaire will help us plan our work in WP 8. In particular it will contribute to (i) defining the scope of the literature review enabling us to identify a preliminary list of desired SUNDS capabilities, and (ii) expanding the list of interview candidates through snowballing (the qualitative social science research method). This preliminary questionnaire is distributed to each participant in the kick-off meeting of the SUN project, 29-30 October 2013 and explained during the presentation on WP 8. You can fill in the questionnaire anonymously and the results will only be used within the framework of the SUN project. It is available on paper and online via this link: www.ethicschool.nl/test. Please hand it in by 7 November 2013.

In the coming months, we will furthermore contact you and/or your colleagues for further semi- structured telephone interviews assessing your needs in regard to SUNDS design as input in MS14: a report to be presented and evaluated by the consortium and Advisory Board of the SUN project by March 2014. The study will be conducted in accordance with relevant EU legislation and ethical guidelines including The Charter of Fundamental Rights and Directive 95/46/EC of the European Parliament and of the Council of 24 October 1995 on the protection of individuals with regard to the processing of personal data and on the free movement of such data. If you have any questions regarding this questionnaire, please contact XXX

Questions

- 1) What kind of organization do you work for?
 SME < 250 employees

Collective decision making on risk management and sustainable manufacturing of nanomaterials and the role of decision support tools

- Large industry > 250 employees
 - HEI/public research organization
 - Government policy making body (e.g. ministry, European Commission, OECD etc)
 - Authority / notified body / inspectorate etc
 - Other (please specify):
 - 2) What is your position?
 - Senior management
 - Group leader/ middle management
 - Researcher
 - Other (please specify):
 - 3) Could you briefly describe a decision you have taken regarding producing or using nanomaterials?
 - 4) What information did you need to be able to take this decision? How did you obtain this information? Was the level of information satisfactory for your decision making needs?
 - 5) What criteria did you use to make this decision?
 - 6) How do you assess this decision in retrospect? Could you comment about how your decision making process could be improved?
 - 7) How do you make decisions about technology selection or optimization in producing nanomaterials?
 - 8) Do you use any software tools for technology selection or optimization? If so, what do you use? What kinds of parameters does the software optimize? Are you happy with the support provided by the software?
 - 9) Would you be interested in using a decision support tool? What would you want to use it for? What characteristics should such a tool have in order to be useful for you?
 - 10) Could you suggest companies / research organizations / government bodies that might be interested in using a decision support tool for decisions in manufacturing/using nanomaterials? If possible suggest contact persons for interviews.
 - 11) Please list any references to literature on capabilities for risk assessment decision support tools that you are aware of.
 - 12) Do you have any other comments or suggestions?
- Thank you for your cooperation. If you have filled in this questionnaire on paper, please hand it in to Danail Hristozov / Elena Semenzin during the

SUN kick off meeting or send it by post / a scanned copy by e-mail by Friday
7 November 2013 to: XXX

Annex 2: Questionnaire

Dear XXX

Thank you for agreeing to a semi-structured telephone interview assessing your needs in regard to the design of the SUNDS Decision Support System. Please find attached the indicative list of questions. During the interview I may ask follow-up questions to explore interesting issues that come up. With your permission I will record the interview. This recording will only be used for transcribing the interview and then deleted. I will send you the transcript enabling you to correct errors and/or add clarification after the interview. The transcript will be used as background information for our study and not published as such. Anonymised quotes from the interview may be used in publications. Your responses will be used as input in a report to be presented and evaluated by the consortium and Advisory Board of the SUN project by March 2014. If you are interested, I can send you a pdf of the final report.

The study will be conducted in accordance with relevant EU legislation and ethical guidelines including The Charter of Fundamental Rights and Directive 95/46/EC of the European Parliament and of the Council of 24 October 1995 on the protection of individuals with regard to the processing of personal data and on the free movement of such data. If you have any questions regarding this study, please feel free to ask me.

Kind regards,

Ineke Malsch

General open questions:

- 1) I have collected some information about your organisation and your function from open sources (see below). Is this correct?
- 2) What type of decisions regarding nanomaterials and products containing nanomaterials are you involved in?
- 3) Do you use any software decision support tools? What do you consider the advantages and disadvantages of the tools you use or have heard of?
- 4) Would you be interested in a new Decision Support System for decisions regarding nanomaterials? If so, what capabilities should this system have? If not, why not?

Specific question industry

3a) Does your company use decision support tools to guide manufacturing? If so, which tools and how do you use these tools? If not, why not?

3b) [If the user mentions one of the tools the SUN project partners reviewed] Which capabilities/features do you like more?

Insurance-related questions: is there a need for specific risk coverage products?

Specific questions regulators

3b) Does your organisation use decision support tools in risk governance? If so, which tools and how do you use these tools? If not, why not?

5) Please rate from 1 to 10 the value of having the following features in the SUN Decision Support Tool:

Feature	Value (1=low, 10=high)
Output of risk assessment	
Read across approaches to quantitative data on alternatives for research materials with uncertainties and data gaps before investments in scale up	
banding approaches to quantitative data on alternatives for research materials with uncertainties and data gaps before investments in scale up	
grouping approaches to quantitative data on alternatives for research materials with uncertainties and data gaps before investments in scale up	
Quantitative consideration of toxic effects	
Quantitative consideration of release rates to human space	
Quantitative consideration of release rates to environment	
Ecological indicators	
Environmental risk management	
Open LCA software with specific data and ecoinvent data	
Economic indicators	
Quantitative consideration of use amounts	
Large overview of patents and scientific literature	
Societal indicators	

Social perceptions of risk	
Factors influencing political decisions	
Large overview of normative frames	
Technical features	
Support experimental activity with computational tools	
How hazard data can feed into this process and influence output	
Easy to use	
Online	
Sharable with others	

Acknowledgement

The research leading to these results has received funding from the European Union Seventh Framework Programme [FP7/2007-2013] under EC-GA No. 604305 'SUN'. This publication reflects the views only of the authors, and the European Commission cannot be held responsible for any use, which may be made of the information contained therein.

References

- ECETOC report TR93 (2005) *Tiered approach to risk assessment in chemical processes*. [Online] Brussels: ECETOC. Available from: <http://www.ecetoc.org/> [Accessed: 13th October 2014].
- Hollan, J. Hutchins, E. and Kirsh, D. (2000) Distributed Cognition: Toward a New Foundation for Human-Computer Interaction Research. *ACM Transactions on Computer-Human Interaction*, 7 (2), 174-196.
- Hristozov, D and Malsch, I. (2009) Hazards and risks of engineered nanoparticles for the environment and human health. *Sustainability*, 1 (4), 1161-1194.
- Hutchins, E. (1995) How a cockpit remembers its speed. *Cognitive Science*, 19 (3), 265-288.
- IRGC (2006) *White Paper on Nanotechnology Risk Governance*. [Online] Geneva: International Risk Governance Council. http://www.irgc.org/IMG/pdf/IRGC_white_paper_2_PDF_final_version-2.pdf, page 57 [Accessed 13th October 2014].

- Koehler, A.R. and Som, C. (2008) Environmental and health implications of nanotechnology - Have innovators learned the lessons from past experiences? *Human and Ecological Risk Assessment*, 14 (3), 512-531.
- Malsch, I. (2013) Nano-education from a European perspective: nano-training for non-R&D jobs. *Nanotechnology Reviews*, 3 (2), 211-221.
- Morgan, M.G., Fischhoff, B., Bostrom, A. and Atman, C.J. (2002) *Risk Communication: A Mental Models Approach*. Boston and New York: Cambridge University Press.
- Nersessian, N.J., Newstetter, W.C. Kurz-Milcke, E and Davies, J.A (2003) *Mixed-method Approach to Studying Distributed Cognition in Evolving Environments*. Paper presented at the Proceedings of the International Conference on Learning Sciences.
- ObservatoryNano (2011) *European Nanotechnology Landscape Report*. [Online] ObservatoryNano.
http://bwcv.es/assets/2011/11/22/European_Nanotechnology_Landscape_Report.pdf [Accessed 13th October 2014].
- Porter, M.E. (1985) *Competitive Advantage: Creating and Sustaining Superior Performance*. New York: Free Press.
- REACH Regulation Annex XI. [Online] ECHA.
<http://echa.europa.eu/web/guest/regulations/reach> [Accessed 13th October 2014].
- Som, C. Nowack, B. Krug, H. and Wick, P. (2013) Towards the development of decision supporting tools that can be used for safe production and use of nanomaterials. *Accounts in Chemical Research*, 46 (3), 863-872.
- Subramanian, V., Semenzin, E., Hristozov, D., Marcomini, A. and Linkov, I. (2014) Sustainable nanotechnology: Defining, measuring and teaching. *Nano Today*, 9 (1), 6-9.
- Wood, M.D. Bostrom, A. Bridges, T. and Linkov, I. (2012) Cognitive Mapping Tools: Review and Risk Management Need. *Risk Analysis*, 32 (8), 1333-1348.



RECYCLE TOOLKIT. Strategie per il riciclo di aree dismesse

Chiara OLIVASTRI*

Università degli Studi di Genova

La scena urbana contemporanea è sempre più spesso ridefinita da pause ed interruzioni caratterizzate da spazi abbandonati che stanno assumendo uno stato di indeterminata attesa. Le politiche con le quali siamo intervenuti sul patrimonio città fino ad oggi necessitano di un cambiamento, di un ripensamento a monte. Pensare agli spazi in termini di riciclo, significa riprogettarli per adattarli ad un diverso uso, che permetta loro di non essere considerati degli scarti, ma di essere reintrodotti nel sistema urbano con una logica performativa di condivisione. La ricerca, al suo primo anno di approfondimento, focalizza l'ambito di interesse sul tema del riciclo temporaneo, ripercorrendo i diversi interventi già attuati nel mondo, per poter poi smontare e rimontare le logiche che li hanno generati e dedurre prassi trasversali da mettere in relazione. La novità non consisterà nel presentare gli interventi, ma bensì nel rileggerne le dinamiche attraverso una nuova chiave di lettura, quella del design, che osserva i fenomeni dal punto di vista dell'utente, della fruizione, per tradurre le strategie di valorizzazione che agiscono attraverso la partecipazione attiva dei cittadini nel processo di trasformazione e per mettere al centro del processo oggetti e azioni che inducono nuovi comportamenti nei confronti dei luoghi abbandonati.

Keywords: *Abbandono; dismesso; identità; riciclo; riattivazione; capitale sociale; sostenibilità; spazialità; strategie; tattiche*

Introduzione

Come la civiltà medioevale sorse dalle rovine dell'impero romano, assicurando ai resti del passato la possibilità di una nuova vita, spesso più grandiosa della precedente, così la città contemporanea deve rafforzarsi su nuovi e solide politiche di rinascita dell'immenso patrimonio dismesso.

* Corresponding Author: **Chiara Olivastri** | e-mail: olivastrichiara@gmail.com

Il termine 'area/edificio dismessa/o' definisce quegli spazi in attesa di utilizzazioni, cesure del tessuto urbano, per le quali la società attende un riscatto.

La scena urbana contemporanea è sempre più spesso ridefinita da pause ed interruzioni caratterizzate da spazi abbandonati e indefiniti che stanno assumendo una stato di indeterminata attesa.

L'unica certezza è quello che è stato, il procrastinarsi di quello che potrà essere lascia spazio all'assenza del luogo.

Non esistono non luoghi nel senso assoluto del termine, la coppia luogo/non luogo è uno strumento di misura del grado di socialità e di simbolizzazione di un dato spazio (Augè, 2010).

Ovviamente la polis riflette la crisi sociopolitica che stiamo attraversando, dove aumentano ogni giorno il numero di attività che chiudono i battenti.

La cultura del progetto non può rimanere insensibile di fronte a questo profondo cambiamento che stravolge la città occidentale, costellata da episodi di abbandono del nuovo (Ricci, 2013).

Serve a monte una grande politica di recupero creativo dei territori della nostra città, che devono smettere di crescere divorando terra agricola e natura e devono invece cominciare a occuparsi di sé stessi, rigenerando quei 'deserti urbani' (Boeri, 2009) che rappresentano la vera cifra della nostra follia politica.

Viviamo in città vuote eppure ci ostiniamo a volerle più grandi, più estese nel territorio, la nostra responsabilità è il non voler prendere in considerazione questo nostro straripante paradosso.

Si tratta di una condizione urbana nuova, emerge con chiarezza l'impotenza di un apparato disciplinare che continua a rappresentare un complesso articolato di posizioni teoriche e di sperimentazioni e che non riesce a sanare una condizione urbana disagiata, ma nemmeno a prevedere le dinamiche dei cambiamenti, a governare le trasformazioni.

A questo nuovo paradigma devono rispondere urbanisti, architetti, designer, sociologi, geografi e politici, con nuovi approcci di contestualizzazione dall'esistente nel preesistente.

Guardando la città si osservano industrie abbandonate, infrastrutture dismesse, spazi pubblici sottoutilizzati che definiscono una scena in *stand by*, paralizzata dall'economia e dalla burocrazia, come una clessidra il cui fluire del tempo è stato arrestato dal sopravvento della crisi.

Il trascorrere del tempo in questi casi è causa di degrado crescente, è necessario evitare lo spreco di denaro e di spazio determinato dai luoghi in

attesa di essere riprogettati, è fondamentale escogitare nuove strategie per rimettere in moto questo inestimabile patrimonio che ci sfugge di mano.

Guardare al patrimonio abbandonato dal punto di vista del design significa ribaltare il punto di vista, per osservarlo dalla parte di chi lo vive, lo fruisce e non dall'osservatore esterno che studia il territorio.

La coscienza della mancanza si è spostata: essa non riguarda tanto un senso perduto, quanto un senso da ritrovare.

Lo spazio urbano, quanto più difficilmente riesce a definirsi, tanto più si estende (e viceversa) (Augè, 2004).

In questo quadro è fondamentale ristudiare e comprendere i nuovi parametri che articolano gli spazi, come cicli e ricicli di attività e funzioni che si alternano, per meglio rispondere ai bisogni del tempo.

Il termine riciclare sta ad indicare un nuovo senso e un nuovo uso a quello che esiste già, dare nuova vita ai materiali di scarto, affinché questi tornino a far parte di un unico metabolismo (Bocchi, 2012).

In quest'accezione prevale una riconsiderazione dell'architettura e della città come corpo organico, con un accostamento al mondo naturale, in cui il rifiuto non esiste o meglio l'immediato riutilizzo non ne permette la creazione. Eliminare il concetto di rifiuti, non ridurli o minimizzarli, ma superare il concetto stesso partendo dalla progettazione, è la tesi di McDonough (2003) che si domanda -nel suo libro 'Dalla culla alla culla'- come sarebbero gli spazi se l'uomo progettasse prodotti e sistemi che esaltino la sua creatività, la sua cultura e la sua produttività, che siano tanto intelligenti e sicuri da permettere alla nostra specie di lasciare sull'ambiente un'impronta di cui rallegrarsi e non dolersi.

Pensare agli spazi in termini di riciclo, significa riprogettarli per adattarli ad un diverso uso per essere reintrodotti nel sistema urbano, il riciclo è inteso come nuovo ciclo di vita, ma anche come essere parte di un ciclo, essere parte del cambiamento con una logica performativa di condivisione. (Fagnoni, 2013).

Intervenire in questo quadro appena delineato non è affatto cosa semplice, lo dimostrano i lunghi tempi di attesa che intercorrono prima di un possibile intervento, nel tentativo di sbrogliare complicate matasse burocratiche e questioni economiche.

In queste parentesi temporali, assistiamo sempre più spesso ad interventi dal basso, organizzati dagli stessi cittadini, o da associazioni, raramente pianificati da professionisti, che tentano di sottrarre al degrado e all'incuria edifici o spazi potenzialmente di grande interesse.

Sono strategie di valorizzazione che agiscono attraverso la partecipazione attiva degli abitanti nel processo di trasformazione, sono azioni che mettono al centro del processo nuovi comportamenti nei confronti dei luoghi. Si tratta di interventi eterogenei che funzionano da tramite nell'attesa di un progetto definitivo o come oggetto di attenzione per un ripensamento e una rivalutazione delle previsioni immaginate: un riciclo temporaneo.

Hanno approcci specifici al contesto, possono consistere in occupazioni degli spazi verdi incolti che vengono ripensati come orti urbani (come il progetto di 2.000 mq di orti urbani alla Garbatella ancora in fase di assegnazione) o spazi ludici di quartiere o per lo sport, ex fabbriche trasformate da artisti e performers in spazio per spettacoli (Cell Space a San Francisco, 1996), spazi abbandonati riconvertiti in luoghi della movida come i locali che hanno aperto lungo le sponde del fiume Sprea a Berlino.

Spesso usi spontanei di riuso temporaneo hanno innescato processi di rigenerazione urbana imprevisti, andando ad occupare un 'tempo di mezzo' che intercorre tra vecchia e nuova destinazione d'uso che ha dato spazio a nuove pratiche abitative, lavorative, per il tempo libero.

Gli spazi vuoti possono essere intesi come riserve urbane per la sperimentazione dei sogni collettivi, liberi di accogliere e lasciare sedimentare un capitale sociale, divengono luoghi dove osservare le tattiche di autorganizzazione della città post-capitalista (Inti, 2011).

Obiettivo della ricerca

La riflessione verte sulla domanda di qualità nei contesti urbani e sulla capacità operativa e di ricerca del design nel campo dello spazio pubblico, intendendo la capacità della disciplina di indagare l'immaginario visivo, i simboli, l'evocatività, gli elementi di riconoscibilità da associare ad un racconto da vivere in prima persona. L'approfondimento di una relazione che presuppone uno studio sulla natura dello spazio pubblico nella città contemporanea e sulle domande che emergono dall'osservazione delle realtà in atto.

Le azioni di rigenerazione sono spesso mosse dal basso, sono gli abitanti stessi che, utilizzando la rete, coinvolgono comunità del network per divenire attori e portavoce delle trasformazioni. Lo spazio da dimenticato diviene performativo, facendo convergere esperienze e azioni che rimettono in discussione la vocazione e il significato di un determinato luogo.

Basta cambiare lo sguardo, per trasformare un vuoto in modo che sia non più assenza ma possibilità, non più problema, ma risorsa, in cui l'attesa

di future destinazioni può essere riempita da usi quotidiani, da spazi di vita, secondo le logiche di un design spontaneo, condiviso, open source (Fagnoni, 2013).

Interessante a questo proposito riportare il pensiero di Manzini (2006) che vede la realtà contemporanea come un elemento fluido che sembra perdere di solidità: le sue organizzazioni diventano plastiche, le forme di vita che in essa hanno luogo diventano fluide, ogni progetto tende ad essere flessibile ed ogni scelta si propone come reversibile.

In contrapposizione alla cultura occidentale che è stata costruita a partire da un modello di pensiero in cui la realtà viene considerata come un insieme di forme e funzioni immerse e congelate in materiali solidi, lo sviluppo dei mezzi di comunicazione ha reso più permeabile lo spazio ed ha portato ad aumentare la mobilità fisica delle persone e delle cose, infine la connettività sta completando l'opera di scioglimento delle organizzazioni sociali tradizionali, l'insieme di questi fenomeni porta all'emergere di una 'modernità liquida'.

In questo cambio di paradigma, il riciclo temporaneo prende campo in questa fluidità, sovverte le aspettative e funziona da monito per ribadire che l'atto progettuale non può essere pensato come unico e inamovibile, ma piuttosto in una prospettiva di sviluppo di lungo termine, le relazioni tra i dispositivi temporanei di azione, i loro attori e gli spazi residuali, possono determinare effetti molto differenti.

L'evento è paragonabile ad un sommovimento tellurico che come un vulcano in eruzione inonda lo spazio di nuove attività (Inti, 2005).

Spazi effimeri possono allora innescare nuove utenze e pratiche, sovvertire i codici semantici di uno spazio, rimanere poi simboli di un progetto e divenire infine luoghi di radicamento.

Si assiste in questi casi ad un ribaltamento del processo di identificazione spazio-individuo (ivi): non più spazi codificati e istituzionalizzati che assegnano identità sociale agli individui che li frequentano ma individui, o meglio attori, con la loro capacità di progetto e invenzione per ridare identità, funzione e senso agli spazi abbandonati.

La capacità di lettura delle trasformazioni in atto, in un mondo che vive continue rivoluzioni tecnologiche e culturali, è tipica del design, caratterizzata da un'elasticità di approccio che parte dalla lettura della realtà, nel tentativo di definire i punti cardini su cui orientarsi.

I designer si collocano come specialisti del progetto, che agiscono all'interno di una rete più complessa di attori/interlocutori come particolari

facilitatori di processo: che usano le loro specifiche capacità e competenze per far succedere eventi orientati ad un risultato.

Paola Gambaro (2009) in *Design Research Map*, considera gli eventi come la costruzione di azioni progettuali mirate che si svolgono in un tempo determinato, rappresentano una tattica sempre più frequente e diffusa su tutto il territorio per perseguire diverse finalità. Essa concentra al suo interno ampie competenze afferenti alle discipline del design che possono fertilmente contribuire a elaborare strategie rilevanti perché capaci di avere ripercussioni significative per lo sviluppo locale anche di lungo periodo.

L'evento può divenire una tattica pioniera quando alcuni usi temporanei che ridefiniscono il sito abbandonato riescono ad insediarsi e divenire permanenti.

Con un azzardo potremmo definire gli spazi abbandonati come i beni culturali contemporanei e in quanto tali da valorizzare e rendere fruibili.

La ricerca intende porsi come obiettivo quello di ripercorrere e approfondire queste dinamiche che si generano nei diversi interventi di riciclo temporaneo nel mondo, per poter poi smontare e rimontare le logiche che li hanno generati e dedurne prassi trasversali da mettere in relazione.

Altro obiettivo importante sarà quello di aggiornare il ventaglio di casi studio, per ampliare in generale il quadro in continuo sviluppo e tragarne possibili tendenze e linee di sviluppo.

Stato dell'arte

La normale durata di vita di un edificio può essere oggi stimata, calcolata, ma è solitamente previsto che a un certo momento un altro immobile lo sostituirà, che potrà avere l'aspetto di quello di prima o che potrà intrufolarsi dietro la facciata, conservata, di una costruzione più antica. La città attuale è così l'eterno presente: edifici sostituibili gli uni con gli altri ed eventi architettonici, «singolarità» che sono anche avvenimenti artistici concepiti per attirare visitatori da tutto il mondo.

Ora, almeno per qualche tempo, i terreni incolti e i cantieri oltrepassano il presente da due lati. Sono spazi in attesa che, talvolta un po' vagamente, risvegliano ricordi, ridestano la tentazione del passato e del futuro. Fungono per noi da rovine (Augè, 2004).

L'obsolescenza programmata (Latouche, 2013) notoriamente riferita agli oggetti ed utensili di largo consumo, è un concetto che sta riguardando anche le logiche della città, in questo caso l'obsolescenza è l'incapacità degli

spazi di rendersi flessibili e quindi adeguabili ad una domanda d'uso che si evolve, esprimendo differenti necessità.

Le passeggiate, gli eventi, le performances diventano allora un metodo umile per guardare ai territori dell'abbandono, che prima di essere riprogettati e risignificati possono essere esperiti come depositari di storie.

Occorre pensare lo spazio in tutte le sue possibili modalità e tipologie, mettendo in evidenza la condizione di possibilità, attraverso una rinnovata percezione degli insediamenti urbani, per impedire che si parli di negligenza (Braungart e McDonough, 2003).

Rispettare la diversità nella progettazione di un oggetto significa considerare non solo come è fatto, ma chi lo utilizzerà e come. In una concezione dalla 'culla alla culla' potrebbe essere utilizzato in più modi da molti utenti, nel tempo e nello spazio, invece di essere costruito per uno scopo specifico e in seguito abbattuto o goffamente riconvertito.

E' Papanek (1979) ad introdurre il concetto di responsabilità sociale e morale da parte del progettista che è in possesso del più potente strumento attraverso il quale l'uomo modella il suo ambiente naturale e per estensione la società e se stesso: la progettazione.

Ad oggi la ricerca 'apripista' su questo argomento è quella effettuata dal 2001 al 2003 con il coordinamento del gruppo Urban Catalyst presso l'Università Tecnica di Berlino e la rete interdisciplinare di 12 partner provenienti da cinque metropoli europee: Helsinki, Amsterdam, Berlino, Vienna e Napoli. Hanno sviluppato modelli di azione e strumenti di pianificazione strategica, integrando le potenzialità di usi temporanei in un duraturo sviluppo urbano con la formazione del primo archivio su questo tema, che ora è a disposizione di architetti, progettisti, comuni, sviluppatori, proprietari e utenti temporanei. L'intenzione di questo studio è stata quella di riaprire il dibattito sulle strategie e gli strumenti di pianificazione, riflettendo criticamente sulle carenze e le innovazioni di sviluppo, sia all'interno che all'esterno del vocabolario della pianificazione urbana convenzionale.

Sia la *gentrification* che l'abbandono sono i sintomi di una crisi, che dovrebbe essere considerata come un'opportunità per esaminare criticamente gli strumenti attuali e per elaborare modelli alternativi di sviluppo; i siti di ricerca delle cinque città rappresentano uno spettro di condizioni diverse in cui l'uso temporaneo può agire come un catalizzatore urbano. Queste condizioni (come la flessibilità del lavoro, la mancanza di spazi di aggregazione, il cambiamento della domanda di mercato, associato allo sviluppo tecnologico, che genera chiusura di industrie obsolete) sono il

riflesso di una società in cambiamento che chiede un'evoluzione delle tipologie di spazi del vivere e sono inoltre prototipo per l'odierna condizione europea.

Simile è l'approccio di Haydn e Temel che nel 2007 pubblicano *Temporary Urban Spaces*, in cui all'ampia sezione dedicata ai progetti, affiancano altre sezioni interessanti che descrivono le politiche, le pratiche e gli obiettivi con un focus dedicato ai nuovi termini che vanno a implementare il glossario urbanistico.

Dello stesso anno è *Urban Pioneers*, che concentra però il tema del riuso temporaneo alla città di Berlino, considerata da sempre la città 'campione' per eccellenza. Trattandosi chiaramente di un fenomeno legato alla prassi, che ha visto la sperimentazione sul campo e l'iniziativa spontanea precedere la sistematizzazione e la messa a punto teorica, il tema viene ovviamente affrontato impostando la narrazione sulla metodologia dell'atlante di casi studio. La narrazione di queste ricerche è spesso sviluppata sulla scansione dei prototipi a seconda degli attori, dei finanziatori e dei luoghi geografici, interessante potrebbe essere incrociare tutte queste logiche analitiche per rintracciare prassi trasversali e nuovi principi.

Se nell'evoluzione storica del Design assistiamo prima alla ricerca e alla sperimentazione per la realizzazione di un oggetto, secondariamente alla ricerca e all'evoluzione tecnica del prodotto approdando così al consumo sfrenato dell'oggetto stesso, oggi possiamo affermare di essere spettatori e responsabili di una fase che vede nell' *'Experience Design'* il concetto di progettazione per l'utente come cardine e preciso strumento di riflessione alla progettazione (Simeone, 2001).

Ridefinire tutto intorno al regista di queste esperienze, l'utente, porta a capire come diverse gestioni delle pratiche portino tuttavia a eguali successi, per esempio alcune volte vi sono associazioni che si pongono come intermediari tra proprietari e soggetti interessati a occupare temporaneamente dei luoghi, altre volte sono economie informali e nuovi servizi autorganizzati ad impossessarsi e far rinascere uno spazio abbandonato.

Offrire l'analisi di alcuni di questi usi attraverso la lente d'ingrandimento di un dibattito internazionale in rapida crescita, potrebbe portare a scovare tattiche interessanti da replicare e sistematizzare e, perché no, da condividere con amministrazioni.

Molto interessante è il caso della Caserma dei pompieri a Ferrara, costruita nel 1930 ed abbandonata nel 2004, concessa nel 2012 dalla Provincia di Ferrara all'Associazione no-profit Grisù in comodato d'uso

gratuito per un tempo determinato, con contratto rinnovabile. Da ex-Caserma dei Vigili del Fuoco nasce la prima Factory della cultura dell'Emilia-Romagna, una 'casa per creativi' che intende contribuire al processo di crescita del territorio attraverso lo sviluppo dell'imprenditoria culturale.

La gestione dello spazio è di competenza dell'Associazione Grisù, nata nel 2009 come centro di formazione ed informazione socio-culturale per il quartiere, così come la selezione dei progetti e la concessione di spazi all'interno dell'ex Caserma viene affidata al Comitato Direttivo.

A differenza di quella ferrarese, l'associazione Temporiuso agisce su tutta la provincia di Milano e all'estero, promuove la ricerca-azione sulla base di esperienze e sperimentazioni di progetti di riuso temporaneo.

Nasce proprio con l'intento di avviare progetti che utilizzano il patrimonio edilizio esistente e gli spazi aperti vuoti, in abbandono o sottoutilizzati di proprietà pubblica o privata per riattivarli con progetti legati al mondo della cultura e dell'associazionismo, delle start-up, dell'artigianato e piccola impresa, dell'accoglienza temporanea per studenti e turismo low cost, con contratti ad uso temporaneo a canone calmierato.

L'associazione mira all'avvio di bandi di assegnazione e concorsi d'idee, alla creazione di un data-base accessibile per spazi ed utenti, all'individuazione di un modello gestionale tramite Sportello Informativo. I progetti negli spazi temporanei sono da considerarsi sussidiari e non sostitutivi ai servizi permanenti ad uso della collettività, prevedono inoltre un coinvolgimento degli attori locali e delle attività pubbliche rivolte al contesto.

Tutt'altra tipologia di intervento e gestione è quello della Tour 13 a Parigi, senza alcun finanziamento e diretto da Mehdi Ben Cheikh, si ispira alla convinzione che anche le aree urbane più abbandonate possano rinascere grazie allo strumento della creatività. Tour 13 era un palazzo destinato alla demolizione, che per un breve periodo, prima della sua demolizione avvenuta il 31 ottobre 2013, è divenuta una delle più grandi gallerie temporanee di "street art" mai realizzate. Cento artisti di 16 nazionalità diverse hanno utilizzato come tela un edificio abbandonato. Nove piani e 36 appartamenti, alcuni dei quali ancora arredati, sono stati completamente trasformati andando a creare quella che è stata chiamata "Galerie Itinerance", con una superficie di circa 4500 mq.

Graffiti, stencil, fumetti e labirinti geometrici destinati a scomparire, o meglio rimanere in rete, a ricordo di un'impresa di riciclo temporaneo, che seppur sconfitta dalle logiche predeterminate dei dettami urbanistici, ha

riscosso un successo enorme, al punto tale da creare code negli ultimi giorni che circondavano l'intero isolato.

Altro esempio di occupazione è quello della Torre Galfa a Milano del 5 maggio 2012 ad opera del centro per le arti Macao, che registra una così alta visibilità e il supporto di diverse personalità del mondo dello spettacolo e della cultura da determinarne lo sgombero e la permanenza dal 15 maggio.

I diversi utilizzi temporanei non emergono casualmente, ma sono guidati da differenti fattori e regole in cui gli utenti temporanei sono giocatori urbani che agiscono deliberatamente seguendo diverse visioni, decriptare questo nuovo linguaggio sarà l'intento della mia ricerca.

Metodo e processo

Con la capacità del design di reinterpretare le logiche e travalicare impostazioni consolidate per ribaltare il punto di osservazione si intende ripensare lo spazio in termine di 'spazialità' (Tagliagambe, 2011), al fine di distinguerlo dai tanti spazi comuni, per accentuarne una sua condizione di possibilità.

Il processo che si intende perseguire è quello fenomenologico illustrato da Donald Schon (1983), il quale afferma che il design è un intreccio tra prassi e teoria, dove la riflessione scientifica prende le mosse dalla riflessione sull'azione progettuale e delle sue ricadute sul contesto per trarne le regole generali. Infatti come afferma Erik Stolterman (2008) il design, a differenza delle scienze, non può prescindere dalla realtà, ma anzi ha bisogno di mettere insieme esperienze per capire e modificare il mondo reale.

L'identità viene intesa come autentica ed efficace espressione dell'attitudine a progettarsi, la capacità di sentire e vedere la realtà non come qualcosa di già compiuto e definito, di cui limitarsi a prendere atto, ma come processo in divenire, che può assumere forme e modalità differenti rispetto a quelle che attualmente esibisce e quindi esige, da parte dell'osservatore, di percepire e pensare altrimenti.

Non trattandosi del primo caso di ricerca in questo ambito, la novità non consisterà nel catalogare gli interventi, ma bensì nell'interpretare al meglio la struttura per rileggere le dinamiche attraverso una nuova chiave di lettura, quella del design, che osserva i fenomeni dal punto di vista dell'utente, della fruizione, per tradurre le strategie di valorizzazione che agiscono attraverso la partecipazione attiva dei cittadini nel processo di trasformazione e per

mettere al centro del processo oggetti e azioni che inducono nuovi comportamenti nei confronti dei luoghi abbandonati.

La contaminazione e la reinterpretazione saranno le principali novità perché, a differenza delle ricerche già svolte precedentemente, quando ancora il fenomeno non aveva preso piede, il distacco temporale permetterà di fare considerazioni *ex post* che metteranno in discussione diversi principi.

I casi trattati saranno visti non più come unitari e permanenti, ma come componenti di una spazialità che si muove e si trasforma di continuo all'interno delle città con cambiamento periodico delle destinazioni e degli usi. Vedere in modi alternati ed inediti la città, e quindi ripensarla in maniera da facilitare derivate e traslazioni nelle categorie descrittive, con l'intento primario di scardinare qualsiasi metafora implementativa intesa come passaggio lineare della politica urbana.

Se il progetto deve essere il risultato di una costante tensione dinamica tra senso della realtà e senso della possibilità e della ricerca di un equilibrio, provvisorio e revocabile, tra questi due poli, allora la categoria centrale alla quale dobbiamo fare riferimento è quella della trasformazione e il nostro interesse si deve dirigere verso le condizioni che rendono possibile questa trasformazione. Determinante sarà quindi la dimensione processuale e tutto ciò che la può alimentare, orientandola verso un risultato efficace, raggiunto dopo aver colto 'Il tempo adatto per' (Tagliagambe, 2011), come occasione, come capacità di trovare tutte le opportunità che possono presentarsi nelle diverse circostanze.

Il tema potrà essere ulteriormente sviluppato nell'ambito della ricerca nazionale PRIN 'Recycle' che intende esplorare le ricadute operative del processo di riciclaggio sul sistema urbano e sulle tracce di urbanizzazione che investono il territorio nazionale, affinché questi "materiali" tornino a far parte, insieme al sistema ambientale, di un unico metabolismo.

Quest'occasione alimenterà nuovi casi studio e fornirà ulteriori occasioni per rimettere in discussione l'atteggiamento contemporaneo verso l'abbandono e la paralisi delle politiche di sviluppo delle nostre città.

Risultati attesi

Nel mostrare gli eventi come reagenti di luoghi da riciclare, si opererà con una lettura trasversale di diversi casi studio nazionali e internazionali per poi dedurre delle tattiche generali.

Cogliendo l'occasione di far parte dell'unità di Genova della ricerca Prin 'Recycle', si avrà l'opportunità, grazie ad una mappatura delle diverse aree

dismesse all'interno della municipalità, di mettere in pratica i principi desunti, cercando di carpirne le possibili dinamiche di riciclo.

Un'occasione importante di studio per il mio ambito di ricerca sarà l'organizzazione di un evento di riciclo temporaneo della Sopraelevata di Genova. Per un giorno - il 21 settembre 2014 - quest'importante arteria viaria verrà chiusa ai veicoli per divenire un passeggiata, che si dipanerà tra installazioni manifesto del riciclo, per sovvertire l'utilizzo abituale che ne viene fatto e poter così traguardare un'opportunità alternativa per un'infrastruttura che è spesso protagonista del dibattito cittadino.

La connotazione pratica è la caratteristica principale del riciclo temporaneo, è la risposta concreta che la cittadinanza si aspetta di fronte all'immobilità degli strumenti che finora abbiamo applicato.

Braungart (2003) avverte che da domani si parlerà di negligenza se l'umanità, dopo aver capito l'entità della distruzione che sta producendo, non farà qualcosa per cambiarla e si renderà complice di una strategia della tragedia; il riciclaggio è come un'aspirina che allevia i sintomi di una sbornia collettiva di un consumo eccessivo, il modo migliore per ridurre l'impatto ambientale non è riciclare di più ma produrre di meno e sprecare di meno.

Quello che il riciclo temporaneo fa in un *time gap* è solo il cambiamento di un approccio che deve essere ripensato dall'origine dell'atto progettuale, per non creare poi delle falle nel susseguirsi dei vari cicli di vita in cui il terreno andrà inevitabilmente incontro. A tale scopo si vorrebbe riuscire infine a fornire un *toolkit* da poter utilizzare per intervenire con maggior consapevolezza e responsabilità in diverse tipologie di aree, di cui si vuole leggere l'immaginario visivo, da associare ad un racconto da fruire, da vivere in prima persona per porre l'accento sull'io che dà significato e ragione di essere al dove.

Dobbiamo accettare la natura dei vuoti come occasione, opportunità, affascinante intervallo e come luoghi della transizione da uno stato all'altro e non come scarti di un processo che non li aveva previsti.

I cittadini l'hanno capito meglio degli urbanisti.

Le esigenze ambientali sono diventate prerequisiti del design contemporaneo e i progetti futuri dovranno scaturire sempre più dallo studio delle richieste funzionali, semantiche ed ambientali che possono nascere dal rapporto tra l'uomo e la terra su cui vive (Tamborrini, 2009).

Conclusioni

Dovremmo forse cogliere questo essere in transito di luoghi e persone come un'occasione per rinnovare i nostri strumenti progettuali.

La volontà di questa ricerca è quella di indagare e delineare un nuovo ambito di applicazione del design come attivatore di processi di innesco di un nuovo ciclo di vita per edifici e aree dismesse.

Sistematizzando l'esperienza che è già stata messa in atto da singoli, associazioni, gruppi, amministrazioni si vuole approfondire una possibile declinazione di strategie da applicare, per sbloccare logoranti processi burocratici che sono i principali responsabili del rallentamento del meccanismo città. Il vuoto nelle nostre città è infatti il riflesso fisico del vuoto che separa le istituzioni pubbliche dalle energie vitali della società civile (Boeri, 2009).

Bibliografia

- AA.VV. (2013) *Ricettario Urbano*. Genova: De Ferrari.
- Augè, M. (2010) *Nonluoghi*. Trento: Elèuthera.
- Augè, M. (2004) *Rovine e macerie il senso del tempo*. Torino: Bollati Boringhieri.
- Bertola, P. e Manzini, E. (a cura di) (2006) *Design multiverso, appunti di fenomenologia del design*. Milano: Edizioni Poli.design.
- Braungart, M. e McDonough, W. (2003) *Dalla culla alla culla*. Torino: Blu Edizioni.
- Bocchi, R. (2012) *Il Progetto*. [Online] Available from: <http://recycleitaly.it>. [Accessed: 12th February 2014].
- Boeri, S. (2011) Deserti urbani. *Territorio*, 56 (2), 77-78.
- Clement, G. (2005) *Manifesto del terzo paesaggio*. Macerata: Quodlibet.
- Falciديو, M. (a cura di) (2010) *Le scienze per l'architettura*. Firenze: Alinea.
- Franzato, C. (2009) Design del progetto territoriale. *Strategic Design Research Journal*, 2 (1), 1-6.
- Gambaro, P. e Rosa, E. (2009) *D. Cult Il design per la valorizzazione dei beni culturali*. In Bertola, P. e Maffei, S. (a cura di), *Design Research Maps. Prospettive della ricerca universitaria in design in Italia*. Rimini: Maggioli Editore.
- Haydn, F. e Temel, R. (2007) *Temporary Urban Spaces*. Basel: Birkhauser.
- Inti, I. (2011) Che cos'è il riuso temporaneo?. *Territorio*, 56 (1), 18-42.
- Lupo, E. (2007) La cultura come pratica abilitante di costruzione sociale della città. *Passaggi*, 14 (2), 108-118.

- Lupo, E. e Campagnaro, C. (2009) Formare comunità in-formare territori _designing connected places: 'fare scuola' di design per il territorio. *Tafter Journal. Esperienze e strumenti per cultura e territorio*, 15.
- Kolhaas, R. (2006) *Junkspace*. Macerata: Quodlibet.
- Oswalt, P., Overmeyer, K. e Misselwitz, P. (2013) *Urban catalyst, the power of temporary use*. Berlin: DOM publishers.
- Overmeyer, K. (2007) *Urban Pioneers*. Berlin: Jovis Verlag GmbH.
- Parente, M. (2010) Il design per la valorizzazione territoriale. Il caso di rione Sanità a Napoli. *Tafter Journal. Esperienze e strumenti per cultura e territorio*, 22.
- Papanek, V. (1976) *Progettare per il mondo reale*. Milano: Arnoldo Mondadori.
- Pericu, S. (2013) *Design for citylife. Riuso urbano intelligente*. Firenze: Alinea Editrice.
- Ricci, M. (2012) *Nuovi paradigmi*. Trento: Babel.
- Simeone, L. (2001) Experience Design. *Avatar*, 2.
- Stolterman, E. (2008) The nature of design practice and implications for interaction design research. *International Journal of Design*, 2 (1), 55-65.
- Schon, D.A. (1983) Il professionista riflessivo. Per una nuova epistemologia della pratica professionale. Bari: Dedalo.
- Tagliagambe, S. (2011) Strategie per la riqualificazione urbana. *Territorio*, 56, 7-13.
- Tamborrini, P. (2009) *Design sostenibile: oggetti, sistemi e comportamenti*. Milano: Mondadori.
- Thackara, J. (2008) *Design per un futuro sostenibile*. Torino: Umberto Allemandi.

In the Interior of Innovation: The FabLab Synthesis of Physical and Virtual Environments

Ricardo SAINT-CLAIR*
Politecnico di Milano

Forged by MIT at the Department of Bits and Atoms, FabLabs are workshop spaces for digital fabrication with openly available resources and know-how. These innovative places, blending the physical and the virtual, are spreading exponentially all over the world, along with their innovative end results. This paper investigates the FabLab proposal, contrasting with linear, hierarchical, non-flexible and, often, tedious structures from traditional R&D Departments. FabLabs' triumphs rely on disruptive political and economical dynamics, and become visible via a complex interdisciplinary ecology: open knowledge, co-creation, non-linear routines, high-end accessible technology and fluid social interaction. In short, tangible and intangible systems escalating considerably productivity and successful outcomes. The ongoing empirical research focuses in FabLabs located at the cities of Milan, Paris, London, Amsterdam, and Sao Paulo, unleashing patterns and congruencies on these adaptive models of interior and social design, that often appear to be anarchical. How the random synthesis of physical and virtual environments can openly foster the emergence of innovation? To what extent does the design of a physical space influence collaboration? What does arise when learning and working topologies collide? The findings of the proceeding study aim to delineate the strengths and flaws of the FabLab paradigm, exploring particularly the concept of an Open Interior and its blurring borderline between physical and virtual territories.

Keywords: Social interaction; open knowledge; interior innovation

* Corresponding author: **Ricardo Saint-Clair** | e-mail: ricardo.saintclair@polimi.it

1. Historic Context

1.1 *The Birth*

In 1998, the Center for Bits and Atoms (CBA), from the Media Lab at the Massachusetts Institute of Technology (MIT), gathered the first group of students for the opening course titled 'How to Make (Almost) Anything,' proposed by Professor Neil Gershenfeld. The class was targeted at the intersection between physical science and computer science. Besides logic and programming, the most important tool for the lectures was a programmable personal fabricator, a machine able to assemble atoms.

Computer-aided manufacturing (CAM) and numerically controlling machines (NC) are inventions from the late 50's, attests Gershenfeld (2005). The novelty in the late 90's was the striking decrease of machines in both size and cost, democratizing them to academia and their students. 'The course was aimed at the small group of advanced students who would use these tools in their research. But they weren't ones we expected; there were as many artists and architects as engineers (Gershenfeld, 2005, p. 12). Therefore, back in 1998, there was already an unfulfilled demand we would witness more clearly in the following decade: everyone was motivated by the desire to make things, to innovate. There was a lack of support and spaces to allow people to participate in, helping innovation to thrive and proliferate everywhere.

In order to investigate the implications and applications of personal fabrication in other parts of the world, mostly in areas where technology was scarce, a project focused on the creation of field 'fab labs' was created, as an acronym to fabrication labs and/or fabulous labs. The project was launched in 2002, a collaboration between the Grassroots Invention Group, the Center for Bits and Atoms and a grant from the National Science Foundation, starting in places such as rural India, Costa Rica, Ghana, Afghanistan, and the US. Twelve years later, there are 312 FabLabs in 43 countries, according to the FabFoundation.org. 'At the heart of this idea is the belief that the most sustainable way to bring the deepest results of the digital revolution to developing communities is to enable them to participate in creating their own technological tools for finding solutions to their own problems.' (Mikhak et al., 2002, p. 1).

In FabLabs the participants have full access to all the resources, mostly machines, know-how and processes, for the developing and making of things, from the creation of the physical form (three dimensional shapes via additive or reductive procedures), to the logical function (programming,

debugging and building circuits with computer chips). Often, the learning process is driven by curiosity and discovery, through the demand of local solutions for local problems, not primarily via the anticipated supply of knowledge.

1.2 The Bits

In the last decades, our contemporary world observed an unprecedented dematerialization of products and services, due to the massive spread of digital technologies and their social interactions. The first massive impact was on the new economics of entertainment and media industry, followed by banking, the retail sector, fashion, travel and public relations.

The digitalization of communication and computation started in the 40's in laboratories such as Bell Labs and MIT. In the 70's, the huge and expensive mainframes, occupying entire rooms and floors, were connected via the Arpanet and others academic networks. However, it was with the lineage of personal computers, TCP/IP protocols and the World Wide Web system that the world became truly digitally integrated. Networks, computers and digital devices have been growing exponentially in recent years.

'The main effect of all this connectivity is unlimited and unfiltered access to culture and content of all sorts, from the mainstream to the farthest fringe of the underground. Increasingly, the mass market is turning into a mass of niches.' (Anderson, 2010, p. 2). The market of niches has always existed, but meeting and experiencing niche products and services to niche consumers have never been so available, and have started to have a huge impact in the economy, with a thin intersection between commercial and noncommercial worlds. As a result, the borderline separating professionals and amateurs became suddenly blurry.

Everything related to bits came to be more personal and customized in an era of mass customization. While distribution and marketing became digital, it was natural to forecast that the same trend would be followed by manufacturing. Besides, we now undergo the move of computing from the traditional computers into everyday ordinary objects. The world of bits and atoms has never been so melted.

1.3 The Atoms

In addition to publishing, broadcasting and communications, the last decades of Internet operation had also a huge impact on the wide

circulation of physical products to consumers, via online stores and global reach and demand. In that sense the Internet has revolutionized distribution, not production. With the rapidly decrease of cost of machines for personal fabrication, the final expected dramatic change in making is lastly happening.

'Just like Apple encouraged music fans to 'Rip. Mix. Burn.' Autodesk now preaches the gospel of 'Rip. Mod. Fab.' (3-D Scan Objects, modify them in a CAD program, and print them on a 3-D Printer' (Anderson, 2012, p. 67). The cost of prototyping and product development has dropped 98% in the last 5 years. It means that if something would have cost one hundred thousand euros for research, design and development processes, now it can be reached by two thousand euros. 'In a sense we now failure for free.

A critical by-product of this new reality is that this means almost everyone can afford to innovate. The choice between innovating or not because of the expense is not an innovation barrier anymore' (Hatch, 2013, p. 37). This new scenario supplies cheap, powerful, and easy-to-use tools, added to full access to knowledge, capital and markets. The DIY industry (Do-It-Yourself) in the United States is worth over 700 billion dollars. Self-manufacturing, from spare parts to toys, is already possible from a virtual retailer. We are used to download software and to print photographs at home, we might not be that far from getting used to download a product, and instead of having it delivered by a courier company, it will be personally fabricated. In a way, the product will be materialized in our living room.

Anderson (2012) underlines that the DIY culture has suddenly met Web culture, and that the intersection of these two relies mainly in digital design: the fact that physical products are now created first onscreen. Many tangible products does not come from blueprints anymore, they are actual a digital information or digital description put in physical form by devices and machines, most of them robots. Hardware is becoming more like software, just an intellectual property embodied in commodity materials.

It is important to observe that the term digital fabrication is not entirely suitable, since the material is actually not digital yet, it is not smart. The extraordinary revolution in atoms will take place when matter acts just like the DNA, when all the information about what to make and how to behave is encoded into the materials themselves: they will carry the instructions for their own assembly. 'We are now on the threshold of the digital revolution in fabrication. The earlier revolutions in digitizing communications and computation allowed equipment made from unreliable components to reliably send messages and perform computations; the digitization of

fabrication will allow perfect macroscopic objects to be made out of imperfect microscopic components, by correcting errors in the assembly of their constituents.’ (Gershenfeld, 2005, p. 78).

2. Scientific Context

2.1 Design Theories

As an emerging field of studies, there is still an absence of academic literature and specific theories related to FabLabs, leading the ongoing study towards two interrelated routes: firstly, the descriptive research, dealing with a concrete description about what the phenomena is about and its historic context; secondly, the current explanatory research, raising questions about why and how the phenomena is happening and spreading itself so rapidly. This process can be described as a theory building, from the earliest onsite participatory observation at the FabLab Milano location along the current year, up to the theoretical findings in surveys from related conferences, books, articles and the FabLabs’ web sites.

Concerning design theories, the problem-solving approach is not sufficient to account for the innovative aspects of the FabLab proposal, which often does not employ ad hoc methods for finding solutions to problems. In this sense, innovation thrives via random collisions in a space that encourages uncertainty and freedom. In order to describe the surprising and serendipitous facets of design in the FabLab environment, C-K Theory, well known as Concept-Knowledged theory, offers a crucial aid with its system that is domain-independent, which is also one of the noticeable traits of FabLabs. Armand Hatchuel and Benoît Weil have been advocating the C-K Theory and exploring the inner contradictions of imagination and innovative reasoning for the past decade (Hatchuel and Weil, 2003). They have introduced a new framework for design practices that has been applied in many R&D Departments, mainly in France, Sweden and Germany. For instance, C-K Theory have shown how Crazy Concepts, those that seem absurd as an exploration path in a design process, can truly add extra knowledge and help to achieve innovative and practical end results.

Focusing in FabLab’s topics, Peter Toxtler is a prolific scholar that started to map the collaborative system of maker spaces that encompasses FabLabs, but also TechShops, Hacker Spaces and 100K Garages. His work offers a preliminary ethnography study of nine FabLabs in his search for a business model that can aid the sustainability of their settings (Toxler, 2010). The author identified the lack of a marketing or a PR plan, and

compare the weaknesses and strengths of the current models, which aims to different audiences and objectives, such as start-ups incubation, business partnerships, entrepreneurs, researchers, students and the general public. Toxler also states that the present overall literature stresses the FabLab users rather than the labs and their business or built environments (Pfeiffer, 2009; Gershenfeld 2005).

2.2 From Bits to Atoms

Negroponce (1995) points out that digitalization is not merely about reducing costs or increasing speed and productivity. Digitalization is a global changer in the way we distribute intelligence. Assuming that intelligence and knowledge are immaterial assets, their transmission and distribution occur both in virtual and physical realms. FabLabs offer the best of these two domains, constituting tangible spaces with the qualities migrated from the virtual ones.

In order to investigate the research question 'how the random synthesis of physical and virtual environments can openly foster the emergence of innovation', we must embrace a 'bricolage' methodological approach, using multiple means and schemes borrowed from the social and behavioral sciences. The primal hypothesis relies on the fact that the FabLab program was created and implemented in a settled digitalized world, around 2002.

This circumstance provides its edge and uniqueness. Ever since, technology has been increasingly ubiquitous and pervasive, and, in result, the FabLab built environment is hybrid, physical and virtual realms are not separated or do have a clear borderline. In fact, its physical space resembles attributes and promotes attitudes taken from the digital ones. With numerous digital qualities presenting themselves physically, the FabLabs become a boundless area and a great opportunity to explore this contemporary hybridization, inspiring new archetypes for R&D Departments or any built space with the aim to encourage innovation practices.

The interior design of a FabLab is an organized chaos, non-hierarchical and in constant flux; a physical platform with a random diversity of components and participants ready to connect, create, collaborate, hack, remix and distribute information and knowledge. Just like the Web, more than a physical platform, FabLabs are also a network, capable of adopting currently new configurations, shaping new patterns and allowing new connections to mate randomly.

2.3 Open Knowledge

Open knowledge is the theoretical or practical understanding that can be used and distributed without legal, social or technological restriction. Recently, we had the commons-based peer-network production concentrated in the realm of software development. Now the same open-approach is being applied to the world of fabrication or ‘fabbing’.

In a sense, new theories and practices were always built on the top of previous ones. There is a long tradition of citizens giving time and intellectual energy tackling problems where there is a perceived civic good at stake. (Johnson, 2010). Sharing principles and methodologies, people fulfill the desire to contribute for the same ecosystem. It is not just about letting the information flow inside the system, because the information is not simply flowing. It is actually being transformed, being recombined, being recycled. It is a co-creation process.

The tradition of copyrights, patents and trade secrets often stop the knowledge flow, not to mention its recombination and remix. Once more, digital open knowledge is not merely about sharing and copying limitlessly at virtually no cost or loss of quality. In fact, the knowledge is also being effortlessly modified. Inside a ‘remix philosophy,’ people tend to participate in collaborating incrementally to previous existing ideas and designs.

2.4 Fluid Networks

A digital lifestyle can be characterized by the quest of flexible and innovative organizations. At the network society nothing is fixed, social interactions appear and disappear in every split of a second.

Concerning organizations and networks, Johnson (2010) draws a comparison between state-run economies (with structural hierarchies and a top-down decision making), with the market-oriented economies (where good ideas can be forged and flourishes anywhere in the system). As a contrast, even though the promise of profit returns encourages people to seek for useful innovation, it also leads them to protect those ideas. In a fluid network, with a genuinely open knowledge approach, information is evenly distributed, fully liberated. In result, innovation prospers.

A closer look into the social processes of living in network and the future of the digital culture were encountered in the findings of Howard Rheingold, who in 1993 coined the term Virtual Communities. As many authors, he tries to cover the profound social, economic and political changes arising from the fast-paced developing technologies. As an example, he seeks for what stimulates members of a peer-to-peer network, that often does not know

each other, to share information and knowledge that is so particular or even secret, starting together a creative process without any reasonable or aimed result (Rheingold, 2004). Reviewing concepts as collaboration, participatory media and collective action, the author discerns every new digital phenomenon as a natural human instinct to act as a group. As Howard Rheingold himself puts it, 'I fell into the computer realm from the typewriter dimension, then plugged my computer into my telephone and got sucked into the net.'

FabLabs are a combination of interconnected players and technologies: the physical space, computers, digital machines, digital information, the Internet, but mostly important, really connected and motivated people. FabLabs are places where connection is more nurtured than protection. The collective mind that emerges in such collaborative process is not smart, but it surely makes the individual smarter.

2.5 Merging Spaces

'Innovative systems have a tendency to gravitate toward the 'edge of chaos': the fertile zone between too much order and too much anarchy.' (Johnson, 2010, p. 51). FabLabs draw no distinction between physical and virtual environments. Actually this random synthesis rises as its main characteristic. Most of the information process is cached digitally in infinite websites, web forums, blogs and personal pages. The FabLab 'cloud' offers full support and storage for its physical resources. Invention occurs both on site and remotely. And as a global community, these remote spaces are openly shared and grow exceptionally with the proceeding increase of new members joining and contributing to the conversation. These virtual tools enable every stage on the innovation process, from observation and data collection, to documenting, prototyping and testing.

Besides the merge of physical and virtual spaces, the theoretical and practical transmission of knowledge occurs through the motto 'Learning by Doing.' Consequently, a FabLab is moreover a blend of working and learning settings. Usually defined as a workshop, it is also a 'learnshop', as the space shares both activities, and the decisions and layout sets are made on the fly, depending on the project and participants. More than just giving structure and tools for personal fabrication, FabLabs offer know-how. Courses, debates, discussions, brainstorming, they all contribute to the discovery of solutions collaboratively. This co-creation scheme is entirely supported by the interchangeable and adaptable nature of their interior design environment.

Conceiving a diagram with two axes, the horizontal line representing working and learning topologies, and the vertical one regarding physical and virtual realms, we are able to identify divergences between FabLabs. As an example, FabLab 1 can have a limited physical space, but offers full support and activity on its virtual space, while FabLab 3 is more active in learning activities, in comparison to the availability of a full structure of working tools and machines.



Figure 1 The four merging spaces diagram will support the ongoing study in establishing a comparison between different practices and settings of Fablabs.

2.6 Ideology

When someone shares a common culture with thousands of other people, ideas and inventions tend to jump from one mind to another, even when the creators try to keep them secret. Johnson (2010) calls it ‘information spillover,’ as if it was an event that no one could avoid happening. In contrast, inside the Makers ideology the spillover occurs not just by chance, but by intention. To create and to share is a visible law and practice. ‘Sharing what you have made and what you know about making

with others is the method which a maker's feeling of wholeness is achieved. You cannot make and not share.' (Hatch, 2013, p. 1).

Decentralized environments do not have the assurance of payday, but their openness creates a powerful motivation to the exchange of ideas and support for outcomes. Peer-to-peer networks have changed industries, like the music industry. Personal fabrication is already being supported with the aid of crowd funding websites, without any government support or a venture capitalist investment, and they are already accounting for the 'Long Tail of Things.' It is the power of democratization, when tools are on the hands of people instead of governments and industries, giving birth to local solutions for local problems. 'The Internet democratized publishing, broadcasting and communications, and the consequence was a massive increase in the range of both participation and participants in everything digital – The Long Tail of Bits. Now the same is happening to manufacturing – the Long Tail of Things.' (Anderson, 2012, p. 62).

As innovative social phenomena, this ideology spreads the feeling that collectively and creatively the Makers can solve the local or global greatest problems, and meet people's most critical demands. Needless to say, technology here plays an important role: as products become a simple digital code, they become information, and people treat them just as information, manipulating it collaboratively with anyone, sharing online globally, remixing, hacking, and distributing it for free.

3. Methodology

The strategy and the structure of the current research are still a work in progress, with a leading spine allowing some flexibility on the run. Even though the decisions about the overall methodology are logical and, in a lesser extent, logistical, they were commanded by the theory building practice along the preliminary participatory observations in the course of this year at FabLab Milano, and other locations in the cities of Milan, Paris, London and Sao Paulo, and also by data and literature surveys.

As the pivotal feature of the researched phenomena relies on social interaction, methodologies borrowed from the social and behavioral sciences must be employed, in order to obtain relevant qualitative data for further analysis. Needless to say, quantitative data is also applicable and necessary, mapping and comparing the FabLab locations, offering statistics about physical structures, tools, resources, and ethnographic data from their participants, both staff and end users.

The first phase has started with the descriptive research, gathering data from the historic context of FabLabs via specific literature, document and data analysis, mainly from the Fab Foundation (www.fabfoundation.org). Formed in 2009, it is a US non-profit organization that supports the growth of the international network and the development of regional Fab Foundations and organizations. Its website is pretty comprehensive, with an up-to-date list and info about the FabLabs all over the world, and also detailed resources encouraging you to plan and build your own FabLab.

The second phase, launching the explanatory research, has initiated with a membership enrollment at the FabLab Milano, located at Bovisa, Milan. Introducing myself as a researcher from Politecnico di Milano, but in fact acting as an ordinary member interested in the resources, tools and knowledge that the FabLab could provide, would allow my first observations from inside the phenomenon. I have been actually engaging in multiple learning and working processes, attending many courses such as 3D Printing, Arduino Programming (a popular electronic micro-controller) and Digital Fabrication. This participatory observation, perceiving the space and its users interaction, both physically and virtually, has led to the current theory and hypothesis that are being tested. Subsequently, informal interviews were also conducted with lab managers and more active members, supporting the theoretical findings in books, papers and articles.

The methodology on course could be considered a 'bricolage' research methodology, using multiple means to achieve and present the outcomes of the research, mainly via Case Study and Ethnography. This decision is based on the complexity of the interrelated components of the phenomena. On the first hand, the case studies will examine intensively and in detail the physical/virtual spaces and the social interaction underneath them. On the second hand, the ethnographic strategy will offer a better understanding of the members examined, describing their culture, shared attributes, norms, values, and practices.

Therefore, as stated previously, both quantitative and qualitative research methods will focus on five FabLab locations. Via a comparative approach, the study will continue to center attention on managers and more active members of the chosen FabLabs, in order to gather few but relevant qualitative data via direct observation, action and one-to-one interviews. The participatory observation, acting as an ordinary member, not as an outsider researcher, is a strategy that will help the contribution and identification of key participants to the research, in order to form

further focus groups for debates, fruitful discussions and contextual analysis.

It is important to point out that there is a critical component to the elected methodology. As one specific objective of this investigation is the proposal of a co-design methodology for co-making spaces, the research intention is also to uncover flaws and fragilities, promoting change and enhancement to future scenarios for the related community and its stakeholders.

4. The ‘Open Interior’

At a first glance, the term ‘Open Interior’ suggests a physical aspect of a space structure, for example, the absence of walls separating rooms and zones. Nevertheless, the purpose here is to add up to the concept of an interior the intangible attributes of ‘openness’, borrowed from digital environments and online practices.

The interior of a FabLab naturally gathers the physicality of essential elements of interior design, such as furniture, lighting, windows and structure settings, with the virtual qualities of their disposition and use, contributing for the advent of a hidden system where the participants will interact and operate. Its interior acts as a platform to innovation and design practices, resembling the virtual values that made the digital revolution so successful. Most of all, it is an impermanent structure, supporting moral and behavioral attitudes that inspire, encourage and sustain collaboration and connectivity between their users.

FabLabs also provides a mixed balance of ideation and fabrication spaces. ‘Gathering the tools for active ideation and fabrication in a single place enhances the product outcome of a design process. Ideation spaces are common in corporate settings, focusing on the creation of a concept, an idea or an innovation to find the solution to a brief, or even creating a brief altogether. Fabrication spaces are environments that provide the tools necessary for materializing a concept or idea. FabLabs offer public access to the fabrication process to self-created briefs. Additionally, these fabrication environments may also encourage ‘ideation’; as both casual social interaction and experimentation with tools are likely to generate new ideas or solutions.’ (Horn, Donnet and Mougnot, 2013, p. 5).

The combined characteristics of physical and virtual spaces listed below were identified via participatory observation and data collection for the

ongoing research at FabLabs' locations and websites, mostly at FabLab Milano, in Bovisa, Milan.

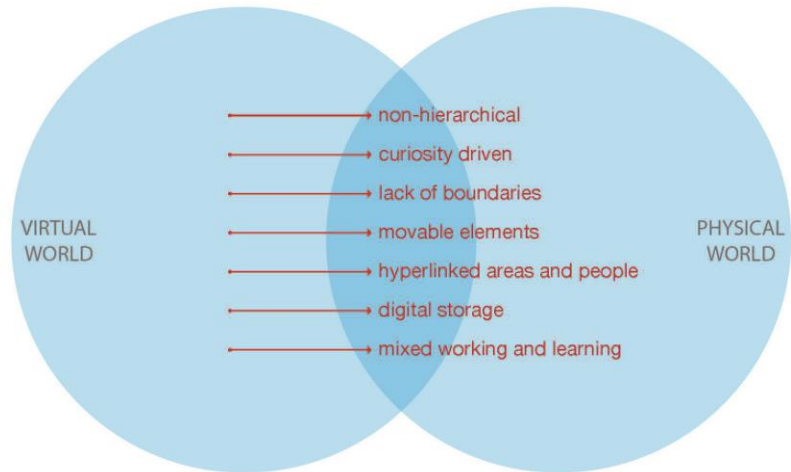


Figure 2 Virtual and intangible qualities applied to physical environments.

4.1 Non-Hierarchical

When entering a FabLab it is laborious to discern who is in charge of the space, or who should be addressed first. The manager or assistant is usually fused with other members, and they all share the same responsibility of aiding visitors, members and everyone who enters in the room. Just as the Internet, the participant will assemble the hierarchy of its content and elements via choice, chance or personal interest. For instance, the library zone of a FabLab might occupy the same area, or might offer the same access and importance, of 3D printers or other fabrication machines.

4.2 Curiosity Driven

The lack of information design in all areas and rooms, explaining where things are or what they do, stimulates connections and interactions. The visitor is invited to discover the place, its features and resources. Just like browsing on the Internet, one discovery leads to another, as if there is a hidden hyperlink in every object, furniture and member participant.

4.3 Lack of Boundaries

The areas are frequently characterized by the lack of walls, helping people to socialize and interact. If a member is working on a 3d printer, he (she) will have a chance to see someone debugging an electronic circuit or preparing an object for painting. Someone can build a team for a project in minutes by just crossing the invisible boundaries between the workshop areas. Common spaces promote casual meetings and chatter without formal planning. Everything seems to be modular, if there are walls they are movable, and the whole space can be systematically reconfigured. Even though it is a structural container, it allows plenty of freedom to the innovation dynamics.

4.4 Movable Elements

Wheels are everywhere, on tables, chairs and the supporting furniture for the 3D printers and machines. The result is that the settings are in constant motion. The continuous flux of information seen on the digital realm is applied to the physical, as members regularly use laptops, making it easy to move them around. A table can change its function, from a supporting furnishing to computers, microcontrollers and circuits, to a meeting point for an ideation process.

4.5 Hyperlinked Areas and People

Everything is connected or ready to connect. It is an environment that promotes random collisions between its elements. It promotes information spillover from one project to another, where collaboration and inspiration happens in unpredictable ways. The space assures that connections can occur anywhere and anytime, with electricity and data access spread all over the floor and walls. Some walls are to write on and wipe off, so sketching out ideas can become a discussion with others. Even the relaxed areas, such as the library at FabLab Milano, have chairs and sofas placed in a circle setting, inviting a meeting or a conversation. If we consider the knowledge process crucially rooted in a social process, the interior design of a FabLab takes action enabling as much social interaction as possible.

4.6 Digital Storage

One of the FabLab's goals is to build knowledge on the top of previous ones. And to cultivate this occurrence, it is also a place to share and store that knowledge. Some FabLabs have dedicated areas to help and encourage members to document projects and prototypes, a ready to use photo

setting with lighting, tripod and white background. Everything should be photographed, documented and posted online for easy access of other community contributors.

4.7 Mixed Working and Learning Topologies

Working and learning is merged, almost like a single process. The approach of Learning by Doing makes no distinctions in the interior design of the space. Each workstation, with computers and machines, can become a learning station, with projectors and sketchpads. These shifts occur naturally. And personal issues and local problems give rise to a learning process, where this mix and apparent chaos is not a flaw. As mentioned before, the proximity between ideation and fabrication encourages idea exploration and successful outcomes. Working and learning settings in FabLabs are deeply inter-related, and are not considered separate matters.

5. Conclusion

Individuals get smarter and more innovative when connected to a network. Virtual networks and the world of bits have already proved the power of the collective mind, giving rise to innumerable innovations in the last decades. Often, innovations that appear to emerge in the realms of bits were usually forged in the realms of physical spaces, such as garages, offices, cafeterias and academic labs.

FabLabs are dedicated spaces for the inception of innovation, merging physical resources with the unlimited digital ones. Its interior design plays a pivotal part, resembling the virtual traits that are now wide accepted and embraced by the contemporary society. The word Open Interior helps us to understand its post-digital dynamics. In that way, FabLabs are more a system than a fixed space. It is mutable, adaptable and seeking for constant change. It shares core principles with the liquid networks.

As the cost of production and distribution will continue to dramatically drop down, we will see an exponential explosion of the diversity of innovative solutions. With more variety, and tools to personal expression, people will continue to focus into their individualities rather than their commonalities, more precisely the top-down model of the traditional mass production model. FabLabs will thrive and continue to adapt to this new scenario. The so-called 3rd Industrial Revolution is already in place, feeding a fragmented market with common values: innovate, share and collaborate.

It seems reasonable to suppose that people possess some of the qualities of the environments they are drawn to. Why do a FabLab symbolize a disruptive model? Because its transformative change is coming with full democratization. A FabLab does not belong to companies, governments and other institutions, they belong to the individuals members of the community, from different fields but with the same motivation, sharing interests and needs. FabLabs truly belong to each single Maker.

Acknowledgements

The ongoing research at Lab.I.R.Int, in the Department of Design, Politecnico di Milano, has been partly funded by the Science Without Borders (CSF) program. Data collection and interviews have been carried out by Ricardo Saint-Clair, as part of a thesis for the PhD in Design at Politecnico di Milano.

References

- Anderson, C. (2012) *Makers: The New Industrial Revolution*. New York: Crown Business.
- Anderson, C. (2010) *The Long Tail: How Endless Choice is Creating Unlimited Demand*. London: Cornerstone.
- Botton, A. de (2007) *The Architecture of Happiness*. London: Penguin.
- Chesbrough, H. (2003) *Open Innovation. The new imperative for creating and profiting from technology*. Boston: Harvard Business School Publishing.
- Gershenfeld, N. (2005) *FAB: The Coming Revolution on Your Desktop. From Personal Computers to Personal Fabrication*. Cambridge: Basic Books.
- Hatch, M. (2013) *The Maker Movement Manifesto: Rules for Innovation in the New World of Crafters, Hackers, and Tinkeners*. New York: McGraw-Hill.
- Hatchuel, A. and Weil, B. (2003). *A New Approach of Innovative Design: an Introduction to C-K Theory*. Paper presented at the Proceedings of the international conference on engineering design (ICED'03), Stockholm, Sweden.
- Hippel, E. von (2005) *Democratizing Innovation*. Cambridge: MIT Press.
- Horn, J., Donnet, P. and Mougnot, C. (2013) *Boosting Creativity in Disruptive Innovations with Fabrication*. Paper Presented at the Proceedings of the Fab 9 Research Stream.
- Johnson, S. (2010) *Where Good Ideas Come From: The Natural History of Innovation*. London: Penguin.

- Leontiev, A.N. (1978) *Activity, Consciousness, and Personality*. Englewood Cliffs: Prentice-Hall.
- Moles, A. and Jacobus, D. (1988) *Design and Immateriality: What of It in a Post Industrial Society?* Cambridge: MIT Press.
- Mikhak, B., Lyon, C., Gorton, T., Gershenfeld, N., McEnnis, C., and Taylor, J. (2002) *Fab Lab: An Alternative Model of ICT for Development*. Bangalore: ThinkCycle.
- Negroponte, N. (1995) *Being Digital*. NewYork: Vintage.
- Rheingold, H. (2002) *Smart Mobs: The Next Social Revolution*. Cambridge: Basic Books.
- Troxler, P. (2010) *Commons-based peer-production of physical goods: Is there room for a hybrid innovation ecology?*. Paper Presented at the 3rd Free Culture Research Conference, Berlin.



Radical Innovation in Urban Development as Making Unfolds Its Potential

Peter TROXLER* and Gert-Joost PEEK
Rotterdam University of Applied Sciences

Urban development has been regarded as a distinct professional activity for decades, while making and Fab Labs have only recently appeared as a hedonistic pass-time activity. Ever since Barcelona has been promoting itself as 'Fab City', urban development has adopted the instrument of labs for making as an addition to its instruments. However, the potential, and indeed significance, of the bottom-up aspects of making have rarely been discussed.

In this paper we demonstrate how making is at the roots of emerging production paradigms. Small-scale but high-tech developments are particularly compelling, certainly from a perspective of emerging socio-technical production paradigms. As these development often happen in an urban context, urban development and urban developers have become interested. And since urban development itself is in transition, new paradigms might offer a way to renounce incumbent paradigms in which traditional parties are mainly interested in selling technology and services to governments and other public entities and accordingly have adapted to their top-down and silo structure. Relocating production and research functions to the centres of neighbourhoods potentially adds to liveability of cities and to the viability of local economies. A lab-centric approach however has to not only develop the technological aspect of manufacturing infrastructure, the proper labs themselves, but it needs to examine and shape the political and social structures in which they are embedded. This paper argues that such an approach of smart urban development requires a rethinking of the spaces of production, including the relationships between people and tools and people and existing authorities.

Keywords: *Urban area development; maker movement; third places*

* Corresponding author: **Peter Troxler** | e-mail: p.troxler@hr.nl

Introduction

Urban development has been regarded as a distinct professional activity for decades, while making and Fab Labs have only recently appeared as a hedonistic pass-time activity. Ever since Barcelona has been promoting itself as 'Fab City', urban development has adopted the instrument of labs for making as an addition to its instruments. However, the potential, and indeed significance, of the bottom-up aspects of making have rarely been discussed.

In this paper, we explore the implications bottom-up making for urban development. We will first briefly summarize the developments of making over the past decade. Building on a number of case studies, we will then sketch emerging production paradigms and relate them to the ideas of 'Fab Cities'. These new paradigms arise in a time when urban development itself is in transition, triggered by the crisis and revealing faults of the incumbent system of urban development. We posit, that the emerging production paradigms and the transition in urban development actually are mutually supportive and could be integrated in a new understanding of smart urban development. Such smart urban development differentiates itself from the more technocratic and top-down 'smart cities' approach by focusing on empowering citizens. In that sense, lab-centric approaches that position themselves in the Making tradition also differ from the living labs approach that is more geared towards corporate exploitation. We conclude that Urban Open Innovation Environment is a potentially strong change agent for radical innovation in the field of urban area development, and that it requires tactical shaping the political and social structures in which they are embedded.

Making

Making is often seen as a hedonistic pass-time activity: individuals using low- and high-tech manufacturing equipment to produce anything from everyday goods to artworks and weird and useful machines. Fab Labs (fabrication laboratories) and Makerspaces are publicly accessible workshops. Fab Labs, in particular are a global network of local labs, enabling invention by providing public access to digital fabrication. They share an inventory of core capabilities and can be considered a community resource (CBA, 2012). The initial concept was developed at MIT. When Neil Gershenfeld started the Center of Bits and Atoms (CBA) at the Massachusetts Institute of Technology (MIT) in 2001 to explore the merging

of physical and computer science, he was required to establish a community and outreach programme. To this end, it was decided to select a subset of the digital fabrication equipment, tools and processes – CNC milling, laser cutting, microprocessor programming and electronics – that the center used for their research and make it available to communities. The first labs were established in the United States (INTEL Computer Clubhouse in Boston, Science Museum of Minnesota), in Costa Rica, in the village of Vigyan Ashram (India), and in Ghana. Scientific interest beyond outreach was to understand and review ‘the implications, applications, and enabling research for access in the field to prototype tools for personal fabrication’ (CBA, 2005).

Makerspaces are similar, often equipped with the same machines, but lacking the global network. Often, a public workshop calls itself a ‘Makerspace’ to differentiate itself from the Fab Lab network. One reason often given is that the Fab Charter (CBA, 2012) requires ‘open access for individuals’ which is often read as ‘free access’ which many feel is a restriction on their business model. The name ‘Makerspace’ also refers to the regular Maker Faires, Make Magazine and Maker Shed, all brands owned and promoted by Makermedia (<http://makermedia.com>). Makermedia itself, founded in 2005, is an offspring of O’Reilly publishers (independent since 2013) and the self-promoted leader of the Maker movement. Maker Faires are events that bring together the proponents of the maker movement, Make Magazine promotes ‘DIY-projects, how-tos and inspiration from geeks, makers and hackers’, MakerShed is the official online store of Make Magazine.

Techshop is an a US based is a chain of member-based workshops that lets people of all skill levels come in and use industrial tools and equipment to build their own projects. Its first workshops were opened in the Bay area in 2006, the company is currently looking into expanding into other continents. A first European Techshop has been announced to open in Munich (Zheng, 2013), and Rotterdam is trying to attract Techshop (Louwes, 2013). Techshops’ founder has published the The Maker Movement Manifesto: Rules for Innovation in the New World of Crafters, Hackers, and Tinkerers (Hatch, 2013).

Globally, big players have started to fund Fab Lab on a substantial scale. Schlumberger is supporting the development of Fab Labs in Russia, Aramco sponsored the first Fab Lab in Dhahran (Saudi Arabia), and Chevron promised support fort setting up Fab Labs in US communities where it is active. Ford in the US and BMW in Germany are partnering with Techshop

to provide their employees with access to digital manufacturing technology for tinkering outside working hours.

More interesting, however, are small-scale but high-tech developments, certainly from a perspective of emerging socio-technical production paradigms. For instance, Barcelona is pronouncing itself as 'Fab City' and aims to develop neighbourhood Fab Labs in every city district. The Dutch order of Inventors was a key partner for setting up the Fab Lab in Utrecht. In Amersfoort, the Netherlands, an artists' collective is effectively transforming a former dye factory into a test bed for the transition town movement, centered around a Fab Lab. The Swiss clean tech accelerator Blue Lion in Zurich is setting up a Fab Lab for its companies.

In the following section we shall provide a series of case studies of urban open innovation environments in Netherlands, that defy the top-down approach of centrally planned 'creative hotspots'. They represent not the archetypal grass-roots, bottom-up, counter-culture projects, but stand for a new type of initiatives that appear to operate on a lateral rather than a hierarchical dimension, very much akin to Rifkin's projection of a shift away from hierarchical power and toward lateral power (Rifkin, 2011).

Emerging Production Paradigms

The Dutch order of Inventors was a key partner for setting up the Fab Lab in Utrecht, Protospace, in 2008, together with the University of Utrecht, the University of Applied Sciences in Utrecht, Utrecht Province, City of Utrecht, Syntens (a former Dutch quango promoting innovation for SMEs), Utrecht Inc (a technology oriented business incubator), Technocentrum Utrecht (a now mothballed initiative to link vocational education and trade), and Taskforce innovatie regio Utrecht (a non-profit focusing on cross-sector innovation). Initially set up to bring the Fab Lab concept to Utrecht, Protospace has outgrown to a network of three related spaces and is participating in international and trans-disciplinary research projects, such as the Hydro-Zone project that aims to develop bio-printing technologies for 3D bioactive cartilage-ECM mimetic hydrogels.

The incubator Dnmo in Rotterdam decided to refocus its activities as 'RDM Maker Space'. RDM Maker Space is based at the former shipyard of the Rotterdamsche Droogdok Maatschappij (Rotterdam Dry-dock Company, RDM) that has been converted to an innovation hub where higher education, research institutions, start-ups and companies are located. The place provides opportunities for sharing knowledge, exchanging best

practices, conferences and networking. RDM Maker Space offers access to high-tech manufacturing equipment as well as prototyping and manufacturing services. RDM Maker Space aims to spur innovation and entrepreneurship and to create a place where smart, creative and experienced people with different skills come together and eventually form a large community of makers. Similarly, the Swiss clean tech accelerator Blue Lion in Zurich is setting up a Fab Lab for its companies.

In Rotterdam, there are more players who are actively working on combining real estate development and Making: urban developer Stipo Rotterdam together with the city council and Techshop are planning to convert the Zomerhofkwartier to the making neighbourhood ('maakkwartier') of Rotterdam. Zomerhofkwartier is an area in walking distance of the central train station. The owner of the area has decided on a time-out of ten years to study the potential of the area and its bottom-up initiatives after traditional approaches to (re)development turned out to be difficult and little promising. The time-out approach allows the developer to involve everybody in shaping the neighbourhood. The transitional character of the area attracts the creative industry; and the developer has pronounced the neighbourhood as the 'maakkwartier' (making quarter) with an emphasis on the creative and niche manufacturing industry and with a view to possibly attract Techshop to set up a large making facility there. Yet they remain open for others who embrace their philosophy, and remain open to the precise result of such developments (Berk, 2013).

Other initiatives include the Platform Digital Manufacturing, de Bende with its plans to make crafts-based making accessible, the 3D Print Academy, De Makers van Rotterdam, an initiative of social enterprises centered around Making, and Made-in-4Havens. Made-in-4Havens is an emerging initiative in a former but now derelict dockland area in Rotterdam managed by the city council and the port authority. The area has been designated to house innovative business in the fields of clean tech, medical and food. However, the area is also home to quite a few leading Dutch designers. Made-in-4Havens currently serves as a platform to make local design visible and to connect it to local craft and manufacturing. One vision of Made-in-4Havens is to integrate the local workforce to complement design with local production (Sant-Barendregt and van Dael, 2013).

Barcelona is pronouncing itself proudly as 'Fab City'. It aims to develop a local production facilities in the form of a network of fabrication laboratories in the inner city of Barcelona, serving as a knowledge exchange and entrepreneurial platform for its citizens. This network 'will give rise to a

new model for the city which redefines the use of new information technologies and production [technologies], giving a social, economic, and productive dimension to the tool. The same tool that has been used to construct spectacular sculptures will be reoriented now to offer solutions to local problems: energy, production or socialization of objects' (Diez, 2012, p. 465). The local network is also supposed to link to larger networks of similar production facilities.

Urban Development in Transition

Such city-wide initiatives are an expression of and impact upon urban development which currently is undergoing substantial structural changes. In the Netherlands, for example, the traditional market driven way of urban development, involving large real estate developers and municipalities acting actively on the land market, has failed as a result of the financial and economic crisis. Private and public actors are exploring new ways of working together and new actors, such as private individuals and local collectives, have entered the marketplace. As such the field of urban development is the take-off phase of transition and radical innovations are key to a further development of the process of change (cf. Peek and Troxler, 2014).

Before the financial and economic crisis started in 2007 large scale urban developments involved a municipality actively purchasing land and developing it in partnership with large private property companies based on a long-term residual financial model and a 'blue print' master plan containing certain landmarks or iconic buildings. The phase of management after the works are complete was not part of the area development process as profits were made at the moment parcels of land and constructed buildings were sold to new owners and public space was transferred to the municipal department of urban management.

After 2007 the lack of available debt finance and the sudden shift from a sellers' market to a buyers' market brought most large scale area developments to a hold. The capacity to (re)develop no longer lies with municipalities and the large property developers. Their 'marriage' dissolved or is in a state of divorce as both actors have to largely depreciate on the land assets they hold.

This situation leaves room for other actors to get directly involved in real-estate development, such as local contractors, present land-owners and users and future users of an area. The involvement of these types of actors

results in a more bottom-up approach and a decreased project size. Most striking is the emergence of appreciation for the present state of the area.

Where before a 'tabula rasa'-situation as start of the (re)development was preferred and strived for, currently actors see potential in the existing land use and aim to build on this, limiting investments upfront and benefiting from temporary uses.

In our opinion this type of urban area development does not suffice to answer the challenges our cities face. Especially in the field of sustainability the ability to invest on a larger scale is needed, for instance in infrastructure supporting renewable energy solutions and urban transit systems. In order to do so we advocate an area development process that also involves the future management phase. With this we move away from a development approach focused on risk reduction and profit from a temporary – albeit lengthy – commitment, towards the users' perspective focusing on continuity and long-term value creation combined with a continued utilitarian valuation of the property.

Viewing urban area development mainly as a process of urban management instead of a sort of property development XL offers opportunities for the coupling of juxtaposed (financial) flows in the area to those of the real estate business case. Coupling these flows, such as energy (electricity, gas, heat and cold), water, waste, transportation of people and goods and information, increases the financial base for development of the area and offers opportunities for more sustainable solutions for the future.

We agree with Rotmans (2012) and consider the present Dutch practice of urban area development to be in the take-off phase of a transition process. Changes in the external landscape of area development like a decrease in population in certain regions of the Netherlands, changing work patterns (flexible hours and working from home) and space for water resilience, have resulted in a deadlock of the pre-crisis development model.

The crisis itself was merely a trigger to reveal the faults of the system. In the meantime on a local level many bottom-up experiments are on their way. People start producing their own renewable energy, individually or in collectives. Others seize this opportunity to design and build their own home. Some experiment developing floating homes for living on water or make use of vacant plots of land for urban farming.

Analysing these niches for the perspective of our vision on the future of urban area development we find that all in some way or another deal with supply chain integration (Peek and Van Remmen, 2012). Some initiatives lead to vertical integration, as end-users take the lead in the development

process or emphasis is on the transformational powers of the current owners and users. Others mainly focus on an area based approach to utilities such as energy and water and by that resulting in a horizontal integration of real estate with these adjacent sectors. And others again revolve around the material flows in a city and aim to replace the 'Product In, Trash Out' mentality (Diez, 2012, p. 465) by a more sustainable and more locally based production system of sustainable production and reuse.

Smart Urban Development

The involvement of incubators, real estate developers and urban planners in emerging fabrication models moves making way out of the narrow field of attention of the proselytizers of the maker movement as it renders making relevant beyond the narrow scope of gonzo inventors. It could result in more sustainable solutions by relating the urban development process to the development and management of all sorts of urban infrastructures. Such solutions form a sharp contrast to what traditional parties in urban development offer, who are mainly interested in selling technology and services to governments and other public entities and accordingly have adapted to their top-down and silo structure.

Technology certainly remains a main driver of innovation. In the field of urban development we find an entire movement based on new technologies under the umbrella of the 'Smart City'. The Smart City approach has gained a lot of momentum out of the belief that the availability of intellectual capital (or knowledge) and social capital are urban production-factors that determine the competitiveness of cities (Caragliu et al., 2009). Smart City refers to sustainable urban development (smart environment); to the incorporation of information and communication technologies in the management of services (smart economy); to the generation of participatory spaces in terms of collaboration and innovation (smart governance). As such the concept may serve many different intentions, not touching upon interrelations and contributions to overarching goals, and remains particularly polysemous and vague. This is probably why it has turned into a highly used term when proposing or justifying urban reforms (Tironi, 2013). Smart City is also a successful term for marketing new urban technologies used by multinationals like IBM, Cisco, Siemens, General Electric and Philips.

While the Smart City certainly holds considerable innovative power of the Smart City, we question its transition force, particularly as the concept

has already been taken over by the dominant regime in showcases like Songdo International Business District and Masdar City. As no city wants to be a 'dumb' city, the Smart City concept is quickly adapted for benchmarking cities. An example is the Smart City-model ranking European medium-sized cities (Centre of Regional Science, 2007) that defines a Smart City as a city that is well performing in a forward-looking way in economy, mobility, environment, citizenship, quality of life and governance, built on the 'smart' combination of endowments and activities of self-decisive, independent and aware citizens. These aspects are also at the core of the Smart City Wheel that Cohen (2012) introduced to benchmark the world's major cities.

Although citizens' participation is emphasised and the benchmarks even hint at possible change in roles of government and citizens, the Smart City concept remains, both as benchmark and as marketing tool, highly top-down oriented aimed at better managing and controlling city systems by collating ever-detailed information about real time functioning, and being able to optimise decision making in the immediate, short and long term.

Cosgrave et al. (2013, p. 669) state that 'the Smart City should not necessarily be interpreted as top-down vision delivered solely through government investment. Quite the opposite, the Smart City is largely an organic 'system of systems' (Harrison and Abbott Donnelly, 2011), which comprises an ecosystem of products, services, companies, people and society that are working together creatively to foster innovation within the city'.

From a transition perspective the key concept of the Smart City should be application of ICT that is aimed at empowering citizens, rather than focussed on improving control of city systems. 'Citizens are not only engaged and informed in the relationship between their activities, their neighbourhoods, and the wider urban ecosystems, but are actively encouraged to see the city itself as something they can collectively tune, such that it is efficient, interactive, engaging, adaptive and flexible' as Arup (2010) describe in their Smart City vision. The Smart Citizens concept (Hemment and Townsend, 2014) has been effectively proposed to counter the technocratic approach criticized above.

Lab Centric Approach: Third Places

Relocating production and research functions to the centres of neighbourhoods has the potential to add to the liveability and to the local

economy. As developed above, such relocation is of little added value if it is just part of corporate strategy. Instead of focusing on offices, retail or residential areas, urban area development needs to explore the possibilities of an approach that at its centre has the lab as a key instrument for citizen empowerment. However, there are at least two pitfalls to watch out for: the lab as a clever instrument for benefitting corporate strategy through free crowd sourcing e.g. in the Living Lab concept (European Commission, 2009), and the (neo-)liberal phantasies of white western middle-class males of labs as the source for renewed entrepreneurship in the maker movement (Hatch, 2013).

Living Labs claim to bring together public and private actors, such as companies and associations, and individuals to test new services or products. They provide a user-centric approach to develop and prototype complex solutions to emerging socio-technical challenges to promote open innovation and involve users early in the design. This all happens in a real life context; their success relies heavily on user co-creation. However, little attention has been paid so far to the question if and how the participating users were not just the Guinea pigs (worst case) or co-creators (best case) in a Living Lab setting, but never actually become co-owners of the solutions proposed and developed. Results from true co-creation, one might argue, should not disappear behind corporate walls. As it is the case with open innovation, the game logic of Living Labs is still to benefit corporations that are focusing on selling services and technology to governments and other public entities. The accreditation of Living Labs through a single non-profit association – the European Network of Living Labs (ENoLL) headquartered in Brussels – as the legal representative entity of the network, does not exactly paint a more network oriented picture of the Living Lab approach.

Labs, such as local makerspaces, Fab Labs and Techshops regularly paint themselves as the new places of empowerment, as they give ordinary people access to high-tech manufacturing equipment. However, they add little to the empowerment of society at large as long as they are just promoting themselves ‘as the killer-app for personal fabrication, the market of one, individual expression in technology’ (Gershenfeld, 2006). Societal empowerment requires more than just enabling individuals to realise their technological phantasies in a technology-affirmative environment that is disconnected from the bigger societal questions that drive transition: questions of equity, fairness and diversity, questions of power and economic relations, questions of responsible use of resources and of sustainability. With Bookchin (1982) we argue that it does not make sense

to embark on empowerment through access to technology without examining and shaping the political and social structures in which they are embedded.

The emerging lab-centric initiatives need to develop into new institutions of a radically different type of economy, an economy that fundamentally contrasts the conventional top-down organization of society that characterized much of the economic, social, and political life of the fossil-fuel based industrial era. Its new paradigms are 'distributed' and 'collaborative', paradigms that appeal to a new generation of people who grew up with the Internet and who have for all their lives been engaged in distributed and collaborative social spaces in parallel to the traditional, hierarchical environments of family, school and job. The new lab-centric institutions in that way can become a further evolution of the well-known concept of third places (Oldenburg, 1989; 2000) as public, civic spaces in the built environment.

Conclusion

We conclude that the new type of use of the Urban Open Innovation Environment (Peek and Troxler, 2014) is a potentially strong change agent for radical innovation in the field of urban area development as it combines supply chain integration and empowering ICT. The success of new, lab-centric initiatives largely depends on their open character, not being part of the dominant regime of large companies and (governmental) institutions, even while they will most certainly come under pressure from shopping malls and corporate enterprises, trying to transform public space into an extension of the market. That does not necessarily mean to resign third spaces to a counter culture driven niche of grassroots/bottom-up activities, not willing or able to leverage on their efforts. True openness in this respect refers to the ability to not only involve niche players, but make cross-overs to change minded actors within the dominant regime so that though lateral development (Rifkin, 2011) new regimes may emerge and the change becomes irreversible.

Governments have an important role to play here. For Urban Open Innovation Environments to be truly open, certain room to experiment and to innovate is required. Yet, only focussing on the operational level of concrete projects is not enough. For a new regime to emerge efforts on the tactical level have to be made, involving the support of emerging new, lateral 'institutions' that are able to generate business from radical

innovations. These environments should enable new types of entrepreneurship, such as micro-multinationals, and social enterprises operating beyond traditional business models. In this way, Urban Open Innovation Environments are able to become a constant force in the field of urban area development making cities in transition more sustainable and resilient, and through inclusion and equity adding to the quality of life.

References

- Arup's IT and Communications Systems team (2010) *Smart Cities: Transforming the 21st century city via the creative use of technology*. London, Hong Kong, San Francisco, Sydney: Arup. [Online] Available from http://www.arup.com/~media/Files/PDF/Publications/Research_and_whitepapers/Arup_SmartCities_June2011.ashx [Accessed: 16 October 2014]
- Berk, H. van den: *Ontwikkelen nieuwe stijl*. [Blog] Weblog. Available from <http://www.havensteder.nl/over-havensteder/blog/artikel/artikel/ontwikkelen-nieuwe-stijl-324/> [Accessed 21 February 2014]
- Bookchin, M. (1982) *The Ecology of Freedom: The Emergence and Dissolution of Hierarchy*. Palo Alto: Cheshire Books.
- Caragliu, A., del Bo, C. and Nijkamp, P. (2009) *Smart cities in Europe*. Serie Research Memoranda 0048. Amsterdam: Faculty of Economics, Business Administration and Econometrics.
- CBA (2005) Fab Lab User Group Meeting. [Online] Available from: <http://cba.mit.edu/events/05.01.fab/index.html> [Accessed: 3 March 2014]
- CBA (2012) The Fab Charter. [Online] Available from: <http://fab.cba.mit.edu/about/charter/> [Accessed: 20 October 2012]
- Centre of Regional Science (2007) *Smart cities: Ranking of European medium-sized cities*. Vienna: UT.
- Cohen, B. (2012) The Top 10 Smart Cities on the Planet. [Blog] Fastcoexist. Available from: <http://www.fastcoexist.com/1679127/the-top-10-smart-cities-on-the-planet> [Accessed 26 February 2014].
- Cosgrave, E., Arbuthnot, K. and Tryfonas, T. (2013) *Living Labs, Innovation Districts and Information: Marketplaces: A Systems Approach for Smart Cities*. Paper Presented at the Conference on Systems Engineering Research (CSER 13), Atlanta, Georgia Institute of Technology.

- Diez, T. (2012) Personal Fabrication: Fab Labs as Platforms for Citizen-Based Innovation, from Microcontrollers to Cities. *Nexus Network Journal* 14 (3), 457-468.
- Gershenveld, N. (2006) Digital Revolution in Fabrication. [Video] Available from: http://www.ted.com/talks/neil_gershenveld_on_fab_labs.html [Accessed 20. Sept. 2012].
- Harrison, C. and Abbott Donnelly, I. (2011) *A Theory of Smart Cities*. Paper Presented at the Proceedings of the 55th Annual Meeting of the ISSS, University of Hull Business School.
- Hatch, M. (2013) *The Maker Movement Manifesto: Rules for Innovation in the New World of Crafters, Hackers, and Tinkerers*. New York: McGraw-Hill.
- Hemment, D. and Townsend, A. (eds.) (2014) *Smart Citizens*. Manchester: Future Everything Publications.
- Louwes, C. (2013) Hybride bril helpt printende stad. *Concire column*. [Online] Available from <http://www.concire.nl/consideria.php?sub=column> [accessed 3 March 2014]
- Oldenburg, R. (1989) *The Great Good Place: Cafes, Coffee Shops, Community Centers, Beauty Parlors, General Stores, Bars, Hangouts, and How They Get You Through the Day*. New York: Paragon House.
- Oldenburg, R. (2000) *Celebrating the Third Place: Inspiring Stories about the 'Great Good Places' at the Heart of Our Communities*. New York: Marlowe & Company.
- Peek, G.J. and Remmen, Y.V. (2012) *Investeren in gebiedsontwikkeling nieuwe stijl: Handreikingen voor samenwerking en verdienmodellen*. Den Haag: Ministerie van Infrastructuur en Milieu.
- Peek, G.J., and Troxler, P. (2014) *City in Transition: Urban Open Innovation Environments as a Radical Innovation*. Paper Presented at Real Corp 2014, 19th International Conference on Urban Planning and Regional Development in the Information Society, Vienna.
- Rifkin, J. (2011) *The Third Industrial Revolution: How Lateral Power is Transforming Energy, the Economy, and the World*. New York: Palgrave Macmillan.
- Rotmans, J. and Horsten, H. (2012) *In het oog van de orkaan. Nederland in transitie*. Boxtel: Aeneas.
- Sant-Barendregt, J. and Dael, Y.V. (2013) Pionieren aan de Maas. Oude economie vs. nieuwe economie. *INN010. Inspiratie uit Innovatie*, 1, 25-27.

- Tironi, M. (2013) Smart Cities: Urban laboratories and experiments. [Blog] Sustainable-mobility.org Forum. [Online] Available from <http://www.sustainable-mobility.org/forum/smart-cities-urban-laboratories-and-experiments.html> [Accessed 26 February 2014].
- Zheng, C.J. (2013) TechShop Partners with BMW Group and UnternehmerTUM – Center for Innovation and Business Creation at Technical University Munich. Press Release. [Online] Available from http://www.techshop.ws/press_releases.html?&action=detail&press_release_id=55 [Accessed: 1 Nov 2013].

Health, Safety, and Wellbeing



The document use as a situated practice in pre-hospital emergency care

Petra AUVINEN^{*a}, Hannele PALUKKA^a and Ilkka ARMINEN^b

^a University of Tampere; ^b University of Helsinki

Our paper concerns the activity of patient reporting in pre-hospital emergency care from ethnomethodological point of view. The reporting activity is approached as a situated joint accomplishment of three participants, i.e., two paramedics and a patient. The participants simultaneously orient to different modes of action in the performance of patient reporting, including talk, gesture, and use of material tools. The essential tool or resource used in the completion of reporting activity is Patient Care Report (PCR) form, which the paramedics are required to fill out for every patient. In the setting analysed, the documentation of pertinent patient information is done manually, with paper and pen. This paper studies the use of PCR form as a socio-material activity and asks: How the use of the form organizes, and is organized by, the situated courses of interaction between the paramedics and the patient? The paper also ponders the relationship between paper-based and electronic patient reporting and the implications these different technologies may have for the organization of paramedics-patient –interaction and future design of reporting systems. The research data consist of one of twenty-seven video recordings of paramedics-patient –encounters made within Pirkanmaa Hospital District’s area in Finland in 2010.

Keywords: Patient reporting; pre-hospital emergency care; paper and pen; multimodal interaction; ethnomethodology

Introduction

The paramedics are healthcare professionals trained to handle various medical emergencies, such as car accidents, heart attacks, slips and falls, childbirth and gunshot wounds. The paramedics are typically dispatched by the Emergency Response Centre (ERC) operator to the scene. The ERC operator receives and evaluates the emergency calls from 112 and hands

^{*} Corresponding author: **Petra Auvinen** | e-mail: petra.auvinen@uta.fi

the assignment over to the appropriate units. The paramedics are often first to arrive at the scene. Their task is to provide emergency care to the patient and, if necessary, transport the patient to a medical facility. The paramedics work in two-person teams in which each member has pre-assigned duties. Most basically, one paramedic interviews the patient and fills out the PCR form using traditional paper and pen technology while the other paramedic conducts the physical examination of the patient and drives the ambulance (on the division of labour in action, see Auvinen and Palukka, 2012).

This paper analyses the use of PCR form in the moment-to-moment evolving courses of interaction between the two paramedics and the patient. The specific interest focuses on how the activity of manual form filling constitutes, and is constituted through, the triadic interaction of participants in emergency care situation. The primary research data consist of video recordings of interactions between paramedics and patients made at the scene and during ambulance transports. In total twenty-seven (27) emergency missions were recorded within the Pirkanmaa Hospital District's area in Finland in 2010. The secondary data include the paper copies of the original PCR forms of the recorded missions. The paramedic teams participating in the recordings work in Advanced Life Support (ALS) ambulances in either public or private sector. They are relatively highly trained professionals being able to perform such emergency care skills as cardioversion, endotracheal intubation and medication administration.

The paper relates to earlier ethnomethodologically-informed studies on document use in various institutional settings. For example, Garfinkel and Bittner (1967) show that the sense and intelligibility of psychiatric files, or any organizational record is found in the socially organized occasions of their use. Luff, Heath and Greatbatch (1992) analyse the ways in which both paper and screen based documentation is used in the production and co-ordination of collaborative activities in a variety of workplaces. The study by Whalen (1995) concerns the use of the electronic call-record form for a police and fire emergency communications system. It shows how the naturally occurring uses of the form is coordinated with the organization of talk-in-interaction between callers and call-takers.

Moore, Whalen and Hankinson Gathman (2010) examine the situated use of the work order form in face-to-face service encounters of the copy shop. They reveal how the activity of form filling is the product of a collaboration between employee and customer. Finally, Auvinen and Arminen (2013; see also Auvinen, 2009; Arminen and Auvinen, 2013) report the airline pilots' use of the checklist documents as a resource in displaying

their socially shared understandings of the phase of the flight. Following the studies mentioned above, this paper approaches the use of the PCR form as a collaborative achievement of the participants in interaction. The sense and intelligibility of the form becomes visible and thus analysable in its situated practices of use.

Theory and methodology

Theoretically, the paper is based on the anthropology of science and technology and workplace studies (Suchman, 1987; Goodwin, 1995; Heath and Luff, 2000). These traditions form a naturalistic approach committed to the detailed study of social and work practices in complex organizational settings. The analytic focus is on the tacit body of reasoning and procedures through which the participants produce, make sense of and coordinate activities with each other. Drawing on the combination of methods of ethnomethodology (EM), conversation analysis (CA) and ethnography, the approach analyses the production and coordination of tasks in real-time interaction through talk and visual conduct.

CA studies talk-in-interaction (Schegloff, 1987) – the term encompassing talk and other interactional activity, including physical activities, gestures and paralinguistic features of talk. CA concerns the ways in which utterances accomplish particular social actions in terms of their placement and participation within sequences of action. The primary units of analysis are thus sequences and their component unit turns conceived as turns-within-sequences (Heritage, 1984).

The sequences, or, courses of action implemented through talk are generally organized around a basic unit of sequence construction called the adjacency pair (Schegloff and Sacks, 1973). The adjacency pair is a sequence of two utterances being ordered as a first pair part (FPP) and a second pair part (SPP). The production of an utterance identifiable as a FPP (e.g., a question) selects a next speaker who should immediately proceed to produce the appropriate SPP (i.e., an answer) (Schegloff, 2007; Arminen, Koskela and Palukka, 2014).

The regular occurrence of certain paired actions is explained by the property of conditional relevance, which stipulates that the production of the FPP makes a corresponding SPP both relevant and expectable. Providing the next speaker fails to respond, his/her behaviour becomes accountable.

The first speaker may infer that the recipient has some trouble in responding. By, for example, repeating the question, the first speaker

displays that the answer to the original question was appropriate and it is officially absent. (Schegloff, 1972)

Our data analysis will show in detail, how the activity of patient reporting including both talk and physical activities is sequentially organized in interaction between the paramedics and the patient. The sequential organization of talk-in-interaction is significant in respect of how intersubjectivity – the mutual understanding of ongoing talk and action – is accomplished and displayed in talk. The adjacent positioning enables co-participants to show their understandings of the current talk and action and to recognize possible misunderstandings in conversation. (Schegloff and Sacks, 1973; Heritage, 1984)

The situated use of the PCR form

The two paramedic team members work in the roles of attendant and driver, which change from one emergency mission to another. The driver's task is to drive the ambulance to and from the emergency mission and conduct the physical examination of the patient. The examination typically includes the measurement of the patient's vital signs, such as body temperature, heart rate, breathing rate and blood pressure. The driver informs the vital sign values to the attendant who writes them down into the PCR form (figure 1). Depending on the patient's situation, the driver uses different tools and technologies in patient examination, ranging from a thermometer to a complex defibrillator with electrocardiogram (EKG) capability.

Within paramedic team, the attendant has the authority to lead the conduct of emergency care and make treatment decisions under their responsibilities. The attendant is also responsible for interviewing the patient and documenting the necessary information. The structure of the patient interview largely follows the PCR form on which the attendant writes down the information about the event or incident, the patient's contact details, medical condition, history, and treatment rendered. The attendant may also consult the physician-on-duty via phone about the patient's treatment.

The document use as a situated practice in pre-hospital emergency care

Kela Paivälujen tuottaja ja Y-tunnus **Selvitys ja korvaushakemus sairaankuljetuksesta** OSA 1

Henkilötunnus Identity number		Matkapäivä	Yksikkö	Kulj. juoks.nro											
Tilaja <input type="checkbox"/> hätäkeskus <input type="checkbox"/> muu, mikä?	Lähtöpaikka <input type="checkbox"/> asema <input type="checkbox"/> muu, mikä?	Tehtäväosoite <input type="checkbox"/> = kotiosoite <input type="checkbox"/>	<input type="checkbox"/> Jatkokuljetus	Tehtäväkoodi											
Puhelu alkoi klo	Potilaan nimi Patient's name	Potilas on lieäpakkaila <input type="checkbox"/> paarella <input type="checkbox"/> istuvana		Kuljetus-X-koodi											
Tehtävä alkoi		Kotikunta <input type="checkbox"/> Ulkomaalainen / lomake liitteenä		Ajokm yhteensä											
Kohteessa	Kotiosoite (lähiosoite ja postitoimipaikka) Home address														
Potilaan luona		Viite-numero													
Kuljetus alkoi	Matkan aihe <input type="checkbox"/> Sairaus tai raskaus <input type="checkbox"/> Liikennevahinko *) <input type="checkbox"/> Työtapaturma *) <input type="checkbox"/> Vakuutusyhtiön nimi	Ei Kelan korvattava <input type="checkbox"/> Laitoshoido-/ sairaalapotilas <input type="checkbox"/> Muu Mistä laskutettava?	Lähtömaksu -20 km Laskutettavat lisä- kilometrit km 2. sairaankuljettaja t min Odotusaika (yli 1 t) t min	Euroa											
Potilas luovutettu															
Tehtävä päättyi															
Tapahtumatiedot. Pääasiallinen syy (oire tai kohtaus, vammautumistapa; milloin alkoi tai sattui), silminnäkijän yhteydetiedot				Yhteensä											
Event / incident information				Omvastuu											
				Kelailta laskutetaan											
				EVY kohteessa klo											
Tila tavattaessa (oire, vaman löydökset)															
Patient's condition															
Sairaudet, nykyilääkitys, lääkeaineallergiat, aikaisemmat sairaalahoidot															
Illnesses, medication etc.															
SEURANTA KLO	VERENPAIN	SYKE-TAAJUUS	RYTMI	HENGITYS-TAAJUUS	HENGITYS-ÄÄNET	PEF	ETCO ₂	SpO ₂	TAALINTA (GCS) Silmät	PUHE	LIKE	KIPU 0-10	B-gluk	ALKO-METRI	LÄMPÖTILA, mistä
Tavattaessa A															
B															
C															
D															
Hoito (toimenpiteet, lääkitys) ja hoidon vaste. <input type="checkbox"/> Lääkärin konsultoitu <input type="checkbox"/> Lääkäri kohteessa. Lääkäri nimi ja toimipaikka. Annetut hoito-ohjeet															
Treatment															
Hoidosta / kuljetuksesta kiellettyjen allekirjoitus															
Hoitoa antaneen allekirjoitus ja nro <input type="checkbox"/> Lomakkeen tiedot jatkuvat eri paperilla															
Muun henkilöstön nro(t) <input type="checkbox"/> Lähimaisen nimi ja puhelinnumero <input type="checkbox"/> Saattaja mukana															
TERVEYDENHOITO-LAITOKSEN TODISTUS	Vakuutan edellä olevan selvityksen perusteella, että potilaan terveydentila <input type="checkbox"/> edellyttää <input type="checkbox"/> ei edellytä kuljetusta ambulanssilla. Potilaan vastaanotettava henkilön allekirjoitus, nimen selvitys ja virka-asema										Potilaan vastaanotettava hoitolaituksen nimi ja leima				

SV 210 04.07 HOITOLAITOKSELLE; liitetään sairauskertomukseen / POTILAALLE; jos ei kuljetusta

Figure 1 The Patient Care Report (PCR) form.

The main purpose of documentation is to provide an accurate, comprehensive and permanent record of the patient's condition and

treatment. The PCR is primarily a clinical document utilized by subsequent care providers, such as nurses and physicians. The PCR is also a legal document which will be closely examined when a malpractice suit is filed or a standard of care is otherwise questioned. Moreover, the PCR is used for financial reasons to handle the reimbursement issues with, as in our case, the Social Insurance Institution of Finland.

Empirical analysis

The empirical analysis concerns the sequential organization of the PCR form use with the practices of talk-in-interaction in emergency care situation. The specific interest focuses on how the manual form filling is sequentially coordinated with the ongoing courses of interaction between the paramedics and the patient.

The three data extracts shown are chosen from one emergency care situation recorded in 2010. The Emergency Response Centre had determined the urgency category of this emergency call as C referring to the call with a low risk of being life threatening in the next thirty minutes.

The event takes place in the patient compartment of the ambulance located in the yard of an apartment building. The female patient (P on the extract) of over 70 years old had hurt her knee in the corridor of the building and is now laying on an ambulance bed. The male attendant (P1 on the extract) is sitting on a chair and keeping the PCR form on his knees. The male driver (P2 on the extract) is examining the patient with a standing position.

The data extracts are transcribed according to the conversation analytic notation system shown after References. Each participants' talk is described in two lines. The first line is the original talk in Finnish while the second is its translation into English. Where relevant for better understanding the sequential organization of talk and action, the participants' embodied activities are described verbally and, on occasion, visually with still pictures.

Extracts 1 and 2 exemplify the two ways in which the activity of patient reporting gets basically done. As shown in Extract 1, the activity of patient reporting can occur in three-part sequences in the courses of interaction between the paramedics and the patient. One regular or institutionalized patient reporting sequence thus includes 1) P1's question, 2) P's answer and 3) P1's writing activity.

Extract 1

- 01 (13.2)
02 P1: noin↑ suoritellaan sitte?,
okay↑ one performs then?,
03 (1.6)
04 P1: vähän kirjallisia töitä tässä.=mikäs se on rouva teidän nimenne,
a little bit of writing work here.=what's madam your name,
05 (0.5)
06 P: meikäläinen maija, ((name changed))
poppins mary,
07 (0.7)
08 P1: meikäläinen,=
poppins,=
09 P: =meikäläinen juu,
=poppins yeah,
10 ((P1 writes on the item of 'name' and lifts pen; (8.2)))



Figure 2 P1 writes on the item of 'name' (line 10).

- 11 P1: maija,
mary,
12 (0.4)
13 P: maija joo,
mary yeah,
14 ((P1 continues writing on the item of 'name; (3.5)))
15 P1: [mikäs se on maija teidän henk()tu- henkilötunnus,
[what is mary your ident()nu- identity number,
16 ((P1 lifts pen))

At lines 2-4, the P1 orients to the activity of patient reporting by referring to the manual form filling ('writing work') to be done next; he then

asks the patient's name as part of the patient reporting protocol. With her responding turn, the P not only complies with the normative expectations of the prior turn but also displays her understanding of the protocol in action (line 6). After the P has confirmed the P1's candidate understanding concerning the P's last name (lines 8-9), the P1 starts to fill out the relevant item on the form (line 10; figure 2). He then lifts pen and delivers another candidate understanding about the P's first name at lines 10-11. After receiving the confirmative response from the P, the P1 continues writing on the item of name. Simultaneously with completing his current writing activity by lifting his pen, the P1 delivers the second question concerning the P's identity number.

In Extract 2, the measuring activities conducted by the P2 in collaboration with the patient project the standardized base sequence of patient reporting consisting of 1) P2's informing turn and 2) P1's writing activity.

Extract 2

- 01 (0.7)
02 P2: °sit otetaan° lämpöö tuolta korvasta?,
°then one takes° temperature from the ear?,
03 ((P2 holds the thermometer in P's ear; (4.0)))
04 pi::p, ((thermometer sound))
05 ((P2 retracts the thermometer; (1.1)))
06 P2: kolme kuus ja seittemän, ((36.7))
three six and seven, ((36.7))
07 ((P1 writes on the item of 'vital signs;' (4.9)))



Figure 3 P1 writes on the item of 'vital signs' (line 7).

The P2 tells the P about the upcoming activity of measuring the P's temperature *from the ear* and then performs the appropriate measuring activities (lines 2-5). The activities conducted by the P2 together with the patient are preliminary to the base sequence of patient reporting. Thus, the

informative turn concerning the P's temperature ('three six and seven') is directed to the P1 who then writes the value down on the item of 'vital signs' (line 7; figure 3).

The third extract describes a multitasking situation in which the reporting activities exemplified in Extracts 1 and 2 occur simultaneously and overlap. As a consequence of the concurrent courses of (inter-)action, the P1's writing activity concerning the particular vital sign value is temporarily postponed. The extract is presented here in multiple parts because of its lengthiness.

Extract 3

01 (0.7)

02 P2: otetaan se verensokeri siitä sormenpäätä (ni),
one takes the blood sugar from the fingertip (so),

03 (0.5)

04 P2: °vähä?, (0.2) pistää?, °
°it'll slightly?, (0.2) stab?, °

05 ((P2 pricks the P's finger with a small needle; (1.5)))

((8 lines omitted))

14 P2: noin↑ [ja tuolla voitte hieman puristaa siitä (), (.)
okay↑ [and with that you can a little press there (), (.)

15 [((P2 gives a tissue to P))

16 P2: no:in,
like tha:t,

17 (0.3)

18 P: °kiitos, °
°thank you, °

The P2 informs the P not only about the upcoming activity of measuring the blood sugar level *from the fingertip* but also about the stabbing sensation of the operation (lines 2-4); the pricking operation is then carried out at line 5. During the lines omitted, the P2 continues his measuring activities and the P1 asks from the P about her home address. The P2 and the P complete their ongoing course of interaction at lines 14-18: the P thanks the P2 of giving her a tissue to press the prick on the fingertip.

In order to continue with the reporting activities, the P2 needs to inform the P1 about the P's blood sugar level. This is done in the following fragment.

- 19 ((P1 writes on the form, e.g., on the item of 'illnesses;' (10.7)))
20 P1: oliko ↑ muita saira*uksia ku se tablettihoitonon diabe:t:es,
were there any ↑ other illne*sses than the tablet treated
diabe:t:es, ((*lifts pen from the item of 'illnesses'))
21 (1.0)
22 P: verenpainetauti↑ ja sitte sii- *siihen on lääkitys
arterial hypertension↑ and then fo-*for it there' s a medication
23 ((*P1 continues writing on the item of 'illnesses'))
24 P: ja sitte on se tykytys,=ei mulla muita oo?,
and then there's the throbbing,= i don't have anything else?,
25 (0.7)
26 P2: kaheksan pilkku kolme ((8.3)) on sokeri,
eight point three ((8.3)) is the sugar,
27 (0.7)
28 P1: [eli kolesterilääkitys °oli sitte vielä,°
[so the cholesterol medication °was there still,°
29 ((*P1 lifts pen from the item of 'illnesses'))



Figure 4 P1 lifts pen from the item of 'illnesses' (line 29).

- 30 (0.6)
31 P: no:↑ kolestero:liin mää en syö lääkettä?,
well:↑ for kolestero:l i'm not eating medication?,
32 (0.5)
33 P1: ni,
right,
34 (0.5)
35 P: °m:;,°
°hm:;°

At the end of a (10.7)-second pause, the P1 fills out the item of ‘illnesses’ (line 19). He inquires whether the P has any *other illnesses than* the already discussed *tablet treated diabe:t:es*, and simultaneously suspends his writing by lifting pen (line 20). With the response at lines 22-24, the P displays her understanding of the prior turn, i.e., the P1 is seeking information not only about the illnesses but also about the medication used. *The throbbing* in P’s response refers to the arrhythmia that is also treated with medication, as the P discussed earlier. The P1 continues writing on the item of ‘illnesses’ simultaneously with the P’s response (lines 22-23).

The P2 initiates a course of interaction with the P1 by delivering the P’s blood sugar level of *eight point three* at line 26. As mentioned, the P1’s task is to write the value down on the form item of ‘vital signs.’ The P1 suspends filling out the item of ‘illnesses’ at line 29 (figure 4). Instead of shifting the nib to the ‘vital signs’ item, the P1 keeps the pen still and continues talking with the P about her medication (lines 28-35). As shown in the fragment below, the P1’s writing activity concerning the blood sugar level is starting to take place after the P2’s intervention.

- 36 (0.7)
37 P2: ka[heksan ((8)) ja kolme ((3))],
ei[ght ((8)) and three ((3))],
38 P1: [(eli et-)]
[(so th-)]
39 ((P1 shifts the nib towards the item of ‘vital signs;’ (1.0)))



Figure 5 P1 shifts the nib towards the item of ‘vital signs’ (line 39).

- 40 P1: elikä oikeestaan sitte on niinku?,
so actually there’s uhm?,
41 ((P1 starts to write on the item of ‘vital signs;’ (1.6)))



Figure 6 P1 starts to write on the item of 'vital signs' (line 41).

- 42 P1: jäljellä toi#?,
left the#?,
- 43 (0.7)
- 44 P1: diape:tes ja verenpainelääke,
diabe:tes and blood pressure medicine,
- 45 (0.4)
- 46 P: ↑nii?,
↑yes?,
- 47 (1.7)
- 48 P1: ka[he]ksan pilkku kolme ((8.3)) oli sokeri nyt?
ei[gh]t point three ((8.3)) was the sugar now?
- 49 P: [(ja)],
[(and)],
- 50 ((P1 shifts the nib away from the item of 'vital signs;' (2.2)))
- 51 P: se nousee aina kun mää hermostun,
it'll rise every time that i get nervous,

The P2 marks the P1's particular writing activity as noticeably absent by repeating the blood sugar value at line 37. In overlap with the P2's repetition, the P1 continues his course of interaction with the P (lines 37-38). Within the following (1.0)-second pause, the P1 shifts the nib towards the item of 'vital signs' (line 39; figure 5). He starts to fill out the blood sugar value while simultaneously maintaining the conversation with the P (lines 40-42; figure 6).

During the ensuing interaction with the P, the P1 suspends his writing of the blood sugar value (not shown on the transcript). Because of the camera angle directed elsewhere, the completion of the P1's writing activity is difficult to exactly locate. The writing activity is completed at least by line 50, when the P1 shifts the nib away from the item of 'vital signs.'

Finally, the P1 reiterates the blood sugar value at line 48. If directed to the P2, the P1's turn functions as a confirmation that the P1 has received

and understood the P2's prior turn at line 37. However, by accounting for her blood sugar level (*'it'll rise every time that i get nervous'*), the P treats the P1's turn as directed to her as a complaint (line 51).

Discussion

Our analysis concerned the activity of patient reporting through the situated uses of the PCR form by the participants in interaction. The detailed analysis of interaction revealed how the paramedics and the patient oriented to the proper accomplishment of the task in hand. The participants displayed their mutual understandings of the appropriate use of the form by ensuring that the pertinent information is documented in the first place and that the information documented is correct.

The interaction analysis also made visible the participants' orientation to the sequential organization of patient reporting including both talk and visual actions. As in the first example, the attendant asked another question from the patient only after writing down the information concerning the patient's prior answer. The second example showed, how the attendant initiated his writing activity after receiving the information concerning the patient's temperature from the driver.

Moreover, the data analysis described a multitasking situation in which the various reporting activities intertwined and overlapped. The final example described how the attendant's writing activity was temporarily postponed in favour of ongoing interaction with the patient. The attendant completed his writing activity after driver's intervention with which the driver treated the attendant's move of non-writing as officially absent (on the processing of absent actions in cockpit interaction, see Auvinen, 2009).

The data analysis examined the patient reporting in general and the use PCR report form in particular as a collaborative activity, jointly accomplished by the participants in interaction. The detailed analysis of talk and action highlighted the fine-grained interactional work required both from the paramedics and the patient in the performance of their institutional tasks. The relationship of verbal and embodied action and the maintenance of alignment between participants are consequently the critical features or phenomena to be discussed here.

The verbal and embodied action streams may have differing relationships in interaction, since they may be coupled, i.e., interlocked, or decoupled, i.e., unrelated (Levinson, 2013). The decoupling of verbal and embodied action makes the sense of multitasking evident. In our final example analysed, there occurs a decoupling of paramedical practices at

about line 26. At that point, the driver orients to reporting the patient's blood sugar value to the attendant; instead of immediately writing the value down, the attendant continues interviewing the patient.

The decoupling of talk and embodied action is not unambiguously good or bad. It can be an efficient and flexible way to organize the situated courses of interaction in the work settings. For example, in his study on the activity of advice-giving in interactions between nurses and patients, Leppänen (1998, p. 227-229) showed how the nurse postponed her embodied action to highlight the salience of verbal advice. The decoupling of talk and embodied action can also increase the complexity of interaction. In our case, for example, the driver were required to do some extra work in monitoring and ensuring that the blood sugar value eventually became documented by the attendant.

The different medical encounters involve a balancing between medical realm and a patient's life world (Heritage and Maynard, 2006). The paramedics and the patient may differ in how they feel and what they feel about the emergency care situation, and the way it gets handled. These different emotional orientations can lead into misalignment between participants. The patient's negative emotions like distress or anxiety may deepen the misalignment. As shown in our final example, the patient gave an affectively framed account for her blood sugar level, while the paramedics were handling it in an emotionally neutral way (on the misalignments between ERC operator and caller, see Vaajala et al., 2013).

The multitasking nature is a critical part of the sequential organization of action and interaction in pre-hospital emergency care. The (de-)coupling of verbal and embodied action and (mis-)alignments between participants in interaction feature multitasking situations, and are therefore a salient and viable area for research.

Conclusion

In the setting analysed here, the paramedic team uses a paper-based patient reporting system in the emergency care situations. Many emergency medical services (EMS) not only in Finland but also elsewhere are currently implementing or planning to implement electronic patient record (EPR) systems, which are found to be beneficial in respect of documentation compliance and uniformity, accuracy of vital signs registration, appropriate use of online medical direction, and integration with the hospital medical record.

In terms of examples of prior studies on patient reporting systems, Kuisma et al. (2009) examined statistically how the change from paper based patient records to electronic patient records effected on ambulance call duration in Helsinki EMS, Finland. Landman et al. (2012) explored the experiences of the EMS agencies as they adopt and implement EPR systems in the United States and Canada. By using qualitative interviews of EMS agency leaders as data, they sought to characterize the motivations and challenges associated with adoption and implementation.

To our knowledge, no study before ours has examined the use of the patient reporting system from ethnomethodological point of view, as a collaborative accomplishment of the participants in naturally occurring situations. We aim to continue our analysis with the existing data and also collect new data from Helsinki EMS using electronic patient reporting system. Our plan is to compare the uses of paper based and electronic patient reporting systems through the detailed analysis of interaction and contribute to designing more usable systems.

Our future work includes comparative analysis of the implications of the uses of different documentation methods (paper vs. electronic) for the organization of interaction between the paramedics and the patient. We suggest that in the case of electronic patient reporting, the courses of action and interaction are sequentially organized in basically the same way as in the case of paper based patient reporting shown here. In the situated uses of electronic patient reporting systems, the absent actions or other kinds of sequential problems may thus also occur. However, while using electronic patient reporting systems, these problems are resolvable not only with human but also with machine interventions. Following the interactive theme of our work, our final aim is to give some impetus to the dialogue between research on the situated use of patient reporting systems and their design.

References

- Arminen, I. and Auvinen, P. (2013) Environmentally coupled repairs and remedies in the airline cockpit: Repair practices of talk and action in interaction. *Discourse Studies*, 15 (1), 19-41.
- Arminen, I., Koskela, I. and Palukka, H. (2014) Multimodal production of second pair parts in air traffic control training. *Journal of Pragmatics*. [Online] Science Direct Database 65, p. 46-62. Available from: <http://dx.doi.org/10.1016/j.pragma.2014.01.004>. [Accessed: 15th May 2014].

- Auvinen, P. (2009) *Achievement of Intersubjectivity in Airline Cockpit Interaction*. Tampere: Tampere University Press.
- Auvinen, P. and Arminen, I. (2013) An Airline Checklist Use as a Sociomaterial Practice. *46th Hawaii International Conference on System Sciences (HICSS)*. [Online] IEEE Xplore Database, p. 1590-1599. Available from:
<http://ieeexplore.ieee.org/stamp/stamp.jsp?tp=&arnumber=6480032>. [Accessed: 13th November 2014].
- Auvinen, P. and Palukka, H. (2012) Organization of work in interaction between the paramedics and the patient. *Work*, 41 (1), 42-48.
- Garfinkel, H. and Bittner, E. (1967) 'Good' organizational reasons for 'bad' clinic records. In Garfinkel, H. (eds.), *Studies in Ethnomethodology*. Englewood Cliffs: Prentice-Hall.
- Goodwin, C. (1995) Seeing in Depth. *Social Studies of Science*, 25 (2), 237-274.
- Heath, C. and Luff, P. (2000) *Technology in Action*. Cambridge: Cambridge University Press.
- Heritage, J. (1984) *Garfinkel and Ethnomethodology*. Cambridge: Polity Press.
- Heritage, J. and Maynard, D.W. (eds.) (2006) *Communication in medical care: Interaction between primary care physicians and patients*. Cambridge: Cambridge University Press.
- Kuisma, M., Väyrynen, T., Hiltunen, T., Porthan, K. and Aaltonen, J. (2009) Effect of introduction of electronic patient reporting on the duration of ambulance calls. *American Journal of Emergency Medicine*, 27 (8), 948-955.
- Landman, A.B., Lee, C.H., Sasson, C., Van Gelder, C.M. and Curry, L.A. (2012) Prehospital Electronic Patient Care Report Systems: Early Experiences from Emergency Medical Services Agency Leaders. *PLoS ONE*, 7 (3).
- Leppänen, V. (1998) The Straightforwardness of Advice: Advice-Giving in Interactions between Swedish District Nurses and Patients. *Research on Language and Social Interaction*, 31 (2), 209-239.
- Levinson, S.C. (2013) Action formation and ascription. In Stivers, T. and Sidnell, J. (eds.), *The handbook of conversation analysis*. Malden, MA: Wiley-Blackwell.
- Luff, P., Heath, C. and Greatbatch, D. (1992) *Tasks-in-interaction: paper and screen based documentation in collaborative activity*. In Turner, J. and Kraut, R. (eds.) *Proceedings of CSCW' 92 Conference on Computer-Supported Cooperative Work*. New York: ACM Press.

- Moore, R.J., Whalen, J. and Hankinson Gathman, E.C. (2010) *The work of the work order: document practice in face-to-face service encounters*. In Llewellyn, N. and Hindmarsh, J. (eds.), *Organisation, Interaction and Practice. Studies in Ethnomethodology and Conversation Analysis*. Cambridge: Cambridge University Press.
- Schegloff, E.A. (1972) *Sequencing in Conversational Openings*. In Gumperz, J.J. and Hymes, D. (eds.), *Directions in Sociolinguistics. The Ethnography of Communication*. New York: Holt, Rinehart and Winston.
- Schegloff, E.A. (1987) *Between Macro and Micro: Contexts and other connections*. In Alexander, J., Giessen, B., Munch, R. and Smelser, N. (eds.), *The Macro-Micro Link*. Berkeley: University of California Press.
- Schegloff, E.A. (2007) *Sequence Organization in Interaction. A Primer in Conversation Analysis*. Cambridge: Cambridge University Press.
- Schegloff, E.A. and Sacks, H. (1973) Opening up Closings. *Semiotica*, 8 (4), 289–327.
- Suchman, L. (1987) *Plans and situated actions: the problem of human-machine communication*. Cambridge: Cambridge University Press.
- Vaajala, T., Arminen, I. and De Rycker, A. (2013) *Misalignments in Finnish emergency call openings*. In De Rycker, A. and Don, Z.M. (eds.), *Discourse and Crisis. Critical perspectives*. Amsterdam: John Benjamins.
- Whalen, J. (1995) *A Technology of Order Production: Computer-Aided Dispatch in Public Safety Communications*. In Have, P. and Psathas, G. (eds.), *Situated Order: Studies in the Social Organization of Talk and Embodied Activities*. Washington, DC: University Press of America.

Transcription conventions

- [] the beginning and ending of overlapping talk/embodied action
= immediately continuous talk
(1.5) pause measured in seconds
(.) micro-pause, shorter than 0.2 seconds
— emphasis
: stretch
↑ ↓ shifting into higher or lower pitch
. falling intonation
, continuing intonation
? rising intonation
?, slightly rising intonation
° ° diminishing voice
creaky voice
num- production of word is cut off

PETRA AUVINEN, HANNELE PALUKKA, ILKKA ARMINEN

word< sudden stop
.hh in-breath
hh out-breath
(word) unclearly heard
() word not heard
(()) transcriber's comment
(()) description of non-talk activity

L'interpenetrazione tra valori e design nell'ideazione, implementazione e funzionamento della rete di Telessaúde brasiliana

Carlo BOTRUGNO*

University of Bologna

Science and Technology Studies brought a great contribution to the construction of a multifaceted theory through which investigate the processes of design and implementation of telemedicine networks in public health systems. Breaking up with the mainstream of USA and EU telemedicine development, the case of Brazilian Telessaúde goes beyond the classic scheme of the socially mediated characters of the technological artefacts, showing a more profound implication of the system in pursuing objectives of inequalities reduction in healthcare services accessibility.

According to the Brazilian public health system strategies of 'Permanent Education' and 'Humanization', Telessaúde network remains 'on the background' of the medical ecology, respecting the sense of the social relations.

Keywords: *Medical knowledge; telemedicine network design; medical ecology*

Introduzione: innovazione, tecnologia, e contesto sociale nella prospettiva degli Science and Technology Studies

La riflessione sul carattere socialmente mediato degli artefatti tecnologici è un tema classico degli Science and Technology Studies (Mol e Law, 1994; Grint e Woolgar, 1997; MacKenzie e Wajcman, 1999; Latour, 2000). Gli studi prodotti dagli autori che si inscrivono in questo filone hanno avuto un ruolo fondamentale nella costruzione di una reazione alla visione

* Corresponding author: **Carlo Botrugno** | e-mail: carlo.botrugno@unibo.it

deterministico-meccanicista in base alla quale l'innovazione è intesa come un fattore (x) che produce un determinato impatto sulla società e/o sulle interazioni sociali (y), e dal quale derivano a sua volta, alcuni effetti identificabili (z), obbedendo così ad un modello di successione lineare del tipo: $x + y = z$.

Nel contesto specifico dei modelli di cura 'in remoto' – dalla *telecare* alla *telehealth*, passando per la *telemedicine* e l'*eHealth*, sino a giungere alla più recente *mHealth* – alcuni autori, rivitalizzando una prospettiva costruzionistica (Berger e Luckmann, 1967) hanno contribuito alla formazione di un apparato teorico-concettuale utile alla comprensione delle diverse fasi nelle quali si articolano i processi sociali impliciti nella formazione del design e nella costituzione delle tecnologie dei dispositivi medici (Whitten, 2000; May e Ellis, 2001; Finch et al., 2003).

Problematizzare il rapporto tra la tecnologia dei dispositivi medici e le pratiche degli operatori sanitari attraverso la lente della *technology-in-use* (Suchman et al., 1999) ha permesso inoltre di portare alla luce l'incidenza di queste ultime sul funzionamento concreto degli artefatti, e le correlate difficoltà nell'utilizzo di queste innovazioni nella *routine* di un *setting* ospedaliero.

Questo campo di riflessioni ha progressivamente messo in crisi la 'retorica trionfalistica' della telemedicina (May et al., 2001; Zuiderent et al., 2003), la quale, attraverso la legittimazione della letteratura scientifica di stampo medico (Curry et al., 2011) è entrata ufficialmente nell'agenda politico-istituzionale di Stati nazionali e organizzazioni regionali (EU Digital Agenda, 2013).

Dall'interno dello stesso filone degli STS, tuttavia, alcuni (Klein e Kleinman, 2002) hanno sollevato una critica – o meglio un'autocritica – finalizzata a richiamare l'eccessiva predilezione degli studiosi per le problematiche microinterazionistiche – il rapporto fra il medico ed il paziente; la relazione tra pratiche routinarie e innovazione; l'interazione uomo-macchina; ecc. – relegando talvolta in secondo piano l'analisi dei fattori di natura macro – culturali, sociali, politici, ed economici – che entrano in gioco nella definizione di una strategia pubblica per l'implementazione tecnologica, o che, per converso, ne impediscono la sua formazione (di diverso respiro tuttavia Mort et al., 2004).

In questo contesto, un'occasione favorevole per conciliare la prospettiva degli STS con uno sguardo di ampia portata nell'indagine sulle forme di dislocazione territoriale dei processi di cura, è rappresentata dalla rete di telemedicina e teleassistenza brasiliana, la *Telessaúde Brasil Redes*. In

L'interpenetrazione tra valori e design nell'ideazione, implementazione e funzionamento della rete di Telessaúde brasiliana

contrasto con il panorama nazionale ed europeo, laddove lo sviluppo della telemedicina appare frammentario e disomogeneo, le caratteristiche del sistema di Telessaúde, ed in particolare, la stretta correlazione che sussiste tra il design della *Redes* e le finalità assunte dal *Sistema Único de Saúde* (SUS), offrono elementi utili ad una lettura teorico-concettuale della struttura complessiva del servizio implementato, e ciò, nonostante manchi ancora una 'sedimentazione' del servizio in senso diacronico.

L'indagine sulla *Telessaúde* brasiliana può pertanto costituire un'occasione propizia per ricollegare la prospettiva degli STS allo studio delle strutture sociali, politiche ed economiche che sottostanno all'adozione dei dispositivi medici, così rinnovando un piano d'indagine attraverso il quale continuare a problematizzare le modalità con cui la tecnologia ridefinisce e modella il significato sociale della medicina (Faulkner, 2009; Conrad, 2005).

Il Sistema Unico de Saúde: dalla decentralizzazione all'umanizzazione dell'Atenção Básica

Il Brasile è una Repubblica Federale che si estende su una superficie di 8,5 milioni di km², e con una popolazione di 190.732.694 persone, che lo rende il quinto paese più popolato al mondo (IBGE, 2010). L'attuale organizzazione amministrativa del paese si fonda su tre livelli distinti e gerarchicamente ordinati: al livello federale si ricollega l'azione del Distretto Federale e dei 26 Stati nazionali, da cui dipende infine l'attività delle 5563 *municipalidades*.

La storia recente del Brasile si caratterizza per il passaggio dal regime dittatoriale alle istituzioni democratiche sull'onda di un movimento di rinnovamento che traeva ispirazione dalle coeve riforme per la concessione dei diritti sociali nei paesi industrializzati (Luz, 1991; Ferraz et al., 2012).

L'ampia legittimazione popolare e l'intensa condivisione da parte di intellettuali ed esperti ha fatto sì che, con riferimento al settore della sanità pubblica, il movimento sviluppasse sin dagli esordi una prospettiva teorica volta al superamento della razionalità biomedica quale chiave di lettura esclusiva del rapporto tra salute e malattia. La salute pertanto giungeva ad essere concepita come un patrimonio tutelabile non già solo attraverso la predisposizione di servizi sanitari o l'erogazione di prestazioni mediche, quanto, piuttosto, attraverso la definizione di un'azione di carattere globale in grado di incidere anche sui presupposti esterni all'organizzazione del sistema sanitario, e quindi alla stregua di una questione politica e sociale.

Le connotazioni etico-politiche del movimento per la riforma sanitaria troveranno una compiuta attuazione all'interno del *Sistema Único de Saúde* – i cui tratti essenziali sono tracciati dalla Costituzione del 1988, e poi specificati con la successiva implementazione (*Lei* n. 8.080/1990 e ss.) – e si rifletteranno, nella previsione di processi di partecipazione alla definizione delle politiche pubbliche di tutela della salute (*Constituição*, 1988, art. 198).

Nel contesto del *SUS*, infatti, la tutela della salute rappresenta un dovere dello Stato oltre che un diritto del cittadino, ragione per la quale essa deve essere garantita attraverso 'politiche sociali ed economiche che assumano l'obiettivo di ridurre il rischio di infermità e di altre lesioni, e di favorire l'accesso universale e egualitario alle politiche ed ai servizi per la sua promozione, protezione, e recupero' (*Constituição*, 1988, art. 196).

Tra i principi fondativi del *SUS* vi è il concetto di *integralidade*, in virtù del quale la risposta al bisogno di salute della popolazione si struttura come un 'complesso articolato e continuo di azioni e servizi preventivi e curativi, individuali e collettivi, da far valere per ogni caso in tutti i livelli di complessità del sistema' (*Constituição*, 1988, art. 198; *Lei* n. 8.080/90, art. 2).

La presa in carico 'integrale' della salute della popolazione appare strettamente correlata all'adozione di un orientamento ispirato al principio di decentralizzazione delle attività di tutela (*Constituição* 1988, art. 198) attraverso il quale si è sancita la rottura con l'assetto in vigore durante il regime dittatoriale, nel corso del quale l'organizzazione di tali attività venne attratta dal livello federale, in obbedienza ad un modello di gestione centralizzato e di carattere discendente.

L'istituzione di una stretta prossimità tra le attività di gestione della salute e la popolazione locale, in un paese caratterizzato da ampie difformità territoriali e demografiche, nonché da profonde differenze culturali, sociali, ed economiche – e pertanto anche da grandi divergenze nel rapporto tra salute e malattia – ha elevato il territorio, e nello specifico, la *municipalidad*, al ruolo di attore principale nell'organizzazione ed erogazione delle attività di tutela della salute, attribuendo una rinnovata valenza alla persona concreta (cittadino e paziente) distaccandosi dalla visione dell'utente-soggetto astratto.

Il principio di decentralizzazione ha trovato attuazione attraverso la realizzazione di un modello di cure primarie (*Atenção Básica em Saúde*) che ha assunto le vesti del *Programa Saúde da Família* (PSF), il quale ha assunto un'importanza notevole nell'azione del *SUS*, già a partire dalla sua creazione nel 1994 (Iwaya et al., 2013: 285). Il PSF ha previsto che le attività di *atenção básica* fossero realizzate per mezzo del lavoro delle *Equipes de Saúde*,

L'interpenetrazione tra valori e design nell'ideazione, implementazione e funzionamento della rete di Telessaúde brasiliana

ovvero di gruppi di professionisti insediati localmente con il compito di 'prendere in carico' la salute di un determinato numero di famiglie residenti sul territorio della *municipalidad*.

Ogni equipe è formata da un medico, un infermiere, un aiuto-infermiere, e un determinato numero di persone (da 4 a 6) prive di formazione medica, ma con una formazione di base in materia di igiene, nutrizione, gestione della gravidanza, epidemiologia, e malattie infettive. Queste ultime assumono il ruolo di 'Agenti Comunitari di Salute', e la loro funzione è di porre in essere un'opera di ricognizione e di conoscenza diretta delle condizioni di salute e di malattia della popolazione locale, rilevando e segnalando problematicità, consigliando azioni preventive, e monitorando gli sviluppi attraverso l'effettuazione di visite domiciliari periodiche.

Per comprendere appieno la struttura e gli obiettivi perseguiti dal SUS, è necessario tuttavia fare riferimento ad alcune strategie specifiche, tra le quali emergono per la loro rilevanza ai fini della presente riflessione, la *Política Nacional de Educação Permanente em Saúde* (PNEPS, 2003) e la *Política Nacional de Humanização* (PNH, 2004). Attraverso queste politiche di carattere trasversale, si è inteso fornire le premesse teoriche per lo sviluppo di azioni di re-orientamento delle pratiche di tutela della salute e della formazione nell'area sanitaria (Ferraz et al., 2012).

A livello concettuale l'*Educação Permanente* deve essere distinta dall'*Educação Continuada*, la quale ultima si realizza attraverso attività di formazione finalizzate a conseguire un aggiornamento delle competenze dei professionisti che operano nell'area sanitaria. Il concetto di *Educação Permanente* è stato invece adottato per favorire l'incontro tra la formazione, la gestione, la partecipazione sociale, e la tutela della salute, intese quali aree specifiche di saperi e pratiche che, prendendo avvio da riferimenti costruttivisti di 'istruzione-apprendimento' (*ensino-aprendizagem*) si muovono sul terreno comune della promozione della salute della popolazione (Ferraz et al., 2012).

L'*Educação Permanente* si sviluppa infatti attorno al principio fondamentale dell'apprendimento significativo, in base al quale il lavoro di *Atenção em Saúde* è inteso come composto di elementi che 'fanno senso' per i professionisti che operano all'interno del sistema. Attribuendo a questi ultimi una posizione attiva nella riflessione critica sulle pratiche professionali, la *Política de Educação Permanente* aspira a promuovere percorsi di cambiamento (*mudança*) nell'organizzazione dei processi da cui scaturisce la risposta del sistema sanitario (*Ministério da Saúde*, 2004a).

In stretta correlazione con la riflessione critica sulle pratiche quotidiane dei professionisti della salute, la *Política Nacional de Humanização* muove dal convincimento in base al quale la partecipazione (*inclusão*) delle persone e dei gruppi (reti e soggetti collettivi) che compongono fattivamente il SUS, e che contribuiscono con il proprio lavoro a delineare i contorni del sistema, rappresentano un fattore in grado di mettere in crisi i modelli consolidati di attenzione e gestione legati alla predominanza del paradigma biomedico, favorendo inoltre l'acquisizione di consapevolezza da parte degli stessi soggetti coinvolti. La politica di *Humanização* si prefigge di incrementare il grado di corresponsabilità dei diversi attori interferendo nei processi di 'produzione della salute', e proponendo forme di agire alternative all'interno della rete del SUS. In base a questa strategia, gli obiettivi di cambiamento (*mudança*) nella cultura della tutela offerta ai pazienti e nella gestione dei processi professionali possono essere conseguiti prendendo come riferimento il diritto dei pazienti, e, pertanto, riconoscendo loro la possibilità di assumere un ruolo attivo nel sistema di controllo sociale e di produzione della salute (*Ministério da Saúde*, 2004b).

La Telessaúde Brasil: un sistema tecnologico 'socialmente implicato'

Se l'implementazione del modello di *Atenção Básica* è riuscito a conseguire un miglioramento delle condizioni di salute generali della popolazione brasiliana malgrado le difficoltà di copertura territoriale (Machado et al., 2010, p. 248), è invece l'accesso al livello secondario a costituire una delle maggiori criticità dell'attuale organizzazione del SUS (Paim et al., 2011). L'offerta ridotta correlata al numero esiguo di centri sparsi sul territorio spesso impedisce di soddisfare in maniera tempestiva ed appropriata il bisogno di prestazioni specialistiche della popolazione (Piola et al., 2009; Solla e Chioro, 2008).

L'emersione della rete di *Telessaúde*, pertanto, appare sin dal principio finalisticamente orientata, poiché strettamente correlata alla necessità di colmare la distanza fisica che separa le *Equipes de Saúde* dall'offerta di cure specialistiche. Il sistema di *Telessaúde* si sviluppa inizialmente dalla *Rede Universitária de Telemedicina* (Silva, 2012) dalla quale è reso autonomo nel 2007 attraverso un progetto sperimentale (*Portaria* n. 35/2007) che coinvolge 9 Stati federali (*Amazonas, Ceará, Goiás, Minas Gerais, Pernambuco, Rio de Janeiro, Rio Grande do Sul, Santa Catarina, São Paulo*), e si consolida definitivamente nel 2011, quando assume le vesti dell'attuale *Programa Nacional Telessaúde Redes* (*Portaria* n. 2546/2011).

L'interpenetrazione tra valori e design nell'ideazione, implementazione e funzionamento della rete di Telessaúde brasiliana

La *Redes* è composta da una piattaforma di ICT che, per mezzo di postazioni *spokes* denominate *Pontos de Telessaúde*, collega le *Equipes de Saúde* dislocate sul territorio agli *hubs*, i *Núcleos de Telessaúde* che si trovano all'interno dei centri ospedalieri universitari.

L'obiettivo primario della *Redes* è di contribuire alla qualificazione professionale e al supporto ai procedimenti assistenziali dell'*Atenção Básica* attraverso le attività di *Teleconsultoria*, *Telediagnóstico*, *Segunda Opinião Formativa*, e *Teleducação* (Ferraz et al., 2012; Rezende et al., 2010).

Tali attività possono realizzarsi sia nelle forme sincrone (webchat o collegamento audio/video), sia *off-line*, attraverso l'invio di messaggi dal *Ponto* al *Núcleo* (con tempo di risposta entro 72 ore). Le richieste che pervengono al *Núcleo* sono gestite da un medico con esperienza specifica nell'ambito dell'*atenção básica*, che assume il compito fare da regolatore (*Teleregulador*), mediandole ed indirizzandole alla figura competente nell'organigramma interno.

Il *Núcleo de Telessaúde* realizza inoltre azioni di supporto tecnico, monitoraggio e valutazione dei processi di organizzazione del lavoro, confronto e discussione rispetto all'attuazione delle politiche e dei programmi nazionali di salute, raccolta ed analisi dei dati (*Manual Telessaúde*, 2012).

Quello che caratterizza in maniera singolare il sistema di *Telessaúde* brasiliano, tuttavia, è il divieto di incontri virtuali tra medico e paziente. Già a partire dal 1988 (Risoluzione n. 1/246 del 1988) il *Código de Ética Médica* vietava al medico di 'prescrivere un trattamento o di iniziare un percorso senza l'esame diretto del paziente, salvo in casi di urgenza e impossibilità comprovata, con l'obbligo tuttavia, in questo caso, di effettuarlo non appena cessato l'impedimento' (Art. 62). Il *Código* vieta inoltre al medico di 'effettuare consulto, diagnosi, o prescrizione medica per mezzo di qualsiasi mezzo di comunicazione di massa' (Art. 134). Il *Conselho Federal de Medicina* ha rafforzato ulteriormente tale proibizione (Risoluzione n. 1/718 del 2004), vietando 'al medico di istruire in forma privata personale non medico, attraverso qualsiasi forma di trasmissione di conoscenza' (Art. 1).

Se l'obiettivo primario della *Redes*, infatti, consiste nel risolvere il dubbio clinico che ha dato origine alla richiesta del medico dell'*equipe*, quello mediato tuttavia è di favorire la costruzione di una conoscenza pratica per la risoluzione dei casi più difficili, motivo per cui ogni *teleconsultoria* diviene strumento di accrescimento di un sapere medico condiviso in rete e disponibile ai professionisti del *Ponto*.

Se è vero che lo sviluppo di un sistema non consiste nella creazione di un oggetto discreto e intrinsecamente dotato di significato, quanto piuttosto nella produzione culturale di nuove pratiche (Suchman et al., 1999), così che la tecnologia risulta sempre mediata dalle pratiche sociali che la fanno apparire come una ‘tecnologia-in-uso’, il caso della *Telessaúde* viene tuttavia in rilievo non solo in quanto sistema tecnologico socialmente mediato – e che, in quanto tale, si avvale di una tecnologia *low-cost* e *low-profile* – ma, inoltre, come sistema tecnologico ‘socialmente implicato’, poiché strumento attivo di una ‘ideologia’ dai caratteri pragmatici che colloca i servizi offerti dalla *Redes* in un’ottica di riequilibrio delle diseguglianze in salute che storicamente affliggono il paese, e quindi verso il superamento delle barriere geografiche, culturali, ed economiche che sovente impediscono la piena accessibilità ai servizi socio-sanitari da parte dei cittadini (Novaes et al., 2012).

Il design, l’implementazione, ed il funzionamento della *Redes* assumono pertanto una marcata connotazione etico-politica, in quanto finalizzati al perseguimento di finalità di ‘giustizia sociale’, ed alla rivendicazione della *Saúde* quale diritto fondamentale di ogni cittadino.

L’interpenetrazione tra contesto valoriale e struttura del servizio emerge ancora più chiaramente laddove si ponga in comparazione la *Telessaúde* con le esperienze maturate a cavallo tra gli Stati Uniti e l’Europa, laddove i sistemi di telemedicina hanno assunto prevalentemente le forme di reti tecnologiche di natura ‘prestazionale’, all’interno delle quali l’interazione principale si svolge tra un ‘paziente fruitore’ ed un ‘professionista prestatore d’opera’. La *Telessaúde Redes* si caratterizza invece come un sistema di produzione-condivisione e scambio di conoscenza, nel quale l’interazione principale (ed esclusiva) è quella che viene ad instaurarsi tra il ‘territorio-comunità’ ed un ‘sapere medico’. Ne consegue che quell’apprendimento di tipo clinico da parte del personale paramedico che partecipa alle attività di teleconsulto segnalato dalla dottrina (Field, 1996), se in un caso deve considerarsi come un ‘effetto secondario’ – con tutte le criticità che ne derivano – nell’altro diviene un obiettivo dichiarato del servizio di rete, e pertanto calibrato rispetto alle esigenze del territorio ed alle possibilità d’azione dell’*equipe de saúde locale*.

La dialettica istruzione-apprendimento, centrale nella visione orizzontale adottata dal *SUS*, se da una parte dischiude ulteriori scenari di ricerca volti ad indagare le modalità attraverso le quali i professionisti delle *equipes de saúde* gestiscono in concreto l’incontro tra differenti modelli di tutela (cure primarie VS livello specialistico), dall’altra testimonia una prima efficace

problematizzazione dei caratteri della conoscenza medica, e, in particolare, il riconoscimento del carattere collettivo dei processi attraverso i quali prendono forma la diagnosi e la terapia (Cicourel, 1990; Atkinson, 1995; Rajani e Perry, 1999).

Conclusioni: una prospettiva antropotecnologica per l'indagine sulla Telessaúde

In continuità con quello che è stato il carattere ispiratore del movimento di riforma sanitaria in Brasile, il processo di rinnovamento della formazione medica ha posto la tutela della salute della popolazione alla stregua di un compromesso etico-politico, per il cui perseguimento, i principi fondativi del *SUS* hanno costituito un punto di riferimento ineludibile sin dalla sua istituzione (Feuerwerker, 2007).

Le connotazioni ideologiche del *SUS* permeano la *Telessaúde Redes* riservandone le attività in via esclusiva al potenziamento del livello di *atenção básica em saúde*, il quale ultimo riveste una duplice declinazione funzionale poiché, se per un verso rappresenta il principale punto di ingresso del paziente all'interno del sistema sanitario pubblico, dall'altro costituisce il principale asse delle attività di tutela offerte alla popolazione.

La *Telessaúde* si caratterizza come un complesso di persone, dispositivi e pratiche per la tutela della salute in cui l'utente finale non è il paziente, ma il medico. Proibendo qualsiasi forma di incontro virtuale tra medico e paziente, il *SUS* ha optato per la 'non trasmissibilità' di un sapere di carattere relazionale, quale quello medico, attraverso dispositivi di *ICT*, eliminando in radice il dibattito legato al carattere riduzionistico di alcune applicazioni di telemedicina. Questa particolare conformazione del sistema di *Telessaúde* deve essere intesa, da una parte, in virtù della sua derivazione dalla preesistente rete di telemedicina intraospedaliera, e, dall'altra, con riferimento alla necessità di arginare il potere della corporazione dei medici privati, la cui grande influenza avrebbe potuto indurre il rischio di utilizzi strumentali della professione medica in un paese in cui le grandi distanze e l'estensione geografica rendono allettante il ricorso alle *ICT*.

La configurazione della *Redes* appare pertanto in grado di rovesciare la prospettiva prevalente nell'implementazione dei modelli di telemedicina – la c.d. 'retorica della telemedicina' (May et al., 2001; Zuiderent et al., 2003) – che promette di rivoluzionare le modalità di cura conducendo virtualmente il paziente sino al livello specialistico, e pertanto, garantendo

l'effettuazione di una più ampia quantità di prestazioni specialistiche. Se alcuni autori hanno 'recuperato' la fisicità dei luoghi posti in teleconnessione mettendo in luce come *places matter* (Oudshoorn, 2012), il caso della *Telessaúde* ci consente di declinare il rapporto tra spazialità e contesto in termini radicalmente differenti rispetto ai più consolidati modelli di cura a distanza. La dislocazione territoriale del sistema, infatti, lungi dall'adempiere ad obiettivi di mera copertura geografica, deve essere intesa piuttosto come un'incorporazione da parte dell'*equipe de saúde* locale, rispetto alla cui attività la *Redes* diviene strumento di *empowerment*.

Il collegamento tra *Ponto* e *Núcleo*, primariamente orientato a risolvere il dubbio clinico che proviene dal professionista locale, nel medio/lungo termine, si prefigge la formazione di un sapere condiviso rispetto ai casi di difficile interpretazione, un sapere la cui gestione spetta in via esclusiva ai professionisti dell'*equipe de saúde* sui quali grava il compito di adattarlo in funzione delle caratteristiche del territorio e delle condizioni di salute-malattia della popolazione.

L'interpenetrazione tra i valori fondativi del SUS ed il design della *Redes* contribuisce pertanto a delineare i contorni di quella che può essere definita come una *prospettiva antropotecnologica*, per mezzo della quale la *Telessaúde* viene a caratterizzarsi come un sistema in cui l'artefatto tecnologico resta sullo sfondo – *dietro le quinte* – dell'ecologia medica locale, in questo caso particolarmente strutturata anche in virtù dell'opera di conoscenza e ricognizione di natura personale condotta quotidianamente dai professionisti delle *equipes de saúde*. Il caso della *Telessaúde* brasiliana si pone pertanto quale soluzione di continuità rispetto alla visione di una medicina che tende a svincolarsi progressivamente dal paradigma igienico-sociale della sanità pubblica, per caratterizzarsi sempre più come una *tecnomedicina* (Pickstone, 2000) impegnata nella ricerca di un *miracolo tecnologico* (Knight, 1986; Blume, 1997).

In contrasto con la visione della telemedicina quale mera trasmissione di dati sanitari ritenuti di per sé esaustivi di significato clinico, l'attività della *Telessaúde Redes* non interferisce nel processo di co-costruzione della realtà patologica (Richards et al., 2013) rispettando il senso intrinseco delle relazioni sociali proprio del contesto, e pertanto appare in grado di realizzare un intervento che può essere considerato efficace (Webster, 2002).

Bibliografia

- Atkinson, P. (1995) *Medical talk and medical work*. Sage: London.
- Berger, P.L. e Luckmann, T. (1967) *The Social Construction of Reality*. London: Penguin Books.
- Bijker, W.E., Hughes, T.P. e Pinch, T.J. (1987) *The social construction of technological systems: new directions in the sociology and history of technology*. Cambridge: MIT Press.
- Blume, S. (1997) The Rhetoric and Counter Rhetoric of a 'Bionic' Technology. *Science, Technology and Human Values*, 22 (1), 31–56.
- Braga, J.C. e Paula, S.G. (1981) *Saúde e previdência: estudos de política social*. São Paulo: Cebes/Hucitec.
- Cicourel, A.V. (1990) The Integration of Distributed Knowledge in Collaborative Medical Diagnosis. In Galegher J., Kraut, R.E. e Egido C. (eds.) *Intellectual Teamwork. Social and Technological Foundations of Co-operative Work*. New Jersey: Lawrence Erlbaum Associates.
- Conrad, P. (2005) The shifting engines of medicalization. *Journal of Health and Social Behaviour*, 46 (1), 3-14.
- Curry, R., Lethbridge, K. e Plant, L. (2011) Telemedicina nel Regno Unito. *E-Health care : innovazione e tecnologie in sanità*, 13 (3), 70-74.
- Faulkner, A. (2009) *Medical Technology into healthcare and society. A sociology of devices, innovation, and governance*. Hampshire: Palgrave McMillan.
- Ferraz, F., Vendruscolo, C., Kleba, M.E., do Prado, M.L. e Reibnitz, K.S. (2012) Ações estruturantes interministeriais para reorientação da Atenção Básica em Saúde: convergência entre educação e humanização. *O Mundo da Saúde*, 36 (3), 482-493.
- Feuerwerker, L. (2007) Educação na saúde – Educação dos profissionais de saúde – Um campo de saber e de práticas sociais em construção. *Revista Brasileira de Educação Médica*, 31 (1), 3-4.
- Field, M.J. (1996) *Telemedicine: a guide to assessing telecommunications in health care*. Washington DC: National Academies Press.
- Finch, T., May, C., Mair, F., Mort, M. e Gask, L. (2003) Integrating service development with evaluation in telehealthcare: an ethnographic study. *British Medical Journal*, 327 (7425), 1205-1209.
- Grint, K. e Woolgar, S. (1997) *The Machine at Work: Technology, Work and Organization*. Cambridge: Polity Press.
- Instituto Brasileiro de Geografia e Estatística. *Séries estatísticas & séries históricas*. [Online] Consultabile su

- http://www.ibge.gov.br/series_estatisticas/ . [Ultimo Acesso: 07/05/2014].
- Latour, B. (2000) *Pandora's Hope: Essays on the Reality of Science Studies*. Cambridge: Harvard University Press.
- Luz, M.T. (1991) Notas sobre as políticas de saúde no Brasil de 'transição democrática' - anos 80. *Physis: Revista de Saúde Coletiva*, 1 (1), 77-96.
- Klein, H.K. e Kleinman, D.L. (2002) The Social Construction of Technology: Structural Considerations. *Science, Technology, & Human Values*, 27 (1), 28-52.
- Knight, N. (1986) The New Light: X-rays and Medical Futurism. In Corn, J.J. (eds.) *Imagining Tomorrow*. Cambridge: MIT Press.
- MacKenzie, D. e Wajcman, J. (1999) *The Social Shaping of Technology*. Buckingham and Philadelphia: Open University Press.
- Machado, F.S.N., Pinto de Carvalho, M.A., Mataresi, A., Mendonça, A.T., Cardoso, L.M., Yogi, M.S., Rigato, H.M. e Salazar, M. (2010) Utilização da telemedicina como estratégia de promoção de saúde em comunidades ribeirinhas da Amazônia: experiência de trabalho interdisciplinar, integrando as diretrizes do SUS. *Ciência & Saúde Coletiva*, 15 (1), 247-254.
- May, C. e Ellis., N.T. (2001) When protocols fail: technical evaluation, biomedical knowledge and the social production of facts about a telemedicine clinic. *Social Science and Medicine*, 53 (8), 989-1002.
- May, C., Gask, L., Atkinson, T., Ellis, N., Mair, F. e Esmail, A. (2001) Resisting and promoting new technologies in clinical practice: The case of telepsychiatry. *Social Science and Medicine*, 52 (12), 1889-1819.
- Ministério da Saúde (2012) *Manual de Telessaúde para Atenção Básica / Atenção Primária à Saúde*. Brasília. [Online] Consultabile su telessaude.bvs.br/tiki-download_file.php?fileId=2450 [Ultimo Acesso: 7 Maggio 2014].
- Ministério da Saúde (2004a) *HumanizaSUS - A Humanização como Eixo Norteador das Práticas de Atenção e Gestão em Todas as Instâncias do SUS*. Brasília. [Online] Consultabile su http://bvsmms.saude.gov.br/bvs/publicacoes/humanizasus_2004.pdf [Ultimo Acesso: 7 Maggio 2014].
- Ministério da Saúde (2004b) *Pólos de Educação Permanente em Saúde: Política de Educação e Desenvolvimento para o SUS*. Brasília. [Online] Consultabile su http://bvsmms.saude.gov.br/bvs/publicacoes/politica2_vp.pdf [Ultimo Acesso: 7 Maggio 2014].

L'interpenetrazione tra valori e design nell'ideazione, implementazione e funzionamento della rete di Telessaúde brasiliana

- Mol, A. e Law, J. (1994) Regions, Networks and Fluids: Anaemia and Social Topology. *Social Studies of Science*, 24 (4), 641-671.
- Mort, M., May, C., Finch, T. e Mair, F. (2004) Telemedicine and clinical governance: controlling technology - containing knowledge. In Gray, A. e Harrison, S. (eds.) *Governing Medicine: Theory and Practice*. Maidenhead: Open University Press.
- Novaes, M., Machiavelli, J.L., Verde, F.C.V., Amadeus, S.C. e Rodrigues, T.R.C. (2012) Tele-educação para educação continuada das equipes de saúde da família em saúde mental: a experiência de Pernambuco, Brasil. *Interface*, 16 (43), 1095-1106.
- Oudshoorn, N. (2012) How places matter: Telecare technologies and the changing spatial dimensions of healthcare. *Social studies of Science*, 42 (1), 121-142.
- Paim, J., Travassos, C., Almeida, C., Bahia, L. e Macinko, J. (2011) The Brazilian health system: history, advances, and challenges. *The Lancet*, 377 (9779), 1778-1797.
- Pego, R.A. e Almeida, C.M. (2002) Teoría y práctica de las reformas de los sistemas de salud: los casos de Brasil y Mexico. *Cadernos de Saúde Pública*, 18 (4), 971-989.
- Pickstone, J. (2000) *Ways of Knowing: A New Science of Technology, Technology and Medicine*. Manchester: Manchester University Press.
- Piola, S.F., Vianna, S.M., Marinho, A., Carvalho, D., Ribeiro, J.A. e da Silva, J.R., (2009) *Saúde no Brasil: algumas questões sobre o Sistema Único de Saúde*. Brasília-DF: Cepal. [Online] Consultabile su <http://www.cepal.org/brasil/publicaciones/sinsigla/xml/4/35734/LCBRSR200SaudenoBrasil.pdf> [Ultimo Accesso: 7 Maggio 2014].
- Rezende, E.J.C., Melo, M.C.B., Tavares, E.C., Santos, A.F., e Souza, C. (2010) Ética e telessaúde: reflexões para uma prática segura. *Revista Panamericana de Salud Publica*, 28 (1), 58-65.
- Richards, T., Montori, M.V., Godlee, F., Lapsley, P. e Paul, D. (2013) Let the patient revolution begin. Patients can improve healthcare: it's time to take partnership seriously. [online]. *British Medical Journal*. Consultabile su www.bmj.com/content/346/bmj.f2614.full.pdf+html [Ultimo Accesso: 7 Maggio 2014].
- Silva, A.B. e Moraes, I.H.S. (2012) O caso da Rede Universitária de Telemedicina: análise da entrada da telessaúde na agenda política brasileira. *Physis: Revista de Saúde Coletiva*, 22 (3), 1211-1235.

- Singer, P. e Campos, O. (1978) *Prevenir e curar: o controle social através dos serviços de saúde*. Rio de Janeiro: Forense-Universitária.
- Solla, J. e Chioro, A. (2008) *Atenção ambulatorial especializada*. In Giovanella, L., Escorel, S., Costa Lobato, L., Carvalho de Noronha, J. e de Carvalho, I. (eds.), *Políticas e sistema de saúde no Brasil*. Rio de Janeiro: Fiocruz. [Online] Consultabile su <http://www.cfh.ufsc.br/~nipp/materiais/politicasesistemasdesaude.pdf> [Ultimo Accesso: 7 Maggio 2014].
- Suchman, L., Blomberg, J., Orr, J. e Trigg, R. (1999) Reconstructing technologies as social practice. *American Behavioural Scientist*, 43 (3), 392-408.
- Webster, A. (2002) Innovative Health Technologies and the Social: redefining health, medicine and the body. *Current Sociology*, 50 (3), 443-457.
- Whitten, P., Sypher, B.D. e Patterson, J.D., (2000) Transcending the Technology of Telemedicine: An Analysis of Telemedicine in North Carolina. *Health Communication*, 12 (2), 109-135.
- Zuiderent, T., Berg., M. e Winthereik, B.R., (2003) Talking about distributed communication and medicine: on bringing together remote and local actors. *Human-Computer Interaction*, 18 (1), 171-81.

Una tutela ‘by design’ del diritto alla salute. Prospettive di armonizzazione giuridica e tecnologica

Raffaella BRIGHI and Maria Gabriella VIRONE*
University of Bologna

Scopo principale del presente lavoro è quello di evidenziare la complementarità del diritto e delle nuove tecnologie nella promozione e protezione del diritto alla salute, riconosciuto e garantito a livello internazionale, comunitario e nazionale come diritto fondamentale di ogni persona, superando i possibili ostacoli di natura culturale, giuridica e tecnologica a tutt’oggi esistenti. In particolare, lo studio esamina il ruolo del dato sanitario nei nuovi scenari di cura, sempre più caratterizzati dalla telemedicina, con riferimento ai temi della protezione dei dati personali, dell’interoperabilità dei sistemi informativi e delle security policy. Alla base delle riflessioni proposte è la funzione centrale che il paziente assume nei processi socio-assistenziali, in quanto principale attore e fruitore dei servizi sanitari erogati. In questo contesto, è essenziale che i sistemi sanitari nazionali mantengano una visione olistica, per fornire al paziente cure efficienti ed efficaci, ma anche per favorire all’utente un accesso alle prestazioni, sia in modalità analogica sia in modalità digitale, più semplice e diretto.

Keywords: *E-health; health data; privacy by design; data protection; patient rights*

Il paziente al centro della sanità digitale: ostacoli e tendenze attuali

Nel corso dell’ultimo quindicennio, la creazione di società inclusive, caratterizzate da buona salute ed alti livelli di servizi erogati, è un tema rilevante sia nelle politiche della Commissione europea sia nelle strategie dei Governi nazionali.

*Corresponding author: **Maria Gabriella Virone** | e-mail: mariagabriella.virone@gmail.com

A tal fine, seguendo un approccio olistico in cui il paziente è posto al centro dei sistemi socio-assistenziali, le strategie in essere convergono verso un duplice scopo: migliorare l'efficacia delle cure del paziente ed agevolare un accesso semplice ed efficiente ai servizi sanitari.

Per il conseguimento di tali risultati, un ruolo determinante è stato riconosciuto alle Tecnologie dell'Informazione e della Comunicazione applicate al settore sanitario nella sua globalità, sia in riferimento agli strumenti diagnostici utilizzati per finalità di diagnosi e cura, sia in riferimento alla componente aziendale, comprensiva degli aspetti organizzativi, gestionali, amministrativi, di programmazione e controllo etc.

Un particolare estremamente interessante nel contesto di questo studio è rinvenibile nella Comunicazione 'Sanità elettronica - migliorare l'assistenza sanitaria dei cittadini europei: piano d'azione per uno spazio europeo della sanità elettronica', nota anche come 'e-Health Action Plan', in cui, riconosciute le potenzialità degli strumenti digitali applicati al dominio sanitario e sottolineati i loro concreti benefici sia per gli operatori sia per i pazienti, la Commissione europea evidenzia l'importanza di incentrare i sistemi sanitari sul cittadino. Dunque, il binomio ICT ed empowerment del paziente è determinante nella realizzazione di una sanità digitale.

In attuazione della strategia 'Europa 2020', l'Agenda digitale europea' ha recentemente fissato alcuni obiettivi, raggiungibili, tra l'altro, attraverso la diffusione e l'implementazione di servizi di telemedicina; tra questi rientrano garantire l'equità di accesso al servizio sanitario, promuovere una migliore qualità dell'assistenza nonché assicurare la continuità delle cure, anche in relazione al progressivo invecchiamento della popolazione ed alla prevalenza di malattie croniche.

Come sottolineato nel rapporto 'Redesigning health in Europe for 2020', concluso nel 2012 dall'eHealth Task Force, un utilizzo sistematico e ad ampio raggio delle Tecnologie dell'Informazione e della Comunicazione nel settore sanitario è di estrema rilevanza: le nuove tecnologie, infatti, contribuiscono al raggiungimento di un evidente processo di cambiamento, traducibile in risultati concreti, quali, ad esempio, un esercizio più efficace del diritto sull'accesso ai dati da parte dei pazienti, la pubblicazione di dati sanitari de-identificati da parte della Pubblica Amministrazione, una maggiore trasparenza dei sistemi sanitari e la riduzione delle disuguaglianze sociali.

Significativi ostacoli o comunque sfide, di tipo culturale, tecnologico e giuridico, per la protezione e promozione dello 'stato di completo benessere fisico, psichico e sociale' auspicato per tutti dall'Organizzazione Mondiale

alla Sanità fin dal 1946 sono, però, a tutt'oggi esistenti. A titolo esemplificativo si richiamano i fenomeni della mobilità internazionale, del multiculturalismo e del multilinguismo, così come la permanenza di un divario digitale generazionale, l'assenza di banda larga diffusa in modo uniforme sul territorio nazionale ed europeo, la presenza di regole tecniche spesso frammentate, l'esistenza di sistemi informativi frequentemente non interconnessi, la vigenza di una normativa internazionale, europea e nazionale eterogenea, la limitata cooperazione transfrontaliera tra le pubbliche amministrazioni.

Il ruolo del dato sanitario nei nuovi scenari di cura

Alla luce del quadro sinteticamente delineato, questo studio affronta il tema del design di infrastrutture sanitarie, esaminando il ruolo che il *dato sanitario*, digitalizzato e tradotto in sequenze di bit, assume per il paziente e per la collettività nei nuovi scenari di cura.

Le infrastrutture tecnologiche adottate per le cure domiciliari, i dispositivi di *Personal Health*, i sistemi di *e-Health* tradizionali localizzati in Aziende Sanitarie Locali e Aziende Ospedaliere operano su 'dati', creando, memorizzando e scambiando continuamente informazioni inerenti la salute dell'assistito.

Analogamente i sistemi progettati per la cura a distanza, siano essi reti di sensori, strumenti che aiutano il paziente nell'ottemperare correttamente le prescrizioni terapeutiche assegnate o dispositivi di tele-salute e reti sociali per il collegamento del paziente con specialisti e soggetti terzi, collezionano e trasmettono un elevato numero di dati. Alcuni operano in maniera più discreta, come nel caso degli strumenti *event-based* che svolgono un'azione al verificarsi di una specifica condizione, altri, invece, operano in modo più invasivo, registrando e trasmettendo durante l'uso flussi continui di informazioni.

La grande quantità di dati, anche personali e sensibili, che i suddetti strumenti generano, concorre a costruire una vera e propria 'identità elettronica dei pazienti', frutto della rappresentazione informatica degli elementi raccolti nel corso della storia clinica del singolo utente. Il ruolo che tale identità svolge è poliedrico: attraverso di essa, infatti, vengono erogati automaticamente servizi o predisposti protocolli clinici; inoltre, con tecniche di *Data Analytics*, i profili creati da applicazioni di diverso tipo e per motivi differenti, possono essere aggregati e combinati tra loro, per fornire, o

meglio 'ricostruire' informazioni nuove rispetto a quelle originariamente salvate nei sistemi informativi.

In quest'ottica, la funzione del dato sanitario è centrale: il *valore* che esso ha è, in realtà, strettamente collegato alla capacità di raccogliere, analizzare e interpretare la *conoscenza* che veicola.

Nell'ultimo decennio, in ambito scientifico-tecnologico, vari studi hanno definito modelli atti ad esprimere in modo formale la semantica dei dati, con l'obiettivo di produrre un'informazione il più possibile condivisibile, accessibile ed integrabile, a fronte del proliferare di piattaforme chiuse e frammentarie.

Molti progetti ed iniziative, nazionali ed europei, hanno promosso la creazione di infrastrutture interoperabili (come, ad esempio, il progetto epSOS - Smart Open Services for European Patients -, co-finanziato dell'Unione europea, che si concluderà il 31 giugno 2014) e l'uso di standard medici (quali HL7, DICOM, MLMS, GLIF etc.) allo scopo di garantire una migliore qualità ed efficacia delle cure in un contesto caratterizzato da una forte mobilità transfrontaliera.

È bene, però, evidenziare che gli interventi istituzionali intrapresi sul fronte dell'interoperabilità, almeno per ciò che concerne lo scenario italiano, sono spesso carenti sul fronte dell'implementazione o, comunque, di una efficacia operativa a livello locale. Tra le cause della suddetta inefficacia rientrano, certamente, la scarsa conoscenza e la poca fiducia negli strumenti di e-Health. In proposito un'azione strategica rilevante riguarda la necessità e l'opportunità di innescare un efficace percorso culturale e formativo per tutti i fruitori dei servizi socio-sanitari digitali o digitalizzati. Infatti, l'uso delle nuove tecnologie, estesesi anche al settore sanitario, richiede sia per gli operatori (personale sanitario e parasanitario, amministrativi, ricercatori etc.) sia per gli utenti un atteggiamento di fiducia nei confronti dell'ICT, fondato su un utilizzo corretto e consapevole dello strumento tecnologico adoperato nonché sui risultati che produrrà e sui limiti in esso intrinseci.

Nell'era di Internet è quanto mai urgente individuare strumenti ed azioni che, in modo complementare rispetto alle politiche ed alle legislazioni, facilitino la diffusione di un clima di fiducia tra i consumatori/pazienti, il cui pilastro principale è rappresentato dal *diritto alla protezione dei dati personali*. Se si pensa al contesto italiano, infatti, a poco servono le pianificazioni strategiche per la digitalizzazione della Pubblica Amministrazione, se, parimenti, non si pongono le condizioni culturali,

tecnologiche e giuridiche per un effettivo utilizzo dei sistemi informativi da parte degli utenti.

Nel considerare il ruolo che il dato sanitario ha nei nuovi scenari di cura è parimenti importante sottolineare che dalle nuove infrastrutture per l'assistenza domiciliare o cure a distanza proviene altresì un potenziale informativo sui comportamenti dei cittadini, utile per finalità secondarie di sanità pubblica, quali l'organizzazione più efficiente ed efficace di servizi, la razionalizzazione della spesa, la ricerca scientifica etc.

Per tale ragione alcuni, inserendosi nel più ampio fenomeno degli *Open Data*, auspicano l'apertura dei dati sanitari, apertura che non riguarderebbe esclusivamente le informazioni già a disposizione dei sistemi sanitari nazionali, come i dati gestionali, ma anche quelle raccolte in Electronic Health Record e Personal Health Record. Propedeutico all'apertura dei dati è, però, un solido intervento, tecnologico e normativo, atto ad assicurare l'esclusivo trattamento delle informazioni de-identificate e un'adeguata tutela delle informazioni personali e sensibili.

Quanto premesso giustifica l'affermazione secondo cui il dato sanitario è un elemento essenziale per la protezione e la promozione della salute; esso, infatti, è portatore di informazioni che possono rivelarsi decisive sia per i processi diagnostici e di cura del singolo sia per la salute della collettività. Al contempo, però, la sua gestione digitalizzata non deve costringere il cittadino a rinunciare alla propria sfera intima e alla propria riservatezza; un'eccessiva intrusione nella dimensione personale potrebbe portare il paziente al rifiuto delle tecnologie impiegate, con il conseguente fallimento del percorso di cura e del più ampio processo di digitalizzazione dell'erogazione dei servizi socio-assistenziali.

Da ciò deriva la necessità di progettare framework, giuridici e tecnologici, che tutelino i diritti fondamentali del cittadino/paziente, partendo, appunto, da una visione patient-centred.

Prospettive di armonizzazione giuridica e tecnologica per il trattamento dei dati sanitari

Le analisi giuridiche e tecniche, condotte sia a livello europeo sia a livello nazionale, evidenziano il bisogno urgente di definire modelli che favoriscano un impiego dei dati sanitari tale da garantire egualmente i diritti del paziente e gli interessi della collettività alla salute (ex art. 32, comma 1, della Costituzione italiana).

A tal fine, le direzioni strategiche individuate dal presente studio sono tre: (1) armonizzazione della normativa vigente, (2) armonizzazione delle regole tecniche e giuridiche, (3) armonizzazione del design degli strumenti informatici e tecnologici.

Una prima osservazione di carattere generale è, tuttavia, essenziale: al fine di conoscere e comprendere criticità e problematiche connesse al tema in esame, dovrebbe essere maggiormente seguito da parte di policy-maker e stakeholder un approccio di tipo multidisciplinare e interdisciplinare. Tale confronto, pertanto, non è opportuno che sia esclusivamente circoscritto ai documenti prodotti dai Tavoli tecnici istituiti ad hoc, è, in realtà, indispensabile che trovi puntuali modelli teorici e, soprattutto, applicativi.

Con precipuo riferimento alle discipline oggetto del presente studio, il diritto e l'informatica medica, ribadire questo aspetto è d'obbligo, e ciò, dal momento che nell'ambito sanitario le due branche hanno velocità differenti: la tecnologia, infatti, tarda talora a trovare una tempestiva ed efficiente traduzione legislativa. In taluni casi, inoltre, il recepimento di caratteristiche tecnologiche è puramente formale e di difficile applicazione per l'interprete. Questa complessità, registrabile a livello italiano, si amplia se si considera il panorama europeo, nel quale è ancora assente un'uniforme disciplina cogente sul tema della sanità elettronica.

La Privacy by Design come principio trainante della riflessione normativo-tecnologica

Sebbene i limiti e le critiche (Koops e Leenes, 2013; Moerel, 2014) che, peraltro, esulano dal presente studio, un interessante tentativo di armonizzazione giuridica e tecnologica che riguarda il trattamento dei dati, analogici e digitali e, dunque, anche sanitari, proviene dalla Commissione europea. Trattasi del processo di revisione della direttiva 95/46/CE sul trattamento dei dati personali e sulla libera circolazione di tali dati, avviato il 25 gennaio 2012 ed ancora in essere, con la presentazione della proposta di una 'General Data Protection Regulation' finalizzata ad uniformare le regole esistenti tra i 28 Paesi membri in materia di privacy in accordo, appunto, con i progressi tecnologici ed i nuovi metodi di collezione, accesso ed utilizzo dei dati.

In questa direzione, una grande attenzione è posta sull'adozione delle 'Privacy Enhancing Technology' (ovvero gli strumenti, non particolarmente invasivi della sfera privata, attraverso cui modellare sistemi informativi) e sull'implementazione dei principi della 'Privacy by Design' (PbD), il cui presupposto è che lo strumento informatico debba essere progettato in

modo tale da contenere gli abusi di dati personali e sensibili dei pazienti, attraverso opportune limitazioni d'uso e trattamento. L'adesione a questo approccio è una delle possibili soluzioni per l'armonizzazione del design degli strumenti informatici e tecnologici, particolarmente interessante se si considera che esso non ignora, anzi include l'utente e la tutela dei suoi diritti.

Secondo il framework delineato da Ann Cavoukian già negli anni Novanta (Cavoukian, 2009) e riconosciuto come 'global privacy standard' nel 2010 durante la '32nd International Conference of Data Protection and Privacy Commissioners', le regole sulla privacy devono diventare un'impostazione di default ed essere integrate nel design delle infrastrutture tecnologiche, affinché i dati dell'utente siano salvaguardati a priori dai sistemi stessi.

Sinteticamente i 7 principi fondazionali del suddetto approccio sono: 1) l'essere proattivo non reattivo: la PbD ha come scopo la prevenzione piuttosto che il rimedio; 2) la privacy come impostazione di default, ovvero come regola di base di un sistema IT; 3) la privacy incorporata nella progettazione, cioè integrata nell'architettura dei sistemi informativi; 4) il perseguimento della massima funzionalità, intesa come valore positivo, non valore zero, quindi vantaggioso per tutti; 5) la sicurezza fino alla fine e la piena protezione del ciclo di vita del dato; 6) la visibilità e la trasparenza, dal momento che componenti ed operazioni delle tecnologie e delle prassi utilizzate devono sempre essere verificabili; 7) il rispetto per la privacy dell'utente e la centralità dell'utente, potenziate seguendo un approccio user-centred (Cavoukian, 2010).

La minimizzazione nel trattamento (raccolta, utilizzo, divulgazione e conservazione) dei dati sensibili/identificativi dei pazienti, la separazione tra identificazione e contenuto dei dati personali, l'uso di pseudonimi e di tecniche di anonimizzazione nonché la cancellazione dei dati personali in tempi brevi sono modalità attraverso cui attuare veri e propri meccanismi di prevenzione, attraverso cui, peraltro, è possibile utilizzare le informazioni sanitarie non sensibili anche per finalità secondarie.

Rispondono al modello della Privacy by Design, rappresentandone una concreta espressione applicativa, i c.d. 'Smart Data', ovvero quegli agenti autonomi, basati su Internet, il cui fine è quello di proteggere in modo sicuro ed intelligente le informazioni digitali personali e sensibili, impedendone la divulgazione, in conformità con le istruzioni per l'uso ricevute (Cavoukian, 2013; Tromko, 2013). La funzione di questo strumento è, appunto, quello di difendere 'by default', e quindi, in via preventiva, i dati

sensibili, non divulgabili senza idonee forme di consenso ma comunque presenti in Rete.

Quanto illustrato, se ben compreso e attualizzato, riassume al paziente un ruolo centrale all'interno dei processi di cura; la tradizionale visione della relazione medico-paziente, vacillante, a dire dei critici più conservatori, con l'introduzione delle nuove tecnologie nel settore sanitario, può, infatti, non soltanto essere recuperata, bensì trovare una migliore interpretazione. Progettare sistemi informativi in un'ottica di 'Privacy by Design' significa, infatti, primariamente, permettere all'utente, principale beneficiario delle misure considerate, di essere centro dei flussi di dati, appunto grazie alla definizione di strumenti privacy-friendly.

In questo senso, l'implementazione della 'Privacy by default' e della 'Privacy by Design' si rivela come una strategia 'positive sum win-win' che può facilitare il design di nuove infrastrutture per la gestione della salute, consentendo di raggiungere un buon bilanciamento tra esigenze di cura individuale, tutela di diritti fondamentali del paziente e interessi di salute pubblica. A tal fine, è, altresì, auspicabile che gruppi di esperti riflettano sulle nuove fattispecie, nate dalla sempre più diffusa applicazione delle Tecnologie dell'Informazione e della Comunicazione anche al settore sanitario (tra le altre, si consideri, ad esempio, la possibilità di raccogliere e trattare i dati sanitari in infrastrutture e servizi di 'cloud computing' o nei dispositivi 'mobile'), per l'integrazione o revisione delle attuali norme in materia di protezione dei dati personali.

Interoperabilità dei sistemi informativi e condivisione di security policy: le nuove tecnologie a servizio dei pazienti

Risponde alle stesse finalità dell'armonizzazione della normativa e del design degli strumenti informatici e tecnologici, l'opportunità di armonizzare le regole tecniche e giuridiche esistenti, soluzioni concepite in questo studio come strategie di e-Health.

Le principali questioni aperte sottese alla tematica summenzionata riguardano l'*interoperabilità* dei sistemi informativi sanitari e la definizione di '*security policy*' condivise tra le istituzioni sanitarie coinvolte tanto a livello nazionale quanto a livello europeo.

Con riferimento al primo profilo, quello cioè dell'interoperabilità, possibile grazie all'adozione di standard condivisi, l'interesse e l'attenzione della Commissione europea così come dei 28 Paesi membri non sono nuovi, sebbene di fatto i livelli di interoperabilità raggiunti tanto sul fronte comunitario quanto sul fronte nazionale non siano ancora del tutto ottimali.

Da qui, tra gli altri, il monito della Commissione europea nel piano d'azione 'Sanità elettronica 2012-2020 – Una sanità innovativa per il 21esimo secolo' per la creazione di un quadro europeo interoperabile – dal punto di vista giuridico, organizzativo, semantico e tecnico – in materia di sanità elettronica.

Benefici dell'interoperabilità, e, quindi, del flusso di dati sensibili dei pazienti all'interno dell'Unione, sono, anzitutto, la rapida accessibilità delle informazioni clinico-sanitarie del paziente e il conseguente innalzamento della qualità e della sicurezza nelle cure. Ulteriori vantaggi dell'interoperabilità - organizzativa, semantica e tecnica - investono anche il personale sanitario, gli enti finanziatori, le agenzie assicurative, l'industria IT specializzata nel settore medico, il mercato dell'e-Health, l'e-Government ed i servizi pubblici fruibili in Rete.

Ancora una volta, dunque, è avvalorata la tesi per cui un uso efficiente ed efficace delle nuove tecnologie può contribuire a migliorare la qualità delle prestazioni sanitarie erogate, a vantaggio non soltanto delle istituzioni coinvolte, ma anche, e soprattutto, a vantaggio del cittadino/paziente, il quale, nel mondo globalizzato potrà fruire di adeguate cure sia nel proprio luogo di vita abituale sia all'interno dei confini nazionali ed europei.

Dal punto di vista politico e legislativo sono, in tal senso, già stati creati i presupposti per consentire l'assistenza sanitaria transfrontaliera, eliminando gli ostacoli che impediscono ai pazienti di curarsi in Europa nonché formalizzando il diritto di recarsi in uno Stato membro per curarsi ed ottenere il rimborso delle spese sostenute (cfr. direttiva 2011/24/UE recepita dall'Italia nel 2014).

Creare sistemi informativi sanitari interoperabili e fascicoli sanitari elettronici interoperabili è una delle chiavi di volta per garantire l'esercizio di tali diritti (in proposito, tra i più recenti provvedimenti si richiama la 'Raccomandazione della Commissione sulla interoperabilità transfrontaliera dei fascicoli sanitari elettronici'). Al tempo stesso, saranno inevitabili futuri interventi legislativi che definiscano misure comuni tra gli Stati membri di identificazione ed autenticazione per agevolare la trasferibilità dei dati nell'assistenza sanitaria transfrontaliera nonché per garantire la continuità delle cure e la sicurezza del paziente e dei flussi dei dati sensibili ad esso attinenti.

Per quanto concerne, invece, il tema delle 'security policy', nelle quali l'azienda definisce non soltanto il concetto di sicurezza che all'interno del proprio sistema ha valore, ma anche gli obiettivi perseguiti e gli strumenti utilizzati per implementare ambienti operativi sicuri, in un'ottica di mobilità

nazionale e comunitaria, è sempre più importante che le istituzioni sanitarie concordino sull'utilizzo di standard di cui, in primis, potranno beneficiare gli utenti. Infatti, la presenza di norme e prassi condivise all'interno dell'Unione europea creerà di riflesso una maggior fiducia dei pazienti, i quali verosimilmente si avvarranno con minor timore dei servizi sanitari di qualità erogati anche presso Stati terzi ovvero con modalità di telemedicina.

Una visione patient-centred delle nuove tecnologie

In conclusione è possibile affermare che lo studio rivela un'idea chiave: la salute è un diritto del singolo e della collettività; per tale ragione, tutti gli aspetti con esso connessi (nel caso di specie sono stati esaminati quelli tecnologici e giuridici, ma un analogo esito potrebbe aversi tenendo presente ogni altra disciplina, scientifica o umanistica) devono essere integrati. Il bilanciamento delle talora antitetiche prospettive deve avere come riferimento il paziente/utente, principale fruitore delle prestazioni socio-assistenziali ma, al tempo stesso, motore di uno sviluppo armonico del sistema sanitario nel suo complesso. Le nuove tecnologie più che introdurre dei nuovi paradigmi hanno sollecitato la nascita di nuove dinamiche relazionali che, evidentemente, non possono essere ignorate bensì comprese. La progettazione dei nuovi strumenti di cura deve, però, fondarsi sui paradigmi tradizionali della relazione medico-paziente, fornendo al tempo stesso adeguate chiavi di lettura alla generazione di pazienti non nativi digitali, affinché questi possano acquisire una cultura 2.0 e contribuire allo sviluppo di meccanismi virtuosi sia sul fronte clinico sia sul fronte amministrativo.

Attribuzione dei paragrafi

The contributions of this paper are assigned as following: R. Brighi: 'Il paziente al centro della sanità digitale: ostacoli e tendenze attuali' and 'Il ruolo del dato sanitario nei nuovi scenari di cura'; M.G. Virone: 'Prospettive di armonizzazione giuridica e tecnologica per il trattamento dei dati sanitari' and 'Una visione patient-centred delle nuove tecnologie'.

References

Callens, S. (2010) *The EU legal framework on e-health*. In Mossialos, E., Permanand, G., Baeten, R. e Hervey, T.K. (eds.), *Health Systems*

- Governance in Europe. The Role of European Union Law and Policy.*
Cambridge: Cambridge University Press.
- Cavoukian, A. (2009) *Privacy by Design. The 7 Foundational Principles.*
Toronto. [Online] Consultabile su
<http://www.privacybydesign.ca/index.php/about-pbd/7-foundational-principles/> [Ultimo Accesso: 14 Dicembre 2014].
- Cavoukian, A. e El Emam, K. (2010) *A Positive-Sum Paradigm in Action in the Health Sector.* [Online]. Consultabile su
<http://www.ipc.on.ca/English/Resources/Discussion-Papers/Discussion-Papers-Summary/?id=943>. [Ultimo Accesso: 14 Dicembre 2014].
- Cavoukian, A. (2009) *Moving Forward From PETs to PETs Plus: The Time for Change is Now.* [Online]. Consultabile su
<http://www.privacybydesign.ca/index.php/paper/moving-forward-from-pets-to-pets-plus-the-time-for-change-is-now/>. [Ultimo Accesso: 14 Dicembre 2014].
- Cavoukian, A. (2009) *Privacy by Design ... Take the Challenge.* [Online]. Consultabile su <http://www.ipc.on.ca/english/Resources/Discussion-Papers/Discussion-Papers-Summary/?id=856>. [Ultimo Accesso: 14 Dicembre 2014].
- Cavoukian, A. (2010) *Privacy by Design. The 7 Foundational Principles. Implementation and Mapping of Fair Information Practices.* [Online].
<http://www.privacybydesign.ca/index.php/paper/implementation-and-mapping-of-fair-information-practices/>. [Ultimo Accesso: 14 Dicembre 2014].
- Cavoukian, A. (2013) Privacy by Design and the Promise of SmartData. In Harvey, I., Cavoukian, A., Tomko, G., Borrett, D., Kwan, H. e Hatzinakos, D. (eds.), *SmartData: Privacy Meets Evolutionary Robotics*. New York: Springer.
- Cavoukian, A. (2013) Privacy by Design : Leadership, Methods, and Results. In Gutwirth, S., Leenes, R., de Hert, P. E Poullet, Y. (eds.), *European Data Protection: Coming of Age*. New York: Springer.
- Cavoukian, A. e Chanliau, M. (2013) *Privacy and Security by Design: A Convergence of Paradigms.* [Online].
<http://www.privacybydesign.ca/index.php/paper/privacy-and-security-by-design-a-convergence-of-paradigms/>. [Ultimo Accesso: 14 Dicembre 2014].
- Koops, B.J. e Leenes, R. (2013) Privacy regulation cannot be hardcoded. A critical comment on the 'privacy by design' provision in data-protection

law. *International Review of Law, Computers & Technology*, 28 (2), 159-171.

Moerel, L. (2014) *Big Data Protection. How to Make the Draft EU Regulation on Data Protection Future Proof*. Tilburg: Tilburg University.

Pagallo, U. (2012) On the Principle of Privacy by Design and its Limits: Technology, Ethics and the Rule of Law. In Gutwirth S., Leenes R., De Hert P. e Poullet Y. (eds), *European Data Protection: In Good Health?*. New York: Springer.

Palfrey, J. e Gasser, U. (2012) *Interop. The promise and perils of highly interconnected systems*. Basic Books: New York.

Tromko, G. (2013) SmartData: The Need, the Goal and the Challenge. In Harvey, I., Cavoukian, A., Tomko, G., Borrett, D., Kwan, H. e Hatzinakos, D. (eds.), *SmartData: Privacy Meets Evolutionary Robotics*. New York: Springer.

The role of artefacts in the coordination of home care practices

Adeline HVIDSTEN^{*a}, Antonella LA ROCCA^b and Thomas HOHOLM^a

^a BI Norwegian Business School; ^b Akershus University Hospital

In this paper, we describe how artefacts contribute to the coordination of home care services. We report from our ongoing fieldwork at a home care service provider in a city district of Oslo. From the narrative of a typical day in the home care service, we identify and discuss three aspects: (1) the role of an assemblage of artefacts, rather than single objects, (2) how practitioners cope with artefacts that have more or less permanent shortcomings and (3) the direct (boundary object) and indirect (shadow object) roles of budgets in coordinating home care practices.

Keywords: Coordination; artefacts; home care; practice

Introduction

Using a practice lens, the aim of this paper is to explore how employees in a small home nursing unit in a district of Oslo interact with both technological and non-technological artefacts in health care coordination.

As a consequence of the Coordination Reform (St.Meld nr. 47, (2008–2009) 2009), relationships between hospitals (secondary care) and municipalities (primary care) are changing substantially. The reform aims to ‘improve cooperation between municipal health and care services and the specialist health care services’ (NOU 2011, p. 21) by redistributing both resources and responsibility from hospitals to municipalities. This process includes decentralizing services as part of the plan to move from a specialist-centred approach to a patient-centred service (Melby and Tjora, 2013). Furthermore, the government has introduced a payment regulation that imposes daily penalties on municipalities that are not able to provide care services for patients ready to be discharged from hospitals.

* Corresponding author: **Adeline Hvidsten** | e-mail: adeline.hvidsten@bi.no

To fulfil the aim of the reform and help municipalities cope with newfound pressure, the government stresses the importance and potential of information technology (IT), recommending the removal of old non-technological solutions (Helse-og Omsorgsdepartementet, 2004). Despite this, ‘the established methods of communication in health care are, for the most part, non-electronic, although more electronic means are currently being implemented’ (Lyngstad et al., 2014, p. 2). While technologies such as smartphones and electronic messaging systems have been implemented in home care, health care professionals are not utilizing the full potential of technology, with electronic messaging systems often used simply as ‘electronic paper’ (Meld. St. 9 (2012–2013), 2012).

Introducing new technological solutions means replacing artefacts used as coordination tools with functions that are rich but to some extent latent. Studying the parallel use of non-technological and technological tools in collaborative practices may prevent ‘designing away’ important coordination functionalities in developing support systems (Xiao et al., 2001; Wears et al., 2007). In addition, non-technological objects often play an important part in modelling, designing and supporting technological work flows (Xiao, 2005).

We wish to contribute to the discourse on the role of artefacts in coordinating practices in municipal health care, specifically in situations of transition, where new technologies are entwined with old practices and where technological and non-technological artefacts are used together to promote coordination. We thus aim to gain insights into the design of systems and artefacts for supporting coordination of activities.

Theoretical Grounding

The role of technologies in organisation studies has been emphasized strongly by Orlikowski and Scott’s (2008) theorized fusion of the social and technical aspects, labelled sociomateriality. They describe sociomateriality as an umbrella term for studies taking a relational approach to the material and the social, suggesting that humans and technology ‘exist only through their temporally emergent constitutive entanglement’ (p. 457). Our study relates to those on the role of objects and the material in the organising of work practices. Nicolini (2013) argues that practices are never objectless and the entrance of a landscape of tools, artefacts and resources actively contributes to their accomplishment. Just as a practice must be enacted and re-enacted to exist, objects must be used and reused to be meaningful/have

utility. Nicolini, Mengis and Swan (2012) classify objects as boundary objects, activity-based objects, epistemic objects and infrastructural objects and discuss how objects may serve different interests and change status over time.

Fast-paced and high-pressure organisations face unique coordination challenges, and in health care effective inter-group coordination is a primary task (Faraj and Xiao, 2006; Wears et al., 2007). Faraj and Xiao (2006) explore how coordination of knowledge work occurs in a fast-response organisation using a practice lens, defining coordination as ‘a temporal unfolding and contextualized process of input regulation and interaction articulation to realise a collective performance’ (p. 1157). A recent literature review (Okhuysen and Bechky, 2009) suggests three main conditions for coordination: accountability, predictability and common understanding.

Bardram and Bossen (2005) explore how people in a hospital ward achieved coordination through a web of non-technological artefacts described by their material qualities, the structure provided for templates and their signalling to knowledgeable actors. It has been also observed that white information boards in hospital wards are key components in supporting collaborative work, affording users the ability to tailor it to their coordination needs and inventing new ways of representing information (Faraj and Xiao, 2006; Wears et al., 2007). In one Danish hospital, workers even retained the operating room (OR) planning board to re-represent the information after implementing a computerized system (Bardram, 1997).

Methodology

This study is part of a larger longitudinal research project investigating the change within and across health care organisations when introducing electronic messaging and mobile solutions. The investigation mainly applies qualitative fieldwork methods in the form of ethnography and action research. The data used for this particular paper consists of three full days of observation, as well as 11 interviews and document analysis.

The case we chose for our study is a unit providing home nursing services (called Unit A for confidentiality reasons) in a city district in the municipality of Oslo. It has approximately 180-200 patients, 17 permanent employees and several part-time and ad hoc employees. Since the most intensive coordination activities are planned in the morning and during lunchtime, these were considered the two critical observation moments.

However, observations were conducted for the entire working day for three consecutive days from 7.30 AM to 5 PM so as to follow coordination activities in between and after collective meetings. The primary settings of observation were the unit’s meeting room and two unit coordinators’ offices. Notes were taken about when and how people interacted with objects in the room, as well as other people.

Table 1 lists the respondents by organization, role and type of observation conducted. We conducted seven open-ended interviews which lasted between 40 and 60 minutes that were recorded and transcribed. When recording was not allowed, we took detailed notes of on-going dialogues between actors.

Table 1 Respondents.

Respondent	Organization	Role	Observed
R1	Oslo Municipality, PROSIT	Consultant, Gerica	meeting electronic messaging
R2	Oslo Municipality, PROSIT	Consultant, Gerica	meeting electronic messaging
R3	Oslo Municipality, PROSIT	Consultant, Gerica	
R4	Home Nursing Unit A.	Unit Leader	Unit meetings
R5	Home Nursing Unit A.	Unit Coordinator	Unit meetings, Office work
R6	Home Care Unit B.	Unit Coordinator	Office work
R7	Home Nursing Unit A.	Nurse	Unit meetings, Demonstration PDA
R8	Home Nursing Unit A.	Nurse	Unit meetings
R 9	Home Nursing Unit A.	Nurse	Unit meetings, Demonstration PDA
R10	Home Nursing Unit A.	Nurse Assistant	Unit meetings, Demonstration PDA
R11	Home Nursing Unit A.	Unskilled Worker	Unit meetings

At the home care unit, we interviewed eight employees (R4-R11) about the use of various tools at the workplace – personal digital assistants (PDAs), work lists, planning software, electronic messages – and their translation into practice. We also interviewed three electronic medical records system (called Gerica) consultants (R1-3) employed in the IT service unit of Oslo

Municipality (called PROSIT) at a training meeting they held in the home care unit.

The case context

Figure 1 describes the organization of the Municipal Health Care Services in Oslo. The municipality of Oslo has a central department that deals with the electronic medical records (EMR) system, Gerica, called PROSIT. Representatives from PROSIT work as consultants to train and support workers using Gerica in their daily work and work closely with the developer of Gerica, a private company.

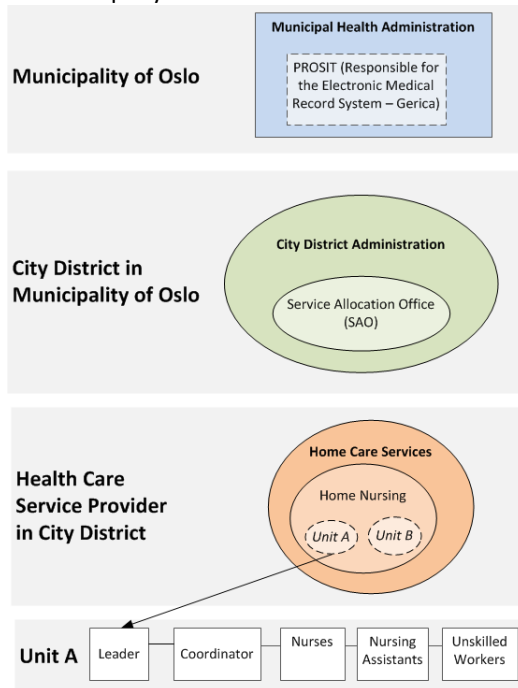


Figure 1 Municipal Health Care Services in Oslo.

All city districts of Oslo have their own internal administration, with a service allocation office (SAO) that is responsible for determining the primary health care services to offer patients. The SAO is responsible for the so-called 'decision' regarding the type of care services the user needs and how much time the care personnel should spend, down to the minute. Each city district has many municipal health care services: nursing homes,

physiotherapy and home care services, amongst others. Each nursing unit covers different geographic areas and each unit has a leader and a coordinator, as well as 'front-line workers' - nurses, nursing assistants and unskilled workers - who have direct contact with patients in their homes.

Coordination practices at the home care unit

We start this section by describing the overall environment of the home care unit before zooming in on coordination practices. The home nurses, nursing assistants and unskilled workers represent the 'front line' of municipal health care services. Their daily work is heavily influenced by decisions taken at the municipal administration level, in the unit, and by other actors such as the Service Allocation Office. As the SAO regulates the budget of the home care service it maintains close control:

'If we spend more time with the user than [the SAO] has determined is appropriate, they tell us 'you are not able to use that time, you need to reduce it'. They are like supervisors, and it is very strict ...' (R4, unit leader).

Front-line workers are under strong time pressure and only 53% of their time is allocated for user care. Apart from their work with users, they are required to perform administrative work in the form of documenting user visits in Gerica (EMR system), ordering equipment and communicating with general practitioners (GPs) and hospitals. Each employee might visit 20+ users each day, and documenting a serious case can take almost 40 minutes. The working hours are often insufficient to complete such tasks:

'If you don't do it [document a visit in Gerica] during the day, then you have to stay late ... It is a matter of life and death' (R10, nursing assistant).

The SAO is responsible for tasks such as monitoring the 'activities of daily living' of patients (a measurement of the functional status of a person) through Gerica and occasional house calls. The SAO also has an emergency team responsible for the first home visit after hospitalization. Care service decisions, registered in Gerica, are taken by the SAO, but a home care unit's coordinator can negotiate changes upon receiving a request from a front-

line worker. The coordinator uses these decisions as tools for scheduling and allocating care services:

‘One of my primary tasks is to continuously communicate with the SAO... most of the time we negotiate the decision on time to be spent with users. I feel really controlled by the SAO, even if I have the power to decide’ (R5, coordinator).

The coordination reform has influenced the daily work of the unit and the relationship with the SAO. The SAO is responsible for the budget and thus does not want to pay a fine for not providing a user with a service when that user is ready to be discharged from the hospital. This is clearly frustrating for the unit, especially because unit personnel perceive re-hospitalizations are increasing:

‘We see that users return to the hospital much earlier than before. We think that they cannot stay home because it is dangerous... But, this is typical, after the coordination reform... It is because [the SAO] does not want to pay the fines’ (R4, unit leader).

According to our interviewees, patients coming home are sicker, which has increased the unit’s work load and challenged staff competence. Nurses must be retrained, so the home care service hired its own nurse for professional development and training. Front-line workers are constrained and frustrated by the strict time schedule (R10, nursing assistant) and they are aware that this affects the quality of the treatment they provide also in terms of ‘needed human touch’ (R8, nurse).

The unit coordinator’s role and tasks

It is morning and the coordinator is planning, while constantly on the phone with front-line workers, users, their relatives, hospitals and the SAO. She needs to make sure enough staff members are on duty and that they have the required competencies to perform the scheduled procedures. The lack of personnel is perceived as urgent in relation to the training; it is a trade-off:

‘If I take someone out to train them, then there are not so many working with the patients... that’s a result of the budgeting...’ (R4, unit leader).

The coordinator collects a binder from the unit's common room containing the shift plan; each page has a list of who is working what shift on a specific day. The unit has software called GAT and all employees can see their shift plan and schedule in the office; they can also access them online. Still, they use the paper shift plan in the binder for both these functions. The coordinator registers changes from the shift plan in GAT since the workers only use the paper list. The changes must also be registered in Gerica as GAT controls the salaries

The daily schedule, printed from Gerica, is assigned to each employee. Each front-line worker is given a unique route each day containing about 20-25 users. It is important to have the right competencies in each shift, and even when procedures can be performed by unskilled workers, not everyone has such training. There is at least one 'pure nurse' route each day. Each type of worker is allocated a certain amount of time with users each day: a nurse should spend no more than 3,2 hours each day, while nursing assistants and unskilled workers should spend even less time. This is determined using a calculator and a notebook.

When satisfied with the shift plan for the date in question, the coordinator assigns the routes to employees using the schedule function in Gerica. It is, however, not that easy to plan ahead, as patients are often going to and coming home from the hospital. If a patient in need of nursing procedures suddenly comes home, then the nurses' 3,2 hours are easily exceeded. This is quite common, and if the nurse is not prepared it is 'her head that is on the chopping block' (R5); to avoid surprises, the coordinator constantly has to monitor hospitalizations.

The coordinator explains that to maintain a certain control she can only rely on her experience and knowledge as a nurse. The unit leader says she has a backup person who can do her job in case she is ill but she also says that this kind of job is not easily inter-changeable (R5).

We see the importance of an experienced coordinator when spending an hour in the office of a coordinator of a different unit. Here the coordinator has only 2,5 months of experience and is struggling, not knowing the users or the geographic area well. She keeps a book with handwritten instructions that she follows to generate reports and routes, and she needs a map at all times. While coordinators generally plan one week ahead, we observe that at 1 PM she is still creating the schedule for the next day.

Front-line workers' practice

Front-line workers' day in the home care unit can be described as follows: morning assessment meeting, first patient visits, report meeting during lunch, second patient visits, return to report and document. Following a temporal logic, we describe the main characteristics of each of these phases and the kind of tools used to perform their activities. We enter the unit's common room at 7.30 AM, the same time as employees should meet for the morning report, unless their rounds have already started. Employees grab paperwork lists (schedules) with their names on, providing their routes. The work lists define which users should be visited when and their official decisions. Two workers are arguing; the coordinator gives them a stern look: 'I will just do my report, and then you can carry on with the fistfight?'

The coordinator signals it is time for the report to start and all workers settle down around the table. She reads messages generated after work lists were printed, along with her own notes on users. There is free discussion about problematic cases (e.g. users who do not gladly accept the treatment provided) and the coordinator often acts as advisor, providing suggestions that may also be useful for others in the room. Workers scribble extra information on their lists, and the coordinator registers changes related to the official decisions in her book. After information has been distributed, the care personnel start to arrange their rounds. Keys for users' houses and car keys need to be signed off. There are ten workers and only four cars, so they need to negotiate with each other for rides, and some do their routes on foot. Three people stand around a map; a nurse who is walking does not know where to go and is asking others for help.

There is a space to record changes in the work lists. When there is no way to get transportation to work, if a user refuses a visit from a certain nationality or gender or if someone is not able to perform a procedure defined by the official decisions, the users must be swapped. The normal procedure for changes is to 'cut and paste'. We see this first hand; one worker rips a patient from her list, a second worker tapes it to her list with medical tape. When asked about this practice, they answer:

'That is how it is. In the future I hope we will only use the PDAs, and then we will stop with all this cutting and pasting ...' (R4, unit leader).

'It is much better now; when I got here they were physically

fighting and stealing each other's lists ...' (R5, coordinator).

PDAs are available on a shelf in the meeting room, but only a few workers bring one with them. Although they are the first unit in the district to get PDAs, they nearly never use them. The PDAs are old; many are broken, almost impossible to log on to and slow to operate; also, they run out of power after two hours and the network connections are poor. Their potential is recognised by operators but:

'At the moment they are just heavy mobile phones... Now I am doing this [shakes the work list rigorously] and if I lack some information I need to go back to the office... If the PDA was working, I could just get the EMR. I could check if the medication was right, or wrong, and if the nurse needs to update it... And, I could write the report right there, I would not need to do it in the office... We are always in a hurry, a lot of stress; we have to be back in the office for the report at 12.30 PM... I think we will never really get rid of this 100% [shakes the list again]...' (R10, nursing assistant).

It is time for the lunch report, and the room is filling up slowly; workers are again running in and out of the room, performing different administrative tasks. It is difficult to reach the GPs; their phone is closed during lunch. The computer in the meeting room is started and Gerica appears on the smart TV. Each worker around the table reports on his or her users. A nurse is documenting the information into Gerica, being interrupted as others correct his spelling or add something. A heated argument occurs, but it is quickly silenced by proof in the form of a record in Gerica; excuses are made quickly.

After the official report is completed, other experiences are shared. The workers tell each other stories about how nice their users are and offer examples of how the users call them their son or daughter. The unit leader tells us that they try to make sure users always have the same worker, while the front-line workers see it as reassuring to have more eyes on the same user.

Shortly, the same routine starts as before starts; keys are swapped, forms are signed, rides are planned and work lists are modified. Some employees tell us they do not actually care for this report; theirs is the only unit still producing it. They have a lot of administrative work to do after

their lunch break and too little time with users in the first place (R11, unskilled worker).

Another report is given in the shift change. Not all personnel from the morning shifts show up, and the room is less busy. The workers are required to attend, but we are told there are just too many other things to do.

Discussion

Although this study is at a preliminary stage, it suggests areas that are worthy of further research on coordination practices in the field of health care. Drawing on our observations and interviews, we have identified three main issues, which are discussed below.

An Emerging Network of New and Old Artefacts

The first aspect of interest is how the home care unit operates in a context 'in transition' where, as a consequence, the inclusion of an assemblage of artefacts instead of just a single object becomes important for inquiry. Digital and non-digital artefacts are blended together. Consistent with what Bardram and Bossen (2005, p. 174) described as 'brought 'out of the computer' again' and modified through 'micro practices', lists are printed and modified by cutting and pasting and handwritten notes are used to discuss patients' conditions during report meetings. The information is then brought into the computer again through the worker writing a report in the medical record system. If the information recorded requires a change in the formal decision, the coordinator will transfer the case to her report book before registering it. The different artefacts produce dual representations of the same information (Bardram & Bossen, 2005), related to the actions afforded by the artefacts. While the computer is stationary and requires time for logging on, the lists are mobile and information is easily accessed and modified. The display screen is used as a means for sharing doubt and taking decisions in a collective way, confirming the role of external representation to 'solve problems leveraging perceptual capabilities' (Xiao et al., 2001, p. 267).

Technological Shortcomings

What we see in this case is not just that technological artefacts 'break down' occasionally, which is often a great entry point for understanding the role of technology for organising. It is more like a situation where some artefacts are expected to fail, at least partially, on a regular basis. So, a

relevant question is: 'What happens when coordination artefacts are perceived as unreliable?' The backup procedure is improvisation. There is no standard procedure to overcome the problem; rather, there is a process of arrangement and re-arrangement of the 'assemblage' in an attempt to produce a reliable coordination practice despite fragile technologies. In the setting we observed, we assisted in both ways of handling the shortcomings of technology: through the dual representation of data (Bardram & Bossen, 2005) and by dropping it completely (Wears et al., 2007). Similar to a previous study (Bardram, 1997), despite the apparently intuitive software used for the shift plan and schedule program, front-line workers continue to use the paper folder in the unit's common room, thereby limiting use of the computerized system to remote access. Thus, its current main uses concern the transcription of information by the unit coordinator from the paper folder to the system to ensure that the front-line workers are paid for their work.

Our case seems to confirm what has been observed in a previous study (Wears et al., 2007), which is that artefacts that do not fit into practice will be dropped quickly, especially in medical contexts where the outcome of failures can potentially be fatal. As Wears et al. (2007) note, one of the biggest weaknesses of medical status boards is that they leave no documentary trace and are therefore of little use for managers (ibid). In our case, when lists are modified by front-line workers, the coordinator registers these changes in the medical record system. Also, the information written on the lists during patient visits is recorded in the system and reported to the coordinator in case of doubts about a patient's care treatment. However, while the staff can easily act on the paper lists by correcting and modifying their content, the shortcomings of PDAs are perceived as impossible to overcome. Therefore, a stable practice of using paper has been adopted and workers feel they will never get rid of the lists, even if they know new-generation PDAs are coming.

The budget as an artefact

In this case study, one artefact seems to occupy a prominent role, while not directly manifesting in the daily coordination of practice: the budget. In daily practice, the budget is like a shadow - not directly present, but still strongly influential via its implications for personnel and resources and via the priorities and decisions of the coordinator and her leaders. The coordinator tries to 'protect' her employees from this artefact or at least from the stress/workload it may add to their already intense daily work with

patients. To those directly involved with the budget, it is a boundary object, mediating the available monetary resources and the required "production" of services with local practice, as well as the available resources (e.g. technologies, cars), and the actual needs of their unique base of users. There is a clear asymmetry of power among the actors involved in the budgeting issue. The city district administration, providing the monetary resources and the production requirements, actively seeks to influence care providers to become more efficient and to prioritize according to policies and decisions. Still, the local managers and coordinators are very active in mediating and channelling the budget effects by protecting their employees from the budget discourse, as well as engaging with their personnel in creating and maintaining practices that are also consistent with their professional values and their empathy with users.

Conclusion

This case study has shown how several new and old artefacts are used together, thereby suggesting that the role of objects in coordination can be thought of and analysed as an assemblage of objects. This concept may help produce valuable insights into the socio-material character, as well as the dynamics, of coordination work. When new artefacts are introduced, such as IT tools, we see how the assemblage is typically not considered, as it seems to be more common to consider only the direct objects being replaced. Assembling or de-assembling artefacts implies 'making and breakings links' (Shove et al., 2012). From an assemblage point of view, it becomes more understandable how and why the introduction of new coordination tools are not always leading to the replacements of the old ones. Furthermore, we may understand better how practitioners cope with the incompleteness of objects by adjusting practices, tinkering with the objects, and taking social implications such as the effect on colleagues and patients into account. For further research, we believe that e.g. the role of shadow objects, artefacts whose role and effects become visible only by zooming out from micro to macro practices, deserve more attention.

Analysing interdependences between artefacts, how they are formed and how their configuration changes over time is undoubtedly an important venue of research if we want to better understand coordination practices.

References

- Bardram, J.E. (1997) *I love the system—I just don't use it!* Paper presented at the ACM Conference on Group Work (GROUP'97), New York.
- Bardram, J.E. and Bossen, C. (2005) *A Web of Coordinative Artifacts: Collaborative Work at a Hospital Ward*. Paper presented at the 2005 International ACM SIGGROUP Conference on Supporting Group Work, Florida.
- Faraj, S. and Xiao, Y. (2006) Coordination in Fast-Response Organizations. *Management Science*, 52 (8), 1155-1169.
- Helse- og Omsorgsdepartementet (2004) *S@mspill 2007. Elektronisk samarbeid i helse- og sosialsektoren*. (Statlig strategi I-1097B). Oslo: Helse- og Omsorgsdepartementet.
- Lyngstad, M., Grimsmo, A., Hofoss, D. and Hellesø, R. (2014) Home care nurses' experiences with using electronic messaging in their communication with general practitioners. *Journal of Clinical Nursing*, 23 (23-24), 3424-33.
- Melby, L. and Tjora, A. (2013) *Samhandlingens mange ansikter*. In Tjora, A. and Melby, L. (eds.), *Samhandling for Helse: Kunnskap, kommunikasjon og teknologi i helsetjenesten*. Oslo: Gyldendal.
- Meld. St. 9 (2012–2013) *Én innbygger – én journal. Digitale tjenester i helse- og omsorgssektoren*. Oslo: Helse- og Omsorgsdepartementet. [Online]. Available from:
<http://www.regjeringen.no/pages/38146106/PDFS/STM201220130009000DDDPDFS.pdf>. [Accessed: December 2013].
- Nicolini, D. (2013) *Practice theory, work, and organization: An introduction*. Oxford: Oxford University Press.
- Nicolini, D., Mengis, J. and Swan, J. (2012) Understanding the Role of Objects in Cross-Disciplinary Collaboration. *Organization Science*, 23 (3), 612-629.
- NOU 2011 (2011) *Innovasjon i Omsorg*. Oslo: Helse- og Omsorgsdepartementet. [Online]. Available from:
http://www.regjeringen.no/pages/37990512/PDFS/NOU201120110011000EN_PDFS.pdf [Accessed: December 2013].
- Okhuysen, G.A. and Bechky, B.A. (2009) Coordination in Organizations: An Integrative Perspective. *The Academy of Management Annals*, 3 (1), 463-502.
- Orlikowski, W.J. and Scott, S.V. (2008) Sociomateriality: Challenging the Separation of Technology, Work and Organization. *Academy of Management Annals*, 2 (1), 433-474.

- Shove, E., Pantzar, M., and Watson, M. (2012) *The Dynamics of Social Practice: Everyday Life and How it Changes*. Los Angeles: Sage.
- St.Meld nr. 47 (2009) *Samhandlingsreformen. Rett behandling- på rett sted - til rett tid*. Oslo: Det Kongelige Helse- og Omsorgsdepartementet. [Online]. Available from: <http://www.regjeringen.no/pages/2206374/PDFS/STM200820090047000DDDPDFS.pdf>. [Accessed: December 2013]
- Wears, R., Perry, S. J., Wilson, S., Galliers, J. and Fone, J. (2007) Emergency department status boards: user-evolved artefacts for inter- and intra-group coordination. *Cognition, Technology & Work*, 9 (3), 163-170.
- Xiao, Y. (2005) Artifacts and collaborative work in healthcare: methodological, theoretical, and technological implications of the tangible. *Journal of Biomedical Informatics*, 38 (1), 26-33.
- Xiao, Y., Lasome, J. M., Mackenzie, C. F. and Faraj, S. (2001) *Cognitive Properties of a Whiteboard: A Case Study in a Trauma Centre*. Paper presented at the the Seventh European Conference on Computer-Supported Cooperative Work, Bonn.



Taking Care of Drivers/Taking Care of Technologies? Tensions and Promises of Advanced Driver Assistance Systems

Oana MITREA*
Alpen-Adria Universität

Does driver assistance also mean 'driver maintenance and repair'? And will the technological visions of driver assistance change in the direction of preventing humans of intermingling with 'just and safe' decisions of automated technologies? The current paper analyzes designers' visions about the procedures and routines of maintenance and repair embedded in advanced driver assistance concepts.

Keywords: *Driver assistance; designers' scripts, routines of maintenance and repair of human errors*

Introduction

The technical solutions for the assistance of drivers are developed according to 'scripts', described by Akrich (1992) as: 'the end-product of the designers' hypotheses and visions about the entities that make up the world into which the object is inserted' (Akrich 1992, p. 207-208). The notion of *driver assistance* in Advanced Driver Assistance Systems (ADAS) covers a variety of scripts that play with the relative magnitude of human and technological overhand. According to Carsten and Nilsson (2001) they range from assistance as information providing (navigation systems, Traffic Master and RDS-TMC receivers), as feed-back with the intention of reducing drivers errors and violations (longitudinal collision warning systems, lane departure warning systems and lane-change assistant systems), to intervention in vehicle control without completely supplanting the driver (intelligent speed adaptation, adaptive cruise control- ACC, Stop and Go), and even autonomous driving (Carsten and Nilsson, 2001). Driver monitoring systems have been recently developed to monitor sleepiness, drowsiness,

* Corresponding author: Oana Mitrea | e-mail: oana.mitrea@aau.at

distraction, or inattentiveness on the road (Wang et al., 2007; Rogado et al., 2009; Regan and Hallett, 2011; Park et al., 2011). A revolution in vehicle automation is expected, which is made possible by the low-cost sophisticated sensors (Denaro, talk at IEEE ITCS 2013).

These recent and future developments make necessary the further exploration of the meaning of driver assistance. The issues of maintenance and repair in the session: 'To maintain, to repair. Infrastructures and design-in-use' offer inspiration in this matter. The current paper formulates the following assumption:

Designers' visions about the purposes and forms of driver assistance have extended beyond the notion of tactical and operational support of driving to a sort of 'continuous human repairing'.

- a. *Human drivers are currently regarded as dangerous and difficult to predict components of mobility systems. Consequently, their impact should be controlled and minimized as much as possible in order to enhance traffic safety and efficiency.*
- b. *Even if humans are kept out of risky actions and decisions (in vehicle automation), the responsibility for driving should still stay with them (out of regulatory reasons, industry interests). A new dilemma occurs: how reach and maintain both driver inclusion and exclusion?*

To check if these assumptions are in accordance to designers' visions, a literature survey in the field of driver assistance and intelligent transportation systems (ITS) has been conducted. Additional empirical information comes from interviews with professionals working in the area of transportation informatics. These first results stay at the beginning of a larger ongoing study that compares the visions of technology designers and users about technological drivers' assistance on the road.

The paper is structured as follows: in a first step the focus is placed on the current aims and fields of action of driver assistance in intelligent transportation systems, as they are reflected in the ITS field literature and the program and contributions in a major recent international conference on Intelligent Transportation Systems. The second part of the paper analyzes designer's visions about driver assistance with relevance for the

issues of maintenance and repairing and comments on a changed meaning of human maintenance and repair in advanced driver assistance systems.

Technical Scripts: taking care of drivers

Intelligent Transportation Systems (ITS) use 'synergistic technologies and systems engineering concepts to develop and improve transportation systems of all kinds.' (<http://sites.ieee.org/itss/>). One of the key research directions of the present in this field is towards intelligent solutions for drivers' assistance- ADAS (advanced driver assistance systems). The strongest motivation for the development of solutions for driver assistance is the enhancement of traffic safety. There is consensus among the designers of these solutions that: 'more people die or are injured on the streets than in wars' and that: 'humans are vulnerable elements of traffic, either as drivers, passengers, cyclists or other types of participants to traffic.'

The importance of the subject is reflected by the fact that the 16th International IEEE Conference on Intelligent Transportation Systems ITCS 2013 in The Hague included no less than nine sessions dedicated to driver assistance systems. Many other sessions dealt with closely related issues such as: advanced safety vehicles, sensors and machine vision, respectively human-computer interaction and autonomous driving. In the advanced driver assistance session the contributions focused on the detection and prediction of human, vehicle, and environmental conditions. Typical such studies concern: the inferring of driver intentions (Liebner et al., 2013), the learning about driving situations and behaviour models from data (Platto et al., 2013), the monitoring of drivers' drowsiness (Amine et al., 2013), driver behaviour profiling using smartphones (Castignani et al., 2013), the technical possibilities for improving of cognitive ability of old drivers (Nakano et al., 2013). Also very important has been the detection and classification of the external conditions for driving, be they pedestrians (Aly et al., 2013), obstacles (Garcia et al., 2013), or road infrastructure elements (Boutteau et al., 2013).

Designers' visions about how 'take care of drivers' are very diverse. They run from the necessity to ensure an enhanced comfort and enjoying of driving (light, temperature, and entertainment) to the efforts for an automatic identification of risky elements, events or behaviours and prevention of risky road events. Automated automobile safety solutions

such as ABS (anti-lock braking system) and ESP (electronic stabilization program) with related subsystems are already heavily implemented and welcomed by users, sometimes working below their awareness and caring.

The collision warning and fatigue monitoring systems should in principle include a form of interaction with humans, consisting in the providing of information and/or recommendation for action if a risky event occurs. The possibility for the taking over of driving control is given in near-to crash situations. For instance the Automatic Emergency Braking (AEB) technology will brake the vehicle just before a pending collision in order to reduce impact energy and reach an autonomous speed reduction of maximally around 35 - 40 km/h (Eidehall and Madås, 2013).

Visions of 'advanced' assistance of drivers

Since the beginning of May 2014 I have been conducting in-depth interviews with technology developers in the area of smart system technologies in traffic. The main focus of the interviews is on the following issues:

- The role and importance of humans in modern traffic systems
- The role and importance of smart traffic technologies
- The meaning of driver assistance. Designers' scripts of driver assistance
- Vehicle automation and the driver

15 interviews are planned with members of the academic community and industry experts working in the field of ITS (Intelligent Transportation Systems). The analysis below is mainly based on the literature survey of the research in the field of driver assistance, driver monitoring and warning, respectively vehicle automation and human factors. Several findings from the first two conducted interviews are here additionally presented to support the suppositions and arguments.

One of the first striking things from the first interviews has been the consensus about humans as 'danger zones' – requiring intervention from technologies. As one young male technology developer (academic) asserted:

I believe that currently humans represent for me the most serious danger area, for they are the ones who more or less cause accidents.. Here could technology a bit intervene, to minimize or eliminate this

cause ... "Fully eliminate is not possible, I believe that no one freely gives up freely his/her 100% control. Not even myself I want this..."¹

Another male young technology developer gives a similar answer to the question about the role and importance of humans in modern traffic and transportation. He highlights the rising importance and volume of needed technology to 'automate' human processes and minimize errors:

I believe that wherever people work, there are dangers and problems. I believe that the traffic and the technology has become so complex, so many areas are loaded with dangers and problems that such risks and potential dangers are getting bigger. The traffic volume is generally growing. If one thinks at the air traffic, the volume of air traffic continues to grow, more and more machines start and land, the processes become more complex, ...increasingly more technology is needed to automate the human factor.²

Monitoring and warning

In the area of traffic safety massive efforts have been made to intelligently recognize dangerous in- or out-car situations through sensors, process and interpret huge information amounts, present the results to drivers in a clear and user-friendly form, and eventually interact with drivers. The learning from past driver behaviour should enable them the prediction of driver intents and behaviour in specific contexts.

Concerning the automatic identification of risky types or behaviours, the state of the art research in traffic safety has generally confirmed the influence of age, gender, personality, and motivation on the safe /unsafe

1 In original (German): 'ich glaube, dass, derzeit Menschen für mich die ernste Gefahrzone für mich darstellen, dass sie mehr oder weniger Unfallverursacher sind...Da kann man mit Technik ein bisschen schauen, wie man diese Ursache minimieren oder eliminieren kann... Ganz eliminieren geht es schlecht, ich glaube nicht dass jemand den Steuer hundertprozentig abgibt, möchte nicht einmal selber...'

2 In original (German): 'Ich glaube, dass überall wo Menschen arbeiten, Gefahren und Probleme gibt es im Spiel. Ich glaube, dass der Verkehr und die Technik mittlerweile so komplex geworden sind, dass so viele Bereiche mit Gefahren und Problemen mitinvolviert sind, dass diese Gefahren und Gefahrpotenziale immer größer werden. Die Tragweite der Gefahren wird immer größer. Wenn man sich am Flugverkehr denkt: das Flugaufkommen wird immer größer, immer mehr Maschinen starten und landen, die Abläufe werden immer komplexer, es wird immer mehr Technik notwendig, um den Faktor Mensch zu automatisieren..'

driving. Some categories seem to carry the 'unsafety' germ in their core, such as: 'the adolescent driver' (Glendon, 2011), 'old drivers' (Schultheis and Manning, 2011), males, among them particularly the 'the sensation-seeking' ones (Rosenbloom and Wolf, 2002). Brain research has concluded that the youngest drivers manifest a tendency for risk taking, tend to look for immediate rewards, and have a rather irrational, disorganized thought pattern and a delayed processing of critical information about generically dangerous situations (Glendon, 2011). These stable features seem to justify preventive and /or corrective technological efforts focused on drivers and their contexts. The question remains whether these measures should be of a technical nature or the enhancement of risk awareness (for instance in driving schools) would be effective enough.

In the last time there have been growing efforts to detect dangerous drivers' states such as fatigue and distraction, which resulted in various driver monitoring systems. The main focus of these systems so far has been to identify sleepiness/drowsiness and distraction. For systems monitoring drivers' drowsiness see Wang et al. (2007), for inattentiveness see Regan and Hallett (2011). For the direct monitoring of driver's physiological characteristics through EEG see (Park et al.) 2011; heart rate Rogado et al. (2009). For the indirect inference of driver's status by looking at the vehicle performance/behavior see Diaz et al. (2002). For non-intrusive approaches monitoring drivers' behavior and status directly through various visual sensors see Amine et al. (2013); Fan et al. (2007); and Zhang et al. (2008).

For vision systems looking at the same time out of the vehicle to detect and track roads and avoid hitting obstacles or pedestrians and inside the vehicle to monitor the attentiveness of the driver and even predict her intentions see Trivedi et al. (2007). In industry Volvo has been developing a fatigue monitoring system based on a sensor anchored in the instrument panel that registers the direction in which the driver looks, how far his eyes are open and how he or she holds her head. If fatigue signs are detected, the car increases the distance to the car ahead as a precautionary measure and warns the driver. Such system should also be able to warn drivers before nodding off³.

The recent warning information systems come with solutions for crash prediction, accident prevention, collision avoidance, and the propagation of

3 <http://www.golem.de/news/muede-und-unaufmerksam-volvo-schaut-dem-fahrer-in-die-agen-1403-105199.html>

safety relevant data to drivers in real-time (Xie et al., 2010), warning of rear-end collision on account on image processing (Chang and Chou, 2009); system putting in relation the road geometry and the safe speed and preventing drivers from taking a curve with a dangerous speed (Glaser et al., 2007); and warnings based on 'blind spot', 'lane departure' detection and 'safe following distance' monitoring (Cayir and Açarman, 2009).

The assistance of drivers in (semi) automated driving

At the first sight one could assert that automatic driving is mainly about keeping drivers out from the (strenuous and risky) driving tasks. The vision of autonomous driving is however not only driven by safety concerns, but also has to bring the liberation from the strains of driving, a better employment of humans' mobility time, and a higher in-car comfort.

Moreover, 'autonomous driving' or 'automated vehicles' should not be made equal to 'driverless' since drivers are considered by the field community still an important part of the system. As the own participant observation at conference presentations and informal discussions at the IEEE ICTS2013 Conference has confirmed, the designers community believes that drivers should not be alienated from driving and be relieved from the responsibility for the driving process.

The concrete realization of this vision has technical, as well as human and social requirements and paths of action. From the technical point of view the road towards the establishment of automated driving systems is marked with already achieved accomplishments such as Adaptive Cruise Control (ACC) <http://www.daimler.com/dccom/0-5-1210218-1-1210321-1-0-0-1210228-0-0-135-0-0-0-0-0-0-0-0-0-0.html>) and concepts such as *platooning* (cars driving automatically a row with short spacings between them). Also in the field Cooperative Traffic Systems there have been completed pilot projects and formulated policy recommendations.

In the project example *Drive Me* (2014-2017)⁴ self-driving cars will ride on about 50 km of selected roads in and around Gothenburg. This will be made possible by the cooperative traffic technology that enables the

4 www.multivu.com/mnr/64153-volvo-self-driving-cars-unique-swedish-project. The pilot project will be conducted von Volvo Car Group in cooperation with the Swedish Transport Administration, the Swedish Transport Administration, the Swedish Transport Agency, Lindholmen Science Park, and the city of Gothenburg.

interaction between vehicles and street infrastructure. The control of the road and traffic is combined in Drive Me with this of the driver.

*'As the Volvo technology engineer Per Landfors explains: 'In the car, a sensor monitors the driver's attention. It detects whether the driver looks at the road or whether his eyes are closed'. However, the driver will continue to be responsible for his/her driving.'*⁵

The official homepage of the project highlights some individual benefits for drivers that should derive from the mix of autonomous and active driving:

*'Autonomous driving will fundamentally change the way we look at driving cars, as you can plan your drive with a mix of autonomous and active driving. This makes the journey more time-efficient. You can safely interact via phone or tablets or simply choose to relax. 'The self-driving technology used in the pilot allows you to hand over the driving to the car when the circumstances are appropriate,' comments Håkan Samuelsson.'*⁶

Maintaining and repairing: Tensions of the distributed actions and decisions

Maintenance and repairing represent important activities in Information Technology. A proof of this is that in software systems they consume 49% of the processing resources (Alkhatib, 2006). The maintenance of informatics systems can be classified in four categories: corrective (repairing of errors, modifications of systems to repair errors in design, programming or implementation), adaptive (ensuring the functioning of the system in various changing conditions), perfective (related mainly to the system improvement, new developments), and the continuous support (id.).

In general the ITS (Intelligent Transportation Systems) encompass complex telecommunication and street infrastructures, vehicles, humans, groups and institutions and do require all types of maintenance activities in specific fields. In the narrower field of ADAS the user involvement in technical maintenance activities plays currently a very small part (fact

5 www.multivu.com/mnr/64153-volvo-self-driving-cars-unique-swedish-project

6 <http://www.multivu.com/mnr/64153-volvo-self-driving-cars-unique-swedish-project>

generally confirmed in interviews). It is generally commonly accepted that very few drivers of latest vehicles stuffed with electronics and sensors would have the courage, competences and the technical means /devices to look behind the walls and try to repair the eventual damages. The repairing and system maintenance seem to be an expert- or a technology business: the self-repairing through intelligent supervision of the own functionality and learning from errors. On this background the interviewed technology designers suggest to ways to give humans back a rest of intervention powers:

Enable drivers to return to a manual control if advanced systems fail;
Adapt the car anatomy to this requirement (make manual control again possible by design).

The other way around, the assistive technology is very determined to check, correct, and even prevent human errors. Based on the systems analyzed in the first chapter, the *driver maintenance and repair* envisaged by the various driver assistance systems and services and accepted by the interviewed technology designers include the following forms:

Perfective maintenance:

The extension of human senses to the in-car and out-car perspectives not available before (particularly information about events in the dead angle, at poor light condition).

Corrective and preventive maintenance:

- The automatic recognition of errors, traffic violations, and dangerous driver states, warning (the further possibility of automatic avoidance, automatic braking, stop, etc. is not very welcomed by the interviewed technology designers);
- Rebooting humans – return of drivers to the a desired state (awake, aware, concentrated) or to context awareness through louder music, automatic adaptation of the car environment (light, temperature).

Coercitive maintainance (only if imminent life danger present):

This means to automatically prevent human actions (driving manoeuvres) if these are perceived as risky. Such type is seen as meaningful by the interviewed technology developers only if humans are on the verge

of a heart attack or other abrupt deterioration of physical condition and cannot control the car anymore

The above analysis of the distributiveness of the maintenance and repairing in the cars stuffed with intelligent technology gives new support for the reflections of Weyer (2005, 2009) about the consequences for humans of the long-term interaction with advanced/autonomous technology. In intelligent transportation humans and intelligent technologies take decisions and act together in various configurations, ranging from the full manual control to full automation (Weyer 2009, p. 47). The consequences of this hybridization are manifold:

'Hybrid systems of distributed agency tend to intensify the over-reliance on technology, which increases risks solely by the invisibility of the processes and the enormous time pressure. Additionally hybrid systems, which allow for autonomous action of technology and aim at a "perfect" control of the world, run the risk of a loss of competence on the part of the operators, since they try to avoid situations in which the operator can gain experience and learn from experience.' (Weyer, 2006, p. 141)

In addition, humans may suffer from a decrease of their capacity for strategic planning and instead to adaptive behaviour in the sense that only short time reactions to complex situation changes remain possible (Weyer, 2009). Although Weyer considers aviation the most adequate exemplification of a new world that is more and more shaped by the 'autonomous' technology, the intelligent assistive technical solutions face similar promises and problems. On this background the identification of the conflict potential emerging from the relation between the transparency degree of technological agency and the driver adaptability and autonomy represents a key issue for research.

What are the chances for higher user participation to maintenance activities in technologies aiming to intelligently assist humans in general (in driving, at home)? Even if some interesting forms of participative travel information and correction of travel information errors are evolving in the field of Transportation and Social Media, there is still room for design creativity about user maintenance and repair routines in Intelligent Transportation Systems.

Bibliography

- Alkrich, M. (1992) *The de-scription of technical objects*. In Bijker, W.E. and Law, J. (eds.), *Shaping Technology / Building Society: Studies in Sociotechnical Change*. Cambridge: MIT Press
- Alkhatib, G. (1992) The maintenance problem of application software: An empirical analysis. *Journal of Software Maintenance Research and Practice*, 4 (2), 83-104.
- Aly, S., Hassan, L., Sagheer, A. and Murase, H. (2013) *Partially occluded pedestrian classification Using Part-Based Classifiers and Restricted Boltzmann Machine Model*. Paper presented at the 6th International IEEE Conference on Intelligent Transportation Systems. The Hague: IEEE.
- Amine, A., Alioua, N., Zann, F., Ruichek, Y. and Hmina, N. (2013) *Monitoring Drivers Drowsiness Using a Wide Angle Lens*. Paper presented at the 6th International IEEE Conference on Intelligent Transportation Systems. The Hague: IEEE.
- Boutteau, R., Savatier, X., Bonardi, F. and Ertaud, J.Y. (2013) *Road-Line detection and 3D Reconstruction Using Fisheye Cameras*. Paper presented at the 6th International IEEE Conference on Intelligent Transportation Systems. The Hague: IEEE.
- Carsten, O.M.J. and Nilsson, L. (2001) Safety Assessment of Driver Assistance Systems. *European Journal of Transport and Infrastructure Research*, 1 (3), 225-243.
- Castignani, G., Frank, R. and Engel, T. (2013) *Driver behaviour profiling using Smartphones*. Paper presented at the 6th International IEEE Conference on Intelligent Transportation Systems. The Hague: IEEE.
- Cayir, B. and Acarman, T. (2009) *Low cost driver monitoring and warning system development*. Paper presented at the 6th International IEEE Conference on Intelligent Transportation Systems. The Hague: IEEE.
- Chang, T.H. and Chou, C.J. (2009) *Rear-end collision warning system on account of a rear-end monitoring camera*. Paper presented at the 6th International IEEE Conference on Intelligent Transportation Systems. The Hague: IEEE.
- Denaro, B. (2013) *ITS: Connecting, and Extrapolating the Dots*. Keynote Talk at the 16th International IEEE Conference on Intelligent Transportation Systems, The Hague.
- Diaz, A.S., Jammes, B., Esteve, D. and Mendoza, M.G. (2002) *Driver hypovigilance diagnosis using wavelets and statistical analysis*. Paper

- presented at the Proceedings The IEEE 5th International Conference on Intelligent Transportation Systems.
- Eidehall, A. and Madãs, D. (2013) *Real Time Path Planning for Threat Assessment and Collision Avoidance by Steering*. Paper presented at the Proceedings of the 16th International IEEE Conference on Intelligent Transportation Systems, The Hague.
- Fan, X., Yin, B.C. and Sun, Y.F. (2007) *Yawning Detection for Monitoring Driver Fatigue*. Paper presented at the 2007 International Conference on Machine Learning and Cybernetics.
- Garcia, F., de la Escalera, A. and Armingol, J.M. (2013) *Enhanced Obstacle Detection Based on Data Fusion for ADAS Applications*. Paper presented at the Proceedings of the 16th International IEEE Conference on Intelligent Transportation Systems, The Hague.
- Glaser, S., Nouveliere, L. and Lusetti, B. (2007) *Speed Limitation based on an Advanced Curve Warning System*. Paper presented at the Intelligent Vehicles Symposium.
- Glendon, I. (2011) *Neuroscience and Young Drivers*. In Porter, B.E. (eds.), *Handbook of Traffic Psychology*. Amsterdam, Boston, London: Academic Press Elsevier.
- Liebner, M., Ruhhammer, C., Klanner, F. and Stiller, C. (2013) *Generic Driver Intent Inference based on Parametric Models*. Paper presented at the Proceedings of the 16th International IEEE Conference on Intelligent Transportation Systems, The Hague.
- Nakano, Y., Kojima, T., Kawanaka, H. and Oguri, K. (2013) *Study of Improving the cognitive ability of old drivers*. 16th International IEEE Conference on Intelligent Transportation Systems, The Hague.
- Park, J., Xu, L., Sridhar, V., Chi, M. and Cauwenberghs, G. (2011) *Wireless dry EEG for drowsiness detection*. Paper presented at the 2011 Annual International Conference of the IEEE Engineering in Medicine and Biology Society. IEEE. Available from: <http://www.ncbi.nlm.nih.gov/pubmed/22255044> [Accessed: 12th Mai 2014].
- Platto, M., Gross, H.M. and Eggert, J. (2013) *Learning Driving Situations and Behavior Models from Data*. Paper Presented at the 16th International IEEE Conference on Intelligent Transportation Systems, The Hague.
- Regan, M.A. and Hallett, C. (2011) *Driver Distraction*. In Porter B.E. (eds.), *Handbook of Traffic Psychology*. Amsterdam: Elsevier Academic Press.
- Rogado, E., Garcia, J.L., Barea, R., Bergasa, L.M. and Lopez, E. (2009) *Driver fatigue detection system*. Paper presented at the IEEE International

- Conference on Robotics and Biomimetics, IEEE. Available from: <http://ieeexplore.ieee.org/lpdocs/epic03/wrapper.htm?arnumber=4913155> . [Accessed: 15th Mai 2014].
- Rosenbloom, T. and Wolf, Y.(2002). Sensation seeking and detection of risky road signals: a developmental perspective. *Accident Analysis and Prevention*, 34 (5), 569-580.
- Schultheis, M.T. and Manning K.J. (2011) *Neuroscience and older drivers*. In Porter B.E. (eds.), *Handbook of Traffic Psychology*. Amsterdam, Boston, London: Elsevier Academic Press.
- Trivedi, M M., Gandhi, T. and McCall, J. (2007). *Looking-In and Looking-Out of a Vehicle: Computer-Vision-Based Enhanced Vehicle Safety*. Paper Presented at the 16th International IEEE Conference on Intelligent Transportation Systems, The Hague.
- Wang, L., Wu, X. and Yu, M. (2007). Review of driver fatigue/drowsiness detection methods. *Journal of biomedical engineering*, 24 (1), 245-248.
- Weyer, J. (2006) Modes of Governance of Hybrid Systems. The Mid-Air Collision at Ueberlingen and the Impact of Smart Technology. *Science, Technology and Innovation Studies*, 2 (2), 127-149.
- Weyer, J. (2009) *Die Kooperation menschlicher Akteure und nicht-menschlicher Agenten. Ansatzpunkte einer Soziologie hybrider Systeme*. In Berger, W. and Getzinger, G. (eds.), *Das Tätigsein der Dinge. Beiträge zur Handlungsträgerschaft von Technik*. Munich/Vienna: Profil.
- Xie, H.X.H., Kulik, L. and Tanin, E. (2010) *Privacy-Aware Traffic Monitoring*. Paper Presented at the 16th International IEEE Conference on Intelligent Transportation Systems, The Hague.
- Zhang, Z., Chen, Y. and Yang, Y. (2008) *Driver fatigue detection system based on machine vision*. Paper presented at the 7th World Congress on Intelligent Control and Automation.



Spazi di transizione tra strutture socio-sanitarie e città. Condividere funzionalità in ambiente urbano

Valentina NAPOLI*

University of Rome 'La Sapienza'

Il progetto di ricerca presentato nel paper affronta la tematica di rigenerazione urbana, in un'ottica di sostenibilità ambientale e sociale, legata alla riqualificazione degli spazi aperti intorno alle strutture sanitarie pubbliche. L'obiettivo che si intende raggiungere è quello di analizzare l'organizzazione dello spazio esterno di transizione (pubblico e semi-pubblico) tra ospedale e città. I complessi ospedalieri vedono la compresenza di attività diverse: ricerca, didattica, diagnosi, terapia; essi sono quindi caratterizzati da differenti tipologie di utenza (pazienti, visitatori, operatori sanitari, fornitori, ecc.). Il progetto, attraverso il confronto di casi studio nazionali ed europei selezionati, analizzati con criteri e metodologie analoghi, indaga il ruolo dello spazio rispetto a tali attività, il rapporto con il tessuto urbano, la sua percezione da parte dell'utenza. Gli spazi esterni di questi grandi complessi, spesso degradati, inseriti in realtà urbane consolidate, sono luogo di riflessione ed azioni tese al miglioramento: delle attività interne (percorsi e flussi), della qualità percepita da parte dell'utenza (potenziale terapeutico), ambientale (rigenerazione urbana). I risultati della ricerca, attraverso l'analisi dei dati raccolti, sono input progettuali nella convinzione che, affrontando tale tematica, i progettisti debbano avere degli strumenti idonei che tengano in considerazione i bisogni dell'utenza ed il delicato rapporto con il contesto urbano (inclusive design).

Keywords: Ambiente terapeutico; inclusive design; rigenerazione urbana; spazio aperto; strutture socio-sanitarie

Introduzione

Il paper di seguito proposto presenta un progetto di ricerca *in itinere* che affronterà la tematica della rigenerazione urbana, incentrata sulla

* Corresponding author: **Valentina Napoli** | e-mail: valentina.napoli@uniroma1.it

riqualificazione di spazi aperti intorno alle strutture sociosanitarie pubbliche, in un'ottica di sostenibilità secondo diverse declinazioni (ambientale e sociale).

La ricerca si inserisce nel contesto europeo di Horizon 2020 e in particolare fa riferimento al pilastro 'Societal Challenges' e alla *call* 'Overcoming the crisis: new ideas, strategies and governance structures for Europe'. La Commissione Europea (2013) nel *topic* 'ERA-NET on Smart Urban Futures' evidenzia come dato di partenza fondamentale la percentuale di cittadini europei che vive in aree urbane, ovvero il 70%, e partendo da questo presupposto si prefigge di stimolare progetti di ricerca che dovrebbero fornire strumenti e metodi per rendere le aree urbane più sostenibili, aperte, innovative ed inclusive, attraverso una migliore comprensione delle dinamiche urbane, tra cui quella della progettazione e dell'uso dello spazio pubblico, potenziando nello stesso tempo l'inclusione sociale.

L'obiettivo che quindi si intende raggiungere con il progetto di ricerca è quello di analizzare l'organizzazione dello spazio esterno, di seguito denominato 'spazio di transizione' (pubblico e semi-pubblico) tra strutture ospedaliere ed il contesto urbano. Tali strutture sono complesse sotto il profilo organizzativo - funzionale e vedono la compresenza di attività diverse come ricerca, didattica, diagnosi e terapia caratterizzate da differenti tipologie di utenza (pazienti, visitatori, operatori sanitari, fornitori, etc.). L'intento è quello di indagare il ruolo dello spazio rispetto a tali attività, con particolare riguardo al rapporto con la popolazione, il tessuto urbano circostante e la percezione che ne hanno le diverse categorie di utenza.

Le grandi strutture ospedaliere, che comprendono sia gli edifici sia lo spazio esterno ad essi, occupando una ampia porzione di territorio al centro del tessuto urbano, sono tra le vaste e più complesse istituzioni pubbliche spesso vissute dai cittadini come 'città nelle città' (figure 1).

Nelle aree urbane dove lo spazio è un premio, si evidenzia come quello aperto intorno a tali strutture possa essere considerato 'potenziale spazio pubblico' (Garau, 2013) ed andare ad incrementare e rendere più organico il sistema degli spazi pubblici esistenti.



Figure 1 Schema che illustra il concetto di 'città nella città'.

L'ospedale, portando con sé il retaggio del XVIII secolo, che vede la nascita della medicalizzazione ospedaliera come disciplina o meglio tecnica di esercizio del potere per gestire l'uomo (Foucault, 1993), una 'machine à guerir' (Foucault, 1979, p. 16), è una realtà che suscita spesso disagio, spazialmente separata dal tessuto urbano (figura 2), il cui accesso è limitato solo a situazioni di emergenza o comunque di necessità.

Un 'ospedale aperto' (figura 3), integrato nella città, connesso con la vita urbana, che condivida funzioni con la comunità circostante, potrebbe cambiare la sua percezione pubblica e rivitalizzare la zona.

Dagli studi esaminati (Cooper Marcus and Barnes, 1999; Ulrich, 2001; Wagenar, 2006; Nedučin, Krklješ and Kurtović, 2010) si rileva che nello specifico settore di indagine esistono due principali criticità che si incentrano sul rapporto tra spazio aperto, struttura ospedaliera e tessuto urbano. Da un primo studio preliminare emerge come in tali strutture il rapporto tra il costruito e gli spazi aperti è quasi assente, creando un'interruzione fra le due componenti, con il risultato che nei luoghi istituzionali avere una vista su uno spazio verde, giardino o albero, è una rarità (Ulrich, 1984). Gli spazi interni ed esterni, progettati per l'efficienza, sono fortemente 'medicalizzati' e quindi fonte di stress per pazienti, visitatori e staff (Ulrich, 1992; Horsburgh, 1995).

E' stato rilevato, inoltre, come i confini tra struttura sanitaria, spazio aperto e tessuto urbano, siano vere e proprie 'barriere' che interrompono gli spazi con linee di demarcazione nette, generando nella popolazione la percezione della struttura come realtà difficile e di segregazione (Sack, 1986).

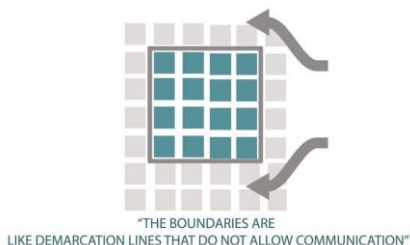
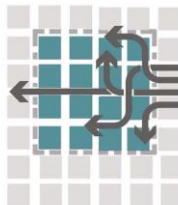


Figure 2 Schema che illustra i confini dell'ospedale, 'barriere' che separano spazialmente la struttura dal contesto non consentendo la comunicazione.

Il superamento di tali criticità è necessario se, in linea con la tendenza attuale in ambito di progettazione ospedaliera, si collocano i bisogni dell'utenza al centro della progettazione, riconoscendo perciò un ruolo fondamentale allo spazio aperto, che, se ben concepito, può avere una notevole valenza terapeutica (Tyson, 1998; Cooper Marcus and Barnes, 1999). Ciò emerge anche dalla definizione di salute data dalla WHO (World Health Organization, 1946, p. 1) come: 'stato fisico, sociale e mentale di benessere e non solamente l'assenza di malattia o infermità', da cui si evince che certi luoghi possano influenzare lo stato di salute dell'utenza, condizionandone il comportamento (Gelser, 2005).

All'interno del quadro di riferimento sinteticamente descritto, il progetto intende indagare, attraverso l'analisi di casi di studio nazionali ed internazionali, il ruolo dello spazio di transizione tra le strutture sanitarie e la città, comparando i risultati e mettendo in evidenza criticità e potenzialità.

In via preliminare si individuano quattro fasi specifiche di riferimento: la scelta dei casi studio da analizzare, la definizione dei profili di utenza, la strutturazione e somministrazione dei questionari e l'osservazione diretta dei flussi, la traduzione dei risultati in strategie progettuali di orientamento all'utenza ed alle amministrazioni per la ristrutturazione o la nuova edificazione di complessi ospedalieri.



"RECONNECTING AND REINTEGRATING HOSPITAL COMPLEXES BACK INTO THE URBAN FABRIC"

Figure 3 Schema che illustra la riconnessione e reintegrazione dell'ospedale nel tessuto urbano circostante.

Nel *paper* presentato assumono particolare rilevanza i presupposti teorici-metodologici delineati attraverso la ricostruzione dello stato dell'arte delle tre tematiche fondamentali che ruotano attorno all'oggetto principale dell'indagine: 'lo spazio di transizione tra strutture socio-sanitarie e città'.

I tre concetti presi in considerazione sono: la riconnessione con la città (contesto urbano) in relazione all'aspetto funzionale delle attività interne (percorsi e flussi), la qualità percepita da parte dell'utenza (potenziale terapeutico) e la qualità ambientale (rigenerazione urbana).

Fasi della ricerca

Facendo riferimento al quadro delle problematiche esposto, le attività che si intendono svolgere per raggiungere l'obiettivo generale, ovvero quello di indagare il ruolo dello spazio di transizione tra le strutture sanitarie e la città in relazione soprattutto alle attività svolte all'interno dell'ospedale ed il loro rapporto con il contesto urbano e la popolazione, si possono sintetizzare in cinque fasi fondamentali.

1. Scelta dei casi studio da analizzare

La scelta dei casi studio, in ambito nazionale ed europeo, si basa sulla messa a punto dell'identificazione di criteri che possano mettere in relazione le diverse strutture. Considerato l'obiettivo che si vuole perseguire in questa ricerca i criteri imprescindibili per la selezione delle strutture ospedaliere sono: il contesto urbano consolidato, la porzione di territorio occupata (es. Policlinico Umberto I, Roma, grande porzione di territorio al centro del tessuto urbano quantificabile in 160.000 mq; St. Olav's, Trondheim, Norvegia 230.000 mq), il numero di posti letto, le caratteristiche

funzionali, prediligendo nella scelta policlinici universitari per la compresenza di varie attività come ricerca, didattica, diagnosi e terapia.

I casi scelti, inseriti successivamente in schede di analisi strutturate, metteranno a sistema i diversi complessi ospedalieri secondo parametri confrontabili: inserimento nel tessuto urbano, inteso come rapporto con la viabilità, il trasporto pubblico e il contesto; la relazione della struttura con il proprio spazio esterno e la tipologia di quest'ultimo (Cooper Marcus and Barnes, 1999); l'organizzazione attuale dello spazio esterno, evidenziando la presenza di percorsi carrabili e pedonali, di elementi di arredo urbano, specie vegetazionali ed elementi artistici. La raccolta del materiale documentale e fotografico avverrà attraverso l'analisi della letteratura disponibile e visite *in situ*.

2. Definizione dei profili di utenza

Nei grandi complessi ospedalieri, specialmente se si tratta di policlinici universitari, data la compresenza di attività diverse come ricerca, didattica, diagnosi e terapia, è difficile la definizione dei profili di utenza. Avendo come obiettivo l'indagine dello 'spazio di transizione tra le strutture e la città', l'utenza si presenta ancora più eterogenea perché comprende anche i cittadini che transitano all'interno del complesso ospedaliero. In via preliminare si può suddividere l'utenza in: pazienti; visitatori/familiari; staff medico ed infermieristico; fornitori; studenti/ricercatori; cittadini.

Le strategie progettuali che si vogliono tracciare analizzando lo spazio hanno come principio guida il benessere di una vasta gamma di utenza, perseguibile tramite la garanzia della soddisfazione dei bisogni specifici della popolazione più vulnerabile.

La categoria dei pazienti quindi rappresenta l'utenza primaria da indagare in riferimento all'utilizzo dello 'spazio di transizione tra struttura e città' e al suo potenziale terapeutico nel processo di guarigione. Questi possono includere persone: in attesa di un intervento, in fase di riabilitazione che devono muoversi ed al contempo fermarsi, che hanno ricevuto trattamenti chemioterapici e potrebbero avere necessità di rilassarsi, pazienti con malattie mentali e comportamentali, anziani con problemi motori, bambini che vivono lo spazio esterno come un momento di sollievo da terapie mediche particolarmente invasive (Cooper Marcus and Sachs, 2014).

3. Strutturazione, somministrazione dei questionari e osservazione diretta dei flussi

I questionari sono strutturati per capire i bisogni e le esigenze attraverso la percezione dello spazio da parte dell'utenza, cercando di indagare le relazioni tra spazio aperto, struttura ospedaliera e tessuto urbano. L'articolazione dei questionari è basata su due modelli concettuali esistenti: l'AEDET (Achieving Excellence in Design Evaluation Toolkit) e l'ASPECT (A Staff Patient Environment Calibration Tool) entrambi sviluppati dal *Department of Health Estates and Facilities* del Regno Unito (2008) per determinare e gestire i requisiti progettuali dalle proposte iniziali alla fase di *Post Occupancy Evaluation*.

Le sezioni in cui sono divisi i modelli affrontano tematiche funzionali all'oggetto della ricerca: l'integrazione sociale e urbana; il paesaggio visto dall'interno del complesso ospedaliero, quindi come estensione dello stesso verso l'esterno; l'uso dello spazio, in questo caso esterno; gli accessi alla struttura; la *privacy*, la compagnia e la dignità garantite dallo spazio; la comprensione del luogo; la natura.

I questionari, in forma anonima, saranno somministrati in loco alle diverse categorie di utenza in numero rappresentativo stimato intorno a 100 per ogni caso studio.

Considerato che l'utenza non è sempre in grado di esprimere con i questionari le proprie esigenze per ragioni oggettive, è necessario operare attraverso l'*evidence-based research* (EBR), ovvero attivare un processo decisionale costruito su dati di ricerca scientifica attendibili al fine di raggiungere i migliori risultati possibili nell'indicare *input* di progetto in grado di soddisfare le esigenze inesprese dei fruitori.

In questo caso la tecnica di indagine sul campo mediante l'osservazione diretta, rilevando i flussi in tre momenti diversi di una giornata tipo (mattina-pomeriggio-sera) propria della ricerca qualitativa, assume un ruolo chiave. Per tale motivo è fondamentale il coinvolgimento di operatori ed altri utenti in grado di descrivere comportamenti ed abitudini dei fruitori in un contesto ambientale definito con altri strumenti propri della stessa tipologia di ricerca, come interviste strutturate, *focus group*, metodo Delphi (Giofrè, 2014).

4. Traduzione dei risultati attesi in strategie progettuali

La sistematizzazione, l'esame, la comparazione dei materiali raccolti (schede di analisi dei casi studio, risultati dei questionari, relazione sui flussi osservati in rapporto all'uso dello spazio) porteranno alla traduzione di quanto rilevato in termini di requisiti ambientali.

Si definiranno strategie di progetto e proposte operative per il miglioramento a livello organizzativo funzionale, spaziale e di qualità ambientale dei complessi ospedalieri rispetto alle attività svolte e al contesto urbano.

I risultati attesi dalla ricerca con l'analisi dei dati raccolti, si collocheranno a tre livelli: strategie progettuali di supporto al progettista, orientamento all'utente (a secondo della categoria) e strumenti di supporto all'amministrazione ospedaliera e municipale sia per la ristrutturazione sia per la nuova edificazione di strutture.

L'intento è di realizzare una socialità ed una libertà attraverso lo spazio pubblico, così come stabilito dalla 'Carta dello Spazio Pubblico per la biennale 2013' (Garau, 2013), secondo la convinzione che nell'affrontare tale tematica si debbano avere strumenti idonei che tengano in considerazione non solo i bisogni dell'utenza ma anche il delicato rapporto con il contesto urbano (inclusive design).

Stato dell'arte presupposti teorici-metodologici

I presupposti teorici-metodologici su cui si basa la ricerca si delineano attraverso la ricostruzione dello stato dell'arte delle tre tematiche, individuate come fondamentali, che ruotano attorno all'oggetto principale dell'indagine: 'lo spazio di transizione tra strutture sociosanitarie e la città'. I tre concetti presi in considerazione sono: la riconnessione con la città con particolare riferimento al contesto urbano, in relazione all'aspetto funzionale delle attività che si svolgono all'interno (percorsi e flussi); la qualità dello spazio esterno percepita da parte dell'utenza e quindi il suo potenziale terapeutico; la qualità ambientale in termini di rigenerazione urbana e sociale.

Riconnessione con la città-contesto urbano

La revisione della letteratura del XX secolo sugli ospedali evidenzia come il rapporto tra le strutture sanitarie e gli spazi aperti si è gradualmente spezzato, fino quasi a scomparire negli anni settanta. Solo negli ultimi

decenni la progettazione sanitaria, mettendo al centro i bisogni dell'utenza, ha ridato valore allo spazio aperto.

Agli inizi del novecento ogni ospedale aveva uno spazio esterno: la relazione con il contesto e il paesaggio era tenuta in grande considerazione soprattutto in termini di benefici sui pazienti (Stevens, 1918).

Contrariamente, negli anni ottanta la letteratura sull'edilizia ospedaliera (Cox and Groves, 1981) tende a non dare nessuna informazione sullo spazio esterno fermandosi alle mura dell'edificio, 'come se gli ospedali fossero sospesi in uno spazio bianco' (Marcus and Barnes, 1999, p. 16) e lo spazio esterno uno spazio annesso con l'unica funzione di parcheggio.

Le strutture sanitarie realizzate o rinnovate nella seconda metà del XX secolo seguono logiche per lo più funzionali, in contrasto con il disegno e il sistema organizzativo urbano (Gaudin, 2006), spazi ritagliati all'interno del tessuto della città, percepiti come grandi 'vuoti': 'città nella città'. Dietro le mura si celano i complessi ospedalieri, chiusi in una loro logica interna senza nessuna relazione con il tessuto urbano ed i vicini edifici, dequalificando così lo spazio pubblico dell'ospedale. L'approccio attuale, ovvero il *patient-centered-design*, guidato dal concetto di umanizzazione delle strutture ospedaliere, tende a reinserire le stesse nella città e, pertanto, con l'utilizzo dello 'spazio di transizione' le potrebbe rendere un'entità urbana e sociale come estensione del paesaggio urbano.

La reintegrazione degli ospedali nel contesto urbano può avvenire in diversi modi: condividendo i servizi che si trovano all'interno, come ristoranti e negozi (es. University Medical Centre Groningem, Olanda), oppure promuovendo iniziative che coinvolgano la comunità circostante. Ma il prerequisito per tale integrazione, funzionale e sociale, può avvenire solo attraverso una contiguità tra l'ospedale e la realtà circostante, 're-urbanizing'(Driesen, 2006, p. 106) l'ospedale restituendolo alla città (Wagenaar, 2006).

La *World Health Organization* (2013) nel documento 'Phase VI (2014-2018) of the WHO European Healthy Cities network: goals and requirements' evidenzia come l'ambiente fisico e infrastrutturale abbia un forte impatto sulla salute e sul benessere della popolazione. La pianificazione quindi dovrebbe attivare una rete di relazioni tra i servizi sanitari e l'ambiente urbano. L'obiettivo volto al miglioramento dello stato di salute e benessere delle persone, può essere quindi raggiunto con la pianificazione urbana e la promozione di azioni tese all'incremento dell'attività fisica, facilitando la mobilità delle persone con particolare riferimento agli anziani ed ai diversamente abili.

Potenziale terapeutico dello spazio esterno

Lo spazio aperto delle strutture sociosanitarie è parte del paesaggio urbano. La Convenzione Europea del Paesaggio (Council of Europe, 2000, p.2) promuove la protezione, la gestione e la pianificazione del paesaggio, considerandolo come: 'un elemento chiave per il benessere individuale e sociale'. La World Health Organization (1946, p. 1) definisce la salute come: 'stato fisico, sociale e mentale di benessere e non solamente l'assenza di malattia o infermità'. La cognizione complessiva del paesaggio e del livello della salute saranno il punto di partenza dell'indagine relativa all' influenza dello spazio aperto, in questa ricerca denominato 'spazio di transizione tra struttura sociosanitaria e città', sul benessere e la salute individuale e sociale.

Attualmente gli spazi interni ed esterni degli ospedali, progettati per l'efficienza, sono fortemente 'medicalizzati' e quindi causa di stress per pazienti, visitatori e staff; la climatizzazione interna ha spesso preso il posto della ventilazione naturale annullando l'uso di eventuali terrazze e balconi; i costi dei terreni, i limiti imposti dai regolamenti edilizi ed il fabbisogno dei parcheggi, hanno causato come risultato che nei grandi luoghi istituzionali, come gli ospedali, sia diventato una rarità avere un panorama su un'area verde (Ulrich, 1992; Malkin, 1992; Horsburgh, 1995).

Numerosi studi (Ulrich, 1981; Kaplan and Kaplan, 1989; Hartig, 1991) evidenziano viceversa il potenziale terapeutico dello spazio esterno, soprattutto se nello stesso sono previsti elementi naturali. Il contatto con la natura e la possibilità di poter usufruire di uno spazio adeguatamente concepito (Tyson, 1998; Cooper Marcus and Barnes, 1999) può provocare cambiamenti fisiologici come la regolarizzazione della pressione sanguigna ed è stato rilevato che gli effetti positivi dell'utilizzo di tale spazio si ripercuotono anche sul decorso post operatorio dei pazienti in termini di accelerazione della guarigione (Ulrich, 1991). Avere la possibilità di distrarsi anche temporaneamente aiuta ad affrontare, controllare e ridurre lo stress, oltre ad influire sulla capacità di concentrazione *Attention Restoration Theory* (ART), teoria sviluppata da Rachel e Stephen Kaplan (1989) ed aspetto molto importante soprattutto per lo staff medico. Lo spazio esterno, facilmente accessibile, favorisce ed incoraggia, inoltre, la presenza delle famiglie dei pazienti consentendo quindi un benefico sostegno agli stessi. Dal punto di vista psicologico riconoscere 'lo spazio di transizione tra ospedale e città' come ambiente di supporto e filtro con il contesto urbano, consente la percezione da parte dei pazienti del mondo esterno, non elidendo quel legame essenziale per il processo di guarigione. L'eliminazione

delle caratteristiche ambientali che hanno un riconosciuto impatto negativo, non solo sui pazienti ma anche sullo staff medico, le famiglie e i cittadini, potrebbe cambiare l'immagine ostile dell'ospedale: da 'fortificazione medica' (Nedučín, Krklješ and Kurtović, 2010) a spazio di inclusione ed accettazione. Affinché questo avvenga, uno dei punti principali della progettazione ospedaliera dovrebbe essere quello di integrare funzionalmente questo spazio con la struttura ospedaliera e la città, eleggendolo a tutti gli effetti come terapeutico.

Rigenerazione urbana e sociale

Le strutture sociosanitarie, per estensione e tipologia di attività connesse, hanno un notevole impatto sulla qualità ambientale urbana.

La Green Guide for Health Care (2008), con l'obiettivo di proteggere e migliorare la salute degli individui e della comunità, ha sviluppato un *toolkit* di valutazione specifico per le strutture sanitarie, che ingloba anche requisiti LEED (Leadership in Energy & Environmental design).

Nella sezione *Sustainable Site management* viene sottolineato come un ecosistema sano, la qualità dell'aria e dell'acqua, contribuisca in modo determinante alla salute delle persone. E' importante conservare le aree naturali esistenti e risanare quelle degradate preservando l'*habitat*, promuovendo la biodiversità, difendendo la vegetazione esistente ed incrementandola con specie autoctone, per creare quei benefici sociali, psicologici e fisici che derivano dalla relazione visiva e tangibile con l'ambiente naturale. La tutela del suolo permeabile, mitigando l'effetto 'isola di calore', ha un notevole impatto sul microclima e sull'*habitat* umano e animale; infatti dagli studi esaminati (Environmental Protection Agency, 2013) si rileva come diminuendo la temperatura del suolo si riducono le difficoltà respiratorie e la necessità di raffrescamento degli edifici circostanti. Lo spazio esterno delle strutture ospedaliere, integrato con il sistema del verde urbano, contribuisce all'inclusione della struttura nel contesto ed interviene sulla qualità ambientale innescando quei processi di rigenerazione che incidono sulla prerogativa urbana e sociale in termini di qualità delle relazioni umane. Lo spazio di transizione dei complessi ospedalieri può assumere dunque un ruolo importante per la salvaguardia dell'ecosistema naturale in area urbana acquisendo quei requisiti necessari affinché possa diventare parte vitale (Gehl, 2011) del paesaggio urbano con risonanze positive sulla comunità circostante.

Ben Bolgar, capo progettista dalla Prince's Foundation di Londra, durante un workshop tenuto per la progettazione dell'Alder Hey Hospital a

Liverpool, spiega come un ospedale possa rigenerare un'area: 'se lo chiamate *the children's hospital* vi focalizzate sull'oggetto, ma se lo chiamate *children's health park* vi focalizzate sul *public realm* e sul luogo' (Smedley, 2013).

Gli obiettivi della progettazione finalizzati all'integrazione della struttura nel tessuto urbano potranno, perciò, rappresentare l'espressione più alta di 'civic pride' (Milburn, 2001) per l'intera comunità.

Conclusioni

Il concetto di salute, legato al mantenimento del suo stato piuttosto che al trattamento della malattia, guida l'importanza del progetto ed è un aspetto che, inserito nel quadro globale, può portare anche benefici economici in termini di minore pressione sul servizio sanitario nazionale.

Un ritorno di interesse sullo stato di salute dei cittadini è dato dall'integrazione dei complessi ospedalieri attraverso il lavoro sullo 'spazio di transizione'. La realizzazione o ristrutturazione di ospedali che abbiano un'interfaccia con il contesto, non più torri circondate da parcheggi e separate dalla comunità, ma spazi inclusivi può incoraggiare l'utilizzo degli stessi da parte dei residenti, stimolandone, inoltre il movimento ed incentivando quindi uno stile di vita più sano (Kovacs and Silvis, 2014).

Lo spazio esterno può influenzare anche da un punto di vista qualitativo la *performance* dello staff medico incidendo significativamente sulle capacità di concentrazione e di gestione dello stress (Ulrich et al., 2008). Questo fattore, come precedentemente evidenziato, avendo notevoli effetti terapeutici e rilevanti ricadute positive sul processo di guarigione dei pazienti, incide in maniera consistente sulla gestione economica ospedaliera. Inoltre, il miglioramento della qualità ambientale, incentivando l'uso di risorse naturali e favorendo un ambiente sano, riduce l'utilizzo del sistema di climatizzazione incidendo notevolmente sull'abbattimento dei costi di esercizio.

Tra gli effetti più significativi, pertanto, si registrano la riduzione dei giorni di ricovero, il minore utilizzo di medicinali, l'incremento qualitativo delle prestazioni dello staff medico con conseguente maggiore soddisfazione e fiducia dell'utenza.

Includendo, perciò, il contributo potenziale del ruolo dello 'spazio di transizione tra struttura e città' nel processo di riqualificazione ed avviando un nuovo processo di edificazione dei complessi ospedalieri attraverso un approccio progettuale olistico, si potranno abbattere i costi aggiuntivi e

valutare l'intervento nel lungo termine principalmente per i benefici che potrà produrre.

References

- Cooper Marcus, C. and Barnes, M. (1999) *Healing Gardens: Therapeutic Benefits and Design Recommendations*. New York: John Wiley & Sons.
- Cooper Marcus, C. and Sachs, N.A. (2014) Design Outdoor Spaces to Fit Specific Patient Population. *Healthcare design*. Available from: <http://www.healthcaredesignmagazine.com/article/designing-outdoor-spaces-fit-specific-patient-populations> [Accessed: 23rd April 2014].
- Council of Europe (2000) *European Landscape Convention CETS No.176*. Florence: Council of Europe.
- Cox, A. and Groves, P. (1981) *Design for Health Care*. London: Butterworth Architecture.
- Driesen, G. (2006) *A strategy for Re-urbanizing hospitals*. In Wagenar, C. (eds.), *Architecture of Hospital*. Rotterdam: Nai Publisher.
- European Commission for Horizon 2020 (2013) *Call: Overcoming the crisis: New Ideas, Strategies and Governance Structures for Europe*. Topic: ERA-NET on Smart Urban Futures. EURO-5-2015.
- Foucault, M. (1993) *Naissance de la Clinique*. Paris: Presses Universitaires de France.
- Foucault, M. (1979) *Les machine à guérir: aux origines de l'hôpital moderne*. Bruxelles: Pierre Mdraga.
- Garau, P. (2013) *Carta dello Spazio Pubblico per la Biennale*. Roma: La Biennale dello Spazio Pubblico, 18th of May. Available from: <http://www.biennalespaziopubblico.it/>[Accessed: 1th June 2014]
- Gaudin, B. (2006) *The Hospital and the City*. In Wagenar, C. (eds.), *Architecture of Hospital*. Rotterdam: Nai Publisher.
- Gehl, J. (2011) *Life between buildings: using public space*. Washington: Island Press.
- Gelser, W.M. (2005) Therapeutic landscapes: an evolving theme. *Health and Place*, 11 (4), 295-297.
- Giofrè, F. (2014) Autismo: la costruzione dello spazio abilitante per il 'non standard'. (*H)ortus*. Available from: <http://www.vg-hortus.it/> [Accessed: 2nd April 2014].
- Green Guide for Health Care (2008). *Sustainable Site*. [Online] 2013. Available from: <http://www.gghc.org/tools.2.2.design.php> [Accessed: 4th April 2014].

- Harting, T., Mang, M. and Evans, G.W. (1991) Restorative Effects of natural Environments Experiences. *Environmental and Behaviour*, 23 (1), 3-26.
- Horsburg, C.R. (1995) Healing by Design. *The New England Journal of Medicine*, 11 (333), 735-740.
- Kaplan, R. and Kaplan, S. (1989) *The experience of nature: a psychological perspective*. New York: Cambridge University Press.
- Kovacs Silvis, J. (2014) Look Outside: Supporting Wellness Through Healthcare Campus Planning. *Healthcare Design Magazine*. Available from: <http://www.healthcaredesignmagazine.com/blogs/jennifer-kovacs-silvis/look-outside-supporting-wellness-healthcare-campus-planning> [Accessed: 7 April 2014].
- Malkin, J. (1992) *Hospital interior architecture*. New York: Van Nostrand Reinold.
- Milburn, A. (2001) *Speech at Building a Better Patient Environment*. NHS/Prince's Foundation Conference 16th November. Available from: http://www.nnah.org/information/transcripts/milburn_patients.html [Accessed: 29th April 2013].
- Nedučín, D., Krklješ, M. and Kurtović-Folić, N. (2010) Hospital Outdoor Space – Therapeutic benefits and design consideration. *Architecture and Civil Engineering*, 8 (3), 239-305.
- Sack, R.D. (1986) *Human territoriality: Its theory and History*. Cambridge: Cambridge University Press.
- Smedley, T. (2013) Alder Hey pushes the boundaries of hospital design. *Guardian sustainable business blog*. Available from: <http://www.theguardian.com/sustainable-business/blog/alder-hey-hospital-childrens-health-park-design> [Accessed: 10 April 2014].
- Stevens, E.F. (1918) *The American Hospital of the Twentieth Century: A Treatise on the Development of Medical Institution, Both in Europe and in America Since the Beginning of the present Century*. New York: Architectural Record Publishing Company.
- Tyson, M. (1998) *The Healing Landscape: Therapeutic Outdoor Environments*. New York: McGraw-Hill.
- Ulrich, R.S. (1981) Natural versus Urban Scenes: Some Psychophysiological Effects. *Environment and Behaviour*, 13 (5), 523-556.
- Ulrich, R.S. (1984) View through a window may influence recovery from surgery. *Science*, 224 (4647), 420-421.
- Ulrich, R.S. (2001) *Effects of Interior Design on Medical Outcomes*. Paper Presented at the Proceedings of Second Conference on Design and Health. Stockholm, Sweden.

- Ulrich, R.S., Simons, R.F., Losito, B.D., Fiorito, E., Miles, M.A. and Zelson, M. (1991) Stress recovery during exposure to natural and urban environment. *Journal of Environmental Psychology*, 11 (3), 201-230.
- Ulrich, R.S., Zimring, C., Zhu, X., DuBose, J., Seo, H.B., Choi, Y.S., Quan, X. and Joseph, A. (2008) A Review of the Research Literature on Evidence-Based Healthcare Design. *The Centre for Health Design*, 1 (3), 61-125.
- United Kingdom. Department of Health. (2008) *Achieving Excellence Design Evaluation Toolkit documentation*. London: DH Estates and Facilities.
- United Kingdom. Department of Health. (2008) *A Staff and Patient Calibration Toolkit Workbook*. London: DH Estates and Facilities.
- U.S. Environmental Protection Agency. (2013) *Heat Island Effect*. [Online] August 2013. Available from: <http://www.epa.gov/hiri/index.html> [Accessed: 1th May 2014].
- Wagenaar, C. (eds.) (2006) *Architecture of Hospital*. Rotterdam: Nai Publisher.
- World Health Organization (1946) *Constitution of the World Health Organization*. Geneva: WHO.
- World Health Organization (2013) *Phase VI (2014-2018) of the WHO European Healthy Cities network: goals and requirements*. Copenhagen: WHO regional Office for Europe.



Design partecipato e pratiche della sicurezza nei cantieri

Silvia PERICU*

Università degli Studi di Genova

La costruzione di una coscienza condivisa del lavoro in sicurezza nei cantieri edili vede coinvolta la ricerca scientifica nella individuazione di nuove strategie per l'azione attiva e la partecipazione dei lavoratori, quali atti fondativi nella definizione dei processi e nel potenziamento dell'efficacia delle strategie messe in atto ai fini della prevenzione del rischio. La ricerca presentata propone un metodo applicato di design partecipato sul redesign di dispositivi di protezione individuale e di attrezzature indossate dal lavoratore per garantirne la protezione e per prevenire le malattie professionali, partendo dall'ascolto dei lavoratori stessi e dall'analisi delle principali problematiche connesse al comparto edile. Cosa accade se i designer/progettisti ripensano i dispositivi impiegati nei cantieri e immaginano il progetto coinvolgendo direttamente i lavoratori/utenti che debbono mettere in atto le pratiche della sicurezza? Lavoratori e designer possono cercare insieme nuove strade di collaborazione e confronto per progettare gli apparati della sicurezza e sperimentare nuovi strumenti, in una logica dove il lavoratore reinventa le sue pratiche, dove il progettista incontra il mondo del cantiere e della trasformazione della città per rileggerne le regole in modo creative.

Keywords: Design; sicurezza; cantieri; user studies

Introduzione

La sicurezza è un concetto che, nella prassi delle costruzioni edili, ha visto affermarsi progressivamente nel corso degli ultimi anni una logica programmatoria volta alla prevenzione dei rischi, creando così un forte punto di contatto con il mondo scientifico della valutazione e della programmazione, e rendendo la prevenzione dei rischi un tassello fondamentale su cui orientare le politiche organizzative del cantiere.

* Corresponding author: Silvia Pericu | e-mail: pericu@arch.unige.it

Dall'idea di risarcimento del danno dell'infortunato di inizio secolo scorso si è passati all'affermarsi della logica della prevenzione degli anni '50, per arrivare alla rivoluzione dettata dalla normative europee negli anni '90 con l'introduzione del progetto della sicurezza come elemento strettamente legato alla qualità edilizia (Giofrè, 2010). Questi passaggi hanno legato indissolubilmente la ricerca scientifica al mondo della sicurezza dei cantieri edili. Lo spostamento dell'attenzione per la prevenzione del rischio a monte del processo produttivo ha imposto una duplice necessità: da una parte quella di definire ruoli, responsabilità e organizzazione di un sistema, ora sempre più industrializzato, e dall'altra quella di raccogliere e programmare obiettivi, valutare risultati e innovare strumenti sul breve e lungo termine per innescare un cambiamento che deve essere, innanzitutto, culturale. Il mondo della ricerca scientifica accompagna il progetto della sicurezza grazie alla sua visione sistemica, cercando di valutare passo dopo passo i risultati di un processo culturale, che ha i propri tempi di maturazione, nonostante l'emergenza in termini di costi sociali ed economici rappresentata dalla realtà degli infortuni e degli incidenti sul lavoro del comparto edile. Non è certamente possibile produrre senza infortuni, ma la ricerca scientifica può essere decisiva per sconfiggere nel lungo periodo le cause strutturali, che fanno del processo produttivo una situazione di rischio attraverso un cambiamento culturale radicale a livello di consapevolezza individuale degli operatori e dei cittadini. In parallelo con la strategia di lungo periodo il carattere emergenziale del problema impone nell'immediato l'attuazione di politiche pubbliche per orientare il cambiamento, quali sono, ad esempio, la repressione delle violazioni, il controllo dei cantieri, l'incentivazione delle buone prassi nell'adozione di disposizioni normative antinfortunistiche e l'affermazione della costo della sicurezza come obbligo all'interno del processo produttivo. Tutte queste azioni perdono la propria incisività se non incluse in un processo di più ampio respiro volto ad incidere su atteggiamenti e fattori culturali. La ricerca in svolgimento all'interno del Dipartimento di Scienze dell'Architettura della Scuola Politecnica dell'Università degli Studi di Genova si orienta sulla linea dell'individuazione di strategie di lungo termine per adeguare la consapevolezza individuale di chi opera nel mondo del cantiere, rivolgendosi alla dimensione interna del cantiere e alla condivisione di questi temi presso le categorie degli addetti ai lavori, tecnici e operai in modo da contribuire ad aumentare la sensibilità collettiva sui temi della sicurezza e diffondere a livello generale la cultura della prevenzione sul lavoro. Da questo punto di vista la distanza esistente

fra le prescrizioni normative e le pratiche seguite nella realtà operativa dei cantieri impone una lettura approfondita della realtà della produzione edile in Italia. Nel fare ciò occorre anche mettere in evidenza le specificità di un comparto che ne possiede moltissime e, soprattutto oggi, segnato da una profonda crisi, che ha portato a una contrazione delle capacità contrattuali dei lavoratori e all'accentuarsi di una forte linea di demarcazione tra le imprese di una certa dimensione, che possiedono già apparati consistenti e competenti in materia di sicurezza sul lavoro, e le piccole medie imprese che appaiono maggiormente in balia degli eventi.

I dati del comparto edile

A questo stato di fatto corrispondono quadri statistici di dati del comparto edile e dell'andamento antinfortunistico che restituiscono il fenomeno in atto in Italia, e da cui si evince che l'occupazione è stata in crescita nei primi anni duemila per poi arrestarsi negli ultimi anni con una rilevante perdita di imprese e di occupati nel settore delle costruzioni in seguito alla crisi economico-produttiva.

La lettura di questi dati si rende necessaria per una piena comprensione degli effetti derivanti dall'adozione delle norme sulla sicurezza introdotte dagli anni '90, e del livello di consapevolezza acquisito da chi deve mettere in atto le pratiche della sicurezza.

L'effetto della rimodulazione dei rapporti di lavoro ha indubbiamente portato a un aumento dei lavoratori autonomi: sono in progressiva crescita, sia la quota di lavoratori autonomi sul totale dei lavoratori, sia la quota di aziende di lavoratori autonomi sul totale delle aziende del settore (Agnesi et al., 2010). A fronte di ciò, negli ultimi cinque anni si è verificato un andamento decrescente degli infortuni sul lavoro in tutti i settori, con un valore più accentuato per l'edilizia, soprattutto per effetto della riduzione degli addetti.

I dati Inail (Inail, 2013) hanno evidenziato come, sul totale degli infortuni accaduti e riconosciuti nel triennio 2008-2010, il 16% appartenga al settore edile; tale quota risulta in calo di due punti percentuali rispetto al valore del precedente triennio 2006-2008. Se ci si riferisce ai soli eventi mortali nello stesso periodo, la quota attribuibile al settore è del 31%, una percentuale sul totale degli infortuni più alta rispetto ad ogni altro comparto: il 10,1% contro 6,5% nel caso di infortuni con esiti permanenti e il 0,3% contro 0.1% nel caso di infortuni mortali.

Appare, quindi, evidente come il mondo delle costruzioni continui ad essere caratterizzato da un'elevata frequenza infortunistica, a cui si accompagna un'elevata gravità, e come la crescita della quota di lavoratori

autonomi comporti un aumento dei rischi di infortunio, in quanto tale categoria di lavoratori non possiede le competenze che possono derivare dall'appartenenza a organizzazioni produttive più complesse e di conseguenza maggiormente controllate.

In questo panorama il Piano Nazionale di Prevenzione in Edilizia 2009-2011, poi esteso al 2013, la cui finalità era la riduzione degli infortuni, in particolare di quelli mortali e gravi, ci dà una lettura dell'andamento infortunistico nelle diverse regioni con un trend in discesa, sia considerando il totale degli eventi, sia sul sottoinsieme di eventi più gravi. Il solo anno 2011 segna, però, un'inversione di tendenza in particolar modo per ciò che concerne gli infortuni gravi: il dato risulta particolarmente allarmante, in quanto al calo di addetti del settore corrispondono valori stazionari degli infortuni e in almeno un terzo delle regioni si registra addirittura un aumento. Le variabili di contesto, che possono avere portato a questi risultati, sono con ogni probabilità da imputarsi ad una distribuzione di lavoratori stranieri, di lavoratori autonomi e/o irregolari molto diversificata nelle regioni italiane, determinanti di rischio tali da rendere la situazione italiana ancora molto critica rispetto ad altri paesi europei. Occorre, inoltre, ricordare la consistente componente dell'occupazione in nero, che in questo settore oscilla intorno al 40% della manodopera regolarmente assunta.

A mettere a rischio i lavoratori edili non sono solo le ricorrenze di infortuni gravi, ma anche le malattie professionali, che, seppure registrate dal sistema previdenziale nazionale, hanno in questo settore una percezione di rischio pressoché assente, perché è scarsa la consapevolezza del pericolo rappresentato da sostanze nocive, così come delle problematiche derivanti dalla movimentazione manuale dei carichi.

L'approccio normativo prevalente basato sul binomio prescrizione/sanzione ha, quindi, generalmente condotto a un irrigidimento delle prescrizioni e all'incremento delle sanzioni, senza operare un aumento di consapevolezza significativo nella classe dei lavoratori edili. E' anzi diffusa tra gli addetti l'idea che la sicurezza sia diventata più un business di formalità praticamente avulse dalla situazione specifica del lavoro, piuttosto che un'esigenza comunemente sentita e pratica applicata.

L'esperienza sul campo ha evidenziato come le prassi di comportamento adottate dagli operatori, soprattutto nelle realtà minori, nei cantieri privati e di piccole dimensioni, si discostino ancora dalle procedure previste dalle norme. Piani di sicurezza operativi fotocopiati su fogli che non vengono mai

letti e finalizzati ai soli controlli, sono ormai la procedura tipica delle piccole realtà del nostro territorio nazionale.

In questo scenario l'introduzione di ulteriori prescrizioni, controlli e sanzioni non serve, ma altresì rischia di incentivare atteggiamenti negativi ed elusori, come sembra suggerire la lettura dei dati relativi agli ultimi anni che vedono nel settore dell'edilizia una diminuzione degli incidenti piuttosto limitata a fronte di un lavoro immane e capillare di controllo e vigilanza nei cantieri di tutto il territorio nazionale.

In questo quadro sono, invece, risultati di maggiore efficacia i percorsi formativi volti all'aumento delle competenze, sia di chi opera, sia di chi controlla, realizzati in questi anni congiuntamente alle campagne di controllo sul territorio.

Il lavoratore attivo

La distanza tra gli obiettivi e i risultati raggiunti è tale da rendere necessaria l'individuazione di strategie per la riduzione del rischio capaci di stimolare la sensibilità collettiva su questi temi all'interno e all'esterno del cantiere.

La considerazione, che sottende le scelte legislative ovvero l'impossibilità di raggiungere un livello di 'rischio zero' (Beck, 2000), ha portato nelle introduzioni normative degli anni '90 alla definizione del lavoratore quale soggetto attivo e partecipe di un nuovo approccio gestionale per il contenimento dei rischi.

Oggi più che mai la necessità di declinare nuove strategie di comunicazione, intercomunicazione, informazione e valorizzazione del cantiere deve ripartire da un modello che va verso una coscienza condivisa del lavoro in sicurezza, attraverso l'azione attiva e la partecipazione dei lavoratori, in linea con le linee guida promosse dall'Agenzia Europea per la Salute e Sicurezza sul Lavoro, EU-OSHA.

Se, quindi, immaginiamo la normativa sulla sicurezza rivolta a un utente finale che è il lavoratore, la partecipazione e l'interazione di quest'ultimo devono diventare atti fondativi nella definizione dei processi e nel potenziamento dell'efficacia delle strategie messe in atto ai fini della prevenzione del rischio.

L'approccio partecipativo al tema della sicurezza deve partire da un'accurata analisi dei rischi, delle procedure e dei conflitti esistenti all'interno del cantiere, da realizzare congiuntamente ai lavoratori, per arrivare a definire insieme a loro pratiche più adatte, sia a livello di utilizzo di dispositivi, che a livello di procedure di sicurezza.

Comprendere appieno le dinamiche dei processi di lavorazione grazie a chi le mette in atto permette l'individuazione di linee di azione più adeguate alle esigenze e alle contingenze reali e, dunque, potenzialmente più efficaci.

La Direttiva Cantieri dell'Unione Europea, all'articolo 12, dedica ampio spazio al tema della consultazione e partecipazione dei lavoratori nella gestione della sicurezza, ed è finalizzata a favorire un adeguato coordinamento tra i lavoratori e i loro rappresentanti all'interno delle imprese, affinché regole e prassi, oggi scollegate dalla realtà operativa, possano acquisire maggiore aderenza alla realtà. L'attività di ascolto e osservazione sul campo si pone come obiettivo la ricostruzione dei comportamenti reali degli operatori, mettendo al centro l'individuo, in quanto utente, e riferendosi alla sua cultura e al valore che dà al proprio lavoro. Da una parte il processo formativo, se seguito scrupolosamente, è in grado di modificare comportamenti e, soprattutto, di permettere l'acquisizione della consapevolezza di diritti e doveri e dei rischi che si corrono; mentre dall'altra l'ascolto permette di capire cosa pensano i lavoratori e i loro datori di lavoro, favorendo il dialogo e cercando di approfondire i significati delle loro rappresentazioni, perché, seppur in molti casi contraddittori, corrispondono spesso a effettivi comportamenti.

Nella riprogettazione della strategia antinfortunistica le attività rivolte principalmente al lavoratore, quali l'ascolto e la formazione, seppur di sicura efficacia, non possono essere sufficienti, se non coordinate con strategie più generali: bisogna, infatti, sempre considerare come a concorrere nel fenomeno infortunistico siano sia fattori esogeni, che fattori endogeni (Terranova, 2010), che debbono essere affrontati contestualmente. Tra i principali fattori esogeni vi sono la spesso scarsa forza contrattuale dei lavoratori e la riorganizzazione di un sistema complesso di relazioni in cui convivono precarietà, lavoro nero, le logiche dei subappalti, ricattabilità, competitività e spesso ritmi incontrollabili.

L'acquisizione di conoscenze adeguate rimane in ogni caso fattore indispensabile per la prevenzione del rischio, in quanto la consapevolezza del rischio e la disponibilità di dispositivi adatti a tal fine aumenta la volontà di prevenirlo, come si è dimostrato ad esempio nella campagna per l'uso del casco obbligatorio per i motocicli condotta negli anni '80 in Italia.

Obiettivi della ricerca

Individuate l'emergenza del settore delle costruzioni e alcune istanze connesse alla peculiarità del settore, la ricerca presentata propone la

definizione di un metodo applicato che, partendo dall'ascolto dei lavoratori del settore edile quali utenti di riferimento, avvii un processo di design partecipato in questo determinato contesto, arrivando a coinvolgere lavoratori, designer e aziende del settore dell'antifortunistica per innovare e rendere più efficienti i dispositivi di protezione individuale e le attrezzature indossate dal lavoratore nel cantiere edile a livello di usabilità e a livello di percezione da parte degli utenti finali. Il metodo proposto si attua progressivamente in due fasi, partendo dall'ascolto dei lavoratori attraverso interviste condotte nei cantieri, per arrivare allo svolgimento di un workshop progettuale quale pratica di design di interazione con l'utente finale.

Metodologia

L'attività di ascolto si è svolta nel territorio genovese nell'inverno 2014 attraverso interviste a 40 addetti di cantiere edili di piccole e medie dimensioni. Precedentemente nello stesso territorio aveva avuto luogo nel 2008 un'importante indagine commissionata da Inail Liguria e Regione Liguria all'Università di Genova - responsabile scientifico Salvatore Palidda - in cui erano stati somministrati questionari aperti e interviste a 530 tra lavoratori, datori di lavoro e addetti alle procedure della sicurezza del mondo del lavoro ligure, per capire cosa effettivamente pensassero delle malattie e degli infortuni.

L'attività del 2014 non può essere scissa dal lavoro di indagine che la precede, in quanto i risultati ottenuti nella precedente e più ampia ricerca, che andava ad investire anche la realtà dei lavoratori edili in una misura di circa il 30% di tutte le interviste, ne costituiscono il presupposto nell'individuazione dei soggetti da intervistare. L'indagine del 2008 aveva messo in luce l'evidenza che la rappresentazione della sicurezza tra i lavoratori fosse diversificata in due fasce disomogenee: da una parte una sicura e tutelata, prevalentemente legata a realtà di organizzazione del lavoro più grandi, che ha beneficiato delle normative entrate in vigore negli ultimi anni, e dall'altra una seconda più esposta ai rischi, perché più debole e costretta ad accettare condizioni di lavoro insicure. E' evidente, quindi come l'aumentare progressivo degli ultimi anni di condizioni di lavoro irregolari con tipologie contrattuali atipiche, la presenza del lavoro nero, di subappalti e di manodopera di lavoratori immigrati abbiano reso la classe dei lavoratori edili una fascia ancora debole. Sono stati, quindi, scelti in qualità di testimoni privilegiati lavoratori edili appartenenti a piccole medie imprese in cantieri di piccole dimensioni, che in questo caso si riteneva dovessero avere circa meno di 20 operai addetti. Le 40 interviste, realizzate dal gruppo di

lavoro del DSA, sono state ripartite in egual misura su lavoratori edili di due fasce di età tra i 20 e i 40 anni e tra i 40 e i 60 anni, e si sono svolte sotto forma di colloquio libero.

Le interviste sono state condotte negli uffici di cantiere in diversi siti della città e si sono svolte in forma di completo anonimato. Sono state rese possibili grazie allo stabilirsi di un rapporto di empatia e complicità tra l'intervistato e l'intervistatore, che ha sempre reso manifeste in modo completo le finalità della ricerca e dell'utilità che la testimonianza del lavoratore poteva avere nel trovare soluzioni innovative a criticità da lui rilevate. Un approccio adottato nel primo gruppo di 10 interviste prevedeva di proporre all'intervistato di definire almeno tre situazioni di criticità e tre situazioni positive nella realtà del cantiere, mentre l'intervistatore prendeva nota su di una scheda delle risposte e solo alla fine poneva le domande più dirette e personali relative ad età, mansioni lavorative e posizione nell'impresa edile. Queste prime interviste si sono, però, rivelate prevalentemente condizionate da una presunta forzata complicità del lavoratore con il datore di lavoro nel dover dimostrare sempre e comunque una piena adesione all'applicazione delle norme, perché, essendo condotte sul luogo di lavoro e in piena attività lavorativa, i lavoratori si sentivano in dovere di difendere le linee di condotta dell'impresa a cui appartenevano.

E' stata, quindi, variata la modalità delle interviste successive, che sono state condotte lontano dai cantieri, in cui i lavoratori risultavano impiegati per ovviare al problema individuato, ed è stato corretto il tiro rispetto all'approccio delle interviste iniziali, in quanto, riferendosi alla realtà del cantiere in generale, risultava difficile per gli intervistati visualizzare facilmente situazioni reali ed entrare nello specifico dell'utilizzo dei dispositivi di protezione individuale.

Si è chiesto agli intervistati di definire in modo più mirato per parole chiave criticità e punti di forza rispetto all'uso dei dispositivi di protezione individuale nelle situazioni da loro stessi individuate, ovvero descrivere in modo sintetico elementi positivi e negativi relativi alla loro esperienza personale nell'utilizzo di elmetti protettivi, guanti, occhiali, cuffie, calzature, mascherine, ecc.

Da questo lavoro più specifico, finalizzato a capire e leggere i bisogni dell'utente, sono stati definiti alcuni temi o campi di necessità sulla base delle parole chiave emerse dalle interviste, come punto di partenza per organizzare un'attività di progetto, che si è svolta nel giugno 2014, all'interno di un laboratorio coordinato dal gruppo di lavoro del Corso di

Laurea in Design della Scuola Politecnica sul tema dei Dispositivi di Protezione di Individuale - DPI.

Riassumendo brevemente i risultati emersi dal lavoro delle interviste rispetto al tema più generale della sicurezza, la maggior parte degli intervistati ha confermato un'impressione positiva di miglioramento negli ultimi venti anni per il maggior accento posto da più parti sulla prevenzione e sulla sicurezza nel luogo di lavoro, ma allo stesso tempo sono state riconosciute, quali situazioni di pericolo, quasi esclusivamente le cadute dall'alto e i lavori su ponteggi, trascurando qualsiasi altra fonte di pericolo se non quelle più evidenti.

Rispetto al tema specifico dei DPI sono emerse con chiarezza alcune problematiche rilevanti: soprattutto nel gruppo dei lavoratori più anziani prevale la mentalità per cui gli infortuni sul lavoro siano nella maggior parte dei casi una mera fatalità, di conseguenza prevale un'avversione all'uso dei DPI, perché considerati come impedimenti nello svolgere velocemente la propria prestazione individuale. Dai caschi che si sfilano dalla testa quando ci si china, alle cinture di tenuta che impediscono di svolgere le lavorazioni necessarie, sono state illustrate dagli intervistati di tutti e due i gruppi le situazioni in cui i DPI risultano maggiormente limitanti, e soprattutto è emersa a livello generale una sensazione di sfiducia, per cui il lavoratore non sente di poter decidere per conto proprio quando indossare il casco e quando no, e vive l'uso del casco come un'imposizione. E', infatti, ritenuto inutile doverlo indossare continuamente, quando si sta lavorando alle opere di scavo e fondazione di una costruzione, confermando così l'idea per cui questo dispositivo, più di altri, diventa oggetto simbolo della propria sensazione di impotenza.

Un altro tema di grande interesse emerso è legato all'incapacità da parte del lavoratore di considerare i DPI ai fini della protezione dal rischio di contrarre malattie professionali: solo pochi intervistati hanno individuato come attività pericolose quelle che comportavano rumori forti, inalazione di sostanze nocive, polveri, inquinamento dell'aria o movimentazioni di carichi, dimostrando come la percezione del rischio legato alle malattie professionali sia pressoché assente nel settore edile. Solo i traumi di ogni genere, in forma di incidente o addirittura morte, sono riconosciuti come pericoli possibili, mentre viene sottostimata la possibilità di ammalarsi per attività svolte sul luogo di lavoro. La ragione che sottostà a questa nemesi è complessa e può essere legata al fatto che socialmente la malattia professionale non viene ancora sufficientemente riconosciuta o comunque viene ancora considerata un costo necessario del lavoro, tema molto critico

in un settore in crisi e in questo momento maggiormente soggetto a ricattabilità.

Indossare la sicurezza: il workshop

Dal lavoro condotto sulla rilettura delle interviste attraverso le parole chiave sono emerse alcune questioni aperte su cui poter orientare l'attività di redesign di Dispositivi di Protezione Individuale più idonei all'uso e da utilizzare per proteggersi dai traumi e per ridurre i rischi di malattie professionali. La necessità di incidere sui modi per implementare l'effettivo uso di questi dispositivi, è confermata dai dati Inail del 2012, per cui nel settore costruzioni sono stati indennizzati 43.729 infortuni, che nel 25% dei casi sono dovuti a contusioni, nel 24% a lussazioni e nel 23% a ferite, che per lo più interessano gli arti superiori e le mani, ma anche la testa, rivelandosi in un caso su due mortali.

Il workshop con gli studenti è partito dall'idea che i dispositivi del lavoro si possono orientare alla prevenzione in questo campo, dove, insieme alla prevalente ipoacusia da rumore, stanno rapidamente incrementando le patologie muscolo-scheletriche legate ai rischi da sforzi ripetuti e da movimentazione manuale dei carichi, e altre malattie quali le dermatiti da contatto, le patologie da strumenti vibranti e le malattie respiratorie, in particolare conseguenti all'amianto.

In questo campo l'attività di formazione gioca un ruolo fondamentale per creare maggiore consapevolezza nel lavoratore e disporlo alle adeguate protezioni, ma ripensare i prodotti della sicurezza e innovarli con nuove tecnologie può rendere disponibili attrezzature più seduttive e, allo stesso tempo, adatte a contenere i rischi. Grazie alle nuove tecnologie oggi abiti e accessori da lavoro sono sempre più performanti, sia dal punto di vista dei materiali, che delle forme, e sono dotabili di sensori e interfacce che li rendono sempre più efficienti. Il futuro vede, dunque, gli accessori diventare una sorta di protesi tecnologica, avvolgenti e comodi da usare, sempre più funzionali ed intelligenti, veicoli di messaggi, ma anche adattabili alle diverse esigenze.

Si apre uno scenario in cui gli abiti del lavoro, i dispositivi di protezione individuale non sono solo più strumenti imposti al lavoratore, ma possono assumere una valenza linguistica, 'un corpus di oggetti protesici che tutelano, ma, spesso, anche implementano e mutano il nostro corpo' (Crippa et al., 2013), in quanto anche l'abbigliamento antinfortunistico con i suoi requisiti di praticità, e comfort, non sfugge alle più sofisticate

interpretazioni sociologiche legate alle forme e ai significati dell'abbigliamento.

DPI

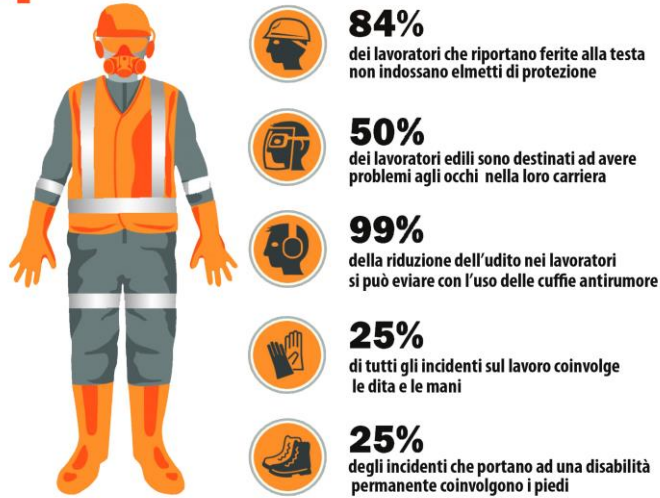


Immagine 1

Infografica sulla prevenzione degli infortuni e delle malattie professionali grazie all'uso dei Dispositivi di Protezione Individuale.

Ricerca-azione: i risultati

Cosa accade se i designer/progettisti ripensano i dispositivi impiegati nei cantieri e immaginano il progetto coinvolgendo direttamente i lavoratori/utenti che debbono mettere in atto le pratiche della sicurezza?

Lavoratori e designer possono cercare insieme nuove strade di collaborazione e confronto per progettare nuovi apparati della sicurezza e nuovi strumenti, in una logica dove il lavoratore reinventa le sue pratiche, dove il progettista incontra il mondo del cantiere e della trasformazione della città per rileggerne le regole in modo creativo.

L'attività di progetto del workshop svolto all'interno del Corso di Laurea in Design del Prodotto e della Nautica del DSA, insieme a circa venti studenti, ha cercato di dare alcune risposte a questi temi attraverso due fasi distinte: (i) il *focus* sugli utenti, realizzato attraverso la lettura per parole chiave delle interviste, in cui il lavoro svolto dal gruppo di ricerca nei cantieri è stato condiviso con gli studenti, analizzando le principali questioni emerse relativamente all'uso dei DPI. In questa prima fase sono stati chiamati a

partecipare al workshop lavoratori edili che si occupano di edilizia in quota con tecniche alpinistiche, per poter analizzare insieme agli studenti i temi emersi sull'uso dei DPI, mostrare i dispositivi e le procedure di sicurezza dei lavori in quota e valutare insieme alcune soluzioni funzionali alle principali questioni. (ii) In una seconda fase, più orientata alla definizione dei concept di progetto, i progettisti si sono confrontati sui temi di progetto con un'azienda che si occupa di attrezzature antinfortunistiche, dalla produzione alla commercializzazione, per poter analizzare materiali e tecnologie ai fini dello sviluppo di prototipi dei prodotti individuati.

Così dall'analisi delle criticità si è arrivati alla definizione di idee di progetto attraverso il dialogo con chi lavora sul campo e chi produce i dispositivi, applicando metodi legati all'User-Centered Design, (Norman, 1991), in quanto è proprio l'UCD il primo strumento metodologico messo a punto per guidare il processo di progettazione verso lo sviluppo di artefatti usabili perché sviluppati a partire dalle caratteristiche e dai bisogni dei loro utilizzatori finali. Allo stesso modo, sono stati applicati strumenti di indagine consolidati provenienti dal campo dell'usabilità e degli *human factors*, utili per mettere a fuoco, oltre l'utente, il prodotto, l'attività e il contesto d'uso in un quadro analitico che congiuntamente concorre a fornire elementi utili alla definizione di un prodotto che supporti realmente l'utente a svolgere le azioni desiderate in maniera naturale.

Conclusioni

Il modus operandi della ricerca è di tipo abduktivo, in cui si conoscono regole e risultati, un approccio che porta a ricostruire una situazione, a definire un processo, il cui scopo non è quello di testare un'ipotesi per rispondere a una domanda di ricerca o alla scoperta di nuove realtà, ma di ideare soluzioni plausibili per i fenomeni proposti attraverso la pratica, deducendo quindi una prassi dal fare.

In questo processo il fare, il progettare, è diventato occasione per acquisire conoscenze, dati, esperienze e mettere in contatto le diverse realtà del mondo del cantiere e di quello del progetto nel tentativo di definire scenari innovativi e aprirsi a nuove soluzioni relative al problema della prevenzione del rischio e del coinvolgimento dei lavoratori nella gestione dello stesso. In questo senso i risultati della progettazione hanno significato se considerati all'interno di questo processo in una fase ancora in costruzione del lavoro. Se il processo riguardasse la possibilità di avere disponibili sul mercato dell'antinfortunistica i prodotti pensati all'interno

dell'attività di progettazione, questi dovrebbero essere realizzati come prototipi nella realtà e testati dagli utenti finali per valutarne con precisione scientifica l'effettiva rispondenza alle esigenze definite in questo processo di design partecipativo. Ma questi prodotti sono intesi come veicoli di messaggi per una nuova e più consapevole cultura della sicurezza in un cantiere che è esso stesso spazio della comunicazione. Su comunicazione e partecipazione, parole chiave della ricerca, si è orientata anche l'attività parallela alla ricerca di formazione di circa 250 architetti, che nel mese di maggio hanno condiviso lo stato di avanzamento del lavoro e hanno proposto modi e idee per innovare le pratiche della sicurezza nel cantiere. La possibilità di rovesciare il tradizionale approccio alla sicurezza nei cantieri e vedere in modo innovativo la partecipazione dei lavoratori all'interno del cantiere si è, infatti, rivelata un importante nesso di unione per avviare un dialogo con i professionisti che nella realtà si occupano di prevenzione del rischio e che possono essere anch'essi considerati utenti finali del processo.

References

- Agnesi, R., Calabresi, C. e Campo, G. (2010) *Edilizia: occupazione, infortuni e malattie professionali*. [Online] Available from: <http://www.prevenzionecantieri.it>. [Accessed: 17th May 2014].
- Beck, U. (2000) *La società del rischio. Verso una seconda modernità*. Roma: Carocci.
- Crippa, D. e Di Prete, B. (2013) *La sicurezza è di moda*. In Bucci, F. (eds.) *Senza Pericolo. Costruzioni e sicurezza*. Bologna: Editrice Compositori.
- INAIL (2013) *Dati Inail. Andamento degli infortuni sul lavoro*. 9 (Settembre 2013).
- Norman, D.A. (1991) *Cognitive Artifacts*. In Carroll, J.M. (eds.), *Designing Interaction: Psychology at the human-computer interface*. Cambridge: Cambridge University Press.
- Fagnoni, R., Pericu, S. (2013) *Lavori in corso*. Design per i cantieri urbani. In *L'Ufficio Tecnico*, vol.6/2013, 37-43.
- Fagnoni, R., Puri, G. e Sabeto, C. (2012) *Design activities. Formazione e produzione*. Genova: GUP.
- Giofrè, F. (2010) *Contro l'infortunio nel progetto e nel cantiere. Per una cultura della sicurezza degli architetti*. Roma: Eureka.
- Pericu, S. (2008) *Design under construction*. Firenze: Alinea Editrice.
- Rizzo, F. (2009) *Strategie di co-design*. Milano: Franco Angeli.

SILVIA PERICU

Terranova, F. (2010) *Conoscenza scientifica, processi produttivi e sicurezza sul lavoro*. In Giofrè, F. (eds.), *Contro l'infortunio nel progetto e nel cantiere. Per una cultura della sicurezza degli architetti*. Roma: Eureka.

Connective practices in the access of immigrants to healthcare services: The role of the language and cultural mediator as a boundary subject

Paolo ROSSI*, Mara TOGNETTI BORDOGNA
University of Milano Bicocca

Access to healthcare services by resident immigrants is often helped by language and cultural mediators acting as go-betweeners in their relations with professionals. The role of the mediator goes beyond this relational function and more closely affects the boundaries of healthcare organizations.

Beginning with a look at organization boundaries and boundary work practice, the paper outlines the role of LCMs as boundary subjects and how they contribute both to altering the practices governing access to health services and hence the boundaries of the organizations providing it, and to creating new relations among healthcare organizations. However, this is an area essentially left to discretion, without any explicitly recognised organizational framework, LCMs having precarious work status. Hence their work as boundary subjects tends to be all too improvisatory, lacking the weight to cope with immigrant residents' ever-more urgent need for inclusion and integration.

Keywords: *Language and cultural mediation; boundary subjects; boundary work; organizational boundaries*

Introduction

Access to healthcare services may prove a decisive step in the process of immigrant social integration. This step is currently being facilitated by the language and cultural mediator (LCM) who translates and interprets between patient and professional, and performs a large number of other functions besides (Tognetti Bordogna, 2013). One such is the emerging role of go-between and 'bridge' among organizations themselves. Often

* Corresponding author: Paolo Rossi | e-mail: paolo.rossi@unimib.it

unrecognised and tending to be on a voluntary basis, this role does call in question the boundaries of the organizations in which LCMs are involved.

The starting assumption of our paper is that nowadays LCMs are acting as 'boundary subjects' (Huzzard, Ahlberg and Ekman, 2010) in the no-man's land between organizations. This is due not just to the position itself, but to the informal or discretionary status that the go-between currently enjoys.

The paper presents the results of research performed in several Milanese hospitals and family advisory bureaus (FABs). The data show how the LCM's work helps, firstly, to retrace the boundaries between organizations and their surrounding environment (especially in terms of the rules of access to the services they provide). Secondly, LCMs are playing a crucial role in creating new inter-organizational relations.

The results show how essential their work is in facilitating social integration of immigrants. But the climate they work in is precarious in job and organizational status, which cramps their scope and demeans their value even in the medium term.

Theoretical Framework

The notion of organizational boundary encompasses a fundamental issue in organization studies. Organizations are in actual fact endowed with boundaries, varying in visibility, purpose and formalization, which carve out a physical space, domain of activity and administrative definition (Lewellyn, 1994; Diamond, Allcorn and Stein, 2004). The identity of an organization and its members hinges on recognition of a clearly perceived boundary (Kreiner, Hollensbe and Sheep, 2006). And yet the notion of the organizational boundary has rarely been dealt with head on (Santos and Eisenhardt, 2005).

The gap becomes especially acute when the organizations analysed involve street-level bureaucrats (SLB) (Lipsky, 1980). Some organizations have even been called street-level organizations (Brodin, 2011) owing to the importance of SLBs in them: various professionals acting in the border-zone in direct contact with the end-user. In many respects SLBs personify that organizational borderland, especially in the eyes of those benefiting from the services provided. This is especially true of organizations regulating access to welfare facilities, a role that may be described as gatekeeping (Rumery and Glendinning, 1999, 2000; Reibling and Wendt, 2012).

Access to welfare facilities, including health services, is often regulated and/or facilitated on a discretionary footing. This boosts the importance of the border-zone in which SLBs operate, performing what may be called

'boundary work' in the eyes of the end-users. Boundary work has been examined from various angles and may mean various things to an organization and its stakeholders (Zietsma and Lawrence, 2010, p. 194). One first function of boundary work lies in creating and protecting the boundary (from out-to-in, and in-to-out), thus ensuring control over specific resources and maintaining independence. 'Boundary-spanners' (Levina and Vaast, 2005) are an example of such work: people expressly empowered to cross the boundary and secure a connection. This power is explicitly accorded to people backed by an agency, as well as to so-called 'boundary objects' (Star and Griesemer, 1989), namely devices designed to establish connections between different organizational contexts. The third value of boundary work is to breach boundaries.

Our specific focus is on the ability of some professionals to act simultaneously on all three of these planes, whilst maintaining their behaviour within the confines of legitimacy both inside and outside the organization. This feature reflects much of what Star and Griesemer had to say about boundary objects: *'objects which both inhabit several interacting social worlds (...) and satisfy the informational requirements of each of them. Boundary objects (...) have different meanings in different social worlds, but their structure is common enough to more than one world to make them recognizable, a means of translation* (1989, p. 393).

LCMs involved in immigrant access to health services play a role which may be compared to boundary objects in many respects. If one replaces the word 'structure' in Star and Griesemer's definition by the concept of *agency*, the profile fits that of the LCM.

To define that job one may speak of boundary *subjects* in the way proposed by Huzzard, Ahlberg and Ekman (2010). They see the factor typifying boundary subjects as the ability to operate reflectively in the border-zone and hence act vigorously to create, cross, destroy or revise the organizational boundaries.

Where we wish to go deeper here concerns the legitimacy and consistency of LCMs' behaviour as boundary subjects, i.e. when creating, opening, and spanning organization boundaries. Such operations might be construed as the pursuit of a particular professional function, but they would lack sense and impact if they were not expressly recognised and legitimated by the organizations concerned. The first question is therefore: what are the sources of boundary subjects' discretionary behaviour? It is likewise legitimate to focus the question on the continuity and stability of their intervention, lest this appear mere improvisation. From this standpoint

the exact question is: how can the action of boundary subjects be stabilized and institutionalized?

Before pressing further with such questions, we had better look more closely at the work LCMs do and the special relationships they may set up with healthcare-providing organizations and their patients.

Language and cultural mediators: boundary subjects and boundary practices

From the literature we may single out a number of definitions throwing light on the function of Language and Cultural Mediators (LCMs): *'mediation is construed as a resource at the service of a service'*. *For the most part it acts so as to inform people, facilitate access to and use of services, remove language and culture barriers, frequently in a spirit of decompression. If engaged in fostering pluralism, mediation tends to relate to groups and communities in the role of advocacy and defence of the representative body, as well as generating empowerment* (Comune di Milano, 2001, p. 21).

The above definition highlights the promotion side, activation of the individual's culturally-oriented personal resources so that by a process of cultural transition he/she can cope better with the new society and the resource system he/she is now living in.

Another definition applying to the social and health service situation (Castiglioni, 1997) sees language and cultural mediation *'as an area preventing hardship and conflict, enabling questions to be formulated whilst decoding them and translating them in terms of law.'*

A third definition by Balsamo (1997) emphasises how intercultural mediation smooths the processes of social interpretation, reducing barriers of communication and access between immigrant users and services, by working with the resources present inside the immigrant population.

This is to see the LCM function as facilitating communications, offering help both in decoding the question and in defining the need. It may also extend to preventing hardship.

The mediator as a demystifier, but also presenting an opportunity to rethink one's own way of doing things and set in motion a reciprocal relationship, a new way of seeing the world. A useful mechanism for understanding the migrant situation, cultural worlds, critical features of the organization structure and patterns of operation. An opportunity to structure the relationship with the end-user, as well as between user and

The role of the language and cultural mediator as a boundary subject
service, social/health worker and mediator (Tognetti Bordogna, 2013).
These tasks all lie within the scope of Language and Cultural Mediation.

The LCM is a new profile calling for a different approach in/by the social/health services. They must renegotiate workstyles, institutional and professional rules, and pay more attention to listening to others, building up trust.

But the new job profile has its snags both for the end-user and for the health worker (Tognetti Bordogna, 2013b).

For the user, one of the most delicate and crucial points bearing on the success of the operation is to have the LCM working alongside the user.

There are a number of compatibility variables to bear in mind.

Compatibility between the language of origin and its dialects; religion, religious observances and ways of practising one's faith. Again, if the LCM and the user are from different countries, any gaps in economic, social or cultural status, not to mention the historical situation or even an ongoing conflict, will need careful handling.

A second critical area is a proper understanding of the LCM's role: this goes for the user and for the health worker. The LCM profile is relatively recent in Italy and its role and range of functions/areas of competence still need to be assimilated. Person-related services thus have a new 'figure' to share their work of intervention. The risks here range from expecting the LCM to play a purely subordinate role, to the opposite: almost total delegation to the LCM of case management. In turn, the foreign end-user may make inappropriate demands perceiving the LCM more as a 'friend' than an official, or someone completely on his side; or there may be fears of exactly the opposite kind. The LCM's job plainly takes place on the boundary (between cultures, organizations), though it also entails crossing that boundary and perhaps redrawing it, as we will show from our research data.

The research: methods and settings

The data we present are the fruit of inter-university research, funded by the Ministry for the University and Research as part of the PRIN venture (*research programmes of national interest*). The overall research topic was integration of immigrant residents in a gender perspective. The research group based at Milan Bicocca University's Department of Sociology and Social Research took the more specific subject of access to health services and its role in the process of social integration.

The Milan-Bicocca team proceeded to conduct semi-structured interviews with health workers from three Integrated Family Advisory

Bureaus (FABs) in Milan itself, and three Milanese Hospitals' maternity and gynaecology/obstetrics departments.

We interviewed users of, and not just workers at, the various facilities, focusing on Moroccan, Filipino and Chinese women since these were the most numerous immigrant women groups in the city. The analysis makes use of data from interviews with professionals, which were conducted as outlined in Table 1.

Table 1 *Number of practitioners interviewed in each context.*

Organizational context	Number of interviews
FAB 1	3
FAB 2	3
FAB 3	4
Hosp 1	3
Hosp 2	4
Hosp 3	3

The settings were chosen because of the incidence of Chinese, Moroccans and Filipinos in them. Each of the organizations surveyed had an LCM service laid on, though the professionals performing that service do not have a fixed post in the organization.

Boundary practices and boundary subjects in Italian healthcare organizations: insights from the field

It will be clear from what follows that certain LCMs may act as boundary subjects in two organization settings: hospitals and FABs. The two organizations have many points of difference: firstly, hospitals provide a wide range of health services, while FABs concentrate on day-hospital services and prevention, and cannot perform clinical interventions. Hospitals are also distinct organizational structures each in its own right, while FABs are an organizational offshoot of the ASL (*Azienda Sanitaria Locale* – the structure that manages health services across the local area).

Each hospital, and indeed each of the FABs we studied, has gradually developed its own organizational policy and specialized in helping a specific group of immigrants. This is reflected in the fact of the organization having inside its organization a fixed LCM speaking a particular language.

One should point out that these lady LCMs do not work within the organization or on its payroll: they act as freelance professionals, part of the collaboration agreement hospitals and FBSs have with agencies providing language and cultural mediation. So it may happen that an LCM a) works for more than one LCM agency (at the same time, in some cases), and b) works in various settings, including hospitals and FABs.

That LCMs may belong to various organizations and work in various settings are basic points in our analysis. From the outset this means that language and cultural mediation becomes a job linking a number of organizations, spanning borders that other professionals (in the health world) find difficulty in crossing.

The LCM's job in itself occupies a frontier position: these ladies facilitate relations between professionals and patients when the latter lack the language skills to handle the relationship on their own. But LCM practice is not confined to functional intervention. As a whole, the LCMs studied during our research (directly or indirectly, via remarks by other health workers) work towards (perhaps in cooperation with other members of the organization) creating more intense 'boundary work'. This process may take various forms and have differing aims, which may be grouped under two main headings:

- a) revising boundaries and rules of access to organizations;
- b) setting up new connections beyond the confines of the organization.

Revising boundaries and access rules

The first side to the boundary work performed by LCMs is the discretion this entails in interpreting regulation of access to services provided by the institution. Access to services tends to be governed by procedures that have become consolidated with experience, or erect de facto barriers between organizations and end-users because of certain rules. The work of LCMs may bend these last and make organizational boundaries more permeable, bringing them into line with users' needs and/or expectations. One such example transpires from the words of an LCM working at an FAB:

To be honest, when an Italian lady phones and we have to fix a new appointment on top of all the rest... we're unlikely to fit her in at once. But if a Filipino lady comes along, sometimes we do fit her in straight away, even if we're already full. (LCM - FAB 3)

So there is sometimes positive discrimination, helping immigrant patients to gain access. A similar practice occurs in contacting patients who failed to turn up for an appointment. The same LCM relates:

For Italian patients the rule is that if you didn't come, tough. But with Filipino women if they don't turn up we phone them back to know why they didn't come (...). It's not part of our duties but we do actually, even if we're really full, at the end of the day we may be talking to the gynaecologist or social worker and ask: 'why do you think she didn't come, then?' We ring her up, no problem. Why do such a thing? The patients really appreciate it, they say 'you're the only advisory bureau that phones back' or 'in hospital no-one would dream of calling me for a missed appointment'. (LCM - FAB 3)

Instances of organization boundary permeability by LCMs are not just sporadic, however, but form part of coordinated and shared organizational practice. Again, revising the boundaries is an operation that may involve access dynamics or discharge patterns. As a hospital gynaecologist explains:

For them we can put off the moment of discharge for a bit, while waiting for relatives to take them home, people who understand and can explain. (...) Or help them with the baby, stay a bit longer at night time, perhaps help those breast-feeding a bit more, explain really well, look after them a bit more in that way. (Gynaecologist – Hosp 3)

One should note that adjusting the access procedure is not just something extempore or one-off. The framing of access rules for some services may be tailored to specific needs of potential users right from the start. This happened for example when a Listening Centre for immigrant women was inaugurated at an FAB:

In the whole of Milan this is the only advisory bureau which has a Filipino mediator. So we started off with just one day and thought about which day: morning or afternoon ... we opted for the afternoon because it's easier, you know, maybe (the patients) find it easier to come then. We also decided to do Thursday afternoon, as Filipino women, specially those with a fixed job, tend to get Thursday afternoon off. (LCM – FAB 3)

Setting up new connections

In practice boundary-work tends to involve some bridging of inter-organizational boundaries and setting up of new connections. A recurring theme in interviews is that of LCMs being directly responsible for setting up connections between organizations. Such bridging is often a personal achievement at the discretion of the LCM as part of her professional brief. Later on, some of the connections set up by LCMs may become consolidated and more explicitly institutionalized. An example of inter-organizational connections where LCMs were the vectors is provided by an LCM:

We work as a network, if (patients) get into difficulty. For example, we had a lady who was in post-childbirth depression; we got our act together and phoned the 'A' hospital since there's a service for that very thing there. Or the 'B' hospital, 'cause when you work at the 'B', too, it's easier to communicate, they find the same mediator they met in this service. (LCM – FAB 3)

Setting up relations may also respond to an organizational need. A great influx of immigrant patients may cause an overload of work, meaning that not all the patient requests can be met. Where that happens, the LCMs themselves will re-route patients to another facility, as one LCM working at a bureau relates:

We have no room for (monitoring) pregnancies until the end of January. So today there were six pregnancy cases, so I gave the numbers of other places: one lady I gave the number of another advisory bureau, and to someone near hospital I gave the 'B' hospital address. (LCM – FAB 1)

One notes with interest how LCMs' personal contacts outside work sometimes provide an eye-opener onto the role of some organizations in integrating immigrant residents. Thus, for example, at the Brizzi hospital one LCM set up a link to the Chinese consul. The experience was recounted by a social worker who works at the hospital:

Many people called this the Chinese hospital, not the children's hospital, it has so many Chinese children being born. Anyway, one of our long-standing mediators, who's still on the strength, by the way,

managed to get us a contact, a link to the Chinese consul which, I mean when the hospital gave the OK, became official, and it was her doing. (Social worker – Hosp 1)

This analysis would not be complete without a word about the precarious job status of LCMs. That makes the work they are doing of forming connections somewhat fragile. The connections they set up between organizations often stem from personal networks and many evaporate when a particular LCM no longer liaises with certain organizations. The precariousness factor was stressed by one of the LCMs we contacted in the course of our research:

This is a very makeshift sort of job, a few hours here, a few hours there. (LCM – FAB 1)

In a sense it might be argued that precariousness itself raises the need for boundary-crossing, as people look for more settings in which to work.

Discussion and conclusions

In the healthcare setting of hospitals and family advisory bureaus extending health services to immigrants, LCMs function as boundary subjects from various standpoints. Over and above their specific professional role as interpreters and intermediaries between patients and professionals, they play an important role in reconfiguring the organizational boundaries (by way of facilitating access to services) and creating new inter-organizational relations (extending professional and organizational intervention in a more ramified network across institutions and the environment).

The research we have presented illustrates some of the boundary work that may be performed by LCMs. We have also tried to highlight some of the snags that their work runs into. We are well aware of the limitations of this research which focused on a small number of organizations and professionals within a single territorial area (albeit a significant one, given the presence of so many women immigrants). That being said, one may draw a number of more general points for reflection.

First, the boundaries of organizations providing welfare services prove to be quite permeable, where foreign users are concerned. The boundary work performed by LCMs would not be possible in a more rigidly regulated closed environment, still less so, probably, with an all-Italian public. Both hospitals

and FABs thus prove their professional and bureaucratic worth: professionals use their discretion and this affects both the conduct of work and the perimeter activity around the organization. In that light LCMs are boundary subjects liaising with other professionals involved in boundary work (gynaecologists, obstetricians and nurses). The first point of recognition and legitimation in their favour is hence the seamless continuity between their professional rationale and that of the health workers they liaise with. This is often underpinned by an organizational approach that is highly sensitive to the issues of the immigrant public and its specific needs.

Coming to the second question asked by the research, one must conclude that stabilising and institutionalizing boundary work seems to be more problematic. The main drawback is the precarious work status of the LCM, which prevents any medium-long term planning of their activity. One must also note that certain forms of boundary work (like revising the rules of access or creating new inter-organizational relationships handled by LCMs) figure as one-off schemes: they may catch on in professional and organizational practice, but they are unlikely to meet with proper professional recognition. This is due to two main factors: the fact that such initiatives imply 'infringement' of consolidated rules and protocols (as in the cases described of positive discrimination); it also tends, paradoxically, to generate dependency on LCMs, instead of leading to gradual phasing out of their services (as better language skills are achieved, for example). One might argue that the service offered by LCMs is so effective, it catalyzes demand, instead of facilitating access.

In conclusion, then, our research has shown the boundary-work done by LCMs to be fundamental in helping immigrants gain access to health services. However, such boundary work has a fairly substantial side effect: instead of just operating in the border-zone, it creates a new territory corresponding to each LCM's orbit of action (in space and in time) – or to the overall orbit of the LCM network liaising with hospitals and FABs. This is far from a minor issue, if only when it comes to *planning* healthcare operations for immigrant users. Making their working conditions less precarious, if not stabilizing the profile of the LCM within each organization, might remove some of the interstitial quality from the relationship between immigrant residents and institutions.

References

Balsamo, F. (1997) *Da una sponda all'altra del mediterraneo*. Torino: L'Harmattan.

- Brodtkin, E.Z. (2011) Policy Work: Street-Level Organizations Under New Managerialism. *Journal of Public Administration Research and Theory*, 21 (suppl.), 253-277.
- Castiglioni, M. (1999) *La mediazione linguistico-culturale. Principi, strategie, esperienze*. Milano: Franco Angeli.
- Comune di Milano (2001) *Parole a più voci*. Milano: Franco Angeli.
- Diamond, M., Allcorn, S. and Stein, H. (2004) The Surface of Organizational Boundaries: A View from Psychoanalytic Object Relations Theory. *Human Relations*, 57 (1), 31-53.
- Huzzard, T., Ahlberg, B.M. and Ekman, M. (2010) Constructing interorganizational collaboration: The action researcher as boundary subject. *Action Research*, 8 (3), 293-314.
- Kreiner, G.E., Hollensbe, E.C. and Sheep, M.L. (2006) On the edge of identity: Boundary dynamics at the interface of individual and organizational identities. *Human Relations*, 59 (10), 1315-1341.
- Levina, N. and Vaast, E. (2005) The Emergence of Boundary Spanning Competence in Practice: Implications for Implementation and Use of Information Systems. *MIS Quarterly*, 29 (2), 335-363.
- Lipsky, M. (1980) *Street-level Bureaucracy. Dilemmas of the Individual in Public Services*. New York: Russell Sage Foundation.
- Llewellyn, S. (1994) Managing the Boundary: How Accounting Is Implicated in Maintaining the Organization. *Accounting, Auditing & Accountability Journal*, 7 (4), 4-23.
- Milanesi, A. (eds.) (2001) *Mediare parole, mediare significato. La mediazione e i mediatori nella scuola e nei servizi educativi*. Trento: didascalie libri.
- Reibling, N. and Wendt, C. (2012) Gatekeeping and provider choice in OECD healthcare systems. *Current Sociology*, 60 (4), 489-505.
- Rummery, K. and Glendinning, C. (2000) Access to Services as a Civil and Social Rights Issue: The Role of Welfare Professionals in Regulating Access Older People under New Labour. *Social Policy & Administration*, 34 (5), 529-50.
- Rummery, K. and Glendinning, C. (1999) Negotiating needs, access and gatekeeping: developments in health and community care policies in the UK and the rights of disabled and older citizens. *Critical Social Policy*, 19 (3), 335-351.
- Santos, F.M. and Eisenhardt, K.M. (2005) Organizational Boundaries and Theories of Organization. *Organization Science*, 16 (5), 491-508.

- Star, S.L. and Griesemer, J.R. (1989) Institutional Ecology, 'Translations' and Boundary Objects: Amateurs and Professionals in Berkeley's Museum of Vertebrate Zoology, 1907-39. *Social Studies of Science*, 19 (3), 387-420.
- Tognetti Bordogna, M. (2013a) Mediazione Linguistico Culturale. In AA.VV. (eds.), *Dizionario di servizio sociale*. Roma: Carocci.
- Tognetti Bordogna M. (2013b), Bisogni di salute degli immigrati e i processi di cambiamento organizzativi nei servizi sanitari. *Sociologia Urbana e Rurale*, 101, 101-119.
- Zietsma, C. and Lawrence, T.B. (2010) Institutional Work in the Transformation of an Organizational Field: The Work and Practice Work. *Administrative Science Quarterly*, 55 (2), 189-221.



Improving medical information of blood tests results through the application of co-design

Mónica SANTOS^{*a}, Susana BARRETO^a, Katja TSCHIMMEL^b

^a Fine Arts Faculty University of Porto ; ^b ESAD Superior School of Arts and Design

Reading medical information documents can be made from at least two perspectives: the perspective of the health professional and the perspective of the patient or user. The content and presentation of these documents is usually developed by health professionals and because of this, is often beyond the comprehension of the patient, which creates a negative emotional response to information. Misunderstanding the information in the documents is associated with the rejection of information and the lack of motivation to effectively change risk behaviours. In this paper, we demonstrate through observation of 121 voluntary participants, users of the Portuguese National Health Service, the difficulty in understanding the information, getting more insights into the perspective of the people related with medical information. We perceived that most participants had difficulty in interpreting the blood results, didn't know or could not find the information, didn't understand the symbols present in the document, and didn't know what to do to prevent illness when results are not favourable. For further observation in reading the document, some images were presented to the participants and they were asked to choose the solutions they considered best. This paper aims to show that, in order to encourage people to take responsibility for their own health, it is essential to develop medical information documents, based on the real needs of people, through collaborative design and co-creation, and to provide design with tools for building effective health messages.

Keywords: *Information design; health; ethnography; co-design; design thinking*

Introduction

Since the Industrial Revolution we have seen the creation of inventions that allowed us to see the capacity of design to change the world. There has

* Corresponding author: **Mónica Santos** | e-mail: monicasilvasantos@gmail.com

always been a connection between design and society. Until the industrial revolution, design served as a means of communication and as a factor of differentiation, reduced to formal aesthetic aspect, which were demanded by the growing bourgeois class. Although design was seen as a way of increasing company profits, an attitude sustained by capitalism, the social significance of design has always been present.

William Morris, with his ideal of 'design for all' was considered the father of social design. Also the ideology advocated by Bauhaus was primarily social. However, despite these references to design with social concerns, until the 1970 and 1980's, design basically was consumer oriented, as is shown by unbridled consumption and large scale growth.

Sometimes what seems to be beneficial to societies economic growth, has very negative side effects, and despite what appeared to be a boom to the economic situation, it soon became apparent, that consumer oriented design, was a danger to a healthy society (Whiteley, 2003). It was not only the economy that was at stake, but also the culture and life quality. It became obvious that the role of design in society had to be reassessed; it still has a fundamental part in economic society, but it must shoulder responsibility for the social, cultural, political and environmental outcome. Design has become a most powerful tool, with which man can shape society, but that demands a great understanding of society by those who practise design and more insight into the design process by the public (Papanek, 2010).

Currently, we are witnessing various demonstrations against excess, and an emergence of many areas of design demonstrating apprehension with society. Beyond the role of aesthetic and formal issues solver, design has also take on another role, whose goal is to make every day easier and safer.

When the base of design work is a concern with the social questions, it is vital to consider that working with a group with a history, culture and an identity, means investigating that social group and the environment for which it produces is an obligation of design. Understanding the user makes it possible to give him an active role in the design process.

In this article, we investigated health information documents design, their accessibility and comprehensibility, based on a social model that takes in account the needs of document users, and not just those with sufficient literacy skills to read information. It's important to take into account users with low literacy skills, special needs and others difficulties. Inferior or inadequate health information design documents can affect security,

Improving medical information of blood tests results through the application of co-design
opportunity, and stress level, self-esteem and even the physical integrity of people (Papanek, 2002).

Each person has his own reality and knowledge, and different levels evoke different needs. There are three behaviour types when accessing health services: there is a user that is aware of its own ignorance but he doesn't care, preferring someone else to guide him; the second behaviour is about someone also aware of his illiteracy but is too embarrassed to ask for help and also doesn't try to get there on its own; and there is the user that although he doesn't know, doesn't give up, and is proactive, seeking knowledge and information. Usually, this last behaviour type, demonstrates the user experiences health on a more cognitive level, want options and answers (Huelat, 2007).

In this investigation we use a design-based approach as a survival strategy, seeking to balance society and individual needs as a whole, able to answer global challenges like health, poverty and education (Brown, 2010). Design Thinking and Co-Design methodology offers that approach, a profound way of solving wicked problems (Buchanan, 1992) by being human-centred (Cross, 2011; Tschimmel, 2012; Curedale, 2013).

Medical Information Documents

The purpose of an information document in health is to inform. The purpose of the analytical report is to inform the medical professional of the health status of his patient, but also to inform the patient on his own health status.

The fact that the patient does not have an active role on delivering this document is one of the main reasons that leads to the rejection of the information contained in it, and also to the development of a negative emotional response. Frequently the analytical report is presented to the patient with no further explanations or discussion of its contents, language or technical terms, which could be easily replaced by a simpler language, or delivered with brief explanations or suggestions on its contents.

As seen on either the medical professional, or his patient's response when interacting with the same document at the same time, both individuals can experience the information contained in it in a dramatically different mode.

Information design: message

The World Health Organisation (WHO) advocates that for preventing cardiovascular diseases, we should practice exercise everyday, have healthy food habits, weight control, blood pressure and cholesterol, not smoke, avoid stress, among others things. However, it is not enough to tell people what to do to prevent disease, most of them already know, but they simple don't do it. Why? It is not easy to create health information messages that grab people attention, is understandable, and with which they agree and intend to act on it. If the user doesn't perceive the information as such, if he's not able to read it, understand it or even find it attractive, he's hardly going to change his attitude and daily habits. He needs to understand that he can do it and what the benefits are of a behaviour change.

Health communication is about the study and use of communication strategies to inform and influence people and communities decisions, in order to promote health. Health communication includes messages whose goal is to promote health, to educate for health, to avoid risks and help in dealing with health threats, prevent disease, suggest and recommend behaviour changes, recommend screening tests, inform about illness and the tests that is necessary to do, inform about the results, about medicines, recommend preventative measures and self-care activities in patients (Teixeira, 2004).

An inadequate level of literacy is reflected in a misuse of health information, in a rejection of the information and consequently a lower use of preventive health care. Besides this information and it's presentation is normally developed by health professionals, a reason why often exceed the user's reading capacity, leading to an negative emotional answer to given information about their health, and to a lack of motivation to change risk behaviours.

Many health professionals are regularly involved in the development of written material about health education, and with information addressed to users and patients, whose objective is to promote healthier behaviour, which often result in documents with a very good content but with a strong chance of not communicating, because of poor design and layout (Osborne, 2006). Information Design, defined as the art or science of delivering information that human beings can use effectively and efficiently, aims to develop understandable documents, readily and accurately retrievable, and easily transposable to effective action (Jacobson, 2000).

Creating effective health messages it's not an easy task. One of the main challenges that arise is to achieve and maintain audience's attention to the

Improving medical information of blood tests results through the application of co-design

message content and purpose. However, barriers exist, such as the lexical complexity of the information, which makes it difficult for the audience to access your message, partly due to the low health literacy of a large proportion of the population (Espanha, 2009).

Creating effective health messages aiming to modify risky behaviour is an even greater challenge. For a message to be effective, it becomes essential that the public has a genuine interest in it, understands and agrees with it. They must think about it, keep it their memory and intend to act accordingly (THCU, 2002). It is necessary to take into account the host of variables that might have an influence on the outcome of the reading process: attractiveness and credibility, which derive from the characteristics of the message source; message design, organisation and structure; the communication channel itself (direct/ indirect); and even the receivers personal features (mood, education, amongst others).

A design communication message is an instrument to achieve change, it is through it we reach the audience, and inspire and challenge individuals to take actions on their own health. There are two approaches in the construction of the message, one based in theory, one based on the public. Messages based in theory aim to supply knowledge on cognitions, emotions and social processes that motivate health behaviours (Cho, 2012). This paper intends to investigate the construction of messages based on the audience, in order to reduce disparities in health practice and results between the different segments of the population, in which the target group has many different characteristics. The diversity of the audience stems from a wide range of factors: ethnicity, beliefs, values, social culture, identity, and health literacy, among others. Delivering health messages based on the public, tells us how to translate abstract knowledge (cognition, emotion and social process) in effective health messages.

The purpose of the message is to communicate, and communication is fundamental across clinical practice, being through it that feelings, emotions and symptoms are explored and valued. Through communication one attempts to identify and model expectations, give explanations and agree on treatment plans, among other things (Carrapiço and Ramos, 2010). The communication process materialises both through verbal and non-verbal speech, but also through expressions, attitudes, behaviours and so on. And if every interaction between doctor and his patient during medical appointment must be clear, this also applies for all communication supports that have the purpose to inform the user about health, particularly about their own health.

User Literacy

The role of the health services user has changed over recent years. Because of an increasingly easy access to information, through the different existing media, he is no longer a mere receiver of medical treatment, but became an active participant in managing his own health. However, in the present day, the relationship between doctor/patient is still perceived as a professor/student relationship. Doctor/professor has more knowledge than the student, and health professionals hold the control because they control knowledge. It is assumed worldwide that health is what hospitals and doctors deliver, and that health services are the health care services that are organised for us, defining what is to be healthy. Simultaneously, patients are involved in health professional's own language, disabling them, making them confused and dependent.

In order to change this situation, it is essential to endow individuals with capabilities to understand and question what is offered by professionals and health services, and as patients providing them with the knowledge so that it is possible for them to interact with their health care providers. One way to do so is by increasing health literacy. The World Health Organisation defined health literacy as the cognitive and social skills which determine the motivation and ability of individuals to gain access to, understand and use information in ways which promote and maintain good health (WHO, 2006).

Health literacy is important because it enables easy browsing in the health system by individuals, allows them to understand the advice of the doctor or health care provider, and gives them autonomy to take care of themselves and their daily health. They can better manage chronic diseases, and also engage in behaviour for health promotion such as adopting a healthy diet, practicing physical activity, and others, as well as to act on the related information provided.

As well as most information documents in health, analytical reports exceed the capacity of reading and understanding of patients, primarily the ones with poor health literacy. These individuals, in addition to being those that have more difficulties accessing health care and information, usually do not identify themselves with the issues of health literacy and their lack of knowledge is accompanied by embarrassment and shame (Schwartzberg, Vangeest and Wang, 2005).

Methodological approach

Today, Design Thinking is perceived as a form of thought that leads to transformation, introducing design culture in other areas of knowledge. It presents new process tools and models that help increase, expedite and visualise the creative design process, not only to designers but also to all the multidisciplinary team. On the premise that every person is creative, Design Thinking is based on the designer capacity to consider three fundamental factors: human need and the new vision of welfare, materials and resources available, constraints and opportunities of the project. It uses a set of methods of data collection to realise behaviour, objects and words people use in their relationship with things and processes around them.

Co-creation is defined as a creative act between two or more persons, and according to Sanders (2009), co-design is a instance of co-creation. As part of this investigation we use the term co-design because we intend to address the issue of collaborative design throughout all the process and design area. Co-design is an investigation method in which users became active participants in creative development over all the design process (figure 1). User participation in the process, from the problem identification related to the performance of the object, analyses, and new solutions development, tests, improvements, monitoring, allows the creation of solutions based on the real needs of the users. We aim to use this approach, both research-centred, through applied ethnography, and design-centred, that wants user involvement, in which designers and researchers turn to the users, and users turn to the researchers.

Through the observation of the interaction between users and the documents, it was possible to perceive the reading and information comprehension obstacles. The ethnographic method, the investigation of the emotional experiences, facilitates the understanding of the problem, and seeing through the eyes of the users, how they handle, performance, the ability or inability to understand and assimilate the message, mark out the problems present in the document.

Ethnography applied to design seeks to understand the relation between the user and the object, and thus allows us to present data about the user and the object performance. Within this research, observation and co-design were used to take in the users' reading and comprehension needs about the blood test report.

Co-creation and co-design concerns the creative act between two or more person, and it's included in the Design Thinking approach, integrating itself into the collaborative work, as it's main tool. Design Thinking is the

application of design thought in the search for solutions to social, economic and environmental problems. Design thought is an abductive thought, already advocated by Charles Peirce in 1901, which we can distinguish from deduction or induction: 'deduction proves that something must be; induction shows that something actually is operative; abduction merely suggest that something may be' (Steen, 2013).

Design Thinking adopts Herbert Simon's (1999) definition of design, 'the intentional search for change from existing situations into others more preferable', or Tim Brown's (2008) definition 'a discipline that uses the designers' sensibility and methods to satisfy people needs, with what is technologically feasible and can convert into a business strategy of value to the consumer, or a business opportunity'.

The co-creation workshop developed in 2012 enabled us to understand the difficulties in the reading process, and stimulate the generation of ideas from users. It also allowed participants to reflect on issues that hitherto remained unquestioned. With 12 participants, the workshop consisted in 3 parts. Initially participants read individually a blood test report, the mistakes and difficulties were pointed; in a second phase they worked in pairs and we asked them to choose between some models of typography size and type, and some images and colours. Finally we did an information organizing exercise to stimulate creativity and realize how information make sense to the participants. This approach allowed us to prepare the materials to the project that was developed with the national institute of health.



Figure 1 Co-creation workshop 2012.

The Project

This project was conducted in collaboration with the Department of Health Promotion and Chronic Disease of the National Institute of Health Dr. Ricardo Jorge. The department's main strategies are: align health policies, promote increased health literacy, enable health system to innovate and the citizen to better management of their resources and their own health.

This department is carrying out research, denominated 'e_Cor: Study of Cardiovascular Risk Factors in the Portuguese Population', a population-based study with a laboratory component, whose main objective is the determination of cardiovascular risk factors in the Portuguese population and which will contribute to scientific knowledge to help decision making in public health, in particular to define better strategies in the area of cardiovascular prevention (INSA, 2011). For this study, 1700 persons were randomly selected in mainland Portugal and were asked to do a blood test, followed by a questionnaire on lifestyle and a physical examination.

The sample used for our investigation, were 121 users of the National Health Service and voluntary participants of the study e_Cor (table 1).

Table 1 presents the participants characteristics and the results, in percentages, of the answers.

Table 1.

Characteristic	Percentage	Characteristic	Percentage
Age	56%	44%	
18-25	13%	26-35	30%
36-44	11%	45-54	8%
55-69	23%	70-85	13%
Occupation			
can not read	2%	Primary School	20%
Secondary School	12%	High School	26%
Undergraduate	31%	Master Degree	3%
Results outside the reference values reported (Results outside the reference values: 4)			
4 results	49%	3 results	31%
2 results	10%	1 result	9%
Results within the reference values reported as being out:			
1 value	48%	2 values	10%
3 values	13%	4 values	3%
5 values	3%		
Printed out the asterisk *			
Yes	3,10%	No	96,9%
Printed glycated hemoglobin			
Yes	3,3%	No	97,7%
Confusion with the symbols "c e s"			
Yes	52%	No	48%

After explaining our investigation and the objectives of our work, we asked the participants to collaborate on our research on the performance of medical information documents, specifically the blood test report.

The requested tasks were intended to help the user to assess the success of the document. Through this tasks (identification, in the document

provided, of the results that were outside the reference values, the entente of the information, the ability to prevent the increase of a disease or of an illness) we verified that the analytical report (figure 2) used in the e_Cor study contained many inaccuracies regarding the information presentation and our results prove that.

natureza: soro				
Glicose	85	mg/dL	Hexoquinase	70 - 110
	4,72	mmol/L		3,89 - 6,11
Creatinina	0,53	mg/dL	Jaffé-Cinético	0,50 - 0,90
	47,2	µmol/L		44,20 - 79,56
Colesterol Total	240	mg/dL	Enz. Colorimétrico	> 90 - < 190
	6,23	mmol/L		> 2,34 - < 4,94
Colesterol - HDL	59	mg/dL	Enz. Colorimétrico	> 45
	1,53	mmol/L		> 1,17
Colesterol - LDL	167	mg/dL	Enz. Colorimétrico	< 115
	4,35	mmol/L		< 2,99
Lipoproteína (a)- Lp(a)	53	mg/dL	Imunoturbidimétrico	< 30 *
	0,53	g/L		0,00
Apolipoproteína A1	154	mg/dL	Imunoturbidimétrico	> 160
	1,54	g/L		0,00
Apolipoproteína B	120	mg/dL	Imunoturbidimétrico	< 150

Figure 2 Analytical Report Sample.

There were two participants who could not read, some of them didn't understand the nomenclature and symbology present in the document, others didn't know what to do to prevent disease when results were outside the reference value. Although most of the participants know what to do to prevent, for example, increased cholesterol, the vast majority did nothing.



Figure 3 Performance task: typography exercise.

Improving medical information of blood tests results through the application of co-design

Most participants had difficulties in interpreting the results, and didn't or couldn't locate the information. As we can see on table 1, there were four results outside the reference values, which the users should immediately locate: only 49% of the participants were able to identify those four results; only 2,3% mentioned glicad haemoglobin, because this result was not in the expected place; most participants had to follow the line for the result with the finger not to lose the horizontal orientation or inadvertently jump to row above or below, and misread the result (fig. 4).

Many participants were confused by the symbols $< / >$ (less than/greater than), and others confused the results with the reference values.

After the observation of participants in reading and locating information tasks, we presented some images. These images were produced based on the analyses of the results of the performance tasks developed earlier. Participants were requested to choose the best image concerning readability, understanding and visual harmony (fig. 5). Participants had to select what they considered the best option: typography, font and size for words and numbers, the colour associated with a good or bad result, the symbol associated with the good and bad result, and organise the columns the way they considered most effective from the user perspective. These exercises had the goal of determining which were the best solutions to present the results of the blood test analyses in order to contribute to the reading and comprehension of the document, contributing to the health literacy and turning the user responsible for his own health promotion and disease prevention.



Figure 4 Performance task: document reading.

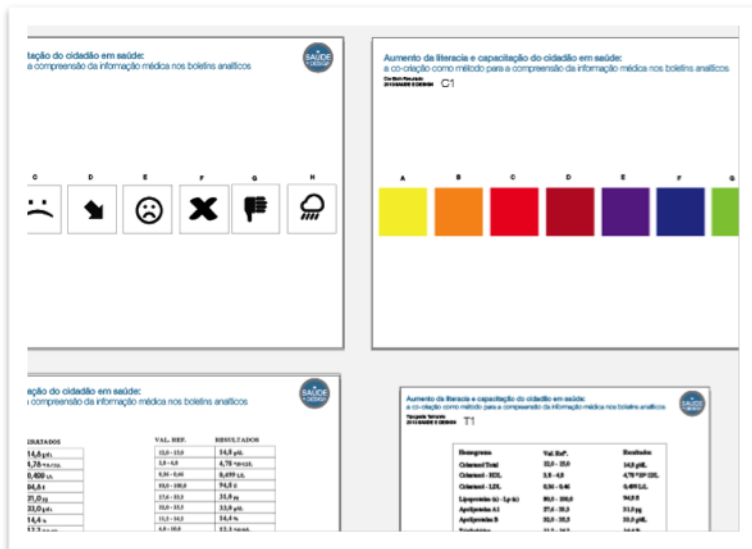


Figure 5 Performance task: reading observation.

New Document Design

The main improvement to design effective health information documents and promote user behaviour change, is to see the user as an active intervener with an active role in welfare creation. The absence of the user-based practice, means that the effect of this medium will be reduced and will have less probability of involving the public to which they are addressed, meeting the informational needs of the users, of increasing their motivation and make them act on that motivation.

A way of improving health information reading and comprehension is to consider a series of key attributes like legibility, typography, colour, grid, image, spatial organisation of elements and orientation. This investigation, through observation of the performance tasks, allows us to conclude that the fact that the users are not active participants in the information document design, from identification of the problem until testing with prototypes, results in a misuse of the information document, failure to identify the important information, non-recognition of others, misinterpretation of results, non-comprehension of symbols and words.

The selection of the images in the performance tasks developed made it possible to create a prototype exempt from the problems of the previous

Improving medical information of blood tests results through the application of co-design document. Some of the reading problems found were the existing of a very technical language, symbols that weren't understood, lack of horizontal orientation and absence of symbols that help illiterate to understand their own results. Sometimes the simple solutions are the best to make health information comprehensible to most people. Testing this prototype (figure 6) and find out if it works better is our next task.

NATUREZA: SANGUE	ANÁLISE (MÉTODO)	RESULTADOS	VALORES REFERÊNCIA
	HEMOGLOBINA GLICADA (HbA1c)	36 mmol/mol	20 - 42 *
* Norma DGS nº 033 / 2011			
NATUREZA: SORO	GLICOSE (Hexoquinase)	85 mg/dL	70 - 110
	CREATININA (Jaffé-Cinético)	0,53 mg/dL	0,50 - 0,90
	COLESTEROL TOTAL (Enz. Colorimétrico)	240 mg/dL	> 90 < 190 ☹
	COLESTEROL HDL (Enz. Colorimétrico)	59 mg/dL	> 45
	COLESTEROL LDL (Enz. Colorimétrico)	167 mg/dL	< 115 ☹
	LIPOPROTEINA(a)Lp(a) (Imunoturbidimétrico)	53 mg/dL	< 30 ☹
	ALIPOPROTEINA A1 (Imunoturbidimétrico)	154 mg/dL	> 160 ☹
	ALIPOPROTEINA B (Imunoturbidimétrico)	120 mg/dL	< 150
	TRIGLICÉRIDOS (Enz. Colorimétrico)	54 mg/dL	< 150

< menor que; > maior que;

Figure 6 Prototype sample.

Conclusion

In future research, we want to develop a straight dialogue between the user and the health providers through application of the Design Thinking approach and the Co-Design methodology, in order to develop projects to improve medical information communication. By doing so, we enable health autonomy, and provide citizens with better literacy skills. Since behaviour change may be a good response to some health problems (O'Sullivan et al., 2003), and to change behaviours users has to understand information, it is crucial to provide users with knowledge in order to motivate this change. Better understanding of health information gives the opportunity to easily and quickly read information and act on it and consequently promote change behaviour. The more informed we are, the more responsible we become.

References

- Brown, T. (2009) *Change by Design: How Design Thinking Transforms Organizations and Inspires Innovation*. New York: HarperCollins Publishers.
- Buchanan, R. (1992) Wicked Problems in Design Thinking. *Design Issues*, 8(2), 5-21.
- Carrapiço, E. and Ramos, V. (2012) Doctor-patient Communication: A Proposal for Continuous Improvement in Clinical Practice. *Revista Portuguesa de Medicina Geral e Familiar*, 28 (3), 212-222.
- Cho, H. (2012) *Health Communication Message Design – Theory and Practice*. London: Sage.
- Cross, N. (2011) *Design Thinking*. Oxford: Berg.
- Curedale, R. (2013) *Design Thinking: Process and Methods Manual*. Topanga: Design Community College.
- Espanha, R. (2009) *Saúde e Comunicação numa Sociedade em Rede – o Caso Português*. Lisboa: Monitor.
- Huelat, J. B. (2007) *Wayfinding: Design for Understanding*. Washington: The Center for Health Design.
- Instituto Nacional de Saude (INSA) (2011) *Brochure of the Health Promotion and Chronic Diseases Department*. Lisbon.
- Jacobson, R. (1999) *Information Design*. London: MIT Press.
- O’Sullivan, G.A., Yonkler, J.A., Morgan, W. and Merritt, A.P. (2003) *A Filed Guide to Designing a Health Communication Strategy*. Baltimore: John Hopkins Bloomberg School of Public Health.
- Osborne, H. (2006) How Visuals Can Help Tell the Healthcare Story. *Journal of Visual Communication in medicine*. *Journal of Visual Communication in Medicine*, 29 (1), 28-32.
- Papanek, V. (1984) *Design for the Real World*. London: Thames & Hudson.
- Sanders, E. and Stappers, P.J. (2008) Co-creation and the new landscape of design. *International Journal of Co-creation in Design and the Arts*, 4 (1), 5-18.
- Schwartzberg, J., Vangeest, J. and Wang, C. (2005) *Understanding Health Literacy – Implications for Public Health*. *Journal of the National Medical Association*, 98 (6), 980-981.
- Simon, H. (1999) *The Sciences of the Artificial*. Cambridge: MIT Press.
- Steen, M. (2013) Co-design as a process of Joint Inquiry and Imagination. *Design Issues*, 29 (2), 16-28.
- Teixeira, J.A.C. (2004) Comunicação em saúde: Relação Técnicos de Saúde - Utentes. *Análise Psicológica* 22 (3), 615-620.

Improving medical information of blood tests results through the application of co-design

Tschimmel, K. (2011) *Design as a Perception-in-Action Process*. In Taura, Y. and Nagai, Y. (eds.), *Design Creativity 2010*. London: Springer Verlag.

Whiteley, N. (1993) *Design for Society*. London: Reaktion Books.

Enhancing Corporeal Boundaries through Technology

Secil UGUR YAVUZ*

In the last decades there has been an increasing interest in human body and technology relation that enhances the natural borders of human body by pushing them further to widen its limits. Today, wearable technology and its human-centred applications can improve human body's capabilities in order to create a healthier, happier and more connected society. These solutions create a more engaging interaction, where the human body acts in the central point. While smart textiles can sense bodily and environmental data, they can also respond to these data through changing their states. Through wearing these embodied interfaces human body itself can become an interface, in which it is impossible to define where boundary of the self ends and others start. This paper focuses on various human-centred design cases, where wearable technology is used as embodied interface in order to enhance emotional wellbeing in three different modalities: physically, psychologically and socially. Besides the case studies, the paper represents a design concept with a user-scenario, where wearable technology is applied in a system to assist children with special needs.

Keywords: *Wearable technology; embodied interaction; emotional wellbeing, therapy*

Introduction

In the last decades there is an increasing interest in human body and technology relation, in which both artefacts function as a holistic entity in order to enhance the natural borders pushing them further to widen the abilities of human beings. Although few decades ago the future's human being was pictured as a cyborg, which is a mix of flesh and robot; today with the improvements in nanotechnology, micro-electronics, e-textiles, wearables and furthermore the involvement of designers into this multi-disciplinary research with a human-centred approach the image of 'super-

* Corresponding author: **Secil Ugur Yavuz** | e-mail: secil.ugur@gmail.com

human' has changed into a more inherent organism that has supernormal skills. Without making a radical change on the human silhouette, technology can be placed on the body imperceptibly in order to create healthier, happier and more connected society. Embodied interfaces, in which the technology is seamlessly integrated into the physical world, allow human body to interact with digital data through using bodily abilities such as expressive gestures and fine-motor skills. These interfaces create a more engaging interaction, where the human body is the central of attention.

Due to the integration of technology and textiles, it is possible to turn the clothes into interactive surfaces that can act as sensors or transmitters. These new 'prosthesis' can help people to live in a more sensorial way, increase their well-being and make them connected with others. Smart textiles have various capabilities that allow designers to create intelligent artefacts functioning comprehensibly as extensions of human body and of its senses. While some smart textiles can sense bodily and environmental data, some of them can respond to these data through changing their states. They can act both as sensors and displays. Through wearing these embodied interfaces human body itself can become the interface, in which it is impossible to define where boundary of the self ends and others start.

This paper focuses on various human-centred design case studies, where wearable technology is used as embodied interface in order to enhance emotional wellbeing in three different modalities: physically, psychologically and socially. Through giving examples of applied researches, this paper tries to underline the role of technology as a seamless mediator in order to create innovative solutions that involve human body as the main actor of interaction. Besides the case studies, the paper represents a design concept with a user-scenario, where smart textiles are applied in a system to assist children with special needs.

Redefining Boundaries

Boundary means a limit that identifies a territory. By using this spatial metaphor Lakoff and Johnson (1999) defines human body as a container with a boundary that creates an inside and outside phenomenon. The existence of this boundary was also mentioned by Freud (1955) and Fisher and Cleveland (1968). According to Fisher and Cleveland (1968) the body boundary 'is a screen, which the individual interposes between himself and outer situations and which he can carry with him at all times'. This border of separation between the body and the outer world defines the sense of

individuality and can be altered through perception (Tiemersma, 1987).

Through their 'phantom nose' and the 'phantom head' experiences Ramachandran and Hirstein (1997) discovered that the body image has a temporary and versatile nature and can be altered by an illusion caused in perception. This illusion can also happen through artefacts that are located outside of the body boundary. Objects that are mediators between the human body and the real world can be perceived as parts of the body. For instance, a stick that a blind man uses is no longer an external object, but a medium, through which the man perceives the world (Merleau-Ponty, 1962). Heidegger (1996) describes this phenomenon with the 'ready-to-hand' term, in which the objects becomes transparent in consciousness, while the attention is focused on the action.

Emerging technologies have carried this discussion into a more complex interplay, where boundary of the human body has become fluid as reshaping itself depending on the situation and even has been dissolving. Dyens (2001) says that the twentieth century will be remembered as 'a century, where the living body was blurred, molded, and transformed by technology and culture'. Technology as an extension phenomenon has been first addressed by McLuhan (1964). He defined the new media as an enhancement of exiting organs and human perception. Moreover, Kelly (2010) also defined technology as the 'extended body'. Ihde (2002) mentioned about the embodiment phenomenon through introducing new technologies as prosthesis of the human perception. According to him information technologies can withdraw from the perception while in use and can be perceived as extensions of human body. This phenomenon can be seen also in digital interfaces, where the user is focused on the task, without being aware of the existence of the physical interface (Norman, 1988); so that the human body is extended into a digital space, where it is possible to interact with the intangible data.

Haraway (1991) has carried this phenomenon into an other point of view by describing the integration of technology and human body as a cyborg, which was 'a hybrid of machine and organism, a creature of social reality as well as a creature of fiction'. In her understanding, boundary between man and machine is blurred. Furthermore, Clark (2003) opened up a new perception of what cyborg is through defining 'natural born cyborgs', which do not depend only on a physical integration of technology and flesh, but a ubiquitous connection between technologies and human beings. According to him, cyborg is not a new phenomenon, but people have been cyborgs for centuries, through the use of tools and artefacts.

Today, the physical substance of what we call technology has been vanishing. What Weiser (1991) was envisioning as ubiquitous technology has become real with today's technologies. He mentions a new notion on technologies, in which the technology disappears and 'weaves itself into the fabric of everyday life until it is indistinguishable' (Weiser, 1991). Today, technology has become pervasive, invisible and embedded into space, everyday objects, clothes and even human body. There are no longer the traditional physical interfaces between technologies and human beings, such as keyboards; but an embodied interaction, in which the user engages naturally (Dourish, 2001). The human body can perform through invisible mediators -new technologies- to be the centre of activity.

Wearable Technology as Invisible Mediators

Electronics have been shrinking to nano-scales and becoming invisible to be embedded into daily objects. The image of technology has moved from being mechanic, solid and manipulated with screens and buttons to an image totally flexible, invisible and interactive. Smart materials, which sense and react to the external stimuli (such as mechanical, thermal, chemical, electrical or magnetic) have emerged (Tao, 2001) and changed the way we interact with artefacts. According to Fortunati et al. (2003) technologies have extended the boundaries of the body, through first with clothes, then the synthetic fibres and today with smart textiles and wearable technologies. Thanks to smart textiles and microelectronics, technology can be worn on human body in an embedded way, in which the wearer is not aware of at all. Wearable technology can dissolve the body boundaries through enabling all kinds of data to flow in and out. While it can measure bodily data such as vital signals, body movements, posture, etc., it can also detect outside stimuli. Wearable technology can be connected to a network wirelessly, where the personal information is transmitted to a wider community, a specific group or a specific person. Hence, this ability of transition of personal data to a wide network has turned personal boundaries into mutual ones. Moreover, thanks to wearable applications of haptic technologies it is possible to transmit tactile stimuli in order to create physical presence, provide therapeutic support or simply inform the wearer in an immediate way. Smart textiles that can change phase (shape, colour, emitting light, etc.) are often used in wearable technology in order to carry the natural expressiveness of clothes into a further level that is the capability of immediate transformation. With all characteristics of smart textiles and microelectronics, today it is possible to have a simple shirt that

can behave as a living surface that behaves as an invisible mediator between the human body and real world.

When wearable technology meets with user-centred design approach these abilities can be used in finding solutions for many crucial problems.

Today, human wellbeing is one of the most important concerns of the society that has to be seen with a wider perspective embracing physical, psychological and social needs as whole. The designer's role has been shifting from being a mere shape maker to being a sense giver, which concentrates on not only aesthetical and functional aspects, but also physiological, psychological and social ones that are embedded into user experience. Starting from the real user needs, designer should create new user scenarios, where the wearable technology can solve hectic problems in an invisible way through enabling human body to perform 'impossible' actions.

Therapeutic Wearable Technologies

According to World Health Organization (WHO, 2001) mental health -the basis of wellbeing- is a state 'in which the individual realizes his or her own abilities, can cope with the normal stresses of life, can work productively and fruitfully, and is able to make a contribution to his or her community'.

Mental health is interconnected with social and emotional wellbeing, therefore can be supported through enhancing the quality of these factors in people's lives. Today, with the developments in technology and material science, there are new attempts that involve engineers and designers in order to create new solutions of prevention and therapy for supporting mental health. While wearable sensors can provide easy and mobile monitoring of user's inner state, wearable sensory interfaces can create novel solutions for reproducing and transmitting emotions that can be used for enhancing social and emotional wellbeing.

Wireless wearable solutions provide easy monitoring of patients through sensors embedded into clothing that constantly measure vital signs, such as blood pressure, heart rate, etc. Thanks to these wireless sensors, the traditional healthcare system based in hospitals has changed into patient centric care that can be sustained at home (Brown and Penders, 2011).

These monitoring technologies are used also in mental healthcare applications. The psychophysiological parameters, such as heart rate variability, galvanic skin response, breathing rhythm and muscle stress that give important information about emotions can be monitored in an unobtrusive and unnoticeable way by wireless body sensors or sensors

embedded into textiles (Ouwerkerk et al., 2008). 'Affective wearable' term was defined by Picard (1997) as a 'wearable system equipped with sensors and tools which enables recognition of its wearer's affective patterns'. While wearable technology can be used as a self-monitoring system for people to increase their psychological wellbeing and help them to cope with stress, it is also used to prevent, assist and rehabilitate mental disorders, such as depression, stress, anxiety disorder, bipolar disorder, autism etc.

One of the examples of affective wearables that can be worn in daily life is *Affectiva Q Sensor* that measures emotional arousal via skin conductance, temperature and activity (Affectiva Q Sensor, 2014). During the states of excitement or anxiety, electro-dermal activity increases, and during boredom or relaxation it decreases. After the wristband detects the electro-dermal activity, the data is transmitted on a software in PC through Bluetooth connection. Besides, INTERSTRESS (Interreality in the Management and Treatment of Stress-Related Disorders), combines the wearable bio-monitoring system with a 3D virtual role-playing exercises and a mobile app in order to help and control psychological stress (Interstress, 2014). The system creates awareness about physiological warnings of stress, gives advices for relaxation and enable user to improve coping with stress through acting in a virtual environment. This project shows that emotional wellbeing can be enhanced by a system that addresses multiple factors: self-reflection (psychological), acting in the virtual environment (social) and relaxation therapy (physical). On the other hand, *MONARCA* is a project that is based on smartphone-centred wearable sensors network recognizing early warning signs and predict maniac or depressive episodes (Puiatti et al., 2011). While this application provides self-treatment possibility, it also informs medical staff about the patient's state in order to enhance their therapy program. One of the self-treatment platform solutions that include wearable sensors is the *Affective Diary* that measures emotions captured by body sensors and uploads them into mobile phone with a graphical interpretation (Ståhl et al., 2009). *Affective diary* differs from other applications with its interpretation of emotional states through using abstract colours and shapes in a digital user interface and the possibility to upload photos, text messages and music for self-reflection. While wireless wearable sensors can track user's emotions in a non-disturbing way, the digital platforms that are linked to these sensors allow users to understand in which situation they get emotional break downs and what kind of preventions they can do in order to regulate their emotions. Besides mobile apps or softwares, emotional state of the wearer can be reflected on a daily

life object. For instance, *Smart Photo Frame* is an object that can be placed in the office desk and connected with wearable biosensors wirelessly in order to give real time feedbacks about the stress level of the wearer (Kimmy et al., 2011). This object that seems as a normal photo frame becomes a reflection of inner state through LEDs embedded into the structure.

On the other hand, touch therapy is commonly used method to rehabilitate psychological disorders. Through wearable applications of haptic technologies, touch therapy can be applied in a subtle way through a simple vest or jacket. For instance, *Squeeze Me* is a vest that simulates therapeutic holding by an embedded pneumatic system in order to prevent panic attacks in autistic children and to help them to manage aggression (Vauccelle et al., 2009). On the other hand, *T.Jacket* provides touch therapy for people with autism through simulating feeling of hug with a jacket that is controlled with smartphone/tablet (T. Jacket, 2014). Besides, *Stress OutSourced* (SOS) is a wearable system that enables anonymous users to send each other therapeutic massages as strokes to relieve stress (Chung et al, 2009).

Through smart textiles that can absorb and realize scent, wearables systems can also provide olfactory therapy. *eScent* is a wearable device that can dispense sensory effects in response to a stimulus (i.e. timer, biometric sensor or switch) as an aromatherapy tool for stress and anxiety reduction (Tillotson, 2014).

On the other hand, LEDs can be easily embedded in textiles in order to reflect biorhythms. The *GER mood sweater* displays excitement levels with an illuminated collar that is connected with biosensors located on the hands (Sensoree, 2014). LED lights embedded collar changes colour according to emotions and creates an artificial blushing effect on the human face. While this kind of products can enhance the communicative level of human body, it can also provide a colour-light therapy for its wearer.

Design Concept of a Wearable System for Children with Emotional Disorder

Emotional disorder can begin in early childhood. Emotions are linked to actions, therefore fear and anxiety can cause fight or flight behaviour, in which the child withdraws or becomes aggressive. Children with emotional disorder generally cannot cope with these emotions and as a result they show aggression or opposite emotion that is withdrawal in a social

environment. Anxiety disorder that can be seen frequently as a mental health problem in young children (Albano et al., 2003) causes to feel worry or frightened towards various situations that cannot be easily recognized by others. This disorder can also limit children's social interaction abilities (Stroul and Friedman, 1994) and lead to social alienation and isolation. If the anxiety disorder is not cured or prevented in early childhood, it can cause depression and other mental problems in adulthood (Huberty, 2004).

There are various types of prevention therapy in order to help children to have healthy emotional development and to build strong social bonds. Play therapy is one of the therapies used in childhood that can reduce anxiety, depression and aggression (Goldstein, 1994). On the other hand, relaxation techniques can be applied on children to cope with their stress and anxiety. For instance, in order to reduce physical effects of panic, patients can do respiratory exercises that let them breathe slowly (Clark et al., 1985; Hibbert and Chan, 1989).

During the PhD thesis *Embodiment of Emotions Through Wearable Technology* (Ugur, 2012), several prototypes were realized in order to show how wearable technology could support communicating emotions and based on the results of this study possible user scenarios were developed. One of the design concepts based on these scenarios focuses on child-caregiver relationship. This concept aims to combine two modalities of therapy (play and respiratory therapy) with affective measurement methods in order to assist children with anxiety disorder to develop healthy social bonds with their family and to cope with stress-anxiety. Since children with anxiety disorder generally have the difficulty to regulate their emotions and this also causes problems in their social environment, this conceptual system aims to focus on not only preventing panic attacks, but also create an emphatic social connection with the care-giver\parents. The idea is to combine Galvanic Skin Conductance sensors that detect arousal level and light embedded interactive surface within a wristband that provides play and relaxation therapy. Involving parents in play therapy can be more effective than being conducted by professionals (Bratton et al., 2005). Therefore, in this concept the parents\care giver will be involved in an active role, which is an important part of the play.

The system is composed by two wristbands that are worn by the child and his\her parent or caregiver. The conceptual system functions in these following steps:

1. Wearable bio-sensor that are embedded into wristband of the child measures the arousal level, and activates the system when the child arrives to a certain level of stress that can cause panic and anxiety.
2. The sensors activate LEDs placed in both wristbands. LEDs simulate a slow breathing pattern in order to help the child to modify her\his breathing for relaxation. The same happens also in the parent's wristband as a sign that the child has reached to a high arousal. On the other hand, others in the same environment, who see the blinking wristband of the child, can recognize that he\she may be in difficulty with stress.
3. When the child starts moving his\her hand, LEDs in the wristband change colour according to the movement that is detected by an accelerometer. This leads a play situation and helps him\her to distract attention from what has created the stress. This interactive game helps child to act out through body gestures. This is the first step of play, where the child is alone.
4. In the second step of the play, the parent arrives next to the child. When parent's wristband gets close to the child's band, the LEDs start creating colourful patterns that provide a playful ambient for child and care giver. Depending on how they move their hands together, the patterns change and this leads a game that is played by the parent and the child.
5. When the child is engaged with the play, the arousal level stays high. Once the child starts getting bored from the game, the sensors can detect the low arousal and shuts down the system until new stress detection happens.

This concept aims to merge physical, psychological and social aspects in a wearable system that enables children with special need to become healthier, happier and more socially engaged. While the wearable technology provides an easy monitoring of emotional state, it also helps to have a gesture-based interaction through playing. The wristbands become a part of the body and provide an embodied interaction. This concept shows that when wearable technology meets with real user needs, it can solve vital problems by enhancing the user's abilities.

Conclusion

Since the mankind started to create tools, probes and artefacts to fulfil their needs, they have been evolved and transformed by what they created. Technologies that are mediations between human beings and real world have been shaping our perceptions, interpretations, actions (Verbeek, 2005) and moreover our bodies. Today, emerging technologies have been penetrating into human body through pushing its boundaries towards new dimensions. This phenomenon has been carried into a further level by wearable technology that enables human body to be the main actor of interaction. While through embedded sensors bodily data such as heart rate, respiratory rate, and gestures can be monitored, through wireless networks this data can be transmitted to others or to a digital platform. This ability to transmit data from inside to outside can be used as a solution for crucial user-needs through user-centred design approach.

This paper represents a design concept with a user-scenario, where wearable technology is applied in a system to assist children with special needs. The system envisioned in this paper is an example of how wearable technology can draw attention into human body by enhancing its physical, psychological and social wellbeing. In this concept, wearable technology functions as a mediator that brings together the child and his/her parent and assists them to play/relax in an embodied interaction. However, this system can also have side effects and limitations during the use as well. Therefore, a deeper study with user tests should be done in order to understand user behaviour and to develop the concept further with user feedbacks.

References

- Affectiva Q Sensor (2014) Affectiva Q Sensor. [online] Available from: <http://acuity-intelligence.com/images/13106.pdf> [Accessed: 18th May 2014]
- Albano, A.M., Chorpita, B.F. and Barlow, D.H. (2003) *Childhood anxiety disorders*. In Mash, E.J. and Barkley, R.A. (eds.), *Child psychopathology*. New York: Guildford Press.
- Bratton, S., Ray, D., Rhine, T. and Jones, L. (2005) The efficacy of play therapy with children: A meta-analytic review of treatment outcomes. *Professional Psychology: Research and Practice*, 36 (4), 376-390.
- Brown, L. and Penders, J. (2011) Wearable Health 'Companions'. *Journal of Cybertherapy and Rehabilitation*, 1, 16.

- Chung, K., Chiu, C., Xiao, X. and Chi, P. (2009) *Stress OutSourced: A Haptic Social Network via Crowdsourcing*. Paper presented at the Proceedings of CHI, Boston, MA, USA.
- Clark, A. (2003) *Natural-Born Cyborgs: Minds, Technologies, and the Future of Human Intelligence*. Oxford: Oxford University Press.
- Clark, D.M., Salkovskis, P.M. and Chalkley, A.J. (1985) Respiratory control as a treatment for panic attacks. *Journal of Behavior Therapy and Experimental Psychiatry*, 16 (1), 23-30.
- Dourish, P. (2001) *Where the action is: the foundations of embodied interaction*. Cambridge: MIT Press.
- Dyens, O. (2001) *Metal and Flesh, The Evolution of Man: Technology Takes Over*. Cambridge: MIT Press.
- Fisher, S. and Cleveland, S. (1968) *Body Image and Personality*. New York: Dover.
- Fortunati, L., Katz, J.E. and Riccini, R. (eds.) (2003) *Mediating the human body: Technology, communication, and fashion*. Mahwah: Lawrence Erlbaum.
- Freud, S. (1955) *Beyond the Pleasure Principle*. London: Hogarth.
- Goldstein, J.H. (1994) *Toys, Play, and Child Development*. Cambridge: Cambridge University Press.
- Haraway, D. (1991) *Simians, Cyborgs And Women: The Reinvention Of Nature*. 149-181. New York: Routledge.
- Heidegger, M. (1996) *Being and Time*. Oxford: Blackwell.
- Hibbert, G.A. and Chan, M. (1989) Respiratory control: Its contribution to the treatment of panic attacks: A controlled study. *British Journal of Psychiatry*, 154, 232-236.
- Huberty, T.J. (2004) Anxiety and anxiety disorders in children: Information for parents. [Online] Available from: www.nasponline.org/resources/intonline/anxiety_huberty.pdf [Accessed: 18th May 2014]
- Ihde, D. (2002) *Bodies in Technology*. Minneapolis: University of Minnesota Press.
- Interstress (2014) Interstress [Online] Available from: <http://www.interstress.eu/index.php/en/project> [Accessed: 18th May 2014]
- Kelly, K. (2010) *What Technology Wants*. New York: Viking Press.
- Kimmy, A., Chen, W. and Lindsay, B. (2011) *Smart Photo Frame for Arousal Feedback—Wearable sensors and intelligent healthy work environment*. Paper presented at the Proceedings of Workshop on Smart Offices and

- Other Workplaces of the 7th International Conference on Intelligent Environments, Nottingham, UK.
- Lakoff, G. and Johnson, M. (1999) *Philosophy in the Flesh: the Embodied Mind and its Challenge to Western Thought*. New York: Basic Books.
- McLuhan, M. (1964) *Understanding Media: The Extensions of Man*. New York: McGraw-Hill.
- Merleau-Ponty, M. (1962) *Phenomenology of Perception*. London: Routledge.
- Norman, D. (1988) *The Design of Everyday Things*. New York: Basic Books.
- Ouwerkerk, M., Pasveer, F. and Langereis, G. (2008) *Unobtrusive sensing of psychophysiological parameters: some examples of non-invasive sensing technologies*. In Westerink, J., Ouwerkerk, M., Overbeek, T.J.M. and Pasveer, W.F. (eds.), *Probing Experience. From Assessment of User Emotions and Behaviour to Development of Products*. New York: Springer.
- Picard, R.W. (1997) *Affective computing*. Cambridge: MIT Press.
- Puiatti, A., Mudda, S., Giordano, S. and Mayora, O. (2011) *Smartphone-Centred Wearable Sensors Network for Monitoring Patients with Bipolar Disorder*. Paper presented at the Proceedings of 33rd Annual International IEEE EMBS Conference. Boston, MA.
- Ramachandran, V.S. and Hirstein, W. (1997) Three laws of qualia: neurology of consciousness. *Journal of Consciousness Studies*, 4 (4-5), 429-457.
- Sensoree (2014) Sensoree [Online] Available from: <http://sensoree.com/artifacts/ger-mood-sweater/> [Accessed: 18th May 2014].
- Ståhl, A., Höök, K., Svensson, M., Taylor, A.S. and Combetto, M. (2009) Experiencing the Affective Diary. *Personal and Ubiquitous Computing*, 13 (5), 365-378.
- Stroul, B.A. and Friedman, R.M. (1994) *A System Of Care For Children And Youth With Severe Emotional Disturbances*. Washington: Georgetown University Child Development Center.
- T.Jacket (2014) T.Jacket [Online] Available from: <http://www.mytjacket.com/> [Accessed: 18th May 2014]
- Tao, X. (2001) *Smart Fibres, Fabrics and Clothing*. Cambridge: CRC Publishing.
- Tiemersma, D. (1987) *Body schema and body image: an interdisciplinary and philosophical study*. Amsterdam: Swets and Zeitlinger.
- Tillotson, J.R. (2014) Smell The Colour Of The Rainbow: Sensory Systems For Wearable Product Technologies To Reduce Stress And Sleep Disorders

SECIL UGUR YAVUZ

[Online] Available from: <http://gtr.rcuk.ac.uk/project/5E8ADEFB-3D0E-4C1C-91C2-197E5620A17D> [Accessed: 18th May 2014].

Ugur, S. (2012) *Embodiment of Emotions through Wearable Technology*. PhD Thesis, Politecnico di Milano.

Vaucelle, C., Bonanni, B. and Ishii, H. (2009) *Design of Haptic Interfaces for Therapy*. Paper presented at the Proceedings of, Boston, MA, USA.

Verbeek, P.P. (2005) *Beyond the Human Eye: Mediated Vision and Posthumanity*. Paper presented at the Proceedings of AIAS Conference 'Mediated Vision'.

Weiser, M. (1991) The Computer for the 21st Century. *Scientific American* 265 (3), 66-75.

WHO (2001) *Strengthening mental health promotion*. Geneva: World Health Organization.

Il progetto della casa sensibile – Designing the Sense-Able Home

Niccolò CASIDDU*, Claudia PORFIRIONE, Matteo ZALLIO
Università degli Studi di Genova

Diversi studi dimostrano come l'ambiente, il contesto in cui si vive ed il contesto familiare, costituiscono un fattore decisivo per il benessere psico-fisico della persona anziana. Le azioni del Design, devono orientarsi alla ricerca e all'individuazione di quelle soluzioni che ottimizzano la risposta ai bisogni dell'anziano, con lo scopo di sostenerne l'autonomia e l'indipendenza attraverso supporti, ausili e stimoli relazionali, ambientali, tecnologici ed assistenziali. L'approccio progettuale per l'habitat residenziale proposto, tende a sviluppare un sistema di Home Sensing e Home Actuating, in coerenza e complementarietà con quanto proposto per la SenseAble City (Ratti, 2012). Punto nodale per la realizzazione di uno scenario attuabile nell'immediato è l'integrazione dei sistemi con l'ambiente e il progetto dell'interfaccia di utilizzo dei device di controllo utente. Attuando una serie di good-practices del Design è possibile favorire il diffondersi di una nuova cultura del progetto, che possa contribuire al miglioramento del sistema del welfare assistenziale sostenibile e che garantisca la riconoscibilità dei diritti della persona anziana, tra i quali il mantenimento di un ruolo attivo e la partecipazione alla vita della comunità in ogni fase della vita.

Keywords: design for all; human centered robotic design; senseable home; monitoraggio della persona; sicurezza; ageing; longevità attiva; interaction design

Introduzione

Lo scenario che si sta delineando sempre in misura maggiore nel corso di questi anni prevede la permanenza delle persone anziane e/o affette da micro-disabilità, sostenute da piccoli interventi di carattere socio-assistenziale e sanitario, nel proprio habitat domiciliare.

* Corresponding author: Niccolò Casiddu | e-mail: casiddu@arch.unige.it

Ogni anno circa un terzo dei soggetti che hanno più di 65 anni è soggetto a caduta e, fra gli anziani che risiedono in strutture assistenziali la percentuale risulta essere ancora maggiore; si calcola, infatti, che l'incidenza delle cadute nelle case di cura e negli ospedali sia due o tre volte superiore rispetto a quella delle cadute che avvengono nell'abitazione (ISTAT, 2002).

È utile riportare alcune conclusioni dello studio Argento (ISS, 2003), promosso dall'Istituto Superiore di Sanità e condotto nel 2002 in 11 regioni e province italiane tra cui: Piemonte, Liguria, Provincia Autonoma di Bolzano, Veneto, Emilia Romagna, Marche, Puglia, Campania, Basilicata, Sicilia e Sardegna, per mezzo di interviste domiciliari a 2.366 persone. La ricerca ha delineato quali siano le necessità assistenziali dell'anziano sottolineando le differenze territoriali e il divario tra offerta di assistenza e i traguardi ottimali cui mirare. Tra i dati più importanti che emergono dalle interviste, il 27% degli intervistati ha riferito di aver subito una caduta nell'ultimo anno e l'8% è caduto più di una volta; il 41% delle persone dichiara di essere caduto in casa; gli ambienti domestici dove avvengono più frequentemente le cadute sono la camera da letto (23%), la cucina (18%), le scale (14%) e il bagno (9%) (ISS, 2003).

Le cadute possono essere provocate da fattori intrinseci quali: alterazioni legate all'età, disturbi che colpiscono le funzioni necessarie al mantenimento dell'equilibrio come le funzioni vestibolare, propriocettiva e visiva, difficoltà cognitive, problemi muscolari e scheletrici e da fattori estrinseci come la presenza di ostacoli in casa o le differenti attività espletate. In particolare, la ricerca ha evidenziato come differenti fattori aumentino il rischio di malori e di cadute per gli anziani, nel dettaglio si riconoscono cause quali: rischi domestici ed isolamento sociale, storia di precedenti cadute, paura di cadere, terapie polifarmaco e assunzione di farmaci particolari, alterazione della mobilità ed alterazione della vista.

Nella tabella seguente sono riportati alcuni dati che dimostrano quanto sia elevata la percentuale media di cadute, legate ai fattori ambientali e domestici.

Tabella 1 Cause di cadute negli anziani in 12 studi che hanno valutato attentamente gli anziani dopo una caduta e specificato la causa (Jensen et al., 2003). 1 = percentuale media calcolata da 3.628 cadute in 12 studi; 2 = minimo – massimo; 3 = questa categoria include artrite, malattie acute, farmaci, alcol, dolore, epilessia e caduta dal letto.

Cause	Percentuale media (1)	Range (2)
Accidentale – correlata all'ambiente	31 %	1 - 53 %

Il progetto della casa sensibile – Designing the Sense-Able Home

Disturbo di andatura, riduzione della forza muscolare	17 %	4 - 39 %
Capogiri, vertigini	13 %	0 - 30 %
Collasso	9 %	0 - 52 %
Confusione	5 %	0 - 14 %
Ipotensione posturale	3 %	0 - 24 %
Disturbo visivo	2 %	0 - 5 %
Sincope	0,3 %	0 - 3 %
Altre cause specificate (3)	15 %	2 - 39 %
Cause sconosciute	5 %	0 - 21 %

La valutazione del pericolo di caduta eseguita da professionisti sanitari con competenze specifiche deve includere alcuni parametri fondamentali come l'identificazione di una storia di cadute, la valutazione della deambulazione, equilibrio e debolezza muscolare, una valutazione della condizione osteoporotica, una valutazione dell'abilità funzionale soggettivamente percepita dall'anziano e paura correlata al cadere, una valutazione delle alterazioni della vista, una valutazione del deterioramento cognitivo ed esame neurologico, una valutazione dell'incontinenza urinaria, un esame cardiovascolare ed una eventuale revisione del trattamento farmacologico.

Inoltre, l'ambiente in cui la persona anziana risiede, può diventare un'ottimo condensatore di soluzioni per vivere in maniera sicura in condizione di benessere, fruendo in maniera semplice ed efficace dello spazio architettonico e delle tecnologie. L'attenta analisi dei dati di rischio è fondamentale per capire in quali punti agire e come indirizzare le strategie progettuali per generare soluzioni architettoniche sicure, dove le criticità siano ridotte al minimo e dove le componenti tecnologiche installate possano diventare degli ausili per i sensi, per le capacità e per gli arti degli utenti, al fine di aiutare e facilitare la vita alle persone anziane.

La strategia progettuale: Sense-Able home

La casa, oggi intesa come rifugio dagli stress giornalieri, luogo protettivo e confortevole, spazio altamente privato e ineludibile, può portare con sé un equipaggiamento che si modifica nel tempo a seconda delle richieste particolari dei differenti fruitori. Analizzando le problematiche presenti nelle abitazioni comuni e delle persone che vivono al loro interno e seguendo i

dettami del Design for All (Accolla, 2009) ed i principi di progettazione che pongono l'uomo al centro del progetto (User Centered Design), la principale esigenza che sorge quando sussistono mutate le condizioni di vita al contorno per una persona anziana, è la rivisitazione dell'habitat in cui si vive.

Per raggiungere questo obiettivo, tenendo conto delle necessità degli individui, del patrimonio edilizio esistente e delle limitazioni tecnologiche (seppur contenute tutt'oggi), la Building Automation, intesa come scienza che si occupa di integrare e automatizzare i dispositivi della casa, degli edifici e degli ambienti di vita in generale, assume un ruolo decisivo nel fornire un supporto tecnologico in maniera efficace e rapida da installare, allo svolgimento delle azioni giornaliere. Occorre quindi ripensare, rifunzionalizzare e ridisegnare l'intero ambiente domestico, che parte dal sistema del vicinato, agli spazi comuni interni ad un edificio, fino a giungere all'unità abitativa singola per fare in modo che diventi fruibile, adattata ed adattabile alle mutate necessità dell'utente. L'approccio progettuale proposto per l'habitat residenziale, tende a sviluppare un sistema di 'Home Sensing' e 'Home Actuating', in assonanza con quanto enunciato dall'arch. Carlo Ratti, a capo del 'Senseable City Lab' del MIT di Boston '... per le nostre città, ci sono migliaia di dispositivi per il Sensing, che incamerano e registrano informazioni dall'esterno e in base alle quali si può programmare un Actuating, un agire che si basa sulle informazioni ricevute. È la stessa cosa che facciamo noi esseri umani quando ad esempio ci presentiamo a qualcuno: vediamo il suo viso, la sua voce, stringiamo la mano e poi rispondiamo...'.

Si definisce quindi il paradigma della '*Home Sensing*' ovvero l'attività di raccolta ed elaborazione di grandi volumi di dati relativi all'ambiente ed alle attività umane all'interno della propria realtà domestica, con il quale si intende non solo analizzare le informazioni che descrivono l'ambiente residenziale, ma agire sul comfort e sul benessere dell'*user*, utilizzando la sufficiente e necessaria quantità di dotazione tecnologica, ottimizzando le risorse già presenti. L'attività di '*Sensing*' non è data semplicemente da una fitta rete di sensori dislocati all'interno della casa, ma da un numero ridotto di elementi che opportunamente calibrati sulle esigenze degli utenti riescono a soddisfare a pieno le richieste, avvalorando il principio della corretta pratica di progettazione *Human Centered Robotic Design* (HCRD) (Casiddu, 2011), che mira ad ottimizzare le risorse, ottenendo il massimo della resa con l'utilizzo delle tecnologie robotiche e di *Information & Communication Technologies* dedicate e di conseguenza con minima

invasività negli ambienti.

All'interno del contesto abitativo le tecnologie *ICT*, ancora non entrate a far parte a pieno titolo della dotazione standard di base delle abitazioni in costruzione ed esistenti sul territorio nazionale, diventano di primaria importanza per integrare ed automatizzare i dispositivi della casa, ad esempio utilizzando lo stesso sensore per fruire di più informazioni e dati.

L'integrazione all'interno di un sistema intelligente è la capacità di comunicare con differenti *device*, portando la loro gestione ad un livello comunemente accessibile. Significa garantire la possibilità d'interazione tra i vari componenti appartenenti a pacchetti tecnologici differenti. Ad esempio un sensore di rilevazione presenza potrebbe essere utilizzato non solo per la sicurezza antintrusione ma, sulla base di opportuni parametri settati a monte, può assolvere alle funzioni di accensione/spengimento di impianto luminoso, di riscaldamento, oppure monitorare lo stato di attività di una persona (Quaranta, 2013).

L'introduzione di adeguate '*Active-Technologies*' e '*Soft-Technologies*', ha lo scopo di ottenere innumerevoli vantaggi, tra cui:

- Un controllo efficace e semplificato grazie all'utilizzo delle interfacce, delle applicazioni domestiche sia dall'interno che dall'esterno della casa;
- Un aumento delle comunicazioni con l'esterno permettendo l'accesso a facilitazioni e servizi pubblici e privati;
- La condivisione di applicazioni semplificate, le quali portino ad una gestione parsimoniosa finalizzata a:
 - Risparmio energetico, con un controllo delle risorse energetiche;
 - Sicurezza;
 - Controllo remoto della casa;
 - Accesso a servizi esterni;
 - Indipendenza ed autonomia;
 - Benessere e Comfort;
 - Intrattenimento e svago.

Le *Smart Technologies* inserite all'interno del sistema domestico, possono essere suddivise secondo ambiti di azione definiti:

- Rilevazione: reti di sensori e dispositivi posizionati su differenti oggetti ed arredi, in qualsiasi luogo, nei capi indossabili, sulla

superficie o internamente, nei dispositivi o all'interno dell'ambiente circostante;

- Elaborazione: aggregazione, elaborazione ed analisi di dati trasformati in informazioni all'interno di spazi differenti e spesso collegati trasversalmente;
- Attuazione: macchine dotate di sensori, per esempio robot, ma anche di elettrovalvole di sicurezza, automatismi domestici e attuatori che, configurati sulla propria percezione dell'ambiente, agiscono a favore degli utenti svolgendo azioni concrete;
- Interazione: interazione intelligente con sistemi e servizi capaci di supportare le capacità e le abilità degli utenti, nonché interazione diretta con l'utente finale;
- Comunicazione: sensori e attuatori collegati ad uno o più sistemi intelligenti, a loro volta connessi ad altri sistemi *outdoor* (Zuccatelli et. al., 2012).

A seguito di questa analisi funzionale, è possibile ipotizzare diversi scenari attuabili tramite differenti device, sensori ed attuatori di semplice utilizzo, come il posizionamento nell'ecosistema domestico di: strumenti di automazione *indoor* ed *outdoor* per azionare dispositivi per la regolazione dell'illuminazione, apertura-chiusura di finestre e porte, sistemi di oscuramento, sistemi di riscaldamento o raffrescamento, sistemi di controllo in remoto per la sicurezza dell'abitazione come allarmi anti-intrusione, rilevatori di gas, sensori di presenza, tag *RFID*. È possibile però, spingersi oltre con gli aspetti di controllo, fino a giungere a sistemi più complessi dove si possa agire in maniera più importante su apparecchiature elettrodomestiche o comunicative della casa: *tablet*, *smart Tv*, *smart washing machine*, *laptop*, piani di cottura, frigoriferi, telecamere, impianto di riproduzione sonora. L'utilizzo del sistema *ICT-based*, integrato da una configurazione di *smart grid*, ovvero da un insieme di elementi e device messi a sistema tra di loro e con altri al di fuori dell'abitazione tramite le reti dati, rilevatori di presenza e d'azione, (come sensori a raggi infrarossi per accensione e spegnimento luci, rilevatori di fumo e di gas nocivi all'interno dell'ambiente), può essere utilizzato oltre che come strumento di telecontrollo, nel rispetto dei vincoli imposti dalla tutela della *privacy* degli utenti, anche come strumento per socializzare e mantenere un contatto con le persone al di fuori della propria abitazione.

Il punto nodale per la realizzazione dello scenario di progetto, riguarda principalmente l'integrazione dei sistemi e dei device con gli utenti e

l'ambiente. In particolare le aree di intervento, definite in base alle funzionalità ed alle specifiche esigenze, analizzate con gli utenti, sono relative a:

- Dispositivi sempre meno invasivi per la *privacy* dell'*user*, come sensori e sistemi portatili di ultima generazione con basso consumo energetico, inclusi dispositivi indossabili (es.: sensori integrabili negli abiti e nelle calzature);
- Reti *wireless/wired* coadiuvate da sistemi *multi-tasking*, con capacità decisionale attiva e con interfacce di tipo *plug&play*;
- Tecnologie per la generazione di energia utile per l'alimentazione dei dispositivi indossabili;
- Nuove interfacce utente *for all*;
- Nuovi sistemi per gestire le informazioni mediche dei pazienti e monitoraggio di parametri vitali e per la gestione dell'assistenza domiciliare;
- Dispositivi e sistemi innovativi per l'inclusione sociale a livello domestico e nel vicinato;
- Nuovi prodotti e componenti per rendere attivi ed automatizzati gli impianti, negli arredi e nelle apparecchiature tecnologiche degli edifici;
- Componenti e sistemi di comunicazione che consentano nel loro insieme di realizzare sistemi tecnologici complessi per migliorare la fruizione e la gestione degli spazi dentro e fuori gli edifici;
- Possibilità di integrare ed ampliare nel tempo e al mutare delle condizioni soggettive il sistema domestico tramite punti e scatole pre-installate in fase di costruzione o rinnovamento edilizio che permettano il posizionamento corretto e possibilità di alimentazione per la sensoristica.

Un'abitazione che collabora con l'utente, che diventa *smart* è una casa che ha al suo interno una rete di sensori connessi e dislocati in differenti punti. I singoli dispositivi di rilevazione, di norma costituiti da un microcontroller di ridotte dimensioni equipaggiato dal sensore (acustico, *RFID*, di presenza, rilevatore di fumo, di gas, a basso costo e tecnologia di trasmissione dati *ZigBee*), vengono dislocati in punti strategici decisi in fase di progetto. I dati verranno successivamente comunicati all'unità centrale che può essere gestita semplicemente grazie a *tablet*, una *smart Tv*, un sistema interattivo di casa, tramite la rete dati *Wi-Fi* o *Bluetooth* a seconda

delle differenti esigenze. Infine l'elaborazione dei dati raccolti, ormai resa possibile anche con l'utilizzo di comuni *device* disponibili sul mercato, può essere condivisa in *real-time* con la centrale di controllo, con il medico, con la centrale di assistenza o familiari e conoscenti.

User needs e tecnologie integrate per l'habitat residenziale

È noto, come le statistiche e le proiezioni future (ISTAT e Comunità Europea) dimostrino e confermino quanto sia importante per una persona anziana, vivere in un ambiente sicuro e confortevole, tenere le relazioni affettive con i propri cari, parenti, amici, mantenere la condizione di salute e di sicurezza e gestire in autonomia le proprie necessità ed esigenze.

A tal fine, la ricerca è orientata allo studio e all'individuazione di quelle soluzioni che ottimizzano la risposta ai bisogni degli utenti anziani, con lo scopo di sostenerne l'autonomia e l'indipendenza, attraverso supporti, ausili e stimoli relazionali, ambientali, tecnologici ed assistenziali.

I presupposti che hanno portato allo sviluppo del progetto di ricerca sono: l'aumento della prevenzione dei fattori di rischio per la salute, l'aumento dell'utilizzo del proprio ambiente domestico come scenario di vita ideale per la terza età, l'aumento delle attività svolte a distanza (grazie a sistemi di tele-presenza, tele-diagnostica, assistenza in remoto) e più in generale i paradigmi dettati dall'*Ambient Assisted Living* (De Munari et. al., 2012).

Alcuni dei punti nodali definiti in fase di progettazione del sistema sono relativi ad allarmi comportamentali e rilevazione di eventi potenzialmente ad alto rischio riguardanti la persona (svenimento, caduta), che comportano una variazione più o meno drastica del comportamento abituale. Poiché l'effetto di questo tipo di segnalazione comporta l'intervento immediato, presso l'abitazione della persona interessata, di personale d'assistenza qualificato, è stato assolutamente necessario evitare falsi allarmi. Ciò significa che la segnalazione non deve essere associata alla semplice informazione proveniente da un sensore, ma deve essere la risultante di informazioni multiple opportunamente elaborate con adeguati algoritmi finalizzati alla riduzione dei falsi positivi.

Potenzialmente ogni evento che caratterizza la vita quotidiana può essere monitorato a questo scopo, come ad esempio il modo con cui l'utente si relaziona con gli elettrodomestici e gli altri oggetti della casa.

Il sistema sarà programmato in modo da segnalare le anomalie, tramite l'individuazione di eventi che possano potenzialmente preludere a situazioni di pericolo o essere indicatori di comportamento anomalo, con riferimento soprattutto a soggetti con problemi legati alla sfera cognitiva.

Inoltre saranno inseriti strumenti per il monitoraggio delle attività giornaliere dell'utente. È prevista la possibilità di monitorare il comportamento giornaliero dell'utente attraverso l'acquisizione e l'elaborazione di tutti gli eventi d'interazione con gli *smart objects* presenti in casa, intendendo con questo termine tutti gli oggetti dell'ambiente domestico che sono in grado di comunicare con la rete locale del sistema.

Il focus principale, è riferito al monitoraggio della condizione fisica e posturale della persona anziana ed alla possibilità di mantenere l'anziano in condizioni di fragilità nel proprio ambiente domestico. Al fine di capire le situazioni di possibile malore, di pericolo e di intervenire tempestivamente per la salvaguardia dello stato di salute della persona, l'impianto tecnologico è stato predisposto per fornire gli alert relativi alle possibili cadute, al controllo della postura e quindi alle abitudini e alle condizioni di soggiorno all'interno dell'abitazione.

Nell'ottica di integrare le componenti di controllo all'interno dei sistemi abitativi, è importante garantire l'interazione del sistema intelligente di monitoraggio, con l'utente, tramite ad esempio consigli d'uso, consigli comportamentali, suggerimenti utili per semplificare le attività della vita quotidiana e suggerimenti relativi alla postura tenuta durante l'arco della giornata.

Il livello successivo di evoluzione del sistema porterà ad informare il personale dedicato sulle condizioni dell'utenza (stato di salute della persona) e sull'eventuale necessità d'intervento in seguito a malori, il tutto grazie ai dati rilevati dai sensori presenti nell'ambiente ed al successivo trasferimento alla piattaforma remota '*Omniacare*' su un server centale.

L'importanza di avere la possibilità di monitorare le condizioni fisiche dell'utente anche da remoto, da parte di un assistente specializzato (medico o infermiere) oltre che dai familiari, garantisce un notevole grado di sicurezza e di tempestività di azione in caso di necessità o di allarmi sullo stato personale di salute.

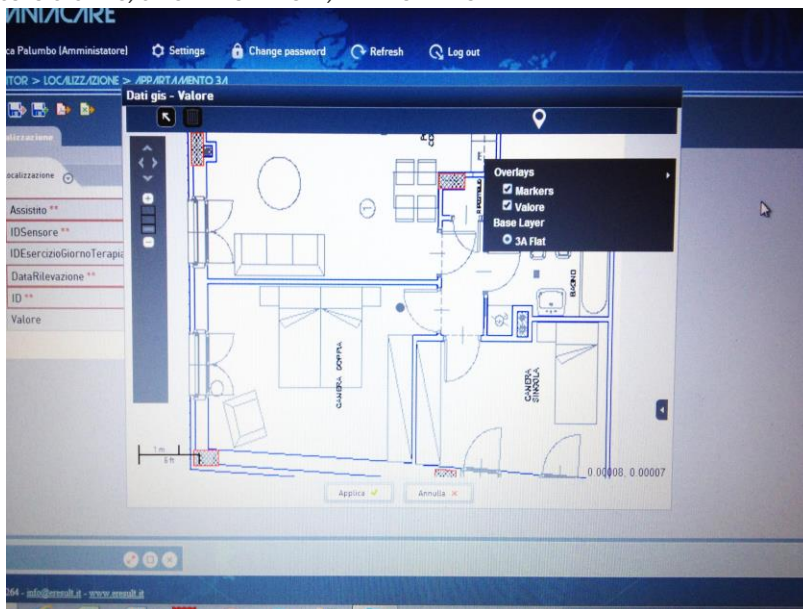


Immagine 1 Schermata del sistema di rilevamento della persona tramite il sistema Omnicare.

Un punto focale della ricerca, riguarda il tracciamento, secondo la necessità dettata dalle condizioni di salute dell'utente, delle sue abitudini, dei suoi comportamenti giornalieri e degli eventuali trend posturali, dove l'insorgere di eventuali anomalie possono costituire indizio di disagio e quindi consentire azioni di prevenzione verso il rischio di incipienti malattie.

Si ritiene preferibile che queste funzioni siano eseguite in maniera distribuita tra i singoli dispositivi che compongono il sistema di sensori, che, a loro volta, devono far riferimento anche ad un'unità centrale di monitoraggio, tramite la quale l'utente possa interagire.

L'obiettivo è quello di diminuire il più possibile l'assistenza istituzionalizzata per le condizioni di disabilità meno gravose, privilegiando un modello di assistenza capillare, all'interno del proprio habitat domestico, attraverso l'utilizzo di sistemi tecnologici integrati. Sostituendo una percentuale elevata di interventi di piccola gravità con la teleassistenza o i sistemi di monitoraggio in remoto, sarà possibile alleggerire il sistema di welfare sia dal punto di vista operativo sia dal punto di vista finanziario.

È importante sottolineare che la quantità di sensori inseriti nello spazio casa, rappresenta un valore molto ridotto, poichè la vera sfida rimane quella

di ottenere la massima resa, in qualità e quantità di dati, da pochi e ben distribuiti sensori, invece che ricoprire totalmente l'abitazione da una fitta e per certi versi sovradimensionata rete di apparati tecnologici.

L'utilizzo appropriato di prodotti e servizi 'intelligenti', basati su tecnologie ICT che includono sia componenti Hardware che Software, deve essere consono alle esigenze ed alle aspettative dell'user, in modo che questi traggano serenità nello svolgimento delle attività quotidiane nel proprio domicilio, fruendo di spazi abitativi tecnologicamente assistiti.

Il progetto della casa sensibile: progettare e ri-progettare gli ambienti domestici per gli anziani di oggi e domain.

Mettendo a sistema i dati riscontrati dalla ricerca in letteratura, con i risultati ottenuti da test effettuati con utenti selezionati, è stato possibile tracciare quali siano stati i punti critici e le plus valenze del sistema 3A – Ambiente Assistito per Anziani e Persone con Disabilità.

Semplici accorgimenti nella fase di progettazione di un'appartamento, sia esso in fase di costruzione ex-novo che di ristrutturazione, possono garantire livelli di upgrade tecnologico, ad oggi molto difficili da riscontrare nelle nostre case. Grazie alla predisposizione di guaine elettrificate in punti studiati e strategici dell'abitazione, alla predisposizione di sistemi domotici integrati (come ad esempio, il comando dell'illuminazione da remoto, comando delle tende ed avvolgibili motorizzati, sensori anti-intrusione, sensori per rilevamento fumi e acqua e con l'utilizzo di sistemi di controllo basati su tecnologia *wireless* per la connessione di sistemi di piccole dimensioni) è possibile raggiungere un elevato standard di controllo e sicurezza della persona oltre che dell'abitazione, servendosi di ridotte quantità di sensori.

Gli elementi che compongono la dotazione tecnologica di base per il monitoraggio ed assistenza della persona sono costituiti da:

- *Netbook, Tablet o Smartphone* per la visualizzazione dati;
- Sensore per rilevamento liquidi;
- Sensore per rilevamento fumi-gas;
- Modulo per la trasmissione dei dati secondo il protocollo *ZigBee*, per trasmissione dati per i sensori rilevamento liquidi e gas;
- Ancore (prototipo *Matrix*) per la geolocalizzazione della persona, in media almeno una per stanza;
- Coordinatore per abilitare il collegamento al PC in modalità *wireless*;

- *Device* indossabile per il monitoraggio dell'utente, che consente di rilevare e trasmettere dati clinici relativi alla frequenza cardiaca, insufficienza respiratoria e caduta;

In particolare, per verificare il funzionamento e l'attinenza delle tecnologie prescelte per monitorare le necessità prefissate, sono stati effettuati differenti test all'interno dell'appartamento pilota situato in Genova.

Il primo test è stato effettuato, con il *device* indossabile utilizzato dagli utenti volontari dell'*AUSER* di Genova, su tutta la superficie dell'appartamento; gli utenti hanno indossato a turno il *device*, dal quale sono stati rilevati con esattezza dati clinici e parametri vitali, quali: postura, temperatura del corpo, indice respiratorio, battito cardiaco, livello di attività fisica.

Foto	Tipo device	Parametro	Valore
	BioHarness	zephyr heart rate	74
	BioHarness	zephyr activity	0,04
	BioHarness	zephyr posture	in piedi
	BioHarness	zephyr skin temperature	33,5
	BioHarness	zephyr respiration rate	33,1
	BioHarness	zephyr heart rate	74
	BioHarness	zephyr activity	0,01
	BioHarness	zephyr posture	in piedi
	BioHarness	zephyr skin temperature	33,6
	BioHarness	zephyr respiration rate	33,3
	BioHarness	zephyr heart rate	76

Immagine 2 Schermata dei valori rilevati tramite il *device* indossabile.

Il secondo test è stato ultimato dagli utenti, con il supporto dei tecnici, per fare in modo che si verificassero le condizioni critiche per testare l'allarme in caso di caduta e la variazione dei parametri biomedicali rilevati tramite *device*. È stato possibile capire e settare l'algoritmo che identifica il momento della caduta, grazie all'accelerazione di gravità misurata da parte dell'accelerometro posto all'interno del *device* e per segnalare in quale posizione l'utente fosse caduto, se in posizione supina o prona.

I risultati sono stati soddisfacenti e il dispositivo ha segnalato con la necessaria precisione tutti gli eventi in cui si sono verificate cadute degli utenti.

Successivamente è stato testato il funzionamento del sistema ‘*Omniacare*’ per verificare l’esattezza della posizione all’interno di ogni camera dell’appartamento. In questo caso, su quattro soggetti, si sono verificati un numero ridotto di ‘false posizioni’, ovvero dove il sistema non identificava in maniera corretta la posizione esatta dell’utente. Il sistema, che acquisisce dati sulla posizione dell’utente ogni quaranta secondi (implementabile con intervalli di minor tempo), ha segnalato alcuni falsi spostamenti o posizioni, mentre in altre occasioni si è dimostrato preciso ed accurato nella segnalazione del punto sulla pianta dell’appartamento in dotazione al software.

Il sistema si basa sulla ‘triangolazione’ del punto ovvero, per essere segnalata la posizione dell’utente che indossa il *device*, devono esserci almeno tre ancore che captino il segnale, garantendo una sufficiente precisione del posizionamento. Si può dire che in questo caso il sistema, a causa di alcune interferenze a livello ambientale necessita ancora di un’ulteriore implementazione e studio.

Infine l’ultimo test, effettuato dal personale tecnico è stato utile per capire l’integrabilità dei segnali di allarme generati da eventuale allagamento e fuga di gas.

L’integrazione dei due sistemi è avvenuta in maniera discreta, ed il loro utilizzo si rivela necessario in caso di problemi relativi a fughe di gas o allagamento dell’appartamento. Si sono rilevati alcuni problemi a livello di trasmissione dati con la rete *ZigBee*, ma sicuramente risolvibili con le successive implementazioni del sistema.

Le strategie di integrazione tecnologica nell’abitazione garantiscono un senso di sicurezza percepita dagli utenti sul grado di accettabilità della tecnologia e sulla possibilità di far conoscere ad assistenti e parenti, in remoto, il proprio stato di salute o un imminente malore, come è stato riscontrato durante la fase di test, all’interno del quale sono pervenuti numerosi feedback positivi da parte degli utenti coinvolti.

In differenti prove a cui sono stati sottoposti gli utenti selezionati, è stato possibile interagire con il sistema che, opportunamente settato, avrebbe garantito uno standard ridotto di invasività tecnologica (evitando di entrare nella sfera privata e nella *privacy* degli utenti anziani), pur essendo in grado di percepire gli stati di allerta o la possibilità di caduta.



Immagine 2 Utenti anziani e component dell'unità di ricerca.

I *feedback* positivi ricevuti dagli utenti hanno provato che in questo caso l'utilizzo di piccoli *device* tecnologici, inseriti in maniera attenta all'interno dell'abitazione, può portare numerosi benefici in termini di sicurezza per la persona. Altresì è stato possibile capire se la dimensione del *device* ed il suo utilizzo prolungato per tutta la giornata potesse portare a fenomeni di rigetto o difficoltà di utilizzo. Alla fine del test i commenti sono stati positivi, a parte qualche appunto sul fatto di ricordare di portare con se il *device*, che seppur di piccole dimensioni, non è ancora in grado di garantire un'ottima indossabilità.

Il basso costo è una delle qualità caratterizzanti del sistema, che implementato in successivi step e sviluppato come prodotto vendibile ed installabile in maniera '*plug&play*' garantirebbe una facilità di installazione da parte degli utenti o dei loro familiari, con una fruizione più ampia e quindi una sicurezza maggiore all'interno delle abitazioni avvalorando quelli che sono stati gli elementi fondanti la ricerca.

Infine, il totale della sola apparecchiatura tecnologica inserita nell'appartamento pilota, escluse le opere murarie, rappresenta un valore che varia dallo 0,4 allo 0,6% del costo totale di un immobile, percentuale che può ridursi ulteriormente grazie ad interventi mirati sia all'ottimizzazione delle componenti del sistema, oltre che grazie alla naturale diminuzione dei costi legati all'innovazione ed allo sviluppo dei sistemi informatici.

Il rapporto costi benefici, alla luce di questi dati, gioca a favore dell'implementazione tecnologica, incentivando la possibilità di vivere in un ecosistema domestico intelligente ad un costo quasi impercettibile se rapportato al valore totale di un'abitazione.

Inoltre l'integrazione dei componenti tecnologici rende l'ambiente intelligente e sensibile alle richieste dell'utente, senza modificare la tradizionale percezione della propria abitazione, senza precludere scelte particolari della sistemazione degli ambienti, facendone al contempo, accrescere il valore di mercato.

Conclusioni

Oggi il sistema assistenziale è ancora profondamente strutturato con metodi assistivi tradizionali, ovvero gestiti direttamente da personale, operatori e medici che si attivano su esplicita richiesta degli utenti o dei familiari, con costi e tempistiche molto elevate. Nel futuro più prossimo, si tenderà a passare da un modello di welfare basato sulla centralità dei sistemi assistenziali, ad un sistema basato sull'aumento della 'domiciliarità', mantenendo il più a lungo possibile la persona nel proprio ambiente familiare, sicuro e confortevole, portando l'assistenza sociale e sanitaria a casa della persona, erogando i servizi destinati alla persona, anche di livello avanzato ed attivando le potenzialità offerte dai territori e dalle comunità locali. Inoltre servirà da supporto a questo cambiamento, lo sviluppo delle Tecnologie per la Società dell'Informazione e della Comunicazione (ICT) sia come strumento abilitante per la capillarizzazione dei servizi ed il controllo dei costi, ma anche e soprattutto come motore fondamentale di cambiamento sociale per una migliore qualità della vita in casa propria.

L'investimento, rappresentato dall'inserimento del sistema tecnologico per il monitoraggio, presenta un plus valore, rispetto ai tradizionali strumenti di assistenza alla persona anziana, che è dato dalla capacità di permanere attivo 24h su 24h, oltre che in maniera prolungata nel tempo, a differenza delle formule già presenti oggi, come assistenti personali o *care giver* professionali, dai costi nettamente superiori. Il valore aggiunto, infine, non è solo da riferirsi alla possibilità di assistenza per la persona, ma anche al valore intrinseco che l'immobile potrebbe acquisire in seguito all'installazione del sistema.

Si può affermare quindi, che la strada intrapresa è corretta e le tecnologie utilizzate hanno permesso di testare con successo quanto sia importante dotare le abitazioni delle necessarie predisposizioni di base, implementabili a seconda delle esigenze degli utenti, in particolare in una fase della vita, in cui le necessità sono in continuo e drastico mutamento.

È stato molto utile confermare che, progettare e quindi anticipare le possibili dotazioni da installare all'interno delle proprie abitazioni possa

rendere persone con piccoli deficit fisico-motori o piccole criticità cognitive, ancora autonome e capaci di vivere serenamente a casa propria, con la sicurezza di avere un sistema di *alert* in grado di percepire eventuali necessità o stati di pericolo.

Basti pensare a quali siano le successive implicazioni e sviluppi di una tecnologia tanto semplice quanto ben integrata all'interno dell'ambiente 'casa', che potrebbe diventare, non solo per gli ultimi anni della propria vita, ma fin dai primi tempi in cui viene acquistato un immobile, in giovane età, un espediente ed un condensatore di facilitazioni, funzionalità, supporto, sicurezza, risparmio per le nostre vite, garantendo elevati canoni di estetica, forma, efficienza ed implementabilità a seconda delle esigenze in mutamento.

Infine, si potrà ancora lavorare sull'aspetto dei device installabili, oltre che dei dispositivi indossabili, che potranno addirittura essere integrati nelle etichette degli indumenti con tecnologie quali ad esempio i tag *RFID*.

L'importanza di intervenire in maniera capillare, mirata e definita solo su alcuni elementi necessari per la riuscita del test ha permesso di confermare l'importanza della strategia progettuale, legata all'integrazione tecnologica negli apparati domestici, per garantire il massimo grado di fruibilità, contenendo la complessità d'uso per l'utente e realizzando un sistema in grado di gestire in autonomia stati di pericolo per la persona, differenti livelli di *alert* e favorendo il benessere dell'anziano.

Molte sono ancora le possibilità che si possono raggiungere per migliorare una delle criticità relative alla crescita dell'età media della popolazione che nei prossimi anni, tenderà ad aumentare. Questo scenario, alla luce dei dati riscontrati e della ricerca effettuata si propone come uno dei possibili e diversificati espedienti per intervenire sul problema della sicurezza domestica, per aumentare l'*affordance* (Gibson, 1977) dei prodotti e delle tecnologie e per mantenere il più a lungo possibile le persone all'interno del proprio habitat domiciliare.

References

- Accolla, A. (2009) *Design for All - Il progetto per l'individuo reale*. Milano: Franco Angeli.
- Casiddu, N. and Micheli, E. (2011) *Human Centered Robotic Design*. Firenze: Alinea Editrice.
- Casiddu, N. (2008) *Il valore dell'accessibilità – Contributi per la progettazione residenziale*. Milano: Franco Angeli.

- Casiddu, N. (2004) *Anziani a casa propria – Linee guida per adeguare spazi e oggetti*. Milano: Franco Angeli.
- De Munari, I., Matrella, G. e Ciampolini, P. (2012) *AAL in Italia, Il primo libro bianco*. Vicenza: TGBook.
- Del Curto, B., Fiorani, E. and Passaro, C. (2010) *La pelle del design. Progettare la sensorialità*. Milano: Lupetti.
- Fagnoni, R. (2006) *A Colori, strategie di progetto per l'utenza debole*. Firenze: Alinea Editrice.
- Fornari, D. (2012) *Il volto come interfaccia*. Milano: Et al.
- Gibson, J.J. (1977) *The Theory of Affordances*. In Shaw, R. and Bransford, J. (eds.), *Perceiving, Acting, and Knowing: Toward an Ecological Psychology*. Hillsdale: Lawrence Erlbaum.
- Jensen, J., Nyberg, L., Gustafson, Y. and Lundin-Olsson, L. (2003) Fall & injury prevention in residential care—effects in residents with higher & lower levels of cognition. *Journal of the American Geriatrics Society*, 51 (5), 627-635.
- ISTAT (2002) *Stili di vita e condizioni di salute. Indagine multiscopo annuale sulle famiglie. Aspetti della vita quotidiana anno 2001*.
- ISTITUTO SUPERIORE DI SANITÀ (2003) *Studio Argento. Indagine sulla salute nella terza età in Emilia-Romagna*.
- Quaranta, G.G. (2013) *La domotica per l'efficienza energetica delle abitazioni*. Sant'arcangelo di Romagna: Maggioli Editore.
- Ratti, C. (2012) Smart City. *Wired*, 3.
- Spadolini, M.B., (2013) *Design for better life. Longevity: scenarios and strategies*. Milano: Franco Angeli.
- Zuccatelli, G. and Lattanzio, F. (2012) *Health and science on aging, Documento di riferimento per 'Progetto Casa intelligente per una longevità attiva ed indipendente dell'anziano'*. [online] Accessibile su: www.google.it/url?sa=t&rct=j&q=&esrc=s&source=web&cd=1&ved=0CCMQFjAA&url=http%3A%2F%2Fwww.inrca.it%2Ffinrca%2Ffiles%2FNEWS%2FSPECIFICHE%2520DI%2520PROGETTO.pdf&ei=_dGrVNG1ClrkaPOigpgB&usg=AFQjCNH5pxSwShSyUX99L6Ae4So-btLNVw&sig2=UX6TsCNcBrk1TUEVMfAJKg&bvm=bv.82001339,d.d2s. [Ultimo Accesso: 30 Dicembre 2014].



Organizzare la cura fuori dai contesti istituzionali: il caso dei pazienti anziani con terapie complesse

Alberto ZANUTTO^{*b}, Francesco MIELE^b, Enrico Maria PIRAS^b, Claudio COLETTA^a e Attila BRUNI^a

^a Università of Trento; ^b Fondazione Bruno Kessler

In un contesto di sempre maggiore frammentazione e decentramento dei sistemi sanitari nazionali, la medicina di territorio sta guadagnando una nuova centralità, assistendo e affiancando i pazienti nella gestione quotidiana della malattia. Il presente lavoro si sofferma sulle strategie messe in atto dai Medici di Medicina Generale (MMG) nel supportare una categoria particolarmente fragile, i pazienti anziani con terapie complesse. Attraverso l'analisi di alcuni Focus Group, svolti in una provincia di montagna del nord-est d'Italia, si sono individuate diverse strategie messe in atto dai medici a seconda delle circostanze. Così facendo si mostrerà come i MMG cerchino, non senza difficoltà, di guadagnarsi ed occupare un ruolo centrale all'interno dei sistemi sanitari territoriali: sviluppando e mettendo al lavoro nuove e vecchie competenze, cercando la legittimità presso pazienti sempre più informati ed esigenti, tessendo relazioni di fiducia e potere con i loro caregivers, coordinandosi e alleandosi con i medici specialisti.

Keywords: *Organizzazioni sanitarie; invecchiamento; autogestione; cure primarie*

Introduzione

Negli ultimi anni, le società occidentali hanno subito notevoli cambiamenti demografici. In particolare, l'aspettativa di vita e l'età media della popolazione sono aumentate considerevolmente, portando all'aumento della popolazione anziana, caratterizzata da una varietà di malattie croniche e da un continuo bisogno di cure ed assistenza. Allo stesso tempo i sistemi sanitari, di estrema importanza per questa fascia della

* Corresponding author: **Alberto Zanutto** | e-mail: alberto.zanutto@unitn.it

popolazione, hanno cambiato radicalmente le proprie strutture organizzative e i loro modelli di intervento, abbandonando gradualmente i vecchi modelli organizzativi per una gestione più decentrata dei bisogni di cura. Gli ospedali, da parte loro, sono chiamati a fornire essenzialmente servizi specializzati e interventi limitati alle fasi acute delle malattie dei pazienti. Per queste ragioni la gestione delle malattie croniche e dei casi patologici complessi è sempre più delegata ai pazienti, ai loro parenti e caregivers.

In questo clima di cambiamento, le cure primarie stanno acquisendo un ruolo centrale nei programmi di assistenza medica affiancando i pazienti nella gestione quotidiana delle loro patologie (Altenstetter and Björkman, 1997; Saltman et al., 2007). In Europa, varie riforme hanno affidato ai Medici di Medicina Generale (MMG) un ruolo chiave nella riduzione dei costi nel coordinamento, integrazione e miglioramento dei servizi sanitari (Starfield, 1996, 1998; Boerma and Fleming, 1998; Delnoij et al., 2000). Come recentemente sostenuto dall'organizzazione mondiale degli MMG (WONCA 2011), nonostante le seppur significative differenze tra i sistemi sanitari nazionali, in Europa gli MMG si trovano a svolgere le seguenti attività:

- Promozione della salute e del benessere con interventi appropriati ed efficaci;
- Garantire che la popolazione percepisca il medico come il primo contatto consultato all'interno del sistema sanitario;
- Offrire un accesso aperto e illimitato a disposizione dei cittadini che possono così presentare al medico tutti i possibili problemi di salute;
- Occuparsi di coordinare gli interventi sanitari in collaborazione con altri professionisti delle cure primarie e gestire la relazione con i medici specialisti;
- Sviluppare un approccio centrato sulla persona, la sua famiglia e la comunità;
- Responsabilizzare i pazienti nella gestione responsabile strategie di cura in base alle esigenze personalizzate dei pazienti;
- Promuovere l'empowerment del paziente e la sua autonomia.

Preso atto dell'importanza della medicina di territorio nei sistemi sanitari occidentali, questo lavoro di ricerca intende concentrarsi sulle strategie che i MMG pongono in essere per garantire la salute e il benessere di una fascia di

popolazione particolarmente vulnerabile, ovvero i pazienti anziani che devono affrontare complessità patologiche significative e i compiti di cura che ne conseguono.

Partendo da alcuni risultati provenienti da una ricerca qualitativa condotta in una provincia montana del Nord-Est italiano, questo lavoro intende mettere in evidenza le principali strategie di intervento messe in atto dai MMG al fine di consentire alle persone anziane di gestire le loro malattie fuori dalle strutture ospedaliere.

Prendersi cura di pazienti anziani: il lavoro del MMG

In Italia, il ruolo del medico di famiglia è cambiato notevolmente negli ultimi anni (Cipolla et al., 2006; Speranza, 2012). A dispetto di un sistema sanitario altamente decentrato e specializzato, diverse azioni di programmazione istituzionale hanno assegnato un ruolo importante (e insolito) agli MMG. Questi professionisti sembrano diventare strategici soprattutto per due motivi: da un lato, sono chiamati ad assumere un approccio olistico orientato alla cura del paziente tenendo conto delle sue condizioni generali; dall'altro, svolgono un ruolo strategico di gatekeeper regolando e consentendo l'accesso dei pazienti ai diversi servizi sanitari (Vicarelli, 2006). Di conseguenza, i medici hanno acquisito una posizione chiave nella risoluzione di alcuni importanti mutamenti sociali. Uno di questi è il progressivo invecchiamento della popolazione. L'Italia è uno dei paesi con il più alto indice di invecchiamento in Europa, e questo comporta un aumento del numero di pazienti con una pluralità di malattie croniche che rilanciano una costante richiesta di cure ed assistenza.

Lo studio che qui si presenta si concentra sui modi con cui i MMG italiani gestiscono i pazienti anziani affetti da malattie croniche allo scopo di limitare il più possibile l'accesso alle strutture sanitarie. Il lavoro trae ispirazione dagli strumenti teorici forniti dal dibattito multidisciplinare che, negli ultimi anni, ha analizzato come le persone anziane gestiscono la loro salute. Questi studi hanno coinvolto vari settori - ad esempio, la gerontologia, la sociologia della salute e della malattia, l'analisi organizzativa e gli Science and Technologies Studies (STS) - che hanno sottolineato come la gestione dei pazienti anziani coinvolga una molteplicità di elementi:

- **L'azione dei sistemi sanitari nazionali** è sempre più frammentata e distribuita tra le organizzazioni locali e nazionali. I pazienti e le loro

reti sociali (partner, parenti, vicini di casa, e così via) interagiscono con i vari operatori sanitari, superando il tradizionale rapporto medico-paziente di tipo paternalistico (May, 1992). In particolare, i pazienti anziani sono definiti come utenti dei servizi, ma anche come consumatori capaci di giudicare la qualità dei servizi offerta e di contribuire alle decisioni terapeutiche che li riguarda (Chapple et al., 2002), emancipandoli dallo stereotipo che li vorrebbe inermi e con limitate capacità cognitive (Lumme et. al., 2002).

- **Le reti sociali** giocano un ruolo chiave nella gestione dei pazienti e dei loro percorsi terapeutici. Familiari, amici e vicini di casa sembrano particolarmente importanti nel sostenere gli anziani direttamente (attraverso farmaci, sostegno nelle misurazioni dei parametri fisiologici, e così via) o indirettamente (per esempio con esortazioni specifiche volte a far assumere comportamenti responsabili e rispettosi delle malattie in corso). In particolare, le famiglie di appartenenza assumono un ruolo di sostegno costante in grado di supportare gli anziani nei vari aspetti della loro vita quotidiana. Allo stesso tempo anche figure più esterne come colleghi e vicini possono intervenire in vari aspetti del lavoro di cura (Prohaska et al., 2001).
- **I farmaci** permeano le case, le routine terapeutiche e, in generale, la vita quotidiana delle persone anziane. I soggetti anziani, sottoposti a terapie complesse e le loro assistenti, svolgono un lavoro impegnativo di gestione dei farmaci ad esempio nella giusta corrispondenza delle confezioni con il contenuto delle stesse (comprensione dell'etichetta, delle istruzioni, del colore della pillola e così via). Queste competenze influenzano le pratiche di cura e la consistenza delle stesse terapie prescritte. Spesso infatti, i disegni ed i nomi di farmaci inducono in errore i pazienti anziani e i loro caregivers (Hellier et al., 2006; Shrank et al., 2007; Ward et al., 2010), al punto che spesso si devono prendere molte precauzioni per evitare errori pericolosi.
- Vari studi si sono focalizzati sui modi in cui i pazienti anziani cercano di utilizzare, riconfigurare, o evitare **le tecnologie di teleassistenza** progettate per sostenerli nella gestione delle loro malattie. Queste infrastrutture servono a scopi diversi: la trasmissione di

informazioni dal paziente al medico (Peinado et al., 2009); il coinvolgimento degli anziani nelle decisioni di trattamento (Rogers et al., 2005); la creazione di reti di sostegno tra pari (Cornejo et al., 2013), e favorire costantemente la comunicazione con i parenti e gli altri operatori sanitari (Mort et al., 2013). Le tecnologie della teleassistenza sono quindi concepite come mezzi per sostenere i pazienti e le loro reti di cura, che, tuttavia, si diversificano in modo molto articolati al loro interno.

Precedenti studi hanno evidenziato, quindi, che gli anziani sono coinvolti in reti eterogenee in cui la famiglia, gli amici, le infrastrutture tecnologiche, i medici e altri operatori sanitari sono continuamente connessi tra loro. L'assistenza agli anziani assume così una rilevanza che esula il tradizionale rapporto medico-paziente, per connotarsi come uno spazio articolato in cui il benessere del paziente è frutto di un lavoro collettivo in cui i medici sono affiancati in modo significativo da altri attori.

Secondo questi orientamenti, i MMG non garantiscono la salute e il benessere delle persone anziane non istituzionalizzate attraverso un rapporto esclusivo medico-paziente, privato e isolato dal contesto esterno. Al contrario, May (2007) suggerisce di porre l'attenzione sulle reti di supporto composte da istituzioni, professionisti sanitari, tecnologie, parenti, amici e altri operatori sanitari. L'assistenza agli anziani sembra in tal senso essere il prodotto di network eterogenei in cui convivono differenti (ma interconnesse) logiche e pratiche.

Gestire l'anziano e il suo network di cura: le strategie dei MMG

Nel lavoro che segue, ci concentreremo sui vari modi in cui i MMG costruiscono il rapporto con il paziente e la sua rete assistenziale. In particolare il lavoro empirico è consistito in cinque focus group condotti con i MMG (per un totale di 22 medici coinvolti) in una provincia di montagna del Nord-Est. I focus group sono stati realizzati in cinque aree territoriali differenziate in base ad alcuni criteri teoricamente orientati: due sono stati realizzati nelle due città principali della provincia (ciascuna con un ospedale) e tre nei centri più abitati delle valli (una con un ospedale, una dotata di un ospedale raggiungibile con un breve percorso in auto, e una lontana da strutture sanitarie dotate di servizi di emergenza). Queste aree sono state selezionate con l'intenzione di confrontarsi con diverse pratiche di sostegno

alla gestione delle terapie nei pazienti anziani. Nei focus group si sono creati dei momenti di confronto e discussione sulle rappresentazioni, sulle logiche e sulle pratiche che guidano i medici nell'assistenza dei pazienti anziani con terapie complesse. Questo lavoro di campo ha permesso di focalizzare l'attenzione su alcuni aspetti ricorrenti che i medici sperimentano nell'esercizio del loro ruolo:

- 1) *Passare le carte*: quando l'azione del MMG è nei fatti una delega agli specialisti delle varie patologie;
- 2) *Mediare*: quando il MMG mediano tra le diverse richieste provenienti dal paziente, dai suoi familiari e dai diversi professionisti sanitari;
- 3) *Configurare*: quando i medici cercano di mettere i pazienti nelle condizioni di gestire la terapia affidata in modo, allestendo e sostenendo una rete di assistenza adeguata;
- 4) *Coordinare*: quando i medici modificano le terapie e organizzano in modo strategico la rete assistenziale.

Passare le carte

Quando i MMG accumulano un alto carico di lavoro, il ricorso ai medici specialisti appare come una risorsa per ridurre le pressioni e le richieste provenienti dai pazienti in carico. In questo caso gli MMG (da qui in avanti si utilizzerà la sigla 'GP#' per riportare l'identificativo del medico autore del frammento audio, e la sigla 'FG#' per identificare il focus group) reindirizzano il paziente anziano agli specialisti, agendo come dei semplici *passacarte*:

Lo specialista è importante, importante da un punto di vista personale nostro... nel senso che a volte ti permette di tirare un po' il fiato...nel senso che scarica un po' magari la gravità non tanto del problema, quanto della richiesta per risolvere il problema [...]. Ci si trova lì tante volte con delle persone che han di tutto davanti e non sai neanche più cosa dirgli [...]. [Poi] lo specialista a noi può esser utile indubbiamente dove noi lo richiediamo, anche noi abbiamo bisogno dello specialista per certi problemi che noi... oh, lui ne sa più di noi nel campo specifico! [FG4, GP2]

La scelta strategica di passare le carte può essere assunta dai medici sia per motivi tattici sia per rispondere alle insistenze dei pazienti. Attraverso tale strategia i MMG possono 'prendere respiro' e ridurre il carico di lavoro.

In questo modo i medici rinunciano in parte alla loro autonomia e al loro potere per riservare tempo per dedicarsi ad altre attività inerenti la loro vita professionale e privata. I medici riferiscono, inoltre, della crescente pressione esercitata dai pazienti che vogliono soluzioni rapide per le loro malattie. I pazienti, infatti, arrivano spesso con la convinzione che l'azione del MMG sia insufficiente per il loro tipo di problema e così affrontano il colloquio medico già con in testa la richiesta di essere rinviati alla consulenza specialistica. In questo senso medici devono poter contare sulla rete degli specialisti per affrontare problemi specifici imposti dai pazienti.

La scelta di passare le consegne ai colleghi specialisti, però, ha come conseguenza diretta la conferma di alcuni stereotipi sui MMG esistenti da tempo, in cui essi sono rappresentati come 'medici di serie B' non in grado di affrontare e curare patologie minimamente complesse.

Allora, noi abbiamo perso di... autorevolezza. Perché un certo punto ci ha fatto comodo affidare il nostro paziente allo specialista. Adesso però, secondo me ne stiamo pagando le conseguenze. Se non riequilibrano un po', adesso ci cominciano a snobbare. Non so se siete d'accordo [assensi]. [FG#2, GP#5]

La crescente importanza data alla componente farmacologica e alle conoscenze specialistiche ha svalorizzato la capacità diagnostica e di comprensione del paziente nel suo complesso tipica dei MMG, mettendone in seria difficoltà l'autorità storica e sociologica tipica del passato. La scelta di *passare le carte* non fa altro che assecondare questo processo, portando i pazienti e i loro familiari a prendere come riferimento principale i medici specialisti, reputati gli unici in grado di attendere le loro aspettative sempre più elaborate e complesse.

In conclusione, quando l'incontro clinico tra MMG e paziente si risolve nel passare le carte allo specialista, i MMG si rappresentano e vengono rappresentati come burocrati chiamati a ratificare le prescrizioni degli specialisti (cui i pazienti riservano quote maggiori di fiducia). Il passare le carte è un effetto e, allo stesso tempo, una causa della trasformazione della rete medica che sua volta influenza significativamente la condizione professionale del MMG.

Mediare

La prescrizione e la gestione delle terapie complessa diviene talvolta un processo profondamente collaborativo, in cui i MMG sono spesso chiamati in gioco come mediatori per supervisionare le richieste dei pazienti, per

gestire i conflitti e per mantenere la rete sociale a supporto della terapia. Un momento in cui il MMG svolge frequentemente un ruolo di mediazione è la dimissione del paziente anziano dall'ospedale:

Mi viene in mente che l'ospedale può anche astrarsi. E' lì però può anche dire 'bene, ho questo paziente che lo vedo in una fase di relativa acuzia. Io sono al di fuori di tutto il caos che esiste nella società, perché noi abbiamo le nostre regole, i nostri protocolli, facciamo le nostre cose'. Dopo il paziente torna fuori, tornando fuori trova allora il suo medico di medicina generale [...] Però oltre al medico c'è l'infermiera che anche ha la sua idea, poi ci sono i parenti, che anche loro devono dire [la loro]... [...]. [Poi] il paziente fin quando è in ospedale ubbidisce a quello che dice il medico e l'infermiera, anche perché se no, se non ubbidisce, lo sgridano, mentre a casa dice: 'finalmente sono a casa mia e posso gestirmi un po' come voglio' e quindi è anche lui più libero. [FG#1, GP#5]

Il passaggio dei pazienti dal sistema di assistenza ospedaliera al proprio domicilio comporta una riorganizzazione della vita personale e domestica per rispettare le impostazioni relative alla gestione della terapia. Inoltre, dopo che i pazienti vengono dimessi dall'ospedale, cambia il livello di disponibilità a seguire le indicazioni dei medici relative alla gestione della terapia e aumenta invece il grado di ascolto dei propri caregivers. La lettera di dimissione dall'ospedale è l'unica fonte di informazione per i MMG sulla salute dei loro pazienti che tornano dall'ospedale. Spesso la lettera è scarsa di contenuti e talvolta ambigua dal punto di vista dei termini utilizzati e per i pochi dettagli che fornisce sulla degenza. Ogni dato deve essere re-interpretato e considerato dai MMG perché è possibile che possano mancare alcune informazioni relative a tentativi di terapie poi abbandonate. Il lavoro di mediazione dei MMG consiste in questo caso nel ri-connettere la rete di supporto alla terapia basandosi su poche tracce e su frammenti di discorsi connotati spesso da poca linearità.

Un altro caso frequente, in cui si può osservare l'attivazione di una strategia della mediazione, è la negoziazione della terapia tra il MMG, il paziente e i suoi parenti nel caso dei malati terminali. La rete sociale dei pazienti può, infatti, fornire un supporto importante nella gestione della terapia, ma anche porsi in modo critico nei confronti delle scelte del medico di famiglia.

l'altro giorno avevo il paziente allettato, soporoso, per cui poco risvegliabile... in una situazione terminale diciamo. E i familiari mi

Organizzare la cura fuori dai contesti istituzionali: il caso dei pazienti anziani con terapie complesse

chiedevano: 'ma la morfina se gliela aumentiamo lui dorme [e non possiamo parlare con lui]'. Ma, scusate, è meglio vederlo soffrire o dorme anche adesso, dormirà lo stesso.[...]. Nonostante questo il familiare si pone in modo critico. Chiede, comunque chiede informazioni e vuole dire la sua insomma, giustamente. [FG#2, GP#3]

Situazioni come questa si creano quando si mettono in gioco conflitti dovuti alle aspettative della rete dei parenti, che si contrappongono al limitato spazio di manovra dei medici nel caso dei pazienti fine-vita. Ciò richiede un importante lavoro di negoziazione per i MMG che hanno il compito di gestire il trattamento, cercando di mitigare le aspettative dei parenti e adattando in modo situato le terapie a seconda delle varie diagnosi emerse.

Il lavoro di mediazione degli MMG si svolge dunque tra l'ospedale e la casa, tra i pazienti e i loro parenti, ma anche nella gestione del percorso dei soggetti tra la vita e la morte ed infine tra le retoriche della medicina specialistica e quelle della medicina generale. Questo lavoro richiede la mobilitazione di una serie di attori che si alleino con il MMG al fine di legittimare la terapia e di garantire la sua adeguata gestione.

Configurare

Nella gestione di una terapia complessa, il medico di famiglia si trova spesso a dover capire se il paziente sarà in grado di gestire la terapia affidata. In altre parole, i MMG devono conoscere in modo adeguato i loro "utenti finali" e 'configurarli' per la gestione della terapia corretta:

Ai pazienti che non hanno problemi particolari, che sono complianti, 'svegli' e che magari vivono da soli e sono autosufficienti, io di solito le informazioni le do [direttamente] a loro. E' ovvio che se il paziente non è affidabile, ha dei problemi e c'è il parente o chi per lui... informare il paziente o il caregivers dipende dalla situazione che ti trovi davanti. [FG#1, GP#5]

Una volta che l'utente della terapia (paziente o caregiver che sia) è stato individuato dal MMG il primo compito di progettazione che spetta al MMG consiste nel formare il soggetto alla corretta posologia e modalità di somministrazione dei farmaci, come pure addestrarlo per riconoscere i principali effetti collaterali o sintomi specifici.

Una ulteriore strategia di configurazione dei pazienti e dei loro caregivers affinché si assumano la corresponsabilità di somministratori delle terapie in

autonomia, si esprime ad esempio attraverso la consulenza alle famiglie su come organizzare l'ambiente domestico e gli strumenti di terapia all'interno di esso (cioè ad esempio: tenere il blister in un certo mobile a portata di mano e posizionare una bilancia in un posto adeguato in bagno per rilevare quotidianamente il peso, ecc.). Tali strumenti e le pratiche conseguenti alla loro disposizione permettono di connettere le routine quotidiane con le pratiche di gestione della terapia.

Come si nota nello stralcio a seguire, la strategia di configurazione agisce, inoltre, sia sulla rete del paziente sia sulla terapia stessa:

Mi trovo di fronte terapie imbricate, con il fenomeno dei farmaci dimenticati – un esempio per tutti l'amiodarone: un sacco di pazienti ce l'hanno da anni e nessuno sa chi gliel'ha dato... e allora a volte lo tiro via io [FG#3, GP#3]

La strategia di configurazione, quindi, si manifesta anche quando i pazienti escono dall'ospedale e vengono affidati all'assistenza domiciliare oppure quando i medici devono rimaneggiare le prescrizioni affidate al paziente al momento della dimissione in ospedale e adattarle alla situazione domestica. In questo ultimo caso l'intervento può essere solo quello di dare dei consigli di opportunità sui tempi e i modi di somministrazione, ma può richiedere talvolta anche un consistente intervento sulla prescrizione affidata per renderla compatibile con la situazione reale del paziente. Infatti, può accadere che i medici specialisti dell'ospedale prescrivano la somministrazione di medicine non più in uso, oppure possono prescrivere farmaci che pur essendo di uso comune in ospedale siano in realtà di accesso molto limitato sul mercato.

Coordinare

Infine, i MMG possono svolgere un vero e proprio ruolo di coordinamento nella somministrazione della terapia, distribuendo strategicamente i compiti ai soggetti che compongono la rete degli stakeholders:

Secondo me il ruolo del medico di medicina generale è quello di coordinare tutti questi... stakeholders che ruotano attorno al paziente, perché un qualcuno che abbia la visione d'insieme... ne abbiamo parlato stasera, ne abbiamo parlato un po' tutti, che in fin dei conti... io ad esempio sono uno di quelli che pensa che la casa di

riposo non sia altro che la continuazione del ruolo del medico di medicina generale nell'istituzionalizzazione. [FG#4, GP#1]

Coordinare significa gestire al meglio il connubio tra la dimensione istituzionale e pratiche di cura, giocando un ruolo di regia in un'estesa rete di attori che comprende i pazienti, gli operatori sanitari e le organizzazioni sanitarie. Prima di tutto, il MMG deve condividere la terapia con il paziente e con la sua rete primaria al fine di delegare compiti adeguati al trattamento richiesto e alle competenze disponibili. Nel caso di una limitata disponibilità da parte della rete primaria nel garantire con continuità un sostegno a casa o quando non c'è nemmeno una rete primaria, tocca comunque ai medici predisporre protocolli istituzionalizzati, come ad esempio l'assistenza domiciliare integrata (ADI). L'ADI comporta, inoltre, l'inclusione nella rete di nuovi professionisti della rete socioassistenziale per rispondere ai bisogni di cura quotidiana dei pazienti.

Questa contraddizione organizzativa è specifica del contesto italiano [...]. Un paziente che vive in *** può scegliere qualsiasi medico a praticare nella città di *** come il suo medico. Ma ha probabilmente solo un infermiere in quel quartiere - che avrà anche molto elevato turnover. Si tratta di una questione molto seria. Le infermiere del distretto continuano a cambiare, in modo che non è mai possibile per un medico in una città come la nostra per conoscere le infermiere che lavorano con i loro pazienti, perché cambiano continuamente. [FG # 4, MMG # 1]

Questi professionisti, come ad esempio infermieri e assistenti sociali, devono essere comunque coordinati e istruiti dagli MMG e ciò diviene immediatamente un compito difficoltoso: il personale infermieristico nella gestione burocratica italiana è spesso caratterizzato da un elevato turnover e viene assegnato su base territoriale a seconda di dove vivano i pazienti. Allo stesso tempo siccome l'assetto istituzionale esistente prevede che i MMG siano affidati sulla base delle scelte dei pazienti, si crea un elevato carico amministrativo per far convivere queste due linee amministrative, una territoriale e uno di pura 'scelta' da parte dei pazienti. Questa contraddizione mette talvolta a rischio il coordinamento delle forze in campo, perché le infermiere distribuite territorialmente devono rispondere alle diverse sollecitazioni procurate da una moltitudine di medici che esistono su quel territorio. Sarebbe decisamente più agevole per i medici lavorare con la stessa infermiera per rispondere con più congruità ai desideri

del MMG e dei bisogni terapeutici dei pazienti che vivono questo tipo di situazioni.

La strategia del coordinamento mira, quindi, a sostenere e garantire l'equilibrio di ogni situazione specifica. Allo stesso tempo deve essere in grado di predisporre adeguati mandati di delega per compiti specifici e per soggetti specifici al fine di mettere a sintesi la complessità che l'eterogeneità degli attori portano nel contesto del paziente. Tutti questi attori costituiscono un vero e proprio "pianeta del paziente", verso il quale il MMG deve rivolgersi per stabilire continuità e qualità dei processi di cura.

Conclusioni

Il settore sanitario e assistenziale è attraversato da profonde trasformazioni che riguardano tutte le organizzazioni coinvolte e spingono policy makers e manager sanitari a trovare alternative alla istituzionalizzazione di lunga durata. In questo contesto, i MMG e i servizi sanitari territoriali diventano la pietra angolare di un sistema sanitario che promuove l'autosufficienza degli anziani, l'empowerment del paziente ed il coinvolgimento di familiari e caregiver nell'assistenza. Questo ruolo è prefigurato nei documenti di policies (v. Introduzione) che definiscono come i MMG debbano contribuire a supportare i pazienti in un percorso di vita attiva e autonoma.

In questo lavoro abbiamo analizzato come i MMG nella pratica lavorativa si adoperino per dare corpo a queste attese analizzando le autorappresentazioni del loro lavoro con i pazienti anziani con terapie complesse e le loro reti di cura. Zoomando dal macrolivello delle attese sociali al microlivello delle interazioni quotidiane con i pazienti le distinzioni tracciate con nitidezza nei documenti di policies appaiono sfumate e concetti quali salute, autonomia e vita soddisfacente si mescolano e si confondono. A questo punto occorre concentrare la nostra attenzione su tre temi che le intersecano.

Ridefinire il proprio ruolo

Negli scenari più ostici i medici si percepiscono quasi impotenti e in balia di pazienti che non seguono le indicazioni, caregivers con competenze limitate, familiari invadenti, medici ospedalieri e servizi territoriali non cooperativi. Ogni caso appare unico e spesso cambia nel tempo. In questo scenario, trovare un ruolo nella rete di cura e offrire supporto al paziente e alla sua rete familiare sono due attività strettamente intrecciate, dove la

prima costituisce la preconditione della seconda. Nelle rappresentazioni dei MMG esiste la piena consapevolezza che ridurre il proprio ruolo a quello di passacarte riduce significativamente il prestigio professionale e impoverisce la relazione con il paziente nel lungo periodo. Lo stesso discorso vale, seppur in modo meno marcato, per il ruolo di semplice mediazione. Al contrario, configurare e coordinare si accordano perfettamente con la rappresentazione ideale del proprio ruolo professionale. L'incapacità di far aderire le pratiche lavorative quotidiane alla rappresentazione professionale è la manifestazione più evidente della difficoltà e della percepita inadeguatezza dei MMG di ricoprire il ruolo di pietra angolare del nuovo sistema sanitario così come descritto nei documenti di policies.

Bilanciare e ridefinire salute e vita soddisfacente

L'esplorazione del lavoro dei MMG invita a riflettere sulla relazione tra salute e qualità della vita. La ricerca di una condizione di salute migliore può portare ad una vita più soddisfacente e autonoma. Tuttavia, può anche condurre a dedicare energie e tempo a coltivare aspettative irrealistiche. Una delle attività più impegnative dei MMG è il bilanciamento tra la qualità di vita di pazienti e l'attesa riguardo la salute. Per i medici, i pazienti e i loro familiari sopravvalutano spesso l'efficacia degli interventi e sottovalutano gli effetti collaterali. I pazienti terminali offrono una chiara illustrazione dei trade-off implicati nelle decisioni terapeutiche: i medici spesso propongono un percorso meno medicalizzato per le ultime fasi della vita, di durata minore, ma anche più sereno. Trovare un bilanciamento tra salute e qualità della vita si presenta come un difficoltoso processo in cui i MMG devono trovare alleati nella rete di cura del paziente, persuadendo i più riluttanti, proponendo prospettive alternative da cui guardare l'esperienza vissuta e ridefinendo il significato di concetti come quelli di salute, vita, morte e qualità della vita.

Trovare un equilibrio tra salute del paziente e carico della rete di cura.

Se passiamo dal piano delle policies a quello delle attività quotidiane diventa più complesso comprendere chi sia il beneficiario delle azioni del medico. La rete di cura è una risorsa e un alleato del medico nel supportare i pazienti e favorirne il benessere. I medici, tuttavia, a volte appaiono orientati alla 'cura della rete di cura' cercando di non sovraccaricarla con compiti e responsabilità che siano troppo gravose anche sotto il profilo emotivo.

Ancora un volta, le decisioni di fine vita offrono un esempio vivido. I medici lavorano per realizzare un 'exitus' quanto più possibile sereno per il paziente. Al tempo stesso, le decisioni terapeutiche sono orientate alla riduzione del danno per la rete di cura, cercando di minimizzare lo stress e la sofferenza per la perdita imminente. In queste occasioni, o altre analoghe, è complicato stabilire chi sia il principale beneficiario dell'azione del medico. La ricerca suggerisce che di caso in caso i medici considerino la rete di cura uno strumento da forgiare per supportare il paziente e il suo benessere mentre in altri vedano la rete e i suoi attori come qualcosa di cui prendersi cura evitando stress eccessivi e non necessari.

In conclusione, in questo lavoro abbiamo descritto alcune delle complessità emergenti nel processo di ridefinizione dei sistemi sanitari concentrando la nostra attenzione sulle pratiche di gestione dei pazienti anziani da parte dei MMG. L'analisi ha mostrato le problematiche avvertite dai medici nella gestione delle condizioni complesse. Il nuovo scenario richiede lo sviluppo di nuove competenze per recuperare la legittimazione sociale perduta, per costruire nuove forme di relazione e alleanza con i colleghi ospedalieri ma anche con pazienti, familiari e caregiver sempre più informati ed esigenti.

Ringraziamenti

Questo lavoro è svolto nell'ambito del progetto AETAS finanziato dalla Fondazione Caritro. Un ringraziamento va alla Scuola di Formazione Specifica in Medicina Generale e in particolare ad Alexandra Vontavon. Un ulteriore ringraziamento a Marie Caillaud per la partecipazione alla realizzazione dei focus group.

Bibliografia

- Altenstetter, C. and Björkman J.W. (eds.) (1997) *Health Policy Reform, National Variations and Globalization*. London: Macmillan.
- Bobak, M., Pikhart, H., Rose, R., Hertzman, C. and Marmot, M. (2000) Socioeconomic Factors, Material Inequalities, and Perceived Control in Self-rated Health: Cross-sectional Data from Seven Post-Communist Countries. *Social Science and Medicine* 51 (9), 1343–50.
- Cipolla, C., Corposanto, C. and Tousijn, W. (eds.) (2006) *I medici di medicina generale in Italia*. Milano: Franco Angeli.

- Cornejo, R., Tentori, M. and Favela, J. (2012) Ambient Awareness to Strengthen the Family Social Network of Older Adults. *Computer Supported Cooperative Work*, 22 (2-3), 309-344.
- Delnoij, D., Van Merode, G., Paulus, A. and Groenewegen, P. (2000) Does General Practitioner Gatekeeping Curb Health Care Expenditure? *Journal of Health Services Research and Policy*, 5 (1), 22-26.
- Hellier, E., Edworthy, J., Derbyshire, N. and Costello, A. (2006) Considering the impact of medicine label design characteristics on patient safety. *Ergonomics*, 49 (5-6), 617-630.
- King, N. (1998) *Template analysis*. In Symon, G. and Cassel, C. (eds.), *Qualitative methods and analysis in organizational research: A practical guide*. London: Sage.
- Lumme-Sandt, K., Hervonen, A. and Jylhä, M. (2000) Interpretative repertoires of medication among the oldest-old. *Social science & medicine*, 50 (12), 1843-1850.
- May, C. (1992) Nursing work, nurses' knowledge, and the subjectification of the patient. *Sociology of Health & Illness*, 14 (4), 472-487.
- May, C. (2007) The clinical encounter and the problem of context. *Sociology*, 41, (1), 29-45.
- Mort, M., Roberts, C. and Callén, B. (2012) Ageing with telecare: care or coercion in austerity? *Sociology of health & illness*, 35 (6), 799-812.
- Peinado, I., Arredondo, M.T., Villalba, E., Salvi, D. and Ottaviano, M. (2009) *Patient interaction in homecare systems to treat cardiovascular diseases in the long term*. Paper Presented at the Proceedings of the Annual International Conference of the IEEE Engineering in Medicine and Biology Society.
- Prohaska, T.R. and Glasser, M. (1996) Patients' views of family involvement in medical care decisions and encounters. *Research on Aging*, 18 (1), 52-69.
- Rogers, A., Kennedy, A., Nelson, E. and Robinson, A. (2005) Uncovering the Limits of Patient-Centeredness: Implementing a Self-Management Trial for Chronic Illness. *Qualitative Health Research*, 15 (2), 224-239.
- Saltman, R., Bankauskaite, V. and Vrangbaek, K. (eds.) (2007), *Decentralization in Health Care, European Observatory on Health Systems and Policies*. London: Open University Press.
- Shrank, W., Avorn, J., Rolon, C. and Shekelle, P. (2007) Effect of Content and Format of Prescription Drug Labels on Readability, Understanding, and

- Medication Use: A Systematic Review. *The Annals of Pharmacotherapy*, 41 (5), 783-801.
- Speranza, L. (2012) *Medici in cerca d'autore*. Bologna: Il Mulino.
- Starfield, B. (1996) *Is Strong Primary Care Good for Health Outcomes?*. In Griffin, J. (eds.), *The Future of Primary Care*. London: Office of Health Economics.
- Starfield, B. (1998) *Primary Care: Balancing Health Needs, Services and Technology*. New York: Oxford University Press.
- Vicarelli, G. (2006) *Medicus omnium: la costruzione professionale del Medico di medicina generale*. In Cipolla, C., Corposanto, C. and Tousijn, W. (eds.), *I medici di medicina generale in Italia*. Milano: Franco Angeli.
- Ward, J., Buckle, P. and Clarkson, P.J. (2010) Designing packaging to support the safe use of medicines at home. *Applied Ergonomics*, 41 (5), 682-694.
- WONCA (2011) *La definizione europea della medicina generale/medicina di famiglia*. [online] Barcelona, Spain: The European Society of General Practice / Family Medicine. Available from: http://www.woncaeurope.org/sites/default/files/documents/Definizione%20WONCA%202011%20ita_A4.pdf. [Ultimo Accesso: 30 Dicembre 2014].

ISBN: 978-88-940625-0-2

SUPPORTED BY


DOTTORATO DI RICERCA IN DESIGN
POLITECNICO DI MILANO, DIPARTIMENTO DI DESIGN

FASTWEB
un passo avanti



Fondazione Giannino Bassetti
for Responsibility in Innovation

ISBN 9788894062502



9 788894 062502