

Practical Computing

April 1979

An ECC Publication. Volume 2 Issue 4

**Take your pick:
Guide to VDUs
under £1,000**

**Ready-made
computerised
accounting
systems**

**We review
North Star
Horizon**

**Star Trek
program**

**Interview:
The Apple II
design story**

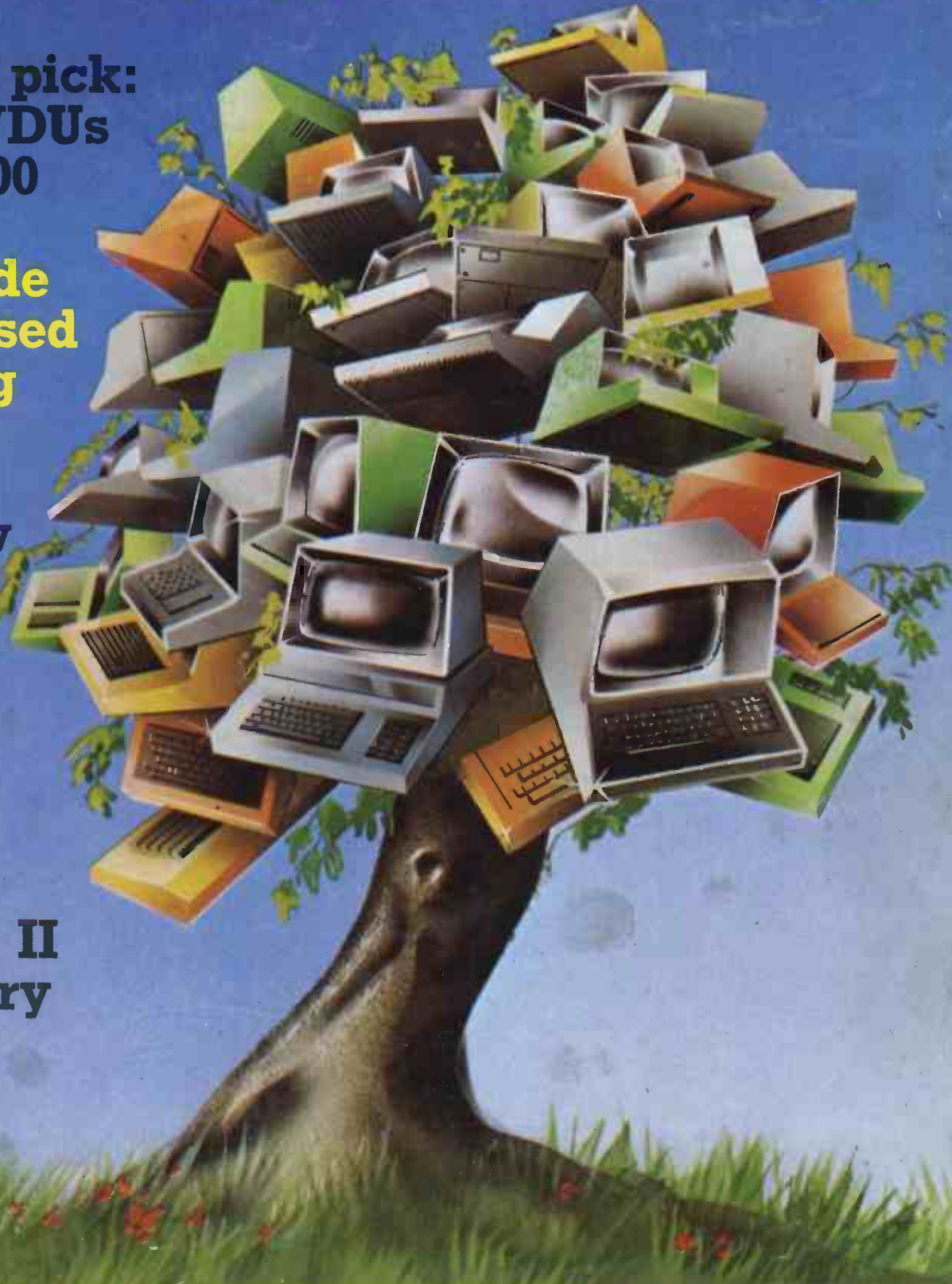



“....the trouble with off-the-shelf microcomputer systems is you have to have an off-the-shelf application.”

The Arrows Formula One racing team couldn't get a ready-made microcomputer system for their application so they came to Scicon. They wanted a device that would monitor certain critical parameters on their racing car hurtling round the track at nearly 200 mph.

We designed and built them their system – the complete system, both hardware and software – which they are now using during practice at every Grand Prix.

So, if you can't get a micro system off-the-shelf for your application, whether its for a data logging role like the Arrows' system or for process control or data communications . . . remember Scicon.

Scicon Consultancy
International Ltd.
Sanderson House
49-57 Berners Street
London W1P 4AQ
Telephone 01-580 5599

You could be eligible
for a £2000 Dol grant.

**SCICON
MICRO
SYSTEMS**

Managing Editor
Dennis Jarrett

Computabits Editor
Nick Hampshire

Staff Writer
Kay Floyd

Production Editor
Harold Mayes

Advertisement Manager
Erica Gibson

Advertisement Representatives
Tom Moloney
Tina Roberts

Subscription Manager
Annabel Hunt

Publisher
Wim Hoeksma

Company Secretary
Carole Fancourt

Managing Director
Richard Hease

Editorial: 01-278 3111

Advertising: 01-278 3143

Production and Subscriptions: 01-278 9517

Practical Computing is published by EEC as a subsidiary of WHICH COMPUTER? Ltd at its registered office, 2 Duncan Terrace, London, N1, and printed by Bournehall Press Ltd, Welwyn Garden City. Distributed by Moore Harness Ltd, 31 Corsica Street, London N5.

©Practical Computing 1979
ISSN 0141-5433.

Subscription rates: Single copy: 50p. Subscriptions: U.K., £6 per annum (including postage); overseas, £12 (including airmail postage)

Every effort has been made to ensure accuracy of articles and program listing. Practical Computing cannot, however, accept any responsibility whatsoever for any errors,

VISUAL DISPLAY TERMINALS UNDER £1,000

Save money by using our guide to terminals which compares for price and capabilities 45

READY-MADE ACCOUNTING SYSTEMS

How to computerise your business accounts. We look at what you can expect and what various systems offer 57

NORTH STAR HORIZON REVIEW

Before you buy a computer, our reviewer tells you what to look for 35

STAR TREK—COMPLETE PROGRAMS

Put this famous game on your computer. We list complete programs in Basic and show you how to put it on your own system 63

APPLE II DESIGN STORY

Practical Computing goes to California to interview Steve Wozniak, the man who invented and built the Apple II computer 38

PROJECT—BUILD A FREQUENCY METER

In Computabits we show you how to build your own frequency meter. This article was held over from last month due to production problems—our apologies 85

PROJECT II—MOTOR CONTROL

Also in Computabits: Build your own motor control unit using a Kim 90

EDUCATION—HOW TO GET MONEY

We interview ILEA chief Derek Estersen to see what money is available for school computing 76

CHIPS WITH EVERYTHING

Computerising school meals and checking what goes in them is one way of using a Pet 81

TOP SOFTWARE REVIEWS

We begin a new regular page reviewing what computer software is available on cassette for all kinds of applications 53

ALL THIS AND MORE

PRINTOUT 31 All the news and the views	DIARY 83 All the latest events, plus a list of user groups.
PET PAGE 40 Tips and ideas for the Pet	BUYERS GUIDE 98 We list and compare what computers are on the market.
TANDY PAGE 43 What you can do with Tandy	GLOSSARY 104 What the words mean
ILLUSTRATING BASIC 69 Teach yourself programming	COMPUTER ARTS 79 A novel way of using a computer
	ADVERTISEMENT INDEX 104

MAY ISSUE ON SALE APRIL 11 — ORDER NOW

THE BRITISH MICRO



RAIR BLACK BOX MICROCOMPUTER

- High speed 8085 microprocessor
- Priority interrupts and DMA
- 64K bytes of RAM memory
- Transparent ROM bootstrap loader
- Integral dual minifloppy disks
- Programmable serial I/O interfaces
- Comprehensive range of peripherals
- UK wide on-site maintenance
- Advanced floppy disk operating system
- Serial and random file processing
- Macro assembler with symbolic debugging
- Extended BASIC interpreter
- Relocating FORTRAN IV compiler
- ANS 74 COBOL compiler
- Quantity and OEM discounts
- Leasing and rental facilities

RAIR RAIR RAIR RAIR RAIR RAIR

30-32 NEAL STREET COVENT GARDEN LONDON WC2H 9PS TELEPHONE 01-836 4663

● Circle No. 102
PRACTICAL COMPUTING April 1979

We've come a long way since the quill pen
 microcomputers are now taking the drudgery
 out of office life
 providing safe and constant control of
 industrial processes
 helping further our knowledge by monitoring
 scientific experiments and well you may
 have yet another application.

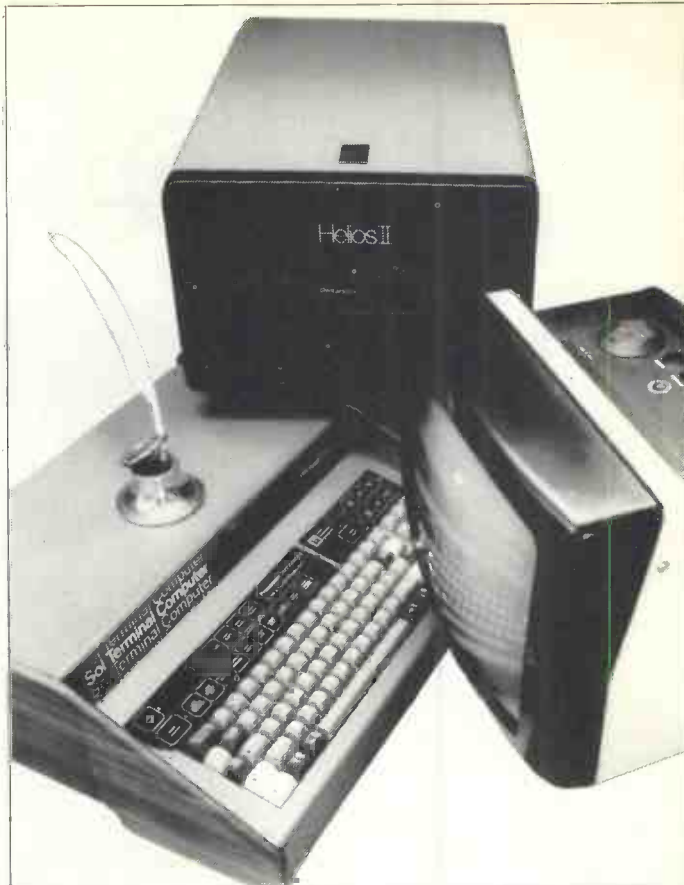

Comart specialise in microcomputers —
 from single-card computers to multiuser systems.
 Analogue interfaces, floppy discs, digital, VDU
 and printer interfaces are all in our range.
 Software from Assembler, Basic, Fortran, Cobol
 to Word Processing and Data Base Management.

Why not discover the Comart Catalogue of Computers — NOW

Contact us at :-

**COMART LTD., P.O. Box 2, St. Neots,
 Cambridgeshire. PE19 4NY.**

Tel: Huntingdon (0480) 215005.

Telex: 32514.

Comart Computers are also available from regional dealers :-

Microcomputermart Ltd., Manchester. Tel: 061 832 2269	The Byte Shop, Ilford, Essex. Tel: 01 554 2177
Cambridge Computer Store, Cambridge. Tel: 0223 68155	Xitan Systems Ltd., Southampton. Tel: 0703 38740
New Bear Computing Store, Newbury, Berks. Tel: 0635 49223	Holdene Ltd., Leeds. Tel: 0532 459459
Isherwoods (Personal Computer Systems) Ltd., Luton, Beds. Tel: 0582 424851	

AIM 65

£249.50 + VAT

- FEATURES INCLUDE:**
- * 20 COLUMN PRINTOUT
 - * 20 CHARACTER ALPHANUMERIC DISPLAY
 - * FULL 54 KEY TERMINAL-STYLE KEYBOARD
 - * TTY INTERFACE
 - * TWIN CASSETTE INTERFACE
 - * RAM — 1K TO 4K OPTIONS
- OPTIONS INCLUDE:**
- 8K BASIC INTERPRETER ROM
 - 4K ASSEMBLER/EDITOR ROM

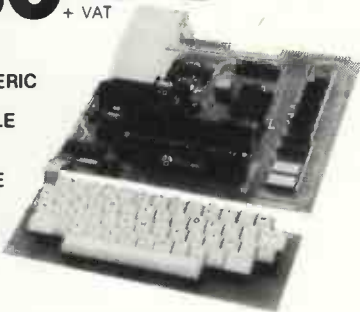

AIM 65 comes to you fully built and tested with a full alphanumeric keyboard, 20 character display and a 20 column printer — for keeping a permanent record of all your work. Available in 1K- and 4K-byte RAM versions, AIM 65 is designed around the 6502 CPU, which has 64K address capability with 13 addressing modes. This is the microprocessor at the heart of many other, more costly, systems such as PET and APPLE. AIM 65 has a 4K ROM-resident monitor program for all peripheral control and user programming functions. Spare sockets are included for expanding on-board program memory via user PROM-based programs and/or Rockwell assembler, text editor and BASIC interpreter plug-in options. AIM 65 has a connector for external access to system bus for memory and I/O expansion, a separate connector

for interfacing a teletype and two cassette recorders. There is a user-dedicated Versatile Interface Adaptor, featuring three 8-bit, bidirectional ports (two parallel, one serial) and two 16-bit interval timer/event counters — thus allowing the user to interface his own system, without extra interface devices in many cases. AIM 65 is probably the most effective, low-cost microcomputer development system available — an invaluable educational aid to first time users and an ideal general purpose micro-computer for the engineer. AIM 65 is available in the UK only from PELCO ELECTRONICS LTD at £249.50 + VAT, complete with User's Manual and Schematic, R6500 Programming and Hardware Manuals and a handy pocket reference card.

Pelco (Electronics) Ltd

Enterprise House,
83-85 Western Road, Hove, Sussex BN3 1JB
Telephone: Brighton (0273) 722155

Buy it with your Access or Barclaycard.

● Circle No. 104

CCS Microhire

MICROCOMPUTER
RENTAL
SPECIALISTS

Before you buy a micro, why not hire it for a day or a weekend?

From £2 a day we hire out a range of micros for evaluation/experience or program development.

- * Apple II
- * Commodore Pet
- * Nascom I or Micros
- * Research Machines 380Z
- * SEED System One
- * Tandy TRS 80
- * Exidy Sorcerer
- * Rockwell AIM

Protect your future investment.
Try out a system now.

For details write to

CCS Microhire, Freepost,
Letchworth, Herts SG6 4YA

● Circle No. 105



We now have available for demonstration in our Camberley showroom the following systems:

EXIDY SORCERER

32K RAM, 128 character ASCII upper- and lower-case keyboard, Z80 processor, 64 pre-defined graphics, 64 user-defined graphics with 240 x 512 resolution, cursor control, 64 characters by 30 line display, 4K power on monitor, 8K PROM BASIC, ASSEMBLER on cartridges. Parallel, serial, RS232 etc. S-100 expansion available.

Prices from £850 to about £3,000

CROMEMCO-Z2

Up to 512K of banked memory, multi-user, up to three mini diskettes, FORTRAN, COBOL, EXTENDED BASIC, MACRO ASSEMBLER, DATABASE MANAGEMENT, WORD PROCESSOR, powerful monitor.

Prices from £395 to about £5,000

SOL 20

Minimum 16K RAM, capacitive keyboard, monitor, serial and parallel interfaces, EXTENDED BASIC, FORTRAN, FOCAL, ASSEMBLER, EDITOR, GAMES, WORD PROCESSOR, mini floppy disks.

Prices from £1,785 to £5,000

SOL*STAR WORD PROCESSOR from £2,500

HORIZON

Minimum 16K RAM, serial interface, mini diskette and power supply. Expands to 48K, 3 diskettes and hardware floating point. EXTENDED BASIC, DOS, CP/M.

Prices from £1,785 to £3,500

SHOWROOM AND OFFICES—34B LONDON ROAD. BLACKWATER. CAMBERLEY. SURREY. TELEPHONE: (0276) 34044.

77-68 BEARBAGS

BOOKS

We can supply a vast range of books and cassettes on almost ANY computer or application from micro to mainframe. Please phone for our book catalogue.



WE WILL COME TO YOU

Our senior staff each have over 10 years' experience in various areas of Business Data Processing. Let us send one of our Business Analysts to you to discuss your specific computing problems and produce a feasibility study *BEFORE* you invest in a business system.

SOFTWARE

In addition to supplying the hardware, we also offer a full consultancy and programming service. We are developing a number of our own business packages for a multitude of applications.

SERVICE

If you would like a demonstration please telephone us for an appointment. Our normal hours are 10.00 a.m. to 6.00 p.m., Monday to Saturday inclusive.

Insurance Maintenance, Leasing, and Hire-purchase facilities available as well as ACCESS, BARCLAYCARD and TRUST-CARD.

● Circle No. 106

IF YOU CAN'T BEAT THEM:-

VECTOR GRAPHIC INC



VECTOR V18A slot Motherchassis accepts the wide range of Vector S100 cards and makes an ideal base to build a microcomputer system. Computing power is available to perform a wide range of tasks from industrial control to small business.

£350

PR2 12K PROM/RAM card holds a comprehensive monitor program for system testing and configuration. Normal operation is in conjunction with a serial terminal via I/O card.

£160

FLASHWRITER, memory mapped VDU with graphics, allows a system to be built without a terminal or I/O card. Specify version EV of monitor program.

£150

I/O, Switchable 110 to 9600 baud serial interface plus two 8-bit parallel I/O ports.

£125

High resolution graphics interface bit-maps 8K of RAM to 256 x 256 points, or 128 x 128 with 16 level grey-scale.

£150

Z80 Processor card	£140	8080 Processor card	£120
8K Static RAM 4MHZ	£140	16K Static RAM 4MHZ	£300
Analogue Interface	£70	Precision analogue interface	£250
Rackmount 18 slot motherboard	£150	Rackmount power supply	£90

8K Computer System £895

MICROPOLIS



Micropolis disk drives employ higher standards of engineering to pack either 143K or 315K bytes per diskette, formatted. Supplied complete with controller card, cables, manual and software they plug directly into the S100 bus; 8080 or Z80.

Extended disc BASIC, mnemonic editor and assembler are provided, to run under the powerful MDOS operating system.

Add-on units are supplied to extend the system to four drives and one drive per system may be powered from the S100 bus.

143K System S100 powered	£439	143K Add-on S100 powered	£279
143K System Mains powered	£499	143K Add-on Mains powered	£339
315K System S100 powered	£649	315K Add-on S100 powered	£349
315K System Mains powered	£699	315K Add-on Mains powered	£399
Twin drive System 630K	£1159	Twin drive Add-on 630K	£859
S100 bus regulator	£14	Diskettes per five	£24

Unmounted drives available from £225

JOIN THEM!

VECTOR MZ



£2300

Combining the best features of the VECTOR GRAPHIC computer and twin MICROPOLIS 315K byte drives. The Vector MZ produces, in one package a powerhouse of Microcomputer ability.

The VECTOR PROM monitor bootstraps directly to either MDOS, for housekeeping and Assembly language operation, or to BASIC to run high-level user programs. Provision is made to immediately attach a printer, for example one of the extensive range from Centronics sold by Sintrom, enabling use of the powerful printer-related features in the MICROPOLIS Software.

Applications Software for the VECTOR MZ now in preparation will perform a wide variety of business functions; stock control, invoicing, ledger and mailing lists. Further applications exist as a microcomputer development system, and low cost replacement for minicomputer control and instrumentation.

VECTOR MZ configuration includes:

Twin disk 630K minifloppy.
Full Micropolis disk software.
Z80 4MHZ 32K processor.
1 Serial port, 2 Parallel ports.
12K PROM RAM card with extended monitor.

And will support:

Flashwriter, Graphics interface, Analogue interface
Additional RAM, additional minifloppy drives.

Centronics Microprinter	£398
Centronics 779	£780
ADM3A VDU	£620



SINTROM GROUP

PRICES EXCLUDE VAT
ALL EQUIPMENT FULLY ASSEMBLED AND TESTED
OEM AND DEALER ENQUIRIES WELCOME

DEMONSTRATIONS IN OUR SHOWROOM

Sintrom Microshop

14, Arkwright Road,
Reading, Berks. RG2 0LS.
Tel: Reading (0734) 84322
TELEX: 847395
CABLES: SINTROM READING

● Circle No. 107

Scotland's first computer shop

● PROUDLY PRESENTS ●

Pet computers... £594

● PLUS FULL SUPPORTING CAST ●

Dual floppy disc (525k)	£795
Choice of 3 printers	£365-£499
Teletype 43 keyboard printer	£875
With bi-direc. PET interface	£995
Memory expansion (to 32k)	£185
Extra keyboard	£65
Modem with acoustic coupler	£75
VDU + keyboard	£395

All Pet compatible!

● ALSO STARRING ●

Cromemco System Three - £3,750
Cromemco System Two - £2,500

● WITH ●

Full range of Cromemco peripherals
Fortran IV, ANSI, Cobol, Extended Basic
Word processing, DBMS, etc.

● AND FEATURING ●

Full warranty and maintenance
Tailored software supplied

● ALL PRICES INCLUDE VAT ●

MicroCentre

132 St. Stephen Street

Edinburgh 3

(5 mins. walk Princes St.)

Tel: 031-225 2022

COMPARE OUR PRICES...

—THEN DROP IN FOR A DEMO

● Circle No. 108

EQUINOX 300

A powerful multi-user
multi-tasking
multi-language

16-bit microcomputer time-sharing system

supporting

- * BASIC
- * LISP
- * PASCAL
- * Floppy discs
- * Hard discs

including a powerful Text Formatter,
Assembly Language Development System
and disc-based Sort utilities.

Priced from under **£5,000**

Write or phone for further information.

EQUINOX COMPUTER SYSTEMS LTD

32-35 Featherstone Street,
London EC1Y 8QX.
(Tel: 01-253 3781/9837)

● Circle No. 109

RECREATIONAL COMPUTING

formerly 'Peoples Computers'

**A bi-monthly magazine
for the micro enthusiast
who is young or young
at heart.**

Features: games, fantasy, graphics, music puzzles,
problems, software, tutorials, interviews + regular
PET-related articles.
£1.75 single issue
£8.00 subscription, £8.50 overseas subscription

HOW TO ORDER:

Payment in sterling drawn against a British bank or
by credit card to: L.P. ENTERPRISES, Room PC
313 Kingston Road
Ilford, Essex IG1 1PJ
U.K.
Tel: 01-553-1001

● Circle No. 110

PRACTICAL COMPUTING April 1979

WHY BUY A MICRO-COMPUTER FROM

PETALECT

**ELECTRONIC
SERVICING LTD.**

BECAUSE

- 1) Established company trading since 1971
- 2) Electronic servicing is our speciality
- 3) We have in house programmers/systems analysts
- 4) We have our own service engineers
- 5) We will demonstrate the PET at your premises
- 6) We can customise the PET to your requirements
- 7) We can arrange finance
- 8) We offer, after the three-month warranty, a service contract for £69.50
- 9) You benefit from our experience of having sold over 100 micro-computers to industrial, educational and business, personal users.

PET 2001-8 COMPUTER—NOW ONLY £550 — vat



Also available:

32K Memory Expansion Boards (disk-compatible)
only £320 + VAT

PET-compatible dual floppy disk unit
with advanced operating system
only £840 + VAT

Telephone for complete system prices.

If you require any more information or demonstration regarding the PET 2001/8 or any associated equipment, programs, etc., please contact Mr. P. J. A. Watts or Mr. D. W. Randall at:

PETALECT ELECTRONIC SERVICES LTD
33/35 Portugal Road,
Woking,
Surrey.
Tel. Woking 69032/68497

PETALECT
Chertsey Road,
Woking,
Surrey.
Tel. Woking 20727/23637

Complete Computer Systems

(CCS Microsales)
Specialists in Computer Graphics

COLOUR GRAPHICS

Apple II 16K Ram: 40 by 48 resolution with 15 colours
or 280 by 192 with 4 colours £970.00

Compucolor II 8K Ram mini-floppy and colour CRT:
8 colours 64 by 32 lines Graphics
128 by 128 plus vectors £1370.00

SORD M100 16K Ram: S-100 Bus, Kansas City tape
interface: Centronics Printer interface:
Rs232C interface: PIO: 2 Analog inputs:
18 Special Keys. 128 by 120 Graphics
7 colours* from £950.00*
*requires disc unit

B & W Graphics

Exidy Sorcerer 16K Ram: Plug ROM Cartridges with
BASIC, FORTRAN and COBOL: 16 Key
numeric keypad: 64 by 30 line display:
512 by 240 Graphics £750.00

Commodore Pet 13K Rom: 64 Special Graphics Keys
plus 64 standard ASCII: numeric key-
pad: 9" VDU: 40 by 25 display.
4K RAM £460.00
32K RAM £795.00

Available from:-

All prices ex. VAT

CCS MICROSALES

22 WESTSIDE

68 FORTIS GREEN

LONDON N2 Tel 01-444 7739

● Circle No. 112

V. & T. ELECTRONICS

ASSEMBLER FOR NASCOM ON TAPE £10.00

supports all standard mnemonics, occupies 3½K available
in sixteen different versions, i.e. one for each page of
O to F; please state which page you require.

CONVERSION KIT TO PLACE NASCOM MONITOR & VDU ON ANY PAGE IN MEMORY

please write or phone for details.
**THIS MONTH'S SPECIAL OFFER: NATIONAL
MM5270 4Kx1 200NS CERAMIC PACKAGE
£10.00 FOR 8**

21L02 450ns	8 off £6.00	Z80 cpu	£13.00
21L02 250ns	8 off £7.00	Z80 cpu	£16.00
4116 250ns	8 off £7.00	Z80 PIO	£15.00
2114 300ns	2 off £11.50	2716 INTEL 1	off £23.50

We apologise to our customers who have tried to contact
us at Dartmouth Rd, N. W2., but we haven't moved
yet—our address is still as below. Stuck for a bit in
the middle of the night? We are often open very late
but please phone first. If you don't see what you need
in this ad, please phone and enquire. By the time this
ad appears, we hope to have some 8 in. floppies in at silly
prices—first come, first served.

Please add 40p postage then 8% V.A.T.
V&T ELECTRONICS 01-263 2643
82 CHESTER ROAD, LONDON N.19

● Circle No. 113

WHY GO TO TEXAS FOR A PORTABLE TERMINAL WHEN YOU CAN BUY A BRITISH ONE HERE

COMPACT 2 is the silent portable
hardcopy terminal designed and manu-
factured in England. With its built in
acoustic coupler, you can get on-line to
your computer within seconds wherever
you are—all you need is a power point
and a phone.

COMPACT 2 is built to travel — its
lightweight fibreglass case makes it robust
and reliable.



Its price is pretty compact too!

So find out more from

COMPUTRADE

Silverwood House, Oxshott Road, Leatherhead, Surrey

Tel. No. 03723 77374

North: 061-477 4960 Midlands: 0533-536077 South East: 01-658 5906

● Circle No. 114

TRS-80

we take over where Tandy leave off

We work exclusively with the TRS-80 because, in its price range, we believe
it to be the best Microcomputer on the market, and it's getting better all the
time! If you think that there is no software around for it, look at our list, which
is getting longer every week.

ELECTRIC PENCIL

This fantastic word processing program is our speciality. It comes on
cassette complete with a very well-written manual and we can do a complete
package including an RS232 + 20ma. loop interface, which plugs into the
back of the keyboard unit.

Software £68.00, lower-case modification £25.00, RS232 £45.00.

We can also supply the TELETYPE 43 printer which is a 9-wire matrix printer,
30 characters p.s. with underline, and will take either 12 in. perforated paper
or letter headings and plain paper. We do all our listings and letters on this
machine which gives virtually typewriter quality and, because it's also a
teletype machine, it's very reliable. The basic printer costs £900.00.

SMALL SYSTEM SOFTWARE

We are now the U.K. agents for this company and we hold a good stock of
most of their products.

TRS-80 COMPUTING newsletter

We are the European distributors, price £12.00 per year inc. for 12 copies.

Anything else that's being made, written or sold for the TRS-80 we are
almost certainly handling. SAE for details.

OPTRONICS

Telephone: 01-892-8455

Visitors by appointment

● Circle No. 115

PRACTICAL COMPUTING April 1979

JADE Computer Products

MEMO2

16K Static RAM Board

S-100, fully buffered, with PHANTOM and bank addressing capabilities, can be addressed at 4K boundaries.

250ns Kit	\$356.25
450ns Kit	\$312.50
250ns A&T	\$437.50
450ns A&T	\$406.25

EPROM BOARD KITS

EPM-1 (uses up to 4K or 1702)	\$74.94
JG8/16 (uses 2708 or 2716)	\$87.44

"IMSAI"-TYPE CARD GUIDE SPECIAL:

Regular Price 38¢ each

SPECIAL: 10 for \$1.25

MICROPROCESSORS

F8	\$21.19
Z80 (2MHz)	\$25.00
Z80A (4MHz)	\$31.25
CDP1802CD	\$22.44
6502	\$14.94
6800	\$21.19
6802	\$31.25
8008-1	\$16.19
8035	\$25.00
8035-B	\$26.25
8080A	\$12.50
8085	\$28.75
TMS9900TL	\$62.44

8080A SUPPORT DEVICES

8212	\$ 3.63
8214	\$ 5.81
8216	\$ 3.44
8224 (2MHz)	\$ 5.38
8224-4 (4MHz)	\$12.44
8226	\$ 3.44
8228	\$ 8.00
8238	\$ 8.00

USRT

S2350	\$13.69
-------	---------

UARTS

AY5-1013A	\$ 6.56
AY5-1014A	\$10.31
TR1602B	\$ 6.56
TMS5011	\$ 7.44
IM6403	\$11.25

BAUD RATE GENERATORS

MC14411	\$12.50
14411 Crystal	\$ 6.19

6800 PRODUCT

6810P	\$ 5.00
6820P	\$ 8.25
6821P	\$ 8.25
6828P	\$14.06
6834P	\$21.19
6850P	\$10.81
6852P	\$13.75
6860P	\$11.56
6862P	\$15.00
6871P	\$35.94
6875P	\$10.94
6880P	\$ 3.13

KIM SUPPORT DEVICES

6502	\$14.94
6520	\$12.50
6522	\$11.56
6530	\$19.94
6530-002	\$19.94
6530-003	\$19.94
6530-004	\$19.94
6530-005	\$19.94

CHARACTER GENERATORS

2513 Upper (-12+5)	\$ 8.44
2513 Lower (-12+5)	\$ 8.44
2513 Upper (5 volt)	\$12.19
2513 Lower (5 volt)	\$13.69
MCM6571 up scan	\$13.69
MCM6571A down scan	\$13.69

PROMS

1702A	\$10.00
2708	\$12.44
2716 (5+12) T1	\$31.25
2716 (5v) INTEL	\$75.00
2758 (5v)	\$29.25

DYNAMIC RAMS

416D/4116 (250ns)	\$15.63
2104/4096	\$ 5.00
2107B-4	\$ 4.94
TMS4027/4096 (300ns)	\$ 5.00

STATIC RAMS

21L02 (450ns)	1-15	\$ 1.50
21L02 (250ns)		\$ 1.88
2101-1		\$ 3.69
2111-1		\$ 3.25
2112-1		\$ 4.06
		\$ 3.69

FLOPPY DISK CONTROLLERS

1771B01	\$49.94
---------	---------

KEYBOARD CHIPS

AYS-2376	\$17.19
AYS-3600	\$17.19
MM5740	\$22.50

Rockwell AIM-65: The Head-Start in Microcomputers

A KIM-1 compatible machine with on-board printer and a real keyboard!

\$468.75 w/1K RAM
\$562.50 w/4K RAM

4K assembler/editor in ROM:	\$100.00
8K BASIC in ROM:	\$125.00
Power supply:	\$ 74.93
Case for AIM-65:	\$ 62.43

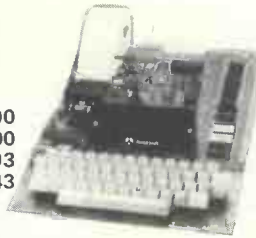

Special Package Price: \$748.75
AIM-65 (4K), Power Supply, Case, and 8K BASIC ROM

EXPANDOR'S BLACK BOX PRINTER

This 64-character ASCII impact printer with 80-column capability is portable and uses standard 8 1/2" paper and regular typewriter ribbon. Base, cover and parallel interface are included. Assembled and complete with manual and documentation.

only \$599.00

(90 day manufacturer's warranty)

TRS-80 Interface Cable for Black Box Printer with mating connectors: **\$60.00** (must be used with expansion module, +8v/1 amp power supply required.)

Power Supply for TRS-80/Black Box Printer \$61.25



Sale!

DYNAMIC RAM BOARDS EXPANDABLE TO 64K

32K VERSION • KITS
Uses 4115 (8Kx1, 250ns)

Dynamic RAM's, can be expanded in 8K increments up to 32K.

8K \$198.75 24K \$311.25
16K \$248.75 32K \$373.75

64K VERSION • KITS
Uses 4116 (16Kx1, 250ns)

Dynamic RAM's, can be expanded in 16K increments up to 64K.

16K \$311.25 48K \$593.75
32K \$461.25 64K \$718.75

S-100 MOTHER BOARDS

9-SLOT "LITTLE MOTHER"

Kit \$107.00
Assembled & Tested \$123.75
Bare Board \$ 43.75

13-SLOT "QUIET MOTHER"

Kit \$118.75
Assembled & Tested \$137.50
Bare Board \$ 50.00

22-SLOT "STREAKER"

Assembled & Tested \$186.25

JADE 8080A

with full documentation

Kit \$125.00
Assembled & Tested \$186.25
Bare Board \$ 37.50

JADE Computer Products

4901 W. ROSECRANS AVENUE
Department "U" 3
HAWTHORNE, CALIF. 90250
U.S.A.

Telephone:
(213) 679-3313

Telex:
18-1823



Discounts available at OEM quantities. All prices above are quoted in U.S. \$ F.O.B. Hawthorne, Calif., U.S.A. To expedite shipments please include International money order or bankers check payable against any U.S. bank in U.S. \$, or use your Barclay, Access or American Express credit card (include card number, expiration date, and signature). Add 20% of total order for shipping & handling.

WRITE FOR OUR FREE CATALOG

All prices subject to change without notice.

Call for discounts on larger quantities

Jade Memory Expansion Kits for TRS-80 and Apple!

4116's - 8 for \$106.25

(16K x 1, 200ns)
includes dip plugs and instructions

★ TRS-80 Kit ★

(16K x 1, 300ns)
includes connectors and instructions
\$112.50

JADE Z80

with provisions for ONBOARD 2708 and POWER ON JUMP

2MHz

Kit \$168.75
Assembled & Tested \$231.25

4 MHz

Kit \$187.44
Assembled & Tested \$249.94
Bare Board \$ 43.75

STATIC RAM BOARDS

JADE 8K

Kits: 450ns \$157.44
250ns \$187.19

Assembled & Tested:
450ns \$174.69
250ns \$212.19

Bare Board: \$ 31.25

16K - Uses 2114's (low power)

Assembled & Tested:
RAM 16 (250ns) \$168.75
RAM 16B (450ns) \$231.25

16K with memory management

Assembled and Tested:
RAM 65 (250ns) \$468.75
RAM 65B (450ns) \$406.25

32K Static

Assembled & Tested:
250ns \$993.75
450ns \$906.25
250ns Kit \$718.75

★ STATIC RAM SPECIALS ★

2114's, low power (1024x4)

	1-15	16-99	100+
450ns	10.00	8.69	6.88
250ns	11.25	10.00	8.13

TMS4044/MM5257, low power

450ns	10.00	9.38	8.13
250ns	12.44	10.94	10.00

4200A (4Kx1, 200ns)

	12.44	10.63	10.00
--	-------	-------	-------

DISK DRIVES

MINI DISK DRIVE \$368.75
Model B51 by Micro Peripherals, Inc. will operate in either single density (125KB, unformatted) or double density (250KB, unformatted) modes, up to 40 tracks, with a track-to-track access time of only 5ms.

SA801R \$618.75
Shugart single-sided 8 in. floppy disk drive.

DM 2700-S \$937.50
Includes SA801R disk drive, 10 in. x 10 in. x 16 in. cabinet, power supply, data cable, fan AC line filter.

VERBATIM FLOPPY DISKS

5 1/4 in. Minidiskettes
Soft sector, 10 sector, or 16 sector
\$5.50 each or box of 10 for \$50.00

8 in. Standard Floppy Disks
Soft Sector
\$5.94 each—10 for \$53.13



MICROCOMPUTERS ETC



JADE

For Hardware, Software, Peripherals, Consultancy and Competitive Prices.

Registered business name.

TRS-80	TRS 80 4K Ram Level I *** Keyboard & 110V PSU only ***	£ 350.00	Pet 2001	Pet 2001 with 8K Memory (110V)	£ 475.00
	TRS 80 4K Ram Level II *** Keyboard & 110V PSU only ***	£ 420.00		Pet 2001 with 8K Memory (240V)	£ 515.00
	TRS 80 16K Ram Level I System (VDU + Cassette recorder + 240V PSU)	£ 595.00		24K Ram Expansion Board to give total 32K Ram	£ 320.00
	TRS 80 16K Level II System (VDU + Cassette Recorder + 240V PSU)	£ 665.00		Interface to S100 (4 slot motherboard)	£ 112.00
	TRS 80 Expansion Interface Incl 16K Ram (240V)	£ 325.00		RS232C 1 way serial interface	£ 118.00
	TRS 80 Expansion Interface Incl 32K Ram (240V)	£ 435.00	Sorcerer	Sorcerer 16K Ram	£ 760.00
	TRS 80 To RS232 Interface Board	£ 45.00		Sorcerer 32K Ram ***	£ 859.00
	Screen Printer for TRS 80 for text plus graphics capability (240V)	£ 400.00		S100 Bus for Sorcerer inc interface+motherboard+power+case	£ 200.00
	Disk Drives for TRS 80	£ 350.00	Apple ITT 2020	Apple II 16K Ram (240V)	£ 859.00
	UHF Modulator (cased with leads & PSU) for 625 lines TV	£ 25.00	Disk Drives	Micropolis & Shugart Minifloppy drives, from Interface to Pet, TRS 80, Apple II, etc. from	£ 350.00
	RS232C Serial Interface	£ 45.00			£ 45.00
	Ram Upgrade (4-16K 16-32K 32-48K) Supplied & fitted	£ 110.00	Printers	Centronics 779 Parallel Printer (240V)	£ 790.00
	16K Ram Upgrade Kit (Supply only)	£ 100.00		Centronics Micro Printer (40 cols) (110 volts)	£ 320.00
	Upgrade to increase speed from 1.78MHZ to 2.6MHZ (switch selectable)	£ 12.50		Centronics 701 Parallel Printer (Bi-Directional)+ tractor feed (240V)	£1,375.00
	'Beeper' audible tone for CSAVE/CLOAD & Key functions	£ 40.00		Teletype 43 KSR Serial Printer For Pet or TRS 80 (240V)	£ 875.00
	Switchable selection of level I or level II (Level I & II Roms required)	£ 25.00	Software	Expander Black Box Printer 80 cols (110V)	£ 320.00
	Automatic Volume Control (AVC) for Cload	£ 25.00		Packages for Pet, TRS 80, etc. Cassette/disk, from	£5-£ 250.00
	'Electric Pencil' text/word processing package C/W lower case mod. (supplied & fitted)	£ 93.00		Diskettes 5 1/4" (Blank) Boxed 10, min. order 10, each	£ 3.00
	'Electric Pencil' text/word processing program (on cassette) Inc. documentation	£ 65.00		PRICES EXCLUDE VAT, FREIGHT & HANDLING. SEND OR 'PHONE FOR PRICE LIST.	
	S100 Interface for TRS 80 (available very shortly)	T. B. A.		Directors: Dr. R.V. King, BA, MIEE S.G. Johnson, BSc. T.S. Johnson, ABIBA, ACMB, FBSC, MBIM A.S. Barton, ACII, ABIBA, CdipAF	

If you don't see it - ask if we have it.

T & V JOHNSON (MICROCOMPUTERS ETC) LTD
Members of the TV Johnson Group of Companies
78 PARK STREET, CAMBERLEY, SURREY

Branches at: Birmingham, Bristol, Edinburgh, Leeds, London, Louth, Newmarket, Nottingham, Oxford, Byfleet, Wokingham.

Phone: (0276) 28333
(Plus 24hr answering machine Eves. & weekends)
Eves. Basingstoke (0256) 24787 and Farnham
(0252) 721094 (Answering Machines office hours)

● Circle No. 117

INTRODUCING THE HAZELTINE 1400 SERIES OF ECONOMY VIDEO TERMINALS TO MICROCOMPUTER USERS

Hazeltine Ltd., the U.K. subsidiary of Hazeltine Corporation, a world leader in Information Electronics for more than half a century, announces the introduction of a low-cost series of interactive video terminals, the 1400 series, aimed specifically at the practical microcomputer market.

The Hazeltine 1400 Terminal, priced at £550 one-off to end-users, contains all the major features required of an interactive video terminal, including all 128 ASCII codes, 64 displayable characters, cursor addressing and sensing, variable transmission rates up to 9,600 baud, EIA standard RS232C interface and remote command facility.

The Hazeltine 1410 Terminal has all the features of the 1400, and in addition has a separate integral numeric pad provided to facilitate efficient numeric data entry. This terminal is believed to offer more of what users want than any other TTY-compatible terminal currently on the market. It is available for around £600 one-off to end-users in the U.K. Hazeltine, has achieved this price/performance by utilising advanced microprocessor design, and produced terminals with an ultra-low component count. The company manufactures all the sub-assemblies including monitor, power supply and controller. Reliability and quality are significantly enhanced since all the electronics are contained on one pcb, eliminating all inter-connections other than input power and monitor connections.

Both terminals are normally available ex-stock from Hazeltine or its distributors throughout the United Kingdom and are supported under one of Hazeltine's Comprehensive Maintenance policies.



**Hazeltine Ltd, Terminal House,
14 Petersham Rd, Richmond, Surrey TW2 5BR
Tel: 01-948-3111 Telex: 928572**

DISTRIBUTORS

Midlands: Billing Machines Ltd., Cliftonville Road, Northampton NN1 5BU Tel: Northampton 21911 Telex: 31504
Scotland: Fortronic (Fife) Ltd., Donibristle Industrial Estate, Dumfermline, Fife KY11 5JW Tel: Dalgety Bay 823121 Telex 727438

S E England: Rair Terminals, 32 Neal Street, London WC2H 9PS Tel: 01-836 4663 Telex: 298452

N W England: Specialist Office Supplies, 269/271 Barlow Moor Rd., Chorlton-cum-Hardy, Manchester Tel 061-8610757 Telex: 667151

Ireland: Technico (Communications) Ltd., Astral House, Adelaide Rd., Dublin 2, Ireland Tel: Dublin 688222 Telex 5129

S W England: Gamma Computer Products Ltd., Gable House, Turnham Green, London W4 Tel: 01-995-3721
Hamilton Rentals, 53 Curtain Rd., London EC2 Tel: 01-739-3444 Telex: 263121

● Circle No. 118

L.P. ENTERPRISES

Room PC
313 Kingston Road, Ilford
Essex IG1 1PJ, England

From the representatives in Europe ... for America's leading Micro-computer magazines and books for the hobbyist, educationist and professional alike, we bring you a little light browsing!
Reading maketh a full man ... Francis Bacon (1561-1626)

Introduction to Microcomputers	
Volume 0 The Beginners Book	£5.95
Volume 1 Basic Concepts	£6.30
Volume 2 Some Real Microprocessors (without binder)	£18.95
Volume 2 Some Real Microprocessors (with binder)	£24.70
Volume 3 Some Real Support Devices (without binder)	£11.95
Volume 3 Some Real Support Devices (with binder)	£17.70
6 Updating supplements for Vol. 2 (for 1 year)	£18.95
6 Updating supplements for Vol. 3 (for 1 year)	£18.95
6 Updating supplements for Vol. 2 } (for 1 year)	£30.0
6 Updating supplements for Vol. 3 }	
Binder (specify for Vol.2 or Vol. 3)	£5.75
1 Updating supplement for Vol. 2	£4.00
1 Updating supplement for Vol. 3	£4.00

6800 Programming for Logic Design	£6.30
8080 Programming for Logic Design	£6.30
Z80 Programming for Logic Design	£6.30

Basic Computer Games	£5.50
What To Do After You Hit Return	T.B.A.
8080 Galaxy Game	£7.95
The Colossal Computer Cartoon Book	£3.95
Computer Rage (A Board Game)	£6.95
Artist and Computer	£3.95
Games with a Pocket Calculator	£1.75
Games, Tricks and Puzzles for a Hand Calculator	£2.49

Z80 Instruction Handbook	£3.50
8080 Programmers Pocket Guide	£1.95
8080 Hex Code Card	£1.95
8080 Octal Code Card	£1.95

Dr. Dobbs Journal: Vol. 1	£10.00
Best of Byte	£8.95
Scelbi Byte Primer	£9.95
Best of Creative Computing: Vol. 1	£6.95
Best of Creative Computing: Vol. 2	£6.95
Best of Micro	£5.50

8080A/8085 Assembly Language Programming	£6.45
6800 Assembler Language Programming	£6.45
8080 Software Gourmet Guide and Cookbook	£7.95
6800 Software Gourmet Guide and Cookbook	£7.95

MAGAZINE SUBSCRIPTIONS

	U.K.	Overseas
	price	price
Subscriptions start within 3 weeks		
Personal Computing (12 per year)	£16.00	£17.00
Interface Age (12 per year)	£20.00	£20.50
Dr. Dobbs Journal (10 per year)	£13.00	£13.50
Computer Music Journal (4 per year)	£8.50	£9.00
Peoples Computers (6 per year)	£8.00	£8.50
BYTE (12 per year)	£21.00	£21.00
Creative Computing (12 per year)	£16.00	£16.50
Calculators and Computers (7 per year)	£10.00	£10.50
Kilobaud (12 per year)	£20.00	£21.00
73 (12 per year)	£20.00	£21.00
MICRO-6502 Journal (12 per year)	£11.50	£12.50

First Book of Kim	£6.50
Microprocessors from Chips to Systems	£7.95
Microprocessor Interfacing Techniques	£7.95
Z80 Microcomputer Handbook	£7.50
T.V. Typewriter Cookbook	£7.50
T.T.L. Cookbook	£7.50
CMOS Cookbook	£7.95
IC OP Cookbook	£9.50
RTL Cookbook	£4.25

Some Common BASIC Programs	£6.30
Computer Programs that Work (in BASIC)	£2.55

Introduction to Personal and Business Computing	£4.95
Getting involved with Your Own Computer	£4.75
Your Home Computer	£7.95
How to Profit from your Personal Computer	£5.50
Reference Book of Personal & Home Computing	£4.95
Hobby Computers are Here	£3.95
New Hobby Computers	£3.95
Understanding Microcomputers and small Computer Systems	£7.95

Instant BASIC	£7.50
My Computer Likes Me ... When I speak in BASIC	£2.75
Basic BASIC	£6.50
Advanced BASIC	£6.00
Introduction to PASCAL	£4.00

Accounts Payable & Account Receivable	£10.95
Payroll with Cost Accounting	£10.95
General Ledger	£10.95

BASIC Software Library	
Vol. 1: Business and Games Programs	£17.50
Vol. 2: Maths, Engineering, Statistical Programs	£17.50
Vol. 3: Advanced Business Programs	£26.95
Vol. 4: General Purpose Programs	£7.95
Vol. 5: Experiments Programs	£7.95
Vol. 6: Miniature Business System	£32.50
Vol. 7: Chess/Medbil/Wdpros Programs	£29.95

8080 Standard Monitor	£9.95
8080 Standard Editor	£9.95
8080 Standard Assembler	£9.95
Special Package: 8080 Assembler, Editor, Monitor	£20.00
Tiny Assembler for 6800 systems	£5.75

MAGAZINE BACK ISSUES

Personal Computing	£1.75
Interface Age	£2.25
Dr Dobbs Journal	£1.75
ROM	£1.75
Computer Music Journal	£2.50
Peoples Computers	£1.75
BYTE	£2.25
Creative Computing	£1.75
Calculators & Computers	£1.75
Kilobaud	£2.25
73	£2.25
Micro-6502 Journal	£1.50

Magazine Storage Box (Holds 12) £1.25

HOW TO ORDER

Tick required items or write letter.

Please note our prices include postage and packing, but not insurance, if wanted add 12p for every £10 of books ordered. Make cheques PO's etc payable to —

L.P. Enterprises.

CREDIT CARDS accepted
BARCLAYCARD/VISA/ACCESS
DINERS CLUB/AMERICAN EXPRESS

Phone 01-553 1001 for Credit Card order (24-hr service).

Send to address above
Indicate Payment Method:

All Orders must be Prepaid
Total Enclosure £

..... My cheque, PO, I.M.O. is enclosed in **Sterling** on **U.K. Bank**

..... Charge to Barclaycard/Visa/Access/Diners/American Express

Credit Card No Expiry Date

Name

Address

..... POSTCODE

Signature

All publications are published in U.S.A. and shipped air-freight by **L.P. Enterprises**. In unusual cases, processing may exceed 30 days. Trade enquiries welcome.

DIODES/ZENERS				
QTY.				
1N914	100v	10mA	.05	
1N4005	600v	1A	.08	
1N4007	1000v	1A	.15	
1N4148	75v	10mA	.05	
1N4733	5.1v	1 W Zener	.25	
1N753A	6.2v	500 mW Zener	.25	
1N758A	10v	"	.25	
1N759A	12v	"	.25	
1N5243	13v	"	.25	
1N5244B	14v	"	.25	
1N5245B	15v	"	.25	

SOCKETS/BRIDGES				
QTY.				
8-pin	pcb	.20	ww	.35
14-pin	pcb	.20	ww	.40
16-pin	pcb	.20	ww	.40
18-pin	pcb	.25	ww	.95
20-pin	pcb	.35	ww	.95
22-pin	pcb	.35	ww	.95
24-pin	pcb	.35	ww	.95
28-pin	pcb	.45	ww	1.25
40-pin	pcb	.50	ww	1.25
Molex pins	.01	To-3 Sockets	.25	
2 Amp Bridge		100-prv	.95	
25 Amp Bridge		200-prv	1.50	

TRANSISTORS, LEDS, etc.				
QTY.				
2N2222	(2N2222 Plastic .10)	.15		
2N2222A		.19		
2N2907A	PNP	.19		
2N3906	PNP (Plastic Unmarked)	.10		
2N3904	NPN (Plastic Unmarked)	.10		
2N3054	NPN	.45		
2N3055	NPN 15A 60v	.60		
T1P125	PNP Darlington	1.95		
LED Green,	Red, Clear, Yellow	.15		
D.L.747	7 seg 5/8" High com-anode	1.95		
MAN72	7 seg com-anode (Red)	1.25		
MAN3610	7 seg com-anode (Orange)	1.25		
MAN82A	7 seg com-anode (Yellow)	1.25		
MAN74	7 seg com-cathode (Red)	1.50		
FND359	7 seg com-cathode (Red)	1.25		

9000 SERIES				
QTY.		QTY.		
9301	.85	9322	.65	
9309	.35	9601	.20	
9316	1.10	9602	.45	

MICRO'S, RAMS, CPU'S, E-PROMS				
QTY.		QTY.		
8T13	1.50	2107B-4	4.95	
8T23	1.50	2114	9.50	
8T24	2.00	2513	6.25	
8T97	1.00	2708	10.50	
74S188	3.00	2716 D.S.	34.00	
1488	1.25	2716 (5v)	59.00	
1489	1.25	2758 (5v)	23.95	
1702A	4.50	3242	10.50	
AM 9050	4.00	4116	11.50	
		6800	13.95	
MM 5314	3.00	6850	7.95	
MM 5316	3.50	8080	7.50	
MM 5387	3.50	8212	2.75	
MM 5369	2.95	8214	4.95	
TR 1602B	3.95	8216	3.50	
UPD 414	4.95	8224	3.25	
Z 80 A	22.50	8228	6.00	
Z 80	17.50	8251	7.50	
Z 80 P10	10.50	8253	18.50	
2102	1.45	8255	8.50	
2102L	1.75	TMS 4044	9.95	

C MOS	
QTY.	
4000	.15
4001	.15
4002	.20
4004	3.95
4006	.95
4007	.20
4008	.75
4009	.35
4010	.35
4011	.20
4012	.20
4013	.40
4014	.75
4015	.75
4016	.35
4017	.75
4018	.75
4019	.35
4020	.85
4021	.75
4022	.75
4023	.20
4024	.75
4025	.20
4026	1.95
4027	.35
4028	.75
4029	1.15
4030	.30
4033	1.50
4034	2.45
4035	.75
4037	1.80
4040	.75
4041	.69
4042	.65
4043	.50
4044	.65
4046	1.25
4048	.95
4049	.45
4050	.45
4052	.75
4053	.75
4066	.55
4069/74C04	.35
4071	.25
4081	.30
4082	.30
4507	.95
4511	.95
4512	1.10
4515	2.95
4519	.85
4522	1.10
4526	.95
4528	1.10
4529	.95
MC 14409	14.50
MC 14419	4.85
74C151	1.50

LINEARS, REGULATORS, etc.			
QTY.		QTY.	
MCT2	.95	LM323K	5.95
8038	3.95	LM324	1.25
LM201	.75	LM339	.75
LM301	.45	7805 (340T5)	.95
LM308	.65	LM340T12	.95
LM309H	.65	LM340T15	.95
LM309K (340K-5)	1.50	LM340T18	.95
LM310	.85	LM340T24	.95
LM311D	.75	LM340K12	1.25
LM318	1.75	LM340K15	1.25
LM320H6	.79	LM340K18	1.25
LM320H15	.79	LM340K24	1.25
LM320H24	.79	LM373	2.95
7905 (LM320K5)	1.65	LM377	3.95
LM320K12	1.65	78L05	.75
LM320K24	1.65	78L12	.75
LM320T5	1.65	78L15	.75
LM320T12	1.65	78M05	.75
LM320T15	1.65		
		LM380 (8-14 Pin)	1.19
		LM709 (8-14 Pin)	.35
		LM711	.45
		LM723	.40
		LM725	2.50
		LM739	1.50
		LM741 (8-14)	.35
		LM747	1.10
		LM1307	1.25
		LM1458	.65
		LM3900	.50
		LM75451	.65
		NE555	.45
		NE556	.85
		NE565	.95
		NE566	1.25
		NE567	.95

- T T L -			
QTY.		QTY.	
7400	.10	7482	.75
7401	.15	7483	.75
7402	.15	7485	.55
7403	.15	7486	.25
7404	.10	7489	1.05
7405	.25	7490	.45
7406	.25	7491	.70
7407	.55	7492	.45
7408	.15	7493	.35
7409	.15	7494	.75
7410	.15	7495	.60
7411	.25	7496	.80
7412	.25	74100	1.15
7413	.25	74107	.25
7414	.75	74121	.35
7416	.25	74122	.55
7417	.40	74123	.35
7420	.15	74125	.45
7426	.25	74126	.35
7427	.25	74132	.75
7430	.15	74141	.90
7432	.20	74150	.85
7437	.20	74151	.65
7438	.20	74153	.75
7440	.20	74154	.95
7441	1.15	74156	.70
7442	.45	74157	.65
7443	.45	74161	.55
7444	.45	74163	.85
7445	.65	74164	.60
7446	.70	74165	1.10
7447	.70	74166	1.25
7448	.50	74175	.80
7450	.25	74176	.85
7451	.25	74180	.55
7453	.20	74181	2.25
7454	.25	74182	.75
7460	.40	74190	1.25
7470	.45	74191	1.25
7472	.40	74192	.75
7473	.25	74193	.85
7474	.30	74194	.95
7475	.35	74195	.95
7476	.40	74196	.95
7480	.55	74197	.95
7481	.75	74198	1.45
		74221	1.00
		74367	.95
		75108A	.35
		75491	.50
		75492	.50
		74H00	.15
		74H01	.20
		74H04	.20
		74H05	.20
		74H08	.35
		74H10	.35
		74H11	.25
		74H15	.45
		74H20	.25
		74H21	.25
		74H22	.40
		74H30	.20
		74H40	.25
		74H50	.25
		74H51	.25
		74H52	.15
		74H53	.25
		74H55	.20
		74H72	.35
		74H74	.35
		74H101	.75
		74H103	.55
		74H106	.95
		74L00	.25
		74L02	.20
		74L03	.25
		74L04	.30
		74L10	.20
		74L20	.35
		74L30	.45
		74L47	1.95
		74L51	.45
		74L55	.65
		74L72	.45
		74L73	.40
		74L74	.45
		74L75	.85
		74L93	.55
		74L123	.85
		74LS00	.30
		74LS01	.30
		74LS02	.30
		74LS04	.30
		74LS05	.35
		74LS08	.35
		74LS09	.35
		74LS10	.35
		74LS11	.35
		74LS20	.30
		74LS21	.35
		74LS22	.35
		74LS32	.35
		74LS37	.35
		74LS38	.45
		74LS40	.40
		74LS42	.75
		74LS51	.45
		74LS74	.45
		74LS76	.50
		74LS86	.45
		74LS90	.65
		74LS93	.65
		74LS107	.50
		74LS123	1.20
		74LS151	.85
		74LS153	.85
		74LS157	.85
		74LS160	.95
		74LS164	1.20
		74LS193	1.05
		74LS195	.95
		74LS244	1.70
		74LS367	.95
		74LS368	.95
		74S00	.35
		74S02	.35
		74S03	.25
		74S04	.25
		74S05	.35
		74S08	.35
		74S10	.35
		74S11	.35
		74S20	.25
		74S40	.20
		74S50	.20
		74S51	.25
		74S64	.15
		74S74	.35
		74S112	.60
		74S114	.65
		74S133	.40
		74S140	.55
		74S151	.30
		74S153	.35
		74S157	.75
		74S158	.30
		74S194	1.05
		74S257 (8123)	1.05
		8131	2.75

CABLE ADDRESS: ICUSD

TELEX #

HOURS: 9 A.M. - 6 P.M. MON. thru SUN.

INTEGRATED CIRCUITS UNLIMITED

7889 Clairemont Mesa Blvd. • San Diego, California 92111 U.S.A.

NO MINIMUM

COMMERCIAL AND MANUFACTURING ACCOUNTS INVITED

ALL PRICES IN U.S. DOLLARS. PLEASE ADD POSTAGE TO COVER METHOD OF SHIPPING.

ORDERS OVER \$100 (U.S.) WILL BE SHIPPED AIR NO CHARGE.

PAYMENT SUBMITTED WITH ORDER SHOULD BE IN U.S. DOLLARS.

ALL IC'S PRIME/GUARANTEED ALL ORDERS SHIPPED SAME DAY RECEIVED.

CREDIT CARDS ACCEPTED:

Phone (714) 278-4394 BarclayCard / Access / American Express / BankAmericard / Visa / MasterCharge

SPECIAL DISCOUNTS

Total Order	Deduct
\$35-\$99	10%
\$100-\$300	15%
\$301-\$1000	20%

Britain is a nation of PET lovers

**THE No. 1
Personal
Computer
in the
U.K.**

**Hobbyist
Commercial
Scientist
Education**

**Affordable
£695
inc. VAT**



for the first time
user and the professional
check out the PET, the world's
most popular personal computer

- * **CAPABLE** - just like a traditional computer.
- * **UNDERSTANDABLE** - fast, comprehensive and powerful - BASIC is one of the easiest computer languages to learn, understand and use. Machine language accessibility for the professionals.
- * **PERSONAL** - easily portable and operated - just "plug in" and go. Unique graphics make fascinating displays.
- * **EXPANDABLE** - built in IEEE-488 output, 8K RAM expandable to 32K, parallel user port 2nd. Cassette interface.
- * **SERVICEABLE** - easily serviced - only 3p.c. boards all readily accessible.

Features of PETS extended BASIC include

Integer, floating point and string variables; A full set of scientific functions, Logical operators, Multi-statement lines. String functions, Left \$, Right \$, Mid \$, Chr \$, Val, Str \$, Peek, Poke, Usr, Sys, to interface to memory and machine language subroutines. Time of day variable.

Future Commodore developments * FLOPPY DISC * PRINTER
* MEMORY EXPANSION * MODEM

Extensive software readily available.

Contact your nearest PET dealer, call today for a demonstration

**In case of difficulty call COMMODORE SYSTEMS DIVISION
360 Euston Road, London. Tel. 01-388-5702**

AUTHORISED PET COMMODORE DEALERS

Birmingham
Taylor-Wilson Systems
Ltd Knowle
05645-6192

Bristol
Sumlock Tabdown Ltd
0272-26685

Derby
Davidson-Richards (Int)
Ltd
0332-366803

Durham
Dyson Instruments
0385-66937

Grimsby
Allen Computers
0472-40568

Guildford
P.P.M.
0483-37337

Hemel Hempstead
Data Efficiency Ltd
0442-57137

Kettering
H.B. Computers Ltd
0536-83922

Liverpool
Dams Office Equipment
Ltd
051-227-3301

London E.C.1
Sumlock Bondain Ltd
01-253-2447

London W.C.2
TLC World Trading Ltd
01-839-3893

Manchester
Cytek (UK) Ltd
061-832-7604

**Sumlock Electronic
Services**
061-228-3507

Newport
G.R. Electronics Ltd
0633-67426

Northern Ireland
Medical & Scientific
08462-77533

Nottingham
Betos (Systems) Ltd
0602-48108

Reading
C.S.E. (Computers)
0734-61492

Southampton
Symtec Systems Ltd
0703-37731

Thame, Oxon
Memec Systems Ltd
084-421-2149

Woking
Petalect Ltd
048-62-69032

Yeovil
Computerbits Ltd
0935-26522

SOURCE

Micro Computer Consultants

12 Vivian Road,
Wellingborough,
Northamptonshire.

Telephone: (0933) 224040

6800 SOFTWARE UNDER FLEX

With full documentation

ASEM disk to disk Relocating — Linking system

- * Produces relocatable modules or memory image files
- * Linking editor produces a disk file from modules
- * May function as a normal disk to disk assembler

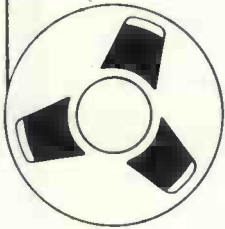

LABDIS Labelling disk to disk disassembler

- * Handles data blocks (FCC, FCB)
- * Produces disk files which may be re-assembled
- * Inserts User-Defined equates from a disk file £40 plus disk

PARTS Inventory System

- * Replaces existing manual card system
- * Real-time system provides up to the minute status
- * Hash-code structure gives very fast retrieval time



Source

Source is a software company available to write programs for small-computer users. Telephone us for a quotation on your software requirements. Prices exclude V.A.T.

● Circle No. 122

*** COMMODORE BASIC ***

31743 BYTES FREE

READY.

PAM is a self-contained add-on memory unit for PET computers. It is available in 8K, 16K, 24K and 32K versions. 8K cards are available to augment all but 32K versions at a later date.

Operation is simply by plugging-in to PET's memory expansion port, using the high-quality, protected connector provided, and to the mains. PET power consumption, temperature and warranty are unaffected.

The standard, 24K version upgrades PET's memory to the full 32K addressable in BASIC, giving over 4 times the capacity of the standard 8K PET.

All units are guaranteed for 6 months and are supplied with full instructions

PRICES—8K £154
(ex VAT) 16K £232 plus £4.50 carr.
24K £310 and insurance
32K £367

8K plug-in card £78 plus £2.50 carr. and insurance

Prices are correct at time of going to press—subject to change without notice.

OMB electronics, Riverside, Eynsford, Kent DA4 0AE
Tel: Farningham (0322) 863567

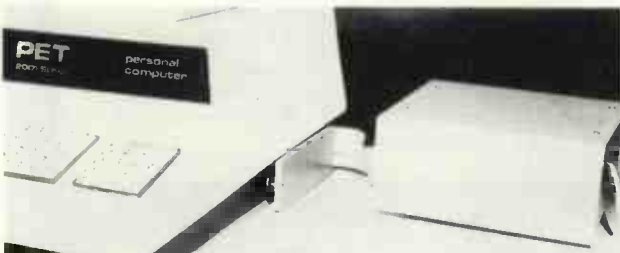

● Circle No. 123

CAMBRIDGE COMPUTER STORE

We can help you select the right system for your application here in Cambridge. Your choice won't be limited—we'll demonstrate as comprehensive a range of microcomputers as you'll find anywhere in the U.K.:

TANDY TRS-80
APPLE II
NORTH-STAR HORIZON
CROMEMCO
SORCERER
SUPERBOARD II
NASCOM-1

Where possible we deliver off-the-shelf. Our stock also includes a vast range of **electronic components** as well as **computer books** and **magazines**.

The store is open 6 days a week from 9–5.30 with demonstration systems always in operation. We offer a professional standard of advice and after-sales support and we're ready to discuss your application any time.

CAMBRIDGE COMPUTER STORE
1 Emmanuel Street, Cambridge
(0223) 68155

● Circle No. 124

This Is The Famous

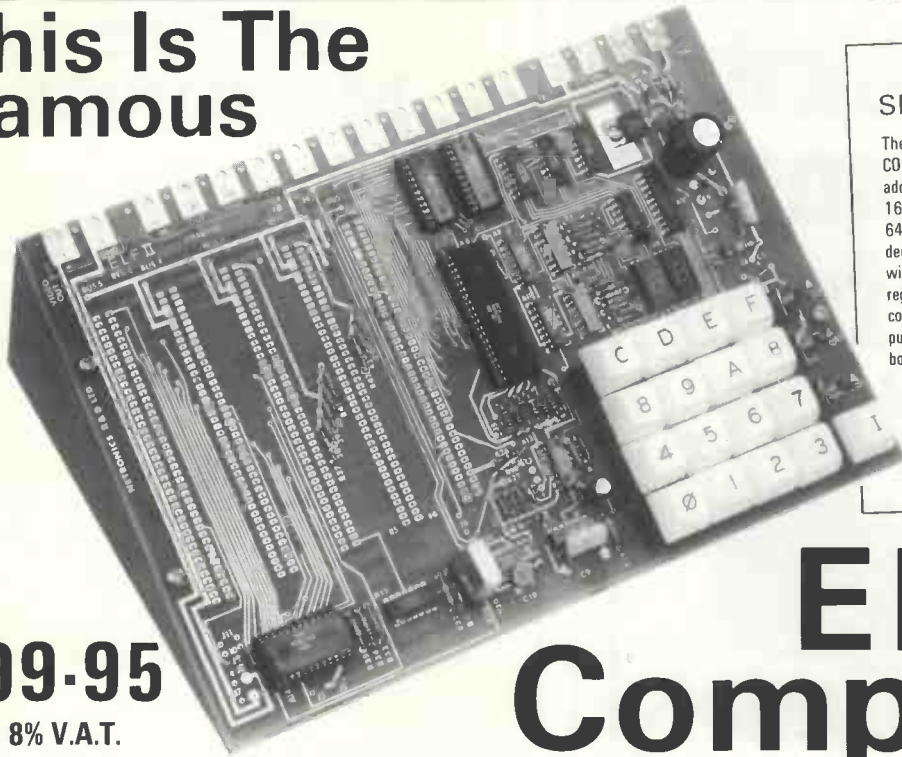

SPECIFICATIONS

The £99.95 ELF II computer features an RCA COSMAC COS/MOS 1802 8-bit microprocessor addressable to 64K bytes with DMA, interrupt, 16 registers, ALU, 256 byte RAM expandable to 64K bytes, professional hex keyboard fully decoded so there's no need to waste memory with keyboard scanning circuits, built-in power regulator, 5 slot plug-in expansion bus (less connectors), stable crystal clock for timing purposes and a double-sided, plated-through pc board plus RCA 1861 video IC to display any segment of memory on a video monitor or TV screen along with all the logic and support circuitry you need to learn every one of the RCA 1802's capabilities.

£99.95

PLUS 8% V.A.T.

ELF II Computer

Stop reading about computers and get your hands on one! With ELF II and our new *Short Course* by Tom Pittman, you can master computers in no time at all! ELF II demonstrates all 91 commands an RCA 1802 can execute and the *Short Course* quickly teaches you how to use each of the 1802's capabilities.

ELF II's video output lets you display an alphanumeric readout or graphics on any TV screen or video monitor and enjoy the latest video games.

But that's not all. Once you've mastered computer fundamentals, ELF II can give you POWER with add-ons that are among the most advanced found anywhere. American IEEE chapters plus hundreds of universities and major corporations have chosen the ELF II to introduce their students and personnel to microprocessor computing!

Learn The Skill That May Soon Be Far More Important Than Your College Degree!

The ability to use a computer may soon be more important to your earning power than a college degree. Without a knowledge of computers, you are always at the mercy of others when it comes to solving highly complex business, engineering, industrial and scientific problems. People who understand computers can command MONEY and to get in on the action, you must learn computers. Otherwise you'll be left behind.

ELF II Is The F-A-S-T Way to Learn Computer Fundamentals!

Regardless of how minimal your computer background is now, you can learn to programme a computer in almost no time at all. That's because Netronics has developed a special *Short Course on Microprocessor And Computer Programming* in non-technical language that leads you through every one of the RCA COSMAC 1802's capabilities so you'll understand everything ELF II can do. ...and how to get ELF II to do it!

All 91 commands that an 1802 can execute are explained to you, step-by-step. The text, written for Netronics by Tom Pittman, is a tremendous advance over every other programming book in print.

Keyed specifically to the ELF II, it's loaded with "hands on" illustrations. When you're finished, ELF II and the 1802 will no longer hold any mysteries for you.

In fact, not only will you be able to use a personal computer creatively, you'll also be able to understand computing articles in the technical press.

If you work with large computers, ELF II and our *Short Course* will help you to understand what makes them tick.

A Dynamic Package For Just £99.95 Plus 8% V.A.T.!

With ELF II, you learn to use machine language — the fundamental language of all computers. Higher level languages such as FORTRAN and BASIC must be translated into machine language before a computer can understand them. With ELF II you build a solid foundation in computers so you'll really know what you're doing, no matter how complicated things get.

Video output also makes ELF II unique among computers selling such a low price. Attached to your TV set, ELF II becomes a fabulous home entertainment centre. It's capable of providing endless hours of fun for both adults and children of all ages! ELF II can create graphics, alphanumeric displays and fantastic video games.

Only a low cost RF modulator is required to connect ELF II to your TV's aerial socket! (To order see below.)

ELF II's 5-card expansion bus (connectors not included) allows you to expand ELF II as your needs for power grows. If you're an engineer or hobbyist, you can also use ELF II as a counter, alarm, lock, thermostat, timer, or for countless other applications.

ELF II Explodes Into A Giant!

Thanks to ongoing work by RCA and Netronics, ELF II add-ons are among the most advanced anywhere. Plug in the GIANT BOARD and you can record and play back programmes, edit and debug programmes, communicate with remote devices and make things happen in the outside world. Add Kluge Board to get ELF II to solve special problems such as operating a more complex alarm system or controlling a printing press. Add 4k RAM board and you can write longer programmes, store more information and solve more sophisticated problems.

Expanded, ELF II is perfect for engineering, business, industrial, scientific and personal finance and tax applications. No other small computer anywhere near ELF II's low price is backed by such an extensive research and development programme.

The ELF-BUG Monitor is an extremely recent breakthrough that lets you debug programmes with lightning speed because the key to debugging is to know what's inside the registers of the microprocessor and, instead of single stepping through your programme, the ELF-BUG Monitor, utilizing break points, lets you display the entire contents of the registers on your TV screen at any point in your programme. You find out immediately what's going on and can make any necessary changes. Programming is further simplified by displaying 24 bytes of RAM with full address, blinking cursor and auto scrolling. A must for serious programmers!

Netronics will soon be introducing the ELF II Colour Graphics & Music System — more breakthroughs that ELF II owners will be the first to enjoy!

Now BASIC Makes Programming ELF II Even Easier!

Like all computers, ELF II understands only "machine language" — the language computers use to talk to each other. But, to make life easier for you, we've developed an ELF II Tiny BASIC. It talks to ELF II in machine language for you so that you can programme ELF II with simple words that can be typed out on a keyboard such as PRINT, RUN and LOAD.

"Ask Not What Your Computer Can Do ... But What Can It Do For YOU!"

Don't be trapped into buying a dinosaur simply because you can afford it and it's big. ELF II is more useful and more fun than "big name" computers that cost a lot more money.

With ELF II, you learn to write and run your own programmes. You're never reduced to being a mere keypunch operator, working blindly with someone else's predeveloped software.

No matter what your speciality is, owning a computer which you really know how to use is sure to make you a leader. ELF II is the fastest way there is to get into computers. Order from the coupon below!

H.L. AUDIO LTD., Dept. P.C., 138 Kingsland Road, London E2 8DY

— SEND TODAY! —

NOW AVAILABLE FOR ELF II —

- Tom Pittman's *Short Course On Microprocessor & Computer Programming* teaches you just about everything there is to know about ELF II or any RCA 1802 computer. Written in non-technical language, it's a learning breakthrough for engineers and laymen alike. £5-00* post paid!
- Deluxe metal cabinet with plexiglas dust cover for ELF II. £29-95* plus £1-50 p&p.
- RF Modulator for use with TV set. £3-00* post paid.
- GIANT BOARD kit with cassette I/O, RS 232-C/TTY I/O, 8-bit P I/O, decoders for 14 separate I/O instructions and a system monitor/editor. £39-95* plus £1-00 p&p.
- Kluge (Prototype) Board accepts up to 36 IC's. £17-00 plus 50p. p&p.
- 4k Static RAM kit. Addressable to any 4k page to 64k. £89-95* plus 50p. p&p.
- Gold plated 86-pin connectors (one required for each plug-in board). £5-70* post paid.
- Professional ASCII Keyboard kit with 128 ASCII upper/lower case set, 96 printable characters, onboard regulator, parity, logic selection and choice of 4 handshaking signals to mate with almost any computer. £64-95* post paid.
- Deluxe metal cabinet for ASCII Keyboard. £19-95* plus £1-50 p&p.
- ELF II Tiny BASIC on cassette tape. Commands include SAVE, LOAD, ±, x, =, (), 26 variables A-Z, LET, IF/THEN, INPUT,

- PRINT, GO TO, GO SUB, RETURN, END, REM, CLEAR, LIST, RUN, PLOT, PEEK, POKE. Comes fully documented and includes alphanumeric generator required to display alphanumeric characters directly on your TV screen without additional hardware. Also plays tick-tack-toe plus a drawing game that uses ELF II's hex keyboard as a joystick, 4k memory required. £14-95* post paid.
 - Tom Pittman's *Short Course on Tiny BASIC* for ELF II. £5-00* post paid.
 - Expansion Power Supply (required when adding 4k RAM). £19-95* plus £2-00 p&p.
 - ELF-BUG Deluxe System Monitor on cassette tape. Allows displaying the contents of all registers on your TV at any point in your programme. Also displays 24 bytes of memory with full addresses, blinking cursor and auto scrolling. A must for the serious programmer! £14-95* post paid.
 - Coming Soon: A-D, D-A Converter, Light Pen, Controller Board, Colour Graphics & Music System ... and more!
- Call or write for wired prices!

H. L. AUDIO LTD., Dept. P.C.
138 Kingsland Road, London E2 8DY
(Tel 01-739 1582)

Sole European Distributors for Netronics R & D Ltd., U.S.A.

Yes! I want to run programmes at home and have enclosed £109-55 including postage and V.A.T. for RCA COSMAC ELF II kit, £5-94 including postage and V.A.T. for power

- supply (required). £5-95 for RCA 1802 User's Manual. £5-95 including postage and V.A.T. for *Short Course on Microprocessor Computer Programming*.
- I want mine wired and tested with power supply, RCA 1802 User's Manual and *Short Course* included for just £184-10 including postage and V.A.T.
- I am also enclosing payment (including postage and V.A.T.) for the items checked at the left.

Total Enclosed £

USE YOUR ACCESS BARCLAYCARD

Account No. _____

Signature _____

Exp. Date _____

CREDIT CARD PHONE ORDERS ACCEPTED 01-739 1582

Print Name _____

Address _____

DEALER INQUIRIES INVITED

Heathkit systems. Right from the start.

At Heathkit, we do our homework properly. And the result is an exceptional range of computer equipment.



H9 video terminal, with 87 ASCII keys.

Processors, video terminals, cassette units and floppy disk drives.

A paper tape reader/punch and a printer.

You can make up a system that suits your application and your pocket, and then you can extend it whenever you want to.

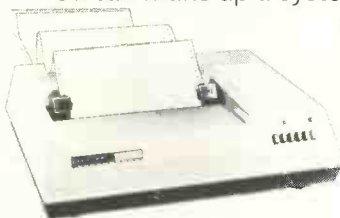

H14 Line printer.

And the quality is superb throughout.

Choose from assembled units or kits - all accompanied by some of the world's best documentation.

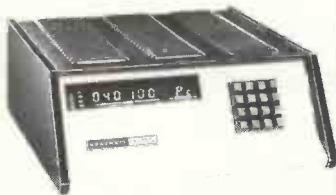

H8 computer, extendable from 8K to 64K.

The details are in our colour brochure. Send for your copy now.



To: Heath (Gloucester) Limited, Dept. PC4
Bristol Road, Gloucester, GL2 6EE.

Name _____
Address _____

Heathkit self-instructional computer courses, probably the finest available.

- Please tick the item(s) you want.
- Colour brochure of computer equipment. (Enclose 20p in stamps.)
 - Catalogue of other electronics kits and courses. (Enclose 20p in stamps.)
- Registered in England, number 606177.

THERE ARE HEATHKIT SHOWROOMS AT
233 Tottenham Court Road, London (01-636 7349)
and Bristol Road, Gloucester (0452-29451)

● Circle No. 126

HAPPY MEMORIES

21L02 450ns 80p	2114 450ns £5.25
21L02 250ns 95p	2114 300ns £6.00
4116 250ns £9.25	2708 450ns £6.75

TRS-80 16K Memory Upgrade Kit £75
Full instructions included

S100 16K Static RAM Kit 450ns £195
Bank select, 4K boundaries, all sockets, components and instructions included

ASCII Keyboards from the USA £48.50
59 keys, 128 characters, alpha-lock, repeat, pos and neg strobe, send SAE for data sheet

Science of Cambridge Mk 14 set of 18
Texas low-profile sockets £2.80

Texas low-profile DIL sockets:
pins 8 14 16 18 20 22 24 28 40
pence 10 11 12 17 18 20 22 28 38

Antex Imm bits CCN or CX17 45p

Call or write for 74LS price list

VAT included. 20p p + p under £10 order

**5 Cranbury Terrace, Southampton
Hants SO2 0LH Tel. (0703) 39267**

● Circle No. 127

Micro Software Systems

DESK TOP COMPUTERS

Find it difficult to make a choice?
Utilise our experience to make the right decision.
Micro Software Systems Supply:

HORIZON
RAIR BLACK BOX
EQUINOX 300
COMPUCORP 600 SERIES
COMPACT 400
MODATA
COMMA V.03 and other LSI BASED SYSTEMS

A complete range of peripherals complements this selection.

Application Software available: Packaged or Bespoke.

Prices from £350
Quantity Discounts can be arranged.

Call or write and we will be happy to discuss your problems.

**Micro Software Systems,
Stanhope House,
Stanford-le-Hope,
Essex**

Tel: Stanford-le-Hope (03756) 41991/2

● Circle No. 128

THE EXPANDABLE GENERAL-PURPOSE MICROCOMPUTER



THE RESEARCH MACHINES 380Z

A UNIQUE TOOL FOR RESEARCH AND EDUCATION

Microcomputers are extremely good value. The outright purchase price of a 380Z installation with dual mini floppy disk drives, digital I/O and a real-time clock, is about the same as the annual maintenance cost of a typical laboratory minicomputer. It is worth thinking about!

The RESEARCH MACHINES 380Z is an excellent microcomputer for on-line data logging and control. In university departments in general, it is also a very attractive alternative to a central mainframe. Having your own 380Z means an end to fighting the central operating system, immediate feedback of program bugs, no more queuing and a virtually unlimited computing budget. You can program in interactive BASIC or run very large programs using our unique Text Editor with a 380Z FORTRAN Compiler. If you already have a minicomputer, you can use your 380Z with a floppy disk system for data capture.

What about Schools and Colleges? You can purchase a 380Z for your Computer Science or Computer Studies department at about the same cost as a terminal. A 380Z has a performance equal to many minicomputers and is ideal for teaching BASIC and Cesium. For A Level machine language instruction, the 380Z has the best software front panel of any computer. This enables a teacher to single-step through programs and observe the effects on registers and memory, using a single keystroke.

WHAT OTHER FEATURES SET THE 380Z APART?

The 380Z with its professional keyboard is robust, hardwearing equipment that will endure continual handling for years. It has an integral VDU interface—just plug a black and white television into the system in order to provide a display unit—you do not need to buy a separate terminal. The integral VDU interface gives you upper and lower case characters and low resolution graphics. Text and graphics can be mixed *anywhere* on the screen. The 380Z also has an integral cassette interface, software and hardware, which uses *named* cassette

files for both program and data storage. This means that it is easy to store more than one program per cassette.

Owners of a 380Z microcomputer can upgrade their system to include floppy (standard or mini) disk storage and take full advantage of a unique occurrence in the history of computing—the CP/MTM* industry standard disk operating system. The 380Z uses an 8080 family microprocessor—the Z80—and this has enabled us to use CP/M. This means that the 380Z user has access to a growing body of CP/M base-software, supplied from many independent sources.

380Z mini floppy disk systems are available with the drives mounted in the computer case itself, presenting a compact and tidy installation. The FDS-2 standard floppy disk system uses double-sided disk drives, providing 1 Megabyte of on-line storage.

Versions of BASIC are available with the 380Z which automatically provide controlled cassette data files, allow programs to be loaded from paper tape, mark sense card readers or from a mainframe. A disk BASIC is also available with serial and random access to disk files. Most BASICs are available in erasable ROM which will allow for periodic updating.

If you already have a teletype, the 380Z can use this for hard copy or for paper tape input. Alternatively, you can purchase a low cost 380Z compatible printer for under £300, or choose from a range of higher performance printers.

*CP/MTM Registered trademark Digital Research.

380Z/16K System with Keyboard £965.00

380Z/56K complete with DUAL FULL FLOPPY DISK SYSTEM FDS-2 £3,266.00

380Z Computer Systems are distributed by RESEARCH MACHINES, P.O. Box 75, Chapel Street, Oxford. Telephone: OXFORD (0865) 49792. Please send for the 380Z information Leaflet. Prices do not include VAT @ 8% or Carriage

**NEW LOW
PRICES**

56-STATION ASCII KEYBOARD NOW IN STOCK — ASCII KEYBOARD MODEL KB756



KB756 mounted on PCB
ONLY £49.50

(mail order total £55.08)

KB756MF including metal mounting frame for extra rigidity,

ONLY £55.00 (mail order total £61.02)

SELF-SCAN ALPHANUMERIC PANEL DISPLAY

16/18 position display with 64 character repertoire, 5 x 7 dot matrix. Input 6-bit BCD-code, power requirements +5v, -12v. Character size 0.40" x 0.28" Overall dimensions 8 1/4" x 2 1/4" x 1 1/4". Supplied with full technical data. Price £55.00 + 75p P&P + 8% VAT (Mail order total £60.21).

Optional Extras:

		Mail Order Total
KB15P	Edge Connector	£ 3.25 £ 4.05
KB701	Plastic Enclosure	£12.50 £14.31
KB702	Steel Enclosure	£25.00 £28.62
KB710	Numeric Pad	£ 8.00 £ 9.18
KB2376	Spare ROM Encoder	£12.50 £14.04

SEAELECTRO PATCH BOARDS

Programme boards for switching and interconnecting input/output circuits. 11 x 20 XY matrix. Interconnection is by means of shorting, skip and component holding pins (not supplied). Dimensions: 7 1/2" x 5 3/4" x 1"



**PRICE:
£12.50**

(mail order total £14.58)

NEW KEYTOP/ KEYSWITCH KITS

Pack of 56 keyswitches plus 56 keytops comprising standard ASCII character set. Ideal as basis for self-build keyboard projects.

**BRAND NEW SURPLUS
PRICE: £15.00**

(mail order total £17.28)

We also specialise in: DEC minis—PDP8 and PDP11 processors, add-on memory, peripherals and spares. Hard copy terminals—ASR 33 and KSR 33 Teletypes, Data Dynamics 390, Texas Silent 700. Send for complete lists.



ELECTRONIC BROKERS LTD.
49-53 Pancras Road, London NW1 2QB.
Tel: 01-837 7781. Telex: 298694.

Reconditioned

HAZELTINE VISUAL DISPLAY UNIT

- * Teletype Compatible
- * 12" Diagonal Screen
- * TTY Format Keyboard
- * 12 lines of 80 characters
- * 64 ASCII Character Set
- * 5 x 7 Dot Matrix
- * Switch-selectable Transmission Speeds up to 9600 baud
- * Switch-selectable Parity
- * Standard CCITT V.24 Interface



MODEL H-1000 PRICE £350 + carriage and VAT

Also available: —

Model H-2000: Buffered/Editing model with direct cursor addressing, dual intensity video, and detachable keyboard with separate numeric and edit clusters. 27 lines of 74 characters. Price £495.00 + carriage + VAT.

A copy of trading conditions supplied on request

● Circle No. 130

DE BOER ELECTRONICS

Our program contains a large assortment of kits. Specially interesting is a microprocessor kit designed by Elektor magazine. This SC/MP µP (National Semiconductors) consist of:

- RAM I.O (9846-1), digital in- and output. With binary switches—displaying the databus £32.35
- SC/MP board (9846-2), a simple mainboard. With the µP- and timing circuits £26.75

With these two kits you can start your own "µP-ing"

- CPU-card (9851) extension card for the SC/MP. This card contains the SC/MP (you don't need the SC/MP board anymore) E-prom for monitor, some RAM etc. £90.50
- Bus-board (9857): Handy card to connect to SC/MP unit in an easy way £3.00



- Memory card (9863): This card completes the heart of the kit. With some memory and monitor E-proms £57.00
- Hex I.O (9893): Now you can load your program in hex-code and on the card there are hex displays £67.25
- 4-K RAM (9885): memory extension £112.05
- SC/MP power supply (9906) with transformers £23.05
- Cassette interface (9905): This kit makes it possible to store programs in an easy way. You can use an ordinary cassette-recorder £16.05
- 3 Elburg-programmed Eproms £68.85
- Complete system, consists of 9851-9863-9885-9906-9905 and Elburg Eproms £349.00
- Keyboard complete with encoder £46.50
- Video display terminal (accepts information of keyboard and SC/MP µP) £69.00

Ordering details:

By letter to: Mike Hutchinson, 2 Lynn Road, Grimston, Kings Lynn, Norfolk PE32 1AD. Phone: Monday to Friday 1 pm to 6 pm. Saturday 10 am to 1pm. At Hillingdon (04856) 553 cheques and postal orders only in the name of De Boer Electronics. All prices are VAT-inclusive. Add 50p for post and packing. No callers, please.



**de boer
elektronika**

Kleine Berg 39-41 Eindhoven
Nederland, tel 040-448229

● Circle No. 131

The exciting new
TRITON
Personal Computer
exclusively from:

TRANSAM



Complete kit of parts available only £286 (+ VAT)

Basic in Rom: a powerful 2k Tiny basic resident on board, makes Triton unique, easy to use and versatile.

Graphics: 64 Graphic characters as well as full alpha numerics.

Single Board: Holds up to 8k of memory, 4k RAM and 4k ROM, supplied with 3k ROM and 2k RAM.

Memory Mapping: 2 mode VDU I/O or memory mapped for animated graphics.

Cassette Interface: crystal controlled Modern tape I/O with auto start/stop + "named" file search.

UHF TV Interface: On board uhf modulator, plugs into TV aerial socket.

Comes Complete with KEYBOARD, CASE, POWER SUPPLY, THRO-HOLE PLATED QUALITY P.C.B. FULL DOCUMENTATION POWERFUL 1k MONITOR & 2k TINY BASIC PLUS ALL COMPONENTS INCL. IC SOCKETS. NOTE TV SET & CASSETTE NOT INCLUDED.

Expansion: Expand your Triton simply and easily with our new 8-slot motherboard complete with its own P.S.U. takes 8 plug-in Euro cards. Plug-in 8k RAM card now available.

All components can be bought separately and eleven packs can be purchased on an easy-to-buy scheme. See catalogue.

The P.C.B. alone is £50 + VAT plus £1 for packing and postage.

VAT rate is 8% on all kit components.

TRANSAM

TRANSAM COMPONENTS LTD.
12 CHAPEL STREET, LONDON, NW1
TEL: 402 8137

Next to Edgware Road Tube Station (Met. Line)
Triton Computer is the Trade Mark of
TRANSAM COMPONENTS LTD.

EXPANSION MOTHERBOARD . . £50

8K STATIC RAM BOARD £97

Full details available in our brand new 1979 computer products catalogue, so order your copy right now!

I am interested in the Triton

Name _____

Address (please print) _____

BARCLAYCARD, ACCESS, VISA & MASTER CHARGE ARE WELCOME. SEND YOUR CARD NUMBER WITH ORDER

To: TRANSAM COMPONENTS LTD., 12 CHAPEL STREET, NW1
Please send me the following

1 A copy of your latest catalogue I enclose 30p + S.A.E. 9 x 7

2 A copy of the Triton Manual. I enclose £5 + 70p P & P

3 A complete kit of parts for Triton Computer, £286 + VAT + £4 P & P

4 A Printed Circuit Board £50 + VAT & £1 P & P

TOTAL ENCLOSED £
Cheque, Money Order, etc.

● Circle No. 132

STAR DEVICES LIMITED.

Low cost ASCII Encoded Capacitive Touch Keyboard

now with improved sensitivity

£37-50

including V.A.T., post and packing. As supplied to many Government departments, schools, colleges and industry. Credit cards accepted.



The Standard Unit Offers:—

- ★ 7-bit parallel ASCII encoded output.
- ★ Positive and negative strobe edges.
- ★ All code outputs will drive 4 TTL loads.
- ★ LEDs to show code of selected character.
- ★ Audio feedback with volume/tone control.
- ★ Adjustable output character rate.
- ★ Touch-pad sensitivity control.
- ★ Auto-character sensitivity control.
- ★ Auto-character repeat.
- ★ Automatic scan facility.
- ★ Requires 5 volts at only 200mA.
- ★ Gold-plated edge connector provided.
- ★ Rugged low-profile case.
- ★ Assembled, tested and burnt-in.
- ★ 6-month guarantee.
- ★ All 128-character ASCII set.
- ★ Comprehensive Handbook supplied.

Low-cost optional extras include

- ★ Serial RS232
- ★ Baud rate and $\pm 12V$ generator
- ★ Parity bit
- ★ On-board 5V regulator
- ★ 30V open collector output

For further details please write to:—

**STAR DEVICES LTD.,
P.O. BOX 21,
NEWBURY,
BERKSHIRE.
0635-68020**

OEM and Custom design inquiries welcome.
Overseas distributors wanted.

● Circle No. 133

PLANNED DATA FURNITURE

Terminal
work stations
stands/wing tables

Assist your operators
Enhance your environment

We manufacture 30
different configurations
to suit most
requirements

Planned Data Furniture

Cheadle House
Mary Street
Cheadle
Cheshire SK8 1AH
Telephone: 061-428 6780
061-477 4890

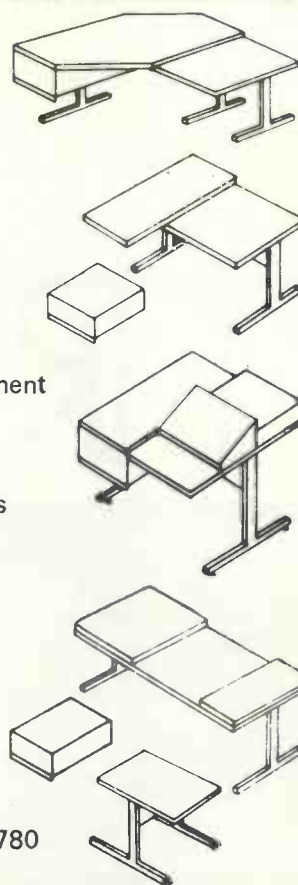

● Circle No. 134

£1 a day keeps your Apple in play

**16K Apple II . . . £985, or £26-98 for
60 months under our lease/purchase
facilities.**

Full range of commercial applications includes:

- Stock control
- Order processing
- Integrated accounting
- Incomplete record accounting
- Rental control
- Management reporting

Apple II's are affordable.

PADMEDE makes them useable.

PADMEDE COMPUTER SERVICES
The Tuns, High Street, Odiham,
Nr Basingstoke, Hants.
Tel: Odiham (025-671) 2434

● Circle No. 135

**ORDER BY POST
FROM THE WIDEST
RANGE OF
MICRO-COMPUTERS
IN BRITAIN...
OR VISIT OUR
STORES**

the **BYTE** SHOP Ltd

**A WIDE VARIETY OF
SYSTEMS AND BOOKS
'OFF THE SHELF'**

SOUTHWEST TECHNICAL PRODUCTS — FOR 6800 USERS



- MP-68CPU, 4K RAM £355
- 8K additional RAM £140
- 560KB twin disk system £1,400
- 160KB twin mini floppy system £860
- CT-64 V.D.U. upper/lower case, monitor £455
- PR-40 40-column printer £250
- Cassette interface £100
- GT-61 Graphics Terminal £105

A favourite with schools and colleges — low priced system that can grow.

Attractive low-priced software!

FOR THE PROFESSIONAL — CROMEMCO



- Z-2 system: fully assembled £575
- Z-2 system: Kit £395
- Disk system from £1,425
- CS-3 System 3, 32K, dual disk, expandable £4,175
- 4 MHz Single card computer £345
- Bytesaver board with PROM Programmer £135
- 16K PROM card £135
- Analogue interface £135
- Disk — BASIC, FORTRAN, ASSEMBLER, COBOL, etc. etc. each — £85

A rugged well-engineered system designed for hard use. Expandable to 512K, 21 Boards. Excellent software support CP/M AVAILABLE

PROCESSOR TECHNOLOGY SOL 20/16



- Computer system, 16K, V.D.U. etc. £1,785
- Additional memory, 16K dynamic £275
- Mini-floppy disk (first) £635
- High quality word processing printer from £1,800

A quality 8080 based system. Over 7,000 sold! Excellent word processing software available.

VISIT US AT: LONDON — 45 TOTTENHAM COURT ROAD. (01) 636 0647
NOTTINGHAM — 92A UPPER PARLIAMENT ST. 0602-40567
OPENING SHORTLY AT: BIRMINGHAM, LEEDS, MANCHESTER, GLASGOW.

Ohio Scientifics

Super board II

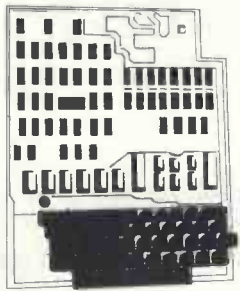

**4K user RAM
Full 8K basic
Built and tested**

£263.84

COMMODORE SYSTEMS

- PET 2001 £550
- PET MKII — Full Keyboard Plus Assmblr £675
- PET Disk Drives £740
- PET Printer £550
- Software from £3.00



NORTH STAR COMPUTER PRODUCTS



- NEW HORIZON-I dual density £1330
- Additional mini floppy £325
- Additional 16K static memory 4MHZ £315
- Printer interface £70
- Extended BASIC and DOS included in above
- Double Density Disks now available separately CP/M Horizon £130

NEW SYSTEMS

ITT 2020 EX STOCK

- 16K RAM integer basic £950
- 32K RAM integer basic £1150
- 48K RAM integer basic £1278
- DISK II floppy subsystem £450
- EXIDY SOCERER 32K £850
- \$100 expansion unit £250
- Disk Drive & Control Card £650
- NASCOM-I kit £197.50
- Buffer Board £25
- 32K RAM £200
- CompuColor II from £1,390

Astounding
Colour
Graphics

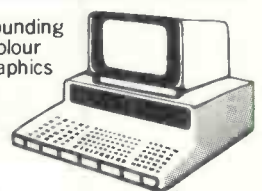

AN AMAZING SYSTEM BUT A COMPUTER IN ITS OWN RIGHT! DISK DRIVE BUILT IN!



MAIL ORDER

Please send me

.....

(if preferred, attach order on separate sheet to coupon)

Name

Address

.....

- I enclose cheque for £
- Please debit my Diners Club/ American Express/Access/Barclaycard Account no.

Please add 8% VAT to all items except books

The Byte Shop Ltd
426-428 Cranbrook Road, Gants Hill,
Ilford Essex. Tel: (01) 554 2177
All prices correct at time of going to Press

● Circle No. 136

TERMINALS FOR YOUR MICRO

RAIR



H1400 VDU Low Cost Video Terminal £550

● Circle No. 137

New low cost VDU featuring full cursor controls and 24x80 screen displaying high resolution upper case characters using a 5x7 dot matrix. Keyboard generates all 128 ASCII codes and unit interfaces through an RS232 interface at transmission rates up to 9600 baud. H1500 series features upper and lower case characters using 7x9 dot matrix integral numeric keypad, buffered editing, and printer port.



DECWRITERS Keyboard Printers From £850

● Circle No. 138

Industry standard dot matrix keyboard printers featuring 132 column upper and lower case printing on standard listing paper at printing speeds of continuous 30cps or 180cps. KSR and RO versions available with a wide range of optional features.



MICRODISC Minidisc Storage Terminal £950

● Circle No. 139

File oriented mass data storage minidisc terminal featuring random access by file name to 200,000 characters stored per diskette, interfacing through terminal and modem/CPU RS232 interfaces at up to 9600 baud. Powerful string search and editing options.



HYTERM Text Printer Terminals From £1900

● Circle No. 140

Range of microprocessor controlled 'daisy-wheel' terminals for text processing applications, printing at 45cps over 158 columns with a wide range of interchangeable type fonts. Many advanced features including IBM2741 compatibility, graphics capability, 'absolute' tabbing, and variable character/line spacing.



DATACASSETTE Cassette Storage Terminal £750

● Circle No. 141

Magnetic tape cassette unit storing 150,000 characters per cassette, communicating at up to 2400 baud through terminal and modem/CPU RS232 interfaces with full local and remote device control. ECMA, TI and NCR format compatibility options available.



LX100 SERIES Desk Top Printers From £1000

● Circle No. 142

New low cost range of desk top serial printers, printing over 80 or 132 columns at 100 or 180cps on standard listing paper using a 7x7 or 7x9 dot matrix. Options include VFU, second paper feed mechanism, 9x9 matrix with italic or expanded printing, buffered serial RS232 interface.

RAIR 30-32 Neal Street, London WC2H 9PS Telephone 01-836 4663

Publisher's Letter

AS THIS 108-page issue of *Practical Computing* bears witness, the micro-computer is very much alive and well in Britain.

There is a tremendous choice of low-cost computers on the market—see the Buyer's Guide on page 98—and better, smaller, more powerful processors and peripheral equipment are being announced regularly.

Much of the equipment is being designed in this country and there are many first-rate designers and technicians following in the trail-blazing footsteps of the late John Miller-Kirkpatrick and others.

Factories are being built to ensure there is enough production to meet the growth in demand. In our schools, the next generation is already being trained in the design and programming of micros. Whether enough resources are being put into this training is another question—see Education article on page 76.

With the equipment being developed, the production capacity being created, and future users being trained, one major question mark remains over the future applications of microcomputers. It concerns the key issue of the design of the thousands of applications crying-out for computerisation now that the price of the equipment is within everyone's reach.

As Dr Tim Keen put it succinctly at the *Practical Computing/ECORS* Managing with Micros conference, the purchaser of a drill is not looking primarily for drills, but for holes.

Similarly, the purchaser of a computer normally is not looking primarily for a computer but rather for solutions to his problems.

Applications will determine the success or failure of the microcomputer revolution. There will be a desperate need for people with experience in the real world of industry, government, commerce and education who can relate the potential of the market to the needs.

If you have such experience, and you keep up-to-date in the microprocessor field, you will be one of the people in great demand in the 1980s.

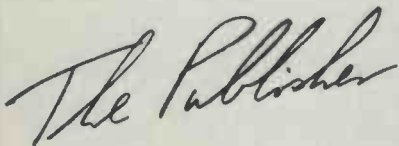

Our Feedback columns offer readers the opportunity of bringing their computing experience and problems to the attention of others, as well as to seek our advice or to make suggestions, which we are always happy to receive. Make sure you use Feedback—it is your chance to keep in touch.

Cheaper storage

I WAS interested in Bert Martin's article. I am thinking of buying a personal computer but the cost of disc storage horrifies me, and as a result I've been trying to find an acceptable method of using cassettes as a cheaper bulk storage medium. Martin's discussion of using both tracks of a stereo cassette deck makes a lot of sense and I would like to mention a few ideas of my own.

My main feeling is that any given point on the cassette should be "self-identifying" and so I propose that the cassette should be divided into a number of discrete blocks of data, and the address track should contain, perhaps among other things, an absolute block number, say, every 10 data blocks, and a block-start sentinel every block.

This information would be read by the recorder in FAST FORWARD/REWIND mode to identify the start of the required file. The first 10 blocks on the cassette would be reserved for the volume index, giving:

- a. filename
- b. file type (i.e. binary dump, data, program source)
- d. no. of blocks occupied.

for each file on the cassette.

It would be preferable if the size of the data blocks were to be standardised to aid transfer between differing systems. A block size of 267 bytes—why such an odd amount follows—would enable genuine double-buffering to be used by the Operating System, if required, without excessive storage outlay. Why 267 bytes? The block layout I propose would be:

1. Header		
a. Block length	2 bytes	
b. File number	2 "	
c. Block no. in file	2 "	
d. File type	1 "	
e. address for start of program dump	2 "	
2. Data	256 bytes	
3. Trailer		
a. checksum	1 bytes	
b. end-of-block marker	1 bytes	
Blocksize	267 bytes	

Most of the fields are self-explanatory. The block length would be of more use in program dump files where the whole 256-byte data capacity need not be required. In non-program dump files it, e (i.e.) would be hex zero H "00". The checksum in the trailer is formed from exclusive OR-ing each byte of the Header and Data but not the trailer, giving an eight-bit parity check.

Assuming that each data block is separated by 250 ms of blank tape to enable it to be over-written where necessary, the following table applies to one side of a C60 cassette:

Baud	No. blocks per side	Useful data*
2,400	1,578	401,664
1,200	888	224,768
600	473	118,528
300	244	59,904

*Useful data size is in bytes, with the 10 blocks for the volume index omitted.

This table compares favourably to Martin's value of 432K bytes. So, it seems, with effort a suitable cassette recorder can hold more data than most floppy disc units, although in spite of high-speed searching, the latency time, to use disc parlance, would be between

15 sec. and 65 sec. on average, depending on the re-wind speed for a cassette.

I would be most interested in hearing any views or comments. In the meantime, thanks for an excellent magazine.

Paul Wilson,
Hove,
E. Sussex.

Tape speed

BERT MARTIN seems unaware that in the audio type of cassette recorder, the tape is not in contact with the head during fast forward or rewind.

He seems unaware, too, that the speed of the tape past the (non-contacting) head of such recorders is varying continually from one end of the cassette to the other, as the diameter of the tape wound round the heel increases from minimum to maximum.

And he also seems unaware that digital cassette tape handlers have long been available, incorporating high-speed search, read, and write, with one track used for addressing. Three which have been advertised for micro-computer use are:

Phi-Deck: Triple I Co., P.O. Box 25308, Okla. City, OK 73125, U.S.A.
Digital Group, P.O. Box 6528, Denver, CO, 80206, U.S.A.

Model 3M3A: National Multiplex Corp., P.O. Box 288, So. Plainfield, NJ, 07080, U.S.A., or G. Ashby, 172 Ifield Road, London SW10 9AG.

No need to re-invent the wheel. Caution is advisable, however, with respect to life in service, as the Phillips cassette was never intended for high-speed use, and tape wear is at least proportional to speed, if not greater, and is the reason why floppy discs were invented.

Frank Chambers,
Westport,
Co. Mayo.

Good idea

MARTIN'S idea is a good one, but in the form suggested it would not work. Fast forward and fast re-wind speeds are not in the least constant, due to variations in the size of the roll of tape on the take-up side in the order of 5:1 or even more.

You could overcome this with a special machine but a better route might be to use numbered pulses as the identifying code. The number of pulses would be counted, and the differing interval between pulses ignored, up to a cut-off point which, if exceeded, would indicate pulse group ended, and machine would either stop, or continue search for correct pulse group.

Stopping is never instant and it takes a really good machine to do it quickly without beating tape but the lay-time could be allowed for easily at some expense in tape use. Not important. Glad to exchange ideas with Mr Martin, if he is interested.

James Woodruff,
Bradford-on-Avon,
Wiltshire.

Unrealistic

I HAVE read with interest the article by Bert Martin on a proposal for a new tape standard

(continued on page 27)

SPECIAL OFFER TO PRACTICAL COMPUTING READERS

SAVE £5 ON THE TEXAS INSTRUMENTS PROGRAMMER HEXIDECIMAL OCTAL AND DECIMAL CALCULATOR

PC is offering the TI Programmer at the special price of £44.95 (inc VAT), a saving of £5 on the manufacturer's price of £49.95.

Whether you are a professional programmer, computer hobbyist or electronic engineer involved in digital logic design, you cannot afford to miss out on this great offer.

Operating hexadecimal, octal and decimal, this TI Programmer lets you perform fast, accurate conversions and calculations in any of these number bases.

Number base conversions: Enter a number in base 8, 10 or 16. Then with a touch of a key, that number is quickly and accurately converted to either of the other number bases. The mode indicator on the LED display means you always know which number base you are operating in.

Number base calculations: The TI Programmer handles arithmetic computations in all three bases. Immediate answers to binary computer problems mean no more time spent with conversion tables and tedious long-hand methods, giving you more time for more important and interesting programming or trouble-shooting tasks.

Ideal for use with any size of computer

The TI Programmer can handle problems of any computer from an IBM 370 to a single-board microprocessor. It uses integer '2s complement' arithmetic in hexadecimal and octal bases just like a computer, with the capability of providing '1s complement' in these bases at the touch of a key.

For additional flexibility in minicomputer and microprocessor work, the TI Programmer has the logical functions: AND, OR, EXCLUSIVE OR and SHIFT. These functions operate bit by bit on numbers in hexadecimal and octal to give you the same capability as many computer instruction sets, and a unique tool for digital logic design.

THE TI PROGRAMMER SAVES YOU TIME WITH PROBLEMS LIKE THESE . . .

1. Q. If a block of available memory begins at address 0416_8 and ends at 1100_8 , how many bytes may be stored there?
A. 307_{10}
2. Q. You have data blocks stored between the following addresses. How many total bytes of data are stored?

	BLOCK 1	BLOCK 2	BLOCK 3
Beginning address	200	4A0	1000
Ending address	3FF	599	2A00

A. 7419_{10}
3. Q. What is 7_8 shifted 2 bits to the left?
A. 348

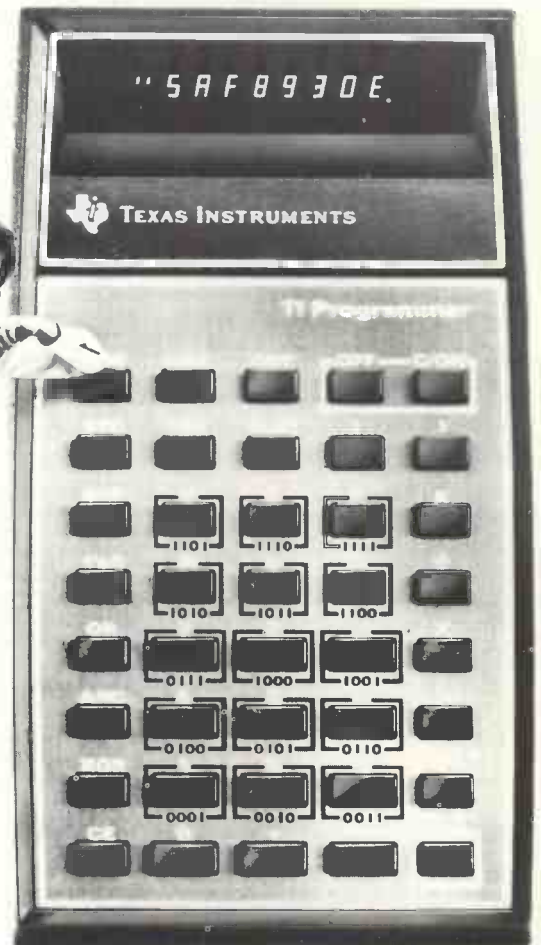

ORDER THE TI PROGRAMMER NOW

Send a cheque or postal order to the address below and ensure early delivery of your TI Programmer. Supplied complete with vinyl carrying case, fast-charge battery pack and AC adaptor/charger. Delivery within four weeks from receipt of order.

Enclosed is my cheque/postal order value for TI Programmers.

Name

Address

PRACTICAL COMPUTING
2 DUNCAN TERRACE LONDON N1 8BJ TEL 01-278 9517

(continued from page 25)

for the microprocessor user. I feel that his proposals are very unrealistic. For a start, his system requires the purchase of a stereo tape recorder at a price of £176 - £420, according to his figures.

In addition, there would be needed a coder/decoder board to handle the interface to the processor, say £20, and a re-written monitor to cope with the new system. The price for the entire changeover is now in the vicinity of the price of a 5¼ in. floppy which will offer much better performance.

I agree that a new look at tape standards is called for and I understand the the ACC is organising it. The main fault of the Kansas City/CUTS standard is its slow speed—300 baud—but that is frequently uprated to 1,200 or 2,400 baud with good reliability. I have heard of people running their cassette interfaces at 4,800 baud.

Perhaps what is needed is a minor re-definition of frequencies to allow a 4,800 baud rate, with improved performance. I notice on reading the specifications of some reasonably-priced and reasonable-quality monorecorders that they have rated input frequencies of 9,000 - 10,000 Hz. By using 4,800 baud we allow almost a 100 percent safety margin.

The CUTS system which uses a phased lock loop on the input to the processor allows for a substantial variation in record and playback speeds and if the basic oscillator for the drive and playback were crystal-controlled, compatibility would be assured between one machine and the next.

Next we should look at the dump or output format. Consider the Nascom under the Nasbug monitor—a rate of approx 25 characters per second is achieved. By using a different format as in the B.Bub, this rate is increased four times. With improved reliability in load and dump at high speeds, the hex redundancy of the slow rate could be abandoned. I would suggest that the dump block length should be shortened from 256 to either 128 or 56 bytes, and a system of headers decided upon which would allow a block search command in the monitor to search for a specified block title/reference number and then, on finding it, to begin load automatically.

Another function which could also be implemented is for the recorder to pick up the reference number of the previous block and increment it automatically on writing the header for the next block.

The hundreds of existing monotape recorders in daily use should not be overlooked in arriving at a new standard.

Rory O'Farrell,
Blessington,
Co. Wicklow.

Waiting list

I AM considering of buying an Ohio Scientific computer, the C3-S1/OEM, but I have not been able to lay hands on publications about this computer. This information I have from the manufacturer is not helping me any further. Is there somebody who has experience with this computer or a user group who can give me some additional information?

Do you plan to write/publish a review on this one, or do you know in which magazine such a review have been published? Please let me know.

Wishing you all the best with your superb magazine.

Barry Groenewegen,
Dundee.

● There was a long waiting and delivery list for the Ohio computer. Our name is on the list and we shall be reviewing it shortly.

Polarisation

DO I detect a growing polarisation between "serious" computer amateurs and "hobby-

ists"? More and more, one reads of people declaring that they have better things to do than to play games with their computers. Even magazine articles tend to make me feel guilty at spending £500-£1,000 on a computer to use it only as a toy.

Perhaps it would be opportune to see the matter in perspective. In the past, I have spent many hundreds of pounds on photography, purely as a hobby and with absolutely no serious intent. Similarly, I've spent hundreds of pounds on hi-fi merely to play badly-recorded pop music.

Again, the object was purely enjoyment and at no time did I feel guilty. Nor do I feel guilty at spending thousands on a motor car used solely for pleasure. The list is endless—the point, I hope, made. I look forward to the abolition of snobbery among hobby computer users. Let's be honest and admit it is fun and stop making me feel so damned guilty.

Brian Wall,
St. Helier,
Jersey.

Bank switching

I WAS surprised to read in the February Feedback that you do not understand what is meant by bank switching.

It is an old-established technique used for years in large mainframe machines. In essence, it means that an eight-bit micro can select any one of a number of boards, each containing 64K of memory. All, however, except one remain in the non-selected state unless activated at a select input point.

This could be done by addressing each board as a part peripheral, using an I/O instruction to select it perhaps by making its bi-directional bus driver chips go low impedance. Once selected, the board operates in the usual way.

Imagine 16 megabytes of memory on one eight-bit system. This technique will be available for those adopting the E78 bus standard. Further details from me.

Alan Secker,
Avant House,
9 Bridge Street,
Pinner, Middx.

● Alan sent us an interesting cutting from a November, 1977 issue of the specialist U.S. magazine *Electronic Design*, written by the director of R & D at a California company, Extensys, which deals in bank-switched memory extensions.

The principle is simple. The micro still addresses no more than 64KB directly but memory reference instructions go through a decode/select phase in software which identifies exactly which of several available blocks of 64KB is to be accessed.

That article mentioned two bank-switching add-ons available in the States for S-100 micros. Both are 64KB boards with bank-selection logic in PROM. IMSAI is one manufacturer; Extensys is the other. And the Extensys board is half the price, about \$1,750.

As far as we know neither is available in this country but watch this space.

Accounting

AS AN accountant I read with interest your article, Payroll and the Pet. Ease of use and reliability are the most important factors when choosing any business package and I was surprised that you dismiss as minor the fact that this payroll is difficult to use, since the more cumbersome the procedures the higher the probability that errors will occur.

Also under the PAYE system it is the employer's responsibility to ensure that proper deductions have been made and he could find himself liable to the Inland Revenue for any under-deductions which occur as a result of errors.

You state that the program has been written by an accountant, as if this is a

recommendation of its reliability. I would agree that any company computerising its accounting procedures should consult its accountant, but the user should not expect him to be an expert in programming. The analogy I would use is: "Would any user accept a computer system which has been passed for audit purposes by a programmer?"

The Pet is ideal as a low-cost computer for handling accounting procedures, especially now that discs will soon be available, but only if the quality of the software can match the capabilities of the machine.

Ethne McClean
Manchester.

Apple group

WE ARE hoping to set up the U.K. Apple users' group under the chairmanship of Dr. Tim Keen. It is hoped that this group will allow for the interchange of programs and information between Apple users, and the solution of any problems which may arise, both with hardware and software.

As the organising body of the users' group we hope to provide all members with a regular newsletter, probably bi-monthly, and to keep them informed of new developments.

Before the group can be organised fully, it would help us if Apple users and dealers (and the new ITT 2020 owners) would contact our office to let us know who they are; we can then send them more information and arrange a conference between all interested parties sometime in the early Summer.

Judith Fletcher
Keen Computers Ltd.,
5 The Poultry,
Nottingham.

Helpful aid

AS MANY of your readers have a Pet 2001 I suspect that they have been trying the Cars game, as shown in December, 1978 issue, Page 45, without success.

I suggest that the following lines are modified or added so that they can enjoy this fascinating game.

```

10 DIM M$ (22), QS (18), JS (9), X (22), Y (22),
    Z (22), G (5), J (22), L (10)
230 FOR I = 1 TO 5
231 READ G (I)
232 NEXT I
250 FOR I = 1 TO 10
251 READ L (I)
252 NEXT I
270 FOR I = 1 TO 22
271 READ J (I)
272 NEXT I
300 FOR I = 1 TO 22
301 READ X (I)
302 NEXT I
320 FOR I = 1 TO 22
321 READ Y (I)
322 NEXT I
340 FOR I = 1 TO 22
341 READ Z (I)
342 NEXT I
1030 READ MS (I)
1050 PRINT "POINT"; I; MS (I)
    
```

A. Bond,
Liverpool.

Vacation work

IT WOULD be appreciated if you would do me a favour by printing the following in your Feedback column.

Sponsorship or vocational work opportunity is required for a first-year undergraduate student on a BSc honours degree sandwich course in electrical and electronic engineering.

The undergraduate would like to get into the hardware side of computers/microcomputers.

J. R. Bridges
7 Eltham Park Gardens,
London S.E.9.

(continued on page 29)

Pet program supermarket

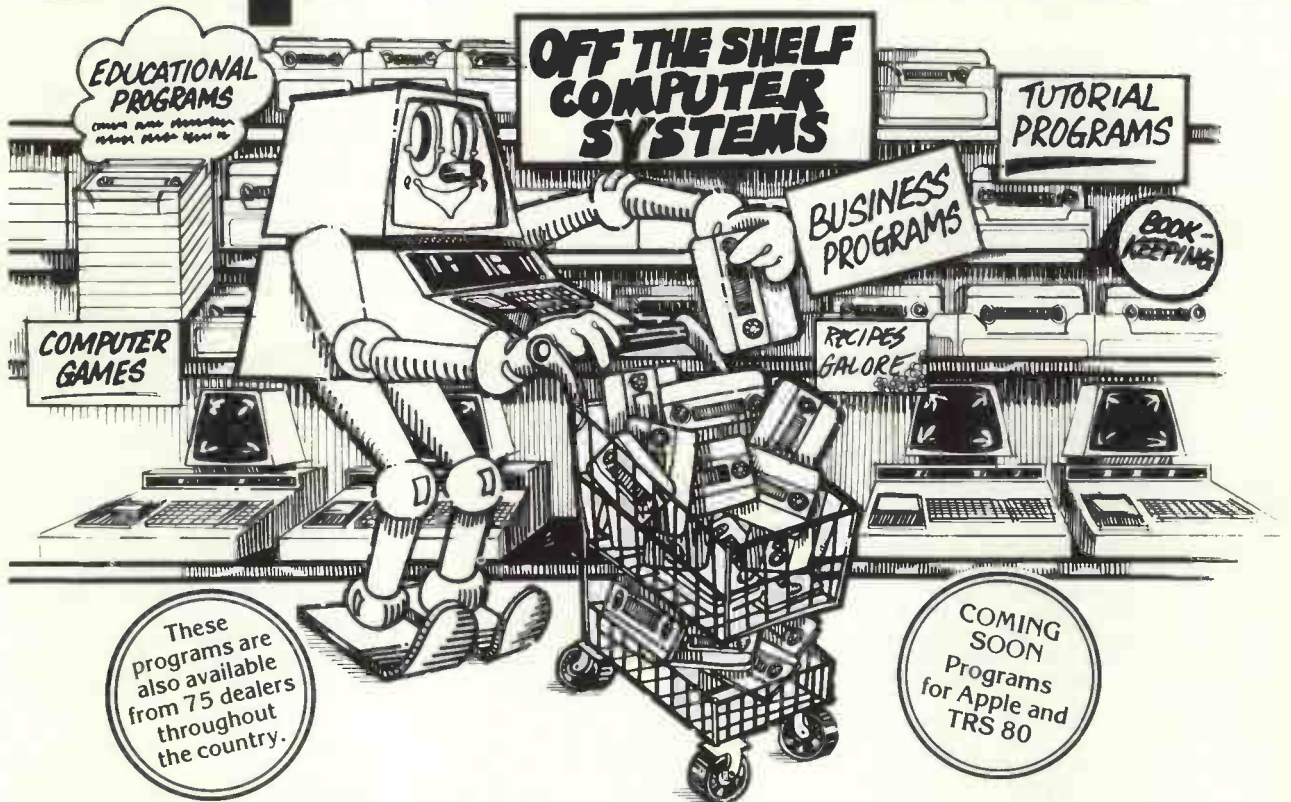

At last a whole menu of programs to feed your PET at prices which knock the bottom out of traditional software costs.

Our 16 page catalogue lists nearly 130 programs from £3 to £50 (including VAT). These cover Business Routines, Programming Aids to help you make the most of your PET and some super games to play with it. Here are just a few examples.

TRY THESE PROGRAMS AT YOUR NEAREST PET DEALER

Addressbook £6	Linear Programming £8	Sales Analysis £10
6502 Assembler/Editor £25	Linear Regression £5	Statistics £7
Backgammon £8	Line Renummer £15	Stock Control £12
Bridge Challenger £10	Microchess £14	Super Startrek £8
Civil War £7.50	Music £10	Tax 78/79 £8
Data File Handler £12	Payroll £25	VAT Pack £17.50
Discounted Cashflow £8	Percentage Costing £49.50	
Graphics Package £12	Pet Basic Tutorial £15	

All our prices include VAT.

For further details of these and the other 110 programs in our free catalogue, complete the coupon or call us today. We also accept credit card orders over the telephone.

Petsoft Specialists in personal computer programs,

5-6 Vicarage Road, Edgbaston, Birmingham B15 3ES.
Tel: 021-454 5348 Telex: 339396.

Petsoft A member of the **ACT** Computer Group.
PET is the trade mark of Commodore.

To **Petsoft**

My name is _____

My PET lives at: _____

5-6 Vicarage Rd., Edgbaston, Birmingham B15 3ES.
MY PET NEEDS FEEDING. Please rush me a copy of your free 16 page catalogue of PET programs without obligation.

(continued from page 27)

Musical Pet

I HAVE become more and more interested in microcomputers, especially the Pet, since reading your magazine. As I was looking through your new column on the Pet in the February issue I was wondering if the Pet could be modified to teach children and adults to play the piano, or any other musical instrument which has a keyboard.

I wondered if it is possible to link the processor to the keyboard, thus linking the computer's memory as well. In this way the computer could be programmed to recognise the different notes and display them on a VDU and thus put them in order and display the tune being made. It could be programmed also to teach. I would be grateful if you could tell me if this is feasible.

Tyrone Cooper,
Cannock, Staffs.

● There are several ways in which the Pet can be used for musical computer applications. At the most basic level, the computer memory could be used to store note sequences; with a sound generator add-on, it could be used to play back these notes. In this way, the Pet can easily be used to create and edit musical sequences. It can, of course, also be used to generate mathematically-based sequences of notes for less conventional music.

Alphabetic game

G Saini of 50 Whitmore Road, Birmingham B10 0NP has an alphabetic Mastermind-type game. The system picks a random sequence of letters—you can specify how many, up to 26—and you have to guess what they are. It's neat but we are a little over-burdened with guessing games of this kind at the moment. Mr. Saini, however, is keen to get together with any owner of a graphics system in his area with a view to adding colour graphics to the program. Any takers?

Not difficult

IN Vincent Tseng's article on the Nascom-1, it gave the impression that the kit was difficult to build. I am 14 and previously had experience only in building small transistor radios and the like.

It took me a weekend to build my Nascom-1 but I did not find it difficult or tedious. I did not have any real problems with it and do not want people to be put off as it's not as difficult as it sounds.

Stuart Erskine,
Wyken,
Coventry.

Cost-effective

REGARDING Mr. Page's letter about stock control on a small business system, may I make the following comments which I hope he and others interested in this field may find of use?

Any cassette system will be very slow and cumbersome—much worse, in fact, than any manual record-card-based stock recording system. In my book this completely rules out any system using tape cassettes as the recording medium.

For a small number of items it may be possible on a 32K computer to hold up to 100 item details within memory and save them on cassette at the end of the updating session. The problem is that any sort of program fault or power failure will result in the loss of the latest data.

The only reliable choice is to use a floppy disc system. Even here many minifloppies will store only 90K per disc and do not allow multi-disc files. So even then it would be difficult to store details of 2,000 items, with, say, 128 bytes per record (250K bytes).

One of the choices which would be effective

and is only just outside the £2,000 figure quoted would be to use high-density minifloppies from Micropolis attached to a 32K Sorcerer. This system would be difficult to beat on grounds of cost effectiveness.

J. M. Collier,
Keighley,
W. Yorkshire.

Freezing

WE ARE interested in a device which will freeze the digital readout from an ADDS system 70 microcomputer on to a TV monitor. The computer will output up to 25 lines of 80 alphanumeric characters on to a TV monitor. We want a memory device which will hold this image until a switch is pressed.

Do you know of any suppliers please?

J. L. Farthing,
Microact,
5-6 Vicarage Road,
Edgbaston,
Birmingham.

● No, but perhaps our readers do.

Far and wide

WE HAVE received a chirpy newsletter from Gonzalo Velez-Juan, who runs the Cuatro Computer Club in Caracas, Venezuela. CCC has been operating since November and if Gonzalo's two-pager is any criterion, it is a cheerfully enthusiastic outfit.

● Enthusiasts interested in the area can reach Gonzalo and CCC at Avenue Los Pinos Edf. Airoa No. 5, La Florida, Caracas.

In the other direction, Singapore is another place with evidence of micro enthusiasm. The Singapore Microcomputer Society held its inaugural meeting towards the end of last year and signed 100 or so members, one of whom has been writing to us complimenting *Practical Computing* for not being a U.S. home computer magazine.

You can reach the Singapore Micro Society via its president, Jack Page, at Page-Asia Associates, 279-M Selegie Complex, Singapore 7.

For engineers

I FIND your articles deal mainly with commercial applications, together with some games. It seems to me that in view of Government support for microprocessors for industry, a major growth area in computing will be in machine and process controllers, particularly those for the smaller industry.

May I suggest that you devote a small part of your space to the problems likely to face engineers trying to use analogue signals in a microcomputer for general industrial control, which often requires proportional signals.

The main problems facing new microprocessor users in this area would seem to be the "hand-shaking" technique for multiplexing analogue input and putput signals.

E. John Skenett,
Clifton, Bristol.

● Thanks for the idea. We shall look into it.

New approach

I LOOK forward to the program examples and I admit, the games each month. With a bit of luck, most of them are up and running by midnight on the day that *Practical Computing* arrives.

But can you please do something about the "l"s and the "i"s in the program listings. Without the aid of a strong magnifying glass I find them indistinguishable. I know we can work out the difference from the logic, but this becomes very tiresome after a time.

Best of luck with your new magazine. I find it a welcome addition to the literature. What a pleasure it is to find so many people

"doing computing" simply because they like it.

Peter Russell,
Headley, Newbury.

● We have adopted a new approach to program listing which will resolve the problem.

Coming

I HAVE ordered a Science of Cambridge Mk 14 microprocessor. Could you please send me any tips or program routines for the Mk 14?

S. Robinson,
Markefield, Leicestershire.

● Watch for next month's issue, when we shall be reviewing the Mk14.

Packages

I HAVE been looking for some time for a software program suitable for incomplete records accounting but have, so far, failed to find any suitable for microcomputers. Do you have any information on the subject?

Fordhams,
54, Fleet Street,
London EC4.

● See this issue for details of accounting packages.

Machine state

I AM writing for help concerning a micro-computer application I have thought out but I am unable to realise because of insufficient knowledge on hardware.

The purpose served by this application is to indicate the state of a machine (phase of operation) or the activities in a factory.

I thought of doing this, using a single-line display (of about 20 illuminating characters of about 8 x 4 cm in size) connected to a micro with an alphanumeric keyboard.

The role of the microcomputer is to accept strings of alphanumeric characters into variable names, store the contents of these variables in EPROM or something equivalent for this application, and output the contents of these variables at a later stage by the depression of a "print" key and the variable name on the keyboard.

The variables should be capable of containing about 20 characters and remain unaltered in memory even after the system is switched-off. The ability to re-assign values to these variables provides the freedom of applying the system to various machines.

The system should work on power supplied by commercially-available batteries and the display should be positioned easily at least three metres away from the micro-keyboard system.

I would be most grateful if you could kindly send me any information which would help me put together such a system or provide me with names of manufacturers who already produce such hardware.

G. Vamialis,
Neas Elvetias 60
Byron T.T.517
Athens, Greece

● The application sounds simple for a micro-computer. You seem to want to call-up a series of messages, with each message related to a specific control key on the keyboard. If that is the case, you don't need a micro at all—any electronics buff should be able to hard-wire such a system for you without great difficulty.

A microprocessor would be more appropriate if your system needed to detect the state of the machine and the time to make its own decision about what should be displaced. That will obviously require a degree of programming, since choice is involved and it will also involve sensors on the machinery itself. Either way the task will not be too difficult, and it should be possible to accomplish it at minimal expense. □

Unmistakable.



APPLE II

Try a comparison test.

Look at the features of Apple II. It still has 8 I/O ports, high and low resolution graphics, a mini assembler, A/D paddles, fantastic Basic, Disks and the best documentation in the business.

Intelligent interface cards.

They're neat. The high speed serial card, printer card and communication card all have elegant documentation. There is also easy-to-use software that mean taking B.C.D. from instrumentation, connecting your favourite printer or talking to a time-sharing computer, is child's play. Apple makes things easy.

Plus:

* Say hello to Apple and let Apple talk back. Explore voice recognition, computer voice recognition and computer voice production. You can now have large vocabularies.

- * Perhaps you'd like to be reminded that it is a special day or would like to chase overdue accounts. Apple clock card is simply the best. It is the most advanced on any personal computer.
- * Draw graphics with the light pen.
- * Make chips for your own software with the Eprom burner. Apple naturally has spare sockets for this.
- * Make interfaces with the prototyping boards.
- * Use Apple's incredible 'programmers aid' hardware option. More thought and care from Apple for you to use.

And there's more yet more to come from our friends at Apple. Phone Personal Computers' distributors and get to know them. They're busy, successful, highly qualified professionals and the best in the business.

Personal Computers Limited

Personal Computers Limited 194-200 Bishopsgate, London EC2M 4NR. Tel. 01-283 3391

Tim Keen, Keen Computers Ltd., Nottingham. Tel. 0602 583254
Stanton Smith, Microsolve, Edgware. Tel. 01-951 0218
Trevor Brownan, Crystal Electronics, Torquay. Tel. 0803 22699
Trevor Williams, Padmede Ltd, Odiham, Nr. Basingstoke. Tel. 02-5671 2434
Bruce Everiss, Micro Digital Ltd., Liverpool. Tel. 051-236 0707
Claude Cowan, Cambridge Computer Store. Tel. 0223 68155
George Sinclair, G.A.T.E. Microsystems, Dundee. Tel. 0382 74390

Peter McNaughton, Perthshire. Tel. 07388 8267
Robin Woods, Isher-Woods, Luton. Tel. 0582 424851
Tom Piercy, Topmark Computers, Huntingdon. Tel. 0480 212563
Steve Cooper, Creative Vision, Leeds. Tel. 0532 458444
John Page, P.I.P.S. Computer Services, Newcastle. Tel. 0632-482 359
Alan Wood, Apple Corner, London. Tel. 01-580 5304

Midlands program exchange

WOLVERHAMPTON is opening its doors to users of small systems to promote and exchange programming experience and programs. If you would like some useful tips on software, or just to talk to people who, like you are using microcomputers to help your business, why not pay a visit?

The organisation is called the Central Program Exchange (CPE) and is completely independent of any manufacturer, being financed jointly by members' subscriptions and the Council for Educational Technology. It has a membership of 72 and holds a library of more than 200 programs in Basic, Fortran and Algol.

Membership normally is £25 per year but individual members can obtain CPE services for £10 per year. That entitles members to a catalogue, newsletter and up to 10 CPE programs as listings or paper tapes.

Details of membership are available from Dr. G. Beech, Central Program Exchange, Department of Computing and Mathematical Sciences, The Polytechnic, Wolverhampton, WV1 1LY.

Digital panel prints as added bonus

DIGITAL EQUIPMENT has announced the latest addition to the PDP-11 series, the Data-system 150, described as a "compact table-top computer", and costing £5,625 for the basic configuration.

It uses dual-drive floppy discs, which store up to 512,000 characters, an LSI-11 central processor, the new VT100 terminal with free-standing keyboard, and a 180

cps dot matrix printer. It has memory sizes of 32K or 60K bytes, and runs under CTS-300 (Commercial Transaction System) operating software, which means it is ideal for payroll, accounts payable and receivable, general ledger and inventory in DIBOL, the Digital high-level language.

As an added bonus, Digital is offering silkscreen panel prints designed by Corita Kent,

one of the most celebrated American serigraph artists. The prints are optional but if you want to brighten your office, a set of three will cost £65—one for the wall and two for the end of each cabinet.

Alternative sets of two duplicate prints from each series of designs can be bought for £49. They are for mounting on Digital low-profile system cabinets.



Above, the concept; below, the artist.



Business decisions package

A BUSINESS decisions package for programmable calculators has been developed by Texas Instruments for its TI58/59 machines.

The library, in the form of a solid state software plug-in module, contains a range of programs to make tasks involved in business decisions much easier, and it permits managers to have instant access to processes handled usually by the computer.

The library also contains several programs which can be incorporated easily in specific routines for a particular company, without the need to produce programs involving detailed analysis of certain techniques such as demand forecasting or economic ordering.

There are 11 programs in the business decisions package which cover module checking, long-term financing, debt financing, investment evaluation, project planning and budgeting, break-even analysis facility capacity, economic re-ordering and production runs re-order timing, demand forecasting, and assembly line balancing.

There is also a 96-page manual containing full information on calculations of short-term financing requirements and facility scheduling.

The library costs £32 including VAT, covering the module, program reference cards, a quick reference guide, the library manual and a wallet.

Helpful newsletter for VIP users

IN THE WILDS of Pennsylvania there's a cheaply-produced but fact-packed independent newsletter for users of RCA VIP microcomputers. It's called *The VIPER* and it is from a small publishing house which makes a habit of publishing cheap but fact-packed newsletters—Aresco Inc also produces *The PET Paper* and is planning similar operations for Apple, Sorcerer and Tandy users, among others.

So if you have a micro with 1802 or COSMAC or RCA on it somewhere, read on. The issue we have seen has 26 pages. It includes the third and final part of a text editor project on the VIP, adding program-controlled tape I/O—with plenty of useful information about playing with the relevant parts of the operating system.

There is the announcement of a VIP software library, with a LIFE game for a start—\$10

for a tape documentation.

There is a neat piece of opportunism. Someone discovered that a \$60 video game from Radio Shack is really an 1802 system with keypad, 512 bytes of CMOS RAM, video interface and power supply; it needs an operating system and cassette to make it work, and that is promised for future issues. You won't get a \$ VIP here, by the way—Radio Shack

was expected to sell out of them.

There's more. VIPER costs \$25 outside the States and they will accept Visa (which means Barclaycard) or Mastercard (Access).

We are looking at the possibility of doing a European edition; let us know what you think. Meanwhile, Aresco can be reached at PO Box 43, Audubon, PA 19407 U.S.A. ☐

Nim game

THERE are two curious errors in the Nim game we printed in March. Both seem to have been caused somewhere along the line between computer and printer because the game ran satisfactorily when we tested it.

Here are the modifications

- add a line as follows:
1120 PRINT "YOU WIN. DO YOU WANT ANOTHER GAME?"
- delete 1840 and add:
1830 IF D(3) = 1 THEN 1860
- change 3490 to read:
3490 GOTO 1120

Incidentally, credit is due to Roger Hargrave, of Crawley, who developed the original flow-chart.

Reference card from Strumech

THE LATEST Strumech catalogue contains several new microprocessor-associated products, together with some very reasonable prices.

For 35p Strumech offers a 6800 reference card, packed

full of invaluable information.

Two examples of new products include the Smoke Signal Broadcasting BFD disc system which now offers Strubal, a new structural Basic language, and it will shortly offer Fortran as well. SDOS, the new operating system for MSI6800 systems, utilises FD-8 and HD-8R disc systems. FD-8 and MSI 6800 can be updated to SDOS.

The 6800 reference card

(please enclose SAE), and the catalogue are available from Strumech, Portland Hse., Coppice Side, Brownhills, Walsall, WS7 7EX, West Midlands. ☐

Nascom-1

OUR REVIEW of single-board computers omitted the fact that the Nascom-1 has an on-board cpu clock, a video modulator, a cassette modem (or Teletype) and 2K bytes of RAM, of which 1K is dedicated for video interface. There is also a NASBUG 1K 2708 Eprom monitor.

The Nascom-1 is manufactured by Nascom Microcomputers Ltd and is available from 21 distributors worldwide, of which Lynx Electronics is one. The price of the kit is now £165 plus VAT. ☐

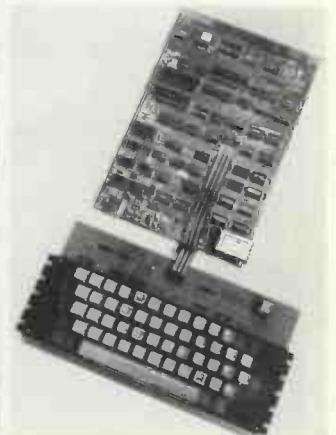

New version

THOSE whose appetites were whetted by our extracts from the book *Computer Programs that Work* will be pleased to hear it has been re-printed with minor changes. The book, which costs £2.40, has three main sections—mathematics, science and games.

All programs are written in Basic and a paper tape version of all programs is available for £6.

If you have difficulty obtaining a copy, write to Sigma Technical Press, 23 Dippons Mill Close, Tettenhall, Wolverhampton, WV6 8HH, West Midlands.

Sigma is also offering to publish any programs you may have for a modest sum of £25. They will help to make up similar books. ☐

ELECTROVALUE

FOR A GOOD DEAL BETTER THAN MOST
ESPECIALLY WHEN IT COMES TO

nm

Nascom Microcomputers

- ★ At new reduced prices
- ★ Appointed national distributors
- ★ Full ranges of available Nascom items for prompt delivery
- ★ Backed by Electrovalue service

PRICE LIST AND INFORMATION

Gladly sent on request. Your name will be fed to our computer for you to be sent future information automatically

**FREE FOR THE ASKING
ELECTROVALUE
CATALOGUE 9**

Latest 120 page catalogue — ICs, Semi-conductors, Onto-devices. Components, Hardware, Connectors Tools, etc.

ELECTROVALUE LTD

Dept. PC 479, 28 St Judes Rd,
Englefield Green, Egham,
Surrey TW10 0HB.

Phone Egham (389 from London:
STD 0784-3) 3603; Telex 264475.
Northern Branch (Personal shoppers only) 680 Burnage Lane,
Burnage, Manchester M19 1NA Phone
(061) 432 4945.

● Circle No. 145

Dot matrix

HEWLETT-PACKARD has a new stand-alone dot matrix which couples a "proven display with a microprocessor-based controller to provide an easy-to-read display with very low power requirements and easy interfacing".

The new system, designated the HDSP-24XX Series, is claimed to reduce engineering development costs and time because the microprocessor controller is pre-programmed with routines which accept, decode and display standard ASCII data.

The 5 volt operation, standard low-power schottky TTL-compatible inputs and four separate display formatting modes permit easy interface to a keyboard or microprocessor based system.

The series is available now and a 32-character single-line display model costs £231.15. □

Data aid

AN IMMEDIATE need for a copy of the complete Motorola Microcomputer Data Library can be satisfied by Cramer Microsystems of Sunbury-on-Thames.

The publications include most of the technical data sheets on all Motorola microprocessors, memories and associated devices, up to the latest M6081 single-chip microcomputers. □

Intel users' group

AN INTEL microprocessor development system users' group has been formed in the U.K. It is entirely independent and has been formed for the benefit of users of the Intel MDS.

Membership is free but is restricted loosely to those organisations or individuals who either own, hire, use or intend to use either Intel Series-I or Series-II configurations.

No such group has existed until now, although Intel reports that it is to improve its system of distributing new product information to its MDS system users.

The group will attempt to keep users up-to-date with new Intel products and will provide a platform for users' software and

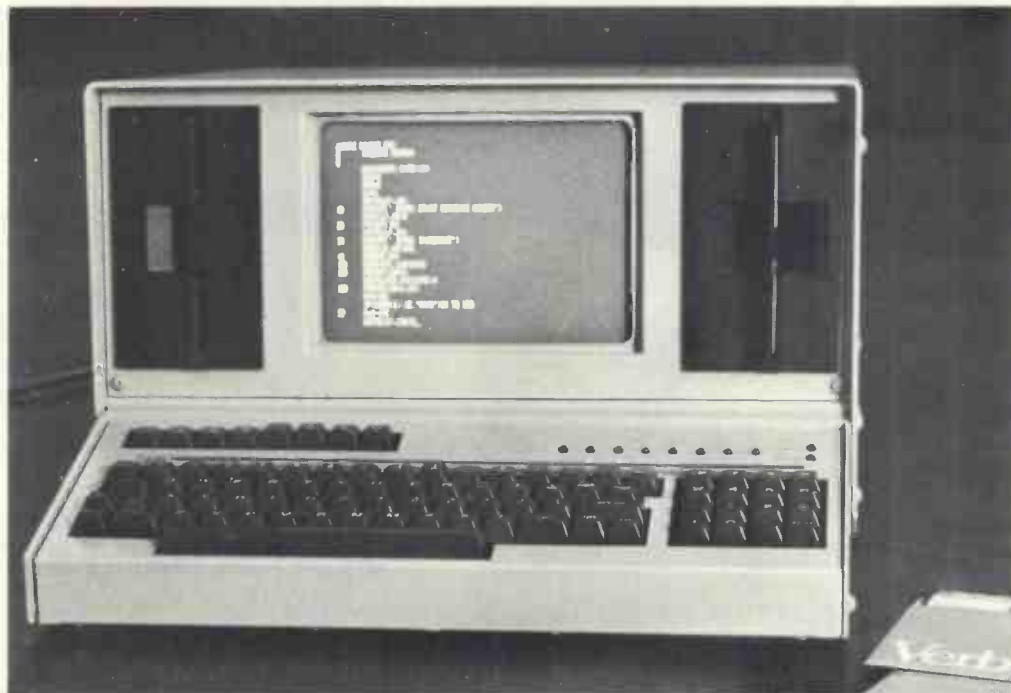

PT 208

Abacus selling new low-cost range

A NEW RANGE of low-cost, high-performance microcomputers is being sold in the U.K. by Abacus Computers for Texas Electronic Instruments.

Abacus, appointed worldwide distributor for the range in November, has already sold two systems to China. Two

popular models in the range are the PT 208, which has a 9 in. CRT and twin SA400 drives. It is priced at £4,190 and has a delivery time of seven days.

The PT 212 has a 15 in. CRT and two Shugart SA800 disc drives. It sells for £4,826 and has a delivery time of between 14 and 21 days.

All the machines feature as standard a CPU with 32K RAM, expandable to 64K, 2K PROM, three parallel and three serial I/O ports, and a floppy disc controller which allows a mixture of large and small disc drives.

The TEI range will understand a variety of languages including Cobol, Fortran, Pascal, Super Basic, RPG II and APL. The machines are fully-compatible with the operating system CP/M and its full range of utility programs.

Abacus is looking for high-street dealers to market the range, so that it will be available off-the-shelf. So far, four dealers have been named—Kingston Computers, of Hull; Dams Office Equipment, of Liverpool; Shulbrook Microservices of Twickenham; and Stratheden of the Isle of Man, who will be the sole distributor there and in Ireland. □

Moving fast at Gants Hill

THE Byte Shop in Gants Hill, Essex, installed a Cromemco System three, which it set up and displayed so that interested customers could see it in action. In the first few weeks of this year, it sold three systems.

Gerard Talaucher, the assistant manager, says that the system is proving to be a "very popular" line. Costing around £4,000, it is ideal for the small business systems user—see *Practical Computing*, February, 1979—but with disc drives, I/O cards and other peripherals, the cost can rise to £8,000 or more.

The system on display in the shop was sold to a school and the other two to small businesses. Talaucher attributed the interest of schools and computer bureaux to its speed and attractive cost-efficiency.

Many enquiries have been received from small businesses—for example, a manufacturer who was considering buying a Cromemco to enable closer co-operation between his accountant and stock controller. □



Keen Computers, Spread Their Wings

Hardware

You've heard about the new **attaché**—we stock it. We are the Midlands distributors of the sophisticated **attaché** business computer from America: This is a purpose designed business computer supplied complete with monitor, dual 8" floppy disks and printer. We also stock the **Apple II**—the best micro for its price available in the U.K.

Attache	£5,895	Printer card	£110	Axiom micro printer	£350
Apple II 16K	£985	Communications card	£110	Axiom printer/plotter	£699
16K Memory	£160	Decwriter II	£1,050	Memory upgrade kit now available for Apple II, ITT and Tandy	
Disk & controller	£425	Centronics 779	£850		
Applesoft ROM	£110				

Software

We have a full range of software for the Apple II, available on disk or cassette:

Incomplete Records Accounting	Matrix Inversion
Addressing & Mailing program	Information Retrieval
Word Processor	Co-resident assembler
Chequebook	Regression
Shape-create	Standard deviation
Variance	Correlation
Data Testing	Distribution

Personal Software MICROCHESS for the Apple II computer, Tandy, and the Pet.

Keen Computers Ltd,
5 The Poultry, (off Market Sq)
Nottingham
Tele: Nottm
583254/5/6



North Star Horizon in two models

NORTH STAR looks like being one of the survivors in the personal computer market and one reason is that it started not with a computer but with a floppy disc subsystem for the S100 bus.

It was one of the first companies to supply minifloppy discs in quantity. Its disc system was supplied with a disc operating system and extended Basic and as they have now been in use for two years they are among the most reliable personal computer software available. About 10,000 of the disc systems have been sold to date.

Immediately following the floppy disc subsystem, North Star released a hardware floating point board for use with its extended Basic. It claims that this can speed execution of a Basic program by as much as a factor of 10 where extensive mathematical calculations are performed.

Logical step

Having established itself as a reliable supplier of S100 subsystems, North Star took the logical step of introducing its own complete system, the Horizon. It is available in two models, the Horizon-1 with a single minifloppy drive and the Horizon-2 with two drives. The storage capacity of each drive is 90K bytes. Double density has now been introduced in the U.K.

Horizon is an S100 bus computer. The

motherboard has slots for up to 12 S100 circuit boards. The motherboard contains one or two serial I/O ports and one parallel I/O port. The processor board uses a Z80A and operates at 4MHz which is twice the speed of an 8080. The complete system is packaged very neatly and

by Martin Collins

includes a more than adequate power supply and a cooling fan.

Our review system was a Horizon-2 supplied by Equinox Computer Systems Ltd. The system had four 8K memory boards made by Industrial Micro Systems, two serial ports, one set to run at 4,800 baud and one at 300 baud, and two

parallel ports, one for input and one for output.

Eight of the 12 slots on the motherboard were fixed with edge connectors and six of them were used, one by the processor card, one by the disc controller and four by the memory boards.

Equinox supplies the IMS memory boards because they are static and this, it claims, makes them more reliable. North Star manufactures a 16K dynamic memory board.

We tested the system using an ACT-1A VDU which has a "simple" RS232 interface requiring only pins 2, 3 and 7 to be used on a standard 25-pin connector.

Confusing advice

The Horizon manual and some additional instructions supplied by Equinox gave confusing advice on how to connect the terminal to the system. The Horizon interface is full RS232, which enables it to be used with modems. To use it with a simple terminal such as the ACT-1A, pins 4-5 and 6-8-20 should be wired together at the Horizon end of the interface cable.

The initial problem we had in wiring the system was caused by the rather scrappy documentation we received with the system. On software we had the following documents:

(continued on next page)

Prices

Horizon with one disc drive, U.K. power supply, eight edge-connectors and serial port, fully assembled and tested.

16K RAM £1,328

24K RAM £1,483

32K RAM £1,638

Horizon with two disc drives, U.K. power supply, eight edge-connectors and serial port, fully assembled and tested.

16K RAM £1,668

24K RAM £1,823

32K RAM £1,978

Extra serial port £45; parallel port £45; hardware floating-point board £220.

(continued from previous page)

North Star Disc Operating System Version 2 Release 3
North Star Basic—Version 6
North Star Monitor—Version 1
Release 4 Software Changes
Notes on system start up from Equinox

All the problems we had in wiring the system resulted from finding the most up-to-date part of the documentation. The manuals are not designed for the first-time user; the Basic manual, for example, is little more than a brief specification of the language as implemented on the system.

Since our initial evaluation we have received revised documentation for the system. This consists of two manuals:

Horizon Computer System Double Density HRZ-D
North Star System Software Manual SOFT-DOC

The first was concerned mainly with assembling a Horizon system from a kit. It provides much information about the hardware but would probably be of use only to anyone capable of or interested in locating and curing hardware faults.

Improvement

The second was a greatly-enhanced version of the software documents we received with the system. It was certainly an improvement to have all the relevant information in a single manual. The manual includes four main sections:

Getting started, which tells you what to do when the system is unpacked.
The operating system, which is concerned

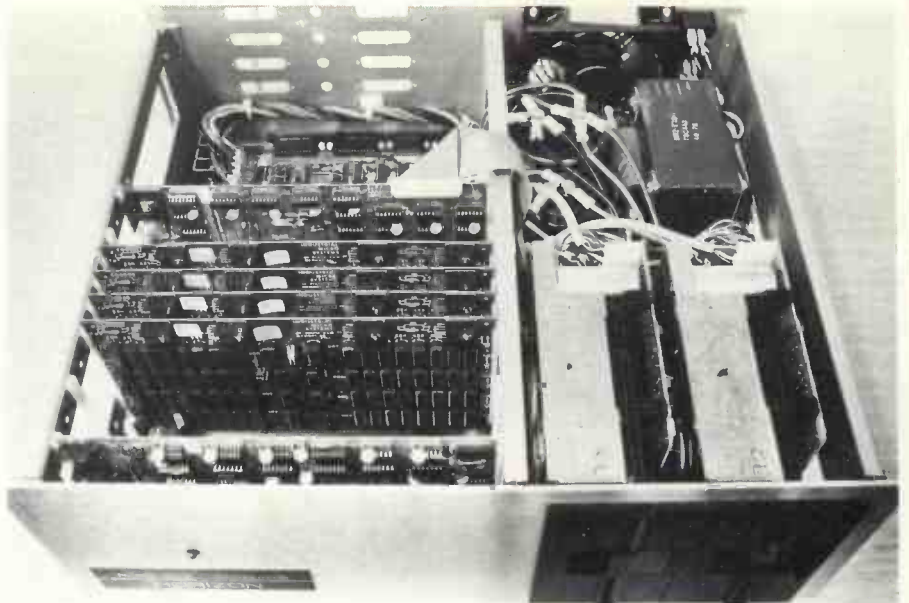

largely with the filing system and its associated utility programs.

The monitor, a program which allows the user to examine and amend memory locations. It may be necessary to use it for "personalising" a system, e.g., amending it to suit a particular set of terminal characteristics, but for most users it will be only of academic interest.

Basic; this forms the major part of the manual and has been written to serve both as an introduction for the novice and as a reference manual for the experienced user. At first sight it seems to meet both those requirements successfully. It also includes as an appendix a number of well-documented sample programs.

Overall, the manuals were some of the

best we have seen for a micro system. They are not the easiest for use by a novice, so if you are starting from scratch you may need to read a simple introduction to computers before using these manuals.

Once we had overcome the problems in linking our VDU to the Horizon we had no further problems in getting the system up and working. There are only two external controls on the system, an on/off switch and a re-set switch.

Loading

Powering the system on or pressing the re-set switch causes the operating system to be loaded from the floppy disc. As we had no printer interfaced, the first prompt was PR to which N is input;* which is the operating system prompt, is then displayed.

The operating system is not the most sophisticated available on a micro system but it includes all the necessary basic commands for setting-up and maintaining disc files. One drawback to the system is that files must occupy physically contiguous disc space.

This has two advantages, however; the first is that the file size must be specified when the file is created and it cannot be extended subsequently. The second is that space left by a deleted file cannot be re-used until the disc has been compacted. The operating system manual supplied with the system is brief and is certainly not written for the beginner. It did, however, contain all the necessary information. It includes a section on "personalising your system" to match it to specific terminal and memory requirements.

No limit

The Basic system is entered by typing GO BASIC. The standard Basic supplied by North Star has 8-digit precision but there are versions available with 2, 4, 6, 10, 12 or 14 digits. Three versions are

Your Horizon dealers

LONDON

Eurocalc Ltd,
55-56 High Holborn, London WC1.
(01-405-3113).

Lion House Microcomputers,
227 Tottenham Court Road, London W1.
(01-580-7383).

Sumlock Bondain Ltd,
15 Clerkenwell Close, London EC1R 0AA.
(01-253-2447).

ESSEX

Micro Software Systems Ltd,
Stanhope House, High Street, Stanford-le-Hope
(03756-41991/2).

HUNTS

Micropower,
26 High Street, Great Paxton, Huntingdon
PE19 4RF.
(0480-213785).

KENT

Microtek Computer Services,
50 Chislehurst Road, Orplington, Kent.
(66-26803).
Tor Business Systems,
83 Timberbank, Vigo Village, Meopham, Kent.
(0732-822956).

SURREY

Radix 2 Technology Ltd,
92 Wimbledon Hill Road, Wimbledon, SW19.
(01-946-8887).

MIDDLESEX

Jacobs Computer Systems Ltd,
36 Bengeworth Road, Harrow, Middlesex
HA1 3SE.
(01-908-1134).

HAMPSHIRE

Claissie-Allen Computing,
5 Upper High Street, Winchester.
(0962-69368).

DORSET

Micro Systems Specialists,
Market Place, Sturminster, Newton, Dorset.
DT10 1BB.
(0258-72946).

SOUTH WALES

Micro Media Systems,
12 Clarence Place, Newport, Gwent.
(0633-50528).

LANCASHIRE & NORTH WALES

Cortex Computer Centre,
25-35 Edge Lane, Liverpool.
(051-263-5783).

CAMBRIDGESHIRE

Wisbech Computer Services Ltd,
10 Market Street, Wisbech.
(0945-64146).

LINCOLNSHIRE

Loveden Computer Services,
167 Bartowby High Road, Grantham.
(0476-72000).

supplied with the system to operate in 16, 24 and 32K.

This is a good extended Basic, with all the normal features available. One unusual capability is that there is no limit on the number of dimensions which an array may have. Strings may be dimensioned up to the limit of memory and substrings may be defined either by \$(u,m) where n and m are the first and last characters or using the LEFT\$, RIGHT\$ and to insert commas, suppress zeroes and so on.

The file-handling allows data to be read or written sequentially or randomly. The sequential file access requires the length of any strings written to be known; there is no equivalent to the ASCII sequential format available on many Basic systems. Random access to files is done by specifying a file pointer which is a byte address within the file.

Limited expansion

North Star has designed the Horizon as a complete system and for that reason system expansion is fairly limited. There is a new version now available in the U.K. with double-density discs giving 180K bytes per drive. A third drive can be added to any system and would be housed outside the cabinet.

Any S100-compatible peripherals can

be used with the system. With the double-density system, four drives are supported by one new controller.

With North Star Basic, the memory can be expanded to 56K. North Star will be releasing a PASCAL compiler shortly which will require a minimum of 48K. As an alternative to the North Star software, the system can also be supplied with the CP/M operating system which provides Cobol, Fortran and CBASIC.

Packages

Equinox is developing packages for the system in conjunction with a number of software houses. The first to be released will be an estate agents' package and a payroll package. There is a large amount of application software available for the system in the States, and Equinox is assessing a number of packages for distribution in this country. They include:

- Stock Control
- Plant Maintenance and Control
- Medical Package
- Word Processor
- Incomplete Record Accounting

Although Equinox does not undertake software development for specific customers, it is able to recommend software houses with experience in program development for the Horizon.

Conclusions

- The Horizon is a well-made system with fully-proven software.
- The availability of a floating-point hardware board to work with the Basic and the fact that the system is based on the Z80A operating at 4MHz make the system suited particularly to applications requiring extensive mathematical calculations.
- Before buying a system with mini-floppy discs, you should make sure that they have sufficient storage capacity for your requirements. Even with the new double-density discs, the capacity is considerably less than a normal full-size floppy.
- The availability of the North Star Operating System and CP/M gives a wide choice of programming languages and application software.
- The revised documentation we received was of a high standard. The first-time user would require a simpler manual, perhaps one of the introduction to micro books, before understanding the manuals. □

Practical Computing evaluation

	Yes/No NA	1	2	3	4	5		Yes/No N/A	1	2	3	4	5
Ease of construction (where applicable)	NA						Assembly language	Y					
Quality of documentation			✓				Basic language						✓
Dealer support/maintenance				✓			Other languages	Y					
Can handle 32K of memory	Y						Compatibility with other systems				✓		
Quality of video monitor (consider resolution and screen size)	—						Reputation of manufacturer						✓
SS-50 Bus	N						Appearance						✓
S-100 Bus	Y						Portability				✓		
Sockets for chips	Y						No. of software applications packages available					✓	
Numeric, calculator-type pad on keyboard	—						Hobby use						✓
Large amount of removable memory, randomly accessible	Y						Business use				✓		
Cassette tape recorder capability: Own	—						Educational use						✓
Built-in recorder	—						Suitability for: Commercial applications				✓		
Floppy disc capability	Y						Home applications						✓
Communications capability (can talk to other computers)	Y						Educational applications						✓
Speed of instruction cycle	4MHz						Ability to add printer(s)	Y					
Ease of expansion					✓		Ability to add discs	Y					
Low power consumption	?						Ability to add other manufacturers' plug-in memory	Y					

Ratings
 1 = poor; 2 = fair; 3 = average; 4 = good; 5 = excellent.
 N/A = not applicable.

ROBIN BRADBEER spent a few hours with Steve Wozniak, inventor of Apple computers, some weeks ago. Today, Apple is one of the success stories of the microcomputer business, it is rich and independent, and its problems are those of over-demand, a rather pleasant position for a company.

Two years ago Apple was two guys and an idea in a garage. If you want to tune-in to commercial success in the home computer world, read on.

The interview is in two parts. We begin with Steve's story about the birth of Apple. Next month the questions are about ideas, developments, trends and opinions.

THE NO COMPU

the single-card system. He went for the more traditional route most people were taking, which was slot-based and bus-structured—the CPU was just one of the cards, the memory was another.

I was still making hand-wired breadboards. Then this friend of mine, Steve Jobs, said why don't we make a few boards like this and sell them? Our original idea was to build about 50 blank boards, take them to the club, hold them up in the air and say "Is anybody interested in buying one of these boards?"

First big order

I sold my HP calculator and Steve sold his van and we used the money to hire a printed circuit artist to lay-out the boards. While we were thinking about making the first boards, Steve received a telephone call to place a \$25,000 order for 50 complete computers, fully built. We were planning to sell only blank boards but these were orders for boards which were fully-stocked with the ICs.

The order was from the local Byte Shop. By arranging credit properly we were able to get all the components we needed to build the boards. Then we went and sold them on the date for which the purchase order was made out and were able to pay our creditors. It was a very neat operation. We were able to turn the whole thing around very fast, in less than a month. That put us in business—in a garage.

We decided to call the company Apple. Steve was working at a place called Apple Orchard, or something like that, in Oregon. It's a really great name—it's one of those names which sticks.

We used the garage for a year and we didn't move too many computers, about 200; but it was the name which sold, and we started advertising in the national magazines.

Fast development

Of course, all this is on the side, and I'm still working at HP. I got a formal legal release from HP to allow me to do this sort of thing.

Stores were springing-up all over the country and the Apple was a different product from the others around. It wasn't a completely finished product like the Apple 2—it was just a board with a microprocessor, 8K of memory and a video terminal.

I think we were the first people to use the 4K dynamic RAMs which were coming in at the time, so the Apple I

LONG before Apple began, I was working at Hewlett-Packard, designing calculators. Round about that time in 1974, I became interested in video games. Atari and other companies were beginning to put their video games into coffee bars, bars, restaurants and similar places. So I thought I'd try to design my own version of them—I was one of those guys who was always playing around with these things as my hobby. This led on to a couple of other projects, chess displays and things like that.

That naturally led to the video terminal. There's not much more to learn to build one of those after you've built a chess display. I looked through the data books and found the appropriate shift registers. My trademark is designing small, tight circuits—this helps to solve many problems later on—by keeping all the logic very close together. I was able to design and build a very simple video terminal.

Terminal start

Of course, all this was taking place while I was still with HP—and none of it was for HP. About that time, the Altair computer had just been introduced. My video terminal was almost finished and a friend mentioned that some people locally were about to start a club for those interested.

Microprocessors I didn't know the first thing about; video terminals I did. So I became one of the founders of a club which consisted initially of 40 people sitting in a garage with the rain pouring outside.

Working on chips

We were sitting discussing microprocessors, which micro had this feature and which had that. Honestly, I just didn't know what was going on—I'd never been into this hobby world at all; what I was doing was working on calculator chips which were a totally different style of microprocessor. I felt a trifle out of it but I attended a few meetings and began to get to know what was going on.

Then I heard that Chuck Peddle was to sell micros over the counter for around \$20 at an electronics trade fair. In the HP lab there were two of us really interested in this type of thing and we went there to buy ourselves some microprocessors.

Now the only micro with which I'd

really had any experience up to that time was the 6800. In fact, I had designed on paper a complete system based around the 6800, but Chuck was selling the 6502.

When we went through the instruction set, found out everything it had and everything it didn't have, we were left with a question—What do you do with a computer?

I realised that Basic was the language which was becoming more and more popular, so I tried to write a Basic compiler with a few things of my own. A friend wrote an Algol program which ran on a HP2000 mini and simulated the 6502 chip, so I was able to write the guts of the Basic compiler. It eventually became our Integer Basic.

Making it work

The next step was to design a system. There was this video terminal on my desk, so I put the microprocessor on it with enough circuitry to make it work as a system. I interfaced it to some RAMs, put a ROM monitor on it and powered up the thing. It started to interact with the keyboard and I could get it to go to various memory locations; it was a very basic first-level system.

There were still a couple of bugs; for example, I forgot to clear the decimal mode on the 6502 which everyone does when they first run it. I took my compiler which was working on the simulator and loaded it in and that sat in the RAM.

Now that I had my system I had to do some more software. So I had to work out more and more of the Basic. While this was going on every few weeks the club would meet and I'd go down to show off the latest.

I got good at typing-in hex; I had no development aids, no cassette recorder, no floppy disc, no assemblers, so it was all done on paper and hand-coded.

I was pass 1, I was pass 2, I was the linking loader, I was the text editor, I was everything: I became very good at working out the op. codes in my head and putting it all down on paper.

At about that time I contracted asthma or something. This rather helped me to develop things because I couldn't sleep; I would get up in the middle of the night and work.

The friend I mentioned before had built his own system as well. My idea was

N-KIT TER

used a lot less power and cost much less.

With Apple I beginning to make an impression, we needed a cassette interface. That was our second product; it was a really fast development. We couldn't do it so fast now—it took about a month.

March, 1976 was when we formed the partnership and started selling the computers. In June, I started on the Apple II, which was designed to do all the things Apple I could do, but better. I was also very interested in colour video.

It proved almost impossible to design a simple colour circuit for the Apple I, so I decided to start completely with a new system and, in fact, everything turned out cleaner. The whole thing was still built as a single stand-alone system.

I had designed a game for Atari called *Breakout*, so I wrote another version of it with graphics commands. It took about a day to write and a day to debug and two weeks of modifying. I couldn't believe how easy it was to write in Basic compared to assembly language.

We took this to Atlantic City in September for our first Computer Fair, PC 76.

'Beautiful'

We came across this Advent projector television and thought it would be really neat if we could try the Apple II on the colour projector TV to see what it would look like. We hooked the Apple II to this projector and threw it up on the screen and it looked just beautiful.

The guy in the booth said "I want one of those". Remember, it was still a hand-wired breadboard at that stage. That told us something. Surrounded by all the fantastic video and computer equipment, this guy wanted ours.

Things were going really well. We were coming up with high-resolution graphics and the 16K RAM was coming along. In fact, we started using 16K RAMs on the Apple I. I think we might have been the first people to sell 16K RAMs for a computer as an extension to the Apple I.

Cost-effective

The Apple II was probably the first small computer to use 16K RAMs as well. We feel we've kept up with the RAM technology all the way through, and as we were one of the few to use this technology, it worked out to be very cost-effective in the end.

The final board design for the Apple II was done around November, 1976. It appeared eventually as a product about April, 1977. We didn't have a case design-



Steve Wozniak

ed. Carl Helmers of *Byte* magazine got interested at this time. He was keen on having a small computer you could take home and plug in, rather like a piece of hi-fi equipment.

Straight lines

We took the hand-drawn work and digitised it into the computer. The lines came out perfectly straight and the board looks better because the lines are all straight.

Meanwhile, the garage was filling with racks and test equipment and there was no way that we were going to be able to do the Apple II in there. There just weren't enough of us involved. We might have gone under; we could just not have met the demand.

News of the product had started getting out. For example, I was going to Los Angeles to demonstrate Apple I to a group there and I forgot the transformers or something like that. All I had with me was an Apple II which I could demonstrate. So I showed that. It was still in breadboard form but there were about a dozen people at that meeting and eight of them ordered Apple IIs.

We knew we had an exciting product and just knew we could sell it, so we started to look for other people.

Steve met the guy who is now our marketing manager; he worked for Intel. Then we hired another guy who was a friend of the marketing manager and he

became president. He had been running a division of National Semi, where he had a lot of responsibility. His job was to keep an eye on the dollars and cents.

He's still our president. As for me, I was still working for HP until the first quarter of 1977. We hired two more engineers, including one guy from Atari who had a superb analogue background. We're now adding about 10 people a week still. We have about 110 employees now; we also place a lot of contracts outside. So there are now many people working just on Apple—the total could be nearer 200 full-time if you take the other companies into account.

More natural

We started slowly and that was a good thing. We had some really good exposure in the Press. We took on a good advertising agency—that's one of the first things we did—and the thing just took off from there.

Apple was beginning to be accepted, it was a more natural sort of product and it wasn't considered a brand new product any more—remember that at that time there were many companies coming out with really neat-looking products which might well be advertised in perhaps five issues of a magazine and then disappear.

So we finally made it to that point where our momentum was going to carry us. We knew we were going to survive unless something very drastic happened. □



These pages represent an independent collection of news and views for owners of the Commodore Pet.

The principal focus is Mike Lake, of the Independent Pet Users' Group (IPUG).

If you wish to contact *Pet Corner*, write to him or send articles or ideas to us directly.

Offerings this month include items on the use of a 40-column printer, the Teletype 43, increasing competition in the supply of floppy discs, and information on how to play Pet music.

News about the Pet Users' Group

RESPONSE to the formation of the Independent Pet User's Group has been very good indeed, according to secretary Mike Lake. "Membership has almost trebled, with nearly 150 members already and growing daily. Many new members have enquired if there is anyone else in the group tackling the same problems as themselves. I hope the newsletter and the address list will put them in touch."

Printer: the PR40

To keep up with the addressing for the group, Mike invested in an SWTP PR40 40-column printer to use with his Pet. He reports that he is "very pleased" with results so far, though he was concerned initially about its speed.

Driving the user port from Basic programs was very slow indeed and each line was taking several seconds to appear. A 256-byte machine-code routine, sitting protected in the top of the memory, has cured that and now the PR40 is delivering about 75 lines per minute.

Mike notes one or two things about this printer which are not so good, though. It is certainly in an attractive enough case, and it is complete with a plug for the Pet user port. Inside the case is a roll of 3 $\frac{1}{4}$ in. paper. It has caused some problems because it is impossible to change the paper roll without loosening the 18 self-tapping screws which hold the case together. SWTP must have designed the case around a printer which had the roll of paper on it, unless no-one is expected to use more than one roll.

The problem, however, is fairly easy to cure. Two neat hacksaw cuts leave the case intact and allow access to the paper roll.

There's another problem. Where do you get 3 $\frac{1}{4}$ in. paper? SWTP wants £1 per roll for it and also charges £4 for a new ribbon—five times the cost of an equivalent typewriter ribbon. Does any reader know of a source of cheap consumables?

That apart, Mike's printer has worked

well. The machine code routine for driving it at full speed is available to group members at £2.50 (£5 for non-members). Incidentally, this routine can be used to drive almost any parallel printer from the user port—hardware interfaces become necessary for using the IEEE port.

The Teletype 43

WE HAVE seen several Pets with the Teletype 43. One user Mike encountered was concerned that he could not get lower-case when driving it from a program—in local mode the lower-case was fine.

To get the lower-case output from a program, you have to fudge the output data slightly.

Here is one way it can be done:

```
10 FOR A = 1 TO LEN (A$)
20 X = ASC (MID$(A$,A,1))
30 IF X < 219 AND X > 192 THEN X = X - 96
40 B$ = B$ + CHR$(X)
50 NEXT A
60 A$ = B$
70 B$ = ""
```

This converts a string (A\$) containing a mixture of upper- and lower-case characters into a form suitable for the Teletype 43. If anyone can think of a better way, let us know.

This still leaves a problem with the Teletype 43. When doing program listings it appears to suppress cursor and other control characters—not even a blank is left in their place. Has anyone found a solution to this problem?

The cheapest printer yet

THE January edition of *Practical Electronics* (no relation) carries the first of two articles on building a 40-column electrostatic printer—total cost about £90. If anyone makes one, please let us know how it goes with Pet.

Floppy discs

COMPETITION to supply floppy discs for the Pet seems to be hotting-up. Commodore has demonstrated a single drive in the U.S., though it has a somewhat limited software. It is hoping to produce a dual mini-floppy system sometime be-

fore the summer. Meanwhile, we count at least three contenders here.

Midland Micronics offers the MM3. This system we have already highlighted in *Practical Computing*. It sits across the top of the Pet VDU and thus forms an integral part of the machine. This twin mini-floppy system offers 80K bytes of storage; a full 8K program can be loaded in two or three seconds. Midland Micronics had some difficulties with the software for the drives but this has been sorted out now.

The system is offered at £1,300 for the dual-drive version and £870 for a single drive.

John Chew, of Kingston Computers in Hull, tells us his company will be importing a dual-drive system from the States early this year. The price will be about £860. This again offers 80KB storage on each diskette.

Kingston Computers is to lend Mike Lake a system for evaluation, so he should be able to report on it for us.

Lotus Sound also has a dual-drive mini-floppy system and if anyone cares to get in touch the company will supply full details. We noted this one last month.

Memory

HERE is another area where competition is getting stronger. Lotus Sound now has 16KB for £298, £364 for 24K, and £425 for 32K. The prices seem to be the lowest around at the moment.

Incidentally, some people have asked why buy an extra 32K of memory when only 24K can be recognised by Basic? The extra 8K can be used for machine-code routines such as the PR40 driver and the IPUG Renumberer (see later). These routines are then protected from being over-written by Basic and can be called by the `USR` or `SYS` commands. Routines for controlling the I/O ports are particularly suitable for this area.

Be warned, though, if you are thinking of buying a floppy disc. Don't rush to buy 32KB of extra memory and expect to use it all for programs; some may be required by the floppy disc itself, any-

(continued on next page)

(continued from previous page)

thing up to 12K of mixed RAM and ROM in some cases.

IPUG Offers

FROM time to time, the group will be offering software for sale; proceeds will go to IPUG to help defray expenses. At the moment there are two routines on offer:

- the PR40 (parallel printer) driver already mentioned;
- the IPUG Renumberer, which Mike Lake describes modestly as “the bee’s knees of renumberers”. It really works, and will catch THENs, GOTOs, ON.....GOTOs GOSUBs. It is in machine code and needs 962 bytes of memory to itself; it will take around four seconds to renumber a very large program. The program can then be saved or executed to test whether the renumbered version works.

Both routines cost £2.50 to members—not bad at all. Non-members must pay £5, so with membership at £2.50 per annum, it’s cheaper to join and then buy.

Word lists

ANYONE interested in word processing could do worse than taking a leaf from Microsoft’s book. The list of Basic keywords is stored at locations CO92 through C18F (you will need to get round PEEK protect to look at this area—try using a disassembler) and the way it is stored is interesting.

The last character of each word has bit 7 set. This means that there is no need to store a space between words. ASCII characters normally do not have this bit set, so as soon as it is detected, you know you are on the last letter of a word. If this idea could be used when storing lists of words, a considerable saving on storage space can be made.

Note production

As promised in the last article, here are full details from Mike Lake of how to make Pet play music—this is also an example of the PR40 printout:

To produce a note you must:

- 1) POKE 59467,16
- 2) POKE 59466,D (SEE COLUMN D)
- 3) POKE 59464,C (SEE COLUMN C)

To hear the note you must connect up the user port like this:

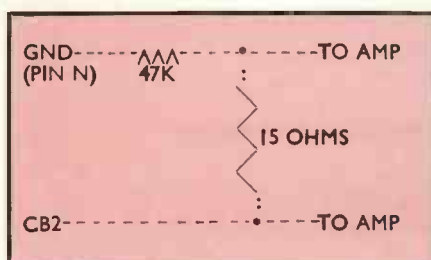

NOTE	FREQUENCY	D	C
G	3136	15	18
F#	2960	15	19
F	2794	15	20
E	2637	15	22
E•	2489	15	23
D	2359	15	25
C#	2217	15	26
C	2093	15	28
B	1976	15	30
B•	1865	15	32
A	1760	15	34
G#	1661	15	36
G	1568	15	38
F#	1480	15	40
F	1397	15	43
E	1319	15	45
E•	1245	15	48
D	1175	15	51
C#	1109	15	54
C	1047	15	58

NOTE	FREQUENCY	D	C
B	988	15	61
B•	932	15	65
A	880	15	69
G#	831	15	73
G	784	15	78
F#	740	15	82
F	698	15	87
E	659	15	93
E•	622	15	98
D	587	15	104
C#	554	15	111
C	523	15	117
B	494	15	125
B•	466	15	132
A	440	15	140
G#	415	15	148
G	392	15	157
F#	370	15	167
F	349	15	177
E	330	15	188

NOTE	FREQUENCY	D	C
E•	311	15	199
D	294	15	211
C#	277	15	223
C	262	15	237
B	247	15	251

Education

NICK GREEN of Commodore—who, as we discovered by accident at a Christmas party, shares the same *alma mater* as our managing editor—has been in touch expressing concern about the lack of educational facilities for Pet users. Some dealers have also expressed the same concern to Mike Lake and made this suggestion.

IPUG would be willing to organise a weekend course—Friday evening to Sunday afternoon—at a “good hotel” close to the M1 in Nottinghamshire. The course would have experienced tutors from the group, and the cost would be about £40 per head, including full board.

IPUG is a voluntary organisation and does not wish to make a profit; neither can it afford to set up such a course without knowing what the demand would be. If anyone is interested, get in touch with Mike as soon as possible. Numbers would have to be limited to give everyone a fair chance for hands-on experience with Pets and peripherals—they would be loaned by local dealers.

To join IPUG only costs £2.50: just drop a line (and a cheque) to: Mike Lake, 9 Littleover Lane, Derby. □

SET FIRE TO THIS MAGAZINE

and you will be annoyed in a few months’ time.

You will then need to refer to the information in this issue.

To keep your copies in good condition and easy for access we have designed a special binder. In blue, it has PRACTICAL COMPUTING stamped in silver-style lettering on the spine.

Each binder holds 12 copies comfortably and the binding system allows each copy to be held firmly in place.

The price is only £2.95, which includes post and packaging.

Send a cheque now to:

Practical Computing
2 Duncan Terrace
London
N1 8BJ

YOU should know about computers, related equipment, software, services and supplies.

YOU should visit COMPUTERMARKET '79

ENTER THE COMPETITION
TO WIN YOUR OWN
PET
Personal Computer System
with software and worth £700+
at
COMPUTERMARKET

13, 14, 15
March
Albany Hotel
Bothwell Street
GLASGOW
G2

20, 21, 22
March
Albany Hotel
(by New Street
Stn) Smallbrook,
Queensway
BIRMINGHAM

27, 28, 29
March
New Century
Hall (by Victoria
Stn) Corporation
Street
MANCHESTER

3, 4, 5
April
Bloomsbury
Centre Hotel
(near Russell
Square Tube)
Coram Street
LONDON
WC1

See computers for big business, small business, home, hobby . . . See software for mainframes, minis, micros . . . See computers for Engineers, Shopkeepers, Solicitors . . . See peripherals for big systems, small systems, distributed systems . . . See computers for Accounts, Graphics, Stock Control . . . See magazines for news, information, jobs . . . See computers for hundreds of £, Thousands of £, tens of thousands of £ . . . See competitions for education, entertainment, prizes . . . See computers for data processing, word processing, work processing . . .

Computermarket is open to business people over eighteen years of age from 9 to 5.30 daily.

For **FREE** admission, complete this coupon and present it at Computermarket Reception. For more tickets or further information contact the Computermarket Organisers at 46 New Cavendish Street, London W1M 7LG. Telephone 01-935 4996.

Name..... Job Function.....

Company.....

Address..... Postcode.....

Pilot arrives

A COPY of Pilot for the Tandy arrived on our desks this month from Optronics in Twickenham, which is one of the first dealers in the U.K. to offer the language.

Pilot is one of the best languages available for writing computer-assisted instruction programs. Its facilities were described in great detail in our November, 1978 issue.

TRS-80 Pilot is Jeff Lasman's version. Programs are written as simulated dialogues in English and can be entered and executed very quickly.

There are four main functions—T to type text; A to receive an answer; M for match keyword; and J for jump. It took us about half-an-hour to master the main parts of the language. It is certainly one of the simplest ways of organising questions, conversations, riddles and general interaction with a computer we have come across.

Programs 50p

ANOTHER goodie to arrive in the U.K. is Library 100, a collection of 100 programs to run on the Tandy. The collection will be selling here for £46.95, less than 50p a program.

Bringing the collection to the U.K. is A. J. Harding of Bexhill-on-Sea, Sussex (0424) 220391. The programs are split into five categories—finance, education, graphics home and games.

We are waiting for our own preview copy but glancing through the contents list it seems that the finance section is definitely American, covering items like real estate capital investment, salvage value, and amortisation schedule. It also includes simple and compound interest and terms of loans.

The list of education programs is what one might expect—addition, subtraction, algebra and so on. There are, however, some intriguing items like inventors and inventions, authors and books, capitals and countries, and presidents and orders.

For the home there are 15 programs with interesting titles like bartender, babysitter,

drunkometer, Christmas list and expense account.

Finally, on the games front there are 29 assorted games like Star Trek, quizzes, and Wheel of Fortune.

Printer interface

WE HAVE just connected a TRS 232 printer interface to link our Tandy with a Diablo printer.

We discovered the interface on a trip to the U.S. where we paid about £30 for it. It is understood that Whitehead Micro Systems of Kenilworth is planning to bring them to the U.K., although there are probably some dealers already offering them here. Doubtless they will let us know.

It is a simple task to set-up the printer interface. It works with any RS-232-compatible printer including Diablo 1620, Teletype 43 and TI Silent.

The interface is a piece of hardware about the size of a cigarette packet which you connect between the power supply and the Tandy. No tools are required. It is a simple plug-to-plug connection.

Some software on cassette is provided to handle the output formatting. That's all there is to it.

Software fix

YOU KNOW that when you touch one letter on the Tandy keyboard you sometimes get two on the screen. Well, Tandy has introduced a software fix for it.

At the moment, it is available only on disc but Tandy plans to issue a tape later. For those readers who want to jump the queue, A. J. Harding has given us a disassembled listing for the routine.

It was disassembled from a 48K machine,



starting at 65481. For 16K the starting address is 32713, and for 32K it is 49097.

FFC9	AF	XOR	A
FFCA	110A00	LD	DE,00A
FFCD	CD0B00	CALL	000B
FFD0	19	ADD	HL,DE
FFD1	221640	LD	(4016),HL
FFD4	CD611B	CALL	1B61
FFD7	CF191A	JP	1A19
FFDA	21 36 40	LD	HL,4036
FFDD	010138	LD	BC, 3801
FFE0	1600	LD	D,00
FFE2	0A	LD	A, (BC)
FFE3	5F	LD	E,A
FFE4	AE	XOR	(HL)
FFE5	73	LD	(HL),E
FFE6	A3	AND	E
FFE7	2008	JR	NZ,FFF1
FFE9	14	INC	D
FFE8	2C	INC	L
FFEB	CB01	RLC	C
FFED	F2E2FF	JP	P,FFE2
FFF0	C9	RET	
FFF1	5F	LD	E,A
FFF2	C5	PUSH	BC
FFF3	01DC05	LD	BC,05DC
FFF6	CD6000	CALL	0060
FFF9	C1	POP	BC
FFFA	0A	LD	A,(BC)
FFFB	A3	AND	E
FFFC	C8	RET	Z
FFFD	C3FB03	JP	03FB

Do you have a Tandy tip? We will pay £5 for every tip printed. Send to Tandy Tips, Practical Computing, 2 Duncan Terrace, London N1 8BJ.

One of the most infuriating features of the Tandy Level II manual is that there is no index. We now remedy that with contents you can cut out and stick into your manual.

TRS-80 Level II Index

ABS	7/1	FIX	7/2	PRINT # -1	3/10
ASC	5/3	FOR. TO. STEP	4/8	PRINT	3/1
ATN	7/1			PRINT@	3/1
AUTO	2/1	FRE	5/5	RANDOM	7/3
CDBL	7/1	GOSUB	4/6	READ	3/9
CHR\$	5/4	GOTO	4/5		
CINT	7/2	IF	4/12	RESET	8/2
CLEAR	2/2,4/3	INKEYS	5/5	RESTORE	3/10
CLOAD	2/2	INPUT # -1	3/10	RESUME	4/11
CLOAD?	2/2	INPUT	3/7	RETURN	4/6
CLS	8/2	INT	7/3	RIGHT\$	5/7
CONT	2/3	LEFT\$	5/6	RND	7/3
COS	7/2	LEN	5/6	SET	8/1
CSAVE	2/3	LET	4/4	SGN	7/4
CSNG	7/2	LIST	2/4	SIN	7/4
DATA	3/8	LLIST	10/2	SQR	7/4
DEFDBL	4/2	LOG	7/3	STOP	4/5
DEFINT	4/1	MEM	8/4	STR\$	5/7
DEFNG	4/2	MID\$	5/6	STRING\$	5/7
DEFSTR	4/2	NEW	2/4	SYSTEM	2/5
DELETE	2/3	NEXT	4/8	TAB	5/2
DIM	4/3,6/3	ON ERROR GOTO	4/11	TAN	7/4
EDIT	2/4	ON N GOSUB	4/7	THEN	4/13
ELSE	4/13	ON N GOTO	4/6	TROFF	2/5
END	4/4	OUT	8/4	TRON	2/5
ERL	8/2	PEEK	8/5	USING	3/3
ERR/2+1	8/3	POINT	8/2	USR	8/7
ERROR	4/10	POKE	8/5	VAL	5/8
EXP	7/2	POS	8/6	VARPTR	8/8

Reprinted from Orange County TRS-80 Users' Group Newsletter, available by donation, £10 a year from user group, 24232 Tahoe ct., Laguna Niguel CA 92677.

OHIO SCIENTIFIC

Microcomputers from the world's largest
full-line manufacturer



The C2-4P Mini Floppy

20K RAM
Basic + Assembler
Personal, Games, Small
Business & Educational Disks
90K Mini Floppy Storage
Printer Interface
OS 65D V.30 Operating System
Only £1595.00 Complete + VAT.

Economic expandable
systems with good disk
based software, available
now.

See your nearest
dealer for full price
list and catalogue.

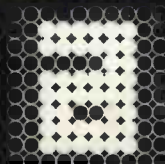

**Abacus
Computers
Limited**

62 New Cavendish Street
London W1 Tel: 01-580 8841

Mutek
Quarry Hill, Box Corsham
Wiltshire SN14 9HT
Tel: 0225-743289

Other systems available include the
C3 OEM with 32K RAM, 512K of disk storage and
BASIC as standard, £2950.00 + VAT. (FORTRAN and
COBOL available as extras.) All dealer enquiries
direct to Abacus Computers Limited.

**Thames Personal
Computers**
13 Wilnot Way Camberley
Surrey Tel: 0276-27860
Linn Products
235 Drakemire Drive
Castlemilk Glasgow

G45 95Z Scotland
Tel: 041-634 3860
U Microcomputers
PO Box 24 Northwich
Cheshire CW8 1RS
Tel: 0606-75627

Helping you to choose

Buying a visual display unit (VDU) can be a daunting task. This month we look at what you can buy for less than £1,000.

THE PRINCIPAL aim of this guide is to explain the features to be found and to look for when selecting VDUs and, equally important, to prevent you having to wade through masses of manufacturers' brochures with their superlatives.

Most VDUs on the market have evolved from the ubiquitous Teletype, a hardcopy printer/keyboard terminal with a maximum operating speed of 10 characters per second.

The Teletype was a winner, selling tens of thousands of units throughout the world, but more recently applications demand higher transmission speeds and where the need for hard-copy is not so important, "glass teletypes" are coming to the fore.

Naturally, many VDUs offer more features than mere "Teletype replacement" and compatibility. They will be covered in more detail later. First, some of the more common buzzwords:

Major role

Interface: the Teletype had a major role to play here, and the development of the 20mA current loop interface was designed around it. This allows for "local" communications by direct two-wire connection over a limited distance to a computer.

The other common type of interface is the EIA RS232C (U.S. standard) or CCITT-V24 (European), both of which are supposedly identical, apart from minor variations, and therefore are used interchangeably. This allows for a signal to be fed into a modem and transmitted via telephone line, theoretically over any distance. Both are serial interfaces. Parallel interfacing is somewhat more ambitious.

ASCII: This is one of the ways of repre-

senting alphanumeric characters in binary code patterns. Seven binary digits (bits) will represent 128 patterns, each corresponding to a particular ASCII character, although most terminals use only a subset of the full character set.

Most interfaces, however, allow for 8-bit character codes, so the spare bit, the eighth bit, may be used as parity bit, which represents whether the bits in the character add up to an even or odd number against which it may be checked for accuracy at the receiving end.

The rate at which a human keys-in characters at a keyboard is somewhat erratic and therefore not synchronised with the computer's own clock; in other words transmission is asynchronous. This means that the computer has to be warned that a character is on its way by means of a start bit preceding it, and a stop bit at the end of it, or in the case of the Teletype, two stop bits to make sure.

This means that a terminal accepting transmission at 9,600 baud—used synonymously with bits-per-second—will display characters at the rate of 960 per second or thereabouts.

Display: If you are wondering why 80 characters per line is so common, it is for no other reason than that punch cards, an earlier data entry medium, have 80 columns. The number of lines ranges between 20 and 25 lines. The characters are formed in a matrix of dots which differs in dimension and format across the various models available.

If you are looking for more bells and whistles, you might like to consider the following features, most of which are designed to facilitate data entry:

Buffers: These are areas of memory which serve as a halfway house for data in transit. This is useful for block mode

transmission, where a piece of data may first be checked and edited if necessary, rather than having each character transmitted immediately as it is keyed-in. In line mode, transmission takes place one line at a time.

Scrolling: This takes place as new lines are entered at the bottom of the screen, with earlier lines disappearing from the top. A scrolling memory will capture some of the lines to display them again when required, by scrolling down. The screen acts, in fact, as a "window into memory".

Alternative

An alternative means of displaying memory is page mode, where it is divided into pages rather than lines. Used with protected fields, page mode allows a programmer to set-up forms on the screen, permitting a switch from one type of data entry to another—for example, from invoicing to stores receipts, or stock enquiries.

Data entry: Other data entry aids include blinking, reverse or inverse video, half-background, and underline, either of protected fields, blank spaces for data entry, or error messages, or any combination of them.

Editing: Editing features may range from simple cursor control and addressing to complex word processing functions. The more common editing functions, however, are character insert/delete, line insert/delete, erase line/screen, and tabulation, the last of which may be used also as a data entry aid.

If you are a supplier of VDUs and we have missed you from this survey, please contact us and we will be pleased to include you in our next round-up.

Burnt Hill Electronics

THE principal advantages claimed for the BH 720 video display terminal are clear text with underline facility, graphics capability, simple cursor control and ease of maintenance.

The 12-in. CRT displays 25 lines by 80 ASCII characters in upper- and lower-case with full descenders including text underlining, blinking and inverse video, and character protection for data entry.

A graphics function is provided and the control system also provides line and page erase, addressable cursor and display of

all control codes. A special function allows the cursor to be returned to the position it was in before the use of the cursor address facility.

The keyboard is capable of generating the full 128-character ASCII code and includes a standard numeric keypad. The interface has a switch-selectable transmission rate from 100 to 19,200 baud in both RS232C and 20mA current loop form. An extension provides for direct connection to a hard-copy printer.

Burnt Hill Electronics Ltd, Holder Road, Aldershot, Hampshire GU12 4RH
Tel: (0252) 313701
Price: £795.



(continued on next page)

(continued from previous page).

Cifer Systems

CIFER is a Wiltshire-based British manufacturer. Of particular interest to the hobbyist will be its Model 034 Cub, featuring a 12-in. diagonal display of 16 lines by 64 upper- and lower-case characters, keyboard with 60 keys, CCITT-V24 interface and eight transmission speeds from 50 to 1,200 bps.

The one-off end-user price is £380 and includes a 12-months' factory warranty. In addition to the standard unit which operates from the normal AC mains

voltage, a 12-volt DC model is available as well as a receive-only Telex version.

Model 127A features the full ASCII repertoire displayed as high-definition 7x12 dot matrix characters on a 24-lines by 80-character display. Standard features include direct XY cursor addressing, fixed or rolling page, printer and video output ports, separate cursor control keys, nine transmission speeds and transmission by character, line, page, or block. (£690 one-off).

Model 026 features a separate contactless keyboard, single- and double-line spacing, double-width characters plus 14

selectable character highlights and cursor addressing (£580 one-off).

Model 224A is a high-quality, page-buffered terminal featuring a separate 84-key keyboard, including numeric and control clusters. Models are available with optional text editing, protected format, tabs, customer-defined character sets and a pseudo-synchronous communications facility (£850 one-off).

Cifer Systems Ltd,
Avro Way, Bowerhill,
Melksham, Wiltshire SN12 6TP.
Tel: (0225) 704502.

Computer Workshop

THE South West Technical Products Co CT-64 visual display terminal is manufactured under licence in the U.K. at Peterborough and marketed by Computer Workshop in London.

It is not a beautiful terminal but worth thinking about at the price (£230 in kit form plus £140 for monitor). A face-lift is imminent, although the price is open to speculation.

The display consists of 16 lines of 64 characters, each formed in a 9x7 dot matrix with full descenders on upper- and lower-case ASCII characters. A switch on the front panel disables lower-case characters.

All cursor movements including home, up, erase to end of line, end of frame, cursor blinking/solid, cursor on/off, page/scroll, and page switch may be selected individually by means of user-defined control characters.

A screen-reversing feature allows field reversal around individual characters or of the whole screen for highlighting purposes. Parity and stop-bit may be jumper programmed on the serial RS232C interface.

The CT-64 is available optionally in assembled form but if you fancy your chances with the soldering iron, you ought to put aside around 15 hours to assemble from kit form.

Computer Workshop,
38 Dover Street,
Piccadilly, London W1.
Tel: (01 491-7507.



Control Data

MODEL 92452 has a 1,920-character display of 24 lines by 80 characters in page or scroll mode. Features include direct XY cursor addressing, incremental cursor positioning, clear screen, clear line,

cursor home, and character/field highlighting.

The standard CCITT-V24 interface allows for transmission at speeds from 110 to 9,600 baud in full-or half-duplex and character or block mode; 20mA current loop interface is optional.

Other options include screen formatting features and numeric keypad.

Megabyte Ltd.,
Kerry House,
Kerry Street, Horsforth,
Leeds, LS18 4AW
Tel: (0532) 583608. Price: £950.

Dacoll Engineering

THE chief attraction of the Model 241 terminal is its lower-case alphabets. It has a 96-character ASCII code using a large 12x7 dot matrix. This format allows for true descenders on lower-case characters. The 12 in. CRT has a 24-line by 80-character display.

Also standard is a numeric keypad. Apart from backspace it offers no editing facilities. Video output for a TV monitor is optional, as is 20mA current loop interface. CCITT-V24 is standard.



The 241 incorporates 1,920-character RAM with switch-selectable half- or full-duplex transmission from 100 to 4,800 baud (Price £660).

The specifications for the Model 247 are much the same as those of the 241 but the characters are formed in a 8x7 dot matrix, and 32 control codes are added to the 96-character ASCII code. Transmission rate increases to 9,600 baud (Price £890).

Dacoll Engineering Services Ltd.,
Gardners Lane, Bathgate,
West Lothian.
Tel: (0506) 56565.

Data Dynamics

THE Tele-ZIP is easily transportable, permitting a user to communicate over a telephone line to a remote computer system, using a standard television receiver or video monitor. Housed in a smart suitcase, it comprises a keyboard and integral acoustic modem. It incorporates fully-controllable cursor and

transmission from 110 to 1,200 baud.

The Tele-ZIP is connected to any standard television receiver aerial socket, using the cable supplied, or connected to a video monitor requiring a video signal at one volt peak-to-peak. (Price £550).

The ZIP-64 costs £395 and employs the 64-character subset of ASCII code—upper-case only. It presents a 16-line by 64-character display on a standard 12 in.

screen. A standard CCITT-V24 interface is included for data transmission from 110 to 1,200 baud, with parity, full- or half-duplex and one or two stop bits.

Data Dynamics,
Data House, Springfield Road,
Hayes, Middx.
Tel: (01) 848-9781.

(continued on next page)

(continued from previous page)

Elbit

ELBIT Data Systems is the Israeli subsidiary of Control Data Corporation. The DS1920/11 is described as a Teletype-replacement terminal, with a 12 or 15 in. diagonal screen displaying 1,920 characters in 24 lines by 80 characters.

A 5×8 dot matrix character format is

standard but an optional 7×8 dot matrix format is available for lower-case character descenders, with ASCII codes in 64-, 96- and 128-character sets.

Transmission rates are switch-selectable from 110 to 9,600 baud asynchronous with even, odd or no parity via RS232C or 20mA current loop and printer interface.

Options include editing features, blink-

ing, field protection, tabulation, cursor control, numeric keypad, address field XY positioning, and page and scroll modes.

Elbit Data Systems Ltd,
Cophall House, St Ives Road,
Maidenhead, Berkshire.
Tel: (0628) 32312.
Price: £550.

Fungus Computer Products

THE abbreviation for metal-oxide silicon is MOS. Stretch that a little and you have Fungus Computer Products, the subsidiary of Systime, a systems house which packages Digital Equipment PDP-11s.

Model 7752 Mark I VDU features direct cursor addressing, high-character

definition on a 15 in. diagonal screen, detachable keyboard and inverse video.

Characters are made up in a 7×5 dot matrix and displayed in 80 characters by 25 lines. The character set is 96 ASCII upper-and lower-case and the keyboard includes a numeric cluster.

Transmission in block or character mode is provided via the built-in CCITT V24 and 20mA current loop interface at

rates from 110 to 9,600 baud. Price: £685.

The 7753 Mark II model is similar to the above, but has an additional row of special function keys.

Fungus Computer Products,
Westmorland House, Second Floor,
Teall Street Wakefield,
West Yorkshire.
Tel: (0924) 60274.
Price: £695.

GEC Telecommunications

THE Datacom 30 terminal is designed for use with the Post Office Prestel and private viewdata systems. It comprises a full alphanumeric detachable keyboard, a 12 in. monochrome display, an integral modem, automatic dialling and a security switch.

A normal keyboard layout is used with

upper- and lower-case characters and Teletype symbols. Control keys give access to viewdata graphic codes.

Local data storage allows the last page of data to be displayed and retained when the connection to the viewdata centre is released, thereby reducing line costs to a minimum.

A six-address, short-code dialler gives rapid access to Prestel/viewdata centres,

the Prestel numbers being programmed by the Post Office. Security is provided by means of a key-operated switch to prohibit unauthorised use.

GEC Telecommunications,
Telephone Division,
Whinbank Road, Aycliffe Industrial Estate,
Co. Durham.
Tel: (0325) 313341.
Price £600 approximately.

Geveke Electronics

TERMINALS manufactured by TEC Inc are supplied in the U.K. by Geveke Electronics.

Model 502 features a 12 in. diagonal screen of 25 lines by 80 characters formed in an 8×10 dot matrix with a character set of 126 ASCII codes in upper- and lower-case.

Numeric keypad is optional. Full cursor control, switchable inverse video and end-of-line bell are standard features. It is supplied with a standard RS232C and current loop interface for transmission speeds from 50 to 9,600 baud in full- or half-duplex mode (£720).

The Tele-TEC Model 1440/1445 features a raster scan refresh rate of 60 Hz, a 64-character ASCII code (upper-

case only), 24 lines by 80 characters formed in a 5×7 dot matrix, and transmission as per Model 502, plus 10- or 11-bit characters with even, odd or no parity (£815-£959 depending on screen size).

Geveke Electronics,
RMC House, Vale Farm Road,
Woking, Surrey GU21 1UW.
Tel: (00862) 71337.

Hazeltine

THE H1400 represents the company's fifth generation of microprocessor-based video terminals, supplementing the existing H1500 range.

Hazeltine says that because of the microprocessor design, the H1400 has far fewer components, resulting in greater reliability and cooler operating temperatures than can be obtained by earlier conventional designs. All the electronics are contained on a single printed circuit card.

The H1400 features a RS232C interface, with odd, even or no parity operating at rates switch-selectable up to 9,600 baud, in full- or half-duplex mode; 64 ASCII characters are formed in a 5×7 dot matrix. Remote commands provide for screen control, such as absolute or incremental cursor address, read cursor address, read character at cursor position, and clear screen (£550).

The H1410 includes a separate numeric keypad which adds another £50 to the price.

The H1500 costs £785 and provides a

94 ASCII character set formed in a 7×10 dot matrix, dual-intensity, rates up to 19,200 baud, auxiliary output, and reverse video.

The H1510 costs £880 and adds protected fields, transmit batch/line/page of unprotected-only data, function keys, tab/back tab/auto tab, and format mode with insert and delete line keys.

Hazeltine Ltd,
Terminal House,
14 Petersham Road,
Richmond Surrey.
Tel: /01 908-3111.

Heathkit

THE Heathkit H9 is designed ideally for use with its H8 or H11 personal computers (reviewed November, 1978) but will nonetheless plug into any other system via its RS-232C (or CCITT-V24 for European) and 20mA current loop serial interfaces, or its parallel interface including standard TTL levels, 8-bits input and 8-bits output and four hand-shaking lines.

The character format is standard

upper-case 5×7 dot matrix. The standard long-form display is 12 80-character lines but if you can obtain back copies of the unofficial Heathkit user magazine, one of them contains details on ROM-tweaking by which you can achieve a 24-line display.

The short-form display provides four 12-line columns of 20 characters each. The automatic line carry-over feature executes line feed and return when the line exceeds the character count of both display forms. A built-in oscillator/

speaker generates an audible end-of-line warning.

Auto-scrolling is featured in both long and short form, with new lines entered from the bottom or new columns entered from the right. This feature may be disabled with a front panel switch. Cursor control keys include up, down, left, right and home.

The erase mode permits automatic full-page erase, or erase to end of line starting at cursor position. A transmit-

(continued on page 49)

From Science of Cambridge: the new MK 14. Simplest, most advanced, most flexible microcomputer – in kit form.

**only
£39.95
(+ 8% VAT)**

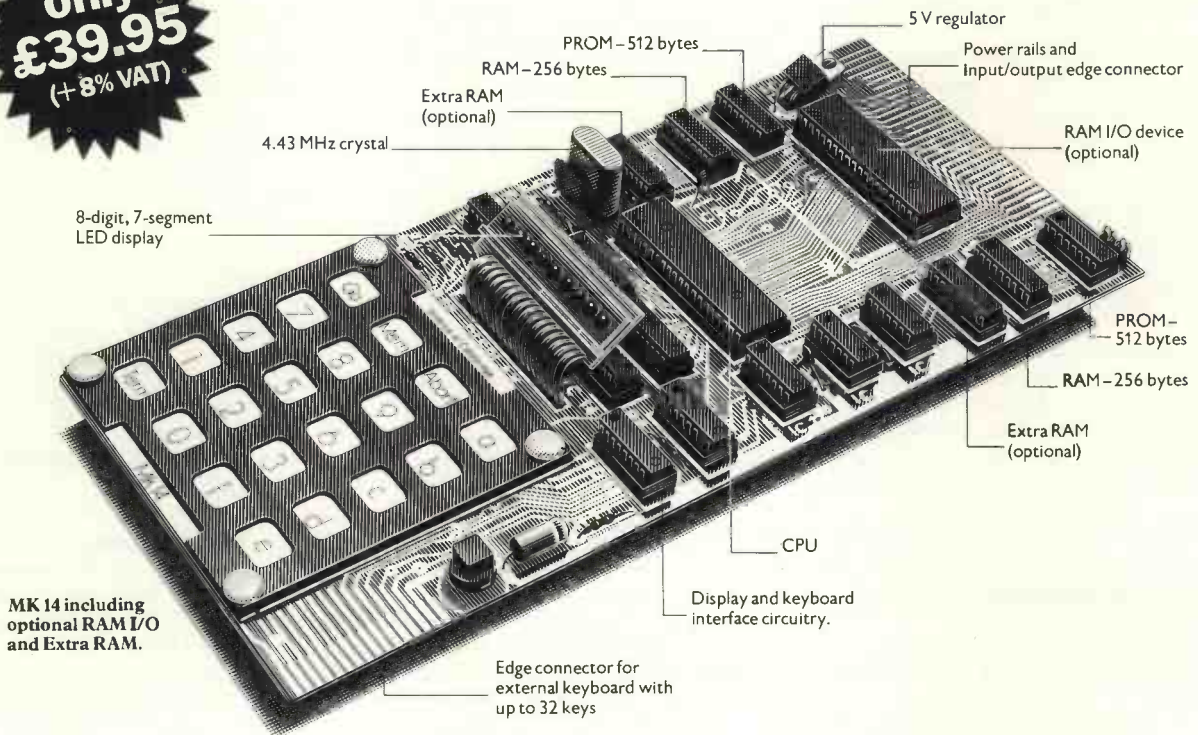

MK 14 including optional RAM I/O and Extra RAM.

The MK 14 is a complete microcomputer with a keyboard, a display, 8 x 512-byte pre-programmed PROMs, and a 256-byte RAM programmable through the keyboard.

As such the MK 14 can handle dozens of user-written programs through the hexadecimal keyboard.

Yet in kit form, the MK 14 costs only £39.95 (+£3.20 VAT, and p&p).

More memory – and peripherals!

Optional extras include:

1. Extra RAM – 256 bytes.
2. 16-line RAM I/O device (allowed for on the PCB) giving further 128 bytes of RAM.
3. Low-cost cassette interface module – which means you can use ordinary tape cassettes/recorder for storage of data and programs.
4. Revised monitor, to get the most from the cassette interface module. It consists of 2 replacement PROMs, pre-programmed with sub-routines for the interface, offset calculations and single step, and single-operation data entry.
5. PROM programmer and blank PROMs to set up your own pre-programmed dedicated applications.

All are available now to owners of MK 14.

A valuable tool – and a training aid

As a computer, it handles operations of all types – from complex games to digital alarm clock functioning, from basic maths to a pulse delay chain. Programs are in the Manual, together with instructions for creating your own genuinely valuable programs. And, of course, it's a superb education and training aid – providing an ideal introduction to computer technology.

SPECIFICATIONS

● Hexadecimal keyboard ● 8-digit, 7-segment LED display ● 8 x 512 PROM, containing monitor program and interface instructions ● 256 bytes of RAM ● 4 MHz crystal ● 5 V regulator ● Single 8 V power supply ● Space available for extra 256-byte RAM and 16 port I/O ● Edge connector access to all data lines and I/O ports

Free Manual

Every MK 14 kit includes a Manual which deals with procedures from soldering techniques to interfacing with complex external equipment. It includes 20 sample programs including math routines (square root, etc), digital alarm clock, single-step, music box, mastermind and moon landing games, self-replication, general purpose sequencing, etc.

Designed for fast, easy assembly

The MK 14 can be assembled by anyone with a fine-tip soldering iron and a few hours' spare time, using the illustrated step-by-step instructions provided.

How to get your MK 14

Getting your MK 14 kit is easy. Just fill in the coupon below, and post it to us today, with a cheque or PO made payable to Science of Cambridge. And, of course, it comes to you with a comprehensive guarantee. If for any reason, you're not completely satisfied with your MK 14, return it to us within 14 days for a full cash refund.

Science of Cambridge Ltd,
6 Kings Parade, Cambridge, Cambs., CB2 1SN.
Telephone: Cambridge (0223) 311488

To: Science of Cambridge Ltd, 6 Kings Parade, Cambridge, Cambs., CB2 1SN.

Please send me the following, plus details of other peripherals:

- MK 14 Standard Microcomputer Kit @ £43.55 (inc 40p p&p.)
 Extra RAM @ £3.88 (inc p&p.)
 RAM I/O device @ £8.42 (inc p&p.)

I enclose cheque/money order/PO for £_____ (indicate total amount.)

Name _____

Address (please print) _____

Allow 21 days for delivery.

Science of Cambridge

(continued from page 47)

page function allows a full page to be formatted, edited and modified, and then transmitted as a block of continuous data.

The plot mode permits graphs, curves and simple figures to be displayed. Plotting can be accomplished via the front-panel keyboard or from external inputs.

Heathkit,
233 Tottenham Court Road,
London W1P 9AE.
Tel: (01) 636-7349.
Price: £499.

Lear Siegler

BETTER-KNOWN as the Dumb Terminal, the Lear Siegler ADM-3A is one of the most popular VDUs with hobbyist systems, particularly in the U.S. where its price is really competitive. Indeed, ADM stands for American Dream Machine.

Standard features include 11 switchable transmission speeds to 19,200 bps, and

switch-selectable data word formats, 9, 10 or 11 bits in length; odd, even, or no parity; one or two stop bits. The display is 12 lines by 80 characters in 5×7 dot matrix.

Upper-and lower-case characters are standard, though without true descenders. Switch-selectable 20mA or V24 interfaces are provided. Data entry is by means of scrolling, one line at a time with each new line entered, or in page mode, allowing

the programmer to position the cursor at any character position on the screen, from which the operator may enter data—assuming they are different people.

Options include 24-line display, full 96-character ASCII code, numeric keypad and answer-back.

Penny & Giles Data Recorders,
Mudford, Christchurch, Dorset.
Tel: (04252)-71511.
Price: £569.

Lyme Peripherals

THE MODEL 4002 terminal holds 4,000 characters in its memory, 1,920 of which are displayed on the 12 in. diagonal screen in a 7×12 dot matrix.

The display may be scrolled up or down, line by line or continuously by using the repeat key. Instant return to last entry position is provided by a single

key depression.

Transmission speeds are switchable from 75 to 9,600 baud via the dual RS232C/20mA current loop interface. Price: £645.

The Model 4004 is a text-editing version of the former with 16 user-programmable function keys, horizontal tabs, optional printer port, two separate pages and block and character mode

transmission. (Price £745).

Other features include protected areas—defined by reduced intensity—XY cursor addressing character insert/delete and cursor blinking underscore.

Lyme Peripherals Ltd.,
2 Avenue Court, Farm Avenue,
London NW2 2PT.
Tel: 01-452-0490.

Mellordata

THE ELITE 1521A is manufactured by Datamedia Corporation and supplied by Mellordata in the U.K. It features a 24-line by 80-character display using the full 128-character ASCII code, or 64-

character subset for upper-case only.

Characters are formed in a 5×9 dot matrix on a dual-intensity display (upper-case only). Editing facilities include clear screen, page and line with full cursor control. Transmission rates are switchable between 50 and 9,600 baud via a standard

RS232C or 20mA current loop interface. Delivery ex-stock.

Mellordata,
Woodgates Road,
East Bergholt, Colchester
Tel: (020629) 8181. Price £720.

Newbury Laboratories

NEWBURY LABORATORIES is an all-British manufacturer concentrating on VDUs. It owns Newbear Computing Store and is in turn owned by another all-British peripheral manufacturer, Data Recording Equipment.

Even if you are not bound to buy British you could do worse in terms of value.

Prices start at £495 for Model 7000/1/2. This provides a 24 lines by 80 characters (5×7 dot matrix) display. Dual CCITT-V24 and 20/60mA current loop interface, hard-copy facility and video output for external monitors, and switchable half-or full-duplex mode transmission from 75 to 9,600 bps are available on the 7001/7002.

Upwards from that are Models 7006/7 starting at £695, based on the Intel 8080

with split-speed transmission, and Models 7008/9, starting at £775, featuring two-page memory (3,840 characters), full editing facilities and block transmission by line or page.

Newbury Laboratories,
King Street, Odiham,
Hampshire RG25 1NN
Tel: (025671) 2910.

Pericom

PERICOM offers a programmable micro-processor-controlled VDU based on the Motorola 6800, the Pericom 6801.

It features 32 user-definable function

keys, 52 editing function keys, scrolling memory, full cursor control and block and character transmission. The screen displays 24 lines by 80 characters. V24 interface is standard with optional 20mA

current loop interface.

Pericom Data Systems Ltd,
Burners Lane, Kiln Farm,
Milton Keynes, Bucks.
Tel: (0908) 564747. Price: £985.

Perkin-Elmer

PERKIN-ELMER has a new model, the Bantam Model 550. It has a display of 80 characters to its 24 lines, and its special

features include full upper-and lower-case characters, complete cursor addressing, shadow numeric pad, silent operation and compact size, and a range of international character sets, including APL. The one-off

price for the unit is slightly less than £600.

Perkin-Elmer Data Systems,
Terminals Division, 227 Bath Road,
Slough, Berkshire
Tel: (0753) 34511.

Pragma

memory lock allows the operator or the computer to lock a portion of the display, while retaining the ability to enter or receive data in the unlocked portion.

Features include eight levels of video and a data display of 80 characters on 24 lines, with 16 extra characters per line

available for field attributes. Other THE user-programmable MCB1 Beehive Micro Bee is a microprocessor-controlled conversational terminal operating at speeds up to 19,200 bps.

It has a self-diagnostic feature to show at a glance if the terminal is working properly. A status line displays modes of operation, error messages, and the like. A

features include cursor addressing, read cursor address, invisible memory address pointer and read terminal status. (Price from £877).

Pragma Ltd,
29 High Street, Edgware,
Middlesex HA8 7UU
Tel: 01-952 8471.

Pronto Electronic Systems

MODEL 601A does not include a screen but the company says a modified domestic TV set may be used.

It is a portable unit weighing 10 lb. and costing £325. Standard features include full cursor control and built-in V24 and 20mA current loop interface.

Pronto Electronic Systems,
645 High Road, Seven Kings,
Essex IG3 8RA
Tel: 01-599 3041

(continued on page 51)

INTRODUCING DUAL DRIVE MINIFLOPPY FOR PET!



- DUAL MINI FLOPPY DRIVE WITH 100K PER DISK SIDE FOR TOTAL 200K ON LINE
- DESIGNED FOR COMMERCIAL SPEED REQUIREMENTS
- FAST LOADING SPEED
- DISKMONT™ (DOS) AUTOMATICALLY REORGANIZES FREE DISK SPACE AFTER SAVE OR ERASE
- DISKMON IS RESIDENT IN ROM VIA DISK CONTROLLER BOARD PLUGGED INTO EXPANDAPET•
- DISKMON ADDS 14 COMMANDS TO BASIC INCLUDING DISK DATA FILES
- DISKMON COMMANDS SUPPORT COMMERCIAL PRINTER OFF PARALLEL PORT SUCH AS CENTRONICS 779
- FULL DISK SOFTWARE SUPPORT
- FORTRAN & PLM COMPILERS THIS JANUARY
- 90 DAY MANUFACTURER'S WARRANTY ON HARDWARE
- READY TO USE ON DELIVERY, WITH FULL INSTRUCTIONS AND UTILITY DISKETTE
- CALL OR WRITE FOR ADDITIONAL INFORMATION
- INITIAL QUANTITIES LIMITED
- THIS SYSTEM IS FULLY SUPPORTED BY SOFTWARE FROM THE MANUFACTURER
- ORDERS ARE NOW BEING ACCEPTED FOR DECEMBER & JANUARY DELIVERY

DKH641 —DUAL DRIVE SYSTEM, COMPLETE WITH DISKMON£916 + VAT

DKL067 —DISKMON ASSEMBLER LISTING/DOS P.O.A.
 ASM789T —PET-ASSEMBLER ON CASSETTE P.O.A.
 ASM789D —PET ASSEMBLER ON DISKETTE (5.5 inch) P.O.A.
 LNK456 —AUTOLINK LINKING LOADER ON DISKETTE .. P.O.A.
 FOR300 —FORTRAN COMPILER ON DISKETTE P.O.A.
 PLM400 —PLM COMPILER ON DISKETTE P.O.A.

★★ BUSINESS PACKAGES STARTING IN 1st QUARTER 1979 ★★
 • THIS SYSTEM REQUIRES EXPANDAPET MEMORY (MINIMUM 16K—SEE BELOW)

INTERNAL MEMORY EXPANSION FOR PET!

EXPANDAPET™

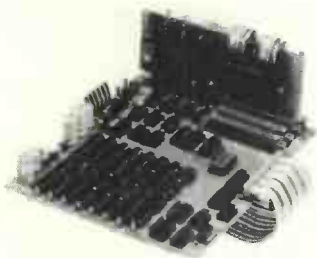

32K UNIT ALLOWS 8K OF ASSEMBLY LANGUAGE SUBROUTINES ACCESSED VIA THE USR COMMAND

OPTIONAL PLUG-IN BOARDS
 SERIAL I/O BOARD P.O.A.
 S-100 I/O BOARD P.O.A.
 4K EPROM BOARD P.O.A.

INTERNAL MEMORY EXPANSION UNIT

- MOUNTS EASILY INSIDE YOUR PET
- EASY TO INSTALL (15 MINUTES)
- NO DEGRADATION OF PET SYSTEM
- USES LOW POWER DYNAMIC RAMS
- 90 DAY PART & LABOUR 1 YR.-RAMS
- 30 DAY MONEY BACK GUARANTEE
- MOUNTING SLOTS FOR 4 BOARDS
- CALL/WRITE FOR ADDITIONAL INFO
- DEALER INQUIRIES INVITED

EXPANDAPET PRICES

16K (+ 8K PET = 24K) £298 + VAT
 24K (+ 8K PET = 32K) £364 + VAT
 32K (+ 8K PET = 40K) £425 + VAT

MUSIC BOX

Turns your PET into a programmable musical instrument. You can record and play up to 90 pages, 16 notes per page, change tempo, key, etc.

£37.50 inc. VAT & P&P

T.I.S. WORKBOOKS

A set of 5 workbooks to give you a full understanding of all the ins and outs of your PET more fully than any previous manuals.

£15.95 per set, inc. P&P

Lots of software and other goodies.
 Send large SAE

OHIO SCIENTIFIC SUPERBOARD II

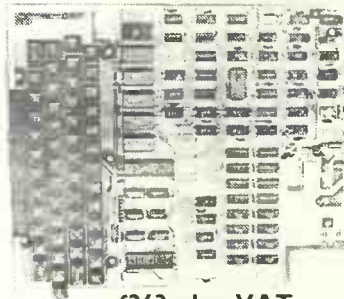

£263 plus VAT

Standard Features

- Uses the ultra powerful 6502 microprocessor
- 8K Microsoft BASIC-in-ROM
- Full feature BASIC runs faster than currently available personal computers and all 8080-based business computers
- 4K static RAM on board expandable to 8K
- Full 53-key keyboard with upper-lower case and user programmability
- Kansas City standard audio cassette interface for high reliability
- Full machine code monitor and I/O utilities in ROM
- Direct access video display has 1K of dedicated memory (besides 4K user memory), features upper case, lower case, graphics and gaming characters for an effective screen resolution of up to 256 by 256 points. Normal TV's with overscan display about 24 rows of 24 characters, without overscan up to 30 x 30 characters.

Extras

- Available expander board features 24K static RAM (additional mini-floppy interface, port adapter for printer and modem and OSI 48 line expansion interface.
- Assembler editor and extended machine code monitor available.

Fully built and tested. Requires only +5V at 3 amps and a videomonitor or TV and RF converter to be up and running. Phone or write for delivery dates. Full one year warranty.

LOTUS SOUND, 4 MORGAN ST., LONDON E3 5AB

Tel: 01-981-3993

Telex: 261426 Attn: Lotus Sound

(continued from page 49)

SEN Electronics

INFOTON terminals are marketed in the U.K. by SEN Electronics. The Infoton 100 is the latest offering in the range and is a microprocessor-controlled terminal based on the Zilog Z80, featuring a 1,920-character 12-in. diagonal screen displaying 24 lines of 80 characters formed in a 5 x 9 dot matrix, with a 25th status line from a 96-character ASCII set, plus drawing characters for graphics.

Other standard features include selectable reverse video, selectable half- or full-intensity, line insert/delete, addressable/readable cursor, and 15-key numeric cluster. Basic price is £610.

Options include PROM-programmable function keys, separately addressable RS232C printer port, block mode, protected field/erase field, insert/delete character, composite video output for monitors and true emulation for the following terminals—DEC VT52 including

special keycaps, Lear Siegler ADM3A, ADDS Console 520, Hazeltine 1400/1500 and Perkin-Elmer Fox.

The Infoton is also Z80-based but is an older and completely different terminal with detachable keyboard, providing three pages of user memory.

The basic price is £875.

SEN Electronics Ltd,
5 London Street,
Chertsey, Surrey
Tel: (09328) 66744.

Soroc

THE Soroc IQ 120 offers such standard features as switch-selectable transmission rates from 75 to 19,200 bps, cursor control, RS 232C interface, standard numeric keypad, line and page erase functions and

protect mode.

Options include block mode transmission, hard-copy facility with printer interface extension, lower-case characters and 1,920-character screen memory. Other options include 24 lines by 80 char-

acters (12 lines standard) and 20mA current loop interface.

Compelec Electronics,
310 Kilburn High Road,
London NW6
Tel: (01) 636 1392. Price: £655.

Strumech Engineering

THE ACT-1 from Strumech Engineering is a video monitor-based terminal which manages a 1,024-character memory into 16 lines of 64 upper- and lower-case ASCII characters.

Output can be to the standard video monitor, or to a standard television set by

means of an optional UHF modulator costing £10. Characters are formed in a 9 x 7 dot matrix with full descenders on lower-case characters.

Standard features are cursor forward/backward, scroll up/down, and bell. I/O specifications include switchable data transfer rates from 110 to 19,200 baud;

even, odd, or no parity; one or two stop bits; and standard RS232C or 20mA current loop interface.

Strumech Engineering Ltd,
Portland House, Coppice Side,
Brownhills, Walsall, Staffs.
Tel: (05433) 4321.
Price: Monitor £125, terminal £260.

Technitron

TELERAY terminals manufactured by Resarch Inc are marketed in the U. K. by Technitron Inc (U.K.).

The Telera 3541 is a straight Teletype replacement with upper-case-only char-

acter set ASCII code. It features a display of 24 lines by 80 characters, detachable keyboard, and built-in CCITT-V24 and 20mA current loop interface (£800).

The Telera 3741 include the same features plus user-definable function keys and 'space over data' edit functions, and

upper- and lower-case ASCII code (£850).

The Telera 3841 adds fully-addressable cursor control at £900.

Technitron Inc (U.K.),
Doman Road, Yorktown Industrial Estate,
Camberley, Surrey GU15 3DH
Tel: (0726) 26517.

Terminal Display Systems

THE ADDS Regent 100 utilises a 96-character ASCII code displayed on a 24-line by 80-character screen in 8 x 8 dot matrix. A 25th line displays the operating

status of the terminal.

Transmission speeds are switch-selectable up to 9,600 baud and features include reverse video, underline, half and zero intensity, blinking, line-drawing and full cursor addressability. An RS232C or

current loop interface is supplied.

Terminal Display Systems,
Hillside, Whitebirk Estate,
Blackburn, Lancs BB1 5BR
Tel: (0254) 662244.
Price: £845.

Warren Logic

THE SR100 Minitype comprises a Teletype-compatible keyboard with full ASCII capabilities. The display consists of 15 alphanumeric 16-segment LEDs util-

ising a 128-character ASCII subset.

The on-line mode of operation is in full duplex with a local facility. Both RS232C and 20mA current loop transmission are standard at rates from 50 to 9,600 baud. Also available is an interface for a low-

cost thermal printer.

Warren Logic Ltd,
Hockley Road, Broseley,
Salop TF12 5HT
Tel: (0952) 883010.
Price: £298.

VDUs for less than £1,000

Burnt Hill Electronics	BH 720	£795	Heathkit	H9	£499
Cifer Systems	034 Cub	£380	Lear Siegler	ADM-3A	£569
Cifer-Systems	127A	£690	Lyme Peripherals	4002	£645
Cifer Systems	026	£580	Lyme Peripherals	4004	£745
Cifer Systems	224A	£850	Mellodata	Elite 1521A	£720
Computer Workshop	SWTPC CT-64	£230 (kit form) + £140 for monitor	Newbury Laboratories	7000/1/2	£495/£595
Control Data	92452	£950	Newbury Laboratories	70046/7	£695
Dacoll Engineering	241	£660	Newbury Laboratories	7008/9	£775
Dacoll Engineering	247	£890	Pericom	6801	£985
Data Dynamics	Tele-ZIP	£550	Perkin-Elmer	550	£600
Data Dynamics	ZIP 64	£395	Pragma	MCBI Beehive Micro Bee	£877
Elbit	DS11920	£350	Pronto Electronic Systems	601A	£352
Fungus Computer Products	7752	£685	SEN Electronics	Infoton	£875
Fungus Computer Products	7753	£695	SEN Electronics	Infoton 100	£610
GEC Telecommunications	Datacom 30	£600	Soroc	IQ 120	£655
Geveke Electronics	502	£720	Strumech Engineering	ACT-1	£260
Geveke Electronics	Tele-TEC 1440/1445	£750 £815-959	Technitron	Telera 3541	£800
Hazeltine	H1400	£550	Technitron	Telera 3741	£850
Hazeltine	H1410	£600	Technitron	Telera 3841	£900
Hazeltine	H1500	£785	Terminal Display Systems	ADDS Regent 100	£845
Hazeltine	H1510	£880	Warren Logic	SR100 Minitype	£298

Note: Most companies will offer discounts for quantity orders.

Unleash your Pet* to its full capability. Add a Plessey Petite.



The easy way to 32K.

- Self-contained peripheral for any Commodore Pet.
- Plugs into mains and Pet.
- No modifications required.
- No demands on Pet power supply.
- No extra heat dissipation within Pet cabinet.
- No warranty problems.

Available now from Europe's leading memory manufacturer, an add-on 24K module to make your Pet more like a powerful business computer.

On sale now through authorised distributors of Plessey Pet peripherals:

Business Electronics Limited
Rownhams House,
Rownhams,
Southampton
(0703) 738248

C.S.S. (Business Equipment)
Limited
502 Kingsland Road,
London, E8 4AE
01-254 3293

Dams Office Equipment Limited
30-36 Dale Street,
Liverpool, L2 5SF
(051) 227 3301

H. B. Computers Limited
22 Newland Street,
Kettering,
Northants
(0536) 83922/520910

Holdene Limited
10 Blenheim Terrace,
Leeds, LS2 9HX
(0532) 459459

Medical & Scientific Computer
Services Limited
Altona Road,
Lisburn, County Down,
Northern Ireland
(084) 62 77533

Rockcliffe Brothers Limited
2 Derby House,
Rumford Street,
Liverpool, L2 8SZ
(051) 236 6773

Sigma Systems Limited
54 Park Place,
Cardiff
(0222) 21515

Torbus Business Systems
Limited
500 Chesham House,
150 Regent Street,
London, W1R 5PA
01-734 5351



PLESSEY
MICROSYSTEMS

*Trademark of Commodore Business Systems.

654-2-094

Games you can play

Video Checkers

Cassette for either Tandy TRS-80 or Commodore Pet. Available from Whitehead Micro Systems, Holly House, 45A Windy Arbour, Kenilworth, Warwickshire. Price £9.95.

THIS program allows the computer to play an intelligent, legal game of draughts, using international rules. The computer is black and therefore always moves first and prompts you by displaying the message "your move" on the right-hand side of the screen. You can move by typing-in the number of the square you occupy and then the number of the square to which you want to move your piece. We tested the program on the Pet, but in the TRS-80 version, you must type a comma between the two sets of numbers.

One quirk in the program we found particularly annoying was that you must jump a piece when the computer tells you to. The game will not continue until you do as it wishes; thus you lose a certain amount of control over it. It does sometimes work the other way, however, and the computer points out an advantageous move you may have missed.

Double and triple jumps are mandatory and they are made one jump at a time. The computer will prompt you when to take your second or third jump. A king is denoted by K in the corner of the appropriate square. A game can be terminated by typing either a "BREAK" or a "STOP".

You will love this program if you have an evening to spare and you will need that, because the computer takes a long time to make up its mind where to move. An average game takes from 45 - 60 minutes to play but if your patience is strong enough, it's worth it in the end, if only to see the computer's startled "I can't believe it, you won" light up on the screen.

Despite this, it is an enjoyable game to play.

Microchess 2.0

Cassette for Commodore Pet. Written by Peter Jennings and available from most Pet dealers. I HATE to admit it but I was continually beaten by the computer on its top level. So far I have won twice out of about 50 attempts.

I'm probably an average chess player yet prepared to treat this program with some scepticism - "Whoever thought I could be beaten at chess by a computer" and all that.

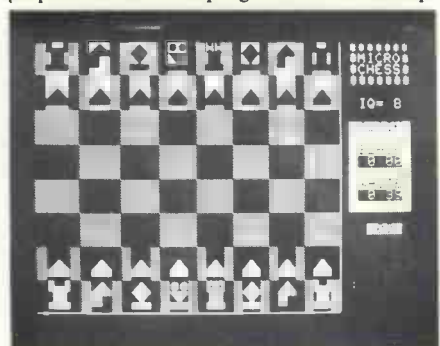

The program gives eight choices of "difficulty". At its most difficult the computer is thinking six moves ahead and can take some time to work out its moves.

I started with Level 8 and then worked backwards until I found a level I could beat easily, then started to "climb". At the top level the computer is setting some ingenious traps and you end up kicking yourself and saying that was obvious after you walked right into it.

Still, it is great fun. I am sure it can improve

your play. I know mine is better. Chess experts would doubtless find it trivial but for the average player it's great fun. Graphics are excellent. There's a time clock and you can set chess problems to solve.

Rhino, Hangman and Reaction Test

Cassette for the Commodore Pet. Available from most Pet dealers. Manufactured by Info-guide on the Compusette label. 142 Wardour Street, London W.1.

RHINO is a novel game in which you get chased all over the VDU by things which purport to

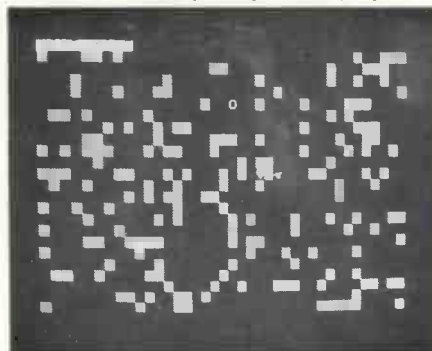

be rhinos but look remarkably like pi signs. We felt it re-created all the thrills and spills involved in the Big Hunt. Definitely a fun game.

The object is to get "home" through the random jungle which the computer prints before the start of each game, without being "whammed" by the rhino(s). They hide among the trees and you cannot see them, and they appear only when they see you.

The computer tells you how many there are on the screen before the game starts. The number is determined by how many games you win in succession. You start with one, and when you get past that, you go to two, and so on. We managed to reach 11 at once but that was our limit, so we can't really say how far you can go with the game, although the maximum is 30.

You negotiate yourself around the screen by using the Pet's number keypad. This is laid out like a calculator and you are in the centre, in effect number five. So if you want to move to the right, you press number six, and so on. You cannot move until the computer tells you to do so, and it is always your move until the rhino spots you. Once he does, he is after you very quickly and often moves three or four times in a row before it is your turn again.

An exciting game which everyone can play, from granny to the kids.

By comparison, the other two games on the cassette were fairly uninteresting. Hangman contains dozens of different words, so if that is up your street, it will keep you happy for hours. The hangman is drawn with some rapidity by the computer and you only have 10 chances to get it right before you're hanged.

Some letters occur more than once in each word but are entered only one at a time, so you may have to press a certain letter more than once before you find the solution.

After the thrills of Rhino, the Reaction Test was something of a letdown. You have to press any button on the keyboard when the word "go" appears. The time you take to press it is then entered in a table at the top of the screen, opposite the number of attempts you have had. The average is worked out and that is all there is to it.

One final word of warning. If you depress

the key before the "go" signal has appeared, you are accused of cheating by the computer. Like most games, it is fun when two play but not quite so invigorating when played alone.

Air Raid

Cassette for Tandy TRS-80. Manufactured by Small System Software, PO Box 483, Newbury Park, California 91320, U.S. Available from Whitehead Micro Systems, Holly House, 45A Windy Arbour, Kenilworth, Warwickshire. Price: £9.95.

AIR RAID gave us many hours of pleasure, which probably shows what vicious creatures we are, for the game involves shooting down enemy aircraft with a ground gun and then trying to exterminate the parachutists who abandon their craft.

There are two types of craft which fly across the screen, fast and slow. You score more points for hitting the fast aircraft, and even more points for shooting down the parachutists when two planes crash. You control the ground gun by moving the Tandy cursors left or right and you shoot your missiles by pressing any key on the keyboard. Your score is added as you proceed and you have points deducted if you use too many shots.

You have 90 seconds in which to complete your game, but if you total more than 6,000 points, you go into extra time. The game speed is controlled by pressing any key from 1 to 9 before the game starts.

We had fun with Air Raid. The graphics are good and the type of game you play varies with the speed which you select. With the slower speed, you can control the "bend" of shots, even though the aircraft move more slowly on to the screen.

Backgammon and Blackjack

Cassette for Tandy TRS-80. Manufactured by: Tandy Corporation. Available from Tandy Corporation, Bilston Road, Wednesbury, West Midlands. 021-556 6101.

THIS program is definitely not the best we have seen or heard about. There are no instructions with the cassette as to how it works - we had difficulty trying to get our pieces into the base. It was only by trial and error that we discovered you have to press 99 to move your piece there.

You have to play the game with a human opponent, which can be disconcerting if

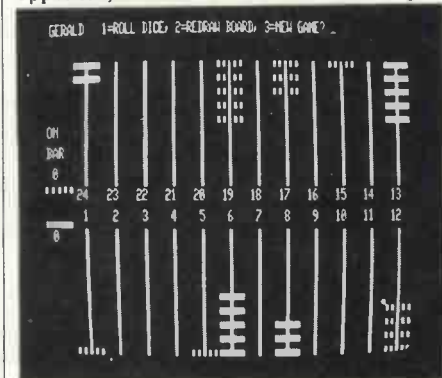

everyone else you know thinks backgammon is boring.

The most appealing thing about Blackjack was that you could bet as much as you liked without losing money. As compulsive gamblers, we found this a great asset.

COMPUTING BOOKS

POPULAR COMPUTER TITLES

Arnold, R., Modern Data Processing	£6.60
Boyle, J., Digital Computer Fundamentals	£12.85
Clifton, H., Business Data Systems (a Practical Guide to Systems Analysis; Data Processing)	£6.00
Dijkstra, E., Discipline of Programming	£15.10
Fry, T., Computer Appreciation	£3.50
Fry, T., Further Computer Appreciation	£4.25
Hansen, P., Operating System Principles	£16.30
Hansen, P., Architecture of Concurrent Programs	£16.00
Hill, F., Digital Systems, Hardware Organisation and Design	£9.00
Motil, T., Digital System Fundamentals	£7.60
Peathan, J., Design of Digital Systems	£7.90
Rosen, A., Word Processing	£11.50
Wirth, N., Systematic Programming	£12.75
Wirth, N., Algorithms + Data Structure = Programs	£16.20

COOKBOOKS

Tracton, K., BASIC Cookbook	£4.10
Lancaster, D., TTL Cookbook	£7.00
Lancaster, D., RTL Cookbook	£4.65
Lancaster, D., CMOS Cookbook	£8.20
Jong, W., IC Op Amp Cookbook	£10.00
Lancaster, D., T.V. Typewriter Cookbook	£7.75
Lancaster, D., Cheap Video Cookbook	£7.00
Jong, W., IC Timer Cookbook	£7.50
Lancaster, D., Incredible Secret Money Machine (a how to cook book for setting up your computer or technical business)	£4.95

Altman, L., Microprocessors £10.65
Gives a general overview of the technology design ideas and explains practical applications.

Altman, L., Applying Microprocessors £12.00
Follow volume which takes you into the second and third generation devices.

Aspinall, D., Intro to Microprocessors £6.40
Explains the characteristics of the component.

Barden, W., Z-80 Microcomputer Handbook £7.65
Barden, W., How to Buy and Use Minicomputers and Microcomputers £7.15

Discusses these smaller computers and shows how they can be used in a variety of practical and recreational tasks in the home or business.

Barden, W., How to Program Microcomputers £7.00
This book explains assembly language programming of microcomputers based on the Intel 8080, Motorola MC6800 and MCS Technology MCS6502 microprocessor.

Barna, A., Introduction to Microcomputers and Microprocessors £7.50

Provides the basic knowledge required to understand microprocessor systems. Presents a fundamental discussion of many topics in both hardware and software.

Bibbero, R. J., Microprocessors in Instruments and Control £12.45

Introduces the background elements paying particular regard to the dynamics and computational instrumentation required to accomplish real-time data processing tasks.

BASIC LANGUAGE

Albrecht, B., Basic for Home Computers
Allcock, D., Illustrating Basic
Coan, J. S., Basic Basic
Coan, J. S., Advanced Basic
Gosling, R., Beginning Basic
Kemeny, J., Basic Programming
Nagin, P., Basic with Style
Schoman, K., Basic Workbook
Sirion, D., Basic from the Ground Up

Graham, N.
Hobbyists
Haviland, M.
Building su
calculator c
Heiserman,
puters
Hilburn, J.
Software an
Complete a
gramming o
roprocessor
Klingman, M.
Outstanding
text is both
treating ove
tion device
microelectr
Korn, G. A.
Systems for
This book
applications
Lesea, A., M
Leventhal, M
Lewis, T.
tions

Bursky, Microcomputer Board Data Manual
Bursky, D., Microprocessor Data

Includes complete discription of the p
circuits, architecture, software, etc.

Duncan, Microprocessor Software Engineer
Freiberger, S., Consumers Guide to Personal Microcomputers

Frenzel, L., Getting Acquainted with Microcomputers
This is an invaluable book for those who w
about hobby and personal computing.

Gilmore, C. M., Beginners Guide to Microcomputers
Rao, G. U., Microprocessors and Microcomputers

A completely up-to-date report on the s
microprocessors and microcomputers wri
leading experts. It thoroughly analyses o
equipment including associated large
hardware and firmware.

Rony, P. H., The 8080A Bugbook: Microprocessor & Programming

The principles, concepts and applications
computer based on the 8080 microproc
emphasis is on a computer as a controller
Scelbi, 6800 Software Gourmet Guide and
Scelbi, 8080 Software Gourmet Guide and

Order from

£4.75
£2.20
£7.50
£7.50
£4.75
£6.10
£4.00
£3.70
£6.00

JAMES MARTIN BOOKS ON COMPUTER SYSTEMS

Martin J. Principles of Data-base Management £16.50
Martin J. Computer Data Base Organisation £20.00
Martin J. Security — Accuracy & Privacy in Computer Systems £20.85
Martin J Design of Man-Computer Dialogues £19.00
Martin J. System Analysis for Data Transmission £22.60
Martin J. Telecommunications and the Computer £22.30
Martin J. Design of Real-Time Computer Systems £16.50
Martin J. Programming Real-Time Computer Systems £13.85

..., Microprocessor Programming for Computer £7.00
A. P., The Compulator Book £6.20
per calculators and minicomputer hardware with chips.
D. L., Miniprocessors from Calculators to Com- £4.85
L., Microcomputers, Microprocessors, Hardware, and Applications £16.95
and practical introduction to the design, pro- operation, uses and maintenance of modern mic- ers, their integrated circuits and other components.
E., Microprocessor Systems Design £16.95
g for its information on real microprocessors, this an introduction and a detailed information source er a dozen processors, including new third genera- s. No prior knowledge of microprocessors or onics is required for the reader.
A., Microprocessor and Small Digital Computer Engineers and Scientists £19.00
covers the types languages, design software and s of microprocessors.
Microprocessor Interfacing Techniques £7.50
Intro to Microprocessors £16.70
G., Mind Appliance Home Computer Applica- £4.75

Libes, S., Small Computer Systems Handbook £5.75
The Primer written for those new to the field of personal home computers.
Lippiatt, Architecture of Small Computer Systems £4.35
Moody, R., First Book of Microcomputers £3.85
(the home computer owners best friend)
McGlynn, D. R., Microprocessors—Technology, Archite- cture & Applications £8.40
This introduction to the 'computer-on-a-chip' provides a clear explanation of the important new device. It describes the computer elements and electronic semiconductor technolo- gies that characterise microprocessors.
McMurrin, Programming Microprocessors £5.50
A practical programming guide that includes architecture arithmetic/logic operations fixed and floating point computa- tions, data exchange with peripheral devices, computers and other programming aids.
Ogden, P. H., Software Design for Microcomputers £7.00
Ogden, P. H., Microcomputer Design £7.05
Peatman, J. B., Microcomputer Based Design £19.00
This book is intended for undergraduate courses on micro- processors.
Adams, C., Beginners Guide to Computers and Micro- processors with Projects £5.60
Understanding building programming and operating your own microcomputer.

al £5.40
£5.40
processor. Support
ring £13.50
al Computing and £5.50
processors £7.10
want to know more
processors £4.75
processor Systems £20.50
state of the art of
tten by one of the
currently available
scale integration
computer Interfacing £7.60
of an 8-bit micro-
processor IV chip. The
Cookbook £7.80
Cookbook £7.80

Scelbi, Understanding Microcomputers £7.60
Gives the fundamental concepts of virtually all micro- computers.
Soucek, B., Microprocessors and Microcomputers £18.80
Here is a description of the applications programming and interfacing technique common to all microprocessors. It concentrates on detailed description of representative micro- processor families and includes explanations of digital codes, logical systems and microcomputer organisation.
Spracklen, D., Sargon £9.75
A computer chess program in Z-80 assembly language.
Tracton, 57 Practical Programs & Games in Basic £6.40
Programs for everything from Space war games to Blackjack.
Waite, M., Microcomputer Primer £6.25
Introduces the beginner, to the basic principles of the micro- computer. Discusses the five main parts of a computer— central processing unit, memory input/output interface and programs. The important characteristics of several well known microprocessors are given and a chapter is given on programming your own microcomputer.
Ward, Microprocessor/Microprogramming Handbook £6.00
Authoritative practical guide to microprocessor construction programming and applications.
Veronis, Microprocessor £12.85
Zaks, R., Introduction to Personal and Business Computing £7.50
Zaks, R., Microprocessors from Chips to Systems £7.50

● Circle No. 152

55

TECHNICAL BOOK SERVICES
PO BOX 79,
MAIDENHEAD, BERKS. SL6 2EG

A division of Strathearn
Publishing Ltd.

MICROSOLVE

If you need advice on which Microcomputer to buy WE CAN HELP YOU. We are specialists in writing packages and tailor-made software.

We are North London dealers for the best micros on the market:

APPLE II (ITT 2020) from £950 a complete business system incl. printer and software £3,500.

MICROSTAR 45 from £4,950 multi-user, multi-task, at its price there is nothing to match this new computer.

Software for APPLE II:

Payroll—Invoicing/Debtors Ledger System—Incomplete Records—Purchase Ledger System—Medical Billing/Case History—Financial Modelling—Stock Control—Schools Commerce Teaching Package—Equipment Rental System—Schools Physics Teaching Package

Software for MICROSTAR 45:

Word Processing—Payroll—Other software available on request

Come and see the computers and discuss your requirements. We promise a personal service.

H.P. or leasing terms available.

Microsolve Computer Services Ltd. 2nd Floor, 125-129 High Street, Edgware, Middx. Telephone 01-951 0218

● Circle No. 153

We Need Software

Owing to the enormous demands for software from our nationwide shops, we feel that we are in danger of re-inventing the wheel. If you have any software available for sale, licence or whatever to carry out any, and we mean *any* type of applications, then write today giving us full details. Don't miss this opportunity to sell your product to the biggest chain outside the U.S.

Contact the software manager,

THE BYTE SHOP LTD,

426-428 Cranbrook Road, Ilford, Essex

IG2 6HW

● Circle No. 154

EQUINOX 300

A powerful multi-user
multi-tasking
multi-language

16-bit microcomputer time-sharing system

supporting

- * BASIC
- * LISP
- * PASCAL
- * Floppy discs
- * Hard discs

including a powerful Text Formatter,
Assembly Language Development System
and disc-based Sort utilities.

Priced from under **£5,000**

Write or phone for further information.

EQUINOX COMPUTER SYSTEMS LTD

32-35 Featherstone Street,

London EC1Y 8QX.

(Tel: 01-253 3781/9837)

● Circle No. 155

a digitizer adds another dimension

The Bit Pad computer digitizer converts graphic information into digital form for direct entry into a computer. By touching a pen like stylus or a cursor, to any position on a drawing, diagram, photograph, or other graphic presentation, the position co-ordinates are converted to digital equivalents.

● Bit Pad interfaces with almost any micro computer.

● Bit Pad consists of a 15" sq. digitizer tablet (11" sq. active area), a stylus, and a controller cabinet.

● Bit Pad costs only £450 (excluding VAT).
Fill in the coupon and we will send you full information and details.

Terminal Display Systems Ltd., Hillside, Whitebirk Industrial Estate, Blackburn BB1 5SM, Lancs. England

Send to: Department CPPC, Terminal Display Systems Ltd., Hillside, Whitebirk Industrial Estate, Blackburn BB1 5SM, Lancs. England.

Name

Address



Microscopy
Structural
Con...
Teaching
Measuring
Menus Market
Cartographic
Orthodontics
Radiology
Structural
Process Control
Teaching
Measuring
Menus Market
Archeological
Design Geology

Work Architecture
Mechanical
Exam marking
onal research
ment Military
Geographical
Town Planning
istics Traffic
Architecture
Electrical
arking
arch
ary
al
g
e

● Circle No. 156

PRACTICAL COMPUTING April 1979



Computerising accounts

WE CONTINUE our series on business applications systems and software for micros by looking at accounting packages. Specifically, packages to handle sales accounting, purchase accounting, general and nominal ledgers, priced at anything from £12 to £950 for software, and from £950 to £6,500 for complete systems.

ACCOUNTING is the principle and technique used in establishing, maintaining and analysing the records of the financial transactions of a business. Debiting and crediting accounts in your business follow 10 simple rules:

Assets:	debit to record INCREASE credit to record decrease
Liabilities:	debit to record decrease credit to record INCREASE
Capital:	debit to record decrease credit to record INCREASE
Expenses:	debit to record INCREASE credit to record decrease
Revenue:	debit to record decrease credit to record INCREASE

Any transaction, broken into its simplest parts, will adhere to those rules.

Sales accounting

Sales accounting probably performs the most important function in a businessman's operation, other than the actual sales. Sales accounting tells him what he has sold, for how much, often to whom and when. It records the transactions of sales, the lifeblood of his business.

The sales ledger—sometimes called

"debtors ledger" and, in American-influenced accounting systems, "accounts receivable"—contains the accounts of individuals or companies owing money to your business, because you have extended credit of some kind i.e., the transaction was not made directly for cash over the counter.

The accounts may be divided alphabetically, geographically, or in some other way convenient to your business. Analysis of the sales ledger usually takes the form of "aged debt analysis"—you see who owes you what after one month, two months, and over three months, and start chasing the "over three months".

Two other ways of accounting for debtors is balance forward—payments are made against the total account regardless of the kind of item(s) purchased, like a Barclaycard statement—or open item debtors, where payment is made against individual items, either the oldest purchase or some other classification.

Using those debts owed to you to raise immediate cash is done by financing your accounts receivable, called "factoring", with someone who will lend you

money against the account collection at some future date.

Purchase accounting

In a way this is less pressing to a businessman than sales accounting because he owes the money to someone else. Nonetheless, to retain goodwill, obtain good credit terms, and retain good credit ratings, the businessman pays close attention to when, from whom he buys, and how much he pays. So, purchase accounting is the reverse, in a sense, of sales accounting but without (almost) all the fuss of analysis or ageing or carry-forwards, and so on. Purchase ledgers are sometimes called "creditors ledger" and, again, in American parlance, "accounts payable".

General ledger

To clear some confusion—and perhaps create more—a general ledger, sometimes called an "impersonal ledger", contains those transactions which are the businessman's dealings in property and items

(continued on next page)

(continued from previous page)

of expenditure—like land, buildings, rent, wages, insurance.

The place of the general ledger can sometimes be taken by a nominal ledger

(containing the nominal accounts, i.e., rent, wages, insurance, and the like) and a private ledger (containing the assets of the business and confidential matters, such as profit and loss accounts, and

balance sheet.

So what is in the marketplace to help you, the businessman, get the most from your debtors and service your creditors conveniently?

Accounts suite

Micro Software Systems, Grays, Essex. SOFTWARE is priced at £850, when supplied with a hardware system by Micro Software, or £950 on its own. Since Micro Software claims to be able to supply "the best of the machines now on the market", the total cost of a system can be from about £2,500 upwards. It is a disc-based system comprising six programs.

1. Entry—a simple security entry system requiring a password for access.
2. Menu—listing the suite's programs.
3. Invoicing—with this you can enter details of either sales or purchase invoices to the corresponding ledger.
4. Receipt—the details of money re-

ceived—either a cash or credit sale—are entered here.

5. Payment—payment details are entered here but information about payments due or outstanding invoices can be called-up.
6. Reports—only one entry is required and the system will perform the double entries and collate the information into the following:
 - a) Bank or cash book—opening balance, debit, credit, closing balance.
 - b) VAT—incoming and outgoing.
 - c) Sales ledger.
 - d) Purchase ledger.
 - e) Nominal ledger—with breakdown into expense and cost areas, with history files if required.

f) Audit trail.

- g) List of all unpaid invoices (sales or purchase).
- h) Trial balance and profit-and-loss account up to year-end.

Error-correction facilities either at input time or later are provided throughout the suite.

On a medium-sized system—say in the £3,500 to £5,000 range—about 1,000 entries per month could be handled. If more are required, a disc-filing system could be employed using a new disc for every period.

The accounts suite covers a wide range of facilities and its 'minimum entries' philosophy means less hassle and fewer errors. A company with sales in the £1-£2 million region could usefully employ it as a basic system.

Accounts receivable

A J Harding, Bexhill-on-Sea, East Sussex.

RUNNING on a Tandy TRS-80, this Level 2 software is £19.95—a Level 2 Tandy costs about £900. The system performs three sales ledger functions:

1. Initialisation, i.e. filling-up your file.

2. Maintenance—essentially this is posting payments and error-correction.

3. Analysis—it performs two kinds:
 - a) List of delinquent accounts.
 - b) Ageing report.

You can hold up to 200 records per cassette. You can have more cassettes but each cassette is a separate totality.

There are two minor drawbacks to this software which we are sure will have been corrected. The currency signs are in dollars, not sterling—the software is imported from the U.S.—and the instructions for processing from one function to the next are unclear, which can be amended by written instruction or augmenting the instructions on the tape.

Accountancy package

Compucorp Ltd, Wembley, Middlesex.

ALTHOUGH no specific limitations are indicated in the specifications we received, they indicate that double floppy disc storage is required, so about 800 to 1,500 records can be assumed held.

On-line enquiries of the files are available but the software caters for hard-copy status reports; that means you will require a printer and an audit trial printer—like on a printing calculator. The whole

system, hardware Compucor 610 and 625 Series) and software, costs about £5,000 and up.

The system uses the 'question-and-answer' technique for guiding a user through succeeding steps.

The heart of posting entries to the sales, purchase, or nominal ledgers is the unposted transactions file through which all entries pass. By using a 'posting key'—there are 15—the entry is identified and the computer then updates the correct ledger using that identification code.

A 'by-value' sales analysis can be performed using the analysis code keys in the transaction records. Extensive cash book routines keep current balances of cash-in-hand, bank balances (multiple accounts), and cash floats.

In all, there are 40 programs in the package dealing with accountancy. Additional jobs, like payroll and invoicing, can be integrated into the system. It is a comprehensive and useful system for the business with sales in the area of £2-£5 million a year.

Video-purchase and Video-debt

Video Software, Kinver, Stourbridge, West Midlands.

THIS GROUP supplies software which is machine-independent and operates with disc-based systems. VIDEO-PURCHASE costs around £300 and VIDEO-DEBT about £300, both dependent on features required—together they will be £600.

VIDEO-PURCHASE is the purchase

ledger software. It has direct keyboard entry and each transaction can be supplemented by detailed analysis lines for purchase analysis or the nominal ledger. Enquiries can give details of individual ledger accounts, including individual outstanding transactions and creditors. Outputs include open-item or balance-forward statements, purchase analysis, and so on. Options include cheque-printing, bank lists, credit transfers.

VIDEO-DEBT is the sales ledger software. It, too, has direct keyboard entry with four categories of debits and of

credits and each category can be 'simple' or 'compound'.

Like VIDEO-PURCHASE, enquiries on individual accounts or on an aged debtor list can be made. Output includes statements printed as open-item or balance forward. A useful addition to VIDEO-PURCHASE and VIDEO-DEBT on your system would be VIDEO-BOSS. It provides a link with all other VIDEO systems and supplies those required sales and purchases analyses, e.g., sales by area/customer, purchases by industry/supplier, and so on.

Horizon Business System

Equinox Computer Systems Ltd, London, EC1.

EQUINOX supplies the Horizon micro for

anywhere between £1,000 and £2,500, depending on RAM size and discs. The Horizon Business System—a Horizon with 32K, disc, monitor, and software—will cost around £4,000. The system pro-

vides management control of sales, purchase and general ledgers, payroll, and stock accounting. It uses the 'question-and-answer' technique to guide the user.

(continued on next page)

(continued from previous page)

The sales ledger program can handle 200 accounts with a total of 900 invoices; the purchase ledger program has about the same capacity. The sales ledger program holds the customers' balances as aged accounts so that 30-60; and 90-day

ageing is readily available. Facilities for additions, deletions and corrections are provided.

The purchase ledger program has all you need to operate a purchase ledger, including a cheque file which produces cheques corresponding to totals in the invoice file.

The general ledger program provides a double-entry ledger of all transactions in a given month. Up to 1,100 items can be handled on each disc. Among several facilities it provides editing of files, balances the cheque file, and provides a balance sheet and profit-and-loss statement.

Purchase ledger system and debtor ledger system

Microsolve Computer Services Ltd, Edgware, Middlesex.

THE PURCHASE ledger software costs £400 and debtor ledger software £500. A complete purchase ledger system costs about £3,400 (excluding VAT). For this, you have the software and a 48K Apple II, two floppies, a matrix printer, and monitor. The system is standard open-item ledger and guides the user through without previous computer knowledge.

The system performs the following functions.

1. Maintains suppliers' account file.
2. Maintains invoice file.
3. Processes credit notes and journal transfers.
4. Processes cash payments.
5. Produces remittance advices.
6. Prints invoices due for payment.

Maximum capacity of the purchase ledger system is 750 suppliers' accounts, 3,400 invoices and 2,500 payments and adjustments.

The debtor ledger system has an invoicing program as an integral part. Like the purchase ledger system, a complete package runs on the Apple II and costs £3,500.

The system performs the following functions:

1. Maintains a customer accounts file.
2. Maintains a products file.
3. Formats and produces invoices automatically.
4. Processes payments made by customers.
5. Produces an aged analysis of debtors.
6. Enquiries can be made as to the state of a particular account balance.

Maximum capacity is 750 customer accounts, 2,000 products, 3,400 invoices, and 2,500 payments and adjustments.

Purchase ledger and Sales ledger

Wilcox Computers Ltd, Wrexham Clywd.

THE WILCOX Series II, on which these accounting packages run, is based on a Z80 with 16K RAM, VDU, printer (140 cps), and two floppy discs with 1.2 Mbytes of storage. Series II costs £7,600 plus VAT. The purchase ledger software is £800 and sales ledger is £600.

Invoice details are keyed into the

purchase ledger system. When an invoice is paid a cheque or a credit transfer slip is produced, together with a remittance advice. The system will also accept credit notes, cash received and journal voucher entries and, retains a record of each transaction. Purchase ledger operates as an open item debtors system. For audit purposes, an audit trail is printed-out each day.

The sales ledger also uses the open-item technique. Details of all uncleared items, including the original invoice and

any subsequent transactions affecting that invoice, such as credit notes, cash and journal entries, are held on file.

The main inputs to the sales ledger package are the original invoice details and details of any subsequent cash received from customers. The main outputs are customer statements of account and an internally-used printout of the accounts. An audit trail is also provided, as are on-line enquiries. Age analysis and credit limit reports are provided.

General ledger—Hustler 1

Petsoft, Newbury, Berkshire.

THIS very general 'general ledger' package sells for £12 and runs on an 8K Pet (about £700). The program holds up to 100 data lines (entries into accounts) with an 8K memory and about 340 with an additional 8K. When the maximum capacity is reached, another block of memories can be started on new tapes—provision is made to carry-over the totals figures to

the new records, so giving continuity.

The account chequebook and bank records are the basis for the system. Each entry is coded into any of eight types of deposits, any of 27 expense accounts, or any of three non-expense withdrawal accounts.

The program operates in three modes:

1. displays all withdrawals made, all deposits made, accumulated totals.
2. all entries with a user-requested

code number are displayed line-by-line, and totalled.

3. calculates and displays, in turn, the detailed entries made for each deposit account, expense account, and non-expense withdrawal account, and totals for each account type.

The software should appeal to very small businesses. The introduction of disc storage to Pet micros will increase its attractiveness.

Bondain Book-keeper

Sumlock Bondain Ltd, London, EC1.

THIS SYSTEM is presented as a complete unit comprising a 32K Adler TA-20, two discs—providing 360K bytes and integral to the system—a VDU, and 150

cps matrix printer. With the standard software, which provides the book-keeping function, the system sells for £6,500.

The standard software consists of four packages:

1. Integrated invoicing and sales ledger suite.

2. Purchase and nominal ledger suite.

3. Payroll suite.

4. Separate stock control suite.

The cost of a standard "package" is from £350 per program, which includes initial installation and training.

Nominal ledger

Computer Mart Ltd, Norwich.

TO WORK on the Imsai 8080, the nominal ledger costs £700. It consists of six modules:

1. Set-up programs.

2. Expense codes.

3. Budgets.

4. Last year's history.

5. Daily processing.

6. Reports—include nominal listing, trial balances, profit and-loss accounts, balance sheet, account apportioning, and profit-and-loss and balance sheet histories.

Incomplete record accounting

Padmede, Odiham, Hants.

IT RUNS on a 48K Apple II with VDU,

printer, and cassette for about £3,700. With disc instead of cassette, it costs about £4,000. The cassette version can hold about 1,300 records; the disc version about 5,000.

This system is aimed at the accountant, with two objectives—to produce periodically, usually quarterly or annually, statements of accounts for the client; and

(continued on page 61)

Confused by the Microprocessor Jungle?
Looking for a learning aid and a tool to design your own Microprocessor applications?
Then all you need is

SOFTY the all in one **Development And Training Aid** with Software-Firmware Copier and Programmer

- ★ Execute programmes on TV screen by resident micro-processor programme will halt and display contents of all internal registers at set break points.
- ★ Develop your firmware on TV screen with true memory mapped hex' display with block shift, displacement calculations, insertion and deletion, byte matching and other assembler functions.
- ★ Produce your firmware with high speed on board EPROM programmer, approx 2 mins for 2708. Also handles 2704 and 2716.
- ★ Replaces monitor or debug programme.
- ★ Plus many other standard features including high speed cassette interface and user programmable function keys.
- * Universal Monitor which can be directly connected to
- ** ANY external microprocessor in system situ for firmware development (written by resident micro and executed by external micro).

SOFTY is equivalent to Development Systems costing thousands of pounds. Yet **SOFTY** only costs you for kit and full instructions—**£99.95 plus VAT**, built and tested—**£145 plus VAT** full details available on request or send cheque or PO to

VIDEOTIME PRODUCTS

56 Queens Road, Basingstoke, Hants RG21 1REA

Tel: (0256) 56417. Telex: 858747.

We welcome Barclay & Access Orders by telephone. (Trade and Export enquiries welcome).

● Circle No. 157

TRS80 SPECIALISTS

- * BUSINESS SYSTEMS ON PERMANENT DEMONSTRATION
- * TAILOR-MADE BUSINESS PROGRAMMES
- * 24hr MAINTENANCE CONTRACTS

Disc drives, printers etc at discount prices. Most popular books and magazines in stock including TRS 80 Newsletter.

SPECIAL ITEMS

RS232 interface, upper and lowercase modification, word processing packages, keyboard covers.

16k TRS80 upgrade kits with full instructions, £80.00 Minidiskettes £3.20 ea. or box of ten, £30.00

ROB*TRONICS COMPUTER CENTRE

118 Wandsworth High Street, London SW18
 Tel: 01-870 4805 Telex: 8813089 (Interprem)

Send stamped addressed envelope for list including discount book prices.

● Circle No. 158

KIM 1 New Low Price

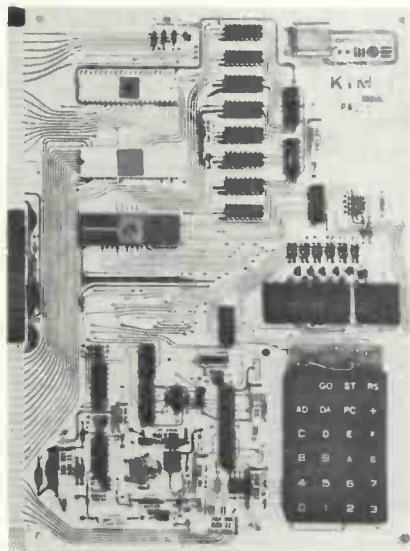

Marshall's for Microprocessors and associated components

We distribute the fabulous **KIM System** – the ready to use **microprocessor system** – a new concept in **microcomputers**. Not a kit but supplied fully tested, wired and guaranteed. Expandable memory that grows with your system – not just an evaluation kit. Starting with KIM 1 at £108.00 VAT incl. you get immediate capability which can be expanded to a complete system capable of addressing up to 65K bytes of memory.

We also stock PET and a comprehensive range of ROMS, RAMS, PROMS, EPROMS, 74LS series, 74C series, microprocessor support components, the National SC/MP Microprocessor and the MEK 6800 DII kit. In addition to these we stock an extensive range of discrete semiconductors, passive components and DIL switches, etc.

Send for details to: **MARSHALL'S ELECTRONICS** Kingsgate House, Kingsgate Place, London NW6 4TA Tel: 01-624 0805
 Retail Sales London: 40 Cricklewood Broadway, NW2 3ET. Tel: 01-452 0161/2. Telex: 21492
 London: 325 Edgware Road, W2. Tel: 01-723 4242. Glasgow: 85 West Regent Street, G2 2QD.
 Tel: 041-332 4133. Bristol: 1 Straits Parade, Fishponds Road, BS16 2LX. Tel: 0272 654201.

NEW 1979 CATALOGUE NOW AVAILABLE 50p post paid or 40p to callers.

● Circle No. 159

(continued from page 59)

to satisfy the taxman's requirements.

It is a "menu"-type system, hand-holding the user through eight options:

1. Enquiry by client name.
2. Input (from keyboard).
3. Input (from cassette tape).
4. List or amend records.
5. Save data on tape.

6. Listout on printer.
7. Profit/loss and trial balance.
8. Enter account code descriptions—in this system, the account codes are numeric, viz, 100-499 are for profit-and-loss sheet items and 500-999 are balance sheet items.

The documentation provided is good and includes a profusion of account code

descriptions—the user, of course, can name his own but, in the majority of cases, the ones shown will suffice. A prime feature of the system is that the user can key-in data directly from a bank statement—after all, the bank has done much of the sorting and accounting already—thus eliminating extraneous source documentation.

Incomplete record system

Verwood Systems, West Haddon, Northamptonshire.

ANOTHER ENTRY to the incomplete record accounting system stakes. This one runs on an SWTP 6800 with 32K RAM, a floppy disc, VDU, and a Centronics printer, all of which costs about £3,600. The software is priced at £50 when bought with the hardware.

From one entry, a transaction is reported on all the accounts to which it applies. Validation and error-correction are done on-line before transactions are posted.

The system depends on an input batch-type code to control the posting—24 are given, up to 99 can be named. A nominal account code then allows the proper slot in the nominal ledger to be accessed and a double entry made. For example, the

batch type could be "10"—sales ledger invoices and credit notes—and the nominal account code could be between 100-199—sales accounts, say, sales branch No. 1, 110.

The eight kinds of reports include profit-and-loss accounts, balance sheet, sales ledger purchase ledger, cash books, VAT analysis, nominal ledger trial balance, and sales ledger statements.

COMAC (computerised accounting)

Microcomputers Etc, Ltd, Camberley, Surrey.

THIS SYSTEM written in Basic is designed for a 48K Tandy TRS-80 with two disc drives, a VDU, and a printer (Centronics) and sells for around £1,700. Microcomputers Etc Ltd also sells the software alone for £250.

It will handle about 1,000 transactions

per month and up to 14 branches—or departments or cost centres or profit centres.

The system guides the user with a "menu", and there are six options:

1. Input.
2. Process—this option processes the input in double entries, carries forward the previous period totals and accumulates.
3. PLBAL—an acronym for the trial

profit and loss and balance sheet calculations. This is for one branch. The next option,

4. GROUP PLBAL summarises all the branches totals into the corporate totals.
5. and 6. Two editing options.

An interesting feature of COMAC is the use of alphabetic mnemonics for account codes; thus ADV is advertising expense, CAR is automobile expense, and so on. They are chosen by the user.

NAME	PROGRAMS	SUPPLIER	AVAILABLE	MACHINE	PRICE (£)
Accounts Suite	Sales Ledger Purchase Ledger Nominal Ledger	Micro Software Systems, Grays, Essex	Now	—	950 (software only)
Accounts Receivable	Sales Ledger	A J Harding Bexhill-on-Sea, Sussex	Now	TRS-80	19.95 (software only)
Accountancy Package	Sales Ledger Purchase Ledger Nominal Ledger	Compucorp, Wembley, Mdx.	Now	Compucorp 610 and 625	about 5,000
VIDEO-PURCHASE; VIDEO-DEBT	Purchase Ledger Sales Ledger	Video Software, Stourbridge, West Midlands	Now	Machine Independent	300 300 (software only)
Horizon Business System	Sales Ledger Purchase Ledger General Ledger	Equinox Computer Systems Ltd, London ECI	Now	Horizon	about 4,000
Purchase Ledger/ Debtor Ledger System	Purchase Ledger Sales Ledger	Microsolve Computer Services Ltd, Edware Middx.	Now	Apple II	about 3,400 (400 for purchase ledger s/w only, 500 for sales ledger s/w only)
Purchase Ledger and Sales Ledger	Purchase and Sales Ledger accounting	Wilcox Computers Ltd, Wrexham, Clwyd	Now		£7,600 (plus VAT) Purchase ledger £800 Sales ledger £600
General Ledger- Hustler I	General Ledger	Petsoft, Newbury, Berks.	Now	PET	about 700 (12 software only)
Bondain Bookkeeper	Sales Ledger Purchase Ledger Nominal Ledger	Sumlock Bondain, London ECI	Now	Adler TA-20	6,500 (350 per package; software only)
Nominal Ledger	Nominal Ledger	Computer Mart Ltd, Norwich	Now	Imsai 8080	700 (software only)
Incomplete Record Accounting	Incomplete Record Acctg to Trial Balance	Padmede, Odiham, Hants.	Now	Apple II	3,700 (cassette) 4,000 (disc)
Incomplete Record System	Incomplete Record Accounting	Verwood Systems, West Haddon, Northamptonshire.	Now		£3,600 hardware; software £50 when purchased with hardware.
COMAC	Incomplete Record Acctg to Trial Balance	Microcomputers Etc, Ltd, Camberley, Surrey	Now	TRS-80	1,700

XITAN SYSTEMS

Southern England stockists for **CROMEMCO**

Selected nationwide by Government departments, Research Establishments, Universities, Professional Consultants, Assurance Companies, Industry and the serious hobbyist. Features include a range of software equalled by no other manufacturer for price and performance. Fortran, Basic, Cobol, Z-80 Macro Assembler, Trace, and Word Processing, all at only £85 each. Xitan Systems can supply CP/M for use on Cromemco equipment with 8 in. floppy discs.



THE machine for professional use

XITAN SYSTEMS, 23 CUMBERLAND PLACE, SOUTHAMPTON SO1 2BB. TEL: (0703) 38740

Also suppliers of: PET * HORIZON * PT SOL * DYNABYTE MEMORY * BOOKS * VDUs * PRINTERS

● Circle No. 160

microsense computers

A Division of Data Efficiency Limited
MICROCOMPUTERS FOR BUSINESS & PLEASURE

Professional Dealers Required

We are pleased to announce that we have obtained an exclusive agency for **MICROSTAR** Computers manufactured by MICRO V CORPORATION of the U. S. A. The **MICROSTAR 45 PLUS** system is unique at its price, less than £5000, since it offers a MULTI-USER, MULTI-TASKING, FLOPPY DOS, 64k RAM, 1.2 Mb Disc (on 2 drives), BASIC, & UPDATE™ DBMS. The system has three time-sharing RS232 I/O interfaces and can also run a further background process simultaneously. CP/M DOS also available.

We invite enquiries from qualified Dealers who wish to sell **MICROSTAR** systems in specific territories in England, Scotland, Wales and Northern Ireland.

We also have certain area Distributorships for the **APPLE II based ITT 2020**, and are looking for Dealers within a thirty mile radius of Hemel Hempstead (excluding certain areas of London) and in the counties of Devon and Cornwall.

Applications should preferably be made in writing to Mike Brewer or Bill Mercer, including relevant supporting information, or they may telephone Hemel Hempstead (0442) 63561.

Finway Road, Hemel Hempstead, Herts HP2 7PS

Telex: 825554 DATEFF G

● Circle No. 161

Star Trek is a classical computer game, which may see a resurgence in popularity now that the series is being re-run on BBC 1. This version was written to give as many features as possible within the constraints of a 16K memory and an 11K BASIC. It is *Practical Computing* tested.

Star Trek

THE object of Star Trek is to destroy all the Klingon ships within 15 stardates. The galaxy is divided into 64 quadrants, with each quadrant split into 64 sections. Both are eight-by-eight grids. The galaxy is initialised with 75 stars, seven Klingons and two starbases placed randomly throughout the 64 quadrants.

A quadrant is initialised each time it is entered by the Enterprise by having the stars, Klingons or starbases assigned randomly to sectors. A sector can be occupied by only one object at a time.

You, as Captain Kirk, control 500 units of energy—for motion, phasers and defence screens—and three photon torpedoes. The two starbases are available to replenish your supplies. Each time the Enterprise enters a quadrant, any Klingon ships in the quadrant are given 100 units of energy.

You may change the computer read-out, move the Enterprise or fire either a photon torpedo or your phasers at any time. If you are in a quadrant occupied by a Klingon, he will fire on you and move each time you enter the quadrant, manoeuvre, or fire at him.

The Enterprise is, of course, well-supplied with computer power to control your weapons and defensive screens, to scan your galactic neighbourhood and to display a composite image of prior scans. Unfortunately, you have limited display capabilities and can see only your status (Figure 1) and either a short-range scan, a long-range scan or the galactic composite at any one time. This display will be updated after each manoeuvre or attack.

Commands

Six Commands are available to you:

Fire phasers. The Enterprise and the Klingon ships are armed with these pure-energy weapons. Phaser fire is countered effectively by deflector screens but each hit depletes the energy reserves of the target ship. This effect is inversely proportional to the distance between ships. You may fire as much of your remaining energy as you wish.

Fire photon torpedo. The on-board

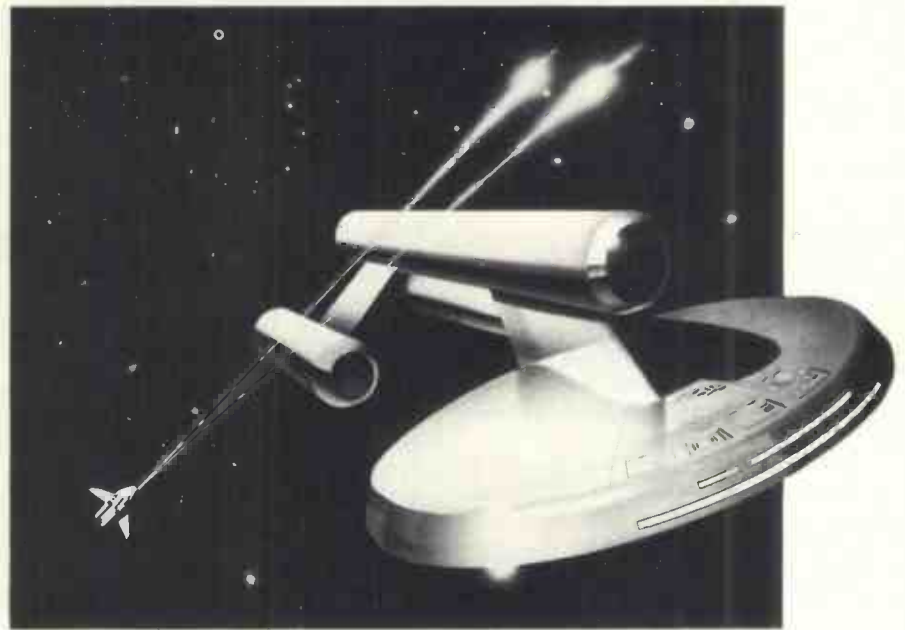

computer aims automatically at the Klingon ship and will not hit a star or starbase. Evasive action by the Klingon is more effective at longer ranges.

Move the Enterprise. The computer requests the motion vector. This is to be given in sectors horizontally and vertically. A negative entry will yield motion to the left or down.

Display short-range sensor scan. The

by Ronald Subler

objects in the quadrant you occupy are displayed with the following symbols:

< * > = Enterprise
 + + + = Klingon
 < ! > = Starbase
 * = Star.

Display long-range sensor scan. The objects in the eight quadrants adjacent to the one you occupy are displayed in the form KBS, where:

K = Klingons
 B = Starbases
 S = Stars.

Display known galaxy. The objects in all prior long-range scans are displayed in the form KBS.

Special conditions

Moving the Enterprise consumes one unit of energy for each sector moved both

horizontally and vertically. An additional 25 units and one stardate are consumed for any move which requires changing quadrants.

Docking replenishes your supplies to three photon torpedoes and 500 units of energy. This is accomplished by moving the Enterprise to one of the four sectors immediately adjacent to a starbase. You lose when a move puts you outside the galaxy; a move causes you to collide with a Klingon, starbase or star; you use up 15 stardates; or your remaining energy goes to zero.

Program

The Star Trek program contains an executive routine and three levels of sub-routines. The calling sequence, shown in Figure 2, is based on the subroutine list in Figure 3.

After deleting all comments, there are only a few bytes of memory left when running Star Trek. You may find that the REMARK statements of Figure 4 will help in understanding the program in Figure 5.

I have used the PEEK and POKE facilities to minimise storage requirements for the galaxy and quadrant maps. They are encoded and stored sequentially above the program. They are addressed relative to variables Q and S, respectively. The encoded value of a quadrant is increased by 40 when it is first scanned so that it

(continued on next page)

(continued from previous page)

will be included in the map of the known galaxy.

Customising

Five parameters are available to extend or shorten the game:

Variable	Line	Effect
BI	440	Sets the number of starbases.
EI	1330	Sets the maximum energy level of the Enterprise.
KI	480	Sets the number of Klingon ships.
K7	490	Sets the initial energy level of Klingon ships.
T	560	Sets the time limit of each game.

Adapting to other systems

This version of Star Trek was written in Polymorphic Systems A00 Basic to run on a 16K Poly-88 TM microcomputer. I have used four features which are likely to be different in other Basics:

The PRINT command can be reduced to "!" on the Poly-88.

PRINT USING is not implemented in Poly A00 Basic. Instead, the width of an integer output field is controlled with "%nI", where n is the field width.

The PLOT statement in line 400 moves the cursor to line X, column Y.

Printing the value CHR\$(12) clears the screen and places the cursor on the top line.

Figure 1 - SAMPLE CONSOLE DISPLAY

Basic status information is constantly displayed at the right side of the screen.

```

STARDATE:      3263
CONDITION:     RED
QUADRANT       6 , 6
SECTOR        6 , 6

STATUS  —  REMAINING:
KLINGONS  =   7
STARDATES =   15
STARBASES =   2
TORPEDOES =   3
ENERGY    =  500

COMMAND?
    
```

Figure 3 - SUBROUTINE LIST

100-350	Executive routine
360-380	Pause subroutine
390-810	Initialise
820-960	Phaser
970-1040	Photon torpedo
1050-1410	Move Enterprise (may go to 3540)
1420-1570	Short-range scan
1580-1890	Long-range scan
1900-2110	Display map of scanned galaxy
2120-2140	Save current quadrant counts
2150-2170	Restore current quadrant counts
2180-2510	Initialise new quadrant (second entry at 2390)
2520-2550	Blank quadrant or galaxy
2560-2630	Poke values into quadrant or galaxy
2640-2730	Decode Enterprise address and distance to Klingon
2740-2790	Convert quadrant code to S, K, B code
2800-2840	Print borders
2850-2870	Check Enterprise energy (may go to 3540)
2880-2970	Display "BOOM" (may STOP)
2980-3300	Display console
3310-3530	Klingon fire
3540-3560	Display loss
3570-3590	Display sensor scan title

Figure 4 - REMARK STATEMENTS

These have been omitted from the program listing so that the program will fit in 5,600 bytes.

REMARK STATEMENTS - 1

```

10 REM - STAR TREK - 16K POLY-88
80 REM - EXECUTIVE ROUTINE
90 REM - DO INITIALISE
105 REM - DO CONSOLE DISPLAY
145 REM - RESTORE COMMAND IF DISPLAY
151 REM
152 REM - DECODE COMMAND
153 REM 1 = FIRE PHASER
154 REM 2 = FIRE PHOTON TORPEDO
155 REM 3 = MOVE ENTERPRISE
156 REM 4 = SHORT-RANGE SCAN
157 REM 5 = LONG-RANGE SCAN
158 REM 6 = DISPLAY KNOWN GALAXY
159 REM
    
```

```

162 REM
164 REM - DO FIRE PHASER
166 REM RETURN IF NO KLINGON IN SECTOR
    
```

```

185 REM SET UP PRIOR DISPLAY, PAUSE, GO TO DECODE
    
```

```

212 REM
214 REM -- DO FIRE TORPEDO
216 REM RETURN IF NO KLINGON IN SECTOR
    
```

REMARK STATEMENTS - 2

```

235 REM SET UP PRIOR DISPLAY, PAUSE, GO TO DECODE
    
```

```

262 REM
264 REM -- DO MOVE ENTERPRISE
    
```

```

275 REM SET UP PRIOR DISPLAY, GO TO DECODE
    
```

```

293 REM
297 REM -- DO SHORT RANGE SCAN
    
```

```

313 REM
317 REM -- DO LONG RANGE SCAN
    
```

```

333 REM
337 REM -- DO DISPLAY KNOWN GALAXY
    
```

```

353 REM
357 REM -- PAUSE SUBROUTINE
    
```

```

383 REM
387 REM -- FUNCTION POSITION TO CURSOR/ BLANK
    
```

```

422 REM
425 REM -- INITIALISE SUBROUTINE
427 REM
    
```

```

615 REM BLANK QUADRANTS
    
```

```

635 REM INITIALISE STARS
    
```

```

675 REM INITIALISE STARBASES
    
```

REMARK STATEMENTS - 3

```

715 REM INITIALISE KLINGONS
    
```

```

755 REM INITIALISE STAR TREK
    
```

```

795 REM DO ESTABLISH CURRENT QUADRANT
    
```

```

812 REM
    
```

```

814 REM -- FIRE PHASER SUBROUTINE
    
```

```

816 REM
    
```

```

855 REM CHECK THAT ENTERPRISE HAS SUFFICIENT ENERGY
    
```

```

865 REM CHECK WHETHER KLINGON DESTROYED
    
```

```

885 REM KLINGON DESTROYED
    
```

```

905 REM DO KLINGON FIRE
    
```

```

922 REM
    
```

```

924 REM -- FIRE PHOTON TORPEDO SUBROUTINE
    
```

```

926 REM
    
```

```

928 REM CHECK WHETHER TORPEDOES REMAINING
    
```

```

965 REM FIRE TORPEDO
    
```

```

985 REM HIT
    
```

```

1005 REM MISS -- KLINGON FIRES
    
```

REMARK STATEMENTS - 4

```

1042 REM
1044 REM -- ENTERPRISE MOVE SUBROUTINE
1046 REM
    
```

```

1095 REM ESTABLISH NEW ENTERPRISE POSITION, ENERGY
    
```

```

1115 REM CHECK WHETHER STILL IN GALAXY
    
```

```

1155 REM HAS QUADRANT CHANGED?
    
```

```

1165 REM NEW QUADRANT
    
```

```

1185 REM ESTABLISH STARS, STARBASES, KLINGONS
    
```

```

1195 REM GET DISTANCE TO KLINGON
    
```

```

1205 REM TIME-UP?
    
```

```

1255 REM MOVE ENTERPRISE IN SECTOR, CHECK ENERGY
    
```

```

1285 REM CHECK FOR DOCKING AT STARBASE
1305 REM DOCKED. RESUPPLY ENTERPRISE, REMOVE STARBASE
    
```

```

1395 REM DO KLINGON FIRE
    
```

```

1412 REM
    
```

```

1414 REM -- SHORT-RANGE SENSOR SCAN SUBROUTINE
    
```

```

1416 REM
    
```

```

1418 REM DISPLAY TITLE
    
```

(continued on next page)

Figure 2 SUBROUTINE CALL STRUCTURE

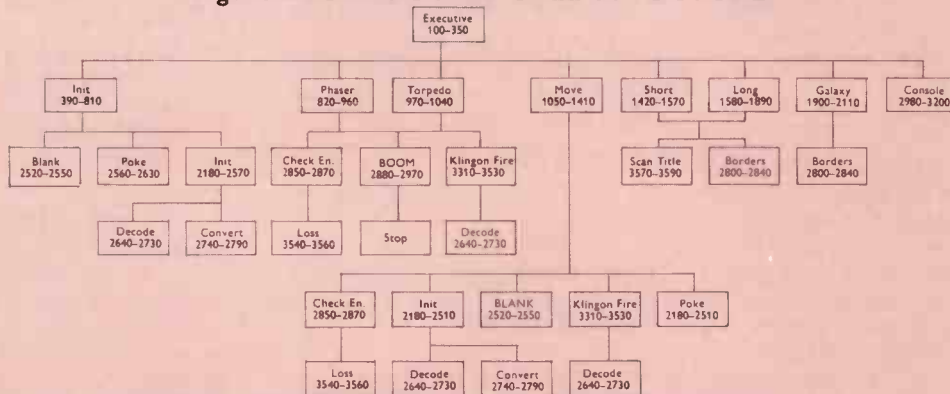

Star Trek is made up of an executive (control) routine and three levels of sub-routines.

(continued from previous page)

REMARK STATEMENTS - 5

```
1445 REM DISPLAY TOP BORDER
1475 REM LOOP TO DISPLAY ROWS OF QUADRANT
1485 REM LOOP TO DISPLAY COLUMNS OF A ROW
1505 REM PRINT LEFT BORDER
1515 REM PRINT OBJECT
1535 REM PRINT RIGHT BORDER
1555 REM DISPLAY BOTTOM BORDER
1572 REM
1574 REM -- LONG RANGE SENSOR SCAN SUBROUTINE
1576 REM
1578 REM DISPLAY TITLE
1615 REM SAVE COUNT OF STARBASES AND KLINGONS IN SECTOR
1625 REM LOOP TO DISPLAY 3 ROWS OF QUADRANTS
1635 REM SET E TO I IF QUADRANTS ARE OUT OF GALAXY
1665 REM DISPLAY ROW BORDER
1685 REM DISPLAY COLUMN BORDER
1705 REM LOOP TO DISPLAY 3 COLUMNS OF A ROW
```

REMARK STATEMENTS - 6

```
1715 REM SET B TO I IF QUADRANT IS OUT OF GALAXY
1765 REM PRINT BLANK IF QUADRANT IS OUT OF GALAXY
1785 REM PRINT QUADRANT CONTENTS AND ADD SCANNED CODE
1855 REM DISPLAY BOTTOM BORDER
1875 REM RESTORE COUNT OF STARBASES AND KLINGONS IN SECTOR
1892 REM
1894 REM -- DISPLAY OF KNOWN GALAXY SUBROUTINE
1896 REM
1898 REM DISPLAY TITLE
```

```
1925 REM DISPLAY TOP BORDER
1965 REM SAVE COUNT OF STARBASES AND KLINGONS IN SECTOR
1975 REM LOOP TO DISPLAY ROWS OF GALAXY
1985 REM PRINT ROW NUMBER
1995 REM LOOP TO DISPLAY COLUMNS IN A ROW
2005 REM PRINT COLUMN-ROW IF IT HAS BEEN PREVIOUSLY SCANNED
2055 REM PRINT ROW NUMBER
2075 REM DISPLAY BOTTOM BORDER
```

REMARK STATEMENTS - 7

```
2095 REM RESTORE COUNT OF STARBASES AND KLINGONS IN SECTOR
2112 REM
2114 REM SUBROUTINE TO SAVE COUNT OF STARBASES AND KLINGONS
2116 REM
2142 REM
2144 REM SUBROUTINE TO RESTORE COUNT OF STARBASES AND KLINGONS
2146 REM
2172 REM
2174 REM SUBROUTINE TO SET-UP QUADRANT WHEN ENTERED
2176 REM
2178 REM BLANK QUADRANT
2195 REM FIND HOW MANY STARS, STARBASES, KLINGONS
2215 REM CODE AS SCANNED
2225 REM POSITION STARS
2265 REM POSITION KLINGON
2305 REM DECODE KLINGON POSITION
2335 REM POSITION STARBASE
2375 REM DECODE STARBASE POSITION
2395 REM POSITION ENTERPRISE AND CHECK FOR COLLISION
```

REMARK STATEMENTS - 8

```
2512 REM
2514 REM SUBROUTINE TO BLANK QUADRANT OR GALAXY
2516 REM
```

```
2552 REM
2554 REM SUBROUTINE FOR RANDOMLY PLACING OBJECTS
2556 REM
2632 REM
2634 REM SUBROUTINE TO DECIDE ENTERPRISE POSITION AND DISTANCE
2636 REM TO KLINGON
2732 REM
2734 REM SUBROUTINE TO DECODE QUADRANT CODE INTO
2736 REM COUNT OF STARS, KLINGONS, STARBASES
2738 REM
2792 REM
2794 REM GENERAL SUBROUTINE TO PRINT BORDERS
2796 REM
2842 REM
2844 REM SUBROUTINE TO CHECK ENTERPRISE ENERGY LEVEL
2846 REM
2872 REM
2874 REM SUBROUTINE TO ELIMINATE DESTROYED KLINGON
2876 REM
```

REMARK STATEMENTS - 9

```
2972 REM
2974 REM SUBROUTINE TO DISPLAY STATUS CONSOLE AT
2976 REM RIGHT OF SCREEN
2978 REM
3302 REM
3304 REM SUBROUTINE FOR FIRE AND MOVE BY KLINGON
3306 REM
3308 REM KLINGON FIRES 20% OF AVAILABLE ENERGY
3315 REM KLINGON ENERGY REDUCED FOR MOVE AND FIRING
3335 REM REDUCE ENTERPRISE ENERGY
3375 REM MOVE KLINGON UP TO 2 COLUMNS
3435 REM MOVE KLINGON UP TO 2 ROWS
3532 REM
3534 REM END-OF-GAME, LOSS
3536 REM
3562 REM
3564 REM SUBROUTINE TO PRINT SENSOR SCAN TITLE
3566 REM
```

>LIST

```
100 GOSUB 390
110 GOSUB 2980
120 INPUT "COMMAND?",C
130 IF C<1 THEN 110
140 IF C>6 THEN 110
150 IF C>3 THEN M=C
160 ON C GOTO 170,
    220,270,300,320,340
170 IF K2=0 THEN 120
180 GOSUB 820
190 C=M
200 GOSUB 360
210 GOTO 160
220 IF K2=0 THEN 120
230 GOSUB 930
240 C=M
250 GOSUB 360
260 GOTO 160
270 GOSUB 1050
280 C=M
290 GOTO 160
300 GOSUB 1420
310 GOTO 110
320 GOSUB 1580
330 GOTO 110
340 GOSUB 1920
350 GOTO 110
360 Z=TIME(0)
370 Z=TIME(1)
380 IF Z<T8*T9
    THEN 370 ELSE RETURN
390 DEF FNZ(X,Y)
400 PLOT Y*2,(X-1)*3,2
```

```
410 RETURNX
420 FNEND
430 DIM D$(15)
440 B1=2
450 D$="" * >!<++++<*>""
460 B9=10
470 E=51
480 K1=7
490 K7=100
500 K9=20
510 M=4
520 J=24176
530 S=24240
540 S1=75
550 S9=1
560 T=15
570 T8=4
580 T9=50
590 W=35
600 B=RND(TIME(0)/65536)
610 !CHR$(12)
620 B=J
630 GOSUB 2520
640 N=S1
650 V=S9
660 L=10
670 GOSUB 2560
680 N=B1
690 V=B9
700 L=20
710 GOSUB 2560
720 N=K1
730 V=K9
740 L=40
750 GOSUB 2560
```

```
760 E1=500
770 E2=3
780 E0=INT(4096*RND(0))
790 GOSUB 2640
800 GOSUB 2180
810 RETURN
820 Z=FNZ(2,W)
830 INPUT "FIRE?",C
840 IF C<1 THEN RETURN
850 E1=E1-C
860 GOSUB 2850
870 K5=K5-C/R
880 IF K5>0 THEN 910
890 GOSUB 2880
900 RETURN
910 GOSUB 3310
920 RETURN
930 IF E2>0 THEN 970
940 Z=FNZ(2,W)
950 !"NO MORE TORPEDOES",
960 RETURN
970 E2=E2-1
980 IF R>15*RND(0) THEN 1010
990 GOSUB 2880
1000 RETURN
1010 Z=FNZ(2,W)
1020 !"YOU MISSED!",
1030 GOSUB 3310
1040 RETURN
1050 Z=FNZ(2,W)
1060 INPUT "VECTOR? ",X,Y
1070 S1=S0
1080 Q1=Q0
1090 E0=E0+X+64*Y
1100 GOSUB 2640
```

(continued on page 67)

GAMES GAMES

GAME CASSETTES IN BASIC
(suitable for PET etc.)

- TORPEDO RUN**—Solo simulation of the destruction of the Death Star. Out-maneuvre and battle, tie fighters until the vent comes into range. Drop your Photon torpedo and the Death Star explodes. Full graphics. £8-00
- FINAL FRONTIER**—Solo Star Trek adventure combining functions on most other Star Trek games. Multiple-choice command including built-in range-finding computer. Nice graphics. Can be replayed instantly £8-00
- YAM**—(Yahtzee) Classic dice game using 5 dice. 2 versions on one tape: 1 for up to 6 players; one for up to 4 players with 4 columns each £6-00
- PONTOON**—Solo version of the well-known card game. Good graphics; betting facility; Splitting and Burning possible. . . . £5-00
- MAN-EATER**—Surround and capture the shark before he chomps your swimmers. Skillful game of deduction, with graphics . . . £4-00

COMPUTER GAMES & BOOKS

- BASIC COMPUTER GAMES**—101 games in Basic. Microcomputer edition £5-50
- CREATIVE COMPUTING MAGAZINE**—Games, puzzles, projects, fiction, articles, humour, cybernetics, building info and more. Sample copy £1-50
- BEST OF CREATIVE COMPUTING Vo. 1**—328pp compendium. £6-95
- BEST OF CREATIVE COMPUTING Vo. 2**—328pp compendium. £6-95
- BEST OF BYTE**—Taken from first 12 issues of 'Byte' mag. Theory, applications, speculations, projects, software systems etc. 384pp £8-95

SCIENCE FICTION & FANTASY BOARD & TABLE GAMES

We are specialists in the rapidly-expanding Science Fiction Games hobby. For our illustrated games catalogue, introductory literature and illustrated miniature figures lists send 30p in stamps + a large SSAE.

All prices include postage and packing (UK only)
TRADE ENQUIRIES WELCOME

Games Workshop, 1 Dalling Rd, London W6 01-741 3445

Games GAMES

● Circle No. 162

dams
Computer Division

PET 24k EXPANSION £ 3 2 0

PET PERIPHERALS

24K Expansion

Internal expansion is here, now at £320 + VAT for 24K (to give 32K). Easily fitted with full instructions.

FLOPPY DISK for Pet. Twin 80K mini drive £840 (complete with dual density prom to give 320K, when available). Adds 16 extra commands to Pet.

INTERNAL RS232 INTERFACE for Pet (upper and lower case) £59

EXTERNAL RS232 INTERFACE with power supply and 'print using' function. £89

JOYSTICK (including software) £25

PAGE PRINTER INTERFACE (for 20m.a. loop) £25

625 VIDEO ADAPTOR (for TV or Monitor) £25

PET 2001 8K—£550

PET PRINTER 2020—£425

PET 2nd CASSETTE—£55

We also supply:

APPLE II, & DISK, KIM, OHIO, and T.E.I.

Also Petsoft, CBM and DAMS Software.

e.g. DAMS RENUMBER (m/c code routine rennumbers GOTOS & GOSUBS etc, very fast) £6

TIM 1-5 (vastly improved Terminal Interface Monitor) £4

DOUBLE DENSITY (4000pt. plot, 80 X 50 on Pet) £4

Send for our comprehensive software and hardware catalogues.

Add 8% VAT to all prices.

P & P 50p per order.

5% discount for orders over £400 (exclusive VAT) C.W.O.

Computer Division D.A.M.S. (Office Equip) Ltd.

30/36 Dale Street, Liverpool, L2 5SF

Sales: 051-227-3301 10 lines

● Circle No. 163

Mind your own business . . .

... with a Bondain Book-keeper.

The Bondain Book-keeper brings big business benefits without breaking budgets.

Whatever your problem we've got a complete solution you can afford.

The Bondain Book-keeper includes complete systems for Stock-Control, Invoicing, Sales Ledgers, Statement Preparation, Debt Dating, Purchase and Nominal Ledgers.



Total cost
under £2000
a year.

Head Office:
Sumlock-Anita House
15 Clerkenwell Close
London EC1R 0AA.
Tel: 01-253 2447/8
Telex: 299844

SUMLOCK



BONDAIN

● Circle No. 164

(continued from page 65)

```

1110 E1=E1-ABS(X)-ABS(Y)
1120 IF X0<0 THEN 1240
1130 IF X0>63 THEN 1240
1140 IF Y0<0 THEN 1240
1150 IF Y0>63 THEN 1240
1160 IF Q0=Q1 THEN 1260
1170 E1=E1-25
1180 T=T-1
1190 GOSUB 2180
1200 GOSUB 2640
1210 IF T>0 THEN 1280
1220 C$="TIME"
1230 GOTO 3540
1240 C$="GALAXY"
1250 GOTO 3540
1260 POKE S+S1,0
1270 GOSUB 2390
1280 GOSUB 2650
1290 IF B2=0 THEN 1400
1300 IF ABS(X6-X2)+ABS
(Y6-Y2)<>1 THEN 1400
1310 Z=FNZ(2,W)
1320 !"-DOCKED-"
1330 E1=500
1340 E2=3
1350 B1=B1-1
1360 B2=0
1370 POKE Q+Q0,PEEK(Q+Q0)-10
1380 POKE S+X6+8*Y6,0
1390 GOTO 1410
1400 IF K2>0 THEN GOSUB 3310
1410 RETURN
1420 C$="SHORT"
1430 !CHR$(12)
1440 GOSUB 3570
1450 C$="+----"
1460 N=8
1470 GOSUB 2800
1480 FOR Y=7 TO 0 STEP -1
1490 FOR X=0 TO 7
1500 P=3*PEEK(S+X+8*Y)+1
1510 IF X=0 THEN !"!", ELSE !" ",
1520 !DS(P,P+2),
1530 NEXT X
1540 !"!"
1550 NEXT Y
1560 GOSUB 2800
1570 RETURN
1580 C$="LONG"
1590 !CHR$(12)
1600 GOSUB 3570
1610 N=3
1620 GOSUB 2120
1630 FOR Y=Y1+1 TO Y1-1 STEP -1
1640 Z=0
1650 IF Y<0 THEN Z=1
1660 IF Y>7 THEN Z=1
1670 C$="+-----"
1680 GOSUB 2800
1690 C$="!"
1700 GOSUB 2800
1710 FOR X=X1-1 TO X1+1
1720 B=0
1730 IF A<0 THEN B=1
1740 IF A>7 THEN B=1
1750 IF Z<>0 THEN 1770
1760 IF B=0 THEN 1790
1770 !C$,
1780 GOTO 1830
1790 Q9=X+8*Y
1800 GOSUB 2740
1810 POKE Q+Q9,C9+40
1820 !"!",K2,B2,S2,
1830 NEXT X
1840 !"!"
1850 NEXT Y
1860 C$="+-----"
1870 GOSUB 2800
1880 GOSUB 2150
1890 RETURN
1900 !CHR$(12)
1910 !TAB(20),"GALACTIC MAP"
1920 !
1930 !"-",
1940 C$=" ---"
1950 N=8
1960 GOSUB 2800
1970 GOSUB 2120
1980 FOR Y=7 TO 0 STEP -1
1990 !X1,Y,
2000 FOR X=0 TO 7
2010 Q9=X+8*Y
2020 GOSUB 2740
2030 P=PEEK(Q+Q9)
2040 IF P>39 THEN !X21,K2,X1,
B2,X11,S2,ELSE!" ",
2050 NEXT X
2060 !X1,Y
2070 NEXT Y
2080 !"-",
2090 GOSUB 2800
2100 GOSUB 2150
2110 RETURN
2120 B8=B2
2130 K8=K2
2140 RETURN
2150 B2=B8
2160 K2=K8
2170 RETURN
2180 B=S
2190 GOSUB 2520
2200 Q9=Q0
2210 GOSUB 2740
2220 POKE Q+Q9,C9+40
2230 N=S2
2240 V=1
2250 L=2
2260 GOSUB 2560
2270 N=K2
2280 V=3
2290 L=4
2300 GOSUB 2560
2310 K5=K7
2320 Y5=INT(1/8)
2330 X5=1-8*Y5
2340 N=B2
2350 V=2
2360 L=3
2370 GOSUB 2560
2380 Y6=INT(1/8)
2390 X6=1-8*Y6
2400 P=PEEK(S+S0)
2410 POKE S+S0,4
2420 IF P=0 THEN RETURN
2430 IF P=4 THEN RETURN
2440 Z=FNZ(2,W)
2450 !"*** COLLISION WITH A ",
2460 IF P=1 THEN !"STAR",
2470 IF P=2 THEN !"STARBASE",
2480 IF P=3 THEN !"KLINGON",
2490 !" ***"
2500 IF P=3 THEN K1=K1-1
2510 STOP
2520 FOR K=0 TO 63
2530 POKE B+K,0
2540 NEXT K
2550 RETURN
2560 IF N=0 THEN RETURN
2570 FOR K=1 TO N
2580 I=INT(64*RD(0))
2590 P=PEEK(B+1)
2600 IF P+V=L THEN 2500
2610 POKE B+I,P+V
2620 NEXT K
2630 RETURN
2640 Y0=INT(E0/64)
2650 X0=E0-64*Y0
2660 Y1=INT(Y0/8)
2670 X1=INT(X0/8)
2680 Y2=Y0-8*Y1
2690 X2=X0-8*X1
2700 Q0=X1+8*Y1
2710 S0=X2+8*Y2
2720 R=ABS(X5-X2)+ABS(Y5-Y2)
2730 RETURN
2740 C9=PEEK(Q+Q9)
2750 IF C9>39 THEN C9=C9-40
2760 S2=C9-10*INT(C9/10)
2770 K2=INT(C9/20)
2780 B2=INT((C9-S2-20*K2)/10)
2790 RETURN
2800 FOR J=1 TO N
2810 !C$,
2820 NEXT J
2830 !C$(1,1)
2840 RETURN
2850 IF E1>0 THEN RETURN
2860 C$="ENERGY"
2870 GOTO 3540
2880 Z=FNZ(2,35)
2890 !"***BOOM***"
2900 K1=K1-1
2910 K2=K2-1
2920 POKE Q+Q0,PEEK(Q+Q0)-20
2930 POKE S+X5+8*Y5,0
2940 IF K1>0 THEN RETURN
2950 Z=FNZ(2,0)
2960 !"MISSION ACCOMPLISHED"
2970 STOP
2980 IF K2=0 THEN C$="GREEN"
ELSE C$=" RED"
2990 Z=FNZ(15,W)
3000 !"STARDATE: ",3278-T,
3010 Z=FNZ(15,E)
3020 Z=FNZ(14,W)
3030 !"CONDITION: ",C$,
3040 Z=FNZ(14,E)
3050 Z=FNZ(13,W)
3060 !"QUADRANT ",X1," ",Y1,
3070 Z=FNZ(13,E)
3080 Z=FNZ(12,W)
3090 !"SECTOR ",X2," ",Y2,
3100 Z=FNZ(12,E)
3110 Z=FNZ(10,W)
3120 !"STATUS - REMAINING:",
3130 Z=FNZ(10,S4)
3140 Z=FNZ(9,W)
3150 !"KLINGONS =",Z61,K1,
3160 Z=FNZ(9,E)
3170 Z=FNZ(8,W)
3180 !"STARDATES=",Z61,T,
3190 Z=FNZ(8,E)
3200 Z=FNZ(7,W)
3210 !"STARBASES=",Z61,B1,
3220 Z=FNZ(7,E)
3230 Z=FNZ(6,W)
3240 !"TORPEDES=",Z61,E2,
3250 Z=FNZ(6,E)
3260 Z=FNZ(5,W)
3270 !"ENERGY =",Z61,INT(E1),
3280 Z=FNZ(5,E)
3290 Z=FNZ(3,W)
3300 RETURN
3310 B=K5/5
3320 K5=K5-B-4
3330 IF K5<0 THEN K5=.1
3340 E1=E1-B/R
3350 Z=FNZ(2,0)
3360 POKES+X5+8*Y5,0
3370 !B/R," UNITS OF
PHASEK DAMAGE"
3380 B=X5+INT(5*RD(0)-2)
3400 IF B<0 THEN 3380
3410 IF B>7 THEN 3380
3420 IF PEEK(S+B+8*Y5)<>0 THEN 3380
3430 X5=B
3440 B=INT(5*RD(0)-2)+Y5
3460 IF B<0 THEN 3440
3470 IF B>7 THEN 3440
3480 IF PEEK(S+X5+8*B)<>0 THEN 3440
3490 Y5=B
3500 POKES+X5+8*Y5,3
3510 GOSUB 2640
3520 GOSUB 2850
3530 RETURN
3540 !"-- OUT OF ",C$, " --"
3550 !"YOU LEFT",K1," KLINGONS"
3560 STOP
3570 !C$," RANGE SENSOR SCAN"
3580 !
3590 RETURN
>=?

```

NEW BESTSELLERS



INTRODUCTION TO PERSONAL AND BUSINESS COMPUTING
By Rodney Zaks, 250 pp, ref C200 £ 4.9

NEW. For the beginner. How to use and purchase a system, from the microcomputer box to the peripherals. Why. Business requirements. How to fail. Programming. Which BASIC?

NOW ALSO AVAILABLE ON CASSETTES - 3 hrs, ref S10 £ 11



MICROPROCESSORS: from chips to systems
By Rodney Zaks, 416 pp, ref C201 £ 7.5

USED WORLDWIDE AS UNIVERSITY TEXT. A comprehensive, yet detailed and clear introduction to all aspects of microprocessors. How they work. The ROM, RAM, PIO, UART. How to interconnect. System development.

MICROPROCESSOR LEXICON, acronyms and definitions, ref X1, 112 pp £ 1.5



PROGRAMMING MICROCOMPUTERS: 6502
By Rodney Zaks, 250 pp, ref C202, £ 7.5

NEW. How to program microprocessors, with 6502 examples: arithmetic, input-output, peripherals, Interrupts. An educational text requiring no prior programming knowledge, yet useful to those wanting to learn about specific programming techniques. Applicable to PET, KIM, VIM, APPLE.

MICROPROCESSOR INTERFACING TECHNIQUES
By Austin Lesea and Rodney Zaks, 416 pp, ref C207, £ 7.5

ALSO USED WORLDWIDE AS UNIVERSITY TEXT. How to connect to all the usual peripherals, from keyboard to floppy disk, including A/D, displays, standard busses (RS232, S100, IEEE 488) and dynamic RAMs.

SELF STUDY COURSES, includes book and cassettes ask for our free catalogue.

TO ORDER
Send your order to SYBEX Europe price includes postage and packing.

USA



EUROPE

SYBEX Europe, 14-18, rue Planchat
75020 PARIS FRANCE

TÉL. : (1) 370-32-75

NAME

COMPANY

POSITION

ADDRESS

X1

C200

C201

C202

C207

PAYMENT ENCLOSED

FREE CATALOGUE



● Circle No. 165

SMALL SYSTEMS ENGINEERING LTD.

(Incorporating R. BAILEY ASSOCIATES)

62 New Cavendish Street, London W1M 7LD, Tel: 01-637 0777, Telex: 8813085 Abacus

THE LARGEST SUPPLIER OF PET MEMORY BOARDS AND INTERFACES IN EUROPE

PET MEMORY BOARDS

Sole official U.K. Agent for PME memory boards.

We provide approved technical back-up, up-grade and service facilities for these boards in the U.K.

Internally mounting memory boards available in 2 configurations;
—24K... £412.50 —32K... £475

IEEE-488/RS232C SERIAL INTERFACE

—Full IEEE address decoding, RS232C or 20mA loop output,
—Switch selectable Baud Rate, Crystal controlled Baud Rate timing,
—Boxed units complete with connectors, full operating instructions and sample programs supplied
—Serial Interface B, input and output... £186
—Serial Interface A, output only... £106
—Lower Case Printing option... £10

IEEE-488/CENTRONICS TYPE PARALLEL INTERFACE

Low cost unit without IEEE address decoding.
Also suitable for Anadex DP-8000 Printer... £45

ANALOG INPUT/OUTPUT

—IEEE-488, 16 Channel, 8BIT A-D... Price to be announced
—IEEE-488, 16 Channel, 8BIT D-1... Price to be announced

CUSTOM INTERFACE DESIGN

Interfaces designed for special applications. Interfaces supplied so far include Analog Input/output, XY plotter, stepper motor control.

PET INTELLIGENT TERMINAL SOFTWARE PACKAGE

A software package which, in conjunction with an Interface B enables the PET to operate as an intelligent terminal. The software implements full IBM or DEC protocols... £100

TV/VIDEO MONITOR INTERFACES

—Video Monitor output only... £29.50
—Video and UHF output (plugs into aerial socket of domestic TV)... £35

IEEE-488 TELEX PUNCH AND INTERFACE

—50 chars/sec. Telex punch... Price to be announced

OHIO SCIENTIFIC

Small Systems Engineering is an official distributor for OHIO SCIENTIFIC products including:

CHALLENGER I (available March 79)

—Superboard II 4K computer on a board... £298
—CIP 4K Superboard in case and power supply... £415
—CIP MF 16K CIP with mini-floppy and OS-65D V3.0... £1,235

CHALLENGER II

—C2-4P 4K "professional portable" computer... £620
—C2-4P MF 20K C2-4P with mini-floppy and OS-65D V3... £1,595
—C2-8P 4K mainframe class personal computer... £825
—C2-8P DF 32K dual 8" floppy personal/business system... £2,670

The **SUPERBOARD II** includes 8K BASIC in ROM up to 8K of RAM on board, full keyboard, cassette interface and video display interface. The **CHALLENGER C2-4P M4** includes 20K of RAM, 1 mini-floppy drive, full keyboard and TV monitor, software supplied. Includes:

- Business disk,
- Education disk,
- Personal disk,
- Games disk,
- OS-65D V3.0 program development disk

BASIC and assembler run under the OS-65D V3.0 disk operating system. All systems supplied with full documentation.

Also available:

COMPU COLOUR II MODEL 3

- 13" 8-colour CRT, 8080 Microprocessor,
- 16K extended disk BASIC in ROM,
- 71-Key detached keyboard,
- 8K RAM memory for user programs,
- 64 characters per line by 32 lines per page,
- Special graphics package with 128 x 128 point plotting,
- Built-in mini-floppy disk drive,
- 50 pin bus,
- RS-232 I/O port for serial printers, etc... £1,248-70

TERMS: All prices EX. VAT. All orders C.W.O. Cheques should be made payable to SMALL SYSTEMS ENGINEERING LTD. Orders should include £2.50 P&P per unit. All goods supplied under 90 days warranty.

● Circle No. 166

PRACTICAL COMPUTING April 1979

ILLUSTRATING BASIC

(A SIMPLE PROGRAMMING LANGUAGE)

WE CONTINUE our series of articles on how to program in Basic, probably the most widely-used programming language for small computers.

For the series, we have obtained the serialisation rights for one of the best books on the subject, *Illustrating Basic* by Donald Alcock.

★

Each month, we are publishing a part of the book, so by the end of the series you will have the complete book.

It is written with a distinct informality and has a rather unusual presentation; but it is this style, we believe, which makes it one of the most easy to read tutorials.

★

Alcock *Illustrating Basic*. Chapter 2. © Cambridge University Press. Reprinted by permission.

★

CONTENTS

PREFACE

1. COMPONENTS OF THE LANGUAGE 2

2. INPUT & OUTPUT, EXPRESSIONS AND FUNCTIONS 15

3. CONTROL 39

4. ARRAYS 59

CONTINUED FROM LAST MONTH

CHAINS ≈ USE OF SUBSCRIPTS IN "LIST PROCESSING" 68
BREAKDOWNS OF POPULATIONS ≈ ANOTHER EXAMPLE 72

5. MATRICES 75

MATRICES ≈ DON'T RUN AWAY; THEY ARE ONLY ARRAYS 76

REPLACEMENT ≈ A WHOLE MATRIX AT A TIME 78

RE-DIMENSIONING ≈ MATRICES EXPAND & SHRINK 79

CHAPTER 5 TO BE CONTINUED NEXT MONTH

6. COMPLETE EXAMPLE PROGRAMS 101

7. COMMANDS AND SIGNING ON 111

8. FILES OF DATA 119

9. SYNTAX 127

INDEX 132

C A I N S

CHAINS ILLUSTRATE THE USEFULNESS OF SUBSCRIPTS. THE MANIPULATION OF CHAINS IS CALLED LIST PROCESSING.

THE SIMPLEST KIND OF CHAIN IS ILLUSTRATED BELOW. IT HAS A HEAD IN THE FORM OF A SIMPLE VARIABLE, H. THIS STORES A POINTER POINTING TO THE FIRST ROW OF INFORMATION SOMEWHERE IN ARRAY A(,) POINTING ALSO TO A LINK CONTAINING ANOTHER POINTER POINTING TO THE NEXT ROW OF INFORMATION IN A(,). THE LAST LINK IN THE CHAIN CONTAINS A ZERO SAYING "END OF CHAIN".

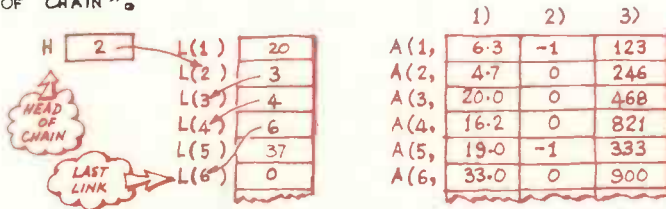

THE FOLLOWING PIECE OF PROGRAM WOULD PRINT INFORMATION IN A(,) ORGANISED BY THE CHAIN WITH HEAD H HOWEVER LONG THE CHAIN.

```

155 LET R = H
160 IF R = 0 THEN 180
185 PRINT A(R,1); A(R,2); A(R,3)
170 LET R = L(R)
175 GO TO 160
180 END
RUN
4.7 0 246
20 0 468
16.2 0 821
33 0 900
    
```

← PICK UP NEXT LINK

THE CLAREST WAY TO DRAW A CHAIN IS TO HOLD THE HEAD IN ONE HAND, THE LAST LINK IN THE OTHER, AND PULL TIGHT. THE CHAIN ILLUSTRATED ABOVE NOW LOOKS LIKE THIS:



WE USE THIS MODEL TO EXPLAIN SOME OPERATIONS ON CHAINS.

A NEW ROW OF A(,) MAY BE LINKED INTO THE CHAIN LIKE THIS:

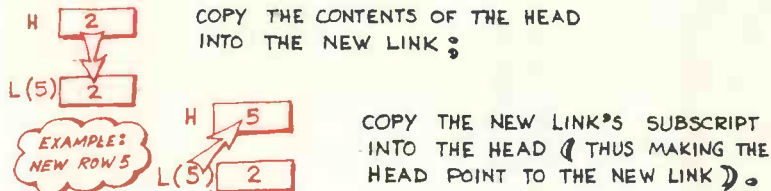

RESULT:

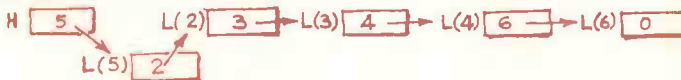

THE FOLLOWING SUBROUTINE LINKS ROW N INTO A CHAIN STORED IN VECTOR L() AND HEAD IN VARIABLE H:

```

100 REM LINK ROW N TO CHAIN L() HEAD H
110 LET L(N) = H
120 LET H = N
130 RETURN
  
```

SO LINKING ROW 5 TO THE CHAIN (PICTURED ABOVE) CAN BE DONE VERY SIMPLY LIKE THIS:

```

1055 LET N = 5
1060 GO SUB 100
1065
  
```

AND CREATING A NEW CHAIN TO LINK, SAY, THE FIRST 10 ROWS LIKE THIS:

```

2125 LET H = 0 ← BEGIN WITH EMPTY CHAIN
2130 FOR N = 1 TO 10
2135 GO SUB 100
2140 NEXT N
  
```

NOTICE THE LAST ROW TO BE LINKED TO A CHAIN IN THIS WAY IS THE FIRST TO BE PRINTED BY THE ROUTINE OPPOSITE. THUS THE MECHANISM MAY BE USED TO ORGANIZE A STACK OF THE KIND DESCRIBED ON PAGE 54. TAKING AN ELEMENT FROM THE TOP OF THE STACK MAY BE DONE LIKE THIS:

```

3260 LET R = H ← REMEMBER THE ROW OF THE ELEMENT
3265 LET H = L(H) ← DISCARD TOP LINK
  
```

CHAINS (CONTINUED)

IT MAKES FOR TIDIER PROGRAMS TO STORE HEADS OF CHAINS IN THE SAME VECTOR AS THE LINKS. THIS WASTES A FEW STORAGE LOCATIONS (AS SHOWN BELOW) BUT YOU MAY REGAIN THE SPACE BY OFFSETTING THE CHAIN FROM ITS INFORMATION AT THE EXPENSE OF MORE COMPLICATED SUBSCRIPTS IF YOU WISH.

MORE THAN ONE CHAIN CAN EXIST IN THE SAME VECTOR AS LONG AS THE ROWS BEING LINKED ARE MUTUALLY EXCLUSIVE (i.e. NO LINK CAN BE IN MORE THAN ONE CHAIN). THE SUBROUTINE BELOW LINKS WOMEN INTO ONE CHAIN AND MEN INTO ANOTHER. THE HEADS OF BOTH CHAINS ARE AT THE TOP OF THE VECTOR STORING BOTH CHAINS.

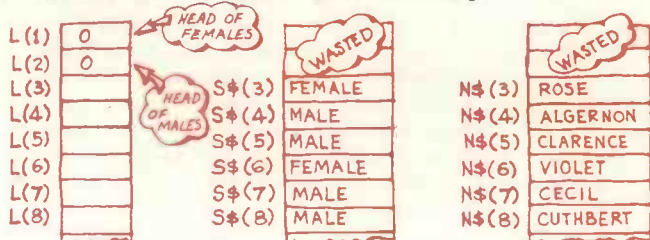

```

1000 REM LINK INTERTWINED CHAINS; N PEOPLE
1010 LET L(1)=0
1020 LET L(2)=0
1030 FOR I=3 TO N+2
1040 LET Q=1
1050 IF S$(I) = "FEMALE" THEN 1070
1060 LET Q=2
1070 LET L(I) = L(Q)
1080 LET L(Q) = I
1090 NEXT I
1100 RETURN
  
```

NOT RIGOROUSLY CHECKED: ANYONE NOT DECLARED FEMALE IS TREATED AS MALE

IN THE SORTING PROGRAM ON PAGE 66 WE EXCHANGED ITEMS OF DATA. WITH CHAINED LISTS, HOWEVER, IT IS ONLY NECESSARY TO EXCHANGE LINKS WHEN SORTING. CONSIDER THIS SHORT LENGTH OF CHAIN:



TO EFFECTIVELY SWOP ROWS 7 & 3 OF THE ARRAY ASSOCIATED WITH THIS CHAIN YOU NEED ONLY SHUNT THREE POINTERS AROUND THE LINKS AS ILLUSTRATED OPPOSITE.

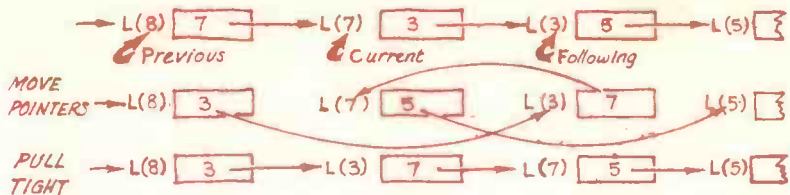

THE SUBROUTINE BELOW USES THE SAME LOGIC AS THE PROGRAM ON PAGE 67 THE RIPPLE SORT BUT WHENEVER IT HAS TO SWOP ROWS IT MOVES POINTERS IN THE MANNER ILLUSTRATED ABOVE. THE LOGIC FOR THIS IS ON LINES 2100 TO 2130, WHERE:

P IS A SUBSCRIPT FOR THE PREVIOUS LINK,
 C IS A SUBSCRIPT FOR THE CURRENT LINK,
 F IS A SUBSCRIPT FOR THE FOLLOWING LINK.

ALL AS SHOWN IN THE PICTURE ABOVE. AFTER A SWOP, C IS NO LONGER THE CURRENT SUBSCRIPT; IT IS ALTERED AT LINE 2140.

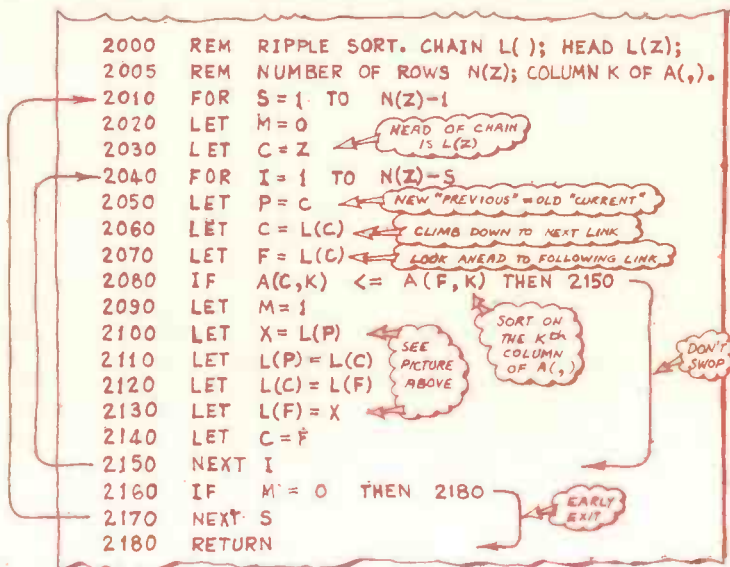

OTHER DIFFERENCES FROM THE PROGRAM ON PAGE 67 ARE NOT CONCERNED WITH THE LOGIC OF SORTING. THE ROUTINE ABOVE CAN USE ANY CHAIN STORED IN L() BEING TOLD A VALUE OF Z; THE HEAD OF THE REQUIRED CHAIN IS THEN L(Z) AND THE NUMBER OF ITEMS IS IN N(Z). FURTHERMORE THE ROUTINE ABOVE CAN SORT ANY COLUMN OF ARRAY A(,) BEING TOLD THE NUMBER OF THAT COLUMN IN K.

BREAKDOWNS

AN EXAMPLE

USING THE SIMPLE LIST
PROCESSING TECHNIQUES
JUST DESCRIBED.

THE TYPICAL "MANAGEMENT REPORTING" PROGRAM DEALS WITH "POPULATIONS BROKEN DOWN BY AGE, RELIGION AND SEX". THE FOLLOWING PROGRAM IS A GHASTLY PARODY OF THE REAL THING BUT SERVES TO ILLUSTRATE A FEW OF THE TECHNIQUES AT THE HEART OF BUSINESS DATA PROCESSING. THE PROGRAM SORTS DIFFERENT COLUMNS OF NUMBERS. IT IS LEFT AS AN EXERCISE FOR THE READER TO EXTEND THE PROGRAM TO SORT NAMES ALPHABETICALLY (SEE PAGE 41 ON THIS).

THIS PROGRAM CALLS THE TWO SUBROUTINES GIVEN ON THE PREVIOUS DOUBLE PAGE. TO USE THE PROGRAM YOU TYPE THE NAME, SEX, DEPARTMENT NUMBER, AGE & SALARY OF EACH MEMBER OF STAFF OF A DEPARTMENT STORE. THE PROGRAM THEN PRINTS THREE MANAGEMENT REPORTS EACH OF WHICH DEALS SEPARATELY WITH THE SEXES. THE FIRST REPORT TABULATES THE INPUT DATA ORDERED BY DEPARTMENT NUMBER, THE SECOND ORDERED BY AGE OF EMPLOYEE, THE THIRD BY SALARY. IN ALL THREE REPORTS THE "ORDERING" COLUMN IS KEPT NEXT TO THE COLUMN OF NAMES.

AN IMPORTANT THING TO NOTICE ABOUT THIS PROGRAM IS THAT THE ORIGINAL INPUT DATA ARE NEVER MOVED. ORGANIZATION IS BY SHUNTING POINTERS ABOUT IN A SINGLE LIST OF POINTERS.

```

10 PRINT "DEPARTMENT STORE: STAFF ANALYSIS"
20 DIM N(2), L$(100), N$(100), M$(100), S$(100), A(100,3), T$(2), R$(3)
30 DATA "FEMALE", "MALE", "DEPARTMENT", "AGE", "SALARY"
40 READ T$(1), T$(2), R$(1), R$(2), R$(3)
50 DEF FNC(Y)=Y-3*INT(Y/4)
60 REM FNC CYCLES 1,2,3,1,2 AS Y GOES 1 TO 5
70 PRINT "HOW MANY STAFF"
80 INPUT N
90 PRINT "FIRSTNAME, LASTNAME, SEX, DEPT., AGE, SALARY"
100 LET N(2)=0
110 FOR I = 3 TO N+2
120 INPUT N$(I), M$(I), S$(I), A(I,1), A(I,2), A(I,3)
130 IF S$(I) = T$(1) THEN 150
140 LET N(2)=N(2)+1
150 NEXT I
160 LET N(1)=N - N(2)
170 REM INPUT COMPLETE

```

NUMBER OF STAFF

COUNT THE NUMBER OF MEN

NUMBER OF WOMEN

ILLUSTRATING BASIC PAGE 72

```

180 REM BEGIN ANALYSIS
190 GO SUB 1000
200 FOR K=1 TO 3
210 PRINT
220 PRINT "REPORT"; K; " ORDERED BY "; R$(K)
230 PRINT
240 FOR Z=1 TO 2
250 GO SUB 2000
260 PRINT
270 PRINT T$(Z); " STAFF"
280 PRINT "NAME" , , R$(K), R$( FNC(K+1) ), R$( FNC(K+2) )
290 LET R=L(Z)
300 IF R=0 THEN 340
310 PRINT M$(R), M$(R), A(R,K), A(R, FNC(K+1)), A(R, FNC(K+2))
320 LET R=L(R)
330 GO TO 300
340 NEXT Z
350 NEXT K
360 GO TO 9999

```

CREATE TWO CHAINS; FEMALE & MALE

CYCLE 3 COLUMNS OF A(,) TO GIVE 3 REPORTS

SPACE

CYCLE WOMEN THEN MEN

SPACE

HEAD OF CHAIN

NEXT LINK

DON'T FALL THROUGH SUBROUTINES

INSERT SUBROUTINES 1000 & 2000 HERE

9999 END

RUN

DEPARTMENT STORE: STAFF ANALYSIS

HOW MANY STAFF

? 6

FIRSTNAME, LASTNAME,	SEX,	DEPT.,	AGE,	SALARY
? ROSE STAGG	FEMALE	6	21	2800
? ALGERNON SWEET	MALE	6	23	3750
? CLARENCE PETTY	MALE	7	22	3750
? VIOLET BUCK	FEMALE	6	66	2000
? CECIL WILTING	MALE	7	18	4000
? CUTHBERT MACQUEEN	MALE	5	70	6000

REPORT 1 ORDERED BY DEPARTMENT

FEMALE STAFF

NAME	DEPARTMENT	AGE	SALARY
VIOLET BUCK	6	66	2000
ROSE STAGG	6	21	2800

MALE STAFF

NAME	DEPARTMENT	AGE	SALARY
CUTHBERT MACQUEEN	5	70	6000
ALGERNON SWEET	6	23	3750
CECIL WILTING	7	18	4000
CLARENCE PETTY	7	22	3750

REPORT 2 ORDERED BY AGE

etc. etc.

THIS BECOMES THE FIRST COLUMN HEADING IN REPORT 2

BITTO: REPORT 3

MATRICES

⚡ DON'T RUN AWAY ⚡
 YOU DON'T HAVE TO KNOW
 MATRIX ALGEBRA TO FIND
 "MAT" STATEMENTS USEFUL.

IN BASIC A MATRIX IS SIMPLY A RECTANGULAR ARRAY OF SUBSCRIPTED VARIABLES :

```
10 DIM A(4,4), B(4,1), C(1,4), D(2,3), E(1,1)
```

	1)	2)	3)	4)
A(1,				
A(2,				
A(3,				
A(4,				

SQUARE MATRIX

	1)
B(1,	
B(2,	
B(3,	
B(4,	

COLUMN MATRIX

	1)	2)	3)	4)
C(1,				

ROW MATRIX

	1)	2)	3)
D(1,			
D(2,			

RECTANGULAR MATRIX

	1)
E(1,	

THIS IS A MATRIX

AND THERE ARE ABOUT 12 "MAT" STATEMENTS IN MOST BASICS WITH WHICH YOU CAN MANIPULATE SUCH ARRAYS.

BUT WATCH OUT FOR THE FOLLOWING :

SOME BASICS ALLOW "MAT" STATEMENTS TO BE USED ON ONE-DIMENSIONAL ARRAYS BUT OTHERS DON'T. SO ALWAYS MAKE TWO-DIMENSIONAL ARRAYS WHEN YOU INTEND TO USE "MAT" STATEMENTS — EVEN WHEN ONE OF THE DIMENSIONS IS UNITY (AS IN B(,) , C(,) & E(,) ABOVE).

DON'T OMIT "DIM" STATEMENTS FOR ARRAYS EVEN THOUGH MOST BASICS ALLOW SUCH OMISSION WHEN DIMENSIONS ARE 10 OR LESS (SEE PAGE 62).

SOME BASICS ALLOW SUBSCRIPTS OF ZERO, BUT IN SPITE OF THIS THEIR "MAT" STATEMENTS

IGNORE

THE ZEROth ROW & ZEROth COLUMN (THUS SUPPORTING THE EXHORTATION ON PAGE 63 NEVER TO USE ZERO SUBSCRIPTS). JUST IN CASE YOUR VERSION DOES ALLOW ZERO SUBSCRIPTS — AND YOU CAN'T BE CERTAIN FROM ITS USER'S MANUAL WHETHER "MAT" STATEMENTS FOLLOW SUIT — RUN THIS LITTLE PROGRAM. IF IT SHOULD PRINT 1 RATHER THAN 0 THEN PROBABLY ALL YOUR "MAT" STATEMENTS TAKE ACCOUNT OF THE ZEROth ROW & COLUMN — AN UNUSUAL BASIC SYSTEM.

```
10 DIM A(1,1)
20 LET A(0,0)=0
30 MAT A=CON
40 PRINT A(0,0)
50 END
RUN
```

GOOD!

matrix, *mā'triks*, or *mat'riks*, *n.* (math.) a rectangular array of quantities or symbols: *pl.* ma'trices (-trīs-ēz, or iz) [L *mā'trix*, *icis*, a breeding animal, later, the womb - *mater*, mother]

MATRIX INSTRUCTIONS BEGIN WITH THE WORD "MAT". TWELVE OF THEM ARE LISTED BELOW AND DESCRIBED ON SUCCEEDING PAGES. TERMS LIKE "TRANSPOSITION", "MATRIX MULTIPLICATION", AND "INVERSION" ARE EXPLAINED SO THAT THOSE WHO HAVE NEVER MET MATRIX ALGEBRA MAY UNDERSTAND AND USE THE ASSOCIATED INSTRUCTIONS.

PAGE

MAT A = B	FOR MAKING ARRAY A(,) THE SAME AS B(,).	78
MAT A = B ± C	FOR MAKING ELEMENTS OF ARRAY A(,) THE SUM OR DIFFERENCE OF CORRESPONDING ELEMENTS OF B(,) AND C(,).	80
<p style="color: red; font-size: small;">ANY LETTERS IN ALL THESE 'MAT' INSTRUCTIONS NOT JUST A, B, C</p>		
MAT A = (N) * B	FOR MAKING ELEMENTS OF ARRAY A(,) "N" TIMES CORRESPONDING ELEMENTS OF B(,) WHERE "N" IS A NUMBER NOT A MATRIX.	82
MAT A = TRN(B)	FOR MAKING THE <i>ROWS</i> OF ARRAY A(,) THE SAME AS THE <i>COLUMNS</i> OF ARRAY B(,).	84
MAT A = ZER	FOR MAKING ALL ELEMENTS OF ARRAY A(,) ZERO.	86
MAT A = CON	FOR MAKING ALL ELEMENTS OF ARRAY A(,) UNITY.	87
MAT A = IDN	FOR MAKING <i>SQUARE</i> ARRAY A(,) INTO AN <i>IDENTITY MATRIX</i> (1's ON THE DIAGONAL AND 0's OFF THE DIAGONAL).	87
MAT R = A * B	FOR MAKING ARRAY R(,) THE MATRIX PRODUCT OF A(,) AND B(,) BY MATRIX MULTIPLICATION.	88
MAT A = INV(B)	FOR MAKING ARRAY A(,) THE INVERSE OF THE MATRIX IN <i>SQUARE</i> ARRAY B(,).	92
MAT READ A, B, C	FOR READING COMPLETE ARRAYS FROM "DATA" STATEMENTS.	94
MAT INPUT A, B, C	FOR DEMANDING COMPLETE ARRAYS FROM A SOURCE OUTSIDE THE PROGRAM.	96
MAT PRINT A, B, C	FOR PRINTING COMPLETE ARRAYS.	98

FOR EVERY "MAT" INSTRUCTION THIS BOOK GIVES A CORRESPONDING ROUTINE IN ELEMENTARY BASIC USING NESTED LOOPS. IN ANY NEST OF LOOPS THE VARIABLE CONTROLLING THE INNERMOST LOOP VARIES FASTEST. IF BASIC STORES ARRAYS BY COLUMNS THEN IT IS MOST EFFICIENT TO MAKE THE ROW SUBSCRIPT VARY FASTEST & CONVERSELY IF BASIC STORES ARRAYS BY ROWS THEN IT IS BETTER TO MAKE THE COLUMN SUBSCRIPT VARY FASTEST. IT HAPPENS THAT SOME BASICS STORE ARRAYS BY COLUMNS; OTHERS BY ROWS; SO DON'T LOOK FOR SIGNIFICANCE IN THE CHOICE OF ROW & COLUMN SUBSCRIPTS IN THIS BOOK.

MAT A = B

THIS INSTRUCTION
MAKES A COPY OF
A COMPLETE
ARRAY.

```
10 DIM A(3,4), B(3,4), C(2,3)
```

	1)	2)	3)	4)
A(1,				
A(2,				
A(3,				

	1)	2)	3)	4)
B(1,	5	-9.6	2.5	7.51
B(2,	6.3	0	1	2.34
B(3,	7.2	3.7	-1	8.86

SUPPOSE YOU WANT ARRAY A(,) TO CONTAIN THE VALUES NOW CONTAINED IN ARRAY B(,). YOU CAN ACHIEVE THIS FAIRLY SIMPLY BY COPYING FROM B(,) TO A(,) ELEMENT BY ELEMENT LIKE THIS :

	1)	2)	3)
C(1,	235	198	137
C(2,	642	856	705

```

200 FOR C = 1 TO 4
210 FOR R = 1 TO 3
220 LET A(R,C) = B(R,C)
230 NEXT R
240 NEXT C

```

Annotations: "CYCLE COLUMNS" points to the FOR C loop; "CYCLE ROWS" points to the FOR R loop.

BUT YOU COULD DO THE WHOLE THING WITH A SINGLE "MAT" INSTRUCTION LIKE THIS :

```
100 MAT A = B
```

NOTICE THAT A & B ON LINE 100 HAVE NOTHING WHATEVER TO DO WITH SIMPLE VARIABLES A & B. THE WORD "MAT" TELLS BASIC YOU MEAN ARRAYS A(,) & B(,).

WITH THE ARRAYS PICTURED ABOVE IT WOULD BE A MISTAKE TO HAVE LINE 110 AS SHOWN BELOW; B(,) IS TOO BIG TO FIT INSIDE C(,). BUT LINE 120 IS ALLOWED. IT HAS THE EFFECT OF ALTERING THE DIMENSIONS OF B(,) TO 2 ROWS AND 3 COLUMNS:

2 & 3 ARE NOW ITS

CURRENT DIMENSIONS

```
110 MAT C = B
120 MAT B = C
```

WHICH MAY BE
ADJUSTED LATER
BY OTHER "MAT"

	1)	2)	3)
B(1,	235	198	137
B(2,	642	856	705

Annotations: "SHRINKS" points to the reduction in dimensions; "B(2,4) NO LONGER EXISTS" points to the missing 4th column.

INSTRUCTIONS PROVIDED THAT THEY NEVER EXCEED THOSE IN ITS ORIGINAL "DIM" STATEMENT.

RE-DIMENSIONING

THIS APPLIES TO NEARLY ALL THE "MAT" INSTRUCTIONS.

AFTER LINE 120 OPPOSITE, ARRAY B(,) IS RE-DIMENSIONED TO BE THE SAME AS ARRAY C(,). IT WOULD NOW BE WRONG TO HAVE:

```
130 LET B(2,4) = 13
```

BECAUSE B(2,4) HAS CEASED TO EXIST. IN SPITE OF THIS SOME BASICS WOULD FAIL TO REPORT AN ERROR AND WOULD DO SOMETHING WITH UNPREDICTABLE RESULTS ~ THE 13 APPEARING PHANTOM-LIKE IN SOME OTHER LOCATION.

IT IS STILL ALLOWABLE TO HAVE:

```
140 MAT B = A
```

EVEN THOUGH A(,) STILL HAS 3 ROWS & 4 COLUMNS WHEREAS B(,) CURRENTLY HAS ONLY 2 ROWS & 3 COLUMNS. A "MAT" INSTRUCTION (UNLIKE THE ORDINARY "LET" INSTRUCTION) RE-DIMENSIONS B(,) GIVING IT CURRENT DIMENSIONS OF 3 ROWS & 4 COLUMNS ONCE AGAIN.

IN GENERAL BASIC RE-DIMENSIONS AN ARRAY ON THE LEFT OF THE EQUALS SIGN ACCORDING TO CURRENT DIMENSIONS OF ARRAYS ON THE RIGHT AS LONG AS THE ORIGINAL SIZE GIVEN IN THE "DIM" STATEMENT IS NOT EXCEEDED. (THAT IS WHY LINE 110 OPPOSITE IS WRONG BUT 140 ABOVE IS CORRECT.)

THERE IS, HOWEVER, A COMPLICATION: MOST BASICS SEEM TO INTERPRET "ORIGINAL SIZE" AS MEANING THE TOTAL NUMBER OF ELEMENTS IN THE ORIGINAL ARRAY; THUS IF P(1,16) APPEARED IN THE "DIM" STATEMENT, P(,) COULD BECOME, THROUGH RE-DIMENSIONING, A SQUARE ARRAY OF FOUR ROWS AND FOUR COLUMNS. THIS IS NOT NICE. IT IS BETTER AND SAFER TO CONSIDER EACH DIMENSION AS AN INDIVIDUAL LIMIT OF RE-DIMENSIONING ~ THUS P(1,16) IN THE ORIGINAL "DIM" STATEMENT MAY ATTAIN ANY NUMBER OF COLUMNS UP TO 16, BUT NEVER MORE THAN ONE ROW. IF YOU PLAN TO HAVE P(,) CHANGE FROM ONE ROW OF 16 ELEMENTS TO FOUR ROWS OF 4 ELEMENTS THEN YOU SHOULD DECLARE P(4,16) IN THE "DIM" STATEMENT.

MICROSPEECH

Does your computer speak to you?

'WEHL IHT KAAAN DOO WIHTH MEE!'

Features

- Single PCB plugs directly into an SWPTC 6800 bus.
- 9 parameter vocal tract model.
- Real time software converts any stored phonetic code to speech.
- Computer Games.
- External input for special musical effects.
- Adds speech output to existing BASIC programs.

Microspeech package

- Speech synthesizer board (assembled & tested).
- MSP2 Software on floppy disc or cassette.
- Hardware & Software manual.
- Speaking BASIC software option.

Make your computer talk

Just by entering phonetic text (as in the sentence at the top of the page). Microspeech with the MSP2 software can make your computer speak. MSP2 uses only 4K of memory. Every extra 1K of buffer space can store 90 seconds of speech.



It speaks for itself

TIM ORR DESIGN CONSULTANT
COSTRONICS ELECTRONICS

55 Drive Mansions, Fulham Road, London, SW6
13 Field Heath Avenue, Hillingdon, Middlesex

● Circle No. 167

TANGERINE

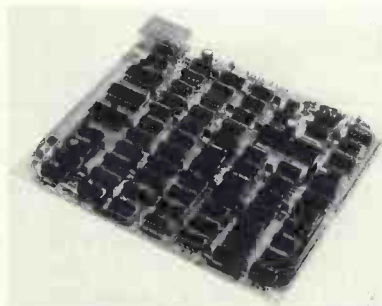

NEW!
Ready built
modules now
available in 7 days
Kits from
STOCK!

A fully-compatible terminal when used with any keyboard and domestic TV (or monitor) that can replace any serial terminal for a fraction of the cost.

Apart from the regular features that most VDUs have, the 1648 can perform the following:

- 1) Fully-controllable cursor.
- 2) Generates 16 lines of 44/48 characters (selectable) in both upper- and lower-case with any keyboard, even those without an 'alpha' facility.
- 3) Break and Repeat also provided.
- 4) RS232 and full current loop I/O provided.
- 5) Full control character decoding—selectable by the user to perform cursor movements, bell, page clear, and for switching any other peripherals with suitable interfacing.
- 6) 10 switchable Baud rates.

All VDUs are supplied with an A4-sized ring-binder containing 50 pages of comprehensive manual with large A3 fold-out Circuit Diagram and Component Layout. Details of graphics, and other applications are also included.

COMING SOON!

We shall be announcing soon the details of our Professional keyboard available in both kit and ready-built versions, with a numeric pad option.

Reed-keys are used exclusively, and it is therefore exceptionally reliable and robust!

Other products to be announced are:

- Z80 based single-board μ computer.
- 6800 based single-board μ computer.
- CRT Controller, an economy VDU module using software to control its functions. Also Teletext-compatible, with full graphics.
- Add-on Graphics Module for the 1648.
- Add-on Hex Keypad, for machine coding.
- Add-on μ modem for cassette interfacing.
- Prom Programmer.
- Complete monitor-less Terminal.

TANGERINE COMPUTER SYSTEMS LIMITED
RIVERMILL LODGE, LONDON ROAD,
St. Ives, Huntingdon PE22 4BR 0480 65666

Please send the following:

- () Further information.
() 1648 VDU KIT @ £129.50 inc. pp + VAT £10.36
() 1648 VDU Built and tested @ £154.50 inc. pp + VAT £12.36

NAME:

ADDRESS:

Business telephone:..... Home telephone:.....

DATE: / /79

I enclose a cheque no: for,

£..... INCLUDING VAT.

Signature:.....

Overseas customers should send a bank draft drawn on a London Bank, and include sufficient postage for surface/air mail for 1,3 kg.

BUILD THE

12,000 ALREADY SOLD



NASCOM I COMPUTER

★ British Design ★ UK Best Selling Kits
FULL AFTER SALES SERVICE & GUARANTEE

We are the Sole Approved London Stockist and National Distributor

FEATURES

- ★ Supplied in kit form for self-assembly
- ★ Full documentation supplied
- ★ Fully screened double-sided plated through hole printed circuit board
- ★ Full 48 key keyboard included
- ★ 2K x 8 Ram
- ★ 1K x 8 monitor program in Epram
- ★ Powerful Mostek Z80 CPU
- ★ 16 x 48 character display interface to std un-modified T.V.
- ★ T.V. display memory mapped for high speed access
- ★ On board expansion to 2K x 8 Eprom



£165 - 8% VAT
POST FREE

- ★ On board expansion for additional 16 I/O lines
- ★ Memory may be expanded to full 60K

EXPANSION

★ Expansion buffer board .. £25

MEMORY KITS (inclusive all hardware)

8K £85
16K £140
32K £200

★ I/O board with decoders and all hardware except ICS will accept up to 3 PIOs, 1 CTV and 1 UART £35

OTHER HARDWARE

- ★ 3A power supply for up to 4K expansion £19.90
- ★ 3A power supply for up to 4K expansion Mk II £24.50
- ★ 8A power supply for larger than 32K expansion £50.00
- ★ Expansion card frame £29.50
- ★ E PROM programmer £40.00
- ★ E PROM Eraser £25.00
- ★ Keyboard cabinet £3.50
- ★ Programming manual £4.00

SOFTWARE

- ★ 1K x 8 monitor program providing 8 operating commands, supporting Mem examine/modify, tabulate, copy, break, single step execute tape, load, tape dump
- ★ Reflective monitor addressing for flexible monitor expansion through user programs
- ★ Monitor sub-routines include—delay ASCII coding, binary to hex convers/pn, clr screen, scroll up, string print, cursor shift and many others

NEW T-4 operating system in (2) 2708 EPROMS upwards compatible from T2 and B-BUG £25.00
Tiny Basic £25.00
Super Tiny Basic (with editor and machine utility routines) £35.00
Zeap assembler editor £32.00

★ VAT 8% ALL ITEMS EXCEPT BOOKS ★ DEMONSTRATIONS CONTINUOUS DAILY
★ WE WELCOME EXPORT—EDUCATIONAL AND INDUSTRIAL ENQUIRIES ★ FREE BROCHURE—SEND SAE 9½ x 8½ STAMP 12p.



HENRY'S
Phone (01) 723 1008

All mail to:
Henry's Radio
404 Edgware Rd
London W2



● Circle No. 168

How would your school like to own its computer? From where do you get the money? Well, if you are in London, Derek Esterson is giving it away.

DEREK ESTERSON works for the Inner London Education Authority. He is Britain's first local education officer with responsibility for computing—and he has money to give away.

First, the background. The arrival of the microprocessor has made it feasible for schools to own their own computer. There are now 10 schools out of 192 in ILEA with a micro. Not very good, you might say.

True, there are 135 schools on-line to

by Carol Gourlay

a Systime 6000 at the City of London Polytechnic, and there are some 80 terminals linked to a Hewlett-Packard computer from various colleges of further education. but that's not the same as having your own computer.

So ILEA decided to make available some £65,000 from central funds to equip schools and colleges with computing power. That's the good news.

Colleges received £50,000 of this, which

leaves £15,000 for 192 schools. You cannot buy much computing power for £78. Moreover, any school wanting a micro has to raise half the cost.

In case you think you can buy any computer you like, think again. ILEA has decided to standardise on the Research Machines 380-Z. There are two exceptions—one school has an Apple and one a M6800.

The most attractive feature of the Research Machines equipment for Esterson—and some of the teachers who have had an opportunity to review the system—is its high-resolution colour graphics capability. Most schools in the area are equipped with colour TV monitors—the legacy of an educational TV network which proved too expensive to run—which can be used in conjunction with the micros.

Another point in favour of the 380-Z is that it can be enhanced easily. Esterson also likes to deal with a U.K. company because it means quicker response time and easier administration.

Not surprisingly, most schools want

the largest machine, which costs £1,250. Already, Esterson has received 45 requests and he predicts that "within a year, most schools are likely to want to jump on the bandwagon".

As the £65,000 is a one-off grant, many schools will be disappointed unless more

He's away

money is made available, and only 15 requests can be granted now.

That's the bad news. The point is that if enough schools lobby Esterson, then there is surely a good case for providing more money, particularly now that the Government is spending millions of



THE TOTAL SOLUTION FROM ALMARC

OF COURSE!

Now Almarc & Vector Graphic offer the complete solution to your computing needs for £2300.00* . . . The Vector MZ needs only the addition of a V.D.U. and it's ready to go. Completely assembled and fully tested the Vector MZ offers the following features as standard:-

- * S-100 bus
- * 4 MHz Z80A processor
- * 158 instructions
- * two quad density Micropolis floppies—over 630k bytes on line
- * serial port
- * two parallel ports
- * 32K static ram
- * 12K prom/ram board with extended monitor
- * Extended disc Basic

Simply connect your peripherals (Elbit V.D.U.s & Centronics printers are available from Almarc) and your up and running and, because the MZ uses the S-100 bus, you can plug in a massive range of add on units.

Ring or Write for a demonstration to:-

Almarc Data Systems Ltd.,
29 Chesterfield Drive,
Burton Joyce,
Nottingham. Tel: 0602 248565.

* Discount terms available.

CPN now available
on the Vector MZ

BASIC for your NASCOM!

GET THE EASE AND SIMPLICITY OF PROGRAMMING IN BASIC WITH . . .

TINY BASIC LEVEL A

A superior Tiny Basic

- No extra memory needed on any NASCOM!
- Fitted in 2 minutes in place of your existing PROM(s)
- Integer arithmetic +, —, ×, ÷
- Random number generation
- Key board pause and interrupt
- Abbreviated commands allow economical use of your memory and include . . .
LET; PRINT; IF; GOSUB; RETURN; REM;
STOP; RND; GOTO; INPUT; RAM; SAVE;
LIST; NEW; RUN

TINY BASIC LEVEL B with enhanced features runs on systems with extra memory and has all the commands above PLUS . . .

PEEK; POKE; CALL; LOAD; DUMP; FOR; NEXT; ABS; IN; OUT for complete machine code capability

LEVEL A or B in two 2708 PROMS £21.50 + 8% VAT

Documentation included

C C SOFT

83 Longfield St., London SW18
Tel: 01-870 4891 (any time)

pounds (£250 million at last count) to encourage use of the micro.

With that in mind, ILEA has a somewhat unusual method of funding the purchase of extra equipment for schools. It allows schools and colleges greater freedom with the allocation of their finances than educational bureaucracy usually permits.

If a school does not spend all the money earmarked for one purpose, it can put the surplus towards the purchase of equipment it could not otherwise afford—a minibus, for example, or a computer.

In particular, Esterson explains that schools often find themselves with excess cash if a teacher resigns midway through

giving money

the year; the school is then free to spend what would have been the teacher's salary. Over a year, the surplus can be as much as £15,000. All the 45 schools which have requested help from ILEA intend to provide their share of the cost in this way.

It is not just buying a computer which is a problem. The biggest obstacle to the development of computing in schools is the lack of qualified people. Esterson, whose official title is Staff Inspector for Science, Engineering and Computing, says: "People are proving hardest to get, and we need people who are not only experienced in the classroom, but who can write their own software as well and produce backing material".

Coherent base

He pointed out that in a school it is often the maths teacher who has responsibility for computing; it seems the myth persists that computers are to do with sums and numbers. Funnily enough this parallels the situation prevalent in business computing, where the computer is often the responsibility of the accountant or the financial director. Neither the maths teacher nor the accountant is necessarily more competent than others to manage a computer system.

Esterson reckons it is important to maintain a rigid separation between electronics and computing, a point with which we definitely agree. Although proud of electronics teaching in his area—"We have some extraordinarily gifted teachers"—Esterson feels it is wrong for a school to feel that it can get dependable computing from a kit assembled by the electronics department.

In his opinion, the only sensible way to tackle the problem of insufficient instruc-



Derek Esterson

ted staff is on a nation-wide basis. He feels it is time to break with the good old British tradition of not having national training programmes, to establish what he calls "a coherent base for the teaching of computing."

The fact that there is little pre-service training in computers for teachers means that it is difficult to make any substantial advance in the number of qualified staff. It is the responsibility of the Department of Education and Science, Esterson believes, to encourage pre-service training, by setting-up and financing national guidelines.

In-service training

Some authorities offer their teachers in-service training in computing; not all of them offer such training free. Esterson runs in-service courses for teachers. They fall into three categories—courses which cover the GCE and CSE syllabuses, programming courses, and computer appreciation courses to show teachers how they can use computers in the teaching of their particular subjects. They are advertised once a term and are generally over-subscribed.

Esterson reckons that computers in schools will prove to be "an extraordinarily powerful aid" in the teaching of many topics in different subjects. In fact, he feels that this may prove to be the most important impact computers will have on education.

"There is", he says, "a great disaffection towards learning in general, among

school kids and among adults. The problem is getting people to want education."

Computers help to provoke people to learn; that is why ILEA micros and terminals are for use in all subjects—the aim is computer literacy, not computer science.

Literacy aim

Computer literacy is what Esterson wants to see achieved in schools. "The aim is not to turn out lots of little programmers," he declares with something of the evangelist in his voice, "but to achieve a wide understanding of the impact computers will have and to encourage an easy familiarity with them—the kids have to come to terms with the enormous economic and social changes which will occur."

He wants youngsters to be aware of the effect computers will have on their future employment and the issue of privacy which surrounds computerisation, to protect their own position.

Above all, the aim is to get people to accept computers as enriching life and not as something alien. "Computers are entering our whole culture; we want people to take advantage of them, not to be latter-day Luddites," he says.

As for the future, Esterson predicts that the next step will be computers in primary schools. He welcomes this development: "We would like to see that every child gets some element of computing from as early as possible." □



Introducing the personal computer you've waited for.

The Exidy Sorcerer.

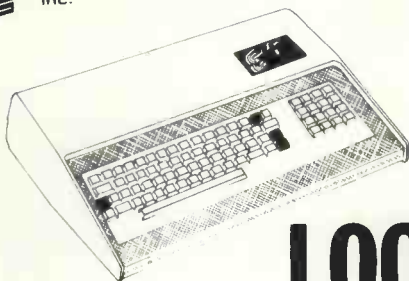

LOOK AT THESE FEATURES

16K £760

32K £859

add 8%
VAT

The Sorcerer Computer is a completely assembled and tested computer system ready to plug in and use. The standard configuration includes 63 key typewriter-style keyboard and 16 key numeric pad dual cassette I/O, with remote computer control at 300 and 1200 baud data rates, RS232 serial I/O for communication, parallel port for direct Centronics printer attachment, Z80 processor, 4K ROM operating system, 8K Microsoft BASIC in separate plug-in Rom Pac™ cartridge, composite video of 64 chars x 30 lines, 128 upper/lower case ASCII character set and a 128 user-defined graphic symbols, up to 32K on-board RAM memory, operators manual, BASIC programming manual and cassette/video cables, connection for S100 bus expansion unit giving access to the spectrum of exciting and useful peripheral devices, such as Floppy disk drives, voice recognition/synthesis battery back-up board in case of power failure, additional memory boards, E-PROM cards give you the facility to program and re-program your own ROM memories etc. etc. This is the most useable and flexible system that's now available to the home and business user at such a low price.

* WORD PROCESSING, COBAL, FORTRAN etc

* PLUG IN ROM CARTRIDGES

* WORKS WITH NORMAL TV

* S100 EXPANSION UNIT

* CASSETTE INTERFACE

* Z80 CPU

* 32K RAM ON BOARD

* A REAL BUSINESS MACHINE

please make cheques and postal orders payable to JADE
phone your order quoting ACCESS or VISA number
for technical information or advice phone 0736 66565

Supplied by - Factor One Computers

JADE

17 Market Place, Penzance, Cornwall.

● Circle No. 171

CIFER SYSTEMS LIMITED

Computer and Ancillary Equipment



CUB the new incredibly low-cost terminal from Cifer which features:

Upper and lower case characters
16 lines each of 64 characters
12 monthly warranty
7 + 9 dot matrix characters
Portability with separate keyboard
Auto-scrolling of text
Available as display only unit
Models available for 12V D.C. operation
ONE-OFF PRICE £380

Avro Way, Bowerhill, Melksham,
Wiltshire SN12 5TP
Telephone Melksham (0225) 702364
Telex 449872



● Circle No. 172

The great RAM sale

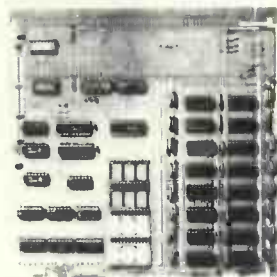

The Nascom system offers major expansion at sale prices. To give you as much choice as possible we offer RAM boards in three configurations to accommodate up to 16 memory ICs of either MK4027 or MK4116, all socketed.

The memory board kit options are:

8K £85.00
16K £140.00
32K £200.00

Boards will also accommodate up to four EPROMS of type 2708 at £10.50 plus VAT each. And if you wish to upgrade 16K to 32K it will only cost you an additional £70.

Memory boards plug straight into a NASBUS and an edge connector is included for this. All boards must be used in conjunction with the buffer board which, like the memory boards, is available in kit form ex-stock from approved Nascom distributors.



Nascom Microcomputers

121 High Street,
Berkhamsted,
Herts.
Tel: (04427) 74343

● Circle No. 173

When you are looking for something different

WHEN you've landed your 137th lunar module on a simulated moon, played your last game of noughts and crosses against a computer which always draws, and you are tired of trying to find a good reason to computerise the stubs in your chequebook, is there anything left to do?

Anything really different, I mean? It seems that virtually all the programs around are variations on a few worn-out themes. Remember when you were fed up, as a child, with those board games which had cars, monsters, spaceships, pirates or whatever, but were really all based on moving round silly counters on a stupid board by shaking a dice? Doesn't it seem, sometimes, a little like that now? Was all that money for your micro really worth it?

In what—three years?—you will be able to buy a pocket computer as opposed to calculator. In six years, they will be in Woolworths. You'll have a computer, a small, built-in colour graphics screen, sound, plenty of memory, speech synthesis and recognition, and so on. In one hand.

If things go the way that they have been doing, a normal day's activity for one of these delights will be to play a few trivial games, or sing God Save the Queen in any key while drawing a picture of Snoopy in 16 wonderful colours. That is to say, it will be like using a Formula 1 racing car to deliver the milk.

Relationship

So here is a somewhat discursive attempt to air a few ideas which seem important. I want to look at some areas where the beginnings of something different may be seen. In particular, I want to write about computers, art and people.

It seems to me that somehow—I think I know how, and it's ultimately a political reason, but I need a pint or two before I really get going—we are being pushed into a view of the relationship between people and personal computers as being a *mechanistic* one.

In 1829, Thomas Carlyle wrote:

"Not the external and physical alone is now managed by machinery, but the internal and spiritual also. . . *not for internal perfection, but for external combinations and arrangements. . . for Mechanism of one sort or another do they struggle.*" (my italics.)

If you ask most people what they think of if you say "computer", it's likely to be something to do with gas-bills, or "miraclechips" in some consumer product.

Think, though, if computers had emerged in the late 1960s instead of the '40s, they would more likely be associated with light shows or advertising graphics.

Computers work on logic, not numbers. We think, or have been led to believe,

that they can deal only with the quantitative aspects of the world, not the qualitative; that you can say "28.3" to a computer, but not "nice" or "fairly small".

That is nonsense. A computer can "understand" a value judgment as much, or as little, as it can a number. Techniques exist to handle qualitative data. Of course,

by Brian Smith

the computer might appreciate only a concept by association with other concepts.

At the British Computer Society fair, there were graph plotters plotting, the Police National Computer naming and remembering, and a model railway being controlled. There was a show of computer art, nearly all of it pictures of numbers.

There were also drawings by children of My Friendly Robot. One, with images of a machine and the world, had the robot saying "I rule the world", while the world said "I rule the robot".

"Solve this equation" is a well-defined problem. "Build me a pleasant house" is an ill-defined problem, with no single solution everyone would agree was correct. Life, need it be said, is an ill-defined problem.

So are there less mechanistic things we could be doing? Could computer art, for example, relate a little more to real life, whatever that is? Could it, even, help us to appreciate what that is?

Weird and wonderful

I think so. There are a number of approaches. I am the happy owner of a Research Machines 380-Z. On Mondays, Tuesdays and Wednesdays I pull it through the snow on a luggage trolley, then by a mixture of buses, tubes and trains, to various art colleges.

There, painters, graphic design persons, sculptors, poets and others do weird and wonderful things with it. Sometimes you wouldn't know it, because they prevent the computer displaying anything at all; they know what's going on inside, and they'll tell you, and that's the artwork.

Sideways thinking is rampant. We put photo-sensitive resistances on to the television screen with sticky tape, then flash little squares of light on and off underneath, to make sounds from a small

oscillator. They want to make programs to respond to peoples' presence.

Forthcoming projects include an intelligent program talking to people who visit London's Design Centre. The program will be created by design students at Chelsea School of Art.

Research Machines is introducing high-resolution colour graphics later in the year and the painters are already salivating.

Most important, however, instead of using the computer to make, or help make art, a few people have started to see "the computer plus what people do with it in the world" as art. They somehow use the computer, and their growing skills with it, to increase their understanding of the context of computers. Because they are supposed to be "creative and all that", they communicate their perceptions as art.

Ideas of progress

Those perceptions, since they are about the general-purpose machines we call computers, and not just any old machine, have implications for the rest of the things and processes in the world. And that to me, is what art is about, and what computers can be about, instead of number-crunchers.

The foregoing might help us, art and computing in general—little by little, I mean—but still leaves us with the problem of what the pocket computer will do in a few years. I mentioned that there were techniques for dealing with qualities rather than quantities.

A couple of names; Fuzzy set theory and Q-analysis. The former copes, as its name implies, with impreciseness. The latter deals in a topological—surface features—way with, for instance, the aesthetics of buildings.

While the techniques need a little searching for, we have access already to programs dealing with psychology, artificial intelligence and so on. There could be many more of them if, our demand stimulated the supply.

To re-state some of the foregoing thoughts more simply. We should beware of generating a kind of "spurious creativity" variety which takes us no further forward.

Unless we can become aware of an idea of progress in what we are doing with computers, we shall have the machines, the context, the public lack of awareness and the mystification we shall deserve.

MICRODIGITAL BOOKWORM

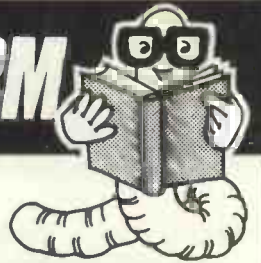

MICRODIGITAL

We sell the widest range of Micro-computer books in the country, backed up by a return of post service.

We accept Access and Barclaycard and welcome telephone orders.

Microcomputer Programming 6502 Zaks—£7.95.

A superb introduction to the techniques and tricks of programming the 6502 micro, used in the APPLE, PET, ACORN SYM, etc. Completely self-contained, it can be used by the novice to learn programming, or anyone who wants to make more effective use of the 6502.

Basic, Basic—J. Coon—£6.50 and Advanced Basic—J. Coon—£6.00

These two books give you the complete picture of the Basic language. Both texts begin with short, complete programs and progress to more sophisticated problems.

Basic with Business Applications—Lott—£8.40

An excellent introduction to basic for the small businessman.

The First Book of Kim-Butterfield etc. ad.—£7.16

Games, system programs, how to expand your Kim—essential reading for the KIM freak.

Programming Proverbs Ledgard—£5.56

An excellent little book. The principles of good programming with numerous examples to improve programming style and proficiency.

The Design of Well-Structured and Correct Programs—Alogic and Arbib—£10.24

This text synthesizes ten years of research in top down program design and verification of program correctness. It shows how these techniques may be used in day to day programming with the Pascal language.

57 Practical Programs and games in Basic-Tracton—£6.36

Programs for your APPLE, SORCERER or PET, including an excellent Star Wars game.

Computer Lib—Nelson—£5.95

The classic work on all computers big or small. It brings the reader through the past ten and into the next ten years of computer science.

Chess Skill and Machine—Frey—£11.84

The classic work on computer chess. Includes the intimate details of one of the Worlds strongest programs—Chess 4.7.

How to build a Computer Controlled Robot—J. Loofborrow—£6.36

This book details the step-by-step directions for building a computer-controlled robot named "Mike", controlled by a Kim-I microprocessor, photographs, diagrams and tables help to direct you in the construction. "Mike" moves under his own control avoiding all objects placed in his way... stops, starts, and changes direction on voice commands.

Scientific and Engineering Problem Solving with the Computer—Bennett—£15.96

A superb book—the exercises run the gamut from random process to the dynamics of motion, from entropy in language to the Watergate problem, you'll discover BASIC applications in lasers, and in the Fourier Series, and the law(!)

Star Ship Simulation—Gorret—£5.10

Everything you need to program the ultimate star game complete with a control console connected to your computer

The First West Coast Computer Faire—£9.56

A mine of hard to find information on such diverse subjects as computer music bit-slice system to implementing high level languages.

Practical Microcomputer Pro-

gramming: the Z80—Weller—£23.40

A much needed text on the techniques and tricks of programming the Z80. Includes complete listings of a powerful Editor/Assembler and debugger.

A Guide to SC/MP Programming—Drury—£4.00

Essential reading for the MK.14 owner! Deals with programming the SC/MP at a level anyone can understand.

Microcomputer Problems Solving using Pascal—Bowles—£7.84

Pascal is rapidly becoming the language of the future! The author pioneered its implementation on a Microcomputer and as such is uniquely qualified to write this text.

A superb book! Pascal user Manual and Report Wirth—£5.52

The "official" reference manual on Pascal.

APL—on Interactive Approach Gilman—£9.50

An industry text on this powerful, interactive language.

SARGON—Z80 Chess, Program by D and K Spracklen.—£11.96.

An excellent, well documented 8K chess program, it won the 1st microcomputer chess championship with 5/5. The book contains a source listing and quite credibly detailed annotation.

Essential reading for anyone planning to write their own program.

Basic and the Personal Computer Dwyer—£10.36

An excellent introduction to the programming language Basic as it applies to the personal user.

Basic Computer Games—AHL £5.50

102 Games for your APPLE, SORCERER or Pet complete with listing and sample runs

Game Playing with Basic D. Spencer—£5.56

In game playing with Basic, the author writes in a non technical style allowing almost everyone to understand computerised game playing.

He includes the rules of each game, how each game works, illustrative flowcharts and diagrams, and the output produced by each program.

Game Playing with Computers D. Spencer—£13.56

Sharpen your programming skills with this collection of over 70 games, puzzles and mathematical recreations. The book includes over 25 game playing programmes.

MICRODIGITAL LTD.



25 BRUNSWICK STREET
LIVERPOOL L2 0BJ

Tel: 051-236 0707



● Circle No. 174

LINBURG ELECTRONICS LTD

QUALITY SEMICONDUCTORS WITH FULL INDUSTRIAL SPECIFICATION

MOTOROLA		74LS TTL	
MC6800P CPU	£8-20	74LS00	19p
MC6810 RAM	£3-20	74LS01	19p
MC6820 PIA	£4-50	74LS02	19p
MC6850 ACIA	£4-50	74LS03	19p
MC6875 CLOCK	£3-80	74LS04	20p
D2 EVALUATION KIT	£176-00	74LS08	20p
(MEK 6800 D2)		74LS10	20p
ZILOG		74LS14	74p
280 CPU 2.5MHZ	£14-00	74LS20	22p
Z80 CTC	£9-00	74LS27	32p
Z80 PIO	£9-00	74LS30	26p
		74LS32	26p
PROMS		74LS42	88p
2708 1K x 8 EPROM	£6-75	74LS47	£1-00
2716 2K x 8 EPROM	£17-00	74LS73	42p
(TEXAS TRIPLE SUPPLY VERSION)		74LS74	30p
SUPPORT CHIPS		74LS75	40p
MC1488 V24 Tx	£1-40	74LS90	54p
MC1489 V24 Rx	£1-40	74LS93	54p
8216 BUS DRIVER	£3-00	74LS154	£1-36
AY-5-1013 UART	£4-83	74LS155	57p
7 in. FLOPPY DISCS (SINGLE DENSITY, SINGLE SIDED)	£7-00	74LS174	80p
		74LS367	54p

PLEASE ADD 30p POSTAGE AND PACKING AND THEN ADD 8% V.A.T.

LINBURG ELECTRONICS LTD
DEPT PC, MOSSWAY DONIBRISTLE
INDUSTRIAL ESTATE, HILLEND
DUNFERMLINE, SCOTLAND
TEL:- (0383) 823222



● Circle No. 175

Computer standard

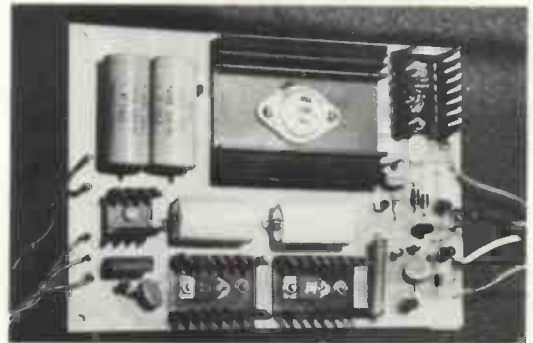

3A PSU

Computers require a reliable and even power supply. The redesigned and uprated Nascom 3A PSU meets these requirements. Its output voltages are +5V 3A; +12V 1A; -12V 1A; -5V 1A. And are sufficient to drive the Nascom-1, buffer board and up to 32K of RAM. It has LED displays on all the outputs and will fit into the Nascom frame to be announced soon. Price of PSU kit—£24.50 plus VAT.

A buffer board kit with edge connectors suitable for the NASBUS and with edge connectors and interconnectors to attach directly to the Nascom-1 is available at £25.00 plus VAT.



Nascom Microcomputers

121 High Street,
Berkhamsted,
Herts.
Tel: (04427) 74343

● Circle No. 176

PRACTICAL COMPUTING April 1979

LIKE many women, Janet Gross Nicklaus raised her family and went back to work. Before marriage, she was a data prep supervisor with ICL; now she's a school meals supervisor with Cheshire County Education Authority.

That means organising up to 2,000 meals per week at a school a few miles from her home in Congleton. She has two main responsibilities—to maintain, or better still exceed, a minimum protein content in her school dinners, and to keep the average cost per meal as close as possible to a figure set in advance by the Education Authority.

Until last September, Janet worked at a distinct disadvantage; she learned whether or not she was within her nutritional and economic guidelines only some two months after her meals had been cooked and eaten.

Daily 'fix'

That was because all the relevant data had to be processed by the central staff at Chester. The effect of the delay was obvious, particularly to Janet. She never had the information when she could use it most.

Now all is changed. Mike Nicklaus, Janet's husband, is a different kind of refugee from ICL. When offered a move to far-off Reading, he elected instead to be made redundant and become a freelance entertainer.

He also invested in a Commodore Pet to continue his daily computing 'fix'. Janet watched it winking at her across the room and began playing with it.

At the same time, she was speculating whether there might not be some application to speed the procedure at work and give her the information she wanted at the time when it would be most useful.

Janet is now at pains to point out that

Janet Gross Nicklaus

CHIPS WITH SOME THINGS

her early experience with computers at ICL had not equipped her to achieve this, but however little her understanding, she was at least familiar with computers and she was certainly not intimidated by them. So it is not too surprising that it occurred to her a small computer could be of direct use in her present job.

Mike taught her the rudiments of

by Michael Burlington

Basic and she wrote her School Meals' Statistics Program on her own. The relevant data was assembled either from her own files or from a fascinated, and co-operative, central office in Chester. The programming took about five hours over a weekend; with Mike's assistance, debugging took another half-hour. Overall planning took them between three and four hours during a two-week period.

The data comprises Janet's stock sheets which show the amount used, cost, and protein value for around 150 meal ingredients. Cost updates are done on a

weekly basis. The entire file is read into memory from tape for processing, of course; the record data is packed to save on space.

The processing is negligible. As Janet puts it: "The main programming effort was in formatting the input and the output".

A run has each item referenced on the screen, with the user invited to enter AMOUNT and COST. When all data for the ingredients has been entered, the program asks for the total number of meals. The totals and averages are then calculated and displayed.

It's an unspectacular but neat program, exactly the kind of thing that a small computer is good at doing. Janet's next plan, to write a menu planning program, is on ice, waiting for Mike to buy a floppy disc to increase the Pet storage capacity beyond the confines of cassette.

Satisfaction

Apart from providing a useful tool in her work, the statistics program gave Janet considerable personal satisfaction. As Mike was devising all manner of applications for the Pet, Janet became impatient to try her hand at it. It was as much a question of devising a useful and original application as of developing sufficient technical expertise. After all, the latter was on hand whenever she wanted it.

Well before devising the school meals program, Janet was tinkering usefully with the Pet. Even without Mike's guidance and skill, she would eventually have had some application up and running. On one occasion, she was keying-in a game and for several hours watched 'Syntax error' flash insistently on the screen—a common enough experience among first-time users.

Eventually she cracked the mistake and corrected it. That frustration and subsequent elation is, according to Janet, the sort of satisfaction the computer enthusiast is seeking.

House rules

Mike attributes much of Janet's success with the statistics program to the simplicity of Basic, and especially to Pet's own sequence of teaching Basic. Neither was enthusiastic about other Pet documentation.

How easy Basic can be to learn and use is emphasised by the two Nicklaus daughters, Josephine, aged 11, and Caroline, a year older. Needless to say with Janet and Mike so absorbed in the Pet, the children became curious. Now, after some minimal instruction, they are both capable of playing many of the games Mike has devised.

With all four using the system, house rules have evolved—like no cups of coffee in the bedroom when the Pet is switched on, and no game-playing for the girls until they have checked any homework on it. □

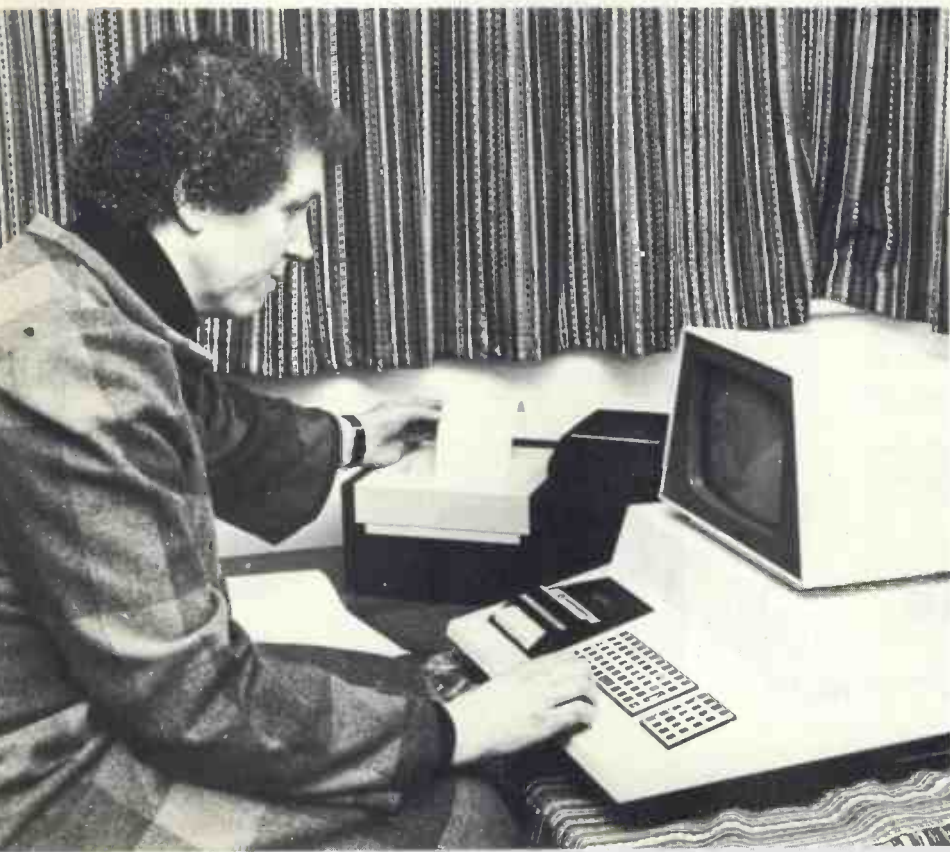

SDS-100

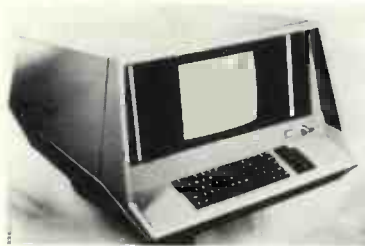

£3,700

SDS-100 HIGHLIGHTS

- 32K Bytes of RAM (Expandable to 64K)
- 1 Megabyte Disk Storage On Line (IBM 3740 Compatible)
- Up to 8K PROM
- 12 in. Video Display (24 lines of 80 characters)
- Z80 Central Processing Unit
- Full Upper and Lower Case Keyboard
- Numeric Key Pad and Cursor Controls
- Parallel Input and Output Ports for parallel I/O requirements
- Key Lock On/Off Switch
- Video Display features Blinking, Reverse, Underline and combinations
- RS-232 Serial Interface for on-line applications and serial printers
- Compatible with C-Basic, Disk Fortran, Cobol and CP/M DOS compatible software. (CP/M is a registered trademark of Digital Research of Pacific Grove, California)

AIRAMCO LTD
30 WITCHES LINN
ARDROSSAN Ayrshire
TEL: 0294 68530
TELEX 779808

STANDARD FEATURES

- Microprocessor controller
- Serial RS-232C interface
- Parallel TTL level interface
- Full upper and lower case ASCII character set (96 characters)
- Full 8½ in. wide paper
- Line length of 80 columns at 10 characters per inch
- Impact printing
- 7 x 7 dot matrix
- Ordinary paper—roll, fanfold, or sheet
- Serial baud rate to 1,200 bits per second
- Multiple line buffer of 256 characters
- Built-in self test mode
- Instantaneous print rate to 100 characters per second
- Sustained throughput to 50 characters per second
- Multiple copies without adjustment
- Re-inking ribbon mechanism
- Expected ribbon life of 10 million characters
- Front panel operator controls
- Attractive table top console

OPTIONAL FEATURES

- Line lengths to 132 columns
- Instantaneous print rate to 165 characters per second
- Sustained throughput to 80 characters per second
- Print densities of 8-3, 10, 12 and 16-5 characters per inch
- Options program selectable by control codes
- Full CRT screen size multiline buffer (2,048 characters)
- Special set of graphic symbols
- Graphics dot plotting mode
- Form feed control
- Eight switch selectable form sizes
- Automatic page boundary skip
- Remote printer selection/deselection
- Automatic line feed on carriage return

IF BOTH UNITS PURCHASED TOGETHER

£4,149 (125)
£4,350 (225)

IP-125/225

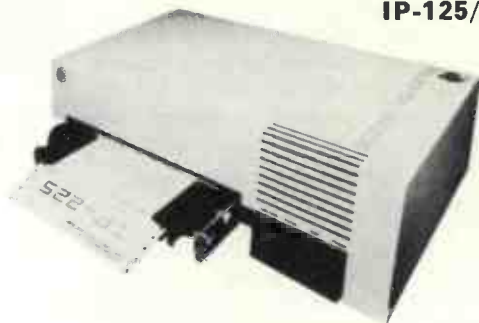

£499 (125)
£695 (225)

● Circle No. 177

LIBRARY 100

for the

TRS-80

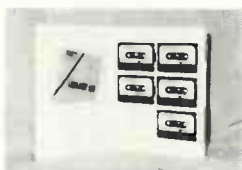

A complete library of 100 programmes for the TRS-80 Level II. The 5 cassettes are attractively packaged in a plastic binder which also holds the full documentation. All programmes were specifically written for the Library and, as a bonus, include a Tiny version of the Pilot language, to give your TRS-80 the added dimension of a new language. Less than 50p a programme !!

Finance: Present Value of a Future Sum—Simple Interest for Days—Future Value of a Present Sum—Amortization Schedule—Interest Rate: Compound Interest—Interest Rate: Installment Loan—Days Between Dates—Term of an Installment Loan—Present Value of a Series of Payments—Real Estate Capital Investment—Nominal and Effective Interest Rates—Internal Rate of Return—Future Value of Regular Deposits—Regular Deposits for Future Value—Depreciation Amount: Rate; Salvage Value; Schedule—Bond Present Value—Bond Yield to Maturity—Sale—Cost—Margin—Day of the Week—Moving Ad.

Education: Multiplication & Division—Add—Subtract—Fraction & Decimal—States & Capitals—States & Order of Entry—States & Abbreviation—Inventors & Inventions—World Capitals & Countries—Urban Areas & Population—Authors & Books—Presidents & Order—States & Largest: City—Basenum.

Graphics: Left Right—Random Ad—Graphic—Blocks—Fireside—Snow—Step Ad—Step Ad 2—Launch—Ratrace—War Game—Weird—Herring—Snoopy.

Home: Message Board—Expense Account—Nutrition—Milage—Remember—Phone Codes—Night Check Off—Drunkometer—Perpetual Calendar—Babysitter—Calculator—Bartender—Christmas List—Vacation Check Off—Conversion.

Games: Speedy—Odd One—R. Roulette—Star Blazer—Search—Spyship—Tiger Shark—Jumble 2—Sting Ray—Stars—Sketch—Flipper—Scissors—Horse—Doomsday—Craps—Jumble 1—Mem. Quiz Letters—Mem. Quiz Numbers—Wheel of Fortune—Decision—Unjumble—Fifteen—Towers—Life—Star Trek—Race Track—Count—Roachrace—Gypsy.

£46.95 (inc.)

A. J. HARDING

28 Collington Ave., Bexhill, E. Sussex. Tel: (0424) 220391

● Circle No. 178

Written for the Nascom

Among the programs written to run on the Nascom-1 and available now are:

ICL Dataskil Letter Editor

This software provides a comprehensive set of data operations. Text can be input, displayed, edited, stored on tape, retrieved and further amended. Control functions include cursor, character, word, line, scrolling, tabbing, tape store and retrieve, text printing. All in less than 2K byte plus workspace for up to almost two full screens. Price on 2 x 2708 EPROM £70 plus VAT.

TINY BASIC

A 2K BASIC Interpreter in 2x2708 EPROM. Normal commands: 1—32767 MSL/single array/arithmetic constant/ <>≤≥≠ /strings valid in PRINT/supplied with user manual/additional three level keyboard control/compatible with NASBUG and B.Bug Price £25 Plus VAT.

An extended version of the above is our SUPER TINY BASIC which has all the TINY BASIC functions plus full editing features and additional operator command. Price in 3x2708 EPROM £35 plus VAT.

ZEAP

An editor assembler which runs under NASBUG and provides the powerful advantages of writing programs in Z80 assembly language instead of directly in machine code. Uses less than 3K bytes of memory and is supplied on cassette priced £30 plus VAT.

nm

Nascom Microcomputers

121 High Street,
 Berkhamsted,
 Herts.

Tel: (04427) 74343

● Circle No. 179

April

● **3-5** **Computermarket**, Bloomsbury Centre Hotel, London WC1. Exhibition for computer buffs reaches London after two weeks travelling round the country. All types of equipment on show. Free. For further details contact Couchmead Ltd, 46 New Cavendish Street, London, W1. Telephone: 01-437 4187.

● **3-12** **Course in computer appreciation for businessmen and learning Basic**. Venue: Northern Software Consultants Ltd, 15 Cross Street, Manchester. This software company decided to hold a series of courses for businessmen and those interested in grasping the rudiments of Basic. On April 9 there is a one-day course for businessmen and from April 10-12 a three-day course for those wanting to learn Basic. That costs £150 plus VAT and the one-day course is £50 plus VAT. Only 20 people are accepted for each course but if you are late for this one, there are others from May 8-11 and June 11-14.

May

● **4-6** **Southern Microcomputer Industry Show**. Venue: Expo Hall, Exposition Park, Orlando, Florida. If you have always fancied a trip to sunny Florida, this could be your ideal opportunity to mix business with pleasure. All the latest U.S. technology will be on display. Contact Bud Felsburg, Felsburg Associates, Inc, PO Box 735, Bowie, MD 20715.

● **8-10** **Compec Europe Exhibition**, Brussels. Similar type of exhibition to Compec but with a European flavour. Contact Iliffe Promotions Ltd, Dorset House, Stamford Street, London SE1 for further details.

● **12** **Personal Computer World**. Venue: West Centre Hotel, 47 Lillie Road, London SW6. Seminar/Mini Exhibition. More information from POW Exhibitions, 62A Westbourne Grove, London W1.

● **15-17** **Micro/Expo 79**. Venue: Paris. Promises to be one of the leading microcomputer and personal computing exhibitions in Europe. The themes will be personal computing, new products and industrial applications. Organiser: Sybex Europe, 313 Rue Lecourbe, 75015 Paris, France. Tel: (1) 828 2502.

June

● **19-21** **International Microcomputers, Minicomputers & Microprocessors 79**. Venue: Geneva. Five thousand visitors from all over the world descended on Geneva for the corresponding show last year. Attracts many top European computer companies. Organisers: Kiver Communications, Surbiton, Surrey. Tel: 01-390 0281.

● **28-30** **The Great British Electronics Bazaar**. An electronics bazaar on tables laid in street market fashion. Aimed at the amateur, hobbyist and small professional buyer. *Practical Computing* plus many other computer firms will be there. Venue: Alexandra Palace, London. Organisers: Evan Steadman Communications Group, Saffron Walden. (0799) 22612.

July

● **5-7** **Microcomputer Show**. Last year it was called the Do-it-Yourself Computer Show. Now it has been expanded and moved to a new venue, the Bloomsbury Centre Hotel. We have a particular affection for this show as we launched *Practical Computing* there last year. In addition to many exhibitors, there are also three days of conferences. Thursday concentrates on *Micros in Light Industry*; Friday is devoted to *Personal Computers in Business*, and Saturday to *Personal Computers in the Home*. Speakers include Portia Isaacson, Adam Osbourne, John Coll and Guy Kewney. Highly recommended. Come and see us on our stand. Organisers: Online Computers, Uxbridge. Tel: (0895) 39362

● *If you have an event you would like us to include in our diary columns, write to Practical Computing, 2 Duncan Terrace, London N.1.*

User Groups

BEDFORDSHIRE
6502 Users' Working Party
W R Wallenborn
21 Argyll Avenue
Luton, LU3 1EG
Tel: 0582 2697 (evenings)

BERKSHIRE
77/68 User Group
Newbear Computing Store
Bone Lane
Newbury
Tel: 0635 49223

BUCKINGHAMSHIRE
Nascom User Group
Lynx Electronics
92 Broad Street
Chesham

CAMBRIDGESHIRE
Cambridge University Processor Group
Emrys Williams
Cavendish Laboratory
Downing College
Cambridge
TI990 User Group
Simon Garth
8 Kestrel Place
St. Neots
Huntingdon
Cambs.

DERBYSHIRE
Independent Pet Users' Group
Mike Lake
9 Littleover Lane
Derby
Tel: Derby 23127

DEVON
Exeter and District Amateur Computer Club
David Carne
44 George Street
Exmouth
Devon, EX8 1LQ
Tel: 039 52 74479
South West Group Amateur Computer Club
G V Barbier
Palmer's Hill
Calverleigh
Tiverton, Devon

EIRE
Computer Education Society of Ireland
7 St. Kilmaind
Blackrock
Co. Dublin
Ireland

ESSEX
Cromemco Users' Group
313 Kingston Road
Ilford
Amateur Computer Club
Mike Lord
7 Dordells
Basildon
Essex
Note: Membership throughout U.K., with many regional clubs and a newsletter.

GLOUCESTERSHIRE
Cheltenham Amateur Computer Club
M. P. Pullin
45 Merestones Drive
The Park
Cheltenham
Tel: Cheltenham 25617
Heath Kit User Group
Gloucester GL2 6EE

HAMPSHIRE
Southampton University Amateur Computer Club
Paul Maddison
Students Union
University Road
Southampton SO9 5NH

HERTFORDSHIRE
Bywood Scrumpi User Group
68 Ebbens Road
Hemel Hempstead HP3 9QRC
Tel: 0442 62757

KENT
Gillingham User Group
A. Aylward
194 Balmoral Road
Gillingham

LANCASHIRE
Northwest Group Amateur Computer Club
Ken Horton
50 Lymfield Drive
Worsley
Tel: 061-228 6333 ext. 372

LINCOLNSHIRE
Lincolnshire Microprocessor Society
Michael Lyne
Far End
Far Lane
Coleyby
Lincoln LN5 0AH
Tel: 0522 810468

LONDON
North London Hobby Computer Club
Acting Club Secretary: Robin Bradbeer
Department of Electronics and Communications Engineering
Polytechnic of North London
Holloway Road
London N7 8DB
Stephanie Bromley
607 8663 (office)
359 2282 (home)
M O'Reilly
607 2789 ext. 2100
South East London Microcomputer Club
Don Hicks
Breakspears Road
Lewisham Way, SE4 1UT
Tel: (01) 692 0353 ext. 358
U.K. Pet Users' Club
Commodore Systems
360 Euston Road, NW1 3BL

MANCHESTER
Manchester User Group Amateur Computer Club
P. Wade
26 Wolseley Close
Radcliffe
Manchester M26 0AG
Tel: 061-723 1021

MIDDLESEX
Harrow Group Amateur Computer Club
Jim MacDonald
19 Cowper Road
London W7 1EL

MIDLANDS
Midlands User Group Amateur Computer Club
Roy Diamond
27 Loweswater Road
Coventry CV3 2HJ
Tel: 0203 454061

NOTTINGHAMSHIRE
U.K. Apple Users' Group
Chairman: Dr Tim Keen
5 The Poultry
Nottingham
Tel: Nottingham 583254/5/6

OXFORD
Research Machines Users' Group
PO Box 75
Oxford

TYNE AND WEAR
Newcastle Personal Computer Society
Dr. W. G. Allen
Department of Electrical Engineering and Physical Electronics
Newcastle-upon-Tyne Polytechnic
Ellison Place
Newcastle-upon-Tyne NE1 8ST

SCOTLAND
Scottish Amateur Computer Society
Stewart Stevenson
Lindsafarne
New Well Wynd
Linlithgow
West Lothian
Tel: Linlithgow 2657

WORCESTERSHIRE
Z-80 Group
Roger Sinden
The Corner House
Birlingham
Near Pershore
Tel: Evesham 750251

Note: We plan to run an update of clubs every three months. If your club is not mentioned, write to the Editor, *Practical Computing*, 2 Duncan Terrace, London N.1.

The microcomputer for those who need more than the minimum. The right processor for business, scientific and educational use. Proven applications include Games • Educational • Word Processing • Invoicing • Stock Control • Sales Ledger • Purchase Ledger • Mailing • Scientific.

THE NEW HORIZON

Languages

Powerful Basic including sequential and random access disc files • formatted output • strings • line editor • machine language CALL • many other facilities. Optional additional software (under CP/M operating system) includes BASIC

The Horizon computer includes:-

Specification

Zilog Z80A MPU • S-100 bus (12 slots) • Solid well-built case • Up to four Shugart mini-floppy disc drives, 180KB each • Serial port for CRT or Teletype • Real-time clock on motherboard •

Optional additional serial port and parallel port • Powerful operating system and monitor • Access to wide range of S-100 special application boards.

compiler, FORTRAN and COBOL.

Horizon Z80A computer with 2 double-density disc drives and 24K RAM £1,823 (exclusive of VAT and carriage).



Equinox Computer Systems Ltd,
32-35 Featherstone Street,
London EC1Y 8QX.
Tel: 01-253 3781/9837.

MICRO MEDIA SYSTEMS
12 Clarence Place
Newport, Gwent.
Tel: 0633 50528

● Circle No. 180

Expand your Pet to its full capability with these professional peripherals

Dual floppy disk unit

A COMMERCIAL GRADE DISK SYSTEM FOR THE PET

- Up to 800K Bytes on Line Mass Storage
- High Speed D.O.S. in ROM
- Effectively doubles PET operating system commands
- Complete documentation allows use of full resources
- Handles up to four disk drives
- Includes Commercial Printer Support
- Adds 16 commands to PET basic
- Automatic self reorganisation of free space on disk after each save or erase command
- Free space is never fragmented

PRICE £840.00 + VAT

Expandem memory expansion board

General purpose expansion system for PET and other 6502 Computer Systems (e.g. KIM, SIM, AIM).

- 24K to 32K Low Dissipation RAM
- Mounting slots for 4 option cards
- All necessary cables and brackets
- Disk Controller
- Parallel I/O
- Sockets for Eprom
- Flexible Serial I/O
- S100 I/O Driver

24K Board £320.00 + VAT

Plessey Petite add-on memory
From Europe's largest memory board supplier

Stand-alone, plug-in memory expansion. Available in 8K, 16K, 24K, and 32K versions. Complete in case with built-in P.S.U.

24K £449.00 + VAT



PET 2001-4 4K Bytes of Memory £460.00 + VAT

PET 2001-8 8K Bytes of Memory £550.00 + VAT

PET 2ND Cassette Unit £55.00 + VAT

PET Sound Box Plugs direct into 2nd Cassette Port complete with Demo Software £12.03 + VAT

PET Dust Covers To protect your PET—(Four Colours) Rust, Blue, Beige, Green £8.33 + VAT

PET TV Interface Plugs direct into user port Superb Specification £45.29 + VAT

Software

We supply all Commodore, Petsoft and Compuette programs. We should be glad to quote for dedicated software applications.

R.H. Mastermind: Surely the best Mastermind ever. 3 Games levels. £5.00

R.H. Shape Matching: Match up two different shapes to score. You against the other guy. You will have to be sharp for this one. £5.00

Estate Agency: Very cheap, very effective method of showing properties to customers. Automatic deletion. Printed copies for prospective purchasers (Now available on disk). £25.00

Access and Barclaycard accepted for Telephone and Postal Orders.

All prices include post and packing (insured post extra).

We should be glad to discuss your problems or requirements relating to technical matters, software, etc—in-house software experts available.

Dealer enquiries Invited for all our stock items.

All new equipment sold by us carries a 12 months' guarantee

HB COMPUTERS LTD

Computers for Business & Home

22 Newland Street
Kettering Northants
Telephone (0536) 83922/
520910



Five-decade meter built from TTL

by NICK HAMPSHIRE

SOME YEARS ago I built a five-decade frequency meter from TTL, with a 'Nixie' neon tube display. It contains about 25 TTL devices, a crystal-controlled oscillator, a 5V power-supply line for the logic and a 180V line for the neon tubes.

Months of effort went into designing and testing the circuits, printed circuit layouts, etching, drilling and soldering. An aluminium box had to be bought, cut and painted, and the front panel labelled before being varnished.

Since then, this creation has seen much reliable service, except that occasionally it requires a sharp thump to clear a faulty connection on one of the display boards.

In frequency meter mode, each input cycle adds one to a count stored in five decade counter chips (SN7490). Every second, or one-tenth of a second, or 10 seconds, the total count is transferred from the 7490 counters into five four-bit latches (SN7475).

Immediately after this the five counters are re-set to zero and the count re-starts. In any particular one-second 'slot' the display shows the number of cycles in the previous one-second slot. After each time-slot the display is updated. Resolution is therefore plus or minus one cycle.

With a one-tenth of a second time slot the display is updated more often but the resolution falls to plus or minus 10 cycles. The highest frequency which may be displayed is just short of one megahertz. Should the counter be set to accumulate over a 10-second period, the resolution rises to plus or minus one-tenth of a cycle.

Six other divide-by 10 counters divide a 100KHz crystal-controlled oscillator frequency to provide a range of time-slot periods. A rotary switch is used to select the desired range.

Commercially-available frequency meters range in price from about £75. It is possible, however, to use the Kim-1 microprocessor board to simulate most of the logic for such an instrument. The seven segment LED displays will be the visible output. The user timer on the P10 will generate the time-slot signal—after all, it is crystal-controlled.

SCANS, the monitor display routine,

continually displays the six Binary Coded Decimal digits stored in DISP (\$F9, \$FA and \$FB). DISP therefore replaces the latch chips in my TTL version. Three further locations TALLY (\$06, \$07 and \$08) act as the counters, keeping a tally of the number of input cycles per time-slot.

The program breaks into three sections. From the label G01 to where the interrupts are enabled (CLI) the counter and display locations are cleared, the user ports are set up and TIME is loaded with the number of millisecond P10 timer delays per time-slot.

Only two instructions form the main program loop. One calls the subroutine SCANS and the next jumps back to the label MAIN to repeat this operation continually.

Interrupts

It would appear that the program will display only the initial contents of DISP. Since these locations are set to zero the display would be '000000'. Were it not for the interrupt capability of the M6502 processor this would be the case. The third part of the program is the interrupt handler and polling routine.

When an interrupt occurs a number of things happen. After execution of the instruction being performed has been completed, the main program is suspended temporarily. The current value of the program counter, the contents of the A-register and the processor condition codes are all saved by being pushed on to the stack.

Next the program counter is loaded with the address of the code to be performed after an interrupt. This address (\$0051 in this program) is stored in the Kim-1 in locations \$17FE and \$17FF. Code starting at this address is then executed normally until a return from interrupt instruction is encountered (RTI).

At this point the current contents of the program counter are discarded and replaced by those saved previously on the stack. The A-register and condition codes are also restored. Processing then continues from the next instruction of the main program, the interrupt having been 'serviced'.

An interrupt may be made to occur

(continued on next page)

CALCULATORS

SCIENTIFIC

SPECIAL OFFER
TEXAS TI59 together with PC100C
(Complete as manufacturers specifications)
£285.00

- TEXAS/HP Accessories available
- *TEXAS TI59 (New Card prog 960 prog steps or 100 mem) £156.50
 - *TEXAS I58 (New Key prog 480 steps or 60 mem) £60.00
 - *TEXAS PC100C (New updated Printing Units for TI58/TI59) £140.00
 - *TEXAS TI57 (Key Prog 8 Mem. 150 Key Strokes/50 Prog Steps) £26.30
 - TEXAS TI33 (as TI30 but 3 Mem.) £13.95
 - *TEXAS TI45 (8 Dig slide Rule with Exp Mem Green Display) £19.95
 - *TEXAS 42MBA (10 Dig Fin/Stat Prog 12 Mem 32 key strokes) £42.95
 - *TEXAS TI PROGRAMMER (Hexadecimal Oct) £46.50
 - *TEXAS TI51/III (New 8 Dig + Exp 10 Mem 32 Prog Steps, Stat/Sci) £26.30
 - TEXAS TI25 (new LCD Sci/Stat) £18.90

SPECIAL INTEREST

TEXAS TI58 or TI59

with Pre-Programmed Applied

Statistics Module

This branch of applied mathematics

is useful in many fields: from

medicine to political science and

quality control to mechanical design.

Module includes:

Random Number Generator

Data Entry Programs

Means and Moments

Histogram Construction

Theoretical Histogram

Data Transforms

t Statistic Evaluation

Contingency Table Analysis

Two-way Analysis of Variance

Rank Sum

Multiple Linear Regression

One Way Analysis of Variance

Normal Distribution

Binomial Distribution

Chi-Square Distribution

t & F Distribution Diagnostic

*TEXAS TI58 with Applied Statistics £80.00

*TEXAS TI59 with PC100C & Applied Statistics £305.00

WINTER SALE

TEXAS TI59 Calculator (complete as manufacturer's spec.) PLUS statistics module & extra set of 40 Blank Prog. Cards with wallet etc.

ONLY £180

*CBM 561 (Stat + SCI & Mem NS Div Chi Sq, Dia, Lin Regr. etc.) £46.00

*CBM 9190R (as 9190R but 9 Mem) £27.50

*CBM Pro 100 (72 Step Prog) £29.50

*HP 19C (Cont. Mem. Key prog, Printer) £129.00

*HP 29C (as 19C but no Printer) £93.00

*HP31E (New Sci replaces HP21) £35.00

*HP32E (Adv Sci with Stat) £50.00

*HP33E (8 Mem Prog. Sci/Stat) £64.00

*HP 67A (Card Prog. 224 Steps 26 Mem) £257.75

*HP 97A (Fully prog. with Printer) £442.00

*CASIO FX201P (Sci, 11 Mem, 127 step Key Prog) £44.50

CASIO AQ 1000 (LCD Cal 3-way Stop Watch/Alarm) £20.00

CASIO FX3100 (New version of FX3000-LCD Sci/Std/Div. Poles Rec etc) £22.50

CASIO FX8000 (as above + Stop Watch/Alarm) £27.73

THE COMMODORE PET

COMPUTER

with 8K bytes RAM 2001-8

A complete personal computer

that operates anywhere by simply

plugging into Mains supply. Allows

communications directly from BASIC

to IEEE—488 standard devices—

Cassette, Video Display Unit

& Keyboard built into PET.

Fully guaranteed Warranty to CBM

complete only £643

NOW IT'S YOU AGAINST

'COMPUTERS'

Borris is the most advanced chess

computer yet. Borris is ideal for

learning and improving your chess

game from beginner to master.

Borris can play against himself

has Alpha-Numeric prompting to

help improve play and by simple

switching you have facility to follow

Borris's 'thinking' while he analyzes

position before making a move.

Walnut case wooden chess men

board mains adapter etc. £184.00

Chess Challenger '10' (10 Levels of

beginner to master) £180.00

FREE—Mains/charger included.

GOODS FULLY GUARANTEED.

PRICES EXCLUDE VAT (ADD 8%)

BUT INC P. & P. CHEQUE WITH ORDER

Company/hospital and Government orders

accepted by phone.

Barclaycard/Access accepted by 'phone

Tel. : 01-455 9823

EXPORT ORDERS WELCOMED

Air Freight/Air Post Delivery.

Quotations on request.

MOUNTAINDENE

22 Cowper St. London EC2

● Circle No. 182

PET 2008

Now on show in
BIRMINGHAM

Come along and see the fabulous PET, at work and play in our newly opened showrooms.

Systems start at only £550 + VAT

Business Programs to give you Hands-on experience.

Stockists of Petsoft.

Try before you buy.
Full after sales care.

Camden Electronics (Comp. Div.)
1st Floor, 462 Coventry Road
Small Heath, Birmingham B-10.
021-773 8240

● Circle No. 183

P. I. P. S. COMPUTER SERVICES

North-East England distributors for the best selling micro, the

APPLE II

Full range of accessories and software can be supplied.

Telephone John or Jane Page on (0632) 482359 to discuss your requirements.

NEWCASTLE UPON TYNE

● Circle No. 184

TANDY TRS-80 from £449.

Disc & Printers now available

Commodore PET. New low prices. Petsoft and personalised programs available e.g. Payroll, estate agents etc.

Radio Supplies (Swansea) Ltd
80 Gower Road
Sketty
Swansea

Tel: 0792 24140.

● Circle No. 185

(continued from previous page)

only if the 'interrupt flag' in the condition codes register is cleared (with CLI). It occurs when the IRQ line on the processor is forced to a low state, less than 0.4 V. As it would be undesirable for an interrupt to interrupt the processor during a call to the interrupt handler, this IRQ facility is disabled between the call and its RTI; therefore only one interrupt may be serviced at once.

This simple situation is satisfactory so long as there is only one source of interrupts in the set-up—for instance, if only the incoming pulses are interrupt-driven.

In fact, there are two sources of interrupts in the current program. One is generated internally, from the P10 timer section. The timer is set-up to cause an interrupt every 1,024 microseconds, by loading C1024E with one. After that time has elapsed the program jumps, under interrupt control, to INTVEC. By checking if the top bit of location SR is set, we can tell if it was indeed the timer or another source; these are dealt with at INPUTV.

If it was the timer, then a 16-bit increment by one is performed on locations COUNT and COUNT+1. At the same time the contents of COUNT and COUNT+1 are compared to the contents of TIME and TIME+1.

Sampling

TIME and TIME+1 contain the number of 1,024-microsecond time units which comprise the desired sample time-slot for the frequency meter. They are set up at G01, G02 and G03 with the relevant values stored previously in TENTH, ONE and TEN.

While the contents of the COUNT

locations are not equal to those in the TIME locations, and RTI is executed immediately. When COUNT shows finally, that TIME time units have passed, locations COUNT and COUNT+1 are cleared ready to count the next time slot.

The three TALLY locations are transferred to the three DISP so that the number of input pulses in the last time-slot is displayed by SCANS in the next. These TALLY locations are also cleared ready to keep tally of the number of incoming cycles in the next time-slot.

If it was not a timer interrupt then it was caused by the falling edge of an incoming pulse. The code for these starts at INPUTV. For each incoming pulse one is added to the three TALLY locations.

By first setting the decimal adjust mode on the M6502 with an SED instruction, adding one to a location no longer causes that location to count in 256 binary steps. Instead, the eight-bit byte is treated as two separate four-bit BCD digits. Therefore there are 99 steps between 'zero-zero' and 'nine-nine'.

A half carry between these two digits as well as the normal full carry mean that a 24-bit increment in BCD is as easy as in binary. Should the contents of the TALLY locations overflow—greater than 999999—then PAO is set. Since this situation must not occur with the current parameters it should be interpreted as an error, not as an extra digit(s) overflow. It will be cleared at the beginning of the next time-slot by INTVEC.

Finally, in INPUTV there is a call to subroutine CLR74, which clears the external interrupts flag provided by the small circuit used in conjunction with the program (Figure 1). Unfortunately it is

(continued on next page)

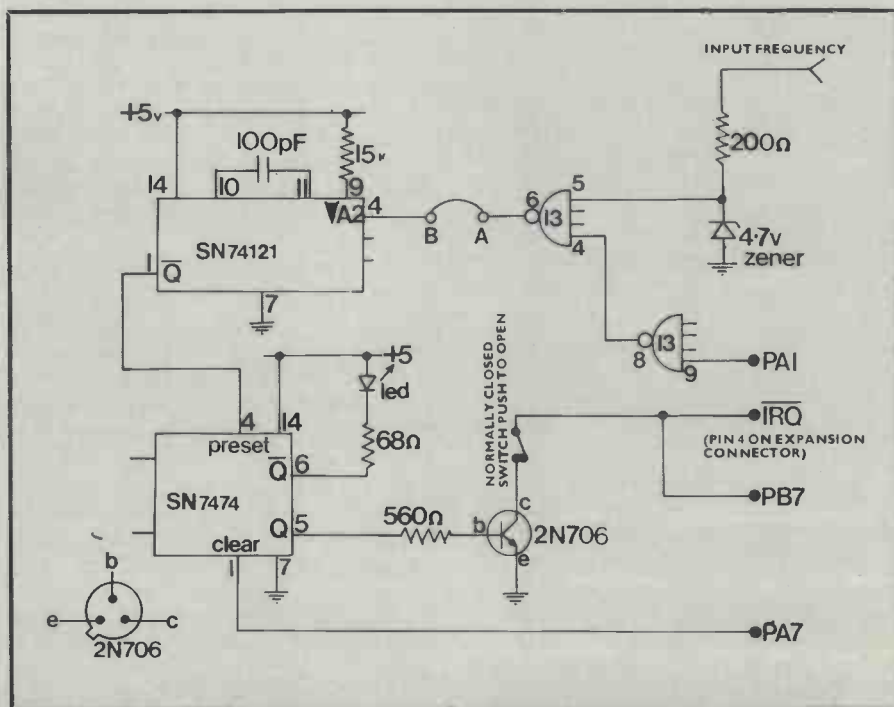

Figure 1. All un-numbered pins are un-connected.



(continued from previous page)

not enough to square-off the input waveform to be TTL-compatible and feed this directly into the IRQ line to cause the interrupt.

As there is no fixed mark: space ratio, it means that the IRQ line is held low for an undefined period. Should IRQ still be low after the RTI is performed, the processor would jump back immediately into the interrupt handler and count the same pulse again.

Nor is it possible to use a monostable directly to contract the pulse so that it is always shorter than the time taken by the interrupt handler. If we did this and the pulse occurred while the program was servicing a timer-generated interrupt, it would ignore that pulse altogether, since the interrupt mask is set while the program is in the handler.

Precise squaring

Instead, an SN7474 D-type flip-flop latch is used to 'remember' the interrupt until it is serviced. Each cycle of the waveform is squared and made TTL-compatible [by a SN7413 dual four-input NAND schmitt gate. The schmitt effect is particularly useful in this application as it provides a degree of hysteresis. The input voltage must rise above a threshold (1.62V) before the output falls—it is an inverting device.

Moreover, before the output rises again the input must fall below a second, rather lower, threshold (0.83V). This causes precise squaring of the input waveform under most conditions.

This TTL waveform is inverted again by the second 7413 gate and each falling edge triggers a one-microsecond monostable (SN74121). The Q output of this device is fed to the PRESET input of the latch, causing its output to go high. While the latch Q output is high the 2N706 transistor conducts, pulling the IRQ line low and hence initiating the interrupt routines.

This transistor remains conducting until a call is made to CLR74, inside INPUTV. This subroutine feeds a logic zero to the CLEAR input of the latch. There is a similar circuit integrated into the P10 for the timer-interrupt device.

If the program is started at G01 (\$000F), the TIME locations are loaded with the number of 1,024-microsecond units required to tally the input pulses for one-tenth of a second.

One would expect that 97.66 units would be closest to the required value. Yet 94 (\$5E) gives the most accurate reading. This discrepancy is due to the timer causing an interrupt after exactly 1,024 microseconds, but not starting the next time unit until one is again loaded into C1024E—the half-dozen or so instructions between IRQ being pulled low and the timer being re-set being the difference.

GO2 (\$001A) loads \$3AF for a one-

second integrating time-slot and GO3 (\$0025) for a 10-second slot (\$24FE). By adjusting these values while comparing them to the readings given by the TTL meter, the reading given by the program should be accurate to within about 0.5 percent.

Continuous display

By modifying these values slightly it may be possible to 'tweak' the accuracy further. Uncertainty about the last digit is unavoidable with this technique and it will usually alternate with the digit higher or lower with each successive sample.

Once started, this program runs giving a continuous display of the input frequency, though remember to apply the appropriate scaling factors if GO1 or GO3 are used. Unfortunately, due to the way SCANS is coded, the interrupts tend to cause some 'scatter' of the display segments. This gets worse as the input frequency, and hence the interrupt rate, rises. Below about 2KHz the effect is noticeable; up to 4KHz the display is still readable.

By the time the input frequency reaches 6KHz the display is unreadable; above about 10KHz we are expecting the processor to spend more time in the interrupt handler than it can execute anyway and the effects are most interesting.

To lose this 'scatter'—segments flickering on which should be off—SCANS could be re-written using a different timing technique. Alternatively, the program could be changed to count the input waveform-generated interrupts while the program in a tight loop counted the elapsed time, then to display the results for about half a second with all the interrupts disabled (SEI). Some commercial frequency meters use this mode of operation.

Pre-scaling

The LED on the notQ output of the latch glows while the IRQ line is being held low due to an input pulse; the brighter it glows the higher the frequency. Sometimes, when the Kim-1 is re-set, the latch remains on 4 if the re-set happened while the 7474 was set. This situation upsets the program re-start.

Should the program fail to re-start, with this LED lit, a quick press on the normally-closed switch on the 2N706 transistor collector will release the IRQ line and the program will continue normally.

Since we are limited to an input frequency of one or two kilohertz, some method of pre-scaling higher frequencies to this range is required.

Figure 2 shows how an SN7490 decade-counter chip may be inserted between points A and B in figure 1 to divide the incoming frequency by 10. Any number of 7490s may be cascaded as shown to provide division by 100, or indeed any power of 10. These TTL pre-scalers are useful

(continued on next page)

Hybrid systems DAC-371-8, D/A converter, plugs into single IC skt, ttl, dtl compatible 8 bits binary or 2 decades bcd, with data, £22.708, (450ns) £6.85p, 2102 (500ns) 98p, 21L02 (250ns) £1.35p, 2513 (Upp case) £5, Micro-speech special synthesiser board, assembled and tested, £320 inclusive (sae with details and type of CPU being used. 2512V (dual 128 bit static shift reg (128 X 2) £1, TMS3128NC (shift reg) £1, N8293A (presettable I/power binary counter) 50p, zero edge connector 2245/2 (22 X 22) key at 7/h 35p, 1702 at £2.95, SN76477 £2.50 p/p 20p.

LB Electronics
43, Westacott,
Hayes,
Middx. UB4 8AH
England

Mail
Order
only

● Circle No. 186

PET NEWS

Floppy disk system
saddle mount twin £950

Compact free twin £916

Both units at last

Pet 2001/8 down in price to
£550 + VAT

for news of the Pet printer,
Pet floppy, Super Pet, EDV
Pet, keyboard, software and
dust-covers

WHY NOT SEND FOR FREE CATALOGUE

Intex Datalogic Ltd,
Eastcliffe Ind. Est.,
Eastcliffe /
Cleveland TB16 0PN
Tel 0642-781193

● Circle No. 187

CLAISSE-ALLEN COMPUTING LTD

5 Upper High Street,
Winchester SO23 8UT
(0962 69368)

Independent computer
consultancy for commercial
and technical applications

Special packages for:
Employment Agencies
Building Contractors
Agriculture

Standard commercial software
for HORIZON computers.

● Circle No. 188

Agents in
SCOTLAND
for the
**COMMODORE
PET**



Robox (Office Equipment Systems) Ltd.
84 Townhead, Kirkintilloch
Glasgow, Scotland

**SALES
SERVICES
SOFTWARE**

See us on Stand 449
KELVIN HALL, GLASGOW
March 19-23

Telephone: 041-776-4388

● Circle No. 189

£1.49

NIM—the popular matchstick game

£2.49

KAYLES—far more complex than Nim
PLOTTER—plots most functions
DISCOMANIA—a logical challenge
BULLS & COWS—like 'Mastermind'

£3.49

BREAKTHRU—similar to 'Breakout'
MINEFIELD—the kids' favourite
All programs are in PET Basic on
quality cassettes. Post paid.

SUPERSOFT 28 Burwood Avenue,
Pinner, Middlesex.

● Circle No. 190



**SCHOOL OF
ELECTRONIC
SYSTEM DESIGN**

are again offering the
One week Residential Course

**MICROPROCESSORS
and their application as
MICROCOMPUTERS**

April 2nd-6th

June 11th-15th

November 5th-9th

Organisation, software and hardware
implementation of 8080/85, Z80,
6800, 9900 and Bit-Slice micro-
processor families.

Further information from:

Registrar (Short Courses A), Cranfield
Institute of Technology, Cranfield,
Bedford, MK43 0AL. Tel. 0234
750111 Ext 284, or contact the
course organiser David Hyndman
Ext 311.

● Circle No. 191

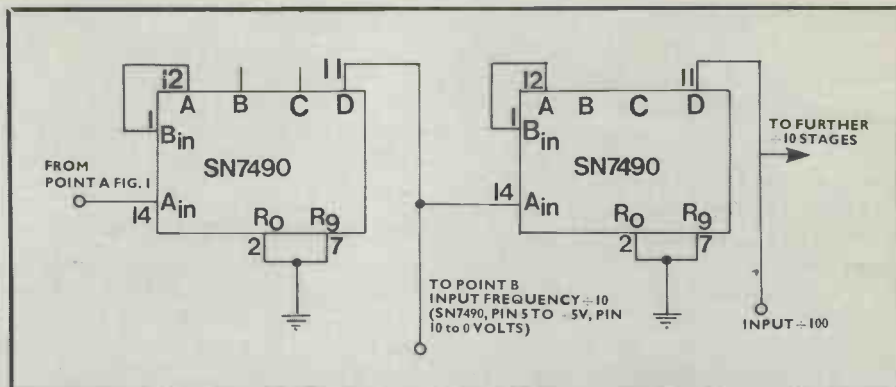

Figure 2. Frequency meter pre-scaler, each SN7490 divides by a further power of 10.

(continued from previous page)

only up to about 15MHz, although pre-scalers are available working up to many hundreds of megahertz.

By powering the Kim-1 from a car battery and taking the input from the vehicle contact-breakers, it could be used as a car tachometer. Were TIME to be loaded at the start of the program with 282, the engine RPM/100 would be displayed every 0.3 of a second—for a four-cylinder, four-stroke engine.

For a six-cylinder engine, TIME would be loaded with 188, giving the RPM every 0.2 of a second. Load 141 for an eight-cylinder every 0.15 seconds, and 94 for twelve cylinders every one-tenth of a second.

These figures are calculations—including the corrections—and may need tweak-

ing in practice. Remember that the back e.m.f. from an ignition coil can be substantial and that contact bounce could upset the reading. Some electronic ignition systems dispense with the contacts and these would be ideal.

A 4.7V zener diode and a resistor would provide some protection to the SN7413 and microprocessor card. The schmitt gate is damaged easily if the input strays outside the zero-to-5V range.

In tricky situations a voltage comparator, such as the LM311, would offer greater input sensitivity and electrical robustness. The output of such a component would still be fed into the 7413. While the input frequency is fed into one of the inputs, possibly through a capacitor to provide some DC de-coupling, a fixed reference voltage is applied to the other input.

```

;
; FREQUENCY METER PROGRAM FOR KIM-1
;
; SYSTEM LOCATIONS
SCANS    = $1F1F
C1024E   = $170F
SR       = $1707
DA       = $1700
DDA      = $1701
DB       = $1702
DDB      = $1703
DISP     = $00F9
TENTH    = .WORD $5E
ONE      = .WORD $3AF
TEN      = .WORD $24FE
TALLY    = ***3
COUNT   = **2
TIME     = **2
FLAG     = **1
XSTORE   = **1

; COUNT OVER A ONE TENTH, ONE OR
; A TEN SECOND PERIOD. STARTING AT
; G01, G02 OR G03.
G01      LDA TENTH+1
        STA TIME+1
        LDA TENTH
        STA TIME
        JMP START
G02      LDA ONE+1
        STA TIME+1
        LDA ONE
        STA TIME

        JMP START
G03      LDA TEN+1
        STA TIME+1
        LDA TEN
        STA TIME

; SETUP PA0-7 AS OUTPUT, PA0-7 AS
; INPUT. CONNECT P07 TO IRQ.
; SET SN7474 IS HIGH
    
```

(continued on next page)

(continued from previous page)

```

;SET ALL TIMER,COUNT AND DISPLAY
;LOCATIONS TO ZERO.
;START TIMER
002D A9 FF      START LDA #5FF
002F 8D 01 17  STA DDA
0032 A9 00      LDA #0
0034 8D 00 17  STA DA
0037 8D 03 17  STA DDB
003A 20 0E 01  JSR ZERO
003D 20 00 01  JSR CLR74
0040 A9 01      LDA #1
0042 8D 0F 17  STA C1024E
0045 A9 00      LDA #0
0047 8D 00 17  STA DA
;ENABLE INTERRUPTS
004A 58        CLI
;CONTINUALLY DISPLAY FREQUENCY
;AS A BACKGROUND PROCESS
004B 20 1F 1F  MAIN JSR SCANS
004E 4C 4B 00  JMP MAIN
;
; INTERRUPT HANDLER
;
; 1) FOR THE TIMER
;
0051 AD 07 17  INTVLC LDA SR
0054 10 3F      BPL INPUTV
;RESTART TIMER
0056 A9 01      LDA #1
0058 8D 0F 17  STA C1024E
;ADD ONE TO COUNT AND COMPARE
;WITH TIME.
005B A5 09      LDA COUNT
005D 18        CLC
005E 69 01      ADC #1
0060 85 09      STA COUNT
0062 A5 0A      LDA COUNT+1
0064 69 00      ADC #0
0066 85 0A      STA COUNT+1
0068 C5 0C      CMP TIME+1
006A F0 01      BEQ Q1
006C 40        RTI
006D A5 09      Q1  LDA COUNT
006F C5 0B      CMP TIME
0071 F0 01      BEQ Q2
0073 40        RTI
;TIME-UP TRANSFER TALLY TO DISP
0074 A5 06      Q2  LDA TALLY
0076 85 F9      STA DISP
0078 A5 07      LDA TALLY+1
007A 85 FA      STA DISP+1
007C A5 08      LDA TALLY+2
007E 85 FB      STA DISP+2
;RESET TALLY AND COUNT TO ZERO
0080 A9 00      LDA #0
0082 85 06      STA TALLY
0084 85 07      STA TALLY+1
0086 85 08      STA TALLY+2
0088 85 09      STA COUNT
008A 85 0A      STA COUNT+1
;CLEAR OVERFLOW INDICATION ON
;PA0
008C AD 00 17  LDA DA
008F 29 FE      AND #%11111111
0091 8D 00 17  STA DA
;RETURN FROM INTERRUPT
0094 40        RTI
;
; 2) FOR THE INPUT FREQUENCY
;
;ADD ONE TO TALLY
0095 F8        INPUTV SED
0096 A5 06      LDA TALLY
0098 18        CLC
0099 69 01      ADC #1
009B 85 06      STA TALLY
009D A5 07      LDA TALLY+1
009F 69 00      ADC #0
00A1 85 07      STA TALLY+1
00A3 A5 08      LDA TALLY+2
00A5 69 00      ADC #0
00A7 85 08      STA TALLY+2
00A9 90 08      BCC Q3
;IF CARRY FROM 999999 THEN
;SET PA0 TO INDICATE OVERFLOW
00AB AD 00 17  LDA DA
00AE 09 01      ORA #%00000001
00B0 8D 00 17  STA DA
;RELEASE IRQ LINE BEFORE RETURN
00B3 20 00 01  JSR CLR74
00B6 40        RTI

```

(continued on next page)

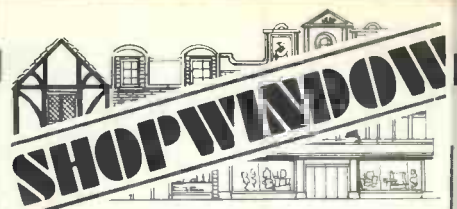

Small business systems HORIZON

with
Double Density Disc Drives
(as reviewed in this month's
Practical Computing)

Application software; word processing, letter writer, complete records, bookkeeping, sales ledger, purchase ledger, insurance brokers' package, etc.
price from £1,328

MICRODATA
71 Deepdale Drive,
Rainhill,
Merseyside
051-426 7271
(callers by appointment only)

● Circle No. 192

KEYBOARD KIT

Features: 1) Full ASCII encoding, all upper- and lower-case and control codes can be generated.

- 2) Single supply— +5v at 120 mA.
- 3) All T.T.L. encoding.
- 4) long keystroke (3 mm) keys.
- 5) Re-legendable keytops.
- 6) 53 keys and space.
- 7) Circuit and full assembly instructions supplied.

PRICE £28.50 including VAT.
Quantity discounts available.

**VIDEO-TERMINALS, 197, Hornbeams
Harlow, Essex**

● Circle No. 193

TRS-80 SOFTWARE

All types of Software for the TRS-80. Imported and U.K. written! Business, games and general programs stocked for same day shipment. A few examples:-

Use Programmable File Handling	£14.95
Microchess	£14.00
Cross Reference	£7.95
Star Trek	£14.95
Accounts Receivable	£19.95
Inventory Management	£19.95
Slot Machine	£9.95
Space Fighter	£9.95

Send SAE for full listing and addition to our mailing list.

A. J. HARDING
28 Collington Avenue,
Bexhill-on-Sea, E. Sussex
Tel: (0424) 220391

● Circle No. 194

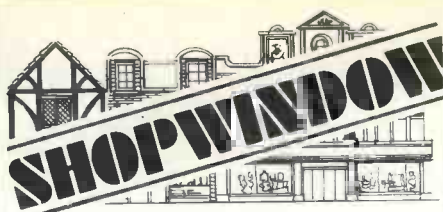

GRAFFCOM PROFESSIONAL BUSINESS SYSTEM

We can offer a complete Turnkey installation with everything including evaluation, system design, installation and training.

Our range of systems handles payroll, accounts, inventory, invoicing, financial planning, plus any specialised applications you require.

Why not contact us Today?

GRAFFCOM

52 Shaftesbury Av., London W1
01-734 8862

GRAFFCOM

● Circle No. 195

Teletype 43 KSR in "as new" condition, £770

Qume Sprint One 45cps Daisywheel printer complete with Daisy Terminals' microprocessor-controlled interface unit giving both RS232C (V24) and 20mA current mode interface from 110 to 120 baud. £1,250 for quick sale.

Telephone Tunbridge Wells (0892) 31812 or 38414 during office hours.

● Circle No. 196

NOW OPEN BIRMINGHAM'S OWN COMPUTER STORE

Pet. 2008. Personal complete £550.00
Kim 1. Micro system. £99.95
Betsi. Pet to S100 Expansion unit. £142.00
Kimsi. Kim to S100 Expansion unit. £142.00
Exidy Sorcerer 32k. Z-80 £850.50
Exidy to S100 Expansion unit £210.00
NASCOM 1. + Free B. Bug & 4 tapes. £197.50
Special. 12" video monitor £692.00
Byte, KILOBAUD, & 6502. Magazines.
ADD VAT. 8% to all orders.
Mail order add £1 p.p. SAE for lists
Demonstrations Daily—
10 a.m. - 7 p.m. Try before you buy.
CAMDEN ELECTRONICS.
1st Floor, 462 Coventry Rd.
Small Heath, Birmingham. B10
021-773 8240

● Circle No. 197

(continued from previous page)

```

00B7
;
; *=$100
; SUBROUTINE TO RELEASE IRQ
; BY CLEARING SN7474 LATCH
CLR74 LDA DA
AND #20111111
STA DA
ORA #21000000
STA DA
RTS
;
; SUBROUTINE TO ZERO ALL
; COUNT AND DISPLAY LOCATIONS
ZERO LDA #0
STA COUNT
STA COUNT+1
STA TALLY
STA TALLY+2
STA TALLY+1
STA DISP+1
STA DISP+2
STA DISP
RTS
; LOAD INTERRUPT VECTOR WITH
; HANDLER ADDRESS
*=$17FE
0121 IRG .WORD INTVEC
17FE 51 00
;
1800
SECOND PASS FINISHED O.K.
SYMBOL TABLE
29
SCANS 1F1F C1024E 170F
SR 1707 DA 1700 DDA 1701
DB 1702 DDB 1703 DISP 00F9
TENTH 0000 ONE 0002 TEN 0004
TALLY 0006 COUNT 0009 TIME 000B
FLAG 000D XSTORE 000E GUI 000F
GO2 001A GO3 0025 START 002D
MAIN 004B INTVEC 0051 Q1 006D
Q2 0074 INPUTV 0095 Q3 00B3
CLR74 0100 ZERO 010E IRG 17FE
END OF ASSEMBLY

```

Due to circumstances beyond our control, this article could not be included in last month's issue. We apologise to our readers who may have been inconvenienced as a result.

Using Kim-1 to aid motor control

HALF the fun of owning a microprocessor such as the 6502-based Kim-1 is being able to control things. The user should not be constrained to use only the hexadecimal keypad and the seven-segment displays. Think of the potential when you can switch electric motors on and off, set their direction and select a suitable speed, and make light bulbs glow, flash and glimmer.

The circuits required are simplicity personified. Further, the basic design can be updated by changing a few component values and types. Any small DC load can be switched. Apart from motors and lamps, they will activate relays and solenoids, thereby widening the scope for control of much heavier electrical loads.

This could be your chance to computerise that model train set or racing car lay-

out. Not only can the speed and direction of the engine or vehicle be varied, but also the points and lights can change automatically, allowing some complex manoeuvres.

In the home

Perhaps you might consider tackling something about the home. Curtains which close automatically at dusk, as the lights switch on, and then open at dawn would act as practice before moving to more serious ventures, such as the central heating, or converting the washing machine controller to the magic of microprocessors.

You could be the first person in your street to use last year's Christmas present to make the lights on next year's tree wink

(continued on next page)

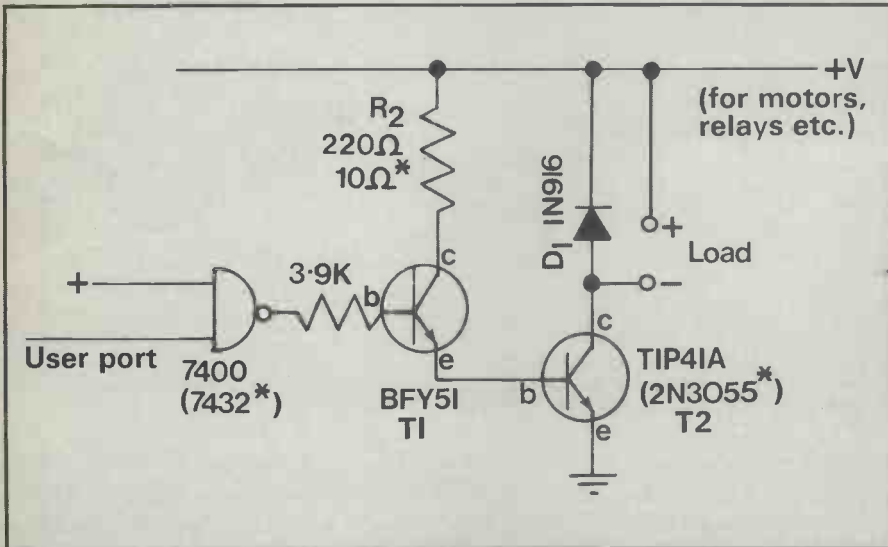

Figure 1. Basic transistor switch (*see text).

(continued from previous page)

in a most perplexing fashion. With a little time and ingenuity, mind-blowing gyrations of disco lights could be achieved.

As with past Kim projects, the body of the code in our sample programs is written as a handful of subroutines. They are then available for you to incorporate into your programs, as well as being demonstrated in a number of test programs.

They may do what you want in themselves but in any case they allow you to experiment with the circuits as soon as the program is keyed-in. At the heart of the code are eight subroutines (ON1, OFF1, ON2, OFF2, ON3, OFF3, ON4 and OFF4) which may be called to set selectively or clear any of the first four bits of the user port PA0-PA3.

Figure 1 shows the basic circuits configuration for switching small DC loads, ones which range from six to about 25 volts, with current consumptions generally less than a few amps. When the output of the inverting gate G1 rises, the emitter of T1 rises to about the same voltage as its base. Current then flows through the current-limiting resistor R2 and T1 into the base of T2.

While the base of T2 is held more than 0.8 volt above its emitter, the device will conduct. Current may then flow through the load. When the output of G1 falls to a logic zero level, the emitter of T1 also drops to a low voltage level and so T2 ceases to conduct.

Low current gain

The power transistor specified, a TIP41A, has a serious disadvantage. It has a low current gain. This means that if it is to pass a large current through its load, T1 must in turn supply a smaller, but still high, current into its base. R2 is placed in the circuit to prevent excessive current flowing through T1.

On the first prototype breadboard of this circuit a rather low value of R2 was

tried first. T1 is expected to drop the load line drive voltage down to about +3 volts. With a low resistance load drawing through a high current, a correspondingly high current flowed in T1—which got hot and shimmered slightly blue. Then I touched the transistor can with my finger to see if it really was hot—and it was.

Heat problem

I threw the burnt-out device into the bin, selected a higher value for R2 and tried again. The moral of this story is not to use the TIP41A to drive loads of more than one amp.

A 2N3055 power transistor has a much higher current gain and R2 can be reduced to as low as 10 ohms without endangering T1. Currents up to many amps may then be switched. The output transistor T2 should not become hot. Either it is not conducting at all, in which case no current flows and power dissipation is zero, or it is conducting with only a small potential drop across its emitter and collector.

Protection

In that case the power dissipated by T2 is less than one watt for each amp flowing through the load. Diode D1 is included in the circuit to protect the other components from back emf spikes often produced by inductive loads, such as motors, relays and solenoids.

Four identical circuits were built-up on a single printed circuit board for the prototype. This is convenient, as each TTL 7400 package contains four gates. By using an inverter for G1, the load is switched on only if the gate input is low (Active Low). This way seem illogical at first; there is, however, a good reason.

When the microprocessor is re-set all the user port lines are set to be inputs. They then appear as a logic '1' to the inputs of TTL gates are still connected. If

(continued on next page)

TOPMARK Computers

dedicated to

APPLE II

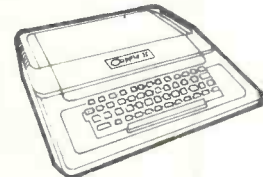

Simply the best!

Full details from Tom Piercy on Huntingdon (0480) 212563 or circle enquiry card.

● Circle No. 198

THE SORCERER

This professional but low-cost computer can now offer CP/M, word processing, APL, high capacity discs, etc. Our experience of business systems, together with the capabilities of the SORCERER, can give you a very effective small business system.

For a demonstration or a quotation for software, contact:

BASIC COMPUTING

Keighley (W. Yorks)
tel. 65094

● Circle No. 199

HUMBERSIDE MICROPROCESSOR SERVICES THE COMPLETE INDEPENDENT SERVICE

Application areas:-

Business, process control, education,

Personal Computing

We can provide for you:-

Consultancy, training, supply, maintenance and software to suit your individual requirements

Including

Commodore P.E.T.

M6800

Compec 202

and full ancillary equipment.

Microprocessor Services,

139 Beverley Road,

Hull

Humberside.

For further details ring (0482) 23146

● Circle No. 200

NORTH LONDON AGENTS FOR PET

For the best deal, come to the experts. Professional advice given in setting-up your own system.

DAVINCI COMPUTERS Ltd.,

Classic Offices, rear of Classic Cinema,
Hendon Central,
London NW4
01-202 4646

● Circle No. 201

NORTH STAR HORIZON

The microcomputer for those who need more than the minimum—at the right price.

Now available from:-



Wisbech Computer Services Ltd

10 Market Street, Wisbech, Cambs.
PE13 1EX
Telephone- Wisbech (0945) 64146

● Circle No. 202

MAILING SERVICES

Computer held files, Selected outputs on labels, letters, envelopes, Sorted for Mailing Rebate, Complete Mailing Shots Assembled & Posted, Coupon Responses, Order Files, Media Analyses etc.
NLDS, ROTHWELL, LINCOLN
0472-89346/7

● Circle No. 203

MICROTEK COMPUTER SERVICES



Agents for North Star Horizon. Personalised software for small business applications. Block control, accounting, estate agents package, mailing list programs.

50, Chislehurst Road,
Orpington, Kent
Tel 66-26803
evenings 0474-872630

● Circle No. 204

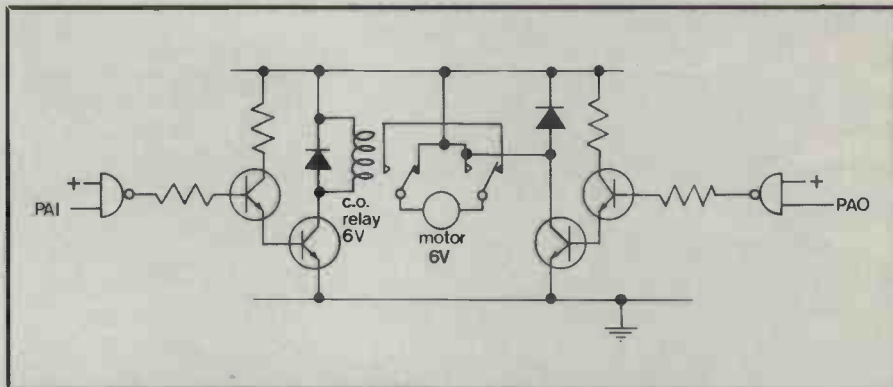

Figure 2. Reversible motor control for SPEEDR.

(continued from previous page)

the gate was non-inverting, every time the microprocessor was re-set all the transistor switches would conduct. In a different application, the quad two input OR gate 7432 package, with the second input grounded, acts as a non-inverting buffer. Further, it has the same pin layout as the 7400 (O'NAND' high = 1 and 1'NAND' high = 0 whereas 0'OR' low = 0 and 1'OR' = low 1).

Figure 2 shows how two identical circuits as shown in figure 1 may be used to turn a DC motor on and off, as well as reverse its direction. The motor connections are swapped over as the double-pole relay is energised. The subroutines starting at \$0100 are written to switch a device attached to the first four-user port lines PA0-PA3.

As a simple demonstration they are incorporated into the program SWITCH at \$0004. First subroutine INIT is called to set-up PIO A as outputs and PIO B as inputs. The program then cycles round, reading the keypad with the monitor routine GETKEY.

Four channels

Keys along the bottom of the pad will be used to switch on any of the four channels, i.e., set the relevant user port line low. This is done by testing for each of the keys in turn and calling ON1, ON2, ON3 or ON4 when GETKEY returns 0, 1, 2 or 3. The next row of keys 4, 5, 6, 7 call the corresponding OFF routines, setting the user port line high and turning off the transistor switch.

Each of the four ON subroutines works by loading the current contents of the user port data register, which reflects the logic values on the wires, into the A-register. By ANDing any individual bit with a '1' it remains unchanged. By ANDing it with a '0' that bit is set to zero.

In each of the four cases only one bit is zeroed before this new value is placed back in the data register DA. Irrespective of their previous values, the zeroed bit turns on the transistor switch; all the others are totally unaffected.

With each of the OFF routines only that bit which is ORed with a '1' is set to a logic high, switching off that channel. All

the others ORed with a '0' remain unaffected. Referring to figure 2, with the circuits connected to the user ports shown, pressing key 0 will switch on the motor, key 4 will switch it off. Key 1 will set it forwards and key 5 into reverse.

Varying speed

When the circuits are used to drive small DC motors it is often useful to vary their speed. As these circuits act only as ordinary switches, either on and applying full voltage, or off and applying none across the windings, some form of pulse-width modulation is called for.

Here the motor is alternately switched on for a period and then switched off for a time. The ratio of on to off determines the speed of rotation. Due to various electrical, magnetic and mechanical inertias in the motor, these pulses are smoothed-out. If the pulse frequencies are chosen carefully, this gives the appearance of the motors being powered from a variable DC source.

While testing the software, various small permanent magnet motors of the type readily available from radio-control and modelling shops were tried. One particular make with bolt-on epicyclic gearboxes is particularly versatile.

Wide range

The gearboxes are manufactured from grey plastic and are flat. They can be bolted on to the output shaft of the motor, and are 'stackable' thereby offering a very wide range of reductions. They are available in a range of sizes, voltages and currents.

At least one of the medium-sized six-volt units is sold as a 'curtain cord motor', supplied with the correct gearing for the task. Also available for these motors is an electrical and wireless interference suppressor—in effect, a few capacitors and ferrite beads to control any arcing at the commutator, although they hardly seem to need it.

On the other hand some of the cheaper motors produce so much electrical 'hash' that they upset the microprocessor circuits. The yellow Meccano 3-12 volt motors, with the six-speed gearboxes, are

(continued on next page)

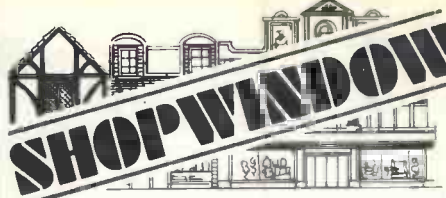

(continued from previous page)

guilty of this, so much so that as soon as the test one was started the Kim-1 promptly re-set itself.

Mains-powered equipment could be catered for with the routines by the use of triacs and opto-isolators (*Practical Computing*, October, 1978), or by commercially-available 'solid state relays'.

Figure 3 shows two forms of proportional control using on/off switching. 3a, as produced by the program MSR (\$005A) shows the kind of control available with a fixed ON pulse-length and a variable OFF delay between these pulses.

DELAY is a subroutine taking two parameters. One, in the A-register, determines the number of 64-microsecond delays which will occur. The Y-register is loaded with the number of times this should happen. With the default settings (loading LONG into A and 1 into Y) the ON pulse is set to about 4.48 milliseconds, 70*64, which on most motors appears as a very short click, not unlike a stepping motor, with the shaft turning a very small amount.

Precise motions

Then the motor will be switched off and the DELAY routine called again. This time the A-register is loaded with the contents of SHORT (22), the basic delay is then 1.4 milliseconds. The Y-register is loaded with the contents of location SPEED (\$0000). Therefore the smallest mark:space ratio is about 4.48:1.4 and the greatest 4.48:360.4.

When SPEED has been loaded with zero, this is tested for separately and the

motor is never switched off full speed. This technique offers a wide dynamic range of speed control. If the ON period is short compared to the inertia of the motor, very precise motions may be made. The values for LONG and SHORT given here are only a rough guide; their optimum values will depend on the motors you use.

Figure 3b shows the effect of SPEEDR (\$0079). In this example the 'time' from A to B is divided into 10 time slots. The number of slots the motor will be on is read from the keypad; for the remainder of the 10 it will be off. The program therefore loads the A-register with GETKEY.

Added bonus

As an added bonus, it will check to see if '\$F', and set PA1 (the relay) off for 'forwards', and for '\$B' to set PA1 for 'backwards'. If it is neither, it jumps to the subroutine ratio (\$0156).

When a key greater than 9 is pressed, the motor is switched off and the routine returns directly. If the key '0' is pressed the Y-register is loaded with 10 and a delay for the full A to B 'time' is effected (about 14 milliseconds) with the motor OFF, before returning. For any key between 1 and 9 the keypad value is loaded into the Y-register and that many time slots are delayed with the motor on.

After the delay the keypad value is subtracted from 10 and the remaining time slots are delayed with the motor off. In any case the motor is switched off before the return, so any delay introduced by calling GETKEY reduces the total

(continued on next page)

Fig. (3a)

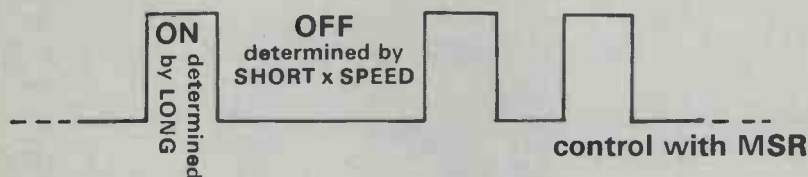
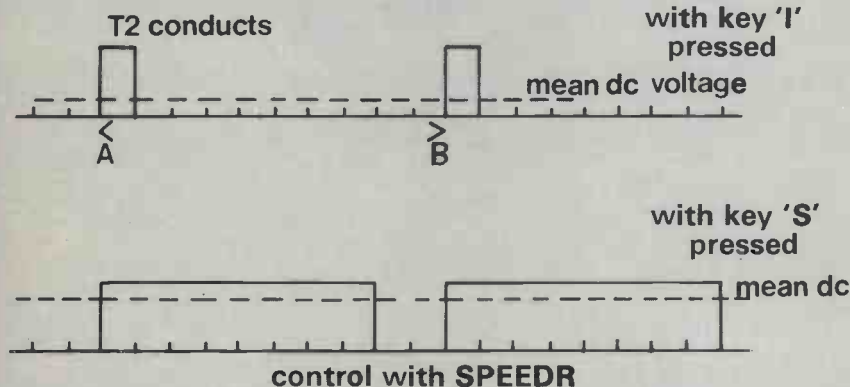

Fig. (3b)



SOUTHAMPTON Your PET Dealer

Hire a PET for £4 per day or £20 per week, refunded if you decide to purchase; software and manuals provided.

We specialise in servicing—ask for a quotation on a maintenance contract

Super-vision
13 St. James Road
Shirley, Southampton
Telephone: daytime Southampton (0703) 774023
evenings Southampton 775038.

● Circle No. 205

RADIO SHACK COMPUTER OWNERS

TRS-80 MONTHLY NEWSLETTER

- PRACTICAL APPLICATIONS
- BUSINESS
- GAMBLING • GAMES
- EDUCATION
- PERSONAL FINANCE
- BEGINNER'S CORNER
- NEW PRODUCTS
- SOFTWARE EXCHANGE
- MARKET PLACE
- QUESTIONS AND ANSWERS
- PROGRAM PRINTOUTS
- ... AND MORE

ONE YEAR SUBSCRIPTION INC. P&P £16-50

G-MAX RESEARCH CO. LTD
8 BATE RD, SUTTON, SURREY
TEL. 01-642 8971 (No callers please)

● Circle No. 206

OHIO SUPERBOARD

Computer on a board. 8K basic in ROM keyboard, graphics, cassettes interface, 2K monitor, British TV interface, expandable.

4K RAM £275 8K RAM £315
C.T.S.
1 Higher Calderbrook,
Littleborough
Lancs OL15 9NL
Tel. Littleborough
(0706) 79332 anytime

● Circle No. 207

NASCOM 1 : Kit £197.50 + VAT
: fully-built and tested
£247.50 + VAT

SUPERBOARD II : fully-built and tested
£284.95 inc VAT
Ohio Scientific.

8K basic, 4K Static RAM 1K dedicated video memory, 53-key keyboard, upper and lower-case, graphics and gaming characters.
for details: NIC Models, 27 Sidney Road, London N22 4LP Tel. 01-889-9736

● Circle No. 208

SHOP WINDOW

Dyna-Byte

fully assembled
burned in S100

16K Dynamic	RAM	£198
16K Static	RAM	250ns £271
16K Static	RAM	450ns £266
32K Static	RAM	250ns £506
32K Static	RAM	450ns £470

80 x 24 video terminal, just add keyboard and monitor £177.

Cable set for video terminal £7.20

Post free. Add 8% VAT to all prices.

S.W.C. Electronic distributors, P.O. Box 30, London E.4.

● Circle No. 209

BRAMBLETYE COMPUTER SYSTEMS LTD

(Forest Row, East Sussex)

Centronics 700, 60cps matrix printer. Twelve months old. £650

Tel. 034-282-4297

● Circle No. 210

SCOTLAND Distributors in Scotland for

NASCOM 1

Nascom 1 can be seen in action
9-5 Mon.-Fri.
Buffer boards and memory now in stock
Callers welcome

STRATHAND

44 St. Andrew's Sq. GLASGOW G1 5PL

Enquiries invited from prospective Dealers throughout Scotland.
GLASGOW (041) 552 6731
Tel. order welcome with Access and Barclaycard.

● Circle No. 211

WANTED

Sprocket feed printers to give 30/40 columns (approx 4 inch) between the sprockets. New or second user. U.K. or any source quote FOB with details.

For sale last of our 8K Pets £500

**Manorfield,
Harpenden AL5 2TE
08727-60624**

● Circle No. 212

(continued from previous page)

possible ON time to somewhat less than 100 percent.

The values used for DELAY in this program have been carefully chosen to provide a 'smooth' DC average value. If the time slots are much longer the motor—or at least those types tested—seemed to 'judder'. If the time slots were much shorter, the pulses were of such a frequency as to be readily audible and the motor 'whines'.

Also try this program with a light bulb in place of the motor. The different keys show clearly their effect as varying brightness. A 12 volt 12 watt one as used in car indicators works well.

One problem with small DC motors is the ease with which the speed changes according to such factors as loading and the supply voltage, possibly as batteries run down. One can never, therefore, guarantee that one pulse from a program like MSR will move the output shaft X degrees from one time to the next. So if such a technique was used to control a robot moved by these motors, 100 pulses might move it one foot the first time, but only 11½ in. the next.

If the delay between the pulses is reduced, the motor has a chance to 'build-

up speed' and in this case might travel 15 in. for 100 pulses. As an example of how this problem may be combatted, figure 4 shows a gray code disc. The four concentric rings show a special binary code in which only one bit changes between adjacent segments. They are marked in the table.

Figure 5 shows a light-emitting diode/phototransistor pair which could shine through a transparent disc with opaque gray code markings. The advantage of such an encoding system is obvious when you consider what would happen with a disc coded with straight binary.

As the disc went from 0000 to 1111 it is possible that, due to the optical readers being slightly off axis with the shaft, or all four not being read at exactly the same time, that some of the cells would still read zero while others now read one, leading to a totally spurious result.

CONVG (\$01A1) is a subroutine which converts a gray code into ordinary binary, which could then be used to determine the exact shaft rotation and speed. Gray codes and code discs are available in many resolutions, typically 6-bit (5.625 degree) and 10 bit (0.352 degree) working on exactly the same principle. The program

(continued on next page)

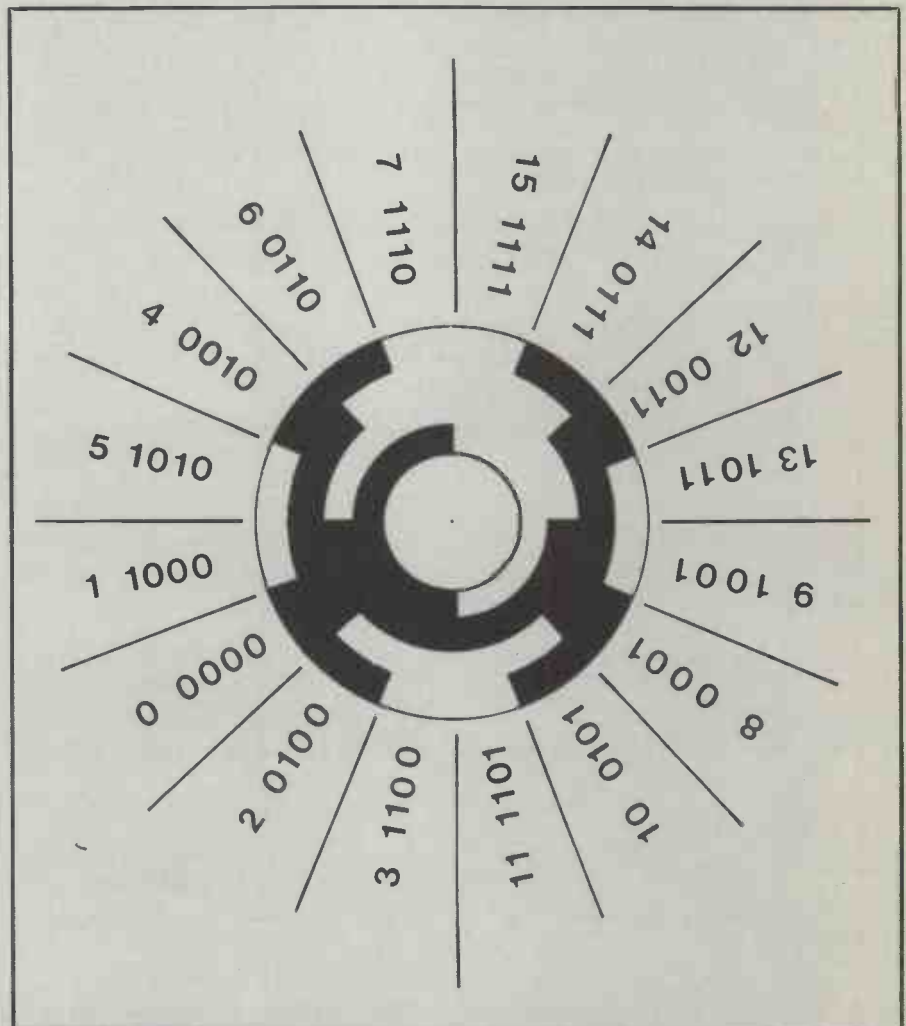
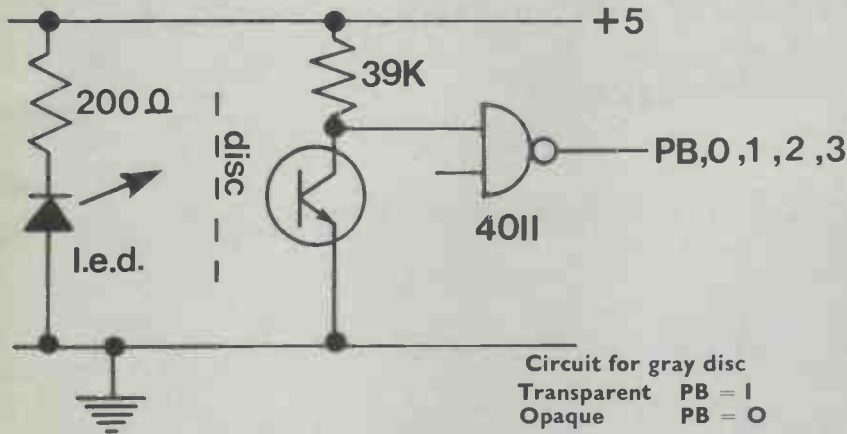

Figure 4. Excess 3-gray code shaft encoder 4-bit.



Fig. 5



(continued from previous page)

GRAYT (\$009D) displays the gray value from bit PB0 to PB3 on the left-most hex display as a binary '0' to 'F' digit.

Obviously many things can now be tackled by modifying these subroutines to

suit your own needs, or indeed using them as they are. On second thoughts, perhaps you should leave modifying the washing machine to the experts. Think how much hot water it could deposit on your floor if a spurious (and malignant) electrical spike re-set the processor.

```

;
; SYSTEM LOCATIONS
;
UA      =51700
DDA     =51701
DB      =51702
DDb     =51703
SCANS   =51F1F
DISP    =51F9
GLTKLY  =51F6A
C64D    =51706
SK      =51707
;
; VARIABLES
SPEED   ****1
SHORT   .BYTL 22
LONG    .BYTL 70
XTP     ****1
;
; PROGRAM TO SWITCH ANY OF THE
; CHANNELS ON OR OFF.
;
; 0=CHANNEL 1 ON
; 1=CHANNEL 2 ON
; 5=CHANNEL 5 OFF
; 2=CHANNEL 3 ON
; 6=CHANNEL 3 OFF
; 3=CHANNEL 4 ON
; 7=CHANNEL 4 OFF
;
0004 20 48 01 SWITCH JSA INIT
0007 20 6A 1F NEXTK JSR GLTKLY
000A C9 00      CMP #0
000C D0 06     BNE G1
000E 20 00 01 JSR DN1
0011 4C 07 00 JMP NEXTK
0014 C9 04     G1  CMP #4
0016 D0 06     BNE G2
0018 20 09 01 JSR OFF1
001B 4C 07 00 JMP NEXTK
001E C9 01     G2  CMP #1
0020 D0 06     BNE G3
0022 20 12 01 JSR DN2
0025 4C 07 00 JMP NEXTK
0028 C9 05     G3  CMP #5
002A D0 06     BNE G4
002C 20 1B 01 JSR UFF2
002F 4C 07 00 JMP NEXTK
0032 C9 02     G4  CMP #2
0034 D0 06     BNE G5
0036 20 24 01 JSR DN3
0039 4C 07 00 JMP NEXTK
003C C9 06     G5  CMP #6
003E D0 06     BNE G6
0040 20 2D 01 JSR OFF3
0043 4C 07 00 JMP NEXTK
0046 C9 03     G6  CMP #3
0048 D0 06     BNE G7
004A 20 36 01 JSK DN4
004D 4C 07 00 JMP NEXTK
0050 C9 07     G7  CMP #7
0052 D0 03     BNE NEXTK
0054 20 3F 01 JSR OFF4
0057 4C 07 00 JMP NEXTK
;
; PROGRAM TO SHOW PULSE MOTOR
; CONTROL. LOCATION 'SPEED'
; CONTAINS NUMBER OF TIME SLOTS
; BETWEEN MOTOR-ON PULSES.
; SPEED=0 MEANS FULL ON
005A 20 48 01 M$K JSR INIT
005D 20 00 01 M$H JSR DN1
0060 A5 02 LDA LONG
0062 A0 01 LDY #1
;
0064 20 8C 01 JSR DELAY
0067 A5 00 LDA SPEED
0069 C9 00 CMP #0
006B F0 F0 BEC M$R1
006D A8 TAY
006E 20 09 01 JSR OFF1
    
```

(continued on next page)

```

      *
0 0 0 0
      *
0 0 0 1
      *
0 1 0 1
      *
0 1 0 0
      *
0 1 1 0
      *
0 1 1 1
      *
1 1 1 1
      *
1 1 1 0
      *
1 1 0 0
      *
1 1 0 1
      *
1 0 0 1
      *
1 0 0 0
      *
1 0 1 0
      *
1 0 1 1
      *
0 0 1 1
      *
0 0 1 0
      *
    
```

Four-bit gray code. Notice how only one bit changes between adjacent numbers.

EXIDY SORCERER

32K Micro Computer

£850.00 + VAT

Dealer for

Bristol and South West

ELECTROPRINT (Mr. Tasker)

5 Kingsdown Parade • Bristol 6 • 292375

● Circle No. 213

JACOBS COMPUTER SYSTEMS

NORTH STAR HORIZON SPECIALISTS



Contact us for the professional approach to Micro Software.

Our very experienced staff can solve your software and systems problems — fast.

Call us on 01-908 1134
 Or write to :- Jacobs Computer Systems Ltd, 36 Bengeworth Rd, Harrow, Middx. HA1 3SE

● Circle No. 214

WEST COUNTRY DEVON

Crystal Electronics

FOR THE BEST IN SMALL COMPUTERS
 advice and full back up on
APPLE II NASCOM I ATARI NEW BEAR
 books (over 150 titles), components, add ons, etc.
 SOFTWARE FOR

Apple 2 stock control (disk and printer) for 10,000 items plus £100+ full update for six months
 exc VAT

Nascom tape containing 6 games etc £6.00 +VAT.
 All products are stocked on advice from our engineers as to quality value for money and reliability.
 Shop open 0930-1800 except Wed/Sun

40 MAGDALENE ROAD,
 TORQUAY, DEVON
 Tel. 0803 22699

● Circle No. 215

Mini Computer

Cassettes

at incredibly low prices



Buy direct from the manufacturer and save on top quality mini-computer cassettes. Thousands sold every month.

Send for full details to:
PROFESSIONAL TAPES Ltd, Cassette House,
 329 Hunslet Road, Leeds, LS10 1NJ.
 Telephone: Leeds (0532) 706066

● Circle No. 216



INDEPENDENT PROGRAMMERS, DESIGNERS AND TRAINERS

Are you looking for projects on microcomputers?

Digitus MicroSkill is seeking people with experience of minis and micros, especially Z80/8080, 6502, 6800, LSI 11 and MicroNova.

Can you develop systems in Assembler, Fortran, Basic, Cobol, PL/M, PL/Z or teach micros to beginners and computer professionals?

Assignments include systems software, industrial, educational, business applications and running hands-on micro courses.

Establish your place on the MicroSkill Register by sending us a C.V. together with details of two referees who will attest to the quality of your work.

We can provide you with regular, interesting projects for development on your own machine, on our machines in London or on those of our customers in the U.K., U.S.A., Europe and Japan.

Don't delay—write today to Alan C. Wood, Digitus Ltd., Dumbarton House, 68 Oxford Street, W.1.

PS: Four of our London customers are seeking permanent staff to work on advanced mini and micro projects.

(continued from previous page)

```

0071 A5 01          LDA SHORT
0073 20 8C 01      JSR DELAY
0076 4C 5D 00      JMP MSK1

; PROGRAM TO DEMONSTRATE PULSE
; WIDTH MODULATION CONTROL OF
; D.C. MOTOR SPEED CONTROL.
; USE KEY-PAD TO SELECT SPEED;
; 0 IS OFF, 9 IS FULL SPEED.
; INCREASING SPEED FROM 1 TO 8
; B- SLT RELAY ON (PA1)
; F- TURN RELAY OFF
; ANY OTHER - NO EFFECT
0079 20 48 01      SPEEDR JSR INIT
007C 20 6A 1F      SPEEDI JSR GETKEY
007F C9 15          CMP #S15
0081 80 F9          MCS SPEED1
0083 C9 08          CMP #S8 REVERSE
0085 D0 06          BNE S1
0087 20 12 01      JSR ON2
008A 4C 7C 00      JMP SPEEDI
008D C9 0F          S1 CMP #F FORWARD
008F D0 06          BNE S2
0091 20 1B 01      JSR OFF2
0094 4C 7C 00      JMP SPEEDI
0097 20 56 01      S2 JSR RATIO
009A 4C 7C 00      JMP SPEEDI

; PROGRAM TO DECODE GRAY
; DISC. RESULT IN DISPLAY
; L-S-D.
009D 20 48 01      GRAYT JSR INIT
00A0 20 A1 01      GRAYT1 JSR CONVG
00A3 20 1F 1F      JSR SCANS
00A6 4C A0 00      JMP GRAYT1

;
00A9              **$100
; SUBROUTINES USED BY PROGRAMS
; TURNS CHANNEL 1 ON
0100 AD 00 17      ON1 LDA DA
0103 29 FE          AND #11111111
0105 8D 00 17      STA DA
0108 60            RTS
; TURNS CHANNEL 1 OFF
0109 AD 00 17      OFF1 LDA DA
010C 09 01          ORA #200000001
010E 8D 00 17      STA DA
0111 60            RTS
; TURNS CHANNEL 2 ON
0112 AD 00 17      ON2 LDA DA
0115 29 FD          AND #11111111
0117 8D 00 17      STA DA
011A 60            RTS
; TURNS CHANNEL 2 OFF
011B AD 00 17      OFF2 LDA DA
011E 09 02          ORA #200000010
0120 8D 00 17      STA DA
0123 60            RTS
; TURNS CHANNEL 3 ON
0124 AD 00 17      ON3 LDA DA
0127 29 FB          AND #211111011
0129 8D 00 17      STA DA
012C 60            RTS
; TURNS CHANNEL 3 OFF
012D AD 00 17      OFF3 LDA DA
0130 09 04          ORA #200000100
0132 8D 00 17      STA DA
0135 60            RTS
; TURNS CHANNEL 4 ON
0136 AD 00 17      ON4 LDA DA
0139 29 F7          AND #111110111
013B 8D 00 17      STA DA
013E 60            RTS
; TURNS CHANNEL 4 OFF
013F AD 00 17      OFF4 LDA DA
0142 09 08          ORA #200001000
0144 8D 00 17      STA DA
0147 60            RTS

; INITIALISE OUTPUT PORTS
; A - OUT, B - IN.
0148 A9 FF          JNIT LDA #FFF
014A 8D 01 17      STA DDA
014D 8D 00 17      STA DA
0150 A9 00          LDA #0
0152 8D 03 17      STA DDB
0155 60            RTS

; DELAYS 10 TIME UNITS.
; CHANNEL 1 ON FOR THE
; NUMBER OF UNITS INDICATED
; IN THE A-REG, OFF FOR THE
0156 85 03          LDA #3
0158 C9 0A          MCS #3
015A 90 04          BCC R1
015C 20 09 01      JSR OFF1
015F 60            RTS
0160 C9 00          CMP #0
0162 D0 0B          BNE R2
0164 20 0B 01      JSR OFF1
0167 A0 0A          LDA #10
0169 A5 01          LDA SHORT
016B 20 8C 01      JSR DELAY
016E 60            RTS
016F 20 00 01      JSR ON1
0172 A4 03          LDA #3
0174 A5 01          LDA #1
0176 20 8C 01      JSR DELAY
0179 20 09 01      JSR OFF1
017C A9 0A          LDA #10
017E 38            SEC
017F E5 03          SBC XTP
0181 C9 00          CMP #0
0183 F0 06          HLT HLTN
0185 A8            TAY
0186 A5 01          LDA SHORT
0188 20 8C 01      JSR DELAY
018B 60            RTS

; SUBROUTINE TO DELAY Y-REG
; TIME UNITS
018C 8D A0 01      DELAY STA TIME
018F AD A0 01      DELAY1 LDA TIME
0192 8D 06 17      STA C64D

0195 2C 07 17      D1 BIT SR
0198 10 FB          BPL D1
019A 88            DEY
019C C0 00          CPY #0
019D D0 F0          BNE DELAY1
019F 60            RTS
TIME *****

; SUBROUTINE TO DECODE GRAY
; CODE DISC TO CONSECUTIVE
; BINARY OUTF IN DISP+2
01A1 AD 02 17      CONVG LDA DB
01A4 29 0F          AND #20000111
01A6 A4            TAX
01A7 5D AD 01      LDA ZCODE,X
01AA 85 FB          STA DISP+2
01AC 60            RTS
ZCODE -BYTE 0,1,15,14,3,2

01A8 00            ZCODE
01A9 01            ZCODE
01AA 0F            ZCODE
01AB 0E            ZCODE
01AC 03            ZCODE
01AD 02            ZCODE
01AE 04            ZCODE
01AF 05            ZCODE
01B0 0B            ZCODE
01B1 08            ZCODE
01B2 02            ZCODE
01B3 04            ZCODE
01B4 05            ZCODE
01B5 0B            ZCODE
01B6 0A            ZCODE
01B7 0C            ZCODE
01B8 0D            ZCODE
01B9 08            ZCODE
01BA 09            ZCODE
01BB 07            ZCODE
01BC 06            ZCODE
01BD 06            ZCODE

SECOND PASS FINISHED O.K.
SYMBOL TABLE
50
DA 1700 DDA 1701 SCANS 1F1F
DB 1702 DDB 1703 C64D 1706
DISP 00F9 GETKEY 1F6A C64D
SR 1707 SPEED 0000 SHDRT 0001
LONG 0002 XTP 0003 SWITCH 0004
NEXTX 0007 G1 0014 G2 001E
G3 0028 G4 0032 G5 003C
G6 0046 G7 0050 HSK 005A
MSK1 005D SPEEDR 0079 SPEEDI 007C
S1 008D S2 0097 GRAYT 009E
GRAYT1 00A0 ON1 0100 OFF1 0109
ON2 0112 OFF2 011B ON3 0124
OFF3 012D ON4 0136 OFF4 013F
INIT 0148 RATIO 0156 RATIO1 0158
R1 0160 R2 016F HLTN 018B
DELAY 018C DELAY1 018F D1 0195
TIME 01A0 CONVG 01A1 ZCODE 01AD
END OF ASSEMBLY
22.25.53-

```

Expansion boards from GEC

GEC SEMICONDUCTORS has announced a wide range of iSBC expansion boards for use with the new Intel 86/12 single-board computer, which will replace four standard minicomputer boards in a typical OEM system at about half the cost.

The boards include RAMs up to 64K bytes, ROMs up to 64K bytes, battery-powered RAM boards, PROM programmer boards, mini and standard disc controllers, video graphics, a range of analogue I/O boards, CRT/keyboard controller boards, relay output boards, isolated input boards, communications controllers and hard disc controllers.

The iSBC 86/12 uses the 8086 16-bit CPU which is designed to support high-

level languages. It has a comprehensive instruction set, including multiply and divide in binary, BCD or ASCII. On-board memory includes 32K bytes of dual-port read/write memory and sockets for up to 16K bytes of ROM.

The dual-port feature allows the read/write memory to be accessed by both the 8086 CPU and any other bus master which shares the Multibus with the iSBC 86/12. Using the expansion cards, the memory can be increased to one megabyte.

Programmable parallel I/O on the boards extends to 24 lines, which can be configured as the application demands. Sockets are available to accommodate standard line drivers and receivers.

QUESTION?

1. Is your hobby home computing or electronics?
2. Do you understand the application of ICs, Transistors, Diodes etc?
3. Have you used or applied analogue or digital techniques?
4. Are you applying TTL Logic to your home computer?
5. Are you programming your home computer using simple software techniques?

If the answer is YES to any of these questions, then why not consider turning your hobby into a career—applying your knowledge to servicing electronic equipment ranging from basic terminals and data processing machines through to advanced micro-processor systems?

We will train you through to advanced technology at the Company training school, fitting the individual in at their own level.

We have vacancies over the whole of the U.K. with the successful applicants working from home, usually in a radius of no more than 60-70 miles.

We supply all tools and test equipment, plus a Company car which is available for private use.

If you are interested, then why not contact Mr. C. Marklew or Mr. D. Simmonds on 0249 813771 to discuss your own career opportunities in confidence, or write to:-

KODE SERVICES LIMITED
Station Road,
Calne,
Wiltshire

EXPERT ON HOME COMPUTERS

Rapidly expanding retail operation in the indoor leisure field is diversifying into home computers and would like to hear from an expert in this field interested in setting up this new division and managing our first Central London shop. Excellent salary commensurate with expenses and responsibility. Please circle reader enquiry no. below.

● Circle No. 222

Editor

Practical Computing, Britain's leading computer monthly is looking for an Editor.

Each month *Practical Computing* shows how computers can be easily used in business, in the home, and in education.

Because of our rapid expansion we are now looking for an editor to take responsibility for developing and running this exciting publication.

Ideally you will have a computer or electronics background, although that is not essential. What is important is that you have a keen interest in the use of computers.

You will be working with a bright, expanding publishing company. Salary is £7,000 per annum plus a company car, and there is a staff shareholding scheme. For an interview write or phone

Richard Hease or Dennis Jarrett
ECC Publications
2 Duncan Terrace
London N1.
Tel: 01-278 9517

Practical Computing

Logica

Real-Time in Holland and throughout the Benelux....

YOU'VE HEARD OF LOGICA
HAVEN'T YOU?

YES OF COURSE YOU HAVE.

THEY'RE SO WELL KNOWN.

OFFICES IN ROTTERDAM & LONDON
NEW YORK SWEDEN & AUSTRALIA.

LOGICA AS YOU KNOW
SPECIALISES IN MINI & MICRO SYSTEMS
FOR ON-LINE APPLICATIONS
INCLUDING DISTRIBUTED PROCESSING
PROCESS CONTROL & TELEMETRY
MESSAGE SWITCHING AND
DATA COMMS NETWORKS.
IF IT'S INNOVATIVE LOGICA DOES IT.

LOGICA B.V. IS NOW RECRUITING
CONSULTANTS & SENIOR CONSULTANTS
AND ANALYST PROGRAMMERS.
A DEGREE IS DESIRABLE.
SALARIES ARE CERTAINLY HIGH.
FRINGE BENEFITS ARE EXCELLENT.
THE WORK IS DEMANDING.
YOU WILL LOVE HOLLAND.

LOGISTIX ARE OUR CONSULTANTS
PHONE THEM ON 01-491 4636
THEY WILL ARRANGE AN INTERVIEW.
DO IT TODAY — NOW.



360 Oxford St.,
London WIN 9HA.
Tel: 01-491 4636

COMPANY	SYSTEM	APPLICATION	PRICE RANGE
AIRAMCO LTD 30 Witches Linn, Ardrossan, Ayrshire KA22 8BR 0294 65530	SDS 100. Single unit containing 32K memory (expandable to 64K); up to 8K PROM; twin double-sided floppy disc drives of 500K bytes each; serial and parallel RS232 interfacing; keyboard; 12 in. video display; power supplies; SD monitor program; line printer available.	Software: CP/M, 8080 assembler, E Basic, Editor supplied with system; M Basic, Fortran, Cobol available for business use, industrial process monitoring and control (with additional hardware). All CP/M games and business packages available.	From £3,750 (basic machine) £890 (printer) £4,500 combined
CALDERBROOK TECHNICAL SERVICES (CTS) 1 Higher Calderbrook Littleborough, Lancs 0706 79332	Ohio Superboard II (computer on a board), Min. size: 6502 processor. 8K BASIC in ROM; 2K monitor in ROM; 4K RAM; Cassette I/F; full keyboard; 32 x 32 video I/F; controller for two floppies.	8K BASIC in ROM; Assembler/Editor; Games, personal, maths tutors, and business programs. American system aimed at hobbyist/small business.	£275-1,100
	Challenger II 4P (professional portable), similar to Superboard but supplied as two separate boards with open slots for expansion.	Similar to Superboard. Aimed at small business, education, research.	£595-1,500
	Challenger II 8P (personal computer), similar to 4P but expandable to include 2 x 8 floppies, multiple line printers, 74 MB hard disc, multiple terminals.	Similar to 4P but larger business/commercial programs. Aimed at small business with requirement for large storage and multiple users. Also education and research.	£800-7,500
COMART PO Box 2, St Neots, Cambridgeshire 0480 215005	Microbox , Min. size: Chassis with three sockets. Max. size: Chassis with six sockets.	Aimed mainly at OEM industrial users and perhaps the serious hobbyist. Manufactured in Britain by Comart, it will take Cromemco, North Star and other processors and software.	£70-£195
	Cromemco System Two , Min size: Processor alone with six sockets in kit form. Max size: 21 sockets; 512K of memory; up to three mini-diskettes of 90K bytes each.	Software: Extended Basic; Fortran IV; Cobol; Macro-assembler; Word-processing, DBMS. American system suggested for systems development.	£395 to around £5,000
	Dynabyte , Memory board for any S100 bus system. Available in 16-32K units.		£275-695
	Cromemco System Three , Min size: 32K memory; terminal and printer interface; dual 250K-byte IBM-compatible floppy discs. Max size: 128K memory; two-three terminals.	Software: Same as System Two. Suitable for a wide range of commercial and scientific applications. Theoretical maximum of 512K of memory.	£4,174-£10,000-plus
	Horizon , Min size: 16K memory; serial interface; one mini-diskette drive with 90K bytes; power supply. Max size: 48K memory; three diskettes; hardware floating point board.	Software: Extended Basic; disc operating system; monitor; access to CP/M range. Manufactured by North Star Computers of the U.S. Aimed at educational and small business users.	£995-£3,500
	SOL 20/16 , Min size: 16K memory; integral keyboard and monitor; serial and parallel interface; cassette unit. Max size: 64K memory; up to 1MB disc capacity.	Software: Extended Basic; Fortran; Focal; Assembler; Editor; Games. Another American system from Processor Technology Corp aimed at the small business and education markets.	£1,785-£5,000-plus
	COMMODORE SYSTEMS DIVISION London NW1 01-388 5702	PET , Single unit containing screen, tape cassette and keyboard. Memory is expandable from 8-32K.	Software: Basic; Games; Business packages. The British subsidiary of Commodore Systems of the U.S. sells Pet for home, educational and small business applications.
	Kim I , Min size: Processor (6502 chip); small calculator-type keyboard; LED six-digit display; built-in interfaces for audio-cassette and Teletype; 1K RAM; 2K ROM. Max size: Can add: Kim 4 motherboard; Kim 3B 8K RAM (up to 64K); Kim 5 resident assembler.	Software: None available yet, but it has three good manuals. An American import which gives Pet-type capabilities with a maximum configuration. For the hobbyist but used mainly as an evaluation board for the 6502 chip. There are two dealers, GR Electronics and J Marshall, which offer further facilities.	£129-£600 (+VAT)
COMP Computer Components 14 Station Road, New Barnet, Herts. 01-441 2922	EXIDY Sorcerer based on Z-80. Typical size: 12K ROM, 32K RAM; cartridge and cassette I/F; 79-key keyboard; 256 character set (128 graphics symbols); 12 in video monitor; expandable with Micropolis floppy discs.	Software: standard Basic Assembler and Editor Fortran and Cobol; word processor; games and other pre-packaged programs.	From £950
COMPELEC 14/15 Berners Street, London W1 01-580 6296	Altair System 1300 , Min size: 32K memory; dual minifloppy discs, 71K bytes each formatted; serial interface. Max size: 64K memory; 4 serial ports.	Software: Basic (single and multi-user); Fortran; Cobol. The hardware for the Altair systems is from Pertec in the States, but the software is Anglo-Dutch.	£3,000-£5,500

(continued on page 100)

NORTH STAR * HORIZON

DOUBLE DENSITY PERFORMANCE
at SINGLE DENSITY PRICES.

- * One Double Density Mini Floppy (180K Bytes)
 - * 16K Fast RAM
 - * Serial I/O Interface
 - * DOS/BASIC
- HRZ-16W £1330
- * Z80A Based S100 Bus Expandable System

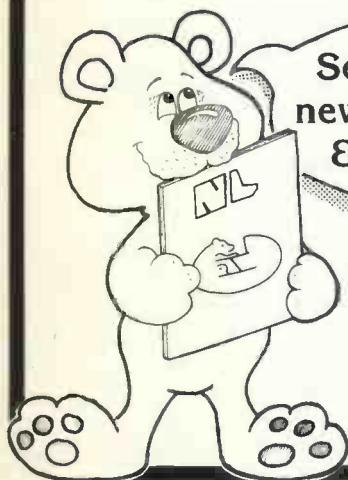

Send for our
new catalogue
& price list

EXIDY SORCERER

- * Plug in ROM Cartridges
- * S100 Expansion Unit
- * Cassette Interface
- * Z80 C.P.U.
- * User definable graphics



NEWBEAR COMPUTING STORE

Head Office: Bone Lane, Newbury, Berkshire.

Telephone Newbury (0635) 49223

Northern Office: 2A Gatley Road, Cheadle. Tel 061-491-2290

● Circle No. 218

AGE OF AFFORDABLE COMPUTING HAS FINALLY ARRIVED PEGASUS—THE COMPLETE SYSTEM



£2,700 EX VAT.

Z80 MPU ● 48K RAM ● DOUBLE-DENSITY SHUGART SA400 DRIVES 320K. S100 BUS ● 12 in. CRT ● 24 x 80 CHRS ● 58-key keyBOARD UPPER-/LOWER-CASE. ● CP/M ● 2 SERIAL ● 1 PARALLEL ● HEAVY-DUTY ANADIX 80 COL. 112 CPS BI-DIRECTIONAL PRINTER ● OPTIONS 8 in. DOUBLE-DENSITY DRIVES 1.2 MB (£400). 2 ADDITIONAL DRIVES 5 in. OR 8 in. ● DIGITAL RECORDER 9,600 BAUD. SOFTWARE. BUSINESS PACKAGE ● WORD PROCESSING. MAILING LIST.

PROFESSIONAL SERVICE—LARGE VARIETY OF SYSTEMS & EQUIPMENT ALSO SUPPLIERS OF PET, APPLE, HORIZON, VDUs, PRINTERS, BOOKS & MAGS.

LONDON COMPUTER STORE

43, GRAFTON WAY (OFF TOTTENHAM COURT RD) W.1. 388 5721 OPEN 11-7 MON-FRI 11-4 SATS.

● Circle No. 219

(continued from page 98)

COMPANY	SYSTEM	APPLICATIONS	PRICE RANGE
COMPELEC (continued)	Altair System 70 , Min size: 33K memory; dual floppy discs, 300K bytes each. Max size: 64K memory; provision for up to 8 VDUs.	Software: Single and multi-user Basic; Fortran; Cobol; APL. Aimed exclusively at business applications; packages are available for general and sales and purchase ledger, payroll, word processing, stock control, estate agency, hotel or small airline reservations, transport management and freight costing. A point-of-sale package will soon be ready.	£4,500 to £10,000-plus
	Altair System 300 , Typical size: 64K memory; 10MB disc drive; turnkey processor; VDU; Qume daisywheel printer and disc unit.	Software: Single-user Basic; Fortran; Cobol. The same packages as for the System 70 are available for this top-end-of-the-market, business-orientated system. Compelec has its own office in Birmingham, but a full distributor network is being set up.	£10,000-plus
COMPUTERBITS LTD 40 Vincent Street, Yeovil, Somerset 0935 26522	System 8 , Typical size: 64K memory; 1MB disc storage; serial I/O port for VDU; parallel port to printer; CP/M operating system.	Software: Basic; Pascal; Fortran. This British-manufactured microcomputer system is almost exclusively for business applications.	£3,000-£5,000
COMPUTER MART LTD 38 St Faiths Lane, Norwich. 0603 615089	VDP-80 , Typical size: Single desk-top unit housing a 12 in. display, dual standard floppy disc drive, processor, power units, cooling system and fully-programmable keyboard containing 62 alphanumeric, 12 numeric and 12 cursor controls in separate keypads. Normally sold with 32K memory and 1.2M bytes of disc storage but may be expanded.	Software: Included in the price is a sophisticated operating system with Commercial Basic. A range of commercial application packages is available, including word processing if required.	£9,500
COMPUTER WORKSHOP 38 Dover Street, London W1 01-491 7507	System 1 , Typical size: 40K memory; dual 8 in. floppy discs, total storage capacity 1.2MB; Ricoh daisywheel printer. System 2 , Typical size: 24K memory; dual minifloppy discs of 80K bytes each; Centronics 779 dot matrix printer; VDU. System 3 , 12K memory; cassette interface; 40-column dot matrix printer.	Software: Range of Editors, Assemblers, Basics and Games; Information retrieval package. These systems were designed and built in Peterborough and are suitable for educational, small business users and perhaps the more serious hobbyist. There is a large number of dealers around the country.	System 1—£5,000-plus; System 2—around £3,000; System 3—from £1,350
EQUINOX COMPUTER SYSTEMS LTD 32-35 Featherstone Street, London EC1Y 8QX 01-253 3781/9837	Horizon , Min size: 16K memory; Z80A processor; single minifloppy disc drive (180KB). Max size: 56K memory, four minifloppy disc drives (180KB), any acceptable S100 peripheral boards.	Software: Standard—Basic Interpreter (includes random and sequential access), disc operating system and monitor; Options—Basic Compiler, Fortran, Cobol, and Pilot. The system is suitable for commercial, educational and scientific applications. Application software for general commercial users.	£1,000—around £2,500
	Equinox 300 , Min size: 48K memory; dual floppy discs giving 600K bytes of storage; 16-bit Western Digital m.p.u. Max size: Up to 256K memory; up to four 10MB hard discs.	Software: Basic, Lisp, Pascal, Macro Assembler, Text Editor and Processor. All software is bundled. The system is a multi-user, multi-tasking, time-sharing system for 2-12 users. Application software is available for general commercial users.	£5,000-£40,000-plus
MICRONICS 1 Station Road, Twickenham, Middlesex 01-892 7044	Micros , Typical size: 1K monitor; 47-key solid state keyboard; interfaces for video, cassette, printer and UHF TV; serial I/Os; dual parallel I/O ports; 2K RAM; power supply.	Software: Extended Basic; Pascal. A British-designed and manufactured system which is being enhanced rapidly. Already available are a 40-column impact printer using plain paper, at £360; what is claimed to be the cheapest data terminal around—a system with an acoustic coupler and VDU for £1,020. Prospective applications: small businesses, process controllers and hobbyists.	From £400, assembled
NASCOM MICROCOMPUTERS 92 Broad Street, Chesham, Buckinghamshire 02405 75151	Nascom 1 , Min size: CPU; 2K memory parallel I/O; serial data interface; 1K monitor in EPROM. Max size: CPU; 64K memory; up to 16 parallel I/O ports.	Software: Mostly games, but a maths package is on its way. The British-manufactured system started as a hobbyists' package but has found an increasing number of industrial users. Printer and minifloppy interfaces are in preparation. There are about two dozen dealers around the country.	From £165 plus VAT
NEWBEAR COMPUTING STORE 7 Bone Lane, Newbury, Berkshire and 2 Gatley Road, Cheadle, Cheshire 0635 49223	Sym 1 , Size: 6502 chip and keypad, with memory available in 4K blocks to 64K.	Software: Any Kim software. An American system meant to be the foundation for very small business and hobbyist users.	From £200
	7768 , Size: CPU board; 4K memory; cassette and VDU interfaces.	Software: Range of Basics and Games. A British-manufactured system for hobbyists. Expandable to 64K memory, it is available only in kit form.	
	Cromemco Z2 , Min size: Z2 chassis: power supply; motherboard; CPU; fan; sockets; byte saver board; 16K memory. Max size: 48-64K memory; dual 8 in. floppy discs.	Software: Basic, Fortran; Assembler; macro assembler. For small business and educational applications. These systems are also supplied to more than a dozen dealers. Same basic system as Comart.	£1,375 to £4,000

(continued on page 102)

The microcomputer for those who need more than the minimum. The right processor for business, scientific and educational use. Proven applications include Games

- Educational • Word Processing • Invoicing • Stock Control
- Sales Ledger • Purchase Ledger • Mailing • Scientific.

THE NEW HORIZON

Languages

Powerful Basic including sequential and random access disc files • formatted output • strings • line editor • machine language CALL • many other facilities. Optional additional software (under CP/M operating system) includes BASIC

compiler, FORTRAN and COBOL.

Horizon Z80A computer with 2 double-density disc drives and 24K RAM £1,823 (exclusive of VAT and carriage).

The Horizon computer includes:-

Specification

- Zilog Z80A MPU • S-100 bus (12 slots) • Solid well-built case • Up to four Shugart mini-floppy disc drives, 180KB each • Serial port for CRT or Teletype • Real-time clock on motherboard • Optional additional serial port and parallel port • Powerful operating system and monitor
- Access to wide range of S-100 special application boards.



Equinox Computer Systems Ltd.
32-35 Featherstone Street,
London EC1Y 8QX.
Tel: 01-253 3781/9837.

For North Star Horizon systems and software contact the people with experience:

LONDON

Eurocalc Ltd., 55/56 High Holborn, London. W.C.1. (Tel: 01-405-3113).

Lion House Microcomputers, 227 Tottenham Ct. Road, London. W.1. (Tel: 01-580-7383).

Sumlock Bondain Ltd., 15 Clerkenwell Close, London. EC1R 0AA. (Tel: 01-2532447).

HUNTS

Micropower, 26 High Street, Great Paxton, Huntingdon, Cambs. PE19 4RF. (Tel: 0480-213785).

SURREY

Radix 2 Technology Ltd., 92 Wimbledon Hill Road, Wimbledon, S.W.19. (Tel: 01-946-8887).

MIDDX

Jacobs Computer Systems Ltd., 36 Bengeworth Road, Harrow, Middx. HA1 3SE. (Tel: 01-908-1134).

HANTS

Claissie-Allen Computing, 5 Upper High Street, Winchester. (Tel: 0962-69368).

DORSET

Micro Systems Specialists, Market Place, Sturminster, Newton, Dorset. DT10 1BB. (Tel: 0258-72946).

SOUTH WALES

Micro Media Systems, 12 Clarence Place, Newport, Gwent. (Tel: 0633-50528).

LANCS & NORTH WALES

Cortex Computer Centre, 25/35 Edge Lane, Liverpool. (Tel: 051-263 5783).

CAMBS

Wisbech Computer Services Ltd., 10 Market Street, Wisbech, Cambs. (Tel: 0945-64146).

LINCS

Loveden Computer Services, 167 Bartowby High Road, Grantham, Lincs. (Tel: 0476-72000).

KENT

Microtek Computer Services, 50 Chislehurst Road, Orpington, Kent. (Tel: 66-26803).
Tor Business Systems, 83 Timberbank, Vigo Village, Meopham, Kent. (Tel: 0732-822956).

ESSEX

Micro Software Systems Ltd., Stanhope House, High Street, Stanford-le-Hope. (Tel: 03756-41991/2).

EQUINOX

COMPUTER SYSTEMS LTD.
32-35 FEATHERSTONE STREET
LONDON EC1Y 8QX
01-253 3781/9837

(continued from page 100)

COMPANY	SYSTEM	APPLICATIONS	PRICE RANGE
PERSONAL COMPUTERS LTD 194 Bishopsgate, London EC2 01-283 3391	Apple II , Min size: 16K memory; 8K ROM; keyboard; monitors; mini-assembler: colourgraphics; Powell card; RF modulator; Games; paddles and speaker; 4 demo cassettes. Max size: Expandable to 48K memory, and floppy discs and printers are now available.	Software: Basic; Assembler; Games; Business packages. An American system regarded as suitable for any kind of applications. There are 15 dealers throughout the country and maintenance contracts are offered.	£1,000-£2,000
RAIR 30-32 Neal Street, London WC2 01-836 4663	RAIR Black Box , Min size: 32K memory; dual minifloppy discs, 80K bytes each; two programmable serial I/O interfaces. Max size: 64K memory; 8 serial interfaces; 1MB disc storage (or 10MB hard disc); range of peripherals.	Software: Advanced Basic interpreter, Fortran IV compiler; Cobol compiler. Described by the makers as the only 'sensible' British-designed and manufactured microcomputer, its uses are small business and educational applications and in distributed processing networks. Hardware distributors are being signed and agreements made with software houses to add software. It is not for the hobbyists. A warranty and U.K.-wide on-site maintenance is given.	£2,300-£8,000
RESEARCH MACHINES LTD PO Box 75, 209 Cowley Road, Oxford 0865 49793	Research Machines 380Z , Min size: 4K memory; 380Z processor; keyboard. Max size: 48K memory. 280Z , 4K board plus connecting cables, £398. 32K board—identical in performance to the 380Z: £722.	Software: Basic Interpreter; 12K Basic; Assembler. A British system using CP/M software; delivery times are about 6 weeks at the moment. A minifloppy disc system is on trial. Sintel is the sole distributor.	From £830
SCIENCE OF CAMBRIDGE 6 Kings Parade, Cambridge 0223 312919	MK 14 , Min size: 8060 SC/MP; ½K user memory; ½K PROM with monitor program; Hex keyboard and 8-digit, seven-segment display; interface circuitry; 5v regulator on board. To this can be added: ½K RAM (£3-60); 16 I/O chip (£7-80); cassette interface kit (£5-95); cassette interface and replacement monitor (£7-95); PROM programmer (£9-95).	Software: None provided, but a 100-page manual includes a number which will fit into 256 bytes covering monitors, maths, electronics systems, music and miscellaneous. Based on American National Semiconductor chips. Science will soon have a VDU interface and large manual on user programming. Half of sales are to hobbyists, half to engineers.	Basic price is £39-95. All prices are exclusive of VAT
STRUMECH ENGINEERING ELECTRONICS DIVISION (SEED) Portland Place, Coppice Side, Brownhills, Walsall, Staffordshire 05433 4321	MSI 6800 , Min size: 6K memory; Act I terminal (keyboard); cassette interface. Max size: Three disc systems are offered: Minifloppy disc system with triple drives of 80 bytes each and 32K memory. Large floppy system with dual 312K-byte capacity disc and 32K of memory. Hard disc system with 10MB, five fixed, five removable, and 56K.	Software: Basic interpreter and compiler; super editor assembler; text processor on small disc system. This is an American-designed system which is being manufactured increasingly in U.K. A SEED survey of its sales showed 60% of the customers were educational establishments, a further 10% research institutes, 10% hobbyists and the rest commercial companies. A distributor network is being set up.	Basic system is £1,100 (£815 as kit); Minidisc—£2,500; large floppy disc £3,200; hard disc £8,000-plus
TANDY CORPORATION Bilston Road, Wednesbury, West Midlands 021-556 6101	TRS-80 , Min size: Level 1 4K memory; video monitor; cassette; power supply. Max size: Level 2 16K memory; line printer, floppy disc system.	Software: Basic; some business packages. An American system from the 200-outlet Tandy chain—The Level 1 is aimed at the hobbyist and education market and Level 2 at small business applications.	Level 1—£499; Level 2—£2,434
U-MICROCOMPUTERS PO Box, 24, Northwich, Cheshire 0606 75627	Challenger 1 . Min. size: 4K RAM, 8K Basic in ROM, keyboard, video and cassette I/F. Max size: 32K memory, printers, voice I/O, dual mini floppies, modem. Based on Ohio Superboard II. Challenger 2 . Min-size: (C2-4P) 4K RAM, 8K Basic in ROM, two slots for expansion (C2-8P has six slots for expansion). Max size: 36K RAM, mini-floppies, full-size floppies, hard disc (74MB), printers. Challenger 3 , Min. size: 32K RAM, dual mini-floppies, triple processor architecture (6502A, Z-80, 6800). Max size: 768K RAM, 74MB hard disc, multiple terminals, printers.	Fast Basic in ROM with wide range of business, personal, games and educational software on cassette or mini-disc. Similar to Challenger 1. Can run virtually all 6502, 6800, 8080 and Z-80 code. With CP/M, languages Basic, Fortran, Cobol can be run. Full business software packages available including word processing and database management. Multi-programming available.	From £300. Single mini-floppy system about £1,400. From £700. From £3,550 (C3 OEM) to £10,000 plus (C3 B with 74MB disc).

We are anxious to keep the guide as up-to-date as possible. If you manufacture or import a computer, and you are not included, contact the Editor on 01-207 3111.

INTRODUCING

THE GREAT BRITISH KEYBOARD BY **alphameric**



NO SWITCHES TO FAIL

ALL 128 ASCII CODES

**TRUE N KEY ROLLOVER
TACTILE FEEDBACK**

RUGGED CONSTRUCTION

**LOW POWER CONSUMPTION
TWO SHOT MOULDED BUTTONS
POSITIVE OR NEGATIVE LOGIC**

PROFESSIONALLY PROVEN DESIGN

AVAILABLE NOW

ALPHAMERIC'S very own A/D LSI/MOS encoder plus ALPHAMERIC's patented proximity detection minimises soldered and mechanical connections, minimises component counts, and eliminates expensive PTH boards. The result is outstanding reliability at modest costs.

54 trimode coded keys (including Escape, Delete, Backslash) plus Control, Caps Lock (for TTY compatibility) Shifts, on-board Repeat, plus a DC level key for firing Reset, Interrupt etc. 60 keys in all.

Unbeatable by the fastest operator.

Like some high quality typewriters, it tells your fingers what they're doing. Has Industry Standard full-travel keys.

A steel chassis takes the knocks and protects the PCB. The key mechanics cannot transmit excessive stress to the PCB.

Only 25 ma at +5V and -12V.

For key inscriptions that never fade.

Logic for data bits (one TTL load) and for strobe/DC outputs (5 TTL loads) are separately user-selectable for easy interfacing to Micros, UARTs, etc.

ALPHAMERIC's keyboards are in thousands of Great British Terminals (and overseas terminals too!) ALPHAMERIC's MOS encoder (world's first for capacitive keyboards) was first available five years ago.

Brand new, ex-stock, with data sheet and 12 month warranty. Cash and Carry or clip the coupon. £75 each plus £6 VAT plus £2 P & P if applicable. Mating 20 way Berg connector plus 2 metres 20 way ribbon cable available at £3 plus £0.24 VAT.

DON'T TAKE A RISK WITH A HEAP OF MECHANICAL SWITCHES! INVEST A LITTLE EXTRA IN STATE-OF-THE-ART SOLID-STATE RELIABILITY! CLIP THE COUPON NOW!

ALPHAMERIC Keyboards Ltd.
Reg. in England No. 1044892

Manor Way, Old Woking,
Surrey. GU22 9JX

NAME

ADDRESS

.....

.....

.....

Send me . . . Great British Keyboards at £83 each inc VAT and PP
Send me . . . mating connectors each with 2 metres cable @ £3.24

I enclose my cheque (allow 7 days for clearance)
Charge to my VISA/ACCESS/DINERS card
Expiry date:

Card No:

Signature:

Not VISA

A PRACTICAL GLOSSARY

Continuing the terminological gamut from G to H

Graphics

Any output which is not alphanumeric; more specifically, the term refers to pictorial symbols and representation built from them. There's much to be said for using graphics as much as you can, largely on the 'picture being worth a thousand words' principle. That applies as much to the design of a screenful of information (try arranging information as organised blocks of copy to make it more meaningful) as it does to creating charts and pictures (lunar lander games gain from the inclusion of a lunar module about to hit the surface; seeing a string of changing figures labelled 'height' simply isn't the same).

Many personal computers have graphics built in, and for others there are several option boards which provide graphics, especially if you have a micro using the S100 bus.

Hard-copy output in graph form can be done by some printers—it looks a bit jerky if you're doing curves, though, because the print-head cannot move in fine enough increments. A graph plotter can do those really small movements, and they tend to use ink-filled pens to draw a continuous line; the printers tend to do it as a string of dots. Plotters aren't cheap, however, though there is at least one U.S. plotter below the \$1,000 mark. Can't you do without graphical hard-copy?

Half-duplex

Refers to a communications link in which data may travel in both

directions along the connected line, but not at the same time. See *full duplex* for an equally interesting definition using slightly different words.

You'll probably encounter the full-or half-duplex question only as a user of a computer terminal, and generally you don't have much say in the matter—your terminal will probably have a switch marked FULL/HALF or FDX/HDX and if it isn't set appropriately you won't be able to talk to the computer.

Halt

An instruction or internally-generated condition which switches the computer out of the 'run' mode in which it was executing a program. The computer doesn't lose its place, though—it HALTS, remembering which line of the program is due to be executed next.

HALT is used usually in program development; you can set the computer cleverly to detect mistakes, for instance, and cause it to suspend operation temporarily to allow you to do something about it. The HALT state frequently gives the user the chance to set and re-set internal conditions from the keyboard, so that when you re-start the program it continues executing but with slightly altered conditions.

Handler

A device (or peripheral) handler is alternatively called a *driver*: it's a bit of a program (usually a bit of the *operating system*, in fact) which

communicates with and generally controls one of your system's peripherals. The handler for the keyboard, for instance, will detect what you mean when you depress a particular key; and it will pass on that information to the central processor for some action.

Handshake

What you get from writing too many glossary definitions too quickly. Alternatively, it's a term which refers to communication between two parts of a system, typically a terminal and the central processor. It means that the receiving end is confirming that it has, in fact, received something. It's a pleasantly graphic term, isn't it? Still, it is a bit heavy; you can now forget it.

Hard copy

Hard copy is computer output on paper, printing or graphics. You may hear the term 'hard-copy printer': that is tautology, since all printers, of course, produce hard copy. It is called 'hard' to indicate a degree of tangibility; 'soft copy' is what appears on a VDU screen.

Hard-sectored

Data is stored on disc in *tracks*, concentric rings around the spindle. So if you know which track a piece of data is on, you have to get the read/head on to that track and read around it until you reach the data; you don't have to read the whole disc looking for it.

Sectoring speeds the process

even more. Discs are also organised into *sectors*, which are wedges rather like slices of cake. So each track is split effectively into a number of sectors; and if you can identify the location of data by track and sector, the read/write head can be directed to the start of the sector on the particular track, and it doesn't have to read round the whole track looking for the data.

Tracks are fixed on the disc by the factory. On some disc systems sectors are, too; the start of a sector is actually defined by a hole punched in the disc surface. That's *hard-sectoring*.

Hardware

Hardware is the physical side of computing, the equipment and physical components. Software is the paperwork, the programs, even the idea involved in programming. The third element is *data*, operated upon by software within hardware.

We've said this before but the dividing line starts to blur if you do not make a distinction between programs and media. So here's your starter for ten—is a programmed read-only memory software or hardware? How about a floppy disc? The PROM is an IC chip, so it's hardware. In practice, it might be more useful to think of it as software. Some people have tried to call hardware-implementation programs 'middleware'.

The semantics are not really worth bothering about too much, so long as you know what you mean when you use the terms.

Advertisement Index

Airamco	82	Games Workshop	66	OMB Electronics	16
Almarc Data Systems	76	Happy Memories	18	Optronics	10
Alphameric Keyboards	103	Hazeltine	12	Padmede	22
American Data and Office Computer	44	HB Computers	84	Pelco	6
Boer (De Boer Elektronica)	20	Henry's Radio	75	Personal Computers	30
Byte Shop	23, 56	HL Audio	17	Petalect	9
Cambridge Computer Store	16	Integrated Circuits Unlimited	14	Petsoft	28
CC Microsales	10	Jade Computer Products	11	Planned Data Furniture	22
CCS Microhire	6	J & J Electronics	82	Plessey	52
CC Soft	76	Keen Computers	34	Rair	4, 24
Cifer	78	Linburg Electronics	80	Research Machines	19
Clustan (Microcentre)	8	London Computer Store	99	Robin Bailey	68
Comart	5	Lotus Sound	50	Rosstronics	60
Commodore Systems Division	15	LP Enterprises	8, 13	Tangerine	75
Comp Computer Components	106-107	Marshall's	60	TDS	56
Compucorp	105	Microbits	6	Technical Book Services	54, 55
Computrade	10	Microdigital	80	Texas Instruments	26
Computer Workshop	108	Micromedia	84	Tim Orr	75
DAMS	66	Microsoft Systems	18	Transam	21
Data Efficiency	62	Microsolve Computer Services	56	T & V Johnson	12
Electronic Brokers	20	Nasco Microcomputers	78, 80, 82	Videotime	60
Electrovalue	32	Newbear Computer Store	99	V & T Electronics	10
Equinox	8, 56, 101			Xitan	62
Factor One	78			Shop Window	85-95
				Jobs	96

COMPUCORP ANNOUNCES THE 610

THE NEW ADDITION TO ITS 'ALL IN ONE'
MICROCOMPUTER FAMILY



- * Why have a separate Microprocessor + VDU + Discs + Interfaces when you can have a complete system, beautifully packaged and ready to use by simply turning on only one switch.
- * The 610 and the 625 are already being used in practical environments for applications such as Payroll (with up to 3,000 employees); Incomplete Records (3,700 transactions per client and almost 450 Nominal Accounts); Stock Control/Invoicing; Estate Agents (2,000 properties, 500 clients held on disc at one time); Accounting; Dealing on the Foreign Exchange Markets in order to provide daily and monthly reports as required by the Bank of England.
- * Complete back-up service available.

The 600 Series uses

- * Z80 Microprocessor
- * Extended Basic and Assembler with one of the most complete File Management Systems available enabling identical packages to work on the 610 and 625.
- * Up to 60K internal memory.

The 600 Series has complete range of Interfaces and peripherals available to include:-

- * 160 cps dot matrix printer
- * 1k Cmos and Real-time clock
- * RS232/V24 Interface
- * IBM-compatible tape
- * 220 Volt uninterruptable Power Supply
- * A/D and D/A Convertor for process control
- * Up to 4 min. floppy drives at 315k bytes each, totalling 1.2 MEG(625)
- * 10 and 20 meg. cartridge disc
- * 32 bit parallel interface
- * IEEE interface for instrumentation
- * S-100 Bus

- * Price of the 600 Series starts from £3,890 and includes
- * 48k RAM Memory; 150k Floppy Disc; VDU; Full Operating Software to include Basic; Assembler; File Management; Disc Operation System and Text Editor
- * DEALERS REQUIRED
- * SUBSTANTIAL OEM AND DEALER DISCOUNTS AVAILABLE

COMPUCORP LTD., CIRCLE HOUSE SOUTH, 65-67 WEMBLEY HILL ROAD, WEMBLEY,
MIDDLESEX. Telephone: 01-903 5444

INTERESTED IN HOME COMPUTING?

Start now and don't get left behind **THE NASCOM 1** is here Ex-stock with full technical services

Plus the opportunity to join the fastest moving club of personal computer users enabling you to get the most out of your computer. You can OBTAIN and EXCHANGE programs and other software — many now available.

The Powerful Z80
Microprocessor
Professional Keyboard
1 Kbyte Monitor in EPROM
2 Kbyte RAM (expandable)
Audio Cassette interface
Plugs into your domestic TV
Easy construction from
straightforward instructions
— no drilling or special tools
— Just neat soldering
required.

Only ~~£197.50~~ + 8% VAT (includes p & p + insurance)

Manuals separately 2.95
Z80 programming Manual 6.90
Z80 Technical Manual 2.95
PIO Technical Manual 2.95

(All prices add 8% VAT)



**SAVE
£60**

**NEW LOW PRICE
£165**

Power supply suitable for
NASCOM 19.90

NASCOM AD ONS — Nascom improved monitor B Bug (2K) featuring — *Four times tape speed *Direct text entry without ASCII *Extended keyboard facility *Additional useful subroutines **£23.00**

Nascom Vero Case **£22.50**

Nascom Music Box Kit **£9.90**

(write your own tunes and play them on your Nascom.)

Nascom Joy Stick Kit **£14.90**

Complete with full documentation.

GRAPHICS ADD ON BOARD £9.90

Complete kit to upgrade your NASCOM for graphics capability includes full documentation and demonstration program.

NASCOM IMMEDIATE EXPANSION S100 from COMP —strongly recommended

The only available S100 motherboard kit (fully buffered) that plugs directly into your Nascom. Designed for the insertion of S100 boards (e.g. Static RAM, EPROM and discs etc.).

S100 Motherboard/Buffer **£47.50**
(Complete kit + documentation) } Motherboard comes complete with 2K Tiny Basic On cassette.
Suitable 8K Static RAM Memory ~~£125~~ **£110**
(fully assembled tested and guaranteed)

ATTENTION! **SAVE £90** TRS 80 & APPLE II USERS

16K UP GRADE KIT HALF NORMAL PRICE **£99** + VAT **LIFETIME GUARANTEE**

Simple to fit—only a screw-driver is required.

SHORT C12 CASSETTES 10 for £4.00 FOR COMPUTER PROGRAMMES

TV GAME BARGAINS TELEPLAY PROGRAMAGAME

Fully Assembled Reduced to **£24.90** + VAT

SAVE £10

ATARI VIDEO SYSTEM

REDUCED TO **£139** + VAT

**SAVE
£30**

PET COSTS LESS AT COMP and it's a pedigree **RRP £550**

The No. 1 Personal Computer in the U.K. **£499** SAVE **£50** Affordable + VAT

for the first time user and the professional check out the PET, the world's most popular personal computer. **8K**



OHIO SUPERBOARD II NEW FIRST IN UK —ON DEMO

For electronic buffs. Fully assembled and tested. Requires +5V at 3 Amps and a video monitor or TV with RF converter to be up and running.

STANDARD FEATURES

Uses the ultra powerful 6502 microprocessor
8K Microsoft BASIC-in-ROM

Full feature BASIC runs faster than currently available personal computers and all 8080-based business computers.

4K static RAM on board expandable to 8K

Full 53-keyboard with upper/lower case and user programmability

Kansas City standard audio cassette interface for high reliability

Full machine code monitor and I/O utilities in ROM

Direct access video display has 1K of dedicated memory (besides 4K user memory), features upper case, lower case, graphics and gaming characters for an effective screen resolution of up to 256 by 256 points. Normal TV's with overscan display about 24 rows of 24 characters; without overscan up to 30 x 30 characters.

EXTRAS

Available expander board features 24K static RAM (additional), dual mini-floppy interface, port adapter for printer and modem and an OSI 48 line expansion interface.

Assembler/editor and extended machine code monitor available.

~~£280.00~~ **£249.00** + VAT *Send £10 to reserve One-pay balance on delivery.*

MODULATORS UHF Channel 36

Standard 6 meg band width **£2.25**
High Quality 8 meg band width **£4.90**

BULK PURCHASE VDU MONITORS

~~£99~~
£69
+ VAT



CASED AND GUARANTEED **12"**

TRS 80 SOFTWARE NEW

100 MIXED PROGRAMMES **£49.00**
on cassette

KEY BOARD

756 GEORGE RISK

Brand new professional ASCII keyboards (USA)

Full technical details included. RRP **£60.00**

Only **£49.90**
+ 8% VAT.

Ready built, tested and guaranteed.



All prices include VAT except where shown. Orders over £5 post and packing free otherwise add 20p. Please make cheques and postal orders payable to COMP, or phone your order quoting BARCLAYCARD or ACCESS number.

OPEN — 10am to 7pm — Monday to Saturday
CONTINUOUS DEMONSTRATIONS



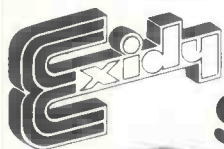

SORCERER™ COMPUTER SPEAKS YOUR LANGUAGE



THIS COMPUTER HAS ALL OF THE FACILITIES NEEDED TO FORM THE NUCLEUS OF A SMALL BUSINESS SYSTEM FOR AN EXCEPTIONALLY SMALL OUTLAY.

EX STOCK

Are you looking for a PERSONAL or SMALL BUSINESS Computer? Look at these features for only **£850** + VAT

- 256 Character Graphics Set includes 128 that you can define.
- Z80 Based computer.
- Power-on 4K Monitor
- Excellent bit-mapped graphics (512 x 240 point resolution)
- Full 79 key dp keyboard including 16 key numeric pad (Full ASCII)
- Plug-in ROM facility (e.g. 8K BASIC, (supplied), Assembler/editor, word processing etc.) so that you can change your language or utility by simply plugging in the one you want.
- 32K of RAM on board.
- Serial I/O ports for cassette/RS232 etc. (300 or 1200 Baud)
- Parallel I/O port for printer (Centronics Compatible)
- Z80 bus available at the rear for connection to the optional 6 slot S100 expansion box (e.g. S100 Floppy disk drives, graphics boards, extra memory etc.)

EXIDY SORCERER 32K RAM computer	£850
(Add £9 for UHF output) 16K RAM computer	£751
12" Video monitor	£69
S100 expansion box (includes 6 Slot Motherboard and power supply)	£210

DISK SYSTEM as shown
MICROPOLIS S100 disks — 315 K bytes per drive
 Drive 1 (includes S100 controller, Micropolis M DOS and BASIC software) **£649**
 Additional 315 K bytes drives (up to 4 per controller) **£349**
 Cables and regulators for 2 disk system **£41**

PRINTER as shown
ANADEX DP8000
 80 columns, 112 char/sec 5 x 7 dot matrix head
 Connects to parallel or serial ports **£575**

ADDITIONAL SOFTWARE FOR SORCERER PLUS DISK SYSTEM

CP/M operating system	£145
CP/M with C BASIC (Compiler/Interpreter)	£235
FORTRAN 80	£350
COBOL 80	£490

MICROPOLIS BASIC PACKAGES FROM COMPUMAX	} STOCK CONTROL (INVENTORY) PAYROLL ACCOUNTS RECEIVABLE LEDGER PERSONNEL	} £99 each

COMP COMPUTER COMPONENTS

(PART OF THE COMPSHOP LTD. GROUP)

For technical and sales literature send SAE to:
 COMP COMPUTER COMPONENTS (Exidy UK Sales),
 Freepost, 14 Station Road, New Barnet, Herts.
 Tel: 01-441 2922 (Sales) 01-449 6596 Telex: 298755

TAKE ADVANTAGE OF OUR SHORT DELIVERY TIME.

All prices exclusive of VAT

SEND FOR OUR SPRING '79 CATALOGUE - 0-60p

We're getting bigger to give you a better service

We've opened a Sales and Customer Service Centre in London. And our new factory is fully operational. Southwest Technical Products provide a range of superb computer systems with technical backing second to none.



Systems

To suit all types of user – OEM, process control, data handling, small business systems, and all accounting functions.

Software

Low cost packages for word processing, selective mailing, progress control and invoicing. Our Software Development Unit available to prepare programmes to customer specification.

Training

Inexpensive courses (at Dover Street): **BASIC** – programming for the businessman; **microcomputers in EDUCATION**; **WORD PROCESSING made easy**; **SOFTWARE DEVELOPMENT** – make your microprocessor work.

Maintenance

Comprehensive national service by Computer Field Maintenance Ltd.

Sales Office: 38 Dover Street, London W1.

Tel: 01-491 7507 Telex: 268913.

Factory: 12 Tresham Road, Orton Southgate, Peterborough.

Tel: 0733-234433 Telex: 32600.



the symbol of reliability