

xenic





xenic

Taking off in full flight is our latest addition of our impressive line of office chairs. A chair gifted by nature as our designer (Joe Leong) was fully inspired by the dance of the multi-colored butterfly... that its wings are now fully supporting and caressing the lumbar for a comfortable seating posture.

Xenic transformation from nature's eco-environment in the insect world has humanised our latest products allowing us to cocoon in our seats while we perform our best...





CODE : **XPX1N1H-A**
 Butterfly Colour 
 Fabric Colour PASSED



CODE : **XPX1N1H-A**
 Butterfly Colour 
 Fabric Colour CALYPSO



CODE : **XPX1N1H-A**
 Butterfly Colour 
 Fabric Colour HULA



CODE : **XPX4S4H-A**
 Butterfly Colour 
 Fabric Colour SCUBA



CODE : **XPX4S4H-A**
 Butterfly Colour 
 Fabric Colour WINDJAMMER



CODE : **XPX4S4H-A**
 Butterfly Colour 
 Fabric Colour PASSED

Xenic style variations

Xenic mesh and fabric are available in multiple combinations offering endless styling possibilities.



CODE : **XPX4S4M-B**
 Butterfly Colour -
 Fabric Colour WINDJAMMER



CODE : **XPX4S4M-A**
 Butterfly Colour 
 Fabric Colour PASSED



CODE : **XPX4S4M-A**
 Butterfly Colour 
 Fabric Colour CALYPSO



CODE : **XPX1N1M-A**
 Butterfly Colour 
 Fabric Colour HULA



CODE : **XPX4S4M-B**
 Butterfly Colour -
 Fabric Colour SCUBA



CODE : **XPX1N1M-B**
 Butterfly Colour -
 Fabric Colour PASSED



CODE : **XPX4S4H-B**
 Butterfly Colour -
 Fabric Colour SCUBA



CODE : **XPX1N1H-B**
 Butterfly Colour -
 Fabric Colour HULA



CODE : **XPX1N1M-B**
 Butterfly Colour -
 Fabric Colour CALYPSO



CODE : **XPX4S4H-B**
 Butterfly Colour -
 Fabric Colour WINDJAMMER



CODE : **XPX4S4M-A**
 Butterfly Colour 
 Fabric Colour SCUBA



CODE : **XPX4S4M-A**
 Butterfly Colour 
 Fabric Colour WINDJAMMER



CODE : **XPX1N1M-A**
 Butterfly Colour 
 Fabric Colour CALYPSO



CODE : **XPX4S4H-B**
 Butterfly Colour -
 Fabric Colour WINDJAMMER



CODE : **XPX1N1M-A**
 Butterfly Colour 
 Fabric Colour PASSED



CODE : **XPX1N1H-A**
 Butterfly Colour 
 Fabric Colour PASSED



- A Supportive Backrest**
Mesh designed backrest allows you to fit your body closely and provide breathability for comfortable sensation even after long hours of sitting.
- B Armrest**
Xenic armrest comes in ergonomic design with curve area for you to rest your hand comfortably. It is available with height adjustable and fixed armrest.
- C Changeable Seat Cover**
One of Xenic great feature is its changeable seat cover. Its creative, stylish and flexible designed fabric seat cover is easy for you to velcro over.
- D Adjustable Headrest**
The nylon headrest with height adjustment and intuitively bend function allows you to adjust it to best suit your posture for utmost comfort with colourful fabric cover.
- E Adjustable Lumbar Support**
Xenic lumbar support comes in various colours together with spring load adjustment, which allows you to adjust it in various heights, in orders to keep your pelvic in the correct position. It made of High Density Polyethylene (HDPE), a lightweight and tensile strength plastic that is recyclable yet environmentally friendly.
- F Seat Depth Adjustment**
Xenic's adjustable seat depth allows you to move the seat pan to accommodate different leg length for better comfort.
- G Synchronized Multi-locking Mechanism**
Automatically coordinates your seat and back movement, and lock your ideal position that suit to your required posture.

OPTIONS FOR GREEN

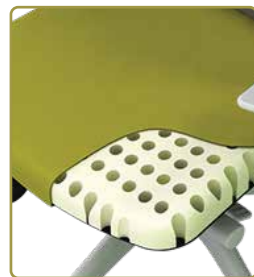

*Natural latex seat is applied only in Xenic chair.

Xenic Seat in Natural Latex
Xenic seat is using natural latex foam that is obtained from the sap of rubber tree. It provides natural spinal support and maximum comfort. The small pinhole design on the cushion offers excellent ventilation to promote air circulation on your seat. In addition, natural latex is elastic and highly resilient, it allows the cushion to return quickly to their original shape after being compressed. Thus Xenic cushion shape is resistance to compression and comfort to the shape of your body. With this seat cushion made of natural latex, the entire chair become a highly sustainable product and qualified as a "GREEN CHAIR".

GECA Certificate



ADVANCE RANGE

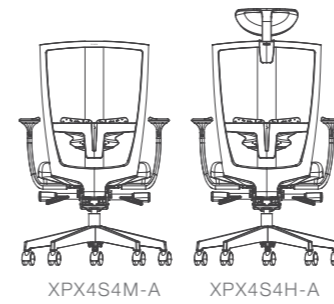

BASIC RANGE

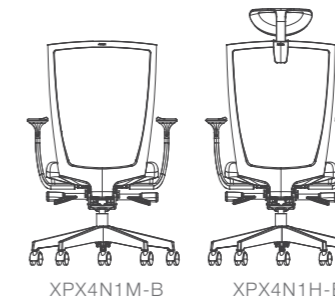

Lumbar Support Colours



Seat Fabric Colours

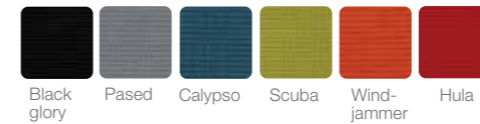

Backrest Mesh Colours



Frame Colours

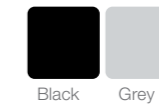

Armrest Types



Base Types



Mechanism Types

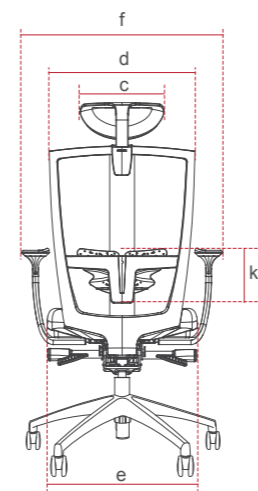
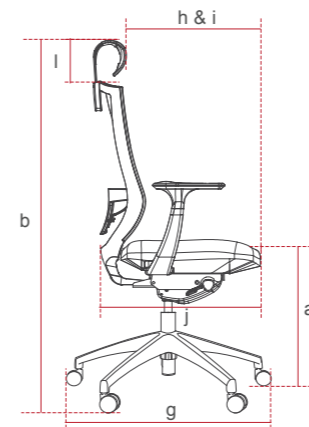

| Code | Dimension (mm) | Advance range in aluminium base | | Basic range in nylon base | |
|------|--------------------------------------------|---------------------------------|------------|---------------------------|------------|
| | | High back | Mid back | High back | Mid back |
| a | Seat height | 450 - 535 | | | |
| b | Overall height | 1115 - 1200 | 955 - 1040 | 1095 - 1180 | 945 - 1030 |
| c | Headrest width | 270 | | 270 | |
| d | Backrest width | 372 - 470 | | | |
| e | Seat width | 485 | | | |
| f | Overall width for Xenic fixed armrest | 615 | | | |
| | Overall width for Xenic adjustable armrest | 630 | | | |
| | Overall width for Mars adjustable armrest | 625 | | | |
| g | Base width | 740 | | 730 | |
| h | Seat depth | 480 | | | |
| i | Seat depth range | 50 | | | |
| j | Overall depth | 530 | | | |
| k | Lumbar support height adjustment range | 70 | | | |
| l | Headrest height adjustment range | 60 | | 60 | |

* Variance ± 5mm

| Packaging Types | Container Sizes | | |
|------------------------------------------------------------------------------------------|-----------------|--------------|--------------|
| | 20' GP | 40' GP | 40' HQ |
| Completely Knocked Down (CKD) 1 chair per carton, chair base packed separately | ± 216 chairs | ± 448 chairs | ± 512 chairs |
| Fully Assembled 2 chairs per carton | ± 100 chairs | ± 216 chairs | ± 216 chairs |

eco-label by:



License No. ARX International 2011 Standard - GSC 07 2011-uniform fittings
ARX-2014
GECA 25-2006 v2 Furniture & Fixings



ARTMATRIX TECHNOLOGY SDN BHD (694144-X)
ARTMATRIX MANUFACTURING SDN BHD (693659-U)

Lot 32789, Jalan 5/1A, Taman Perindustrian Selesa Jaya,
 43300 Balakong, Selangor, Malaysia.

☎ +603 8962 2286 ☎ +603 8961 8862
 ✉ sales@artmatrix.com.my 🌐 www.artmatrix.com.my



KK SHOWROOM

B-07-3, 3rd Floor, Lot 7, Block B, Kota Kinabalu Times Square,
 Off Coastal Highway, 88100 Kota Kinabalu, Sabah, Malaysia.

☎ +6088 44 8355 / 44 8655 ☎ +6088 44 8455

ARTMATRIX UAE (LLC)

PO Box 111497, AL Quoz, Dubai, UAE

☎ +97143419156 ☎ +97143419157 🌐 www.artmatrix.ae

International member of



License No : ART/International/2011
 Standard : GES/IF/2011-anterior fittings



ARK-2014
 GECA 38-2006-v2
 Furniture & Fittings



Top 10 Outstanding
 SMEs - Ranked 3rd



Export Excellence
 Award



Product Excellence
 Award



The Brand Laureate -
 SMEs Chapter Awards 2010



Enterprise 50
 Award 2009

