

Special
IBM Issue

BYTE

\$4.00
\$5.00 in Canada
A McGraw-Hill Publication
0360-5280
Display until Oct. 25

THE SMALL SYSTEMS JOURNAL

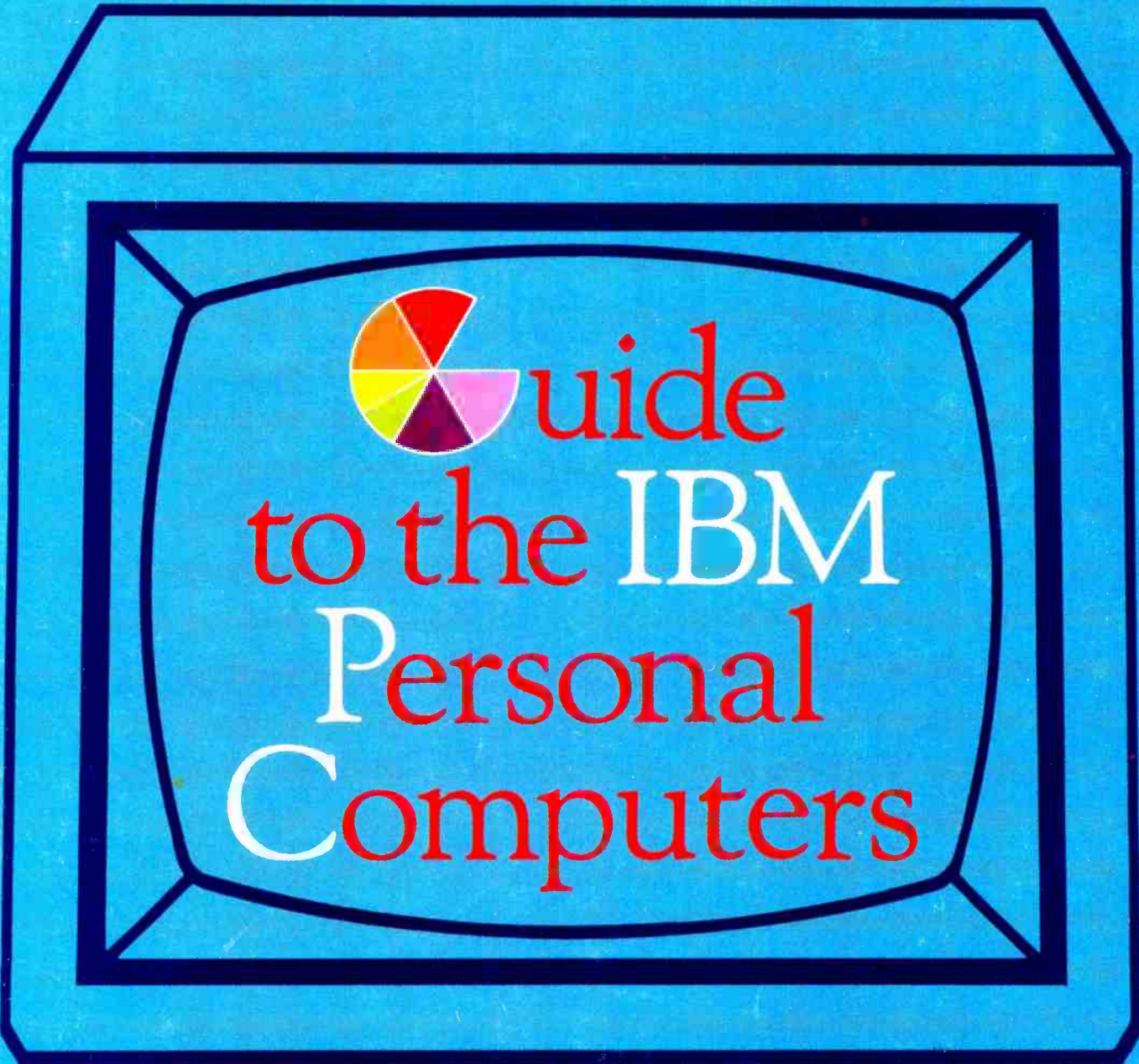

IBM PC, IBM PC XT, IBM PC Portable,
IBM XT/370; IBM 3270, IBM S9000



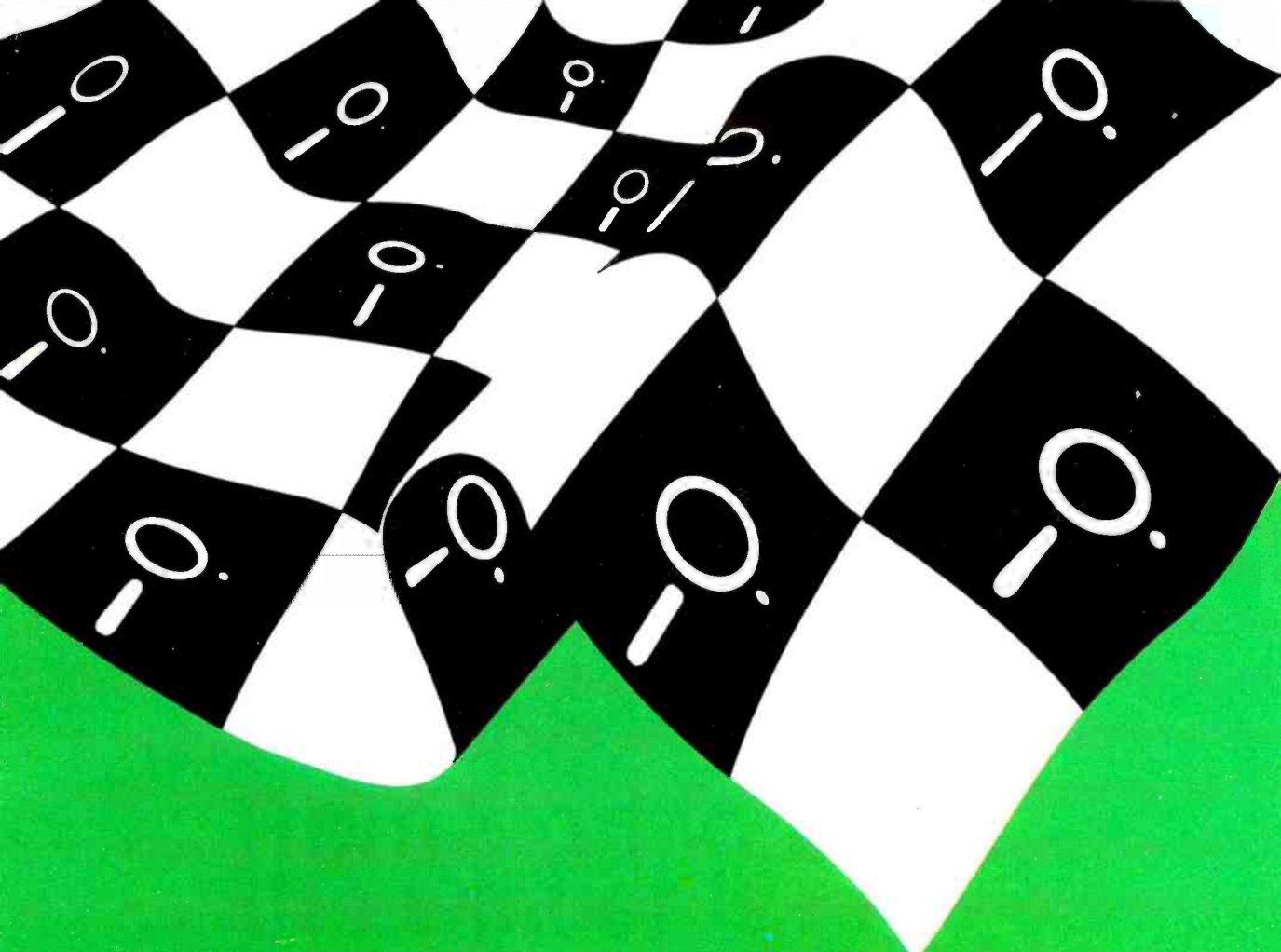

From start to finish
The winner is . . .

BORLAND IN™

If you're programming . . . Turbo Pascal™ makes it easier and much faster . . . from start to finish.

Now . . . with the advent of Turbo Pascal™, Pascal is a language for everyone who programs. It comes with a built-in editor, occupies only 35K of your precious memory and is menu-driven for true, programming ease.

Whether you're a professional software developer, a student, or someone who just enjoys programming for its own sake, Turbo Pascal™ is designed for you.



\$49.95

"Turbo is much better than the Pascal IBM sells."

Jerry Pournelle, *Byte*, July 1984

"If you have the slightest interest in Pascal . . . buy it."

Bruce Webster, *Softalk IBM*, March 1984

- Automatic Overlays
- A Full-Screen Editor
- Full Heap Management — via dispose procedure
- Full Support of Operating System Facilities

- Windowing (IBM PC, XT, jr. or true compatibles)
- Color, Sound and Graphics Support (IBM PC, XT, jr. or true compatibles)
- Optional 8087 Support (Available at an additional charge. Even if you haven't yet added an 8087 math chip to your 16 bit machine, you can purchase this now and be ready for the future. Both versions will be on your disk.)
- No License Fees. You can sell the programs you write with Turbo Pascal without extra cost.
- Free Spreadsheet Included. Yes. We include Microcalc . . . the sample spreadsheet written with Turbo Pascal. You can study the source code to learn how a spreadsheet is written . . . it's right on the disk.

YOU CAN ORDER YOUR COPY OF SIDEKICK™ OR TURBO PASCAL™ TODAY!

For Visa and MasterCard orders call Toll Free 1-800-255-8008

in California 1-800-742-1133

(lines open 24 hours, 7 days a week) Dealer and Distributor Inquiries Welcome 408-438-8400

CHOOSE HERE: (Please add \$5 shipping and handling per copy for U.S. orders)

___ Sidekick™ \$49.95 plus \$5
(Available only for the IBM PC, XT, Jr. and Compatibles)

Please specify computer _____

Turbo Pascal™

My system is 8 bit _____ 16 bit _____

Operating System: CP/M 80 (Z80 only, no 8080) _____

CP/M 86 _____ MSDOS _____ PCDOS _____

Computer: _____ Disk Format: _____

___ Turbo Pascal \$49.95 plus \$5

___ Turbo Pascal with 8087 support \$89.85 plus \$5

(California residents add 6% sales tax. Outside U.S.A. add \$15 shipping and handling per copy. If outside of U.S.A., payment must be by bank draft payable in the U.S. and in U.S. dollars. Sorry, no C.O.D. or purchase orders.) E27

\$ _____ Total enclosed

Check _____ Money Order _____

VISA _____ MasterCard _____

Card # _____

Expiration Date _____

Name: _____

Address: _____

City/State/Zip: _____

Telephone: _____



BORLAND
INTERNATIONAL

Borland International
4113 Scotts Valley Drive
Scotts Valley, California 95066
408/438-8400
TELEX 172373



INTERNATIONAL

Whenever you're using your computer . . . *from start to finish* of your session . . . Sidekick™ will be there . . . ready to serve. And it's as lightning-fast and compact as only Borland knows how to make it.

SIDEKICK

THE SUPER ORGANIZER



ALWAYS JUST A KEYSTROKE AWAY . . .

Introductory Offer

\$49.95



WHETHER YOU'RE RUNNING 1-2-3, WORDSTAR, dBASEII OR WHATEVER . . .

JUST A KEYSTROKE AND A SIDEKICK WINDOW OPENS . . .

- A CALCULATOR
- A NOTEPAD
- AN APPOINTMENT CALENDAR
- AN AUTO DIALER
- A PHONE DIRECTORY
- AN ASCII TABLE
- AND MUCH MORE

ALL AT ONCE . . . OR ONE AT A TIME. ANYWHERE ON THE SCREEN YOU LIKE.

ANOTHER KEYSTROKE, AND YOU'RE RIGHT WHERE YOU LEFT OFF IN YOUR ORIGINAL PROGRAM!

(you never really left!)

Here's Sidekick in action. That's Lotus 1-2-3 running underneath. In the Sidekick Notepad you can see data that's been imported from the Lotus screen. On the upper right, that's the Sidekick Calculator.

There's a notepad that has a full-screen editor that can time and date stamp your notes, and then save them to disk. You can even pull information into the notepad directly from the screen of your underlying software.

Suppose you're working with a spreadsheet, and you suddenly have an important idea. Just hit the button, a window opens, you write the note and hit the button again. You're right back where you left off in the spreadsheet.

Need to make a phone call? Whether the number is in an existing database, your own Sidekick phone directory, or you've just typed it on the screen . . . put the cursor next to the number, hit the keystroke, and Sidekick dials for you!*

There's lots more, too. You can move the Sidekick windows anywhere on the screen you like. And you can have as many on screen at a time as you need. There's even an on-line help window for each of Sidekick's features.

We designed it because we needed it. If you've ever been writing a report and needed to do a quick calculation, or jot down a note, then you need Sidekick, too.

*Only with Hayes Smartmodem and compatibles.

Circle 23 on inquiry card.

IBM AND ITS PERSONAL COMPUTERS

There are two sides to the story of IBM's tremendous success in personal computers. The first side concerns what the IBM PC provided: a processor that could address a lot of memory, an 80-column screen, an open system architecture, a keyboard with upper- and lowercase and good cursor controls, and word-processing software that used correctly labeled function keys.

The second side of the story concerns the failure of other major companies to provide these same fundamental features earlier. In retrospect, it seems IBM stepped into a void that remained, paradoxically, at the center of a crowded market. The Apple III's word-processing software required you to memorize control codes and made no use of function keys. The Apple II required add-ons to provide such word-processing essentials as an 80-column screen and a full upper- and lowercase character set. The Apple development teams were laboring longer than they expected on software for the Lisa and the Macintosh. Eventually those projects bore fruit, but the world might have been different if Apple had first offered Lisa as a \$3000 machine with a 68000 microprocessor, a simple operating system, an 80-column screen, a good keyboard with cursor and function keys, two disk drives, and a set of four basic applications programs. The desktop, the bit map, and the mouse could have followed. The proprietary "Twiggy" disk drives could have given way to Tandons or Shugarts.

While Apple was trying, DEC and Data General were on the sidelines, Tandy's 16-bit system lacked software. Hewlett-Packard was concentrating on specialized markets, Commodore was thinking 8-bit and 64K bytes of RAM. AT&T was tied up by divestiture, and most other companies failed to convince enough prospective buyers that they were here to stay.

The void was there, and IBM stepped in. The array of IBM personal computers is now formidable: the PC, the Portable PC, the PC XT, the XT/370, the 3270 PC, the 68000-based S9000, and the PCjr (which badly needs to grow up). We did this *BYTE Guide to the IBM Personal Computers* because many

of our authors had interesting and original things to say about one or another of the IBM machines and we wanted to collect much of this material in one convenient volume. While our subscribers who own IBM PCs wanted more coverage of their machines in *BYTE*, we didn't want this coverage to be at the expense of our customary variety of features, reviews, theme articles, and columns in the regular issue.

We were hoping for the announcement of IBM's battery-powered portable and its multiuser personal computer in time for this issue, but as of this writing, such intriguing rumors remain rumors. Will the system based on IBM's proprietary 32-bit processor from the Austin group see the light of day? Will IBM's own operating system and applications software supplant those of independent software houses? Will the PCjr grow up? By entering the field of personal computing, IBM has brought the game of IBM watching to an audience of millions.

IBM has also given the field its third major standard, after the Apple II and CP/M. Standards sometimes deprive us of the latest and most innovative technology, but when a standard encompasses both hardware and system software, it cultivates the ground for a flowering of third-party software and peripherals. This increased base of software accompanied by hardware add-ons allows the standard machine to do almost any small computing task. Since the standard machine can do almost anything, everyone wants one.

But everyone also comes to want more. IBM's standard will not be the last, and not just because a one-computer and a one-company world would be dull. Apple's Macintosh offers a superior user interface that attracts passersby. AT&T is capable of creating a standard. HP, DEC, Tandy, and other companies are not to be ignored. IBM itself could bring forth a dazzling new generation of technology.

For the present, it makes more sense to enjoy the benefits of the current IBM standard than to curse it because it could be better. But enjoying the benefits of this standard shouldn't prevent us from keeping an eye open for something really new.

—Phil Lemmons, Editor in Chief

TREE OF LIFE

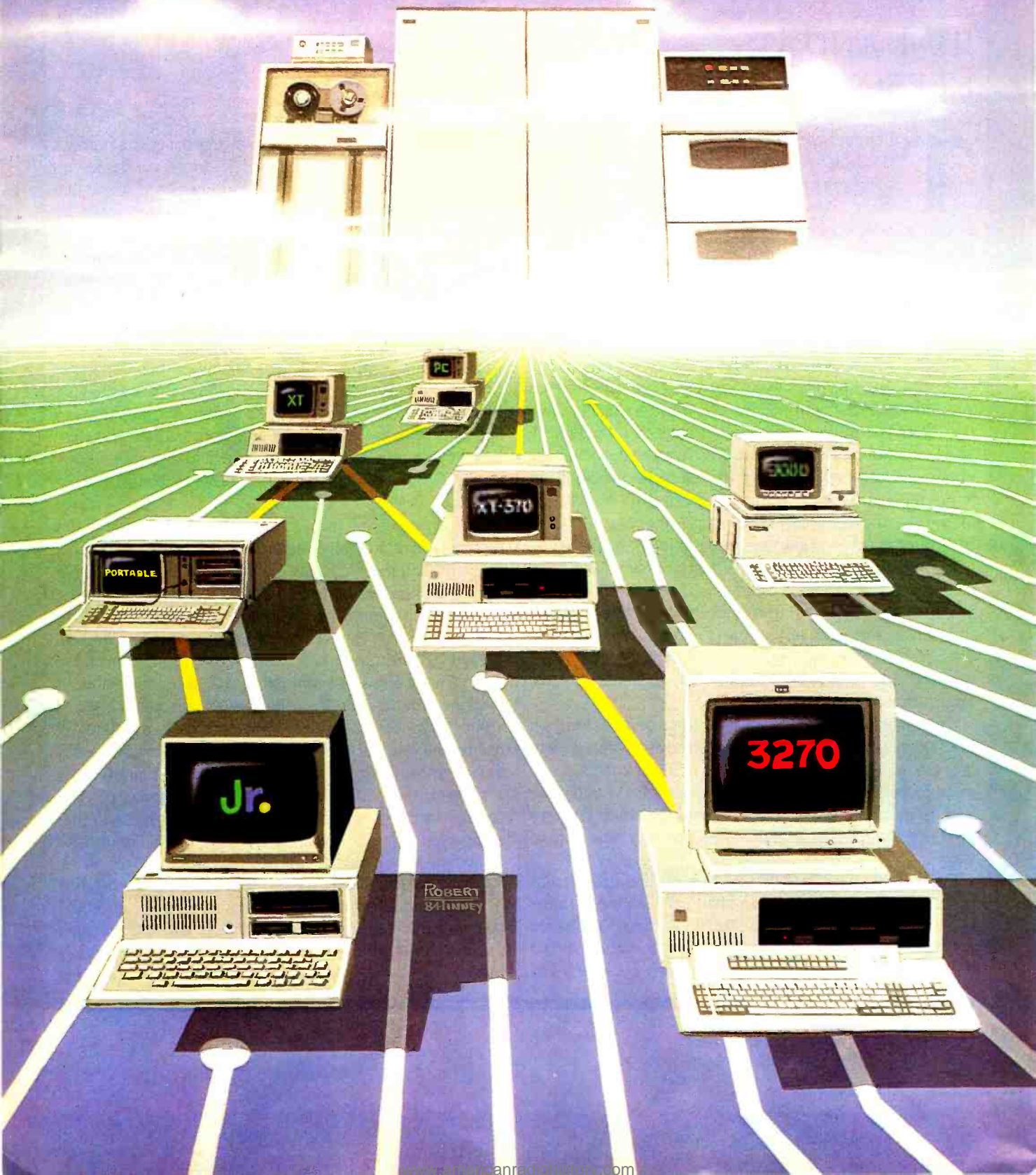

ROBERT
& WINNEY

IBM Guide

CONTENTS

from **BYTE**

IBM AND ITS PCs by Phil Lemmons 1

INTRODUCTION

THE ARRAY OF IBM PERSONAL COMPUTERS 9

■ **Matching Machines to Computing Requirements**

IBM PERSONAL COMPUTERS AT A GLANCE 10
The PC, PC XT, Jr., Portable, XT/370, 3270 PC, and S9000.

FORECAST: MARKET DOMINANCE by Michael Killen 30
A wide range of IBM products followed the PC's well-timed market entry.

STALWARTS

OPERATING SYSTEMS, PROGRAMMING LANGUAGES, AND APPLICATIONS 41

■ **Machines Within the Machines: Operating Systems**

A TALE OF TWO OPERATING SYSTEMS
by Charles Daney and Tom Foth 42
The virtual machine of the XT/370 at work with PC-DOS.

THE FUTURE OF UNIX ON THE IBM PC by Ralph A. Phraner 59
UNIX is running on the PC XT, but how soon will it be available?

FIVE WINDOW MANAGERS FOR THE IBM PC by John Markoff 65
You may be ready for window-management software, but is it ready for you?

■ **Manners of Speaking: Programming Languages**

TWO LOGOS FOR THE IBM PC by Morton Goldberg 91
IBM's Logo compared with a version from Digital Research.

THE LOGICAL RECORD KEEPER: PROLOG ON THE IBM
by James L. Weiner 125
PROLOG uses the techniques of a database manager in a programming language.

AN INTRODUCTION TO PC ASSEMBLY LANGUAGE PROGRAMMING
by William J. Claff 134
High-level languages are easier to learn if you understand assembly language.

■ **Ways of Working: Applications and Programming**

TECHNICAL AND BUSINESS GRAPHICS ON THE IBM PC
by Jack Bishop 155
Spreadsheet packages can improve the looks of any business presentation.

WORD PROCESSING REVISITED by Janet Cameron 165
A review of five new versions of popular word processors for the IBM PC.

SIX DATABASE-MANAGEMENT SYSTEMS FOR THE IBM PC
by David Kruglinski 187
Six popular databases have been updated on the IBM PC.

EVALUATING 8087 PERFORMANCE ON THE IBM PC
by Stephen S. Fried 197
The 8087 coprocessor for your IBM can save you time and money.

EXTRA POWER FOR SPECIAL NEEDS

IBM'S XT/370, 3270 PC, AND S9000 209

■ **The Micro as Mainframe/The Mainframe as Micro**

THE IBM XT/370 PERSONAL COMPUTER
by Ernest Sabine 210
IBM has put a virtual machine on everyone's desk.

NUMBER CRUNCHING ON IBM'S NEW S9000
by David J. States 218
The S9000, from IBM's instrument division, may be the first micro for the scientist.

THE MAINFRAME CONNECTION: IBM'S 3270 PC
by Larry Augustin 231
Faster communications and windows make the 3270 a bridge to IBM's mainframes.

■ **Maximizing the PC Family: Communications and Compatibility**

MODEMS: THE NEXT GENERATION by Mark Klein 238
Smart interfaces and new software are making modems easier to use.

MOVING DATA BETWEEN PCs AND MAINFRAMES
by Jay Siegel 248
Moving data between computers and terminal software can be a problem.

TESTING FOR IBM PC COMPATIBILITY
by Robert A. Stillman 256
Trying to stretch your PC budget may mean searching for a compatible machine.

WHAT'S NEW 266
BYTE looks at some of the latest products to boost the productivity of your PC.



IEEE • 488
High Speed Interface
For Personal Computers

Any IBM PC™
IBM PC compatibles
PC JR
Rainbow 100™

Language Support — Interpretive
BASIC, Compiled BASIC, C,
FORTRAN, Pascal, Assembly.

Operating Systems — PC DOS,
MS DOS, CPM 86/80, FORTH.

Software Compatible with our family
of IEEE-488 Interfaces for VAX,
PDP-11, LSI-11, S-100 BUS, STD
BUS, SBX, and Multibus computers.



**NATIONAL
INSTRUMENTS**
The Leader in IEEE-488
Computer Interfaces

12109 Technology Blvd.
Austin, Texas • 78727
800/531-5066 • 512/250-9119

Rainbow™ is a trademark of Digital Equipment Corp.
IBM PC™ is a trademark of International Business Machines.

EDITOR IN CHIEF, BYTE
PHILIP LEMMONS
MANAGING EDITOR, BYTE
GENE SMARTE

.....
BYTE GUIDE STAFF

MANAGING EDITOR
MICHAEL J. COMENDUL
TECHNICAL EDITOR
BRUCE ROBERTS
CHIEF COPY EDITOR
NANCY HAYES

ART DIRECTOR
ELLEN KLEMPNER-BEGUIN
PRODUCTION ASSISTANT
JAYMIA RYLL

ASSISTANT TECHNICAL EDITORS
RALPH BAUMGARTNER
DANIEL J. GINGRAS
MARGARET COOK GURNEY
STEVE HARDING
COPY EDITORS
BARBARA IATKOLA
HILARY SELBY POLK

.....
SENIOR TECHNICAL EDITORS, BYTE
RICHARD MALLOY, *Reviews*
G. MICHAEL VOSE, *Features*
GREGG WILLIAMS

TECHNICAL EDITORS, BYTE
THOMAS R. CLUNE
GLENN HARTWIG
RICHARD KRAIEWSKI
KEN SHELDON
RICHARD S. SHUFORD
JANE MORRILL TAZELAAR
STANLEY WszOLA
ALAN EASTON, *Drafting*

MANAGING EDITOR, USER NEWS, BYTE
GEORGE BOND

USER NEWS EDITORS, BYTE
ANTHONY J. LOCKWOOD, *What's New*
MARK WELCH, *Microbytes*

COPY EDITORS, BYTE
ELIZABETH R. COOPER, *Chief*
DENNIS BARKER
ANNE L. FISCHER
PAULA NOONAN
JOAN V. ROY
BUD SADLER
WARREN WILLIAMSON

.....
EDITORIAL ASSISTANTS
PEGGY DUNHAM
MARTHA HICKS
FAITH KLUNTZ, *Copyrights and Permissions*
BEVERLY JACKSON
LISA JO STEINER

.....
ART DIRECTOR, BYTE
ROSSLYN A. FRICK

PRODUCTION
DAVID R. ANDERSON, *Associate Director*
DENISE CHARTRAND
MICHAEL J. LONSKY
JAN MULLER
SHERRY MCCARTHY, *Chief Typographer*
NAN FORNAL
LEN LORETTE
VALERIE PAGE
DONNA SWEENEY

PUBLISHER
GENE W. SIMPSON
ASSOCIATE PUBLISHER/PRODUCTION DIRECTOR
JOHN E. HAYES
PUBLISHER'S ASSISTANT
DORIS R. GAMBLE
ADVERTISING SALES
J. PETER HUESTIS, *Sales Manager*
SANDRA FOSTER, *Administrative Assistant*
ADVERTISING
DEBORAH PORTER, *Supervisor*
MARION CARLSON
ROB HANNINGS
JEANNA REENSTIERNA
LISA WOZMAK
WAI CHIU LI, *Quality Control Manager*
LINDA J. SWEENEY, *Advertising/Production Coordinator*
JULIE NELSON

.....
CIRCULATION
GREGORY SPITZFADEN, *Director*
ANDREW JACKSON, *Subscriptions Manager*
CATHY A. R. DREW, *Assistant Manager*
PHIL DECHERT
MARY EMERSON
LOUISE MENEUGS
AGNES E. PERRY
LENNIFER PRICE
JANE VARNUM
JAMES BINGHAM, *Single-Copy Sales Manager*
LINDA TURNER, *Assistant Manager*
CAROL AHO
CLAUDETTE CARSWELL
EDSON WARE

.....
MARKETING COMMUNICATIONS
HORACE T. HOWLAND, *Director*
DOUG WEBSTER, *Director of Public Relations*
VICKI REYNOLDS, *Marketing Associate*
JONI P. VETNE, *Assistant*
STEPHANIE WARNECKY, *Graphic Arts Supervisor*
SHARON PRICE, *Graphic Arts Designer*
MICHELE P. VERVILLE, *Research Manager*
PATRICIA AKERLEY, *Market Research Analyst*
CYNTHIA DAMATO, *Reader Service Coordinator*

.....
ACCOUNTING
DANIEL RODRIGUES, *Business Manager/Controller*
KENNETH A. KING, *Assistant Controller*
MARY E. FLUHR, *Accounting & D/P Manager*
KAREN BURGESS
PATRICIA BURKE
LYDA CLARK
DIANE HENRY
VERN ROCKWELL
LINDA SHORT
JOANN WALTER
VICKI WESTON

.....
TRAFFIC
N. SCOTT GAGNON, *Manager*
ANTHONY BENNETT
BRIAN HIGGINS

.....
RECEPTIONIST
L. RYAN MCCOMBS

.....
PERSONNEL/OFFICE MANAGER
CHERYL A. HURD

.....
Editorial and Business Office: 70 Main Street, Peterborough, New Hampshire 03458 (603) 924-9281
West Coast Offices: McGraw-Hill 425 Battery St. San Francisco, CA 94111. (415) 362-4600
McGraw-Hill 1000 Elwell Court, Palo Alto, CA 94303 (415) 964-0624

Officers of McGraw-Hill Publications Company: President, John G. Wrede; Executive Vice Presidents, Paul F. McPherson, Operations, Walter D. Serwatka, Finance & Services, Senior Vice President-Editorial, Ralph R. Schulz, Senior Vice President-Publishers, Harry L. Brown, David I. McGrath, James R. Pierce, Gene W. Simpson, John E. Slater, Vice President-Publishers, Charlton H. Calhoun III, Richard H. Larsen, John W. Patten, Vice Presidents, Kemp Anderson, Business Systems Development, Shel F. Asen, Manufacturing, John A. Bunyan, Electronic Information Services, George R. Elsinger, Circulation, Michael K. Hehr, Controller, Eric B. Herr, Planning and Development, H. John Sweger, Jr., Marketing, Virginia L. Williamson, Business Development.

Officers of the Corporation: Harold W. McGraw, Jr., Chairman, Joseph L. Dionne, President and Chief Executive Officer, Robert N. Landes, Senior Vice President and Secretary, Ralph J. Webb, Treasurer.

BYTE is published monthly with an additional issue in August and October by McGraw-Hill Inc. Founder James H. McGraw (1860-1948). Executive editorial, circulation, and advertising offices: 70 Main St., Peterborough, NH 03458, phone (603) 924-9281. Office hours: Mon-Thur 8:30 AM - 4:30 PM, Friday 8:30 AM - 1:00 PM, Eastern Time. Address subscriptions to BYTE, Subscriptions, POB 596, Martinsville, NJ 08836. Postmaster: send address changes, USPS Form 3579, undeliverable copies and fulfillment questions to BYTE, Subscriptions, POB 596, Martinsville, NJ 08836. Second-class postage paid at Peterborough, NH 03458 and additional mailing offices. USPS Publication No. 528890 ISSN 0360-5280. Postage paid at Winnipeg, Manitoba. Registration number 9321. Subscriptions are \$21 for one year, \$38 for two years, and \$55 for three years in the USA and its possessions. In Canada and Mexico, \$23 for one year, \$42 for two years, \$61 for three years. \$69 for one year air delivery to Europe, 17 100 yen for one year surface delivery to Japan, \$37 surface delivery elsewhere. Air delivery to selected areas at additional rates upon request. Single copy price is \$3.50 in the USA and its possessions, \$4.25 in Canada and Mexico, \$4.50 in Europe, and \$5 elsewhere. Foreign subscriptions and sales should be remitted in United States funds drawn on a US bank. Please allow six to eight weeks for delivery of first issue. Printed in the United States of America.

Address all editorial correspondence to the Editor, BYTE, POB 372, Hancock, NH 03449. Unacceptable manuscripts will be returned if accompanied by sufficient first-class postage. Not responsible for lost manuscripts or photos. Opinions expressed by the authors are not necessarily those of BYTE.

Copyright © 1984 by McGraw-Hill Inc. All rights reserved. Trademark registered in the United States Patent and Trademark Office. Where necessary permission is granted by the copyright owner for libraries and others registered with the Copyright Clearance Center (CCC) to photocopy any article herein for the flat fee of \$1.50 per copy of the article or any part thereof. Correspondence and payment should be sent directly to the CCC, 29 Congress St., Salem, MA 01970. Specify ISSN 0360-5280/83 \$1.50. Copying done for other than personal or internal reference use without the permission of McGraw-Hill Inc. is prohibited. Request for special permission or bulk orders should be addressed to the publisher, BYTE, is available in microform from University Microfilms International, 300 North Zeeb Rd., Dept. PR, Ann Arbor, MI 48106 or 18 Bedford Row, Dept. PR, London WC1R 4EJ, England.

Subscription questions or problems should be addressed to: BYTE Subscriber Service, POB 328, Hancock, NH 03449.



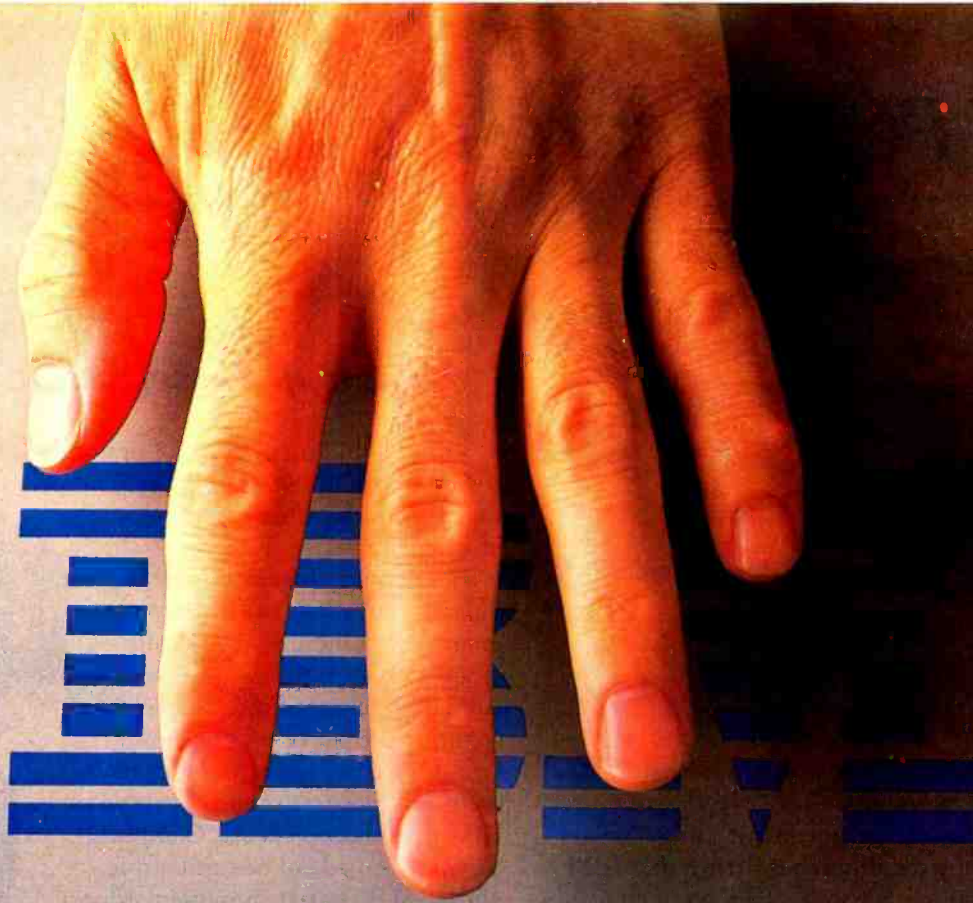

THE NAME TO LOOK FOR WHEN YOU BUY A PERSONAL PRINTER ISN'T IBM®

It's Okidata. Before you buy an IBM printer for your IBM PC, look underneath the initials. It's actually a printer built by another company that just wears the IBM name.

We tell you this because having the right printer is very important. Before you buy you should know what you're getting, and when you buy an Okidata you're getting the best printer there is.

We live, sleep and breathe printers. We specialize in building printers . . . seven different printer models to be exact. So you can fit the printer to the application, not the application to the printer.

We make versatile printers with three print modes; data processing for speed, enhanced for emphasized printing and correspondence for letter quality. (You-know-who only gives you one or two.)

We make fast printers. For example, while an IBM 5152 is plodding along at 80 characters per second, an Okidata

ML 92 is printing the same data twice as fast. Some Okidata models reach speeds up to 350 characters per second . . . an incredible rate that produces five pages in just one minute.

We make printers that match a daisywheel for crisp, clean letter quality, but print much faster than a daisywheel ever could. And Okidata gives you full graphics capabilities for printing all kinds of charts and graphs. You can even print custom typefaces and symbols.

Your IBM's better half. If you're wondering how compatible your Okidata will be with your IBM PC, the answer is "completely," including all popular software packages. And most important, you can buy Okidata printers configured for IBM at no extra cost.

And if you're wondering about service, it's available nationwide through Xerox Service Centers. Of course, chances are you won't need it. Okidata has the best reliability record in the in-

dustry, with a warranty claim rate of less than 1/2 of 1%.

Select, don't settle. Pick your printer for its performance, not its initials. Pick Okidata. Because a printer by any other name just isn't the best printer.

Call 1-800-OKIDATA (609-235-2600 in NJ) for the name of the Authorized Okidata Dealer nearest you. Okidata, Mt. Laurel, NJ 08054.



OKIDATA

an OKI AMERICA company

IBM and the IBM logo are registered trademarks of International Business Machines, Inc.

Fall 1984 • BYTE Guide to the IBM PC • 5

Circle 126 on inquiry card.

IBM PC Software: the value of choosing

Size up the selection.

You'll find many types of programs in the IBM software library. They'll help keep you on your toes in the office, at home or in school.

There are, in fact, seven different categories of IBM programs called "families." A family of software for business, productivity, education, entertainment, lifestyle, communications or programming.

Of course, every program in every family is tested and approved by IBM. And IBM Personal Computer Software is made to be compatible with IBM Personal Computer hardware.

Shoes.

If they don't fit, they're not worth wearing.

Software programs.

If they don't fit, they're not worth using.

That's why it's altogether fitting that IBM Personal Computer Software offers you a choice.

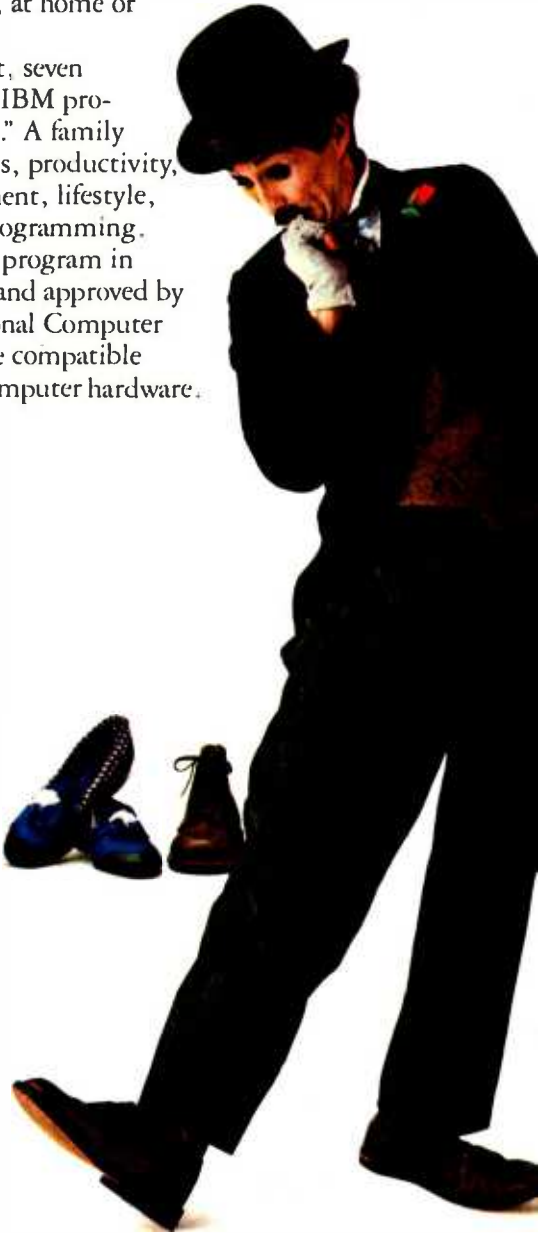

programs that fit.

Putting your best foot forward.

Although every person isn't on equal footing when it comes to using personal computer software, there's something for almost everyone in the IBM software library.

For example, you may be on a shoestring budget and want a big selection of programs with small price tags.

You may be introducing students to computing and want programs that are simple to use and simple to learn.

You may run a business requiring sophisticated inventory and payroll programs. Or you may run a business requiring a single accounting program.

You may write interoffice memos and want a streamlined word processing program. Or you may be a novelist looking for a program with features worth writing home about.

Now you can find IBM Personal Computer Software that fits — to help you accomplish specific tasks and reach individual goals.

Stroll into a store today.

What's the next step?

Visit an authorized IBM Personal Computer dealer or IBM Product Center near you. To find out exactly where, call 800-447-4700. In Alaska or Hawaii, 800-447-0890.

Ask your dealer to demonstrate your choice of programs. Then get comfortable. Sit down at the keyboard and try IBM software on for size.



IBM[®]

Personal Computer Software

Circle 84 on inquiry card.

Little Tramp character licensed by Bubbles Inc., s.a.

How to make your next presentation your best presentation.

Why settle for less than the best when you don't have to? Quadjet, Quadram's ink jet color printer, can give you incredible color graphics that will make you look as good as your next presentation.

An easy match.

Getting started with color graphics is easier than you might think. If you have an IBM PC, XT or Apple Computer, you're already half way there.

Quadjet gets along great with color graphics boards and graphics software packages too, including Lotus 1-2-3. Quadjet even comes with its own standard software that's compatible with the IBM PC.*

Complimentary colors.

Now you can use black, red, green, yellow, cyan, blue or magenta for all your

graphs, charts and diagrams. Print them on *transparencies* as well as paper for individual or group presentations. Take your choice of plain paper or clay coated for the ultimate in quality color printing.

Of course, Quadjet prints text as well as graphics including standard and enlarged characters with true descenders. With a maximum resolution of 640 dots/line, your projects are printed crisply and cleanly everytime.

When you've got Quadjet, it's easy to see that color graphics are clearly better than black and white.

* Software compatible with Apple must be ordered separately.

Quadjet™ by Quadram™

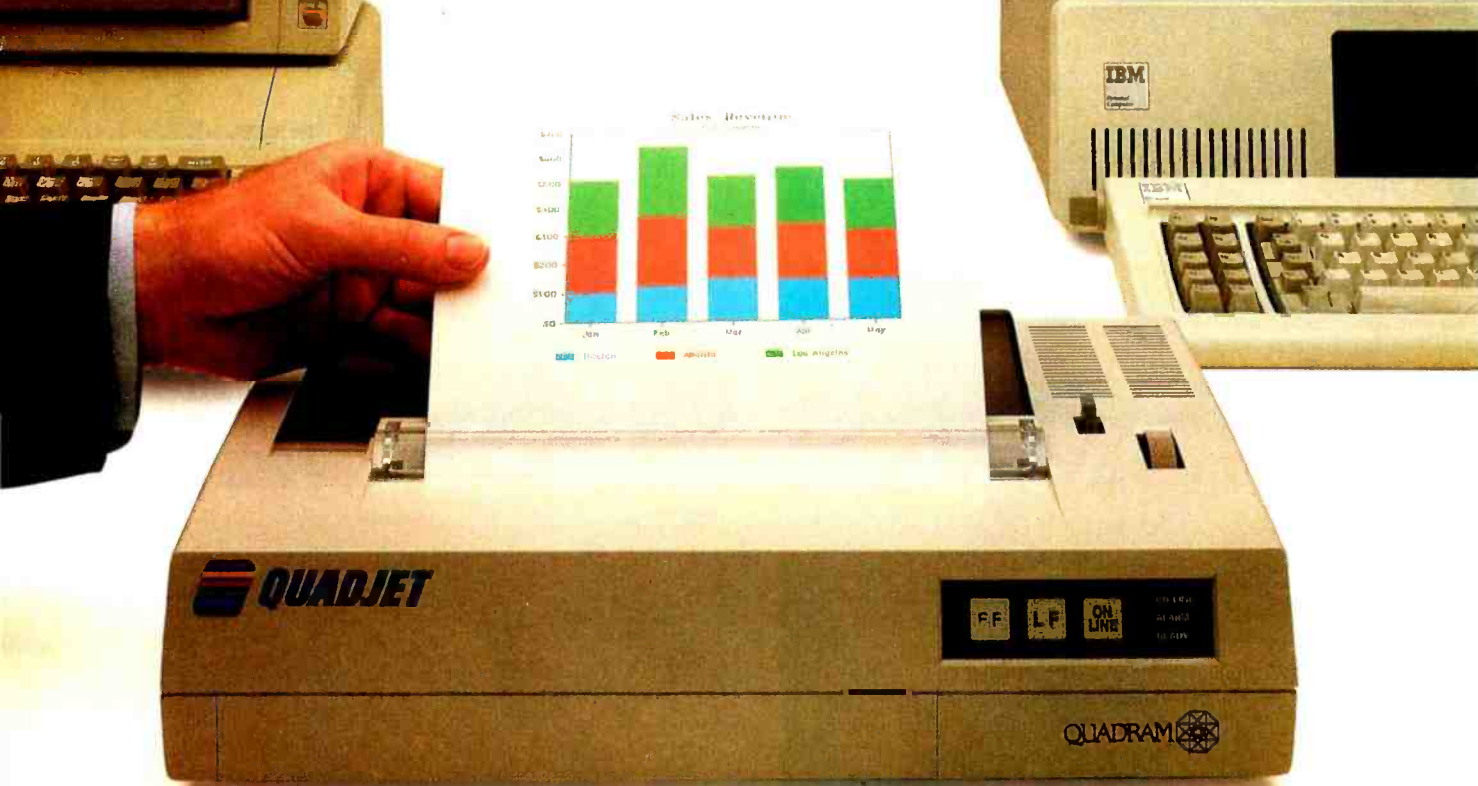
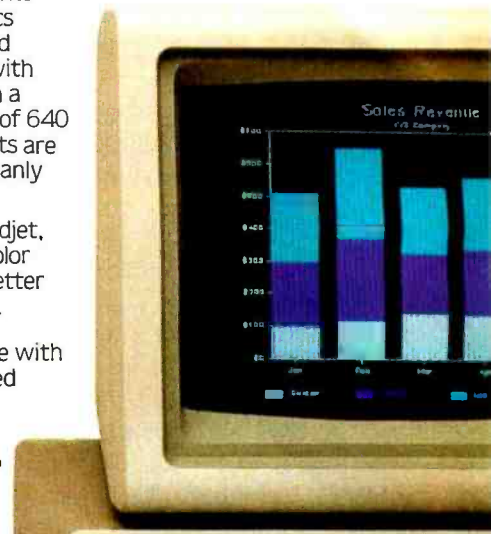
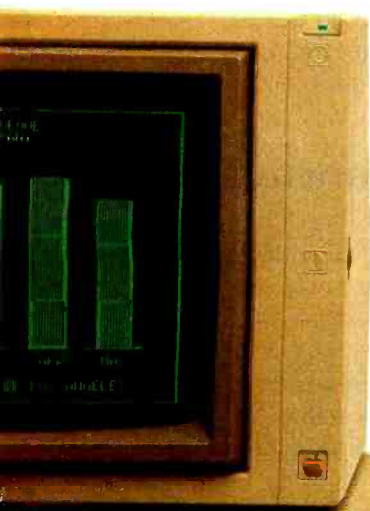

Quadjet output produced using Lotus 1-2-3.



Look for this seal. It's your assurance that you're buying the best in personal computer enhancement devices.



4355 International Blvd./Norcross, Ga. 30093
(404) 923-6666/TWX 810-766-4915 (QUADRAM NCRS)

INTERNATIONAL OFFICES
Interquadram Ltd. 442 Bath Road, Slough, England SL168E
Tel: 6286-63865 Tlx: B47155 Auriema G Interquadram GmbH
Fasanenweg 7, 6092 Keisterbach, West Germany Tel: 6107-3089
Tlx: 417770 Seva G Interquadram s.a.r.l. 41 Rue Yory, 92522 Neuilly
Tel: 756-1240 Tlx: 630842 Iso Bur Checco Computing 6581 Kitimat
Road, Mississauga, Ontario, Canada L5N 2X5 Tel: 416-824-7600

IBM® PC, XT are registered trademarks of International Business Machines Corporation. APPLE® is a registered trademark of Apple Computers, Inc. 1-2-3 and Lotus are trademarks of Lotus Development Corporation. ©Copyright 1984 Quadram Corporation. All rights reserved.

Circle 148 on inquiry card.

www.americanradiohistory.com

INTRODUCTION:

THE ARRAY OF IBM PERSONAL COMPUTERS

MATCHING MACHINES TO COMPUTING REQUIREMENTS	
IBM Personal Computers At a Glance	10
IBM Forecast: Market Dominance	
by Michael Killen	30

ILLUSTRATION BY ROBERT TINNEY



ROBERT
TINNEY

The IBM Personal Computer

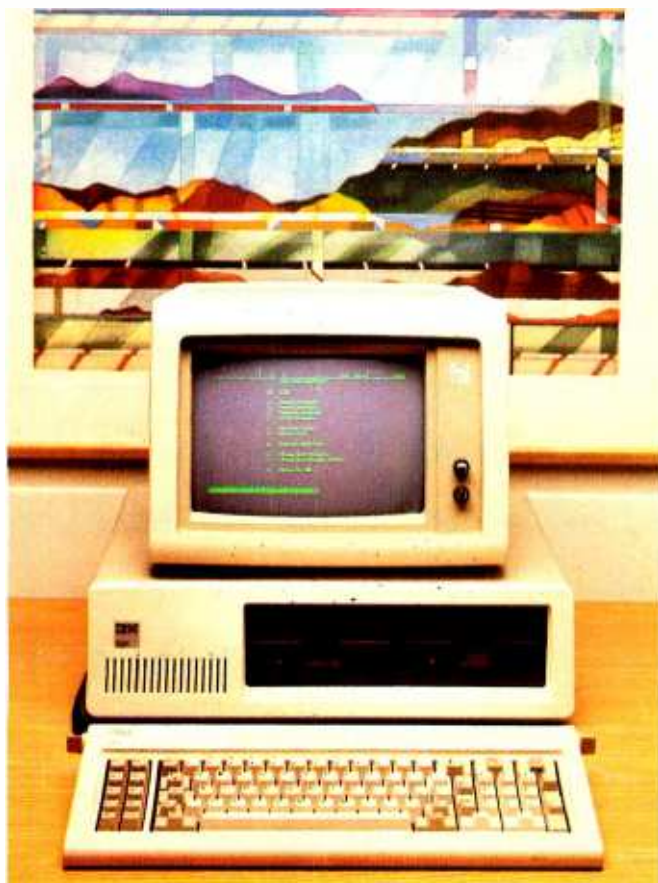

IBM has established itself as the nation's major micro-computer producer in the three years since it introduced the IBM Personal Computer in August, 1981. Drawing on a reputation for service and reliability with its larger computer systems, IBM has been able to quickly woo corporate America and even entice home users.

Catering to over a million IBM PC users, software publishers have created for the computer one of the largest bases of microcomputer programs, thereby contributing further to the PC's proliferation. The 16-/8-bit 8088 processor makes it possible for users to write larger, more complex programs that offer more sophisticated features yet are easier to use than previous 8-bit personal computer applications. The IBM PC's five expansion slots and the wealth of technical information available let numerous third-party vendors manufacture add-on boards that help the PC flex its productive muscle.

IBM has expanded its PC line and recently reduced its prices in an effort to grab an even larger market share by competing more aggressively with the IBM compatibles. An expanded line also means that IBM is competing directly with itself. Many people currently using larger IBM computers, such as the System 34 and the Displaywriter, will find their needs adequately filled by an IBM PC at a lower cost. The IBM PC, one of the company's most successful products, will account for 6 percent of IBM's revenues in 1984.

Name
The IBM Personal Computer

Manufacturer
International Business Machines Corporation
Entry Systems Division
POB 1328
Boca Raton, FL 33432
(800) 447-4700

Size
5½ by 20 by 16 inches; 25 pounds

Components
Processor: Intel 8088, 4.77-MHz; socket for addition of the 8087 math coprocessor
Memory: 40K bytes ROM, 256K bytes RAM standard, 640K bytes RAM maximum with memory-expansion card
Keyboard: 83-key layout with 10 function keys and numeric/cursor keypad; detachable with 6-foot coil cable; adjustable typing angle
Mass Storage: 360K-byte double-sided 5¼-inch floppy-disk drive
Expansion: Five expansion slots (one used by floppy-disk drive controller)

Software
Diagnostics, Microsoft cassette BASIC interpreter in ROM

Optional Hardware	
64/256K-byte Memory Expansion Card with 64K bytes	\$265
64K-byte Memory Module	\$100
Monochrome Display	\$275
Monochrome Display and Printer Adapter	\$250
Color Monitor	\$680
Color/Graphics Monitor Adapter	\$244
Disk drive (5¼-inch floppy disk)	\$425
Asynchronous Communications Adapter	\$100
8087 Math Coprocessor	\$230
Graphics Printer	\$449
Personal Computer Cluster Adapter	\$400
Personal Computer Cluster cable kit	\$110
Fixed Disk Drive Adapter	\$590
10-megabyte Fixed Disk	\$1395
PC Expansion Unit	\$2880

Optional Software	
Personal Computer DOS 1.1 (with Advanced Disk BASIC)	\$40
Personal Computer DOS 2.1	\$65
Personal Computer Cluster Program	\$92

Documentation
Guide to Operations, BASIC Reference Manual

Prices	
256K bytes of RAM and one floppy-disk drive	\$1995
256K bytes of RAM and two floppy-disk drives	\$2420

SEEQUA SHOWS YOU HOW TO GET AN IBM PC FOR JUST \$1995.

BUY A CHAMELEON BY SEEQUA.



The Chameleon by Seequa does everything an IBM PC does. For about \$2000 less than an IBM.

The Chameleon lets you run popular IBM software like Lotus® 1-2-3™ and dBase II.® It has a full 83 key keyboard just like an IBM. A disk drive like the IBM. And a bright 80 × 25 character screen just like an IBM.

But it's not just the Chameleon's similarities to the IBM that should interest you. Its advantages should, too. The Chameleon also has

an 8 bit micro-processor that lets you run any of the thousands of CP/M-80® programs available. It comes complete with two of the best programs around, Perfect Writer™ and Perfect Calc.™ It's portable. And you can plug it in and start computing the moment you unwrap it.

So if you've been interested in an IBM personal computer, now you know where you can get one for \$1995. Wherever they sell Chameleons.

The Chameleon by



SEEQUA
COMPUTER
CORPORATION

8305 Telegraph Road
Odenton, MD 21113

Chameleon shown with optional second disk drive.

To learn more about Seequa or for the location of the Seequa dealer nearest you, call (800) 638-6066 or (301) 672-3600.

IBM is a registered trademark of International Business Machines Corporation.

The IBM Personal Computer XT



Many users soon tire of slow floppy-disk response time, limitations on the size of data files, and the bother of shuffling around their 360K-byte floppy disks and yearn for true "mass" storage. Enter the IBM PC XT, a machine that includes 10 megabytes of storage on a compact hard disk in place of one of the floppy-disk drives. The PC XT can also support a second 10-megabyte drive in a separate expansion unit, making for a fixed disk space of 20 megabytes, or the equivalent of 5000 typewritten pages in a desktop machine.

The PC XT has eight thin expansion slots in place of the PC's five, allowing PC XT users to take advantage of more third-party peripherals without feeling cramped for space. However, three of the expansion slots are already taken by the asynchronous communications adapter and the floppy-disk and hard-disk controllers. The power supply on the XT, however, has been beefed up to handle the extra demands for power, doubling the wattage to 130 watts.

DOS 2.1 offers a hierarchical file system with subdirectories to help organize all the files that will now fit onto the PC XT's hard disk. But the euphoria of a faster disk drive and seemingly limitless disk space eventually gives way to the realization that you can fill up even 10 megabytes sooner than you think.

Name

IBM Personal Computer XT

Manufacturer

International Business Machines Corporation
Entry Systems Division
POB 1328
Boca Raton, FL 33432
(800) 447-4700

Size

5½ by 20 by 16 inches; 32 pounds

Components

Processor: Intel 8088, 4.77-MHz; socket for addition of the 8087 math coprocessor

Memory: 40K bytes ROM, 256K bytes RAM standard, 640K bytes RAM maximum with memory-expansion card

Keyboard: 83-key layout with 10 function keys and numeric/cursor keypad; detachable with 6-foot coil cable; adjustable typing angle

Mass Storage: 10-megabyte fixed disk, 360K-byte double-sided 5¼-inch floppy-disk drive

Expansion: Eight expansion slots (three used by asynchronous communications, floppy-disk drive, and fixed-disk adapters)

Software

Diagnostics, Microsoft cassette BASIC interpreter in ROM

Optional Hardware

64/256K-byte Memory Expansion Card with 64K bytes	\$265
64K-byte Memory Module	\$100
Monochrome Display	\$275
Monochrome Display and Printer Adapter	\$250
Color Display	\$680
Color/Graphics Display Adapter	\$244
8087 Math Coprocessor	\$230
Graphics Printer	\$449
5¼-inch floppy-disk drive	\$425
Personal Computer Cluster Adapter	\$400
Personal Computer Cluster cable kit	\$110
10-megabyte fixed disk	\$1395
PC XT Expansion Unit	\$2290

Optional Software

Personal Computer DOS 2.1 (with Advanced Disk BASIC)	\$65
Personal Computer Cluster Program	\$92

Documentation

Guide to Operations, BASIC Reference Manual

Price

\$4395

A printer should complement your computer, not compromise it.



It's a simple fact that your small computer can compute a lot faster than your printer can print. A problem that becomes even more frustrating in business, when your computer is tied up with your printer while you're ready to move on to other work.

Of course, the only thing more frustrating than waiting on a slow printer is waiting on a printer that's down. Unfortunately, chances are the initial printer you purchased with your computer system just isn't designed to work on continuous cycle high volume printing.

More than likely, you've already experienced one, if not both of these frustrations. But now, you can turn printer frustration into printing satisfaction with the new Genicom 3014, 3024, 3184, 3304 or 3404. Professional printers for personal computers...price/performance matched for small business systems.

Designed and built to increase productivity and maximize the value of your personal computer, the range of 3000 PC printers offers 160-400 cps draft, 80-200 cps memo, and 32-100 cps NLQ printing...performance for both high productivity and high quality printing.

The 3014/3024 models print 132 columns. The 3184, 3304

and 3404 models give you a full 136 column width, and offer color printing as well.

Each printer is easy to use, lightweight, functionally styled and attractive. And you can choose options from pedestals and paper racks to document inserters, sheet feeders and 8K character buffer expansion, plus more.

Genicom 3000 PC printers feature switch selectable hardware, dual connectors and dual parallel or serial interfaces. Plus the 3014 and 3024 emulate popular protocols for both Epson MX with GRAFTRAX-PLUS™ and Okidata Microline 84 Step 2™, while the 3184, 3304 and 3404 emulate popular protocols for Epson MX with GRAFTRAX-PLUS™. So your current system is most likely already capable of working with these Genicom printers without modification.

Most important, the Genicom 3000 PC printers are quality-built, highly durable printers designed for rapid, continuous duty cycle printing.

So why wait? And wait. And wait. Get a Genicom 3000 PC printer now.

Genicom Corporation, One General Electric Drive, Dept. C411, Waynesboro, VA 22980. In Virginia, call 1-703-949-1170.

GENICOM

The New Printer Company.

For the solution to your printing needs call

TOLL FREE 1-800-437-7468

In Virginia, call 1-703-949-1170.

Epson MX with GRAFTRAX-PLUS is a trademark of Epson America, Inc.
Okidata Microline 84 Step 2 is a trademark of Okidata Corporation

The IBM PCjr



While the IBM Personal Computer exceeded IBM's initial sales projections as a business computer, it has had mixed success as a home computer, primarily because it costs more than several of the lower-priced home computers. The IBM PCjr, a scaled-down, limited version of the IBM PC for the home market, starts at \$599 for 64K bytes of memory and no disk drive. Most users will want the expanded model, which has a disk drive and 128K bytes of memory and sells for \$999.

Both models are designed to compete directly with the Apple II family of machines, but the PCjr's shortcomings have cooled its reception. The complaints against the PCjr start with its "chiclet" style keyboard, whose flat, rectangular keys are not labeled and are spaced far apart (this was to allow for keyboard overlays that would redefine the keys). Another major drawback is that many regular IBM PC programs won't run on the PCjr because it has a limit of 128K bytes of memory. In addition, you can add only one disk drive to the PCjr. Further, its innovative cordless keyboard, which uses an infrared link to communicate with the expansion unit, has received mixed reviews.

Name
IBM PCjr

Manufacturer
International Business Machines Corporation
Entry Systems Division
POB 1328
Boca Raton, FL 33432
(800) 447-4700

Size
4 by 14 by 11½ inches; 6 pounds, 9 pounds with disk drive

Components
Processor: Intel 8088, 4.77-MHz
Memory: 64K bytes ROM, 64K bytes RAM standard, 128K bytes RAM maximum
Display: Built-in color adapter
Keyboard: 62-key layout with function control and cursor control keys; detached with infrared link; adjustable typing angle
Expansion: two cartridge slots

Software
Diagnostics, Microsoft cassette BASIC interpreter in ROM

Optional Hardware

Disk drive (360K-byte half-height 5¼-inch floppy disk)	\$480
64K-byte Memory and Display Expansion	\$140
Internal Modem	\$199
Adapter Cable for Serial Devices	\$25
Attachable Joystick	\$40
Keyboard Cord (6-foot)	\$20
Keyboard Overlays (5)	\$10
Television Connector	\$30
Color Display	\$680
Adapter Cable for IBM Color Display	\$20
Compact Printer (thermal)	\$175
Compact Printer Adapter	\$40
Graphics Printer	\$449
Parallel Printer Attachment	\$99
Color Printer	\$1995
Personal Computer Cluster Adapter	\$400
Personal Computer Cluster Cable kit	\$110

Optional Software

BASIC Interpreter Cartridge (Microsoft)	\$75
Personal Computer DOS 2.1 (with Advanced Disk BASIC)	\$65
Personal Computer Cluster Program	\$92

Documentation

Guide to Operations, Hands-On BASIC for the IBM PCjr

Price

64K-byte Entry Model	\$599
128K-byte Extended Model with one floppy-disk drive	\$999



MEET OUR DIRECTOR OF PUBLIC RELATIONS.

Quite a few important people are saying some very good things about our Serial Port Expanders. They're saying things any company would like to hear. Things like "reliable," "sophisticated," and "affordable."

They're talking about the wide range of applications — port contention, multiplexing, time-sharing and networking. They can't seem to tell us enough how pleased they are with our units. But they're trying . . .

"BayTech's Serial Port Expanders were a key solution for Federal Express employees using PCs and peripheral devices. There just weren't enough I/O ports. We needed to talk to more devices. BayTech's units filled that gap. I looked for price and capabilities. With BayTech's Expanders, everything was just right."

*Sam Ho, Technical Advisor,
Federal Express*



We manufacture Serial Port Expanders in four, eight and sixteen port units. We manufacture a model that allows other units to be cascaded for those needing increased expansion.

Seventeen models are available providing a comprehensive range of applications. Many companies are using our units in different divisions,

different locations.

And everyone seems pleased . . .

NCR

"Three of BayTech's 524Fs (any-port-to-any-port model) are used as smart switches between NCR's personal computer, the



Decision Mate 5, and three other processors — NCR's 3240s — which in turn drive twenty-six, 2160 terminals. These cash registers are used at the front gates of Opryland and, on demand, pull totals of gate receipts, number of tickets sold, attendance — even the weather! We are happy with BayTech's units."

*Dave Armelli, Administrative
Manager, NCR*

"I looked for a box that could be used to interface different types of terminals and peripherals with the box being able to do the dirty work. I researched five or six companies. BayTech's units — considering sophistication and price — were the best."

*Tom Redd, Product Manager -
Engineering & Manufacturing, NCR*

Everyone . . .

"We use the (BayTech) Multiports with our IBM PCs to expand communications. They're used to control

production devices on assembly lines. They work fine for us."
*Red Karshick, Automation
Engineer/Logic Process
Development, IBM*

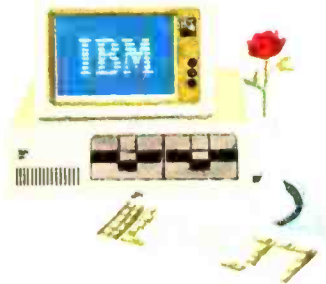

BayTech's Port Expanders allow peripheral devices of different configurations to be mixed-and-matched without reconfiguring the host device. Configuration of the peripheral device ports may be changed by menu-driven software. Many other user-friendly features are standard on BayTech's units.

BayTech



Call us on our toll-free line and tell us your needs. We'll help you choose a Multiport to handle your application. And if you require modifications, don't worry. Not only are we "reliable," "sophisticated" and "affordable," we're also understanding.

1-800-523-2702



BayTech is a registered trademark of Bay Technical Associates Corporation. NCR is a registered trademark of National Cash Register Corporation. Federal Express is a registered trademark of Federal Express Corporation. IBM is a registered trademark of International Business Machines Corporation.

"Excuse Me,



Make Way For Hayes' Please.

An advanced, easy-to-use data management system for the IBM® PC and compatibles.

Want to get your paperwork out of a clumsy file cabinet and onto your PC's screen, where you can manage it better? Frustrated with data base software that's either too limited or too difficult to use? Hayes offers you a simple word of kindness.

Please.™ A powerful, yet easy-to-use, system for organizing and managing your information. *Please* is flexible enough to store any data you enter, and it'll return data to you in exactly the form you need. *Please* does more.

It does it all faster. And it's sure to please!

"The menu, Please?"

Menus list all your options and tell you exactly which keys to press for every *Please* feature.

That's to be expected. As the telecomputing leader, Hayes built its reputation on quality design, rela-

bility and customer support. Now these same standards have been applied to a new data management system that is going to instantly change the way you do business!

Say you're looking for an efficient way to maintain sales data. *Please* leads you every step of the way in creating a sales database that might include names, addresses, dates and figures. These categories are called "fields" in database lingo, and they're the very heart of your database structure.

Want last month's total in a particular region? Press a few keys and it's yours! A few more keystrokes and you'll know who's moving product, and what's your biggest seller.

Please will supply you with labels for a mailing to selected customers. It can send customer information to your word processor for a promotional letter. And it can receive data from

your spreadsheet program. *Please* will even look up a name and company for you, your Hayes Smartmodem* will dial the phone number, and you're ready to talk!

Taking this same sales database, you might also want to define special

fields for a custom Output Plan.

With a defined field for "COMMISSIONS DUE,"

Please can automa-

tically compute each salesman's commissions, and print them out in a report of your own design. All this and more, just for saying "Please."

And if you ever change your mind and want to change the structure of your database, please feel free. Step-by-step instructions show you how.

You have the same flexibility with any database you and *Please* design. You can store up to 16 million records and 200 custom Output Plans for each database! More than you're likely ever to require. But isn't it nice

"Make it snappy, Please!"

Need a report fast? You and *Please* can put together a Quick List in a matter of seconds.

Please!

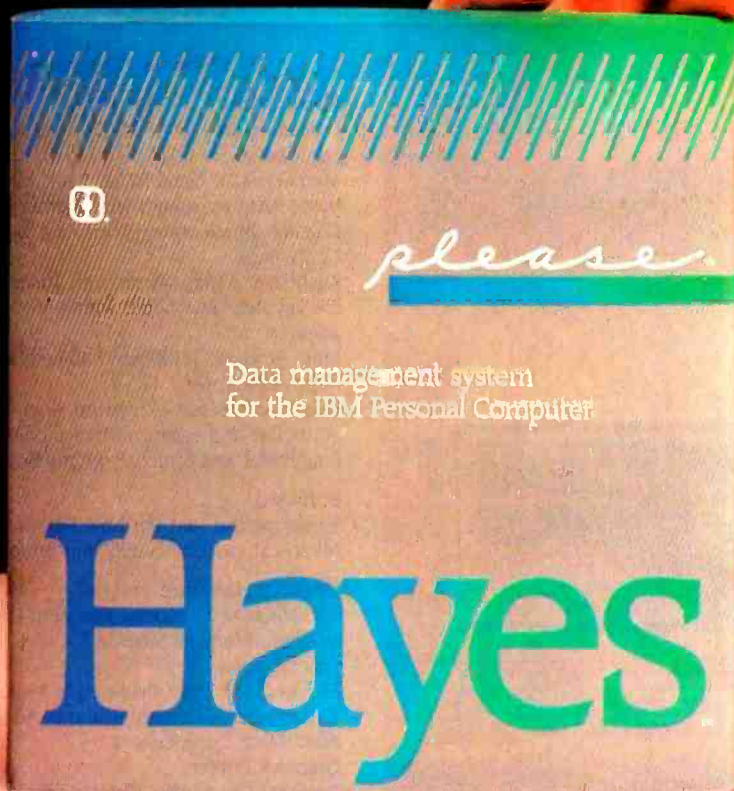

"Put it here, Please!"

Design a special screen format to position data in a particular place.

Just in case you ever need it?

Now you might think that a data management system that does all this must be difficult to use. Right? Rest assured. *Please* works hard so you don't have to. An easy-to-follow sample disk shows you everything you need to know to create your first database. Three *Please* menus show you which keys to press to access every feature. And whenever you need it, *Please* provides on-screen HELP messages, tailored to a specific task. So you needn't waste time reading through a list of unrelated instructions on your screen. Or stop what you're doing to consult a manual. In no time at all, and with no assistance at all, you'll be a *Please* database pro!

knowing all that storage power is there?

"Merge these, Please!"

Combine data from one database into another, without changing your original.

Everything about *Please* is designed to save you time and effort. So what could make data management even easier? *Please Application Templates*, that's what!

To help you get up-and-running immediately, we've developed a series of practical, pre-designed templates. You'll appreciate their well-thought-out structure, and "fill-in-the-blank" ease. Choose several! For business and personal use.

Including *Mailing List*, for storing names and addresses and producing mailing lists. *Contacts*, for man-

aging facts and figures about your sales contacts. *Applicants*, for following applicants throughout the interviewing process. *Appointments*, for maintaining your calendar and tracking all of your business expenses. *Household Records*, a complete home management system. And more! Your dealer has details!

Buy *Please* now! Get a **FREE Mailing List** template from your dealer.

Second **FREE** template of your choice, direct from Hayes!

Help yourself. *Please!* And take advantage of these two valuable offers. See your dealer right away!



Hayes

Hayes Microcomputer Products, Inc.,
5923 Peachtree Industrial Blvd.,
Norcross, Georgia 30092. 404/441-1617.

Circle 74 on Inquiry card.

The IBM Portable Personal Computer



Transportable IBM PC-compatible computers have been around for some time and have taken a slice out of IBM's market, so it was inevitable that IBM would develop a transportable PC. The IBM Portable Personal Computer features a 9-inch amber monitor, a color/graphics monitor adapter, a 360K-byte half-height 5¼-inch floppy-disk drive, seven expansion slots (of which two are already used), 256K bytes of memory, a 130-watt universal power supply for use here or abroad, and a carrying bag for the system unit. It's a fairly complete, self-contained system except for the lack of parallel and serial ports for attaching a printer and modem. These can be added via the expansion slots, but then you have only one full-length slot available. The other four slots will take only half-length cards, of which there are not that many.

The amber monitor with the color/graphics monitor adapter is the only display option unless you connect an external color monitor, because the monochrome display and adapter are not available for the Portable PC. The characters produced by the color/graphics adapter are not as clear as those created by the monochrome adapter, and certain color combinations will produce unreadable text.

Because it uses an IBM PC XT system board, the IBM Portable PC offers the utmost in IBM PC compatibility. The system is well-designed, although it's heavy at 30 pounds.

Name

IBM Portable Personal Computer

Manufacturer

International Business Machines Corporation
Entry Systems Division
POB 1328
Boca Raton, FL 33432
(800) 447-4700

Size

8 by 20 by 17 inches; 30 pounds

Components

Processor: Intel 8088, 4.77-MHz; socket for addition of the 8087 coprocessor

Memory: 40K bytes ROM, 256K bytes RAM standard, 640K bytes RAM maximum with memory-expansion card

Display: 9-inch amber phosphor, built-in monitor; 80 characters by 25 lines

Keyboard: 83-key layout with 10 function keys and numeric/cursor keypad; detachable with 4-foot coil cable; adjustable typing angle

Mass Storage: 360K-byte half-height double-sided 5¼-inch floppy-disk drive

Expansion: Seven expansion slots (two used by floppy-disk drive controller and color/graphics monitor adapter), leaving one full-length slot and four half-length slots

Software

Exploring the IBM Portable Personal Computer. Diagnostics, Microsoft cassette BASIC interpreter in ROM

Optional Hardware

64/256K-byte Memory Expansion Card with 64K bytes	\$265
64K-byte Memory Module	\$100
Color Display	\$680
Slimline Disk drive (half-height 5¼-inch floppy)	\$425
Asynchronous Communications Adapter	\$100
8087 Math Coprocessor	\$230
Graphics Printer	\$449
Personal Computer Cluster Adapter	\$400
Personal Computer Cluster cable kit	\$110

Optional Software

Personal Computer DOS 2.1	\$65
Personal Computer Cluster Program	\$92

Documentation

Guide to Operations. BASIC Reference Manual

Prices

256K bytes RAM and one half-height floppy-disk drive	\$2595
256K bytes RAM and two half-height floppy-disk drives	\$3020

Circuit-Board-Design Without the Tedium

smARTWORK™ lets the design engineer create and revise printed-circuit-board artwork on the IBM Personal Computer.

Forget tape. Forget ruling. Forget waiting for a technician, draftsman, or the CAD department to get to your project. smARTWORK™ software turns your IBM Personal Computer into a professional, high-quality drafting tool. It gives you complete control over your circuit-board artwork — from start to finish.



smARTWORK™ transforms your IBM PC into a CAD system for printed-circuit-board artwork. Display modes include both single-layer black and white and dual-layer color.

What makes smARTWORK™ so smart is that it understands electrical connections. Conductor spacing is always correct, lines don't become too narrow, and connecting lines do not intersect other conductors. smARTWORK™ can automatically find and draw the shortest route between two conductors. Or you can specify the route.

smARTWORK™ is the only low-cost printed-circuit-board artwork editor with all these important advantages:

- Complete interactive control over placement and routing
- Quick correction and revision
- Production-quality 2X artwork from pen-and-ink plotter
- Prototype-quality 2X artwork from dot-matrix printer
- Easy to learn and operate, yet capable of sophisticated layouts
- Single-sided and double-sided printed-circuit boards up to 10 x 16 inches
- Multicolor or black-and-white display
- 32 user selectable color combinations; coincident points can be displayed in contrasting colors.
- Can use optional Microsoft Mouse as pointing device



Twice scale hardcopy of your artwork is produced using the Epson dot-matrix printers or the Houston Instrument DMP-41 pen-and-ink plotter. Quick 1X check plot is also available from Epson printers.

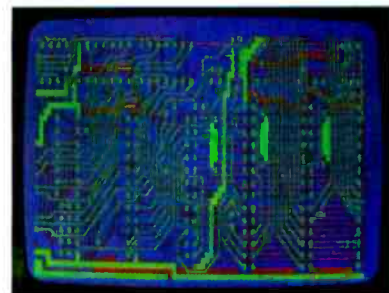

Dual-layer color display of a 2" by 4" section of a 10" by 16" circuit board

The Smart Buy

At \$895, smARTWORK™ is an exceptional value, particularly when compared to conventional engineering workstation costs.

Call or write us for more information on smARTWORK™. We'll be glad to tell you how smARTWORK™ helps us design our own circuit boards and what it can do for your business.

Send a purchase order, or major credit card number, and smARTWORK™ can be working for you next week.

System Requirements

- IBM PC or XT with 192K RAM, 2 disk drives and DOS Version 2.0
- IBM Color/Graphics Adapter with RGB color or b&w monitor
- Epson MX-80/MX-100 or FX-80/FX-100 dot-matrix printer
- Houston Instrument DMP-41 pen-and-ink plotter (optional)
- Microsoft Mouse (optional)



"smARTWORK" and "Wintek" are trademarks of Wintek Corporation.

WINTEK CORPORATION, 1801 South St., Lafayette, IN 47904-2993, Phone: (317) 742-8428, Telex: 70-9079 (WINTEK CORP UD)

IBM Personal Computer XT/370



The IBM PC XT/370 is actually three systems in one—a workstation for a System/370 mainframe, a 3270-type terminal, and a stand-alone IBM PC XT. When you start the Virtual Machine/Personal Computer (VM/PC) program on the XT/370, you can run most Conversational Monitor System (CMS) programs from a System/370 that will fit into the XT's 4-megabyte virtual-memory space. Uploading and downloading files is supported, as is emulation of a 3277 display terminal. Both these modes require a 3274 control unit connected to the coaxial cable to the mainframe. VM/PC files are stored in the CMS format on disk, but these can be converted from and to PC-DOS format with the CMS Import and Export commands. Most IBM PC hardware options will work with the XT/370 running under VM/PC, and if not (as in the case of the 8087 math coprocessor and the communications adapters), you can use them in the PC mode when not running VM/PC. Switching the XT/370 between these three modes usually requires only two keystrokes.

The XT/370 is made from a standard IBM PC XT with three additional cards. The first card contains three separate processors that execute most System/370 instructions. Two Motorola 68000 microprocessor chips, one standard and the other a custom IBM chip based on the 68000, execute most System/370 fixed-point and non-floating-point instructions. The third microprocessor, a modified Intel 8087, executes System/370 floating-point instructions and contains the floating-point registers.

A second card has 512K bytes for memory expansion, giving you the maximum 640K bytes of usable memory for the PC mode and 480K bytes for System/370 storage in VM/PC mode.

Name

IBM Personal Computer XT/370

Manufacturer

International Business Machines Corporation
Information System Group
900 King Street
Rye Brook, NY 10573

Size

5½ by 20 by 16 inches

Components

Processors: Intel 8088, Motorola MC 68000. Custom IBM/Motorola MC 68000. Custom Intel 8087

Memory: 40K bytes ROM. 768K bytes RAM standard: 640K bytes are addressable in the PC mode. 480K bytes in System/370 mode

Display: 3277 Model 2 emulation card standard

Keyboard: 83-key layout with 10 function keys and numeric/cursor keypad: detachable with 6-foot coil cable: adjustable typing angle

Mass Storage: 360K-byte double-sided 5¼-inch floppy-disk drive and 10-megabyte fixed-disk drive

Expansion: Eight expansion slots, six full-length and two half-length: five slots are already used

Software

Diagnostics. Microsoft cassette BASIC interpreter in ROM

Optional Hardware

Monochrome Display	\$275
Monochrome Display and Printer Adapter	\$250
Color Display	\$680
Color/Graphics Monitor Adapter	\$244
Disk drive (5¼-inch floppy disk)	\$425
Asynchronous Communications Adapter	\$100
8087 Math Coprocessor	\$230
Graphics Printer	\$449
XT/370 Expansion Unit	NA
XT/370 Option Kit for IBM PC XT	NA

Optional Software

Personal Computer DOS 2.1 (with Advanced Disk BASIC)	\$65
Virtual Machine/Personal Computer Program	\$1000

Documentation

Guide to Operations PC XT. Guide to Operations PC XT/370. BASIC Reference Manual

Prices

XT/370 Model 568 with one floppy-disk drive (requires XT/370 Expansion Unit)	\$6230
XT/370 Model 588 with one floppy-disk drive and one fixed-disk drive	\$8085

A NEW WORLD OF SIGNAL PROCESSING FOR THE IBM® PC.

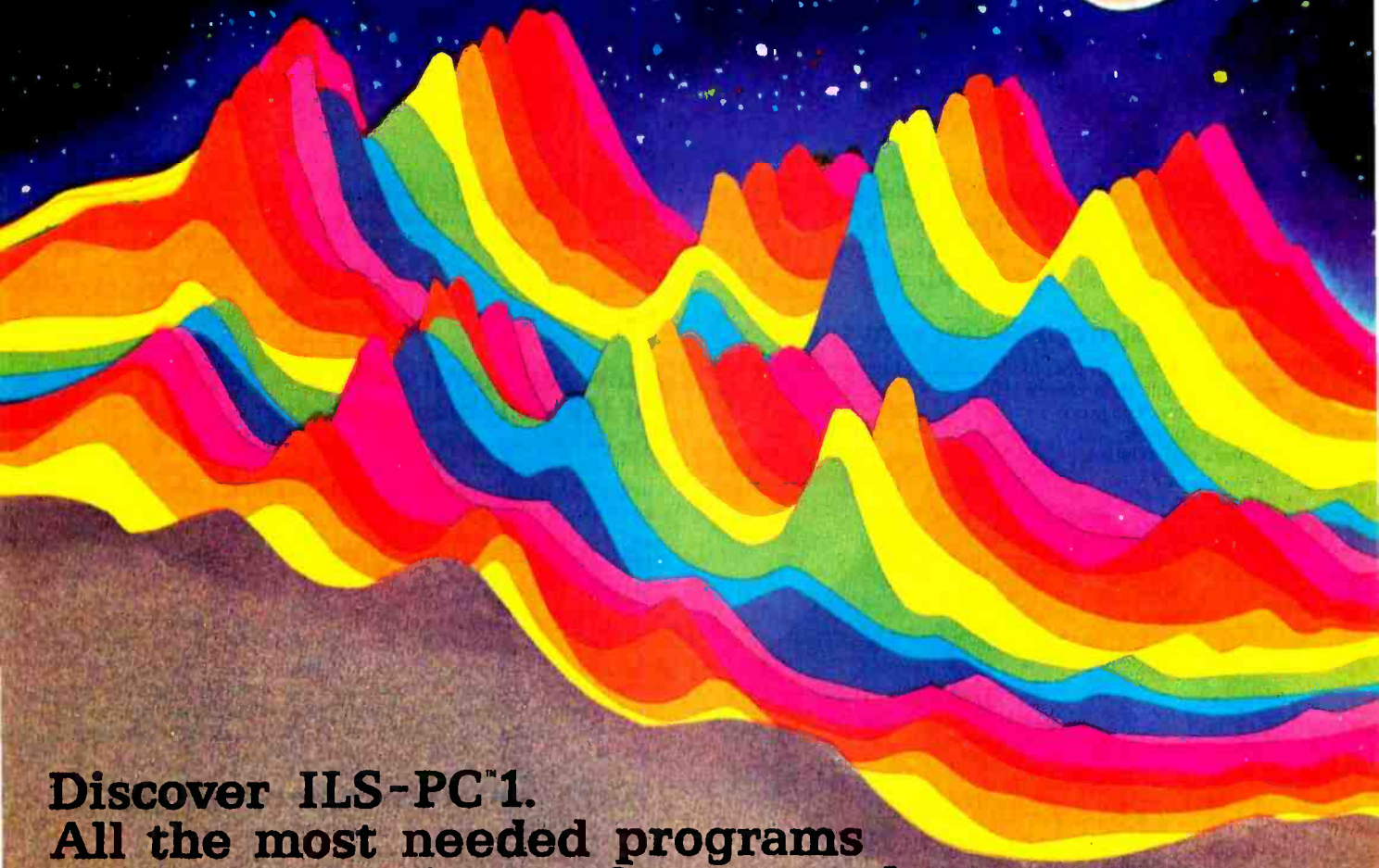

Discover ILS-PC™1. All the most needed programs in one convenient software package.

It's here. True signal processing on the IBM PC. It's called ILS-PC 1, and was developed from our mini-computer ILS, the world standard in signal processing software.

ILS-PC 1 enables you to do signal processing *now* on your own IBM PC or XT. Without writing programs. Without a lot of time or effort. When used with the 8087 coprocessor, it

performs at minicomputer speed.

ILS-PC 1 provides all the essentials: data acquisition support; waveform display and editing; digital filtering; spectral analysis. Applications include noise and vibration, speech, seismology, acoustics, sonar, radar, bio-medicine and many other fields.

Part of ILS-PC 1 convenience is a menu-prompt you can use while

learning, then bypass once you're ready for command control. With our customer service phone line, you get answers to software or applications questions.

Bring signal processing to your own IBM PC or XT. Call our toll-free number now for full information on ILS-PC 1. The price is \$1495. The benefit is a new world of convenience.

 **Signal Technology Inc**

5951 Encina Road • Goleta, CA 93117

In California, (805) 683-3771 TWX 910-334-3471

Call toll-free (800) 235-5787

Germany • TC&E GmbH, Tel. 8139/6067, Telex: 841 527523 / Sweden • 3K Te Konsult AB, Tel: 0764/30175, Telex: 854 15559 / Switzerland • Zentrana Technik AG, Tel. 032 233553, Telex: 845 349353 / U.K. • Logica, Tel. 01637 91111, Telex: 851 27200 / Japan • Rikel Corp., Tel. 03-346-1411, Telex 781 123772 / Korea • Greenell System Industry Co., Tel. 725 6281 2, Telex 787 23231 / Taiwan • Hermes Epitak, Corp. Tel: 02 562 5851, Telex 785 26794 IBM PC and PC/XT are registered trademarks of International Business Machines

How HP business graphics

Enhance your reputation for being more professional, persuasive, credible and effective than your competition with the new HP 7475A Business Professional's Plotter.

Make a first impression that lasts

The vital importance of graphics to today's business professional cannot be overstated. In survey after survey, statistics prove graphics can help you spot trends and relationships quickly, analyze data accurately, and communicate your ideas with more

clarity and power than in any other way.

Even more important, graphics can actually increase personal and company productivity. And create a first impression of quality and professionalism that lasts and lasts.

Graphics: the end to meetings that go nowhere

In a fascinating research project conducted by The University of Pennsylvania, 123 MBA candidates were involved in a study designed to test the effectiveness of business graphics in meeting situations. The results were startling. In the group where visual aids were used:

- **Meetings were shorter:** The study showed a 28% reduction in meeting length when transparencies were used.
- **Group consensus was faster:** Agreement was reached by 79% of the group using transparencies, compared with only 8% among the control group using no visual aids.
- **The decision process was accelerated:** 64% of study participants said they made their business decisions *immediately after the visual presentation*. When overheads were not used, the control group said they delayed decision-making until *some time after the group*

discussion following the presentation.

- Presenters with visual aids were perceived as being more professional, persuasive, credible and effective than those not using visual aids.

Now, with the new HP 7475A Business Professional's Plotter, your meetings can have immediate and productive results like these.

How the quality look of HP graphics can help

The way you present your information can be equally as important as the actual information you're presenting. And that's where the new HP 7475A Business Professional's Plotter lets your professionalism shine through.

Standards unsurpassed in the plotter business

The technical standards of the HP 7475A have no equal for producing quality graphics. With a resolution of one-thousandth-of-an-inch, curved lines are smooth, not jagged, and straight lines are *consistently* straight. Its exceptional repeatability (the ability of a pen to return *precisely* to a given point) assures that intersecting lines and circular shapes will meet *exactly*. The result is *high-quality* charts and graphs you'll be proud to present.

Why 6 pens when experts say 4 will do?

Graphics industry experts maintain that good graphics contain four colors per chart. But Hewlett-Packard goes the experts two better by providing a six-pen carousel, so you can store and use pens of different widths—thick pens for bold headings and thin pens for details. And with six pens, you won't have to waste valuable time changing them. That's important when "the boss wants to see your presentation in twenty minutes!"

With the HP 7475A, you also get automatic pen capping to prevent pens from drying out between uses, and special "pen damping" (gently lowering the pen to the paper or transparency) to increase pen life and ensure better line quality... use after use after use. You also get a rainbow of 10 colors to choose from, in two line widths.

Your choice: 2 paper sizes and today's most popular graphics software packages

While most professional business applications will be satisfied with standard 8½ x 11" paper or transparencies, the HP 7475A adds the

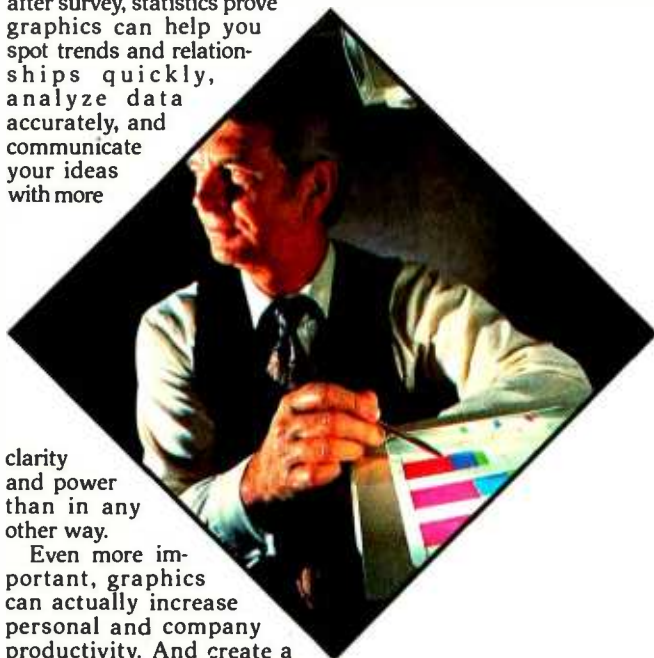

can be the key to your success.



capability of plotting on larger 11 x 17" media, too. The larger plots are especially well-suited for time lines, PERT charts, schematics and engineering drawings.

Best of all, you don't have to be a programmer to produce quality graphics on the HP 7475A. It's supported by a variety of professional graphics software packages for both HP and non-HP desktop and personal computers.

Naturally, speaking of software compatibility leads us to hardware compatibility...

Compatible with almost any personal computer in the marketplace today

With two interfaces available, the HP 7475A quickly "makes friends" with most models of today's most popular personal computers, including IBM®, Apple™, Compaq™, Osborne® and Commodore™ -- as well as a host of HP computers.

The cost? Surprisingly affordable

The new HP 7475A Business Professional's Plotter is an amazingly affordable \$1895. When you consider that a typical fee for a single five-color transparency from a graphics service is \$50—and that the same transparency can be prepared for about \$1 in materials on the HP 7475A—the return on your investment is almost immediate.

Another choice: HP's low-cost, high performance Personal Computer Plotter

For the "business on a budget," you may also want a look at our 2-pen Personal Computer Plotter, the 7470A. Its low cost (only \$1095) is as remarkable as the quality of its plots. With many of the same features as the new HP 7475A, the HP 7470A plots on a single paper size (8½ x 11"). It stores and caps two pens,

and you can easily change the pens yourself for multi-color plotting. Best of all, the HP 7470A 2-pen plotter lets you turn your personal computer into a personal graphics workstation for only \$1095.

Send for your FREE "Better Presentations Package" today!

For a FREE sample plot, overhead transparency, and more details, mail the coupon below today. We'll also enclose a list of software packages you can use with the HP 7475A or HP 7470A.

For the name of your nearest Hewlett-Packard dealer call toll-free 800-547-3400.

1101303



YES! I'm ready to gain a reputation for being more professional, persuasive, credible and effective than my competition. Please send me your FREE "Better Presentations Package," so I can learn more about the new HP 7475A Business Professional's Plotter and the HP 7470A Personal Computer Plotter. I understand I will receive this valuable package without cost or obligation.

Name _____ Title _____

Company _____

Address _____

City/State & Zip _____

Phone Number (____) _____

My computer is _____

Send to: Hewlett-Packard
16399 W. Bernardo Drive, San Diego, CA 92127
Attn: Marketing Communications 11303 BT-IBM GUIDE

The IBM 3270 Personal Computer



The IBM 3270 Personal Computer, another in the "workstation" family of PCs, lets you communicate with host computers such as IBM 43XX or 308X series processors, or to work locally in a personal computing session. The 3270 PC can display information in up to seven user-definable windows, including four host windows, one PC-DOS window, and two electronic notepads, all on a high-resolution color display. You need a 3274 control unit to run more than one host computer session at a time, multiplexing four cables to one or more remote mainframes into a single connection to the 3270 PC. Windows can be moved and adjusted easily; a single keystroke takes you from personal computing to host sessions. You can store the layout of windows on the screen in a "profile" and call it up with a few keystrokes. An autokey function can record a sequence of keystrokes, simplifying logging onto multiple sessions.

The 3270 is available in several configurations with different displays, amounts of memory, and mass storage. Most people will choose the inexpensive 5272 color display or 5151 monochrome display. Sophisticated graphics are available with the 3270 PC/G and GX systems and their larger, very high-resolution color displays with up to 960 by 1000 pixels and 16-color resolution.

Name

IBM 3270 Personal Computer

Manufacturer

International Business Machines Corporation
Information Systems Group
900 King Street
Rye Brook, NY 10573

Size

5½ by 20 by 16 inches; 33 pounds

Components

Processor: Intel 8088

Memory: 40K bytes ROM, 256K bytes RAM standard, 640K bytes RAM maximum with memory-expansion card

Keyboard: 122-key layout including function keys for both 3270 and PC functions and a numeric/cursor keypad; detachable with 6-foot coil cable; adjustable typing angle

Mass Storage: 360K-byte double-sided 5¼-inch floppy-disk drive

Expansion: Eight expansion slots (several already used by various adapters)

IBM 3270 PC

5271 Model 2: System Unit with 256K-byte memory, one floppy-disk drive and adapter, 5151/5272 display adapter, 3270 PC keyboard/timer adapter, 3270 system adapter

\$3785

5271 Model 4: Model 2 features plus second floppy-disk drive, 64/256K-byte memory-expansion option with 64K bytes, parallel printer adapter

\$4650

5271 Model 6: Model 2 features plus one 10-megabyte fixed-disk drive and adapter, 64/256K-byte memory-expansion option with 64K bytes, parallel printer adapter

\$6210

5272 Color Display (14-inch, eight-color, 720 by 350 pixels)

\$995

All-Points-Addressable Graphics Adapter

\$550

Host Graphics Adapter

\$800

3270 PC Control Program

\$300

3270 PC File Transfer Program

\$600

IBM 3270 PC/G and GX

5371 Model 12: System unit with 384K-byte memory, one floppy-disk drive and adapter, 3270 system adapter, parallel printer adapter, and mouse tablet/adapter

\$4130

5371 Model 14: Same as Model 12 except for 512K-byte memory and two floppy-disk drives

\$4755

5371 Model 16: Same as Model 12 except for 576K-byte memory and 10-megabyte fixed-disk drive and adapter

\$6580

5371 Keyboard

\$295

5279 Color Display (14-inch, eight-color, 720 by 512 pixels)

\$1600

5278 Display Attachment Unit

\$3060

5379 Color Display (19-inch, 16-color, 960 by 1000 pixels)

\$3600

5379 Monochrome Display (19-inch, four shades, 960 by 1000 pixels)

\$2750

5378 Display Attachment Unit (color)

\$8310

5378 Display Attachment Unit (monochrome)

\$7810

5277 Mouse

\$340

Optional Hardware

5151 Monochrome Display

\$275

5152 Graphics Printer

\$449

5182 Color Printer (dot-matrix)

\$1995

3852 Color Printer (seven-color ink-jet)

\$900

Documentation

Guide to Operations, Reference Manual, Maintenance Information

Prices

3270 PC/G minimum configuration

\$9535

3270 PC/GX minimum configuration

\$16,785

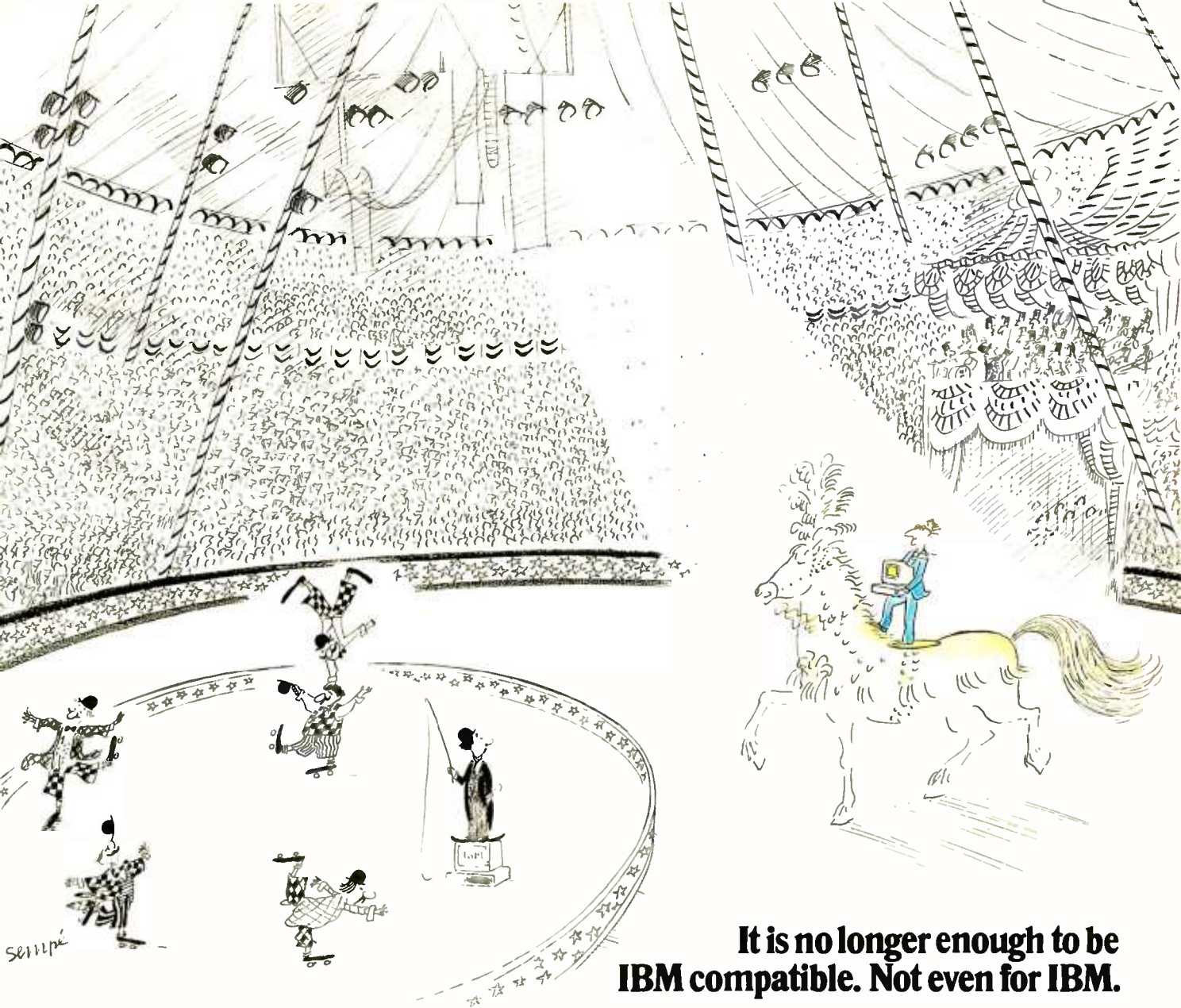

It is no longer enough to be IBM compatible. Not even for IBM.

It was the personal computer circus.

And it had gone on too long.

The crowd grew restless as each new act continued to perform varying degrees of IBM compatibility.

Suddenly, the crowd gasped. It was the unexpected finale—the arrival of Sperry, with a performance no one could have imagined possible.

Ladies and gentlemen, it was the Sperry PC. It ran IBM compatible software.

But that wasn't the show stopper.

Because it soon became quite clear the Sperry PC didn't just *run* the IBM programs, it ran them *better*.

SPERRY PERSONAL COMPUTER SPECIFICATIONS

OPERATING SYSTEM
MS DOS Version 1.25 or 2.0 with G.W.
BASIC MICRO-PROCESSOR
High-Speed 16-bit 8088
DISPLAY SCREENS
High Definition monochrome display
IBM compatible graphics.
COMMUNICATIONS
Built-in Asynchronous

KEYBOARD
84 keys, 6 ft. cord
AUXILIARY MEMORY
Up to two internal 5¼" diskettes 10MB internal fixed disk when configured with single-diskette.
USER MEMORY
Standard 128K bytes, expandable to 640K
DIAGNOSTICS
Power-on self test
CLOCK
Time-of-day with battery back-up

Better because it ran them faster—up to 50% faster.

It ran them with breathtaking graphics, far more dramatic than the IBM PC could provide.

And it ran them from a keyboard that drew roars of approval, for it was not only easier to operate, but far more comfortable than IBM's.

And as the crowd cried out for more, that's just what Sperry gave them: the

ability to plug right into a company's main computer, whether that system was IBM or Sperry. Or both.

As the crowd sat stunned by this final flourish, Sperry left all with a most provocative question. Was it possible

that the Sperry PC could do all of this and yet cost less?

Again, the crowd gasped. Could it be?

Come see for yourself. Hands-on, side-by-side. Call 800-535-3232, toll-free. Or write us. Sperry Corporation, Computer Systems, Department 100, P.O. Box 500, Blue Bell, PA 19424-0024.

SPERRY



**The Sperry PC.
What the personal computer
should have been in the first place.**

© Sperry Corporation, 1983

IBM is a registered trademark of International Business Machines Corporation.
MS DOS is a registered trademark of Microsoft Corporation.

Circle 168 on inquiry card.

Fall 1984 • BYTE Guide to the IBM PC • 25

IBM System 9000



The IBM System 9000 is designed to automate the laboratory as the IBM PC automated the office. For data acquisition, data analysis, and instrument control, the S9000 has a wide range of interfaces: three RS-232C ports, a bidirectional 8-bit parallel port, an IEEE-488 port, three timers, a clock, 32 programmable interrupts, and four DMA channels. The system includes a real-time, multitasking operating system (CSOS) that can simultaneously collect data, store or process it, analyze collected data and display it on the screen, output data to the printer/plotter, or transmit the data to other computers for analysis.

The S9000 comes in two versions—one for the lab, one for the office. The IBM 9001 benchtop model holds the computer, a display, and multicolor printer/plotter in a vertical package that occupies little space. The IBM 9002 is a smaller system with cleaner lines for your desktop. The XENIX operating system (a version of UNIX) is also available for multiuser, multitasking applications in which real-time control is not as critical. You must configure the system with a hard-disk drive, a memory-management card, 640K bytes of memory, and one 8-inch floppy-disk drive in order to run XENIX. Files can be transferred between the two operating systems.

The large membrane keypad with 57 user-programmable keys helps automate laboratory applications by defining single-keystroke commands to control instruments. Keypad overlays let you clearly label the keys. ■

Name

IBM System 9000

Manufacturer

International Business Machines Corporation
IBM Instruments Inc.
Orchard Park
POB 332
Danbury, CT 06810

Size

7 by 18 by 22 inches: 64 pounds

Components

Processor: Motorola 68000, 8-MHz; with four DMA channels
Memory: 128K bytes ROM, 128K bytes RAM standard, expandable to 5.2 megabytes in 256K-byte increments
Processor Board Interfaces: Three RS-232C, one bidirectional 8-bit parallel, one IEEE-488
Display: 12-inch green-phosphor 768- by 480-pixel screen; 80 characters by 30 lines; 10 user-definable keys below screen
Keyboard: 83-key layout with 10 function keys and numeric/cursor keypad; 57-key pressure-sensitive keypad; detachable with 6-foot coil cable
Mass Storage: Optional 640K-byte 5¼-inch or 985K-byte 8-inch floppy-disk drive
Expansion: Optional, five slots on a system bus card

Software

Real-time, multitasking Computer System Operating System (CSOS); diagnostics

Optional Hardware

256K-byte Memory Expansion Card	\$1395
1024K-byte Memory Expansion Card	\$3180
Dual 5¼-inch floppy disks	\$1645
Dual 8-inch floppy disks	\$2470
10-megabyte hard-disk drive	\$2195
Hard-disk controller card	\$1295
Memory-management card	\$1495
Analog sensor card	\$1695
Color Printer	\$1995

Optional Software

CSOS Extensions	\$155
BASIC Interpreter	\$195
Pascal Compiler	\$595
FORTRAN Compiler	\$595
Chromatography Application Program	\$795
XENIX Operating System	\$995

Documentation

Operator's Manual, OS 1.1, Problem Isolation Manual, BASIC Manual

Prices

9001 Benchtop Computer	\$6495
9001 Benchtop Computer with printer/plotter	\$8590
9002 Desktop Computer	\$6495

Tell this to your PC and see what happens.

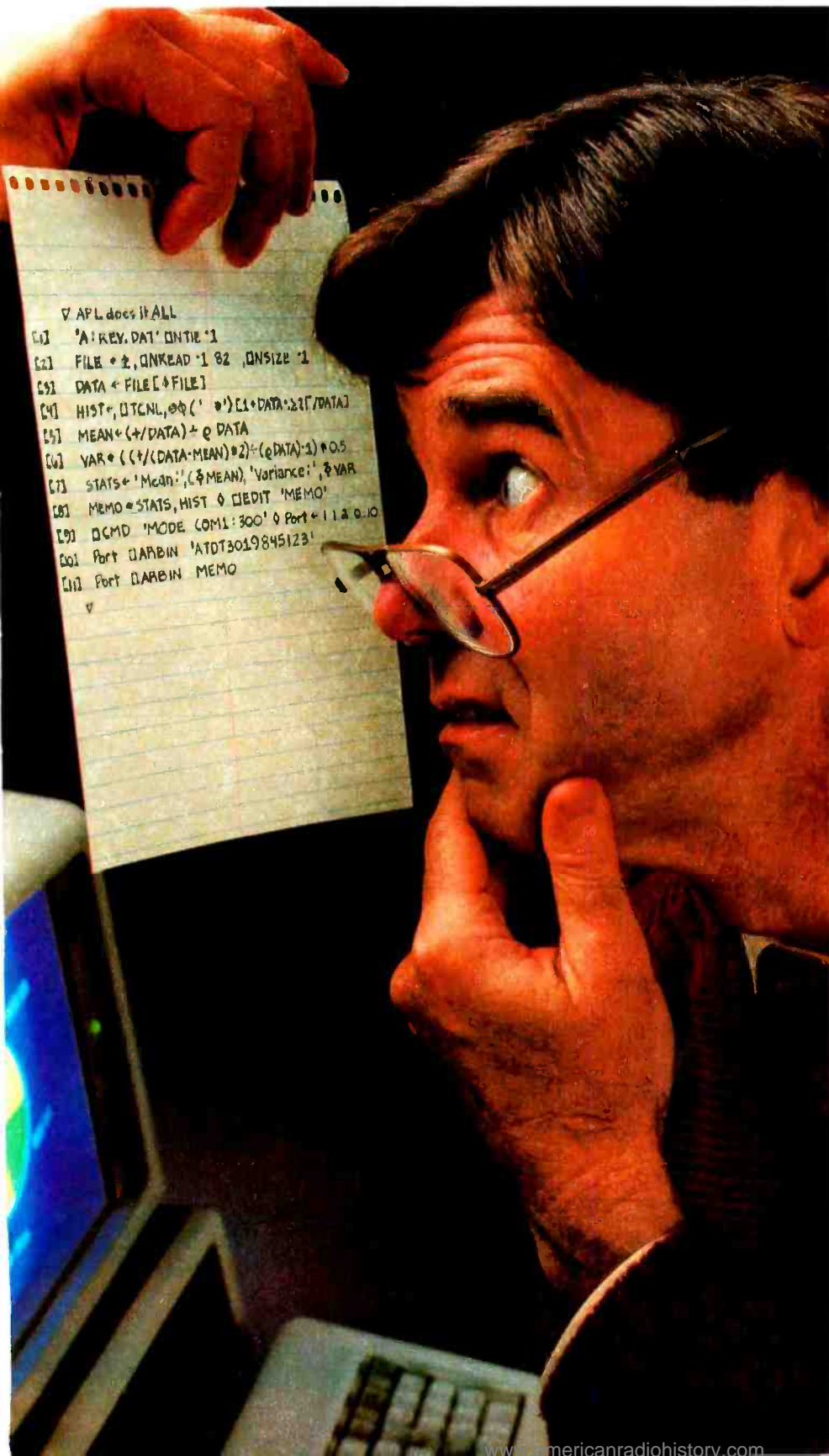

No, it won't roll over and play dead. While the funny-looking symbols might not make immediate sense to you, to a PC equipped with STSC's APL*PLUS®/PC System they tell an amazing story. In just 11 lines this program describes a sequence of events that can't be accomplished by any other single software package.

The program is written in an application development language called the APL*PLUS/PC System. Briefly, here's what it does. First, it sorts a DOS file containing revenue data and plots the revenues as a histogram. It calculates mean and variance revenues. Then with the help of a full-screen editor, it creates a memo combining the histogram, statistics and descriptive text. Finally the program issues a DOS command to the PC, dials a host computer, and electronically mails the memo. All in just 11 lines. No wonder a *PC Magazine* reviewer reacted to our APL*PLUS/PC System with "awe and delight" (March 1983).

If you want to integrate existing software or create custom solutions to problems that can't be handled by the software you're currently using, you need the APL*PLUS/PC System. It costs \$595.00, and runs on the IBM PC with 192 KB of RAM as well as on a number of compatible machines.

To order the APL*PLUS/PC System see your local dealer or contact STSC, Inc., (800) 592-0050, 2115 East Jefferson Street, Rockville, Maryland 20852.

STSC

A Contel Company

Circle 165 on inquiry card.

APL*PLUS is a service mark and trademark of STSC, Inc., registered in the United States Patent and Trademark Office and in certain other countries.



SNA/Bisync

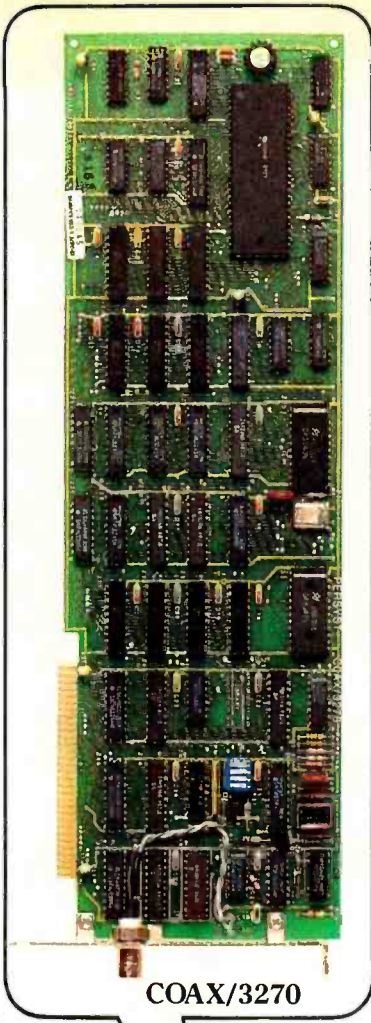

COAX/3270

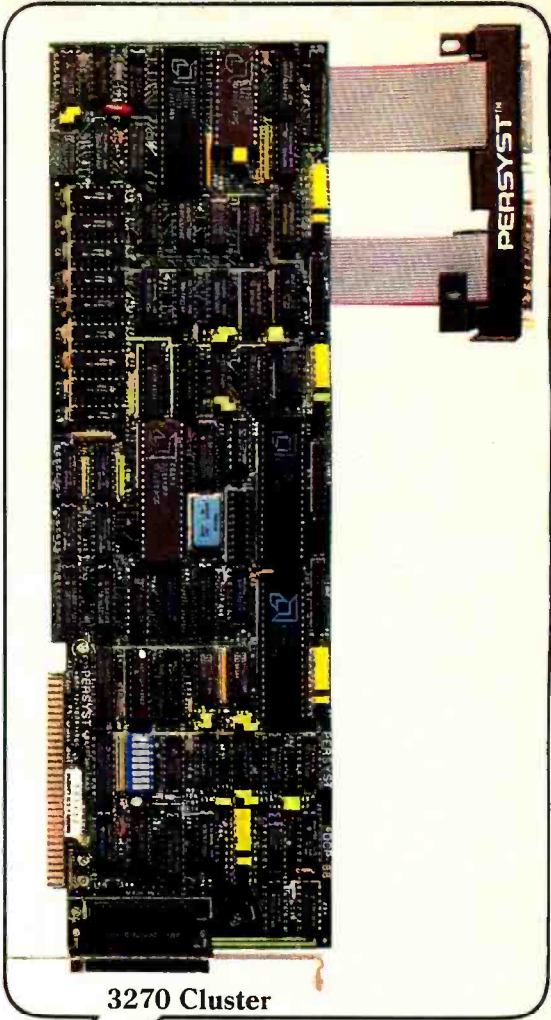

3270 Cluster

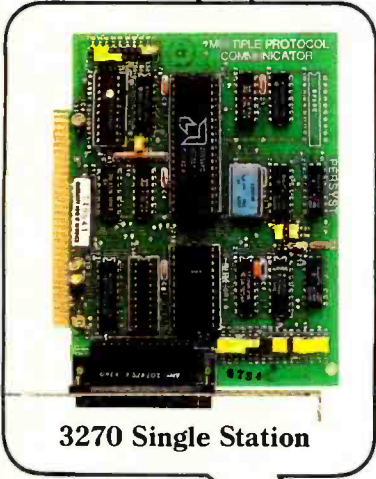

3270 Single Station

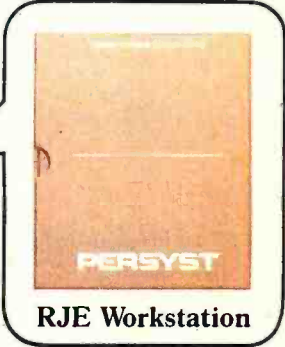

RJE Workstation



Let Persyst get your IBM PC talking to your mainframe, because we have more to talk about.

We have a full range of communication solutions to talk about. That's why Persyst is your single source for the most flexible, the most cost efficient ways to tie your IBM PC to your mainframe computer.

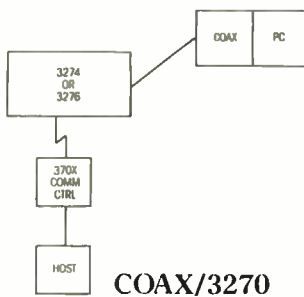

For instance, one solution is our Coax/3270. This single-slot expansion board lets you connect your IBM PC directly into virtually any IBM 3270 environment. And with our 3278/79 emulation software, it's easy to share information between your mainframe and IBM PC.

And that's just the start. Persyst has other solutions that will help you incorporate your IBM PC into almost any IBM communications environment, including SNA or Bisync.

With our DCP/88 and our Multiple Protocol Communications controller (MPC), you can create a sophisticated, remote, multi-user 3270 environment. One that can support up to nine devices, including five printers and four PCs functioning as 3278/79 display stations. Or, use either the DCP/88 or MPC to configure 2780/3780 or HASP RJE workstations.

Because Persyst's communication solutions are built on powerful software-controlled multiple protocol hardware, you'll have maximum configuration flexibility. And this means you'll be able to modify your communication strategies as your needs change — without constantly reinvesting in new hardware. It's your guarantee for the future.

And when you're ready to talk about quality and reliability we have plenty to say about that, too. All Persyst products are submitted to one of the most stringent testing and quality assurance programs in the industry. We're so confident in our quality and reliability that we back our products by a 2-year warranty.

So if you're looking for flexible, low cost and reliable solutions for IBM PC to mainframe communications, talk with Persyst. But be

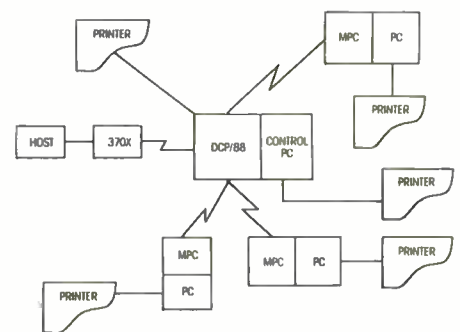

Cluster Controller

prepared to spend some time, because we have lots to talk about.

Persyst Products, Personal Systems Technology, Inc., 17862 Fitch, P.O. Box 19615, Irvine, California 92714. Telephone: (714) 660-1010 Telex: 467864

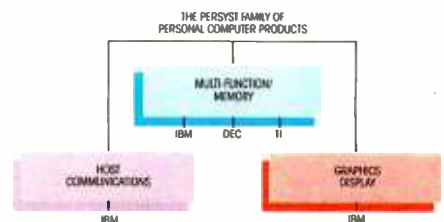

Insist on Persyst.



IBM FORECAST

MARKET DOMINANCE

IBM's array of follow-up products and enhancements for the PC means it is here to stay

During 1983, IBM shipped more than 600,000 PC and PC XT microcomputers, making the microcomputer division one of the most startling success stories in IBM's long history. IBM's introduction of low-end computer products has changed the way the corporation approaches the marketplace. Their success will continue to alter Big Blue's development in years to come.

Follow-up products from the corporation's Entry Systems Division in Boca Raton, Florida, and products developed in concert with that division by IBM's Raleigh, North Carolina facility and Endicott, New York operation (the 3270 and XT/370, respectively) indicate that IBM will continue to devote impressive resources to both software and hardware in low-priced computing packages.

Strategic Inc., a high-tech research and market-analysis firm located in San Jose, California, set out to compile user reactions to IBM's new PC from those businesses across the country that have purchased one or more units. *IBM PC User Reactions, Requirements and Plans—1984*, completed in December 1983, also speculates on how businesses will use these computers in the future.

IBM's PC line now includes six products: the original IBM PC, the IBM PC XT, the PCjr, the PC Portable, the 3270 PC, and the XT/370.

Michael Killen (POB 2150, Cupertino, CA 95015-2150) is president of Strategic Inc.

BY MICHAEL KILLEN

THE 16-BIT STANDARD

The 16-bit IBM PC is a flexible, dependable, expandable personal computer with an Intel 8088 central-processing unit, an 8-bit data bus, and one or two 5¼-inch, single- or double-density floppy disks. Its bit-mapped graphics display comes in monochrome or color, and its PC-DOS (disk operating system), a variant of Microsoft's MS-DOS, is now the standard among 16-bit operating systems for personal computers.

The PC and the XT are architecturally identical: PC programs run without modification on the XT, and any PC board can be plugged into the XT. However, the XT, which contains more slots and a larger power supply, is capable of supporting more peripherals and memory. The XT is configured with both a 5¼-inch floppy disk and a 10-megabyte hard disk.

The IBM PC is exceptionally well constructed and provides an excellent diagnostics package that allows customers to

isolate problems. Most microcomputer companies do not provide such a package. It is a reflection of IBM's long-term customer-oriented philosophy.

IBM's personal computer was one of the first to provide "bit-mapped" graphics, meaning that each pixel on the display monitor is represented by a single bit in memory, with specialized hardware to translate the memory "image" into TV signals to drive the monitor. To update any point on the screen, a programmer need only set the appropriate bit in memory. Bit mapping is inexpensive and critical for the "window" features in advanced software.

The Intel 8088 processor provides slightly less arithmetic power than a 4-mHz Z80 by Zilog. However, the 640K-byte maximum address space of the PC allows many significant programs to be run without swapping code or data segments. This often improves performance considerably because disk

(continued)

User Reactions

Strategic Inc. surveyed 70 large companies that currently use both the IBM PC and at least one mainframe and 100 smaller companies that use the IBM PC and some other mini- or microcomputer.

Strategic's findings confirmed several theories on IBM strategies. According to Strategic, IBM has maintained control of its mainframe customers, dissuading most from adding non-IBM equipment. Further, the December 1983 study found that most mainframe customers are using their PCs in conjunction with their mainframes; ultimately, this habit will increase IBM's mainframe revenues.

Specifically, the study found that the large organizations interviewed had an average of 21 IBM PCs installed; the smaller companies had an average of six. According to the survey results, most of the larger companies consider the standard to be IBM products rather than microcomputers from Apple.

The conclusions Strategic reached in its study are as follows:

- Purchase, installation, training, and service are mainly handled by the data-processing departments of large organizations.
- Training is not yet taken very seriously, with most users being self-

taught. Many respondents don't think this is adequate.

- Most of the actual users of IBM PCs are middle managers in both large and small organizations.
- Large organizations purchase more complete systems than smaller companies, with more than 70 percent of these configured with two floppy-disk drives or 10-megabyte hard-disk drives.
- Large and small users cite more than 30 different primary applications for their PCs. Spreadsheet and financial applications are the most common.
- Most users are not developing applications software themselves. Of those who are, BASIC is the most popular language, followed by Pascal and FORTRAN.
- Only 12 percent of the large organizations sampled use a LAN (local-area network), of which only two are standard networks (Corvus and 3COM). The majority of large users are actively considering purchasing a LAN, or will do so in the foreseeable future.
- Approximately two-thirds of the large users use IBM 3270 emulation to access other systems. For one-fourth, the PC is mainly used as a terminal, with another one-

third using both terminal and PC capabilities. One-third use or want to use remote-job-entry capability.

- Most large users need to access IBM mainframes from the PC. Most small users need to access some other computer system.
- Sharing files is the most common reason cited for wanting multiuser versions of a PC.
- Most systems in both large and small companies are shared by at least two different users, and most users have some file-sharing requirement, making a multiuser version of the PC desirable.
- Most small and large organizations are satisfied with their IBM PCs, most citing increased speed, efficiency, quality, and lower cost work as reasons.
- Large organizations in the sample expect to buy at least 32 PCs each during the next year. Sixty percent of the large user organizations plan to make one brand of personal computer standard, and two-thirds have chosen IBM products. Nine percent have chosen Apple.
- Half of the large users expect to buy at least 25 percent more XT systems. Almost 20 percent state they would buy only XT systems.

\$2,490

Great Lakes offers you add-on storage and tape back-up at an unforgettably attractive price

So you're about to outgrow the storage capacity of your IBM PC™ or compatible computer? And now you're biting your nails over the cost of adding more bytes.

No need! Consider the eminently memorable combination price of the Great Lakes Superior 10™ hard disk subsystem and the Great Lakes Quartermaster 23™ tape back-up module.

The Superior 10—\$1495

Not only is our \$1495 price considerably lower than the nearest 10-megabyte competitor, but we offer the best dollar-per-megabyte ratio for the 23mb and 40mb subsystems as well. The ratios? 10mb at \$149 per mb; 23mb at \$98 per mb (retail \$2249); 40mb at \$70 per mb (retail \$2795).

Quartermaster 23—\$995

This optional 23mb tape back-up module is simple to use and efficient as well. Take, for example, our remarkable Selecta-File™ feature. This ¼-inch tape drive module allows you to back up and restore data using selective file-by-file data transfer (or full streaming). And it masters all this for just \$43 per megabyte.

Complete and ready-to-use

When you buy a Superior hard disk subsystem, everything is there, ready to operate at high speed. This includes: high quality fixed hard disk, controller board, software that runs on DOS 1.1 and 2.0 (CP/M 86™ and other operating systems available), host adaptor board, integral power supply, cables, external custom chassis with additional space for our tape back-up, and documentation.

Our line is expansive, not expensive

Need even more storage for your IBM PC or compatible? We offer hard disk subsystems including 65, 110 and 140mb—all designed for superb quality at the very lowest possible prices. And we stand behind all our products with our 90-day warranty. That's because our quality lives up to our first name.

Available at leading dealers everywhere



 **GREAT LAKES**™
COMPUTER PERIPHERALS, INC.

We live up to our first name

2200 W. Higgins Road, Hoffman Estates, IL 60195
1-800-323-6836/1-312-884-7272

™ IBM PC is a trademark of International Business Machines Corporation.

™ Superior (10 through 140), Quartermaster 23, and Selecta-File are trademarks of Great Lakes Computer Peripherals, Inc.

™ CP/M 86 is a trademark of Digital Research, Inc.

Circle 69 on inquiry card.

The Ven-Tel Half Card.[™] The only 1200 baud modem for your IBM XT or IBM portable PC.

The Ven-Tel Half Card[™] is the only internal 1200/300 baud modem that fits in the small expansion slots of the IBM-XT and the IBM Portable.

Free Expansion Slot. If you own an IBM PC-XT, look inside the chassis sometime. You'll see a number of standard sized expansion slots and one unused half-sized slot. That's where the Half Card[™] fits—in a spot that would otherwise be wasted. So why take up one (or sometimes two) valuable full-size slots for your modem? With the Half Card,[™] it's like getting an extra expansion slot for free.

True Portability. IBM Portable PC owners will appreciate the true portability offered by the Half Card,[™] the only modem that fits in the half-sized slots of the Portable. When you're on the road, you won't need to pack along a bulky external modem, cable and power supply. Your modem will already be inside your computer, ready to go!

Although it's half the size of other modems, the Half Card[™] has all of the high performance features you expect: selection of 1200 or 300 baud,

automatic dialing using the industry standard "AT" command set, automatic answer on any ring, and full compatibility with virtually all software.

The Half Card[™] comes complete with one of the most popular communications software packages available, CROSSTALK XVI by Microstuf. Whether you use an information service such as The Source or Dow Jones News Retrieval, or transfer files and electronic mail, the Half Card[™] connects your Portable or XT to the world.

Effortless Communication
From Ven-Tel Inc.

2342 Walsh Ave.
Santa Clara, CA 95051
(408) 727-5721

Circle 180 on inquiry card.

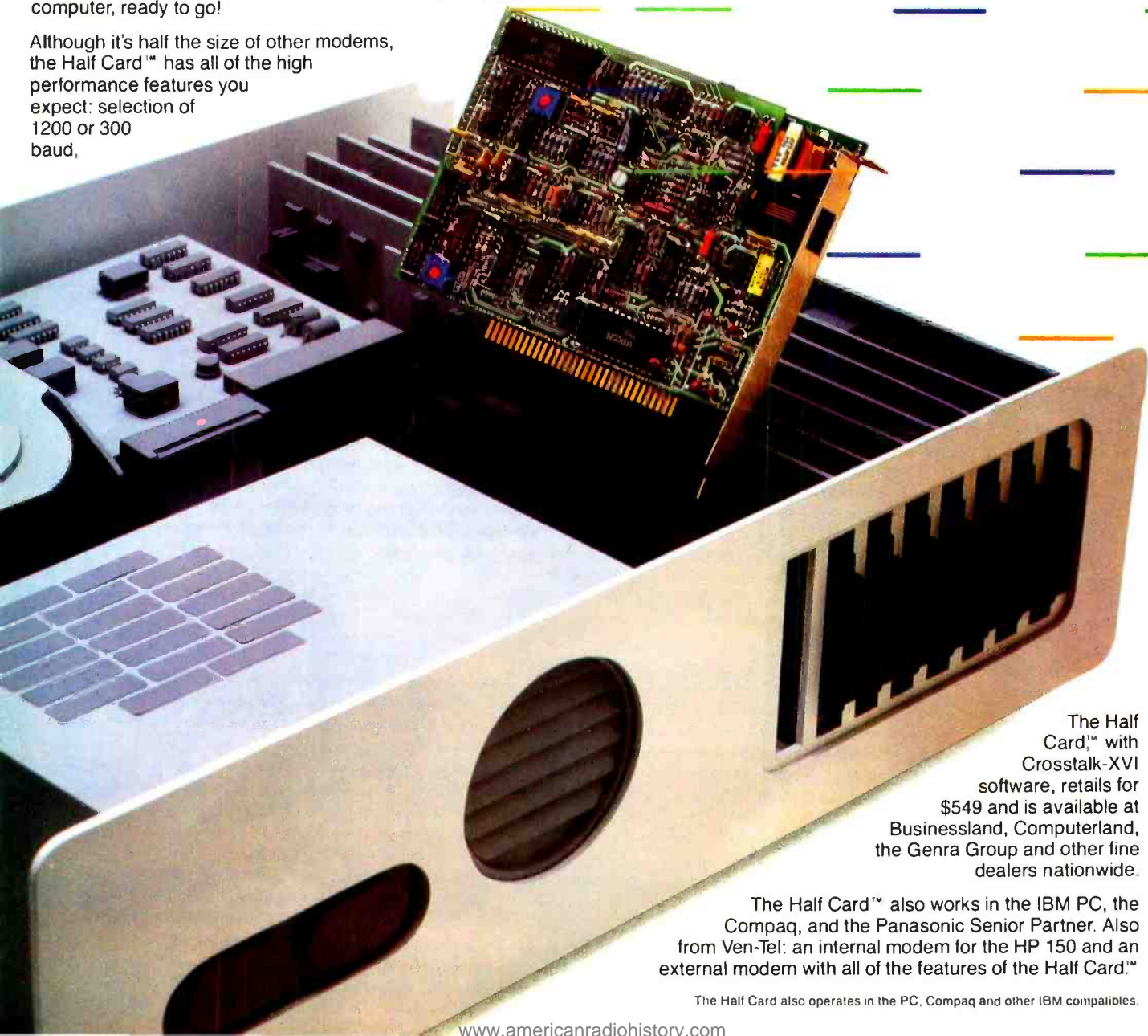

The Half Card[™] with Crosstalk-XVI software, retails for \$549 and is available at Businessland, Computerland, the Genra Group and other fine dealers nationwide.

The Half Card[™] also works in the IBM PC, the Compaq, and the Panasonic Senior Partner. Also from Ven-Tel: an internal modem for the HP 150 and an external modem with all of the features of the Half Card.[™]

The Half Card also operates in the PC, Compaq and other IBM compatibles.

I/O (input/output) is always time consuming. For instance, on a Z80 even a word processor such as WordStar requires code overlays, and relatively small files must be shuffled to and from the disk. On an IBM PC, the entire program can be resident in memory simultaneously, in addition to very large files.

While 640K bytes of address space is a great improvement over available microcomputer RAM (random-access read/write memory), it is only two-thirds of the 1-megabyte address space available to the 8088 chip. Unfortunately, Microsoft's BASIC Interpreter and the PC disk operating system consume the remaining 360K bytes of memory. Although the remaining memory is adequate for most of today's microcomputer programs, the limit prevents the PC from running large programs, keeping several programs in memory at once, or storing a large amount of data in memory. Each limitation reduces the effectiveness of IBM's PC in some applications and will slow the development of more sophisticated software.

Further, the 8088's 8-bit I/O and memory data bus limit the speed of communication between the PC and its disks or other peripherals to 8-bit levels.

IBM's own feature-by-feature comparison of price and performance shows the PC to be markedly inferior and higher priced than most equivalent systems from other companies. The system is not being sold on either point, but rather as the standard from a corporation that provides strong support, demonstrating, once again, IBM's hegemony in the computer market.

THE IBM 3270 PC

The 3270 PC embodies several IBM tactics. First, it allows IBM to push ahead in the personal computer market and yet maintain its mainframe products at the center of a client's information-processing needs. Second, it bolsters the data-processing department's role in information processing. This is important because IBM's main customers are data-processing managers, not office-automation managers.

Further, the advent of the 3270 PC enhances and protects a line of IBM products (3270/3274) that is now 12 years old. The 3270 PC may be the first step in upgrading the 3274 product. For instance, IBM may merge the 3274 and the yet-to-be-announced local-area network product, or it may use the 3270 PC's program capability to enhance mainframe control of terminals and provide such features as teletext and distributed graphics systems.

Before the advent of the 3270 PC, it was possible to argue that mainframes and their traditional data-processing functions were destined to be overlapped and possibly even superseded by information-processing functions performed by integrated networks of PCs and small multiuser systems. IBM has negated this argument by increasing the capabilities of its mainframes through the integration of more business microcomputer functions. Thus, the information processing functions of business microcomputers are dependent upon the existence and expansion of a mainframe.

The 3270 PC is a superset of the functions of the IBM PC and the IBM 3270 terminal. As a 3270 terminal, it hooks into any of the 3274 control units or serial I/O ports on the various IBM mainframe computers. As a PC, the system provides various configurations comparable to the IBM PC or XT.

IBM has added new functions to this combination, the most

important being the simultaneous display and manipulation on the screen of as many as four "documents" (files or data developed within a program). This kind of integration distinguishes the 3270 PC from a PC with a 3270 emulation adapter.

The 3270 PC will appeal to three classes of customers who currently own IBM mainframes: those who have many management and technical personnel who currently use the mainframe and use, or wish to use, PC functions; microcomputer (and not just IBM PC) users who need to access mainframe data in the course of their work with the microcomputer; and IBM PC users who can't wait for IBM to support the multi-window capabilities on the IBM PC.

Strategic Inc. believes there are many such users. However, even if there were not, IBM has positioned this product to strengthen both the IBM PC and its mainframe lines of equipment.

The 3270 PC multitasking window capabilities represent an entirely new dimension for both the IBM PC and mainframe products. Comparable single-user, stand-alone systems are Apple's Lisa, the Xerox 820, and the IBM PC with a hard disk running VisiOn software. No comparable stand-alone, multiuser products are available to users of IBM mainframe products.

There is, therefore, no direct competition with the 3270 PC. Strategic Inc. knows of none planned, although companies that make 3270-compatible terminals, such as Memorex, are likely to develop equivalent products.

THE XT/370

IBM's XT/370 reaffirms its corporate strategy of maintaining the traditional mainframe as the center of a company's information processing. It is also an attempt to create an industry-standard processor in a new market: the personal workstation arena.

Further, the XT/370 will ultimately force the upgrade of a company's existing mainframe equipment. Adding the XT/370 superficially unloads a company's mainframe 370 of its duties, but the introduction of more XT/370s, spurred by the increased terminal capabilities at relatively low cost, will increase the burden of the mainframe 370. Eventually, this leads a company to invest in additional disks, memory, channel capacity, and probably an upgraded central processor.

Physically, the IBM XT/370 is an XT personal computer with three new boards added, providing 768K bytes of memory, four chips (an 8088, two 68000s, and an 8087), which allow it to execute the 370 instruction set, and an I/O and virtual-memory management unit.

Functionally, the IBM XT/370 combines three systems and allows the user to switch quickly between them. In the PC mode, it is an IBM XT. In terminal mode, it functions as an IBM 3277 display terminal. In workstation mode, it executes a new version of the System/370 VM/CMS (Virtual Memory/Conversational Monitor System) operating system, called VM/PC, enabling the workstation to download VM/CMS applications from the host processor. Thus, only normal file and virtual-memory management are handled by the System/370. As a VM/PC workstation, the XT/370 can call up mainframe programs and access mainframe data in a virtual environ-

(continued)

ment of up to 4 megabytes.

Technically, the XT/370 is a weak product: first, there is little integration of the XT/370 with the System/370. For instance, the host treats it like a 3274 terminal, not like a coprocessor. This may be fixed by future software products.

Second, the PC portion of the XT/370 is not well integrated with the MVS (multiple virtual storage) environment.

Third, the XT/370 suffers physical and architectural constraints as a result of IBM's using the XT system as a base. For instance, the PC operating system is always active. The main memory is shared between the 8088 and 370 processors. Further, both I/O and memory share the same 8-bit bus, and, finally, all VM/CMS I/O is run through the PC BIOS (basic input/output system) code.

These limitations, combined with the 70-millisecond access time for the 5¼-inch Winchester disk, which is the paging device, mean that the aggregate performance of the system will be far below the 0.1 millions of instructions per second (MIPS) claimed by IBM. The claim is made for any application with a working set larger than the 416K bytes of physical memory available to the XT/370 processor, while running as a 370. One-tenth of a million instructions per second of 370 processor power is comparable to a 4-mHz Z80 and less than the processor power of an 8086. This is clearly not a price/performance breakthrough compared to other microprocessors.

The XT/370 provides its 0.1 MIPS at a cost of approximately \$12,000, or \$120,000 per 1.0 MIPS. This compares favorably to approximately 1.2 MIPS at \$500,000 for IBM's own 4341 mainframe. Thus, the XT/370 has from two to ten times the absolute processor power available to an average mainframe VM/CMS user, and approximately 3.5 times the price performance ratio of the 4341-12, while allowing you to add the workstations in \$12,000 increments, rather than buying a \$500,000 system.

Finally, IBM's marketing thrust for the XT/370 appears to focus on providing cost-effective higher performance on a per-user basis. However, though favorable relative to IBM's own equipment, the absolute performance of the XT/370 is lower and the price is higher than comparable microcomputers. The per-user cost is unfavorable compared to "super-mini" products.

IBM expects the XT/370 to appeal to several classes of customers who have overloaded mainframes:

- Applications developers. The first software releases for the XT/370 emphasize software development. Undoubtedly the work of the original development team, this software provides an excellent interactive environment.
- Users of small working-set applications. These customers will require considerable processor power relative to that available to a single user under the VM/CMS environment, but relatively little I/O.

If the working set of the application is so large that it cannot fit into the 416K-byte physical memory (when running in 370 mode), or if a large data set is used in the 4 megabytes of virtual memory, the PC's disk I/O will limit performance to a fraction of the 0.1 MIPS. If high-density disk or tape I/O is required and files are so large they cannot fit on the XT disks, the performance advantage of the

XT/370 will likely be dissipated by the increased time necessary to communicate this data between the mainframe and the XT/370 workstation.

- Engineers and scientists. These customers work with relatively small amounts of data (probably in FORTRAN) and will obtain a better turnaround time from a local 0.1 MIPS system than from a shared mainframe.

It is nearly inconceivable, given the number of very high-performance microcomputers aimed at this market, that IBM could sell a single XT/370 for this use without its current dominance in the data-processing market and the power that data-processing departments have in systems acquisition within most companies.

PROBABLE FUTURE PRODUCTS

Obvious and necessary upgrades to the PC and XT are larger memory, larger disks, and a larger variety of printers, plotters, modems, etc. Future versions, compatible at the software but not the hardware level, may feature faster memory and processors, but this is unlikely before 1987 or 1988.

Obvious and necessary upgrades of the 3270 PC include all of the above. Additionally, IBM and other companies will take advantage of the PC's processor power and local disk storage to provide increased integration of other mainframe software environments with the PC. For instance, IBM's interactive environments are not known for simplicity, and a menu-driven TSO (timesharing operation) interface would allow the user to function effectively knowing much less about TSO.

Obvious and necessary upgrades of XT/370 include larger disks, printers, etc., as well as better integration of VM/PC with PC-DOS. Strategic Inc. does not expect a more powerful version of this product, based upon higher performance processors and a 16- or 32-bit bus, until a competitor appears and threatens to gain market share. A more powerful XT/370 would undermine its own 42XX mainframe business.

COMPETITION

Although IBM retains and is extending its market dominance with these PC/workstation products, there is room for competition in terms of performance, cost, features, and market flexibility.

The performance gap between IBM's products and what is technologically possible remains. None of the PC products demonstrates particularly impressive performance, either in absolute terms or relative to price. For instance, the 8088's performance is inherently low, and other companies are already offering PC-compatible systems based on the Intel 8086, a chip with 16-bit access to memory and I/O. Other companies have announced, or soon will announce, systems based on the Intel 80186 and 80286. The 80186 incorporates DMA (direct memory access), bus control, and other functions into the central processor, cutting component cost and allowing more functions on a single board.

Matching the performance of the XT/370 with bit-slice technology or a custom processor would be relatively simple and inexpensive for a competitor.

IBM's PC has no convenient means of sharing peripherals and data with other personal computers. IBM may remedy

(continued)

Has IBM Captured the Market?

The Strategic Inc. study, completed in December of 1983, is based on interviews with 170 companies—both large and small—representing every segment of American industry. The complete report covers user reactions to the PC, a market analysis, and an analysis of the technical limits of IBM's new line of computers.

Based partly on the interviews and also on the company's economic modeling, Strategic forecasts that IBM will sell 1.5 to 2.0 million units of the PC, the PC XT, and the XT/370 in 1984. Shipments of these computers should increase to 3.4 million in 1988.

IBM itself claims that it will ship 2.5 million PCs and PCjr's in 1984. Strategic's estimates are very close to that number, provided IBM ships approximately one million PCjr's. Based on Strategic's interviews with 70 large corporations and 100 smaller ones, all currently using IBM PCs, Strategic has come to some general conclusions that its full study, *IBM PC User Reactions, Requirements and Plans—1984*, documents.

Among these conclusions are proposals as to IBM's probable strategies: to set a standard with IBM PCs in a business environment; to design PCs to function with IBM mainframes, thereby bolstering the company's mainframe business; and to merge terminal and PC functions to increase the value of terminal sales.

MARKET ANALYSIS

Each of IBM's latest products is sold to one of three distinct markets. According to estimates published by IBM, approximately 40 percent of its systems will go to large accounts for business use in 1984; 20 percent to scientists and engineers, mostly with large accounts (companies); and the remaining 40 percent to small organizations and home users.

The PC and XT models are sold to both large and small businesses, where they are used as personal computers, as a small company's

main data-processing system, or as a terminal to a mainframe computer. According to Strategic's 1983 findings, IBM now has 50 percent of this business/personal computing market.

The 3270 PC will be sold in the mainframe-based market in large corporations, primarily for use by managers and financial personnel.

The XT/370 will be sold as a workstation for IBM mainframes, which execute VM/CMS (Virtual Memory/Conversational Monitor System), an operating system with the fastest growth rate of any of IBM's line. It can already be found in more than 10,000 installations.

Despite strong sales growth rates for the PC and PC XT in the next few years, Strategic's conclusions take into account the products' technological obsolescence. The 640K-byte limit of physical memory and the 8-bit data bus (which inhibits I/O, for example) will become increasingly severe constraints on sales as more sophisticated software is developed and higher performance peripherals are added to the IBM PC. Strategic's user survey found that, while most clients were happy with the selection of software available for the PC, most said they wanted a faster version of the PC. Strategic projects that the current versions of the PC and XT, as well as the 3270 PC and the XT/370, will be phased out by 1987.

Strategic also concludes that IBM's main focus for 1984 will be the 3270 PC. As a combined terminal and PC, this is a stronger product than the XT/370. Furthermore, the product has no direct competition, and its only indirect competition comes from microcomputer companies that provide 3270 emulation on PC-compatible products. But these do not provide the features of the IBM model.

Although further software developments throughout 1984 may make the XT/370 a more interesting product by integrating it with mainframe systems, Strategic concludes its design has been seriously compro-

mised by IBM's basing it on the XT. The 416K-byte memory limit when running in 370 mode will eliminate many CMS programs that would have been useful to middle managers who use mainframes constantly. Furthermore, the maximum (best-case) performance of only 0.1 million instructions per second (MIPS) and the 4 megabytes of virtual address space will limit its use in some scientific and engineering applications. It will remain useful for developing software on already overloaded systems.

IMPACT OF COMPETITION

Competition from Asia could encroach on 1984 sales of the IBM PC. Already Taiwanese work-alike computers are being delivered to American shores at prices 30 percent lower than IBM's. Furthermore, a number of American companies are manufacturing their computers and products in the Far East. These systems could saturate the personal and small business computer market for IBM's products by the close of 1984, seriously hurting sales in 1985. IBM PC systems with Winchester hard disks are most susceptible to this competition because of a domestic drive shortage. Both Korea and Taiwan are now manufacturing Winchesters.

Strategic does not believe that Far East competition will affect IBM's large accounts or those companies that buy PCs in quantity. But competition will heat up in the small business market, which, according to IBM's own estimates, will account for 40 percent of IBM's business in 1984. However, should foreign firms gain even 50 percent of the U.S. market—a remarkable feat of marketing and sales—IBM's sales would decrease by only 20 percent. The worst effect would be the saturation of the market; that is, supply would grossly exceed demand. This would place severe downward pricing pressure on the entire PC-compatible market and render a majority of the competitors unprofitable.

The Empress

Mainframe Decision Support Software For The Microcomputer

The Empress, from Empress Technology, is a unique software package for microcomputers which provides Decision Support Capabilities heretofore found only in Mainframe Report Writing Packages such as RAMIS and FOCUS. The Empress takes advantage of the new generation of Micro-Mainframe Chips and their ability to use large amounts of RAM effectively. Its capabilities take over where spreadsheets and integrated packages fall short, when writing complex ad hoc reports using large amounts of data. Most of the products now on the market lack the capability to manipulate large amounts of data interactively. The Empress can manage an unlimited number of records and can sort at a rate of 1000 records per second.

Internal calculations are done with 18 digit accuracy with Decimal Precision as is required by business systems. The Empress also provides a user friendly file editor with simple prompts as well as an interactive report writer which responds to simple commands such as "List each department with total sales for month July." The Empress Database Management System effectively puts a Mainframe Decision Support System on your desk. Most systems will show you how to get out from under your work. The Empress will keep you on top of it.

**THE EMPRESS DATABASE MANAGEMENT SYSTEM IS
AVAILABLE FOR THE APPLE LISA 2 AND OTHER
MOTOROLA 68000 BASED MACHINES**

**EMPRESS TECHNOLOGY INC.
510 KING ST. LITTLETON, MA 01460 • 617-486-9601**

Lisa 2 is a Trademark of Apple Computer Inc.
RAMIS is a Trademark of Mathematica Inc.
FOCUS is a Trademark of Information Builders Inc.

EXPAND to 280 MB NOW!

**For Your IBM PC with Integral
60 MByte Cartridge Tape Back Up.**

- Up to 280 MByte sub-systems available now
- Volumes and file sizes not limited to 32 MBytes
- Physical disk can be easily partitioned into multiple DOS volumes
- Supports all PC compatible networks
- Supports automatic bad sector defect mapping
- Supports IBM PC, PC/XT, or compatible
- Supports PC DOS 2.0, 2.1, QNX, Concurrent DOS and CPM 86
- Boot from hard disk
- Menu driven simple one time installation
- High performance and high capacity at the lowest cost per MByte



EMERALD™
SYSTEMS
CORPORATION
4901 Morena Blvd.
San Diego, CA 92117
619-270-1994

IBM PC, PC/XT are registered trademarks of IBM Corporation
Emerald is a registered trademark of Emerald Systems Corporation
QNX is a registered trademark of Quantum Software Ltd.
Concurrent DOS and CPM 86 are registered trademarks of Digital Research, Inc.

FORECAST

IBM has geared up for massive production, which means it is less flexible than competitors in its response to market requirements. Products with a relatively small market won't be handled by IBM.

this with a network in the future, but this will undoubtedly be a high-cost solution. There is certainly room for a "network-in-a-box" system similar in architecture to that of Molecular Computer's 8-bit systems, since this approach will lead to lower cost per user than a standard network.

This system should run both networked CP/M-86 and MS-DOS, since no multiuser software now exists for MS-DOS systems. Several companies have already demonstrated multiple operating systems executing on a single network.

IBM's PC and XT products were introduced while the Boca Raton organization was still an independent business unit (IBU). Within IBM, an IBU is freed of sharing the R&D cost burden imposed by IBM's establishment. Future products, now handled by the Entry Systems Division, will share the R&D costs, increasing its overhead dramatically. This burden will provide a price umbrella for leaner competitors, even though IBM production is highly automated.

IBM's personal computers don't support many desirable features, for instance, Hewlett-Packard's touch screen and NEC's high-resolution color graphics. Hewlett-Packard has done a notable job in this respect, having signed Lotus to enhance its Lotus 1-2-3 package to support the touch screen.

IBM has geared up for massive production, which means it is less flexible than competitors in its response to market requirements. Products with a relatively small market won't be handled by IBM. This leaves room for manufacturers and resellers of add-on and add-in equipment.

More important, the large-scale production, marketing, and future compatibility requirements planned by IBM for the PC line certainly mean that it won't be pushing technological limits. The company is bound by readily available parts. For instance, IBM's marketing requirement for a very low-cost system (the lowest-cost PC and the PCjr) forced the use of the 8088 central processor. This primarily saved IBM the cost of connectors, but permanently limited the computational performance of the system. For a modest cost increase (\$50 to \$100), IBM could install an 8086 and obtain a 50 percent to 100 percent increase in computational power, relative to the Z80 or 8088. However, IBM's compatibility requirements will prohibit such a change. ■

This article is based on IBM PC User Reactions, Requirements and Plans—1984, a report prepared by the staff of Strategic Inc., San Jose, California, and used with the company's permission. Copies of the document, released in December 1983, are available through the corporation at 4320 Stevens Creek Blvd., Suite 215, San Jose, CA 95157.



Integrated.

Printegrated.

Now, translate your integrated software into integrated hard copy, with the TI OMNI 800™ Model 855 printer. So versatile, it combines letter-quality print, draft-quality print and graphics as no other printer can. **It prints letter-quality twice as fast** as comparably priced daisy wheel printers, yet gives you characters just as sharp, just as clear.

It prints rough drafts ten times faster than daisy wheel printers... faster than most any other dot matrix printer. **Only the TI 855 has snap-in font modules.** Just touch a button; change your typestyle. The 855 gives you more typestyles to choose from than ordinary dot matrix printers. It makes them quicker, cleaner, easier

to access than any other dot matrix or daisy wheel printer.

The 855's pie charts are rounder... all its graphics are sharper than on other dot matrix printers, because the TI 855 prints more dots per inch. As for daisy wheel printers... no graphics.

The TI 855 Printer

The printer for all major PC's



For under \$1,000 you get twice the performance of typical dot matrix printers. Or all the performance of a daisy wheel printer, and then some, for half the price.

So get the best of all printers, and get optimum results from your integrated software. With the TI 855. See it at your nearest authorized TI dealer. Or call toll-free: 1-800-527-3500. Or write Texas Instruments Incorporated, P.O. Box 402430, Dept. DPF-183BY, Dallas, Texas 75240.

TEXAS INSTRUMENTS

Creating useful products and services for you.

™ OMNI 800 is a trademark of Texas Instruments Incorporated
Copyright © 1984 Texas Instruments Incorporated. 2763-36

STALWARTS:

THE IBM PERSONAL COMPUTER, PC XT, PORTABLE AND PCjr.

MACHINES WITHIN THE MACHINES: OPERATING SYSTEMS

- A Tale of Two Operating Systems**
by Charles Daney and Tom Foth 42
- The Future of UNIX on the IBM PC**
by Ralph A. Phraner 59
- Five Window Managers for the IBM PC**
by John Markoff 65

MANNERS OF SPEAKING: PROGRAMMING LANGUAGES

- Two Logos for the IBM PC**
by Morton Goldberg 91
- The Logical Record Keeper: PROLOG on the IBM**
by James L. Weiner 125
- An Introduction to PC Assembly-Language
Programming**
by William J. Claff 134

WAYS OF WORKING: APPLICATIONS AND PROGRAMMING

- Technical and Business Graphics on the IBM**
by Jack Bishop 155
- Word Processing Revisited**
by Janet Cameron 165
- Six Database-Management Systems for the IBM PC**
by David Kruglinski 187
- Evaluating 8087 Performance on the IBM PC**
by Stephen S. Fried 197
-

ILLUSTRATION BY ROBERT TINNEY

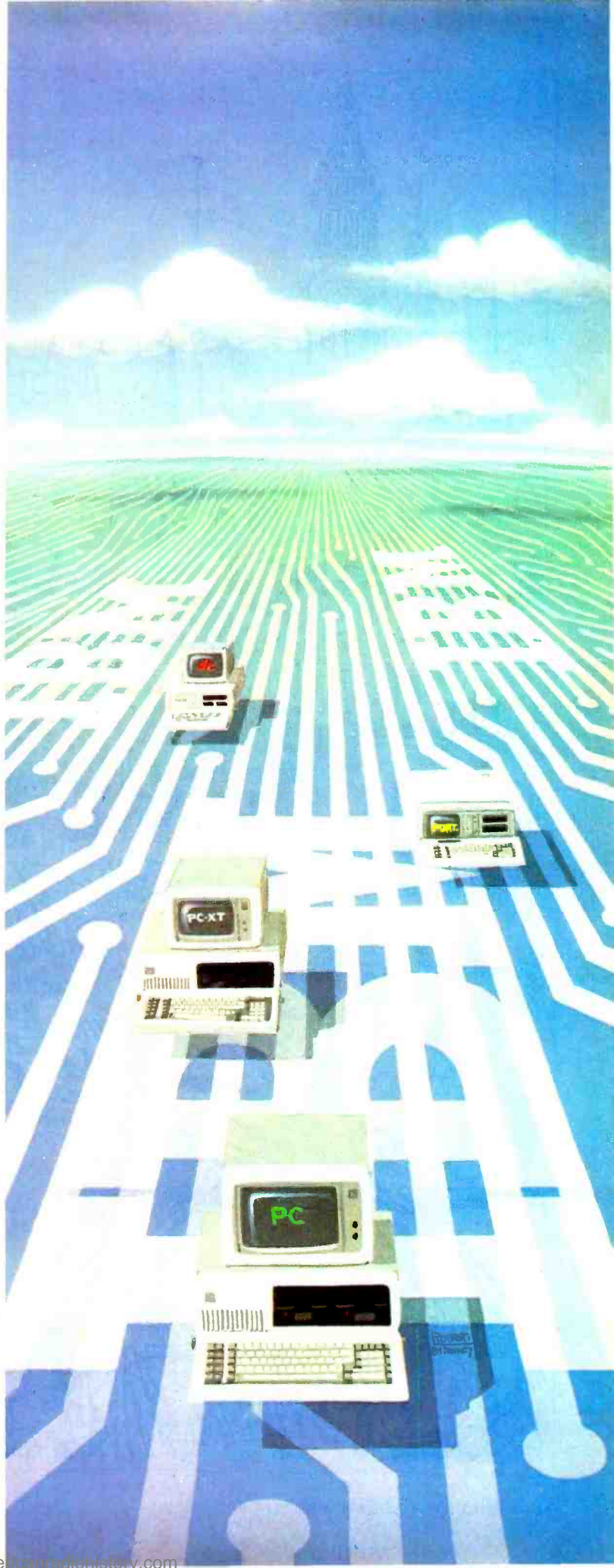

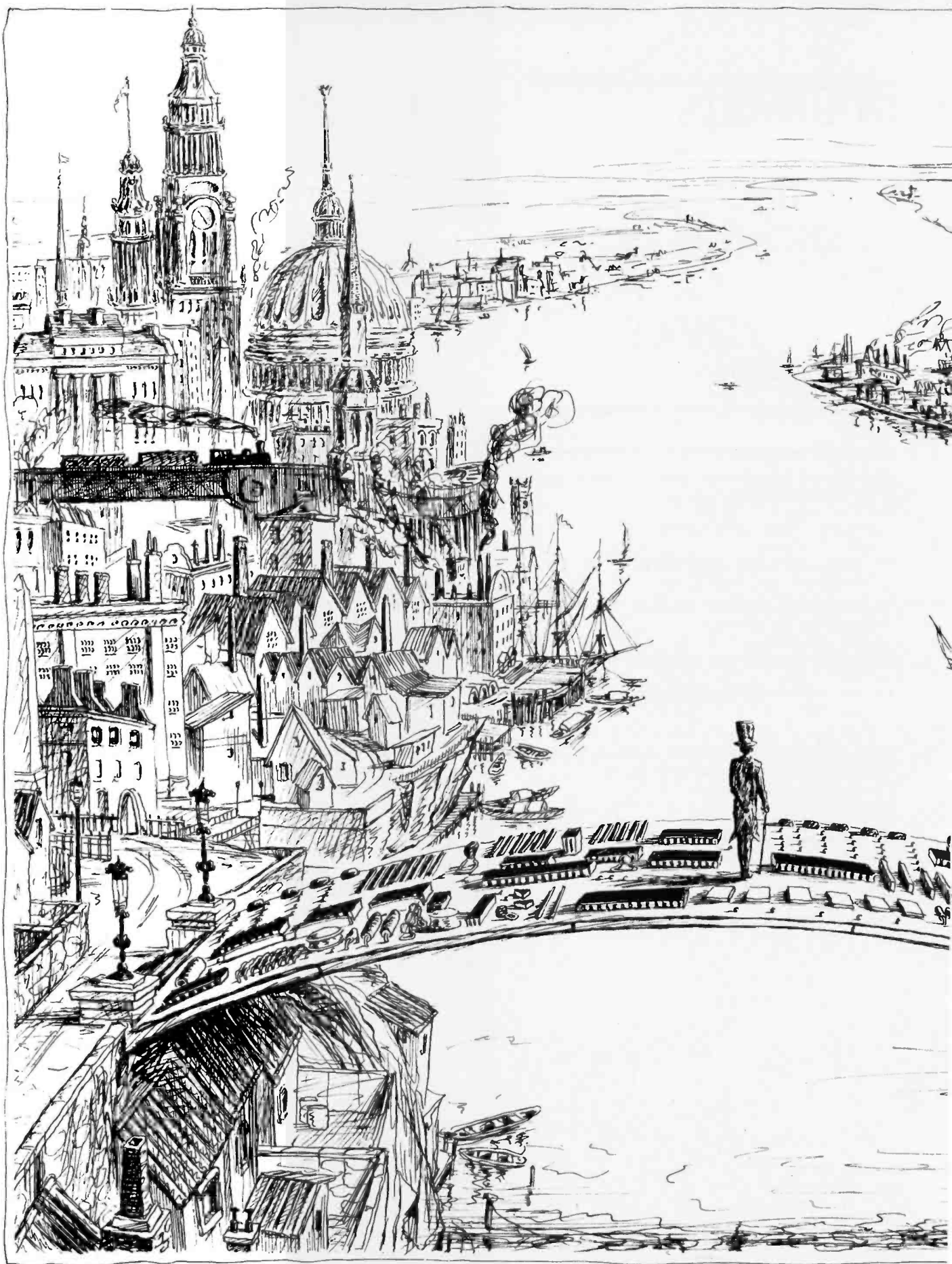

BY CHARLES DANNEY AND TOM FOTH

A TALE OF TWO OPERATING SYSTEMS

Confused about the virtual memory operating system in the new XT/370? Compare it to Microsoft's PC-DOS

In October 1983, IBM announced a new member of its personal computer family, the XT/370, the first desktop design of IBM's mainframe 370 architecture. At the same time, IBM introduced the VM/PC (Virtual Machine/Personal Computer) operating system to take advantage of this new hardware.

VM/PC shares many characteristics with the mainframe operating system known as VM/370—and has several new features as well. The main thing that these two operating systems have in common is known as CMS (Conversational Monitor System).

In VM/PC, CMS acts as the user interface and provides application support facilities, just as it has ever since its first incarnation as a part of CP/67, the predecessor of VM/370, nearly 20 years ago.

We'll focus our comparison of CMS and PC-DOS from Microsoft on three different areas: the file system, command procedures, and system modification and extension. Bear in mind, too, that while Microsoft's PC-DOS is always working in your PC XT/370—even if only for I/O (input/output) operations—VM/CMS is invoked only when you are operating as, or networking with, a System/370 mainframe.

(continued)

Charles Daney (19567 Dorchester Dr., Saratoga, CA 95070) is a senior scientist at Tymshare Inc. Tom Foth (260 Sunset Ave., Fairfield, CT 06430) is part of senior technical support for the Adesse Corp.

ILLUSTRATION BY STEVE SALERNO

*The most important
function of an
operating system
is maintaining
file systems.*

FILE SYSTEMS

Probably the most important function of personal computer operating systems is maintaining file systems. The file system encompasses the conceptual layout and partitioning of disk space, the allocation of data files, the facilities for reading and writing data (sometimes known as "access methods"), and the "catalogs" or "directories" available to the user for keeping track of the files.

PC-DOS assigns letters to disk drives, whether fixed or floppy, as drive identifiers when the system is booted. Although you can change drive letters with the ASSIGN command, the manual specifically recommends against this. Under PC-DOS it's impossible to assign two or more identifiers to distinct parts of the same physical drive.

The mainframe version of VM/CMS assigns virtual disk drives to contiguous portions of disk space on the same physical drive or drives. This space is managed by the control program so that virtual drives appear to be separate devices to CMS, each having its own distinct address. In the 370 architecture, device addresses are three-digit hexadecimal numbers, ranging from 000 to FFF. Hence, 4096 (decimal) possible devices exist, not all of which, of course, are physically present.

Similarly, the VM/PC control program in the XT/370 creates for CMS the illusion of separate devices at specific addresses. These virtual disks are maintained in separate PC-DOS files. Such files can be on either fixed or floppy disks. For example, the virtual disk at address 101 belonging to the user FRED has the name FRED.101.

Because these files are in PC-DOS format and VM/PC actually uses DOS facilities to read and write them, they can be copied, renamed, backed up, and manipulated in general by standard DOS utilities.

CMS data, however, is in a binary format, EBCDIC (Extended Binary-Coded-Decimal Interchange Code), the IBM alternative to ASCII (American Standard Code for Information Interchange), meaningful only to CMS. Therefore, editing or displaying the contents of these files from DOS is not usually productive. But you can very easily move files back and forth between CMS and DOS with the CMS IMPORT and EXPORT commands. These are similar in form to a COPY command except that either the source or the target file is in CMS while the other is in DOS. Options allow for the different end-of-record conventions of CMS and DOS, and conversion between ASCII and EBCDIC is automatic unless suppressed.

As under PC-DOS, these virtual disks are given a file mode letter using the ACCESS command, and the virtual disk cannot be subdivided further with different modes. However, you can change mode assignments any time or assign several different mode letters to the same device. Certain addresses are automatically accessed when CMS is started. For example, the 101 disk becomes the "A" disk by default.

The letter identifier in CMS has a further significance beyond that in PC-DOS: it defines a default "search order." Typically, a command or system utility will search all accessed disks for a requested file whose "mode" is not specified, and the order of search is determined by the alphabetic sequence. This enables the user to keep several versions of the same set of files on different virtual disks and to control which version will be used. Disks "higher" in the search order (toward A) need only contain a subset of all files, consisting of the most recent versions. This function is much like the DOS PATH command, but applies to all file searches.

FILE STORAGE

In both CMS and PC-DOS, files are not stored contiguously on a disk. Instead, a file consists of a number of physical blocks, which can, in principle, be located anywhere on the disk, a definite advantage over earlier operating systems that required a file to be stored as a single segment (or at most a very small number of segments). Files, therefore, need not be preallocated at some fixed size, but can instead grow (or

possibly contract) as required. There is some performance penalty for this, however, in that blocks widely scattered on a disk can cause excessive head movement. In addition, a fair amount of bookkeeping is required to associate disk blocks with files.

In PC-DOS, the most fundamental unit of allocation is the sector, a block of 512 bytes. Different drive types can be formatted with different numbers of sectors per track depending on their physical capacity. For example, PC-DOS on the IBM PC writes either eight or nine sectors per track on floppy disks and 17 sectors per track on a hard disk.

Specific sectors are associated with specific files by means of the file-allocation table (FAT). A FAT is a linear array of entries that are in one-to-one correspondence with space-allocation units on the disk. The space-allocation unit, called a cluster, can be different sizes depending on the type of disk. On a single-sided floppy disk, there is just one sector per cluster, but on a double-sided floppy disks there are two. On a 10-megabyte hard disk, eight sectors per cluster exist. This apportionment is used to keep the total number of clusters, and hence the size of the FAT, small.

The root file directory is a separate table consisting of control blocks, one per file. One field in each control block is the index of an entry in the FAT. This entry corresponds to the first cluster of the file, and it in turn points to another entry of the FAT, which represents the second cluster of the file, and so on.

The PC-DOS design of the FAT places certain limits on the file system. In particular, because each file must have at least one (and usually more) entries in the FAT, there can never be more than 4096 files on a disk, no matter how large it is or how many subdirectories are used.

The FAT design places even more severe limits on the number of files that appear in the root directory. This directory is allocated with a fixed size for a given drive type, and it can never be extended. For instance, on a 10-megabyte disk, the root directory is formatted with just 512 entries. Subdirectories do help to make this limit more flexible, however.

By comparison, the CMS file-allocation

(continued)

IBM XT MADE SIMPLE WITH **mitac**



Engineering Report:
Subject: Mitac Internal Hard Disk Kit ADK-100 I

- Results:
1. 100% software compatible with the IBM XT and IBM PC/XT compatibles model.
 2. High reliability at a lower price!
 3. Bootable BIOS on Eprom can support up to eight drives.
 4. Easy to install.
 5. Can skip floppy drives and directly boot DOS from hard disk.

American mitac Corp.

3385 Viso Ct.
Santa Clara, CA 95054

For more information, please write to us
or call toll free 800-321-8344
(in California call 408-988-0258)

QUANTITY

ECONOMY

SYSTEM
MANUFAC-
TURER

RELIA-
BILITY

QUALITY

TWO OPERATING SYSTEMS

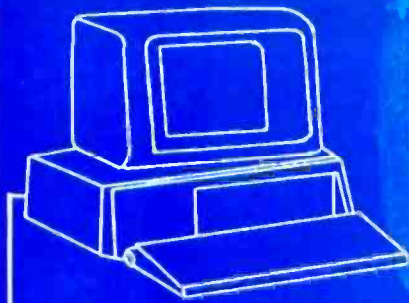

**IBM-PC or PC compatible
IEEE-488 INTERFACE BOARD**

IEEE - 488

VERSATILE

- Implements the entire IEEE-488(GP-IB, HP-IB) standard with high-level commands and standard mnemonics.
- Resident firmware routines support interpreted and compiled BASIC, Pascal, C, and other languages.
- Supports Lotus 123 and most wordprocessing programs.
- One board drives any combination of 15 IEEE-488 peripherals.
- Emulates most Hewlett-Packard controller functions and graphics language statements with single line BASIC statements.
- Supports Tektronix® Standard Codes and Formats.
- Small size - fits the PC/XT short slot.

FAST

- Burst DMA > 800KB/sec
- Continuous DMA > 300KB/sec

PROFESSIONAL

- Clear, concise documentation includes a complete tutorial and source code for interactive bus control, bus diagnostics, graphics plotting, and many other applications.
- \$395 complete. There are no extra software charges.



CAPITAL EQUIPMENT CORP.

10 Evergreen Avenue
Burlington, MA. 01803
(617) 273-1818

IBM is a trademark of International Business Machines Corp.
Lotus 123 is a trademark of Lotus Development

tion mechanism is more complex and overcomes most artificial limits on how many files can be stored on a disk (see figure 1). In CMS, the basic allocation unit is called a block. You can select a block size of 512, 1024, 2048, or 4096 bytes when you format your disks. The smaller number allows for many smaller files without much wasted space, while the larger size permits somewhat faster disk access.

The CMS file directory is similar to that of PC-DOS in that it consists of control block entries, called FSTs (file status tables), describing each file. However, in contrast to PC-DOS, the CMS file directory is not fixed in size. Instead, it is itself just a file, and because there are very generous limits on the size of a file, the directory imposes no practical limit on the number of files a disk can contain. Of course, because any file occupies at least 512 bytes, 10 megabytes of disk space could contain at most about 20,000 files.

Unlike PC-DOS, CMS does not use a fixed-size table like the FAT to map the association of blocks with specific files. Instead, it uses a tree structure. Suppose the disk block size is 1024 bytes. If the file consists of only one block, the FST points directly to the block. If the file has more than one block, the FST points instead to something called a pointer block, which will be 1024 bytes long. Blocks are addressed by full 32-bit words. (Because the high-order bit is a sign, the largest positive number is $2^{31} - 1$, so more than 2 billion blocks can be addressed, 1000 times more than enough for today's largest disks.) Thus, one pointer block can refer to 256 additional blocks. For a larger file in excess of 256 blocks, CMS adds a second-level pointer block that in turn points to as many as 256 first-level pointer blocks, which point to the file's actual data blocks. Hence, with two levels of pointer blocks, a file can contain as many as $256 \times 256 = 65,536$ data blocks. With four levels of pointer blocks, a file can contain more than 4 billion data blocks, which exceeds the number that can be addressed.

Given this technique of associating blocks with files, it's confusing to determine which blocks of a disk are in use. Therefore, information about which disk blocks are actually allocated is kept separately in a system file called the

allocation map. In this file, each bit corresponds to exactly one disk block, and the bit is on if and only if the block is in use (as a file, or pointer block, or whatever). Thus one block of 1024 bytes can describe the allocation status of 8192 other blocks, which is a fairly small overhead ratio.

CMS updates its directory information with a dual-directory technique that never overwrites the old directory. It does this without doubling the amount of space that must be reserved permanently for the directory. By reserving just two disk blocks, including the first block of the directory file which contains the FST entry for both itself and the allocation map file, CMS determines the complete allocation and file information for the whole disk. As the very last step of any directory update, a single record is written in the disk label that indicates which of the two possible blocks is the first of the directory. If a directory update should fail at any step before the last record is written, all of the old information is still intact because it has not been overwritten, and the effect is as if no change at all had occurred. Once the label record is written, all of the new information is in effect. This new information indicates, incidentally, that the old directory data blocks are no longer allocated, so their space isn't wasted.

CMS uses exactly the same technique for writing data. That is, when records are updated in a file, they are always rewritten to a different, unallocated disk block. Only when the file is closed and the directory is updated does this new data "officially" become part of the file. This provides some measure of safety against a database being destroyed due to a power failure, for example. But it also requires that more disk space be available whenever files are updated extensively.

READING AND WRITING FILES

The third aspect of an operating system's file management is its facilities for reading and writing files. CMS and PC-DOS have different file structures. In the latter, at least at the operating system level, a file is usually treated as simply a string of bytes. That is, the file itself does not, in the operating system's view, have a structure consisting of individual records. Instead, the file can be read or

TWO OPERATING SYSTEMS

written sequentially a byte at a time, or it can be accessed randomly by absolute or relative byte number. This method was expanded in version 2.0 of PC-DOS, which introduced new function calls without the "file control blocks" that had forced the programmer to treat files somewhat artificially, as if they were grouped into blocks of 128 records. (At an application level, of course, the file may well have a record structure defined in a variety of ways, such as fixed-length records, embedded record delimiters, etc.)

The CMS file system recognizes two kinds of record structures: fixed-length record format and varying-length. As in PC-DOS, it would be possible to simulate a file as a string of bytes by using a fixed-format file with a record length of one, but this is usually impractical. Furthermore, embedded record delimiters are never used to separate varying length records in a file. The file system keeps track, transparently to all programs, of record positions, a great convenience because applications need never scan for delimiters on input or supply them on output.

A number of slightly different system calls are available in PC-DOS for reading and writing files. Many were in existence before version 2.0 of DOS, and an even larger number were added in that version. The older calls used a parameter list called a file control block (FCB), which required the programmer to deal with an artificial block and record structure even if no record structure really existed in the file. Version 2.0 simplified this by eliminating the FCB. Instead, version 2.0 supplies the file's name (together with optional path) to the "open" function call and returns an identifier called a "file handle" if the operation is successful. This file handle identifies the file in subsequent function calls. The function calls are simplified, basically, to read or write some number of bytes starting at the current position in the file or at a designated position. PC-DOS makes a distinction between "opening" a file, which can be done only on an existing file, and "creating" a file. Recreating an existing file resets it to zero length.

CMS makes no such distinction between opening and creating a file. In fact, you don't even need to open a file

(continued)



"A genuinely helpful productivity tool!"

Jim Seymour: MicroBusiness

**TOUCHDOWN™
KEYTOPS - \$18.95**

Enlarge major control keys for IBM PC, PC/XT, PC Portable, IBM 5291 Display Station and most PC compatibles. Specify model and color: Black or IBM Grey.

ILLUSTRATION: IBM PC TOUCHDOWN KEYTOPS IN BLACK

E-Z TOUCH FULL CONTACT

ASK FOR TOUCHDOWN KEYTOPS OR TOUCHDOWN OVERLAY KITS AT YOUR NEAREST COMPUTER DEALER OR ORDER DIRECT:

\$18.95 (*5520 and Dvorak kits are \$24.95). U.S. orders add \$2.00, Int'l add \$3.50 S/H: AZ residents add 5% sales tax.



**HOOLEON COMPANY
Dept. B
PO Box 201
Cornville, Az. 86325**

VISA/MC CALL (602) 634-4507 or 634-4503

Dealer and Custom Order Hotline: 634-7517

NEW! TOUCHDOWN™ KEY OVERLAY KITS - \$18.95

Re-assign commands on your PC key tops for Dvorak, Wordstar, DisplayWrite 2 and other software. Also for 5251/5291 or 5520* emulation. Overlays are transparent: original commands show through. Rigid, non-glare overlays look and feel like original keytops. Do-it-yourself and blank overlay kits are also available.

TOUCHDOWN CUSTOM OVERLAYS

Re-word key tops to match your software package. Choose your colors! Call or write for info.

Circle 81 on Inquiry card.



The CMS file system recognizes two kinds of record structures.

explicitly. A file will automatically be opened the first time it is read or written. In keeping with the record-oriented operation of CMS, the file calls specify record numbers rather than byte addresses. Although a parameter list must be supplied with the file calls, CMS provides assembler macros to make file easier.

The concept of fixed or variable record formats and the association of specific logical record lengths with CMS files tend to complicate writing general utility programs that must handle a wide assortment of input files. However, an alternative set of system calls, known as

GET and PUT, mask some of this complexity (while introducing complexities of their own). Although they include a number of somewhat exotic options, in their simplest form they shield programmers from concern with the specific format of the file with which they are working. Some of the more useful options give the programmer control over system buffering, which affects performance.

But the most interesting concept that GET and PUT introduce is a level of indirection in file naming. Instead of referring to files in terms of their "real" names, GET and PUT always refer to an eight-character logical name. At run time, this logical name is associated with a real file by means of the FILEDEF command. FILEDEF can also specify other parameters and options, but its most useful function may well be its ability to redirect I/O operations to devices such as the user's console or to a printer. This provides much the same capability that is offered by "standard

input" and "standard output" options in PC-DOS, namely, the ability to write programs that are indifferent to the source or destination of their data. The CMS advantage, of course, is that there can be any number of such "standard" devices instead of just two.

DIRECTORY STRUCTURE

PC-DOS's 2.0 hierarchical directory structure is clearly superior to CMS's. The only advantage of the CMS file directory (apart from its clever implementation) is that it allows file extenders to be eight characters long, instead of the three permitted by PC-DOS. (Each system allows the standard eight-character filename.) Still, 16 characters to fully identify a file is quite meager. In CMS, the only available techniques for logically grouping related files are naming conventions and keeping them on separate virtual disks. Neither approach is particularly satisfactory, either aesthetically or in

(continued)

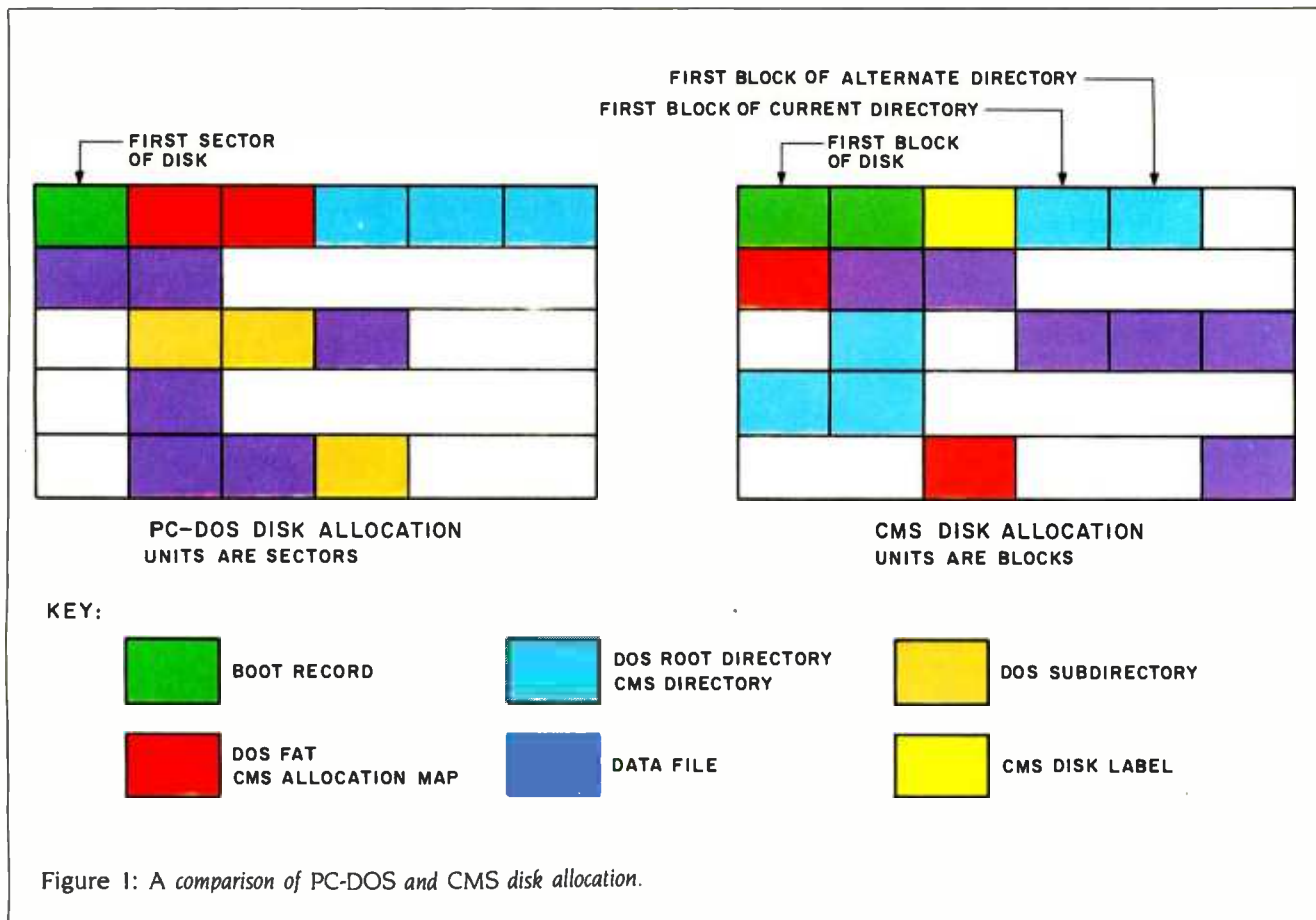



SIMPLE.



SIMPLY POWERFUL.

Basically, we agree with PFS®. If you're looking for some power from software that's essentially simple, there are several PFS packages you might look at.

But if what you really want is genuinely powerful software, that's also simple to use, you'll do better with one new package from Alpha®.

It's called Electric Desk™ and it's word processing, spreadsheet, communications and file management with report writing, all in a single integrated program. What's best, you can run them all at the same time, because it's all on a single disk.

So you not only get to do more work with one Electric Desk than with several PFS's. You also get to do things PFS simply can't. Like jump instantly from a letter to a budget to a customer list, over to a stock

report and back, with just a couple keystrokes. PFS makes you save files, change disks and waste a lot of time if you want to do anything like that.

Plus Electric Desk lets you do something else that's never been done before—save money. Because for \$345.00* you get a complete IBM PC/XT version of Electric Desk with all capabilities included. That's far more computing power than PFS delivers in a handful of packages for about \$600.00*.

So before you decide on software for your business, compare. We think you'll agree. When it comes to serious software, it's not how simple you make it. It's how you make it simple.

Electric Desk. It's the new force in software simplicity.

Also available for the IBM PCjr. for \$295.00.



*Based on manufacturers' suggested retail prices. Electric Desk is a trademark licensed to Alpha Software Corp. by Electric Software, Inc. Alpha Software Corp. is a registered trademark. PFS is a registered trademark of Software Publishing Corporation. IBM is a registered trademark of the International Business Machines Corp. © 1984 Alpha Software Corporation, 30 B St., Burlington, MA 01803. 617-229-2924

practice.

By contrast, the hierarchical PC-DOS structure gives each physical disk a root directory, created when the disk is formatted. The root directory can contain subdirectories, which can, in turn, contain other subdirectories. The complete list of directories from the root to an actual data file is known as the "path."

Such hierarchical structures tend to be more difficult to use, especially for those not very familiar with computers. By defining multiple subdirectories, finding a file can often become a minor project. But on balance the structure is most useful.

Unfortunately, although the concept is excellent, the programming of hierar-

chical directories in PC-DOS has one glaring deficiency: only one directory at a time is the "current" directory, and only its files are ordinarily visible to programs. The PATH command circumvents this problem for the specific case of finding programs to load by allowing the user to specify which directories should be searched, and in which order. It's too bad that the same concept wasn't applied uniformly to all data files. As a consequence of this oversight, certain data files have to be copied into a number of directories.

COMMAND PROCEDURES

Most operating systems provide some sort of command procedure that enables you to group together in a file sets of commands that are used repeatedly to perform some more complex task. PC-DOS treats this as a minor feature. For example, the IBM DOS manual devotes about 20 pages out of more than 600 to the BAT (batch) facility. The analogous facility in CMS is treated at length because of its greater power. Although the following section of the PC-DOS/CMS comparison is slanted toward CMS, these command groups help to explain much of the popularity of CMS.

You can think about batch facilities in various ways. The simplest is the idea of putting commands that would ordinarily be typed on the console all in one file. The command interpreter then simply reads from the file instead of the console in order to drive the rest of the system. Indeed, this is exactly what "batch" implies: the term evolved from the earliest days of computing, when a sequence of programs could be specified in a "batch job" for unattended execution.

In an interactive, as opposed to a true batch environment, other uses of command groups are possible. For instance, command procedures (as they would more properly be called) can be used to reduce the amount of typing required by associating a complex sequence of operations with a single name.

Though PC-DOS batch files can contain sequences of commands, and one batch file can transfer control to another, one file cannot call another as a subroutine. PC-DOS batch files can deal with parameters passed to them but otherwise do not have variables. PC-

Beyond Board-Driven Networks

MultiLink™ is a unique networking system which *doesn't* require costly "Network Interface Boards." Instead, it transforms ONE IBM PC/XT™ (or compatible) into the CPU of a multi-tasking, multi-user network.

Four Workstations for the Price of One . . . with a Software-Driven Network. With MultiLink™, you can utilize up to eight inexpensive terminals as workstations. Four of these terminals cost less than one PC.

MultiLink™ runs under all releases of PC-DOS™ (except 1.0) and certain implementations of MS-DOS®. A wide range of leading programs which include WordStar™, Lotus 1-2-3™, Peachtext 5000™, and dBASE II™ are fully supported.

A Resource-Sharing System. Multiple users are able to access all of your computer's resources, locally, or from remote locations using a terminal with a modem. Features include disk, file, and program-sharing; a dial-in bulletin board, and a comprehensive print spooler.

Make the MultiLink™ Connection Today. Call The Software Link TODAY, and get the whole story. MultiLink™ is immediately available for \$295 and comes with a money-back guarantee. VISA, MC, and AMEX accepted.

MultiLink™



THE SOFTWARE LINK, INC.

8601 Dunwoody Place, Suite 336, Atlanta, GA 30338 Telex: 4996147 SWLINK

CALL: 404/998-0700

Dealer Inquiries Invited



MultiLink™ is a trademark of The Software Link, Inc. Terminals courtesy of QUME Corporation.

DOS includes some very primitive forms of IF, FOR, and GOTO control structures. Finally, PC-DOS batch files can display remarks to the user, but they cannot accept input.

In CMS, command procedures are called EXECs. Like the PC-DOS batch language, an EXEC includes system commands, parameters, and a means for communicating with the user (input as well as output). You can use named variables (with as many as 255 characters). Certain variables are predefined, like the date, time, and the return code from the last command executed. An EXEC generally treats variables like character strings unless you are using arithmetic operations. You can, of course, assign and compare variables. EXEC provides a wide range of built-in functions with special emphasis on pattern matching and string manipulation. Certain types of commands control procedure execution, including basic operations like looping, testing, and branching. One EXEC can call another as a subroutine a fair number of times, and recursive calls are permitted. EXEC also enables you to call internal subroutines and provides error handling and debugging.

The only thing EXEC lacks as a general programming language in itself is a provision to handle arrays of one or more dimensions. You can contrive a somewhat clumsy substitute by constructing variable names dynamically. The control structures are not as nice as those found in a language like C (that is, there is no IF-THEN-ELSE or SWITCH, etc.); nevertheless, for a great many purposes, EXEC can be used for general programming. CMS users tend to employ EXEC procedures routinely, just as PC-DOS users employ BASIC, so much so that the EXEC facility is far more analogous to BASIC than it is to BAT.

Problems with EXEC control structures will be eliminated when the latest version of the language, now called REXX (restructured, extended executor) becomes available in VM/PC, as it is already in VM/370. In addition to improved control structures, REXX is capable of even more powerful pattern matching and string manipulation. It also supports "infinite precision" arithmetic on numbers of arbitrary length. For instance, with a single REXX

command you can parse a data string according to a specified model. REXX also includes extensive debugging aids and function libraries.

One final and important difference in command procedures is that you can't use a PC-DOS batch file to override a command of the same name because the executable command will always be called first. On the other hand, in CMS anyone can write EXEC command procedures that will replace ordinary commands of the same name. This gives users a great deal of control over command naming and syntax.

THE CONSOLE STACK

The CMS console stack is an input buffer. Commands can communicate with each other and with EXEC procedures by reading from the buffer. Many of the most common CMS utilities optionally deliver their output to the stack instead of displaying it to the user. This enables EXEC procedures to determine file characteristics, for example, or to query the system flags. A command called EXECIO even enables EXEC procedures to read and write files via the stack.

The "pipe" is the most powerful inter-program communication technique in PC-DOS. A pipe defines the output of one program to be the input of another. By means of pipes many simple utilities (called "filters") can be combined to build useful applications. Unfortunately, PC-DOS pipes are very inefficient because all they do is pass the data through an intermediate disk file. Programs have had that option all along. Pipes, in a UNIX operating system—from which the technique derives—pass data directly from one program to another.

In addition to parameters, return codes, and the stack, programs and EXEC procedures can communicate through global variables. These are simply named character strings maintained by CMS in any number of separately defined sets and are easily accessed from both programs and EXEC procedures. At the user's discretion, these global variables may remain defined during one session only, or across multiple sessions. Yet another interface enables a program to read and write variables in the EXEC that called it.

Again, PC-DOS has a function similar

to CMS global variables, known as "environment strings." These, however, are defined only until DOS is reloaded. Furthermore, their use is restricted, and higher level language programs or BAT files cannot access these strings easily.

Returning to the original idea of a command procedure—a sequence of commands executed from a file instead of being typed at the console—you may realize that this procedure can apply to any command-driven interaction, not just the operating system command handler. Editors, database managers, communication programs, and indeed most other applications of any complexity are driven by their own private set of commands. Many such programs have their own batch processors. With EXEC in CMS, these private command sets are unnecessary because, by using the CMS subcommand interface (SUBCOM), such applications can use the EXEC interpreter to handle their own command language for them. In addition to making it easier to develop applications, the subcommand interface makes life easier for end users by requiring them to learn only one procedure language.

The text editor provided with CMS, called XEDIT, makes good use of SUBCOM (subcommand) in a number of ways. XEDIT EXEC procedures, also known as macros, allow users to tailor the editor command language to their own preferences. Although XEDIT is not a true word processor, many procedures have been written as macros to perform word-processing functions.

You can use XEDIT to manage the display screen because of its built-in full-screen primitives and its interaction with EXEC command procedures. You can also use XEDIT in applications that have little to do with editing. For instance, the CMS FILELIST command, a full-screen file-directory management utility, is built on XEDIT.

OPERATING SYSTEM TAILORING

EXEC command procedures, and even BAT files to some extent, are available to all users for customizing an operating system. In both PC-DOS and CMS user-written programs can be used in much the same way as system commands, so extending the operating system by adding new commands is quite easy. In both

(continued)



MICRO MART

Atlanta, Charlotte, Washington D.C.,

Networking/Protocol Conversion

PC Turbo by ORCHID

80186 Co-processor Board • Speeds Up PC 5 Times

IRMA "STILL A BEAUTY" REPLACES 3278's WITH PC's/IRMALINE

PC Blossom 64-384K Multifunction Board W/Opt. PCnet Interface

BLUE LYNX 5251/3276 EMULATOR

FORTE DATA 3278/3279 Emulator w/SIIG, Graphics Capability

SNA & BISYNC • 3780, 5251, 3274

Printers

AMDEK AMPLOT II Supports LOTUS 1-2-3 Graphics \$799

Houst. Inst. Plotters & Digitizer CALL!

DOT MATRIX

EPSON FX80 & 100 (160 cps) Best Price!

EPSON RX80T or F/T Best Price!

EPSON RX100 Best Price!

EPSON LQ 1500 NEW! Letter Quality in a Dot Matrix Best Price!

ProWriter \$339

Prism Color IBM's Choice for LESS, 132 Col. (200 cps) Color Graphics \$1495

OKIDATA 92 & 93 Opt. IBM Proms 160 cps Best Price!

OKIDATA ML84 200 cps Best Price!

OKIDATA 2410 Pacemark (350 cps) Best Price!

TOSHIBA P-1351 & 1340 Best Price!

GEMINI Full Line of StarMicronic Printers Starting at \$285

T.I. 855 24 WIRE PIN HEAD. NOW IN STOCK! Best Price!

NEC P2 & P3 180 cps Best Price!

DIABLO P38 1400 CPS) \$1695

LETTER QUALITY

NEC SPINWRITERS 2050, 3550 & 7730 Best Price!

DIABLO 620, 630, 630 ECS Best Price!

C-ITOH Starwriter (40 cps) Printmaster (55 cps) \$1055/\$1455

QUME SPRINT 11/40 PLUS SPRINT 11/55 PLUS Best Price!

LQ Feeders Great Cut Sheet Feeders for NEC 3550 & C-ITOH Starwriter SAVE!



Floppy Disk Drives

TANDON TM 100-2 FULLY IBM PC COMPATIBLE \$209

CALL FOR QUANTITY PRICING
1/2 HT. DISK DRIVES TOP NAMES \$179

SOUTH'S LARGEST SUPPLY • DEALER INQUIRIES INVITED

Chips

CALL FOR QUOTE ON QUANTITY CHIP PURCHASES
INTEL 8087 High Speed Math Coprocessor \$175

64K RAMCHIPS \$55/\$159
(64K-9 Chip/Upgrade Kit) (192K-27 Chip/Upgrade Kit)

Hard Disks

Peachtree Peripherals P-10 Industry's Best Buy • 10 Meg/F. Auto Boot • Runs W/Out Ext. Power Internal or External Installation

SYSGEN 10 & 20 MEG/F W/Streamer Tape Faster Streaming & Formatting CALL!

INFAX Bernoulli Box • 10 MEG Removable Cartridges • Double Drives CALL!

DAVONG 10 MEG/F 15, 21, 35 Available External CALL!

SYSGEN IMAGE Streamer Tape Back Up For Your IBM XT CALL!

ALL NAME BRANDS AVAILABLE NOW! BEST PRICES!!
IF YOU DON'T SEE IT — CALL!

Multifunction Boards

ULTRA PAK Monographics • Serial Ports • Par. Port Expand. RAM (384K) • Floppy Cont. • Opt. Color CALL!

#1-384K 63-384K • Clock Ser. & Par. Pts. Ram Disk • Spooler • Opt. Game Pt. Best Price!

#1 MultiCard Max: 8 Func. (64-512K) W/Opt. Game Pt. Best Price!

#1 I/O Card Ser. Clk. Spooler Ram Disk (Opt. 2nd Ser. Par. & Game) Best Price!

QUADBOARD New Version 64-384K Best Price!

CAPTAIN By Tecmar. 64-384K \$269

SEATTLE RAM + 3 0-256K • Ser. • Par. Flash Disk • Clk. • Spooler \$199

J-RAM II 512K Multifunction Best Price!

PROFIT Systems 64-512K RAM Plus & Elite \$299/\$680

BABY BLUE II 64-256K • Z808 • Par. • 2 Ser. • Clk. RAMdisk • Spooler • Extra Software Best Price!

PC Blossom ORCHID's 6-Pak Clone with Optional PCnet Piggy Back Starting at \$275

MAYNARD SANDSTAR Floppy & Hard Disk Controller Cards Best Price!

Miscellaneous

Keytronics 5151 New Improved CALL!

MOUSE Optical Type LOTUS & VisiOn Compatible By Mouse Systems \$209

CURTIS Monitor Pedestal Keyboard Extension Cable, Monitor Extension Cable CALL!

MICROFAZER (8K-128K) Stack Spooler Starting at \$139

BACK UP Power Supply 200/425/625 Watts CALL!

ISOBAR Surge Protectors • With Great Filtering Via Isolated Outlet Pairing • 4 & 8 Plug Starting at \$55

Advertised cash prices subject to change without notice.

Tampa, Ft. Lauderdale, Orlando, Louisville, New Orleans

Microsoft Project

ACCOUNTING

- IUS A.R., A.P., G.L., Inventory, Order Entry, Payroll . . . **Starting at \$299**
- Peachtree Accounting A.R., A.P., G.L., Payroll Job Cost, Inv., Order Proc. **CALL!**
- Dow Jones Entire Line Now W/Full Acct., Comm. & Sales Plan. Complementing Fine Stk. Mkt. Pkg. **CALL!**

MISCELLANEOUS

- Open Access Spreadsheet, 3-D Graphics, Word Processor, Time Manager & Comm. in One Pkg. . . . **\$299**
- Decision Manager All New Integrated Software by Peachtree . . . **CALL!**
- VisiOn Applications Manager Calc*Word*Graph*Query **CALL!**

MICROSOFT PROJECT CALL!

QUICKCODE/dGRAPH/dUtil CALL!

Lattice C-Compilers Version 2.1 Supports One Meg RAM on PC **\$299**

MICROSOFT COMPILERS CALL!

DIGITAL RESEARCH COMPILERS CALL!

Norton Utilities A must for Every IBM PC **\$59**

ProKey 3.0 Rossoft **\$95**

Copy II PC **\$35**

ATI Training Critics Choice Software Tutorials **\$49**

Set-FX PLUS Epson FX Series Control Pkg. **\$45**

Sideways Inverts Prinout **\$49**

PC Paint Brush Amazing Mouse Driven Graphics W/Screen Dump Utility **\$129**

Chart-Master/Sign-Master **CALL!**

"CAD Systems" Best Selection Available of Computer Aided Design Graphics **CALL!**

ENERGRAPHICS Hot New Graphics Package **\$269**

CROSTALK XVI Microstuf **CALL!**

SMARTCOM II Hayes **\$99**

 **Modems**

HAYES SMARTMODEM 300, 1200 & 1200B **CALL!**

NOVATION MICRO MODEMS, W/Access 1-2-3; Internal w/Crosstalk XVI **Starting at \$99**

RIXON 1200-4800 BAUD*IBM PC Compatible **CALL!**

Signalman Mark XII 300-1200 Direct Connect **\$259**

 **Graphic Cards**

HERCULES Monochrome Graphics Supports LOTUS 1-2-3 **CALL!**

PLANTRONICS Color+ Biplaner, Super HiRes With Color Magic **CALL!**

Graphics Master Tecmar-Color & Mono Graphics Supporting Lotus **Low Price!**

QUADCOLOR I & II **CALL!**

ULTRA PAK Graphics*Serial Port(s)*Par. Port Expand. RAM (384K)*Opt. Color & Floppy Cont. **CALL!**

STB Graphix Plus Color & Mono Graphic*Par. Port RAM Disk*Spooler*Lite Pen Port*Opt Clk/Cal **CALL!**

Multigraph 132 Col in Mono W/Graphics 720h x 350v Color Graphics to 640h x 400v*Opt. Par. Port **\$375**

Amdek MAI Color Graphics/Monochrome/Par/Prt Port/8 Pgs Storage/HALO/Light Pen Port Super W/Color IV **\$345**

WORD PROCESSORS

MultiMate 3.22 "WANG" Style Word Processor with Spelling Checker & All New Tutorial **\$289**

SAMNA II & III Deluxe Word Processing at Best Pricing **CALL!**

Microsoft Word W/&W/o Mouse*4th Gen. Word Processor*Use Up to 8 Windows **CALL!**

VOLKSWRITER DELUXE **\$189**

WordStar ProPack Now W/Free Tutor! CorrectStar, MailMerge **CALL!**

WordPerfect by SSI* Available Now by Popular Demand **\$299**

Easy Writer II Systems Include Speller & Mailer **CALL!**

Peach Text 5000 Personal Productivity Series **\$179**

DATA BASE MANAGERS

HARVARD PROJECT MANAGER **CALL!**

Day Flo Super new data base **CALL!**

R:base 4000 or 6000 Report Writer & Clout Microrim **Starts at \$329**

Power-base GMS Systems*Combination of Relational & Hierarchical Data Base **CALL!**

Knowledge Man Ver. 1.06 Now Available for this Highly Acclaimed Data Base **\$295**

dBase II & III Ashton Tate*Standard plus New "C" Language **CALL!**

Infoscope IBM Critically acclaimed data base **CALL!**

SPREADSHEETS

MultiPlan Microsoft*New Low Pricing **CALL!**

SuperCalc 3 Superior Graphics to LOTUS **CALL!**

 **Monitors & CRT's**

PGS-MAX 12 Amber*Runs off IBM Mono Card*720h x 350v **Best Price!**

PGS SR-12 690x480*Non-Interlaced Mode RGB W/HiRes Text, W/Dual Scan Cd **Best Price!**

PGS-HX 12 HiRes 690 Dot RGB **Best Price!**

QUADCHROME HiRes RGB **Best Price!**

AMDEK COLOR II + **\$399**

AMDEK COLOR IV 720 Dot **\$549**

AMDEK 300 A/300G 12" **\$149/\$139**

AMDEK 310A Amber 12" Improved Alternate to IBM Green Screen **\$185**

Wyse Terminals WX300,100,75,60,50 Entire Line In Stock **Best Price!**

ORDERS ONLY
1-800-241-8149

TECHNOLOGY CORPORATE CAMPUS
3159 Campus Drive • Norcross, GA 30071

For Information	1-404-449-8089
Technical Support	1-404-446-3836
Telex	880497

MICRO MART™

operating systems you can even replace some, but not all, system commands by writing a program of the same name. In PC-DOS, these system commands are the external commands that run as COM or EXEC files, as opposed to those that are part of COMMAND.COM, the command handler. Similarly, you can easily replace CMS system commands that aren't part of the CMS nucleus.

Sometimes, however, you may require more fundamental extensions or changes. In order to modify PC-DOS or CMS, you must first understand the types of interfaces they provide. These interfaces are strongly influenced by processor architecture (8088/8086 and 370, respectively).

In the 8088 architecture, central processor interrupts are generated by various unpredictable events, like I/O events and division by zero. An interrupt can also be generated under program control using the INT instruction. The 8088 assigns a number from 0 to 255 to each type of interrupt it recognizes and maintains a table of 256 four-byte entries starting at location 0, called the interrupt vectors. Each 4-byte entry is the address of a routine that receives program control when its interrupt is generated. Some of these interrupts are defined by the hardware, more are defined by PC-DOS and the IBM PC BIOS (basic input/output system), and some are reserved for use by application programs.

For defined interrupts, the interrupt vector points to routines in DOS or BIOS. An application can take control of any of these interrupts simply by setting the appropriate address in the interrupt vector, a process called interrupt stealing. If an application wants to modify or replace an existing DOS or BIOS service, it takes over or "front-ends" one of the defined interrupts. An application that does this must be prepared either to do most of what DOS or the BIOS would normally do with the interrupt or to eventually pass the event to DOS or the BIOS. If the application merely requires adding a new service, it takes over an unassigned interrupt. This can, of course, lead to incompatibilities among independent applications that take control of the same interrupt.

Not all DOS functions are mapped to

distinct interrupts because only 256 are available. Indeed, DOS reserves only 32 interrupts for itself, 20 hexadecimal through 3F hexadecimal. One interrupt (21 hexadecimal) acts as the general function call interface; specific DOS functions are usually selected by placing a code in a register and calling INT 21 hexadecimal. In order to take over the DOS function, an applications program has only to trap interrupt 21 hexadecimal and watch for the function code or codes it is interested in; all others are passed on to the usual DOS code.

The 370 architecture has only six types of interrupts: processor restart, external (including timers or other central processors), I/O, program checks (instruction error), machine checks (hardware trouble), and supervisor call (SVC). A table of six entries contains program status words (PSWs) that are to be loaded when a specific type of interrupt occurs. This transfers control to the appropriate interrupt handler. Just as with the 8088 interrupt vector, programs can replace the system's PSWs with PSWs that point to their own code. This process is called PSW stealing.

The supervisor call instruction is a very close analog of the 8088's INT, and it, too, provides 256 codes. The single significant difference is that the subroutine addresses associated with each code are not located using hardware. Instead, the operating system must look up the addresses in a table, which is not directly accessible from an application. This can take more time and, more important, makes it harder for an application to selectively front-end specific system services. Fortunately, CMS provides an interface to handle selected supervisor call codes that usually meets application needs.

EXTENDING PC-DOS

You can extend PC-DOS by means of exits, interrupt stealing, and device drivers. The distinction among these is roughly as follows. Exit routines are specifically intended to be called by the operating system when certain events occur or during the execution of certain functions. Interrupt stealing applies when an applications program wishes to replace an existing DOS or BIOS service with its own code. Device drivers are usually programs that DOS will call in order to

manage I/O to otherwise unsupported types of hardware.

In PC-DOS, exit routines are just specialized interrupt handlers. They are associated with specific interrupt numbers and are called by DOS using INT. An example of a PC-DOS exit is the Break exit. When you request a "break" or halt in the execution of an applications program, the operating system will first call the application's Break exit, if one was specified. When invoked, the exit routine can determine if the application is in an appropriate state for termination. If not, the exit routine can warn you and return control to the application. It can also do end-of-application processing (such as closing files) and then terminate the application. When the application returns to PC-DOS, these exit routine addresses are reset to default values.

In order to extend the operating system by interrupt stealing, the application simply replaces one of the interrupt vector addresses with the address of its own routine. A common example of this is a disk emulator (RAMdisk). A disk emulator is first invoked as an ordinary command. It then steals the appropriate disk I/O interrupt addresses and returns to DOS in such a way that its code is left resident. When interrupt calls are made for disk services, the disk emulator examines them. If the request is for a disk the routine is not emulating in storage, the routine passes the request on to the operating system routine. If, on the other hand, the request is for one of the emulated disks, the routine maps the request to a read or write operation from memory.

Another interrupt steal might replace the address for interrupt 21 hexadecimal. A routine could intercept all file requests, for example, and, for files where no path is supplied by the caller, search a set of default paths. Finding the file in one of the default paths, the routine would append the appropriate path information to the request (much as the PATH command does for commands) before passing the request on for normal PC-DOS processing. This overcomes the difficulty mentioned earlier of searching for files in multiple sub-directories.

PC-DOS provides several services especially designed to assist applica-

(continued)



You won't get over what this 350 CPS printer does for under \$2,000.

When you see what the CI-3500 Serial Printer can do, you might not believe it's priced under \$2,000.

Besides giving you data processing printing at 350 CPS, the CI-3500 delivers letter quality printing at a rapid 87 CPS—more than twice the speed of most daisy wheel printers.

And you also get the capability for high resolution graphics, up to 240 X 144 DPI.

The office friendly CI-3500 is as flexible as it is versatile, especially for a table top, workstation printer. For example, a convenient interface cartridge system allows you to change your printer interface simply by changing cartridges.

A DEC-LA100[®] compatible cartridge is standard, but additional cartridges are available for interfacing with other systems, such as the IBM PC.

A similar font cartridge system accommodates multiple fonts and character sets, so you can avoid costly PROM installations.

The CI-3500 Serial Printer for under \$2,000. Whatever you need in a printer, you won't get over what it will do for you. To find out more, just write or call CIE Terminals, 2505 McCabe Way, Irvine, Ca. 92714-6297. (714) 660-1421.

Or call toll-free 1-800-854-5959.
In California, call 1-800-432-3687.

CIE TERMINALS
A CITECH ELECTRONICS COMPANY

Circle 34 on inquiry card.

[®] DEC LA100 is a Registered Trademark of Digital Equipment Corp.
[©] CIE TERMINALS, INC. 1984

*The "pipe" is the
most powerful
interprogram
communication
technique
in PC-DOS.*

tions that do interrupt stealing, such as services that look up the current address of an interrupt or those that replace one interrupt address with another. Memory management is another service required by interrupt-stealing applications.

PC-DOS device drivers, new as of version 2.0, may be the most powerful of the three techniques of system extension. Device drivers are routines that enable applications to replace the PC-DOS logic that handles I/O devices. You can use device drivers as unsupported fixed-disk controllers, as disk emulators, or to read hardware clocks.

Unfortunately, the name of this facility has led users to believe that it is useful only for device handling, but this is simply not the case. Consider a service subroutine (for example, a sort package or database package) that you would like to call from several different languages and, in all cases, use the same calling interface. Rather than trying to interface the routine with several different calling formats, you can call the routine via a sequential I/O request. The same routine will work equally well from any language that supports arbitrary device names.

Device drivers can also ensure data security. You can use a device driver to front-end (take control of) disk I/O. The driver could trap all output commands and first write them to a cartridge tape, providing you with an audit trail. If the disk failed, a utility could restore data from the audit tape to the disk. The beauty of this approach is that the audit feature is completely transparent to the applications program.

EXTENDING CMS

As in PC-DOS, a CMS application can completely take control of one type of

interrupt by replacing the hardware-defined program status word associated with the interrupt. In principle, this enables CMS application programs to do I/O any way they want, alter the meaning of any system service call, etc. But it is rather a brute-force approach, particularly since there are so few distinct interrupt classes, and the applications program becomes obliged to duplicate a lot of system code, even if it later elects not to handle the interrupt.

To surmount this problem, CMS makes much more use of exit routines to handle specific situations. For example, a system call enables an application to handle I/O interrupts for specific I/O devices. You can define another exit routine to handle all external interrupts (so this amounts to little more than front-ending the external interrupt program status word). You can also define individual exit routines for most of the possible supervisor call codes. The exit routine support for program checks (for example, division by zero) is particularly useful, in that the operating system provides services that allow several interrupt routines to be "stacked," making it much easier for multiple applications that use the same sort of interrupt to coexist.

A number of other CMS exit routine interfaces are not associated with specific interrupts. One such routine gets control when a program is terminating abnormally because of a malfunction. This routine can attempt to close files and perform other clean-up chores, or even attempt to recover from an error. Unfortunately, if you cancel a program, you'll get no opportunity to recover or rescind the order as you do with DOS Break exit. You can define another exit routine through the FILEDEF command to receive control in order to handle GET and PUT file requests, so that an exit routine is capable of acting much like a DOS device driver. You can use exit routines of this sort to read and write storage belonging to other programs, and therefore provide another kind of interprogram communication technique. UNIX-like pipes could be programmed in this way.

CMS also provides you with a function called "nucleus extension," enabling you to replace some CMS nucleus commands with your own.

Two special supervisor call codes, 202

and 203 (decimal), invoke CMS functions in a way similar to the way DOS INT 21 hexadecimal does. The specific function being requested is identified to SVC 202 by an eight-character name, and to SVC 203 by a number. Only SVC 202 functions can have nucleus extensions.

To process an SVC 202, CMS first consults an internal table to see whether the function is in the nucleus. If so, CMS calls it. If the function isn't, CMS looks at the accessible disks for a file by the same name as the specified function and whose type is MODULE. If such a file is found, CMS loads and executes it. If no MODULE is found, CMS consults a table of synonyms and abbreviations that the user has supplied to see whether it should try an alias. If CMS finds an alias, the search starts over with the new name.

When an application defines a nucleus extension, its name is added to a special list, which is searched before any of the other lists and tables. The name can even be added to the list more than once (by different applications), and only the first instance will be used. In this way, you can extend CMS nucleus routines, with one unfortunate exception. The CMS file read and write services cannot have nucleus extensions. (Someone decided it was more important to handle files by a very fast path.) However, because these routines are located via addresses that are modifiable by applications, even this situation can be handled.

No such relatively simple techniques are available to replace or enhance PC-DOS internal commands. Because such commands are part of COMMAND.COM, you would have to replace all of COMMAND.COM with an application-supplied module. You can, in fact, do this, using the SHELL command in the CONFIG.SYS file, which is consulted when PC-DOS is loaded. (Device drivers are specified similarly by DEVICE commands in the same file.) However, you must supply a complete replacement COMMAND.COM or (more likely) a shell program that first examines commands for the ones it wants to handle before passing the rest to the real COMMAND.COM. But this requires very sophisticated programming, and the lack of adequate documentation of the interfaces makes it difficult. ■

The new HERCULES[™] Color Card gives you the parallel port IBM[®] forgot—for \$1 more.



And it fits into the XT's short slot.

The new Hercules Color Card gives you these five important features in a color graphics card.

1. A parallel printer port. If you buy IBM's color card, you won't get a parallel port for a printer. Ugh. You've just wasted a valuable slot for an extra printer card.

2. It's short. Our new Color Card uses advanced gate array technology to reduce the chip count by 30 and use less than half the board space IBM does. Which makes the new Hercules Color Card perfect for the short slot in an XT.

3. Fully IBM compatible. Any program that runs on IBM's color card will run on the new Hercules Color Card. With RGB or composite video, any IBM compatible monitor will work too.

4. Hercules Graphics Card compatible. If you have a Hercules Graphics Card (model GB101 or later), or plan to buy one, an ingenious software switch on our new Color Card allows both cards to be kept in the system at the same time.

5. Low price. At a suggested list price of \$245, the new Hercules Color Card has all these features for only \$1 more than IBM's color card.

Call for our free information kit. See why the company that made the first graphics card for the IBM PC still makes the best.



**Hercules. We're
strong on graphics.
800 255 5550 Ext. 428**

Address: Hercules, 2550 Ninth St, Berkeley, CA 94710 Ph: 415 540-6000 Telex: 754063 Features: 2 year warranty Foreign distributors: Compuserve/Canada; Reflex/U.K.; Computer 2000/W. Germany; Edisoft/France; SourceWare/Australia. Trademarks/Owners: Hercules/Hercules Computer Technology; IBM/International Business Machines.
This price comparison is based on the Suggested List Price as of 2.22.84 for the IBM Color Graphics Adapter.

One good idea



deserves another

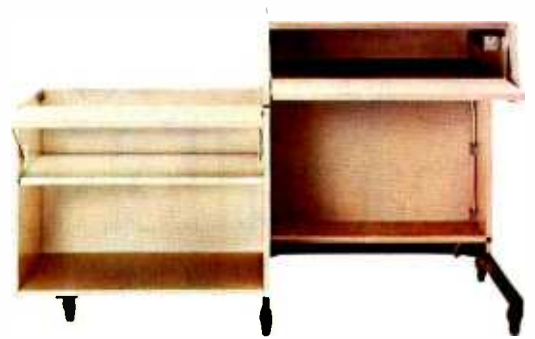

and another



and

another.



At IBM, we've been working to help your business keep up with its computer needs.

That's why we developed our innovative line of IBM Personal Computer Furniture. You'll find work stations, tables and chairs that are custom-designed to accommodate Personal Computers, as well as the people who use them.

And best of all, you'll find IBM's PC Furniture available in a variety of prices designed to accommodate your budget.

The IBM *Synergetix*® PC Work Station (pictured in pearl white) provides a convenient and compact workspace for the Personal Computer. In addition, it's completely mobile, so you can move it from office to office. But most important, the entire unit closes and locks, so you can secure and protect your system.

The IBM PC Table (pictured in walnut) is a stationary unit that's economically priced. It has the same durable construction as our PC Work Station, along with some basic security features. What's more, it's also perfect for the IBM PCjr.

The IBM PC Chair boasts a price tag you don't have to sit down for. This ergonomically engineered seating comes equipped with fingertip adjustments and features a contoured backrest for greater comfort and support.

You'll find our IBM PC Furniture in a variety of attractive colors at your IBM Product Center. The IBM PC Work Station is also available at participating retailers. To find out the location nearest you or to order by phone, call *IBM Direct* toll free at 1 800 IBM-2468, ext. 104W.

IBM Personal Computer Furniture. It's designed with you and your PC in mind.

THE FUTURE OF UNIX ON THE IBM PC

BY RALPH A. PHRANER

*With UNIX available for the XT, the question is not
how to employ it, but how soon*

Microcomputers seem to be moving away from the era where running a separate program for each specific task was considered optimal usage of available computing resources. Manufacturers are offering integrated environments, multitasking operating systems, and hardware enhancements with dedicated software in hopes of gaining a clear position in future markets. The exact nature of the newly emerging working environment is still unclear, but the molding forces of market demand will decide, from many approaches put forward, how to enhance the productivity of the micro-computer workstation.

IBM's Personal Computer brought about a dramatic change in the micro-computer marketplace with its 640K bytes of addressable memory, 16-bit processor, and 10 megabytes of hard-disk storage in the XT model. Backed by IBM's marketing savvy and reputation for reliability, the PC XT captured a large portion of the workstation

*Typically, a concurrent
system maintains
several independent
virtual environments,
each containing a
complete program,
either ready to run or
already executing.*

market of corporate America. Until recently, however, the software available has been limited to memory upgrades of 8-bit microcomputer designs. Single-tasking sequential processes have been the rule.

CONCURRENT FUTURES

Concurrency, the ability of a computer to do two or more projects at once, is both an efficient and an economical approach. The ability of a system to allow

the user to begin another job before a previous one is completed, to suspend one task to work on another, and to automatically transfer data among several independent tasks transparently makes valuable workers, from executives to programmers, much more productive.

Typically, a concurrent system maintains several independent virtual environments, each containing a complete program, either ready to run or already executing. In some cases, the number of concurrent tasks is limited, with all tasks kept resident in RAM (random-access read/write memory). In others, the entire operating environment is written to a reserved area on the system's disk when a higher priority for system resources is recognized by the processor. Each program is guaranteed a

(continued)

Ralph A. Phraner is an independent micro-computer product development and systems software consultant. He can be reached at 516 Shrader St., San Francisco, CA 94117.

fair share of computing time by operating system scheduling.

THE IBM PC MARKETPLACE

The success of the IBM PC is largely due to its acceptance by the business community. From sole proprietorships to Fortune 500 corporations, the largest market for microcomputers is the business market. Two requirements for many of these systems are that they be able to share data among multiple users, whether across the building or across the country, and that they be able to link to mainframes in existing data-processing environments.

At present, most of the tasks necessary for a microcomputer to be used with a large host computer system are possible—but only one at a time. This sequential nature of task execution creates conditions in which the microcomputer is forced to wait for the mainframe to finish just as if it were a dumb terminal, not a powerful, intelligent workstation. The operator is forced to wait unproductively. To overcome this bottleneck and better integrate into existing computer networks, individual workstations should include these features:

- Transparent communication with different machines and locations
- A consistent command set across different machines and applications
- Local concurrency to allow background processing
- Increased overall combined system performance as a result of off-loading data entry and selected processing tasks to a local workstation

Such a system would let you switch freely from task to task as often as the flow of work required, incurring no penalty in either time or concentration to re-establish a previous work project. You wouldn't have to terminate one task to work on another. You could recall a previous project in exactly the state in which it was left. A major candidate for approaching this ideal is the IBM PC running UNIX.

THE ROLE OF UNIX

The UNIX operating system, pioneered

by Bell Laboratories, is heralded as the answer to increasing the usefulness of microcomputers, both in a large data-processing environment and at individual workstations. A closer look at this concurrent system will help put alternative software solutions in perspective.

There is little doubt that UNIX is destined to play a major role in microcomputers within the next few years. It is estimated that the annual market value of UNIX systems will exceed six billion dollars within two years, with an estimated one million systems running UNIX in service by 1986. From micro to mainframe, UNIX is available on a broader range of computer hardware than any other operating system. Over a thousand different software packages are available for application use under UNIX, including word processors, accounting systems, financial-planning packages, and some of the most powerful database-management software available. Most of these software packages were originally designed to run on minicomputers and are thus powerful and sophisticated migrants to the microcomputer domain.

UNIX was created as a response to a programmer's need for an interactive software-development environment. Since the first PDP-11 release to universities in 1973, UNIX has gained popularity as a result of its use as a computer science research tool. Many of the popular enhancements were initiated in universities, which have provided a whole generation of programmers and computer science professionals who are enthusiastic about UNIX.

Over the years, UNIX has evolved into a sophisticated environment for document creation and management, file manipulation, and communication. It may also be the finest system for software development yet invented. The UNIX style of software development is to generate specialized software tools that speed subsequent applications efforts. For portability, the operating-system interface has been isolated, identified, and grouped by function.

Following are some of the major features and benefits of UNIX:

- Execution with an interactive user interface rather than by batch-job submission. However, interac-

tive users may easily initiate substantial batch-job sequences to be run in the background.

- Operating-system and applications software portability through a relatively small number of standardized function calls.
- Multiuser operation with provision for multiple background processes and facilities for system user accounting.
- A hierarchical file system with directories and removable volumes. Links and aliases let you use several names for one utility program or physical file.
- Stream- rather than record-oriented system I/O (input/output). All files and devices look identical to the user.
- Console input and output redirection to any legal device or file.
- Replaceable command-line interpreters. The UNIX shells provide flexible command language, variables, and commands from files. Any other user-supplied shell may be substituted.
- Security implemented by user name and group protocols. FIPS data-encryption standard (DES) available for user files. Encrypted password security protects operating system access.
- Pipes to pass data between concurrent tasks and group simple modules for accomplishing complex operations.
- Many multiprocessing system utility programs include a wide range of separate capacities.
- Text-processing and office-automation utilities including two powerful calculators, a calendar for reminders and provision for scheduled future program execution, formatting for phototypesetter and line printer, two or more editors, formatters for tables and mathematical equations, spelling and writing style checker.
- File-processing utilities enable combine, split, compare, contrast, search, modify, compression, format translation (including 370/EBCDIC), encryption, and tabular data manipulation and processing.
- Software-development tools include translators for various meta-languages (yacc, lex, and m4) and

languages (typically C and FORTRAN 77), subroutine libraries, object-code archiving programs, execution performance profiling, assemblers, linkage editors, debuggers, utilities SCCS and make to manage large numbers of object modules or source/text files, and C language utilities to check source for correctness and print formatted listings.

- Communications utilities for mainframe remote-job entry and dial-up, file transfer, and electronic mail among UNIX facilities.

For a tour of the joys of UNIX, I suggest *The UNIX Tutorial*. David Fiedler's breezy but comprehensive three-part overview (August, September, and October 1983 BYTE).

TRADE-OFFS

Like any operating system, UNIX is a set of compromises made to enhance certain functions at the expense of others. A few of the areas traded off are as follows.

UNIX is poor at real-time tasks such as data acquisition. Task priority is set up to allocate less processor time to jobs that require the most time. The highest priority is given to jobs that use the least amount of the system's central-processor resources. In such a system, designed to be fair across all users and processes, there is no way to guarantee that a time-critical process will get the central processor often enough.

Most of the current UNIX systems permit multiple jobs to simultaneously access the same file, which can bring about such potentially dangerous situations as multiple users updating the same database at the same time. To circumvent this problem, many suppliers of UNIX have implemented file and record locking, generally through the use of such software devices as signals or semaphores, but these are not automatic and must be written into programs. Suppliers of commercial UNIX database programs generally have incorporated file and record locking into their software.

Another drawback is that the user interface can be very difficult to learn. In other systems, the power has been made more explicitly available at a cost of flexibility and command extent.

Often the naming and syntax of commands, options, prompts, error messages, and argument specifications are inconsistent, cryptic, or nonexistent. The concept of a shell to link discrete commands designed for a narrow purpose makes learning difficult, especially for the occasional user.

To overcome these drawbacks, menu systems and other user-interface enhancements are beginning to appear on UNIX systems. It is also worth noting that a competent programmer can create menu facilities, which let new users accomplish tasks usually reserved for experts.

UNIX is vulnerable to problems caused by accidental or intentional overuse of system resources such as jobs, disk space, swap space, and so on. In fact, there are ways to bring a standard UNIX system to a standstill with a single line of commands. The designers assumed that resources are ample to protect against accidental over-allocation and that system users are skilled and benign.

For business uses, there are built-in solutions to the last two issues. Each user should have a login profile, set to execute only the appropriate application program or only given access to a selected safe subset of UNIX commands through the use of shell restrictions. As users become more advanced, these restrictions can be relaxed or rescinded. In addition to the primary goal of ensuring system security, this method implements a configurable learning method—a good set of training wheels. Note, however, that this presupposes someone who knows how to set up and enforce such restrictions.

UNIX AND THE IBM PC

IBM has been increasingly interested in UNIX, as demonstrated by its present commercial offerings in the marketplace. UNIX is presently available from IBM on three of its computer lines, Series I (CP/IX), the S9000 (XENIX), and the PC XT (PC/IX). An implementation called TSS/UNIX has also been done for the 370 and 303X mainframes, but it is not commercially available yet.

In a modest configuration of 256K bytes of RAM, the IBM XT is at the bottom of rankings of system resources employed to host UNIX. The addressable memory expense is

reasonable in comparison to the PDP-11 series of minicomputers that UNIX grew up on, but the Winchester is only marginally adequate. UNIX runs well on hard disks with an average access time of 20 to 40 milliseconds (ms), while the XT's Winchester times are closer to 90 ms.

Excluding user file space, a full UNIX system occupies 6 to 8 megabytes of disk storage space, leaving little space for user files or a DOS partition for hard-disk coresidency. Neither the 8088 nor other on-board hardware provides for memory management and protection. Thus, UNIX must incur extra software overhead to simulate memory management, and the task protection afforded is not sufficient for multiuser software development (due to the likelihood and danger of errant programs) and barely adequate for multiuser application programs. The 8-bit data bus becomes a processing bottleneck in UNIX and C, where most data is manipulated in 16-bit chunks.

On the plus side, the PC family forms the basis for the least expensive UNIX workstation available. That's a potent argument when you recall that only three years ago, the low end of the UNIX market was a minicomputer costing in the middle five figures. The availability of the 8087 coprocessor on the PC is a real boon for floating-point number applications, for example. If usage is restricted to one user doing software development or a maximum of three users at any one time performing tasks such as text entry but not recalculating a large spreadsheet, the system will perform much the same as a terminal on a minicomputer UNIX system under an average load of users. For some applications, then, it's very cost-effective. A general idea of the relative level of performance that can be expected is demonstrated by a computation-intensive benchmark primarily testing central-processor speed and memory-access efficiency. It showed that in tests involving C's long data type, the XT operated at about one-quarter the speed of an 8-MHz 68000-powered supermicro and with C short integers and integers at about one-half that speed.

There are several general reasons why you shouldn't use UNIX on the PC. For

(continued)

one, applications software is currently available in a broader spectrum of variety under PC-DOS than UNIX. Second, it takes considerable time for new users to become proficient. Finally, the system is too complex to exist on its own without some rather advanced software-maintenance procedures such as user account creation and administration, file-system administration and maintenance, and the observance of system shut-down protocols.

On the positive side, when considered as a single-user system, PC UNIX is a cost-effective way to trade off some performance for having UNIX available on a widely used hardware configuration. A few hints may help you get the most out of your system. If you want a full UNIX system, keep some of its less used parts on floppy disks and load them into the system only when necessary. If the system has several users or does extensive multitasking, the larger the amount of RAM in the system, the faster UNIX will work because you'll need to swap data less often. In general, the system should have only one user in all but the lightest duty applications, where it can accommodate two to three users at most.

UNIX SYSTEMS FOR THE PC

Several UNIX systems and work-alikes are presently available for the IBM PC, and more are expected shortly. A brief overview follows.

Currently, four Bell-licensed UNIX systems are available for the PC: PC/IX (implemented by Interactive Systems and sold by IBM), XENIX (implemented by Microsoft and sold by Santa Cruz Operation), VENIX (implemented by VenturCom and sold by Unisource Software), and U-II (implemented by Unidos Systems and sold by International Data Services). All of these systems allow file transfer to and from PC-DOS and include additional DOS file-manipulation utilities. The makers of VENIX and Uniform Software Systems are working on DOS emulation capabilities for VENIX and PC/IX, respectively. PC/IX, XENIX, and U-II are based on Bell UNIX system III, while VENIX's ancestry is Bell version 7 UNIX. These are all large, full, licensed UNIX systems. XENIX, U-II, and VENIX contain some utility programs developed at University of California,

Several UNIX systems and work-alikes for the IBM PC are currently available.

Berkeley, including versions of the vi screen editor and the C language-oriented shell, csh. PC/IX includes a screen editor developed by Interactive Systems.

The four UNIX look-alike operating systems for the PC are Idris (White-Smiths Ltd.), QNX (Quantum Software Systems), Coherent (Mark Williams Company), and uNETix (Lantech Systems). None of these systems is based on a Bell Labs UNIX license. The two closest to Bell UNIX are Coherent, a highly compatible UNIX version 7 look-alike, and Idris, which is system-call compatible with version 6 UNIX, but many of its commands differ slightly from their UNIX counterparts. QNX uses an idiosyncratic syntax with functions that bear a close conceptual resemblance to UNIX. To outline some strong points, Idris has an elegant DOS interface, QNX is capable of high performance, and Coherent is nearly equivalent to Bell UNIX. All three systems include excellent C compilers, perhaps better than those supplied with any of the Bell-licensed products.

Two implementations of UNIX are tied to auxiliary processor cards. A Motorola 68000 card runs Xenix, and a National Semiconductor 16032 card runs BSD (Berkeley Standard Distribution) 4.1 UNIX. Both cards are available from SriTek Inc. These systems, intended for the OEM (original equipment manufacturer) market, typically use the PC only as an I/O processor; the auxiliary processor does all other tasks. Although the level of central-processor performance is considerably better in these systems, the hard disk is still slow and small for UNIX. Be sure to evaluate these systems for cost-effectiveness, since either adds roughly \$3000 to the cost of a basic PC host.

Two general levels of PC-DOS interface are evident. The first, DOS emulation, lets users run DOS programs and return to UNIX without sacrificing the

functionality of either operating system. There are several ways this is done. Idris runs as a task under DOS so DOS commands can be executed from within it by an escape mechanism. Moving between Idris and DOS is as simple as invoking Idris from DOS or exiting to DOS. QNX actually brings the binary executable files into its file system and executes DOS function calls by emulating the operating-system routines accessed through interrupts by the guest program. Coherent and uNETix are both developing emulation capability. The second level, for UNIX environments with DOS file-transfer capability, does not allow for any execution of DOS commands from within UNIX. Differing degrees of file-transfer support are provided. Some systems let you delete, rename, and perform other manipulations on PC-DOS 2.0 directories and files, while others only let you copy files to and from UNIX.

COMPETING SOLUTIONS

Three general categories of software products compete with UNIX for a dominant position in the future market for concurrent systems: other multitasking operating systems, proprietary integrated environments, and enhanced hardware environments incorporating mainframe access.

The first category, multitasking operating systems, includes yet to be released MS-DOS 3.0 and Microsoft Windows, Concurrent CP/M-86, and the Pick operating system and its variants.

Currently, PC-DOS has a greater variety of general-purpose software available, such as decision support, word processing, utilities, and programming tools. However, it lacks concurrency.

Proprietary integrated environments include Lotus's Symphony, Ashton-Tate's Framework, Quarterdeck's DesQ, and VisiCorp's VisiOn series. Generally, they provide the following enhancements to the operating system:

- It's easy to move data from one application module to others.
- The user can freeze session state and return to DOS or execute DOS commands concurrently without leaving the working environment.
- A concurrent stub allows main-

(continued)

Now Quadram Makes Communications as easy as 1, 2, 3.

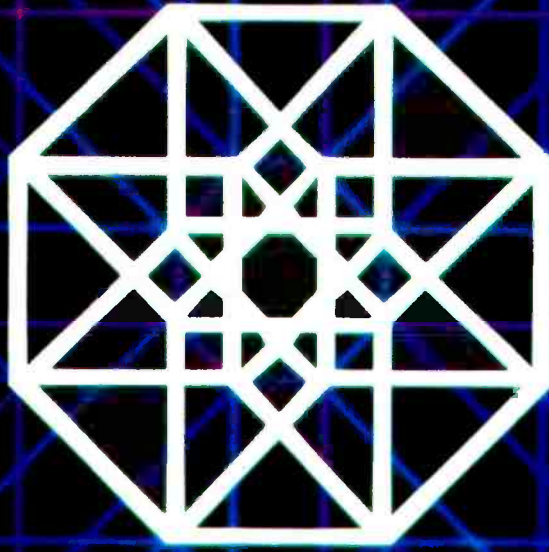

1. Quadmodem.TM Instant access to a world of information, right from your home or office



Quadmodem is the complete intelligent modem. With everything you'd expect from a quality modem. Plus enhanced diagnostic capability to spot communication problems. And call progress monitoring to automatically determine and compensate for the type of phone and transmission.

Quadmodem plugs directly from your computer into your phone line. And it's fully compatible with Bell 103/212A dial-up modems and the most popular modem brands.

Get the modem with the name for quality. Quadmodem. With your choice of internal or stand-alone models, full supporting documentation and user manuals. There's even QuadTalk, our very powerful, but friendly, menu driven communications software. Plus, we'll include a special introductory offer from The Source.SM

IBM® PC, XT, PCjr. are registered trademarks of International Business Machines Corporation.

*The Source is a registered trademark of Source Telecommunicating Corporation.

APPLE IIe® is a registered trademark of Apple Computers, Inc.
© Copyright 1984 Quadram Corporation. All rights reserved.

2. Quadnet.TM Four easy solutions to one difficult problem.

Local Area Networking (L.A.N.) allows you to interlink a group of computers so they can share information and peripherals with each other.

And now with Quadram's new Quadnet, you can easily link as few as two, as many as 255 IBM PCs together in a hard-wired network. And you can configure them almost any way you want. Because Quadnet gives you a choice with four different Network Systems.

And best of all, Quadnet grows as you grow. Yet the user commands stay the same, thanks to the upward compatibility of the Quadnet operating software.

Whichever version you hook on to, you get the complete package (hardware, software, and documentation). And most importantly, you get the Quadram reputation for quality.



Look for this seal. It's your assurance that you're buying the best in personal computer enhancement devices.

3. Quad3278.TM Let an IBM PC communicate with an IBM mainframe.



To integrate your PC system into a main-frame environment, look to Quadram first.

Because now you can have all the features of the PC (mass storage and peripherals) plus the incredible power of a main-frame right at your desk. All it takes is the Quad3278, Quadram's new 3278 emulation package complete with hardware and software.

With Quad3278, once you're on-line, the IBM mainframe sees you as just another 3278 terminal. But little does it know that you're actually a high-performance, intelligent workstation with all the functions of the Personal Computer. Thanks to Quadram Quality.



4355 International Blvd./Norcross, Ga. 30093
(404) 923-6666/TWX 810-766-4915 (QUADRAM NCRS)

INTERNATIONAL OFFICES
Interquadram Ltd. 442 Bath Road, Slough, England SL6 6BB
Tel: 6286-63865 Tlx: 847155 Aurema G Interquadram GmbH
Fasanenweg 7, 6092 Kelsterbach, West Germany Tel: 6107-3089
Tlx: 417770 Seva G Interquadram s.a.r.l. 41, Rue Ybry, 92522 Neuilly
Tel: 758-1240 Tlx: 630842 Iso Bur Checco Computing 6581 Kilimat
Road, Mississauga, Ontario, Canada L5N 2X5 Tel: 416-821-7600

frame communication.

- The system is user friendly and has menu-driven command structures and extensive help information available on-line.
- Other packages can be added to the same environment.

Environments based on concurrently

integrating a mainframe link refer primarily to the two powerful hardware enhancements to the PC computer family offered by IBM, the PC XT/370 with VM/PC operating system and the 3270 PC with its control and file-transfer programs. The facilities of the XT/370 are limited to a single-tasking VM/CMS session locally under VM/PC, and thus PC

XT and 370 modes are not concurrent. The system does offer file-transfer capabilities between mainframe 370 and XT/370 as well as between XT/370-VM/CMS and PC-DOS, but it really shines when it comes to offloading processing from an IBM mainframe to capable local workstations.

The 3270 PC supports seven concurrent tasks, including four separate interactive 3270 sessions with a host mainframe, two local notepads (with full-screen editing and data-transfer capabilities), and one a standard PC-DOS 2.0 task.

You can obtain data from up to four mainframes, collect it in a notepad area, evaluate it in a PC-DOS spreadsheet, and then pass a set of results back to the mainframe for transmittal by electronic mail.

A UNIX SOLUTION

The growing popularity of UNIX, and the C language in which it is written, in the commercial microcomputer community is largely based on demands for software transportability. The capital investment required by the labor-intensive process of creating software makes increasing the market size and useful life of such new programs imperative. From this standpoint, the alternatives to UNIX become less attractive. Further, the software consumer has to consider the costs of retraining workers. Advances in hardware that invite upgrades for increased performance will appear more rapidly than similar advances in software. None of the alternatives operates on the range of hardware that UNIX does.

While less business-oriented application software is available for UNIX than for some alternatives, DOS emulation can serve as a useful bridge until the new generation of UNIX software, already under development, appears. At present, using the full extent of UNIX capabilities requires some sophistication, but customized shells and restricted environments focused on one task will soon become available to allow the unsophisticated user to take advantage of the system's power.

The wide-ranging transportability and communications transparency that UNIX provides make it an attractive long-term solution to business demands. ■

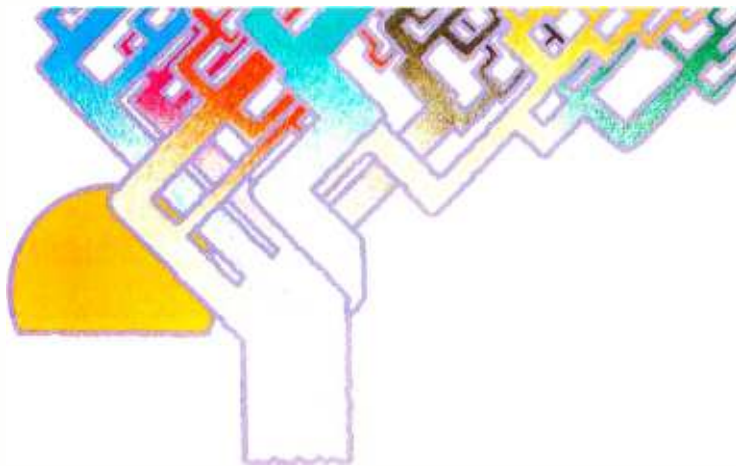

Btrieve™

Network and single-user file management for all your programs. All your programming languages.

Say goodbye to writing file management routines. Because now Btrieve™ can handle file management for all your program development on the IBM PC. All your programming languages.

Based on the b-tree file indexing system, Btrieve provides the most sophisticated file handling powers available for your PC. And for multiple PCs. Btrieve™/N lets you share files among PCs in NetWare™, PCnet™, EtherSeries™, or MultiLink™ networks. And both Btrieve and Btrieve/N offer the same superior performance characteristics:

- Interfaces all major IBM PC languages—BASIC, Pascal, COBOL, C, and IBM Macro Assembler

- Written in 8088 Assembler for the IBM PC
- Multikey access to records
- Automatic file recovery on system crash.

Btrieve and Btrieve/N also have user-defined transaction management. Unlimited number of records per file. Complete error control and recovery within an application. Duplicate, modifiable, and segmented keys. Variable cache buffer from 16K bytes to 64K bytes.

Moreover, record retrieval is *fast* with Btrieve—no matter how large your data base. So *you* can begin writing programs *faster* with Btrieve.

Say goodbye to file management routines. And hello to Btrieve.



P. O. Box 9802 #590 Austin, Texas 78766 (512) 346-8380

Suggested retail prices: Btrieve, \$245; Btrieve/N, \$595. Requires PC/DOS or MS™/DOS, version 1 or 2. Dealer inquiries welcome.

IBM, MS, Btrieve and Btrieve/N, PCnet, MultiLink, NetWare, and EtherSeries are trademarks of International Business Machines, Microsoft Corporation, SoftCraft Inc., Orchid Technology, Davong Systems Inc., Novell Data Systems, and 3Com Corp, respectively.

The more you
know about
integrated
software,

the more you'll
appreciate
what you're
about to read.

Enable.TM

Integration without compromise.

For the IBM²PC and selected compatibles.

Today, buying integrated software is a bit like going through a maze. Full of promising starts and disappointing dead ends.

One package has the functionality but operates at a snail's pace. Another has a good spreadsheet but a weak DBMS. Still another integrates well but not without 512K and a hard disk.

Compromises abound.

But now, there's one system that is without compromise. One system that provides such a totality of performance, it will lead you out of the maze.

That system is Enable.

What you get with Enable will *sound* familiar: an integrated package with five modules—word processing, spreadsheet, database management, graphics, telecommunications.

But this is where Enable's similarity to other integrated software begins and ends.

System design: Unlike any other.

Because Enable was designed from the ground up to work as a unified whole—rather than being a patch job—it operates with a speed, power and total integration previously unknown in PC software.

The Enable integrated system is based on design concepts previously found only in much larger computer systems.

At the heart of Enable is a Master Control Module which is similar to supervisory programs that run the most advanced mainframe computers. This Master Control Module (MCM) contains all services and facilities for Enable. And all functions common to all modules—eliminating system redundancies.

Windowing is easier and faster than ever before. "Cut and paste" data from one module to another cleanly, precisely, with a minimum of keystrokes. And do it in a split-second (others can keep you finger-tapping for a small eternity). Up to 8 windows can be moved, shaped, overlapped or zoomed to full screen size.

Integration: So much, so easily.

You can create a graph from a spreadsheet or database. Then insert the graph and the spreadsheet between text in a single word processing document *right on the screen*.

Select DBMS data using Enable's powerful query language and copy that data into a word processing document. Or insert that data into a spreadsheet and Enable will automatically expand column length and modify formulas.

Using DBMS with word processing, you can automatically include selected DBMS fields—or embed calculated fields—within the text of a letter or report.

Combining word processing with telecommunications, you can write anything from an electronic mail message to an annual report and transmit it across town or around the world.

Since the MCM handles all full-screen text editing, you can use that important feature in any module.

Greek, foreign and special character sets are available—not only in word processing—but for putting labels on top of your graphs, creating DBMS data entry forms and producing customized reports.

Functionality: All you could ask for.

Unlike other integrated software, every one of Enable's modules gives you virtually everything you'd expect from the better stand alone programs. And, often, more than you'd expect.

Enable Word Processing is very much like a dedicated word processor. Going beyond all the standard features to include such things as:

- positioned headers and footers
- pagination
- automatic footnoting
- mail merge
- multiple character sets
- document size limited only by available disk space.

The Enable Spreadsheet is comparable to Lotus 1-2-3™ both in functionality and speed. With such special features as:

- variable column length for loading of DBMS data
- highlighting of all related cells
- step feature for changing value in target cell
- can take advantage of your optional 8087 math co-processor.

Enable Database Management is, without qualification, the most powerful DBMS available in an integrated system. So powerful, you can generate specialized applications *without the need for any programming*. The DBMS includes:

- Menu-driven field definition using an external data dictionary
- comprehensive "paint the screen" input and report forms design
- full screen data entry with extensive and automatic field editing and validation
- over 65,000 records per database
- rapid search and retrieval using Boolean logic, arithmetic and relational operators, and "wild cards"
- powerful menu-driven report generation including virtual and calculated fields, and up to 16 break conditions with running, break, conditional and grand totals.

Enable Graphics draws *presentation-level* graphs. Its many special features include:

- sizing, shaping and positioning of graphs using

windowing • writing labels right on the graph • 7 graph types with 8 fonts.

Enable Telecommunications gives you easy access to online services, your company's big computer and other personal computers. With automatic sign-on using stored "set-ups" enter your connection protocol just once and then press a few keys to make that connection again and again.

192K? Yes, 192K.

Enable's highly efficient, non-redundant system architecture—which makes use of virtual memory as well as reentrant Assembler coding—gives it the ability to run with as little as 192K and two double-density disk drives. And we do mean *run*. Which means you won't have to add lots of expensive memory or a hard disk to your hardware to enjoy a fully-integrated, full-function system.

Speed you've never seen.

This major shortcoming of many integrations is a major asset of Enable.

With Enable, when a word processing document is revised, the entire document is reformatted in an eyeblink (no "ripples").

In a spreadsheet, even as numbers, formulas, rows and columns grow more complex, Enable re-calculates at lightning speed.

Enable's DBMS can rapidly retrieve records according to even the most complex parameters and sort them on up to 8 fields.

Critical Compatibility.

Here's another enormous advantage: all the time and money you've invested in first generation packages won't go to waste. Files created by dBase II™, Lotus 1-2-3™, WordStar™, VisiCalc™, EasyWriter I™, or Volkswriter™ can be used automatically in Enable without conversion or re-keying. Similarly, Enable can *create* files in the proper format for all the above as well.

Enable = Power.

The MCM internally directs traffic, making it possible to run one main program, one communications program and one printing program concurrently. So you can do spreadsheet analysis, print a monthly report and receive

stock quotes over the wire—all at the same time.

Enable's powerful macro facility saves you time and keystrokes in all modules. Macros may be automatically recorded as the steps are executed; even edited using full word processing capabilities. You can, for instance, create a macro which produces a report containing data selected from your DBMS file. Every time the macro is executed, the resulting report is updated with the latest information from your database.

Ease you've never experienced.

As for being "user-friendly" (the most abused phrase in all of computing), the proof, of course, is in the using. Here, you'll discover, Enable shines. Whether you're a beginner or an expert.

Since the MCM is the sole interface between you and all the modules, you only have to learn one uniform set of commands and menus to use the entire system.

You may not even need to open a manual first. Clear, English language menus—complete with explanatory messages—are available in every module. Menu options may be selected by the traditional cursor method, or with a single keystroke short-cut. As you grow more experienced, expert commands bypass the menus. And there are convenient macro commands for the really sophisticated.

For those just getting started, Enable has a tutorial disk distinguished by its clarity and depth. And the manual teaches you, step-by-understandable-step, how to use all that the system provides. For online assistance, at any time, just push the F1 key to get all the help you need.

Support. Then more support.

As an Enable owner, you've got a continually evolving software system. *One complete*

update, with significant new features, will be sent to you—at no cost.

By joining our subscription service, you can receive regular product and manual updates with new features and enhancements. Plus toll-free telephone assistance from our trained staff.

And we've created something unique in the microsoftware industry: all Enable subscribers become official Enable Advisors. You'll tell us what new features you want in future versions of Enable. And we'll *listen*.

Enable. Here today. Here tomorrow.

Enable is software you can grow with. By learning the system with easy menus and graduating to expert commands. Using more and more of its complete functionality. Exploring the many possibilities of its integration.

Enable defeats software obsolescence. Your product updates will not only include important new features, but—because of the MCM's flexible design, its "open architecture"—your system will be continually enhanced to take full advantage of changes in micro hardware.

Now put us to the test.

This advertisement is, of course, just words on paper. *We urge you to see, work with, experience Enable.* That's why we've made it so easy for you to try Enable out for yourself. Visit your authorized Enable Dealer for a demonstration. Or test the system right there. Even take a loaner copy home.

Finally, the introductory price for integration without compromise: a remarkably affordable \$695.

For more information and the name of your nearest Enable Dealer, just dial 1-800-932-0233. In New York, dial 1-800-338-4646.



The Software Group
Northway Ten Executive Park, Ballston Lake, New York 12019

Trademarks: Enable—The Software Group, IBM—International Business Machines Corp., Volkswriter—Lifetree Software, Inc., EasyWriter—Information Unlimited Software, Inc., WordStar—Micropro International Corporation, dBase II—Ashton-Tate, 1-2-3 and Lotus—Lotus Development Corporation, VisiCalc—Visicorp.

© Copyright 1984, The Software Group

FIVE

WINDOW MANAGERS FOR THE IBM PC

Multiple windows, mouse pointing devices, and multitasking environments for your IBM PC

The public's acceptance of the Apple Macintosh computer has made it clear that certain user-interface designs are now becoming more universally accepted.

The major elements of these interfaces are bit-mapped graphics monitors, mouse pointing devices, and window-oriented displays with pop-up menus. Together these elements act as a visual shell, insulating the user from the operating system. By using pop-up menus that overlap on the monitor, your computer's screen is supposed to remind you of a cluttered desktop. Often the new interfaces use icons to represent the computer's programs, documents, and resources.

The roots of window-based user interfaces lie in two computer science research developments that emerged during the fifties and sixties. The first is based on the work done around the mainframe graphics systems developed by George Evans and Ivan Sutherland. Sutherland's doctoral dissertation was based on an innovative graphics system he called Sketchpad. The concept of windows seems to have evolved from Sketchpad. Sutherland did his work before the advent of computer time-sharing, so, in effect, he was using a mainframe as a personal computer.

The second development grew out of the investigation of new technologies

for information storage and retrieval done by a group headed by Douglas Englehardt at SRI International. Much of the group's work dealt with viewing and organizing documents and giving the user the ability to rapidly switch between documents.

Both of these research developments were brought together by computer scientists at the Xerox Palo Alto Research Center (PARC) in the early seventies. At PARC, work done by the Smalltalk research group led to the construction of a series of single-user personal computers that employed mouse pointing devices and bit-mapped displays. The first version of Smalltalk offered a bit-mapped screen displaying overlapping windows; it was created on an Alto personal computer (an experimental Xerox computer) by Dan Ingalls in 1975.

These overlapping windows and mouse pointers were striking in contrast to the single-command line and text-oriented questions that faced the user after booting up on the first mainframes and personal computers.

Certain elements of this user interface are still being hotly debated. Some question the efficiency of mouse pointing devices and others ask whether overlapping or "tiled" windows are preferable. (In a tiled interface windows shrink to accommodate other windows that are expanded; however, all windows remain visible. This concept was

also first developed at Xerox PARC and has been used on the Xerox Star.) However, a consensus seems to have emerged that an interface that permits a user to see a command and point at it to execute a task is simpler and more interactive.

Window-oriented user interfaces function best when they are based on high-performance processors and displayed on high-resolution screens. They have (until the introduction of the Apple Macintosh) generally been considered beyond the realm of the low-cost desktop personal computer. However, a number of window-management software programs have been introduced for the IBM PC.

Because two of the five programs I looked at are still undergoing testing and two others were released in their first salable version only weeks before our deadline, this article does not constitute a formal BYTE review. However, I have been able to work with the products, and I will comment on their performance and design with special emphasis on the style of user interaction offered by each program.

The five programs I previewed include

(continued)

John Markoff is a BYTE senior technical editor. He can be reached at 1000 Elwell Ct., Palo Alto, CA 94303.

DesQ from Quarterdeck Office Systems in Santa Monica, VisiOn from VisiCorp, Windows from Microsoft, Concurrent DOS from Digital Research, and WindowMaster from Structured Systems Group in Oakland, California.

WINDOW MANAGEMENT ON THE IBM PC

If you attempt to display and integrate a number of discrete applications on an IBM PC, you will face a number of problems that have no obvious solutions. For example, some have approached window management as an application in its own right that intermediates between the operating system and separate applications (DesQ, VisiOn, and Window Master can be considered "operating environments"). Other operating-system developers have extended the operating system up toward the application software (Windows and Concurrent DOS).

In the case of the IBM PC, matters have been complicated a great deal, because the user hardware base has tended not to be standardized (the market is split between those who have either monochrome text-oriented or graphics displays and available system memory ranges from as low as 64K to 600K bytes) and because virtually all major software developers have chosen to circumvent the MS-DOS operating system to display information on the screen.

A second issue is "tight" versus "loose" integration of applications. VisiCorp, the first company to announce a window manager for the IBM PC, insisted on tight integration. To run under VisiOn, an application must be specifically designed for that environment. These applications can exist in display windows as well as pass data to other applications. In contrast, Quarterdeck's DesQ attempts to support as broad a range of MS-DOS applications as possible (see table 1). Quarterdeck has provided "agents" for 12 major application programs. These agents will permit the applications to run in windows under DesQ and to transfer data between windows or applications running in different windows. Applications that don't have a specific agent can generally be installed by the user; however, they will not be able to run in windows. Microsoft's Windows will lie somewhere be-

tween tight and loose integration. To run under Windows an application must be specifically tailored to the program; however, Microsoft has stated that if an application writes directly to the hardware, Windows will gracefully turn the screen and other resources over to that application.

There are other issues at stake in developing window managers for the IBM Personal Computer. Important distinctions between window managers range from style questions, such as whether to use icons, to virtual memory and multitasking.

CONTEXT SHIFTING

The variety of personal computer applications available and the fact that many can be used in conjunction with each other or operate on shared data make it desirable to be able to view applications simultaneously and to move quickly between discrete tasks.

If the operating system of the IBM PC is altered to permit multitasking, an ideal window-oriented interface would permit you to carry on simultaneous communications tasks (electronic mail or database access) while running other programs locally.

PARTITIONS

The large memory-address space of the IBM PC permits several programs to be placed in RAM (random-access read/write memory) at the same time. The simplest approach to partitioning memory is taken by a program called Memory Shift from North American Business Systems. Memory Shift is not a window manager per se, but it allows you to divide the RAM of an IBM PC into up to nine separate partitions. Each partition holds its own application, and you

are permitted to switch between different tasks that are then displayed on the screen. Since Memory Shift does not offer a multitasking extension, only one program is run at a time. Programs in other partitions are suspended.

Of the five window-management programs for the IBM PC, DesQ's and VisiOn's partitioning schemes are the most ambitious. DesQ has added some memory-management capabilities to the IBM PC to allow you to simultaneously display programs whose combined memory requirements extend beyond the limits of your system RAM. (Of course, these programs are not running simultaneously; however, DesQ swaps them back and forth from disk.) VisiOn also uses virtual-memory management to permit you to place more programs on its desktop. The exact makeup of the Windows memory-management scheme isn't available yet, but at a developers' seminar held early this year, Microsoft indicated that both code swapping and compaction would be involved. Concurrent DOS and Window Master partition memory in a manner similar to Memory Shift.

MULTITASKING

Multitasking frequently is held out as the next performance plateau for desktop personal computers. Multitasking is in principle possible on the 8088-based IBM PC, but the consensus is that running several computation-intensive tasks will degrade the performance of the PC below what is acceptable. There are several multitasking operating systems available for the PC, most of them variants of the UNIX operating system. There are also a number of multitasking extensions of DOS available from third parties.

Several of the five window managers also offer multitasking capabilities. WindowMaster, Windows, and Concurrent DOS all offer this feature to varying degrees. In each case there are significant limitations. Both WindowMaster and Concurrent DOS have difficulty handling "misbehaved" applications (those that don't use standard DOS calls to write to the screen) as background tasks. Such programs frequently must be put to sleep when they are in the background to avoid conflict over video memory. Windows steps out of the way in the face of programs that do not

Table 1: The DesQ agent library. These programs can run in resizeable windows within the DesQ environment.

FAST GRAPHS	pfs:report
dBASE II	pfs:write
Lotus 1-2-3	SuperCalc
MultiMate	SuperCalc3
Multiplan	WordStar
pfs:file	VisiCalc

meet its design specification. This is not an inconsequential problem, because virtually all of the commercial software available for the IBM PC circumvents MS-DOS for speed reasons.

DATA TRANSFER

Data-transfer capabilities vary in each of the five window managers, ranging from tightly integrated applications (VisiOn and Windows) to a simpler strategy involving only copying screen memory directly or indirectly from one partition to another (Concurrent DOS and WindowMaster). DesQ offers a complex set of transfer options. At one end of the spectrum, with applications that have agent support, DesQ knows enough about how an application formats, marks, and transfers data that it can handle data transfer between dissimilar packages. If agent support isn't available for the programs you are running with DesQ, you can still use a "view" mode transfer option that makes copies from screen memory.

HARDWARE

One obstacle facing the developers of window-management user interfaces for the IBM PC is the lack of standardization among different hardware components.

The most significant split is between the monochrome and color/graphics display. The monochrome display currently available from IBM has a higher resolution than the color/graphics monitor (720 by 350 pixels versus 640 by 200 pixels); however, it supports only a character-mapped display. Developing a window-based user interface has therefore meant choosing to support either one or both of the display options.

There are other hardware-based decisions to make as well. DesQ requires 256K bytes of memory plus enough additional RAM to run the largest application program the user intends to run in addition to a fixed disk. DesQ program files take up over 1 megabyte of disk space. VisiOn requires a minimum of 256K bytes of RAM (VisiCorp claims its applications run faster with more memory) and a fixed disk, and asks the user to clear 5 megabytes of disk space for VisiOn files. Windows, on the other hand, claims that it will run with 256K RAM on a floppy-disk based system.

Finally, there is the issue of the mouse. Both VisiOn and Windows will require mice as pointing and command devices. Mice are optional or not used by the other window managers.

MISBEHAVED APPLICATIONS

The Achilles heel of IBM PC window management is screen management. Only those programs that display textual information on the screen by calling DOS or the ROM BIOS will run in small windows.

Unfortunately, for reasons of performance, almost every software publisher has chosen to write directly to the hardware. DesQ has offered special agents or utilities that permit several popular programs to be run in windows. Still, this probably will remain a major problem until an acceptable standard is set for bit-mapped display graphics and text on the PC's screen.

Other potential sources of incompatibility exist as well, depending on

how individual application programs read the keyboard or how they locate themselves in memory.

STYLE

Entering the debate over the best user interface is hazardous at best. Should your mouse beep, flash, or make no noise at all when you click it? Should your mouse have one, two, or three buttons? Should your windows overlap or be tiled? Should you use icons or have a more staid or serious desktop? The list is virtually endless, yet the questions remain important both from a design and a marketing viewpoint.

DESQ

DesQ was the surprise hit of the 1983 Spring COMDEX computer show in Atlanta. Its strength is that it allows IBM PC users to integrate their already existing applications, and in some cases to display them simultaneously on the

(continued)

IF POWER FAILS, DATASAV[®] TAKES OVER!

PROTECTION - saves data during power failures
 - saves hardware from overvoltage transients.

PORTABILITY - allows mobile or extended holdup time using auxiliary 12 volt battery.

FEATURES - internal battery provides 5 min. + operating time - AC line conditioning
 - audible and visual alarms, interrupt signal - compact, desktop styling
 - no installation required.

200 WATT - \$495 / 90 WATT - \$350
 For special applications and product information, call 805-541-4160.

Instant power order line
805-541-4161

CUESTA SYSTEMS, INC.
 3440 Roberto Court, San Luis Obispo, California 93401

INSTANT AC POWER





All he could do was hit.

And the Babe's fans loved him for it. Doing one thing very well has its rewards. Some people make history. Some set records. Some win hearts.

Multimate International. In a brief 18 months, a growing "fan club" of users has made us one of the leading software companies in the world. The object of their affection: Multimate, the program that put the power and speed of a Wang dedicated word processor into the IBM PC.

We've carved a niche in office automation. By committing ourselves to word processing. And to matching the IBM PC line, product for product. But we're also committed to extending the reach of word processing. By broadening our Multimate line to include data management, and, in the near future, a program that will allow users to convert Wang files to the Multimate format.

Multimate International. We've come a long way in a short time by being very good at what we do. We intend to keep it that way.

To find out more about Multimate, the word processor, and Multimate International, the company, call Jordan Caswell at 1-800-243-3142.

Multimate

Circle 120 on inquiry card.

We're putting our reputation into words.

THE FILE CONNECTION

8" DISKETTE SYSTEM FOR THE IBM PC



Our "FILE CONNECTION" programs provide 8" diskette file exchange between the IBM PC and most Micro-Mini-Main Frame computer systems.

Our "WORD CONNECTION" programs provide 8" diskette text document exchange between the IBM PC and many word processing systems.

Our "DISPLAYWRITER CONNECTION" programs transform documents from Textpack, Wordstar, Multimate, etc. to the new DisplayWrite 2 format.

In addition to our hardware and program products, we also provide a conversion service for customer supplied diskettes. Please contact us for information about the hundreds of 5¼" and 8" diskette formats and systems which we currently support.

FLAGSTAFF ENGINEERING / 2820 West Darleen / Flagstaff, AZ 86001
Telephone 602-774-5188 / Telex 705609 FLAG-ENG-UD

Circle 65 on Inquiry card.

screen and pass information between them. DesQ also automates frequently performed repetitive and complex operations through Learn or Script utilities.

Despite its name, DesQ has kept the use of a desktop metaphor to a minimum; it has no electronic-desktop screen (installed programs appear on a simple menu) and, although the program does support three different mice (Mouse Systems, Microsoft, and Logitech), it is designed to function just as well with menu-based keyboard selections. DesQ does support background color and will run programs that have graphics output (not in windows, however), but it appears to be optimized for use on the IBM monochrome display.

Quarterdeck Office Systems has managed to unhook screen-cursor movement from the individual application software in a number of cases. This means, for example, that it is possible to use a program like WordStar, which is noticeably hostile to mice (quick cursor movement tends to fill a WordStar screen with a series of exclamation marks), with a mouse. However, don't expect the same kind of natural pointing that you experience on a system like Apple's Macintosh. When you move the mouse pointer in WordStar, the DesQ WordStar agent translates your pointer movement into commands. It often

takes several seconds for the WordStar cursor to reach the spot you have pointed at.

Another one of DesQ's strengths is that "shortcuts" have been designed in at every point in the system. This means that, while DesQ is largely menu driven, expert users who have learned commands can frequently get things done using keyboard-control sequences. While novices generally will use menus to move between different windows, experienced users can use a shortcut. To enter a new window (or a new partition of that window), it is only necessary to tap the DesQ key (the Alt key) and then type a number corresponding to the window you wish to activate.

If you are using a mouse with DesQ, one of the mouse buttons becomes the DesQ key. When using a mouse, it is only necessary to point and click in the window to activate it. It is also possible to move or resize the windows with the mouse.

DesQ comes on three floppy disks and uses an install program to create its own directory on a Winchester disk drive. After DesQ is installed, it is necessary to insert the first Starter disk into the floppy-disk drive and then type the command "DesQ" from the operating system prompt each time you start DesQ.

(continued)

AT A GLANCE

Name

DesQ

Manufacturer

Quarterdeck Office Systems
1918 Main St., Suite 240
Santa Monica, CA 90405
(213) 392-9851

Application programs

Existing MS-DOS programs and a simple text editor

Consistent command structure

No

Graphics

Character-based

Hardware required

IBM PC or compatible, 256K bytes of RAM plus enough memory for largest application, 5-megabyte hard disk

Support color

Yes

Multitasking

No

CP/M-86

No

Memory management

Yes

Data transfer

Program-level data with agent support

Mouse support

Optional

Price

\$399

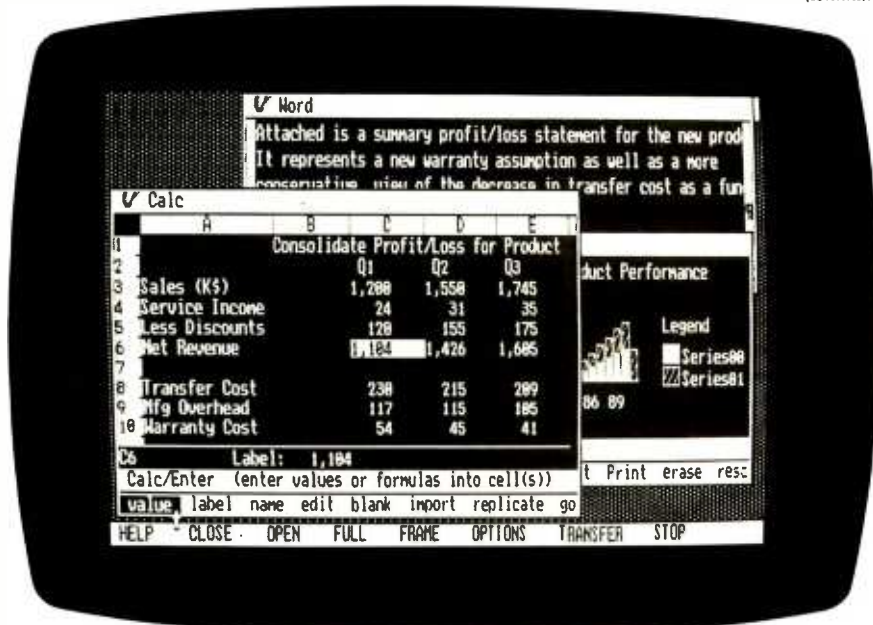

Photo 1: *VisiOn from Microsoft.*

After the program loads, the first screen of information that appears is the DesQ main menu from which you perform such functions as running programs, rearranging directories, and installing new programs.

To run any program under DesQ, you must first install it as part of the DesQ system. This is done by either loading one of the DesQ-supplied agents for one of the 12 programs that have been tailored for the DesQ environment, or by having DesQ create a new agent for a program that is not in its agent library. After this is done and saved to disk, that program becomes a permanent part of the DesQ menu and can be called directly from that menu.

To create permanent Scripts in DesQ using the Learn facility, select the = key from the DesQ main menu, name the particular Script, and select the key-strokes that will invoke the Script. DesQ then creates a record of all subsequent keyboard input until you suspend the Script by again calling the = key from the DesQ main menu. After the Script has been saved to disk, it can be invoked at any point from a submenu that is specific to a given program. Advanced Script functions also include the ability to let a Script pause for keyboard input or to input data from a pause.

DesQ comes with a series of predefined general Scripts that permit a series of general operations to be performed on any currently active application (see table 2).

The Script command also applies to DesQ's Mark and Transfer function. This feature allows users to automatically generate custom reports that have to be generated regularly from diverse sources.

DesQ claims that if your format can read and write information in DOS text files, DIF format or SYLK (Microsoft's own data format), it will be possible to transfer information in or out of these programs.

DesQ also has a Mark Transfer Forms feature to permit collection of disjointed pieces of information and transfer all the pieces in a group to another program. One example is transferring an entry from an address book in pfs:file to a customer database in dBASE II. Using the Forms capability, the user would show DesQ how to mark each of the pieces of an entry in the pfs:file ap-

plication and then show DesQ where in the dBASE II record to put each piece. After DesQ has been shown the operation once, it can then automatically repeat the process. This is an intriguing capability because it can conceivably provide a method for transferring otherwise incompatible database information between programs.

Creation of Mark Transfer Scripts is considered an advanced task in DesQ. Simpler functions include the MARK TRANSFER command, which will permit transfer of data between programs whether they have DesQ customized agent support or not. At the lowest level DesQ uses a View option to copy information from screen memory. The VIEW command can also be used to circumvent individual application restrictions of cursor movement. In View mode DesQ provides a "snapshot" of the information the program has written to the full screen. This can be manipulated independently of program-imposed restrictions.

The View mode also has several other interesting uses. For example, View can be used to save information from communications programs or other programs that write to the screen as if it were a terminal. View will save this information for later editing or other processing. View also lets you take an application that will not run in a DesQ window and place a snapshot of it in a window so that it can be referred to while using other programs. The program is suspended by DesQ when it is in this

special View window.

Although DesQ insulates the user from DOS, the program does not entirely fence the user away from the operating system. DOS directories and most utility programs can be accessed via a special DesQ window called File Print. A range of DOS commands including BACKUP, COPY, ERASE, RENAME, etc., can all be accessed through this menu.

DesQ also provides a DOS-related feature called Logical Drives that permits programs designed for DOS 1.1 to take advantage of DOS 2.0 directories. The Logical Drives feature lets you associate a drive letter with a DOS 2.0 directory. DesQ then maps this drive assignment to a particular directory path.

USER INTERFACE

DesQ can perhaps be viewed as an extension to the operating system as well as a user interface. Thus the real importance of DesQ may be in the power it gives users to automate repetitive operations.

Although DesQ is designed to permit mouse operation, using a mouse didn't seem to have any particular advantage. Virtually all of the DesQ commands can be given as quickly, if not more quickly, from the keyboard.

Used with the IBM monochrome display, DesQ suffers from the same problem that all character-oriented window managers do: when the display is broken into separate windows, the space available for each window is sig-

Table 2: Predefined DesQ scripts.

Switch to Window (1-9)—switches to windows 1 through 9.
Input from Pause—plays back the last variable information entered when a script performed a Pause for Input command.
Repeat Last Script—displays a menu which allows you to repeat the last script played back.
Mark Begin—marks the beginning of information.
Mark End—marks the end of information.
Put Aside—puts a window aside.
Transfer—transfers marked information.
View—switches the current window in or out of View Mode.
Zoom/Unzoom—zooms the window you are working on to a full screen window, or unzooms it from full screen back to its original window size and position.



Photo 2: WindowMaster from Structured Systems Group.

nificantly limited. Users might find that the ability to shift between different programs or contexts quickly is ultimately of more value than the ability to display several documents or programs at once.

As long as DesQ is able to hold different programs in RAM, context switching between them is virtually instantaneous. However, when DesQ is forced to swap programs between RAM and disk, it doesn't seem to be quicker than the time it would take to perform the same operation from DOS.

Finally, software compatibility seemed higher on DesQ than on any of the other programs I experimented with. DesQ was able to run everything I tried; however, several arcade-style games caused the program to hang when I called the DesQ menu.

WINDOWMASTER

WindowMaster is a recently introduced multitasking window-based user interface. It is optimized for Structured Systems Group's own applications that normally run under CP/M-86: Word Right, NAD (a mailing-list database-management program), and Magic Spreadsheet; however, it will run other applications programs as well. In terms of documentation, WindowMaster is one of the simplest of the five window man-

agers, yet it also has the capability to create script macros similar to DesQ. It will allow several MS-DOS and CP/M-86 programs to run concurrently, and it offers simple interwindow data transfer. Multitasking in WindowMaster is done by time slicing, that is, it allocates each task a small amount of processor time. However, there is no way to control task priorities.

In a sense, WindowMaster has extended MS-DOS to support CP/M-86. (Concurrent DOS is a version of CP/M-86 that has been extended to support MS-DOS calls.) The program includes a copy utility that permits the import of CP/M-86 programs and documents.

Like DesQ, WindowMaster doesn't pretend to give the user a desktop metaphor. The program has no built-in provision for mouse support, and all user interaction with WindowMaster is carried out through pop-up menus containing commands that you can execute with the IBM PC's function keys.

WindowMaster will run on a system with as little as 256K bytes of RAM and two floppy disks; however, it can make use of additional RAM and can be run from a hard disk (see table 3). (The WindowMaster disk must be in the A: drive when the system is loaded.) Window-

(continued)

AT A GLANCE

Name
WindowMaster

Manufacturer
Structured Systems Group
5204 Claremont Ave.
Oakland, CA 94618
(415) 547-1567

Application programs
Existing MS-DOS or CP/M-86 programs

Consistent command structure
No

Graphics
No

Hardware required
IBM PC or compatible, 256K bytes of RAM, two floppy-disk drives

Support color
No

Multitasking
Yes

CP/M-86
Yes

Memory management
No

Data transfer
Screen memory only

Mouse support
No

Price
\$295

Master does not recognize DOS 2.0 hierarchical directories; therefore, in a system using DOS 2.0, all programs must reside in the same directory as WindowMaster in order to run.

WindowMaster functions break down into six categories: program management, window management, script management, interwindow transfer of data,

graphics, and keyboard management.

Program management is a menu item that allows the user to run a program, get information on the current status of different tasks, display a series of "advanced" function options, and copy CP/M-86 program and data files.

When a program is loaded and run, WindowMaster gives it a full screen and

allows the user to decide if he or she wants to place it in a smaller window.

The WindowMaster documentation warns that a multitasking extension to MS-DOS can be dangerous because many programs have bypassed the operating system for speed and other reasons. In practice, I found that most, but not all, MS-DOS programs I tested would run in at least some form under WindowMaster.

In grappling with misbehaved applications that write directly to the display screen hardware, WindowMaster has added a special command `RUN CONCURRENT DMA VIDEO PROGRAM`. When an application is invoked with this command and is not in the active window, WindowMaster suspends the program so that it will not write all over the display screen. WindowMaster additionally gives these programs a full display when they are active.

It is also possible to map a misbehaved application that is only writing to part of the screen into a window so that the portion of the program where output appears will be visible and the rest of the program will be hidden. For example, WindowMaster could place WordStar in a window at the top of a screen while a long document file is being printed. During this time Wordstar only updates the top portion of the screen.

From the program-management menu WindowMaster permits the user to display an information screen that shows a listing of currently running tasks, their status, and available memory. WindowMaster uses the cursor keys on the numeric keypad to size windows on the display screen. It also offers a mode that permits a user to switch quickly between different tasks or windows by pressing the Space Bar. To set a new active task, the user presses the Return key.

A Script in WindowMaster is a group of saved keystrokes. The program differentiates between interwindow and intrawindow Scripts and allows each to be defined by invoking the Script mode, performing the desired task, and saving the Script to disk when finished.

WindowMaster permits the transfer of data from one window to another and will permit manual or automatic filtering of characters that are sent between different tasks. If you choose automatic

NOW!
your personal computer can see

with
oculus™

**THE REMARKABLE NEW VISION BOARD INTERFACE
THAT'S DOWNRIGHT AFFORDABLE**

Both our Oculus-100 and Oculus-200 boards give vision to your IBM® PC or compatible computer. And, both convert your PC into an image processor.

For high performance, choose the Oculus-200 board. Priced at \$1995, it incorporates features you'd expect from vision systems costing twice as much. In fact, the Oculus-200 is a real-time, 30 frames/second video digitizer with 256K bytes of memory. Thanks to its on-board video output, the processed image can be displayed on an auxiliary monitor, with graphic overlay and vectoring capabilities. The Oculus-200 transforms, in real-time, the image received from a standard video camera into an array of 512 x 512 pixels with 128 shades of gray. Which means that the digitized image will be as sharp as your original subject.

For those special applications where a real-time binary system is just right: take a close look at our other board... the Oculus-100. It digitizes a TV image, in real-time, into an array of 512 x 512 black and white pixels that can be processed by your personal computer. And the image can be displayed, at a lower resolution, on your PC monitor. With its 32K bytes of memory and \$695 price tag, the Oculus-100 is ideal for the rapid processing of contrasting images.

Applications for the Oculus boards can include: page reading — facsimile — teleconferencing — surveillance/security — microscopy — graphic arts — factory inspection — and much, much more. Dedicated software for these applications is available from our company. Each board is delivered with menu driven imaging software, cable and manual. Camera and display monitor are not included.

For more information about our Oculus boards, software or volume discounts, call us toll free at (800) 361-4997, in Canada call (514) 651-2919. Or write to:

**CORECO INC. The COmputer REsearch COmpany, 547 St. Thomas,
Longueuil, Quebec, Canada J4H 3A7**

IBM is a Registered Trademark of International Business Machines Corporation.

filtering, a filter program creates a file that governs certain aspects of the information transfer, such as the characters to send after each line, the characters that indicate the end of a line, the characters to send before a string field, etc.

A graphics program that permits creation of pie, bar, and line charts on a color display, dot-matrix printer, or the HP 7470A color plotter is also included. However, the program is not integrated with other WindowMaster functions.

Finally, it is possible to define programmable function keys under WindowMaster. This option lets the user define and save single keys for either specific applications or Scripts.

USER INTERFACE

The WindowMaster user interface consists of a Spartan set of menus and makes no provision for either mouse support or an expert mode to permit experienced users to circumvent the menus. However, the multitasking feature of WindowMaster is interesting. I set the program up running WordStar. Crosstalk (a communications program), and a simple BASIC program that displayed elapsed time. When the BASIC program was moved to the background, it was suspended by WindowMaster, yet while Crosstalk was receiving a file through the IBM PC communications port it was possible to run the BASIC program in the foreground while Crosstalk continued to receive the file in the background. When Crosstalk was again made the active task, its screen was updated from the point where it had been frozen as a background task with no loss of information.

Of course, the drawback to a multitasking operating system on the IBM PC is that there is frequently a noticeable effect on individual program performance.

Table 3: Special WindowMaster install files for misbehaved programs.

Crosstalk	Lotus 1-2-3
pfs:file	dBASE II
Multiplan	SuperCalc II
WordStar	TK Solver
BASIC	Word Perfect
BASICA	

WINDOWS

Late last year Microsoft announced that it would be offering a window manager as an extension to the MS-DOS operating system. As the operating-system developer, Microsoft enjoys special advantages because most independent software developers will view the Micro-

soft visual shell as a standard, and because Microsoft has a more intimate working knowledge of the MS-DOS operating system.

To date Microsoft has been able to attract commitments to support Windows from both hardware and software companies. More than 20 IBM PC compati-

(continued)

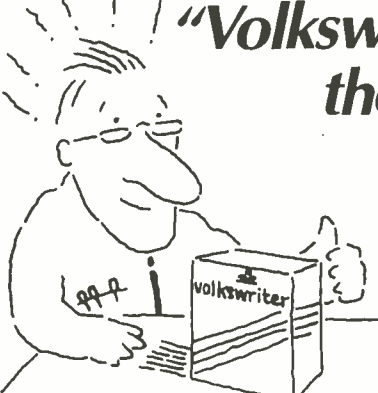

"Volkswriter® Deluxe..." the critics' choice!

“

Thirty word processing programs were reviewed ... no other program received a higher overall evaluation than Volkswriter Deluxe."
Software Digest Ratings Newsletter, January 1984

"If WordStar™ set a standard ... Volkswriter Deluxe sets a new standard for transparency, simplicity, and speed. You can learn Volkswriter in under an hour ... because it does so many things exactly the way you think they should be done."

"VOLKSWRITER DELUXE is the best buy in the IBM-PC™ writing tool arena."
Charles Spezzano, Whole Earth Software Review, January 15, 1984

"Volkswriter Deluxe ... a simple way to word processing power ... for writers who like to think."
Washington DC Capital PC User's Group Vol. 3, #4

"Lifetree ... provides exceptionally helpful and competent assistance to registered owners, and the company's update policies are excellent."

"In sum, this is a unique word-processing program."
John Lombardi, Reviewer, InfoWorld, April 16, 1984

”

We couldn't have said it better ourselves!

Suggested Retail Price: Volkswriter Deluxe \$295 for the IBM-PC, PC compatibles, TI Professional™ and TRS-80 Model 2000.™

"Simply, amazing"

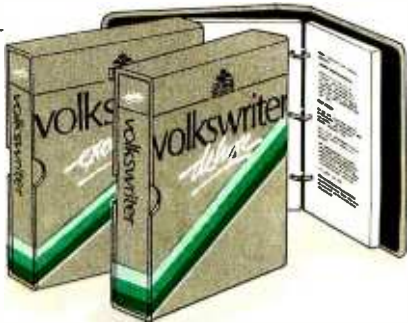



LIFETREE SOFTWARE INC.™

411 Pacific Street • Monterey, California 93940
(408) 373-4718 / TWX 176786

IBM PC is a trademark of International Business Machines. TI Professional Computer is a trademark of Texas Instruments. TRS-80 Model 2000 is a trademark of Tandy Corp. WordStar is a trademark of MicroPro. Volkswriter Deluxe and the Lifetree logo are trademarks of Lifetree Software Inc.
© 1984 Lifetree Software, Inc.

AT A GLANCE

Name

Windows

Manufacturer

Microsoft
10700 Northrup Way
Bellevue, WA 98004
(206) 828-8080

Application programs

Existing MS-DOS and specially designed programs

Consistent command structure

Yes

Graphics

Bit-mapped

Hardware required

IBM PC or PC compatible. 192K bytes,
two floppy-disk drives

Support color

No

Multitasking

Yes

CP/M-86

No

Memory management

Yes

Data transfer

High level with specially adapted programs

Mouse support

Yes

Price

To be announced

ble manufacturers were on hand at the initial product announcement to say they would offer Windows with their computers. IBM was noticeably absent from the group, however. It is still not clear whether IBM PC owners will be able to buy Windows as a retail product.

Only demonstration versions of Microsoft Windows are available currently, and at the time of this writing (late April) Microsoft is stating that it will not ship the Windows development toolkit to OEM (original equipment manufacturer) customers until sometime during May. However, in February, Microsoft held a technical seminar on Windows, and a good deal of information about the product can be gleaned from the proceedings.

As was stated previously, Windows falls somewhere between VisiOn and DesQ in its integration strategy. Windows will allow virtually any existing application to run; however, to take advantage of its user interface, programs must be rewritten specially for the system.

Like VisiOn, Windows will work only with a mouse; however, unlike most other window managers, it doesn't offer overlapping windows. Microsoft takes the view that all current windows should be visible on the screen. The company calls this the tiled approach. As you expand one window, other windows automatically adjust to accommodate the growth. The screen is divided into variable-sized columns and rows. A window can be no smaller than its command line. All the windows are simultaneously active and are not suspended until they are clicked closed with the mouse. Windows will have certain multitasking capabilities and Microsoft is billing the Windows environment as a "sneak preview" of things that will be done with MS-DOS in the future.

The anticipated release size of Windows is between 50K and 60K bytes (the current demonstration version takes about 70K bytes). Microsoft is recommending a minimum of 192K bytes of RAM with Windows. This will leave between 120K and 128K bytes of program space in a minimal system.

Each windowpane has several significant sections. The command line across the top of the window contains the window's name. System prompts, command options, and messages can also appear in this area. Additional application com-

mands can reside in a drop-down menu within the window. Each window also can have horizontal and vertical scrollbars for altering the view of the program or document.

Windows will run only on a bit-mapped display (on most systems it will run in the IBM PC high-resolution mode, but it will not offer color windows) and it is the only one of the five window managers to make extensive use of icons to represent programs, documents, and system peripherals. Microsoft claims that icons are the best way to represent applications when screen-display space is scarce.

The question of tiling versus overlapping windows has become something of a theological dispute among user-interface designers. The Microsoft case is that tiling is the metaphor of the "neat" desktop. They claim that a tiled-window manager builds a certain amount of intelligence into the window-display equation. Windows guesses about where to put and how to size a window when it is selected, and it also allows the user to override in case he or she favors another layout. Microsoft hasn't been entirely orthodox on this issue. It will be possible for individual applications to display their own overlapping or "nested" windows for menus, property sheets, or other tasks.

There will be several data-interchange options in Windows. It will be able to pass information in an internal binary format, as ASCII (American National Standard Code for Information Interchange) text, or in SYLK, and possibly in DIF as well.

One of Microsoft's greatest strengths is its contention that by using Windows, application developers will bring portability to new hardware environments. Inasmuch as Windows is designed to function like a "virtual machine" between the application and the hardware, this will be true. For example, Windows is designed so that it can easily be moved to displays with resolution higher than that of the IBM PC.

USER INTERFACE

Of the five window-manager programs discussed here, Windows most closely approximates the group of concepts that comprise the user-interface design first advanced at Xerox PARC and com-

(continued)

All data base managers can do filing, searching, sorting and reporting, but...

FormManager does it faster, easier AND lets you set up spreadsheet-type formulas.

No new systems to learn ... you can use the format you're used to.

With FormManager, you can lay out forms on a display any way you want; without programming, without any restriction. You can draw lines and boxes with only three keystrokes. Its data validation features catch errors when data is filled in. You can even specify default values (such as "San Jose" for city) to save typing.

Larger capacity than other programs. You won't outgrow it!

FormManager can handle up to 32,767 records, 500 fields per record, and 80 characters per field. Its state-of-the-art B-tree technique assures you of fast sorting and searching even when your database grows. There are several ways to search for a record randomly or sequentially.

The only program that lets you set up complex formulas ... saves hours of manual math!

FormManager's built-in math capability provides 26 general math functions beyond the usual four arithmetic functions. You can define multiple formulas for interactive calculation (as in your spreadsheet programs). Its macro facility includes repetitive and conditional statements. You can easily set up a task such as:

IF state = "CA" then TAX = subtotal * 0.065.

Fully flexible report writing. Prints data the way you want it.

Report Writer lets you produce professional reports sorted by any three fields. Other features such as page break control, calculations and formatting let you create a wide variety of reports.

If you use pre-printed paper forms, you'll love FormManager's advanced printing features. You can set up your own format to print on almost any form, from invoices to insurance forms to loan application forms.

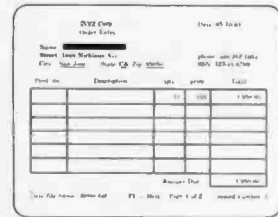

FormManger is the only program that lets you set up forms the way you want.

The best feature of all is the cost ... only \$195. A demo disk is available for only \$5. Send for your copy today.



BIT Software Inc.,
Box 619, Milpitas,
CA 95035

(408)262-1054

New dimensions in Bible study.

THE WORD processor
\$199.95

The KJV Bible on disks. Search for any word or phrase, create personal indexes, print any verse. Build your own library of Scripture references.

THE GREEK transliterator
\$199.95

Start with any English word and find the original Greek, with definition and word roots. For any Greek word find every translation. Includes STRONG'S CONCORDANCE and the KJV New Testament. (Apple and IBM only.)

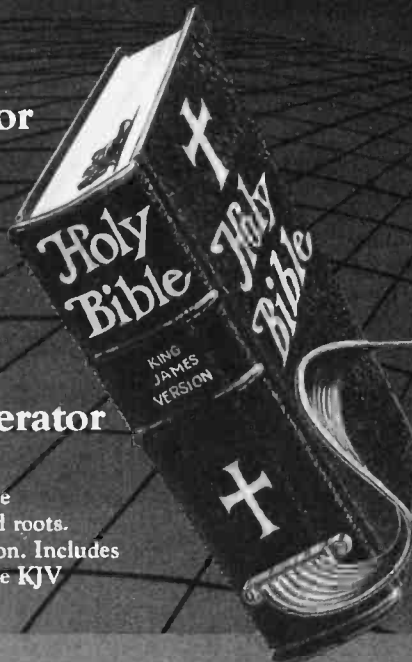

TOPICS \$49.95

An index to over 200 Scripture subjects.

PEOPLE \$49.95

An index to over 140 Biblical people.

For Apple, IBM PC, Commodore 64, TRS80, Kaypro, CPM 2.2, MS-DOS.

Bible Research Systems

9415 Burnet Road #208 • Austin, TX 78758 • (512) 835-7981

Include \$3 postage/handling

"Software for personal Bible study"

EXPOTEK

1-800-528-8960
24 HOUR ORDER LINE

Quality Products
Guaranteed Low Prices

PRINTERS

C. Itoh	Okidata
1550 AP 499	All Models Call
1550 BCD 549	
8510 AP 319	Panasonic
8510 BC2 419	All Models Call
8510 BPI 389	
A10-20 449	Qume
F10-40 899	Letter Pro 629
F10-55 1179	11/40 WIBM IF..1369
	11/55 WIBM IF..1569
Comrex	Silver Reed
CR11 439	EXP 400 Call
Daisywriter	EXP 500 385
2000 985	EXP 550 479
Diablo	EXP 770 Call
620 API 739	
630 API 1699	Star Microtronics
630 ECS 1999	All Models Call
Epson	Tally
All Models Call	Spirit 80 289
Juki	160L w/Tractor...559
6100 439	180L w/Tractor...779
NEC	
2050 779	Toshiba
3510 1219	1340 749
3550 1499	1351 1359
7710 1649	

DISK DRIVES

ACI 5.10.20 MB Hard Disk System	
w/6 MB Cartridge Back-up	Call
TEAC 55B slimline DSDD	179
TEAC 55F slimline DSQD	249
Control Data full height	219
Tandon 100-2	209
Maynard 10MB-WS-1 with EPROM	999
Maynard 10MB-WS-2 with EPROM	1149
Tallgrass Tech Hard Disk System	Call

MONITORS

Taxan 105 Amber/100 Green	109/104
420 IBM RGB Look alike	Call
RGB-III Super Hi Res	Call
Amdek 310 Direct IBM Plug In - A or G	Call
300 Amber Green	154/144
PGS-HX-12	466
PGS MAX-12 Amber	179
Leading Edge Amber, Green, Color	Call

BOARDS

Quadram all products	Call
AST latest boards	Call
Hercules Graphics Card	369
Paradise Multidisplay Card	379

MODEMS

Novation-Access 1-2-3 w/Crosstalk XVI	Call
Smart Cat 300/1200	Call
Hayes Smart Modem 300/1200	212/499
1200B	Call
Anchor Volksmodem	Call
Signalman Mark VII/XII	Call
Microcom Era 2 Internal Model w/Software	349

ACCESSORIES

Standby Power Systems	Best Price
Switch Boxes Parallel & Serial	Save
Chips 64K	55
Koala Pad w/Graphics Illustrator	Call

DISKETTES

3M Call Memorex Call

2017 E. CACTUS STE. B
PHOENIX, AZ 85022
(602) 482-0400

WINDOW MANAGEMENT

AT A GLANCE

Name
 VisiOn

Manufacturer
 VisiCorp
 2895 Zanker Rd.
 San Jose, CA 95134
 (408) 946-9000

Application programs
 Calc, Graph, Word, Query

Consistent command structure
 Yes

Graphics
 Bit-mapped

Hardware required
 IBM PC XT, Eagle and Compaq, TI Professional, Wang PC, Honeywell 7900, color/graphics adapter, 512K bytes of RAM, optical mouse

Support color
 No

Multitasking
 No

CP/M-86 support
 No

Memory management
 Yes

Data transfer
 High level

Mouse
 Yes

Price
 \$95

mercialized by Apple Computer Inc. Both DesQ and WindowMaster are implemented on character-oriented displays and are therefore better suited for keyboard input. VisiOn has chosen to eschew icons and has built-in interaction concepts that substantially differ from the Star, Lisa, and Macintosh. The final user interface for Concurrent DOS has still not emerged and as such the one currently available should be thought of as an interim design.

Microsoft has stated its commitment to adhere to the Apple Macintosh user interface to ease the design burden on third-party software developers. And although there are substantial differences between the interfaces (such as tiled windows and two mouse buttons instead of one), there are also significant points of compatibility. For example, there will be strong similarities between Microsoft application programs running on Macintosh and the same application running on the IBM PC in the Windows environment.

In the Windows operating environment, both mouse buttons of a two-button mouse function alike. However, in a Windows application program, mouse functions are defined by the application and each button can have a separate purpose.

Another important characteristic of Windows is the degree to which it insulates the user from the operating system. Windows greatly reduces the number of verbs (copy, delete, name, print) the user is faced with to interact directly with the operating system.

VISION

VisiCorp first announced VisiOn at the November 1982 COMDEX computer show in Las Vegas. At the time, VisiOn was the first integrated-desktop software environment for personal computers. When VisiOn finally was shipped in early 1984, the market had grown dramatically more competitive. Not only had Apple introduced both Lisa and Macintosh, each with its own integrated-desktop software, but other window managers and a growing variety of integrated programs had also reached the IBM PC marketplace.

Application software must be specially developed to run as part of the VisiOn desktop system. VisiCorp offers

(continued)

**Thinking of
buying a modem?
You owe it
to yourself to check out the Qubie' 212A modems.**

Inside Outside

Just a few years ago, computers needed big air-conditioned rooms to operate in, balefuls of money to buy, and a team of wizards to keep them running. The constant march of technological progress has given more and more powerful machines which cost less and less. Desktop computers more powerful than the early mainframe computers are the result of the evolution. The Qubie' modems represent the latest extension of this progress. Because up until now, a 212A compatible modem cost at least \$500. Through the use of four low-cost, state of the art microprocessors, we can now offer two versions of our full featured 212A modem at prices the competition sells 300 baud modems for.

In The Beginning

In September of 1983 we introduced the first 212A modem card for the IBM PC available for under \$300. The PC212A/1200 is a complete communications package including PC-TALK III software, modular phone cable, card edge guide, and instruction manual. The modem is an auto-dial, auto-answer type, which uses all the Hayes software commands so it can be used with any of the popular software packages including Crosstalk™ and Smartcom™. We picked the best software package we could find based on it's ease of use and features, PC-TALK III. Our modem includes features the old industry standard missed out on. Like being able to fit in one slot in a Portable PC or PC/XT.

Or an optional connector to use the modem's serial port when not using the modem. Of course the topper is the \$299 price, hundreds less than the competition.

Now Available Outside

Our standalone modem, the 212E/1200 can be used with any computer or terminal with a RS-232C serial port. You can use any Hayes compatible communications software on anything from an Apple to a Zenith. Many owners of IBM PC's are using it because they lack available expansion slots, or have more than one computer they want to use their modem with.

It's attractive gold anodized case houses seven status lights (who says low prices means a shortage of features). It fits comfortably under a standard telephone. It is also a 212A compatible auto-dial, auto-answer modem which supports all Hayes software commands. Even the switch settings are the same, so any software giving recommended switch settings for a Hayes modem can be used, without knowing what the switches do. There is a volume control knob for easy adjustment of the speaker's output. Included in the package is modular phone cable, a cable to hook it to your computer or terminal, and instruction manual. Choose the communications package right for your needs, and you're ready to go!

Four Hearts

The heart of the Qubie' modems are four digital signal microprocessors. Two handle sending, and two do the receiving. Rather than attempt to filter all but the relevant tones used for modem communications, the

microprocessors measure the tones digitally. This allows them to overcome line noise and static better than analog filter based modems

Why Buy From Qubie'

Because you will get a product as good or better than any available, pay less for it, and get factory direct help if you need it. If at any time during the one year warranty period your modem should require service, we will fix it or replace it within 48 hours. Notice also there are no hidden charges in our prices. No extra for freight, insurance, credit cards, or COD fees. In a hurry? UPS 2nd day air service is just \$5 extra. If you are like many who say, "Nah, it's too good to be true," just apply the acid test and find out. Then you will be asking yourself, "Why should I pay what these modems used to cost?"

The Acid Test

Qubie' gives you a 30 day satisfaction guarantee on your modem. If you are not completely satisfied we will refund the entire amount of your purchase including the postage to return it. If you can, get anyone selling another modem to give you the same guarantee. Buy both, and return the one you don't like. We know which one you will keep.

IBM is a trademark of International Business Machines Corporation. Crosstalk is a registered trademark of Microsoft Inc. PC-Talk III is a registered trademark of The Headlands Press Inc.



PC212A/1200 Includes: Modem Card, PC-TALK III software, card edge guide, modular phone cable, quick reference card, and instruction manual. **\$299**
Optional external serial port connector **\$20.**

212E/1200 Includes: Standalone modem with cable (specify male or female), modular phone cable, and instruction manual. **\$329.**

Circle 150 on Inquiry card.

Order Today, Shipped Tomorrow!

All prices include UPS surface freight and insurance. Add \$5 for two day air service. For fastest delivery send certified check or credit card. Personal checks take 18 days to clear. Calif. residents add 6% sales tax. Corporations and Institutions call for purchase order details.

(800) 821-4479

Toll Free Outside California

(805) 987-9741

Inside California

QUBIE'

4809 Calle Alto
Camarillo, Ca. 93010

Tempo House, 15 Falcon Road,
London SW11 2PH, United Kingdom

© Copyright Qubie' 1984

Fall 1984 • BYTE Guide to the IBM PC • 79

Meet the

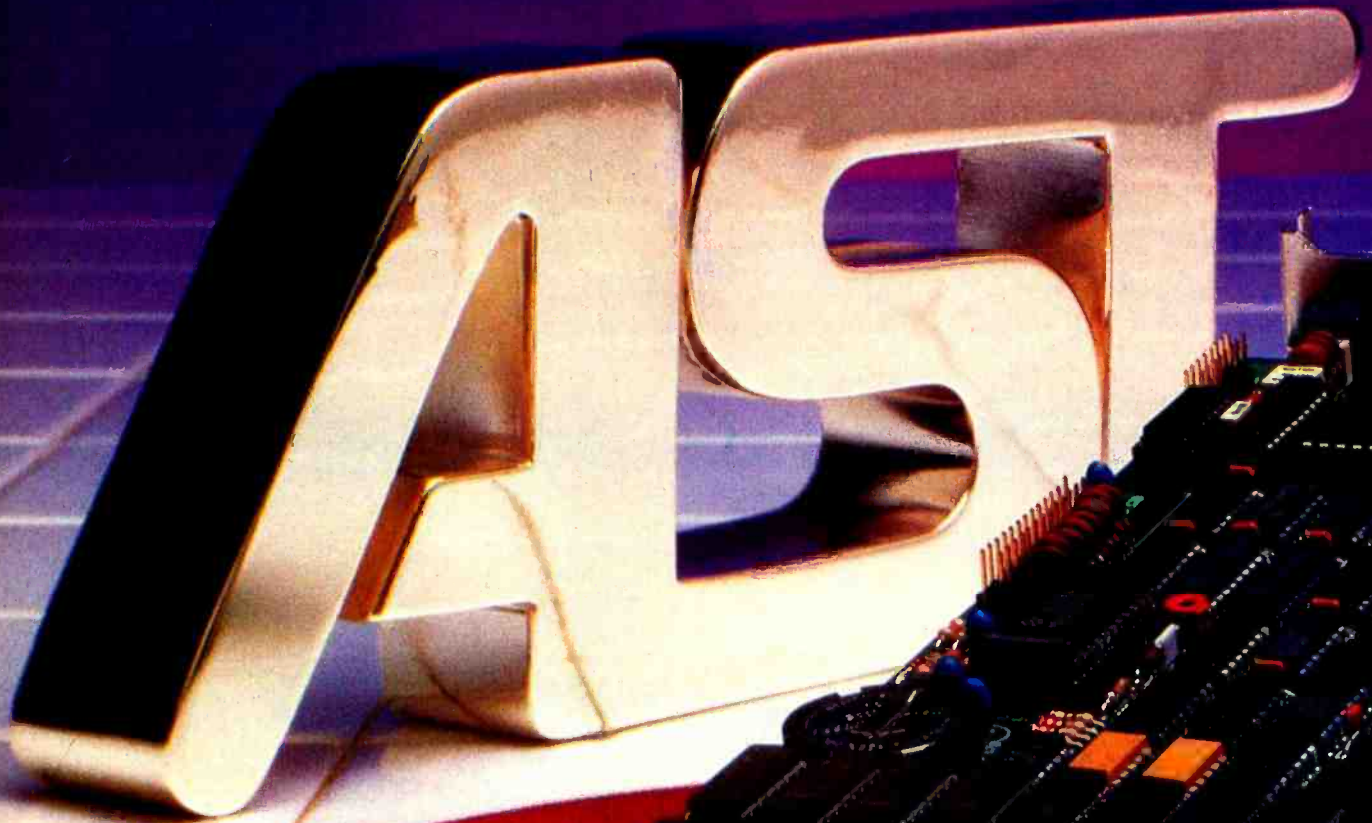

Standard.

AST SixPakPlus™ has set the standard 100,000 times.

We have manufactured and shipped more than 100,000 SixPakPlus multifunction boards—an event that proves quality and quantity are compatible. AST has maintained the same high set of quality standards from our first SixPakPlus board, to our 100,000th in less than a year. No one in the industry has set that kind of standard!

Important as it is, quality is just one of the factors that has made SixPakPlus the most popular, most respected multifunction board available today.

Broad performance capabilities is yet another.

SixPakPlus provides users of the IBM PC and XT and their compatibles with an ideal combination of enhancements to give you all these benefits on a single board:

- When you need more memory to run sophisticated software programs and process more data, the SixPakPlus gives you an additional 64K to 384K RAM.
- If you want to add peripherals such as printers, modems, mice, plotters or joysticks, we give you more Input/Output ports—serial, parallel and optional game adapter.
- More convenience, thanks to a built-in clock-calendar that

provides automatic time and date stamping.

- More productivity with SuperPak™ utility diskette including SuperDrive™, PC World's User Survey award-winner, that works like a drive but fifty times faster—and SuperSpool™ so you can print and input at the same time.

Quality even extends to the documentation, making SixPakPlus one of the easiest hardware/software packages to install and operate.

We continue to set the standards by providing the best possible user information. In fact, with our new audio cassette you don't even have to crack our manual to learn how to take full advantage of all SixPakPlus features and functions.

Now meet the standard for multifunction enhancement boards in person. Get a SixPakPlus from a dealer near you—the proven winner for your PC expansion needs. SixPakPlus is a member of the complete AST family of multifunction boards; Micro-to-Mainframe communications, LAN and graphics products.

Contact: AST Research Inc.,
2121 Alton, Irvine, CA 92714
Telephone: (714) 863-1333
TWX: 753699ASTR UR

*IBM PC and XT are registered trademarks of International Business Machines.



AST

RESEARCH INC.

Circle 1 on Inquiry card.

Both VisiOn and Windows will require mice as pointing and command devices.

third-party software developers a toolkit for developing applications for \$5500. To date, however, the only applications available for VisiOn are ones VisiCorp itself has developed: VisiOn Word (\$375), VisiOn Graph (\$250), and VisiOn Calc (\$395). A fourth VisiCorp product, VisiOn Query (\$375) will be added shortly. The VisiOn mouse is priced at \$250 and the price of the VisiOn host-applications manager was recently reduced to \$95.

In exchange for tightly specifying the applications that would run in the VisiOn environment, the program achieves both a consistent command structure across all programs running on the desktop and a higher level of program integration (meaning that data can be transferred between programs in context). For example, it is possible to continuously and automatically update a graph of spreadsheet data each time the spreadsheet is altered.

Because the command structure of VisiOn is consistent and because learning how to do something in one application will usually transfer to other applications, the program is relatively easy to learn.

Although VisiOn requires a bit-mapped display, it does not make use of icons. Programs first appear in windows on a gray background (although VisiOn uses the IBM color/graphics adapter card, it currently doesn't have color capabilities) and can be resized and overlapped according to the user's needs. Only one window at a time is active, and this is indicated on the VisiOn desktop by special framing of the active window. The limitation to the number of windows that can be open on the desktop at any one time is available system memory. VisiOn also requires a mouse pointing device that is used to execute system and program commands.

Each VisiOn window consists of three sections, or panes. A large contents

pane is continuously displayed; it contains the program or document itself. Along the bottom of the window is a dialogue pane that supplies prompts and the specific program commands. The third pane is the options pane, which is usually not visible. It gives you control over the default settings for the window or program.

At the bottom of the VisiOn display there is a separate menu consisting of eight commands that are generalized to all VisiOn programs—HELP, CLOSE, OPEN, FULL, FRAME, OPTIONS, TRANSFER, and STOP are available to the user at any point. The HELP command is designed to allow context-sensitive help. The user first points and clicks on the help menu item and then points to whatever it is in the system that he or she needs help with. The CLOSE and OPEN commands function the same way. First you select the command and then you point and click the window you want open or closed. FULL is a zoom command that will cause a selected window to fill the entire screen while FRAME allows you to locate and size the active window. The OPTIONS command will invoke the special hidden pane in each window that permits the user to specially define the default settings of each application. When the TRANSFER command is selected, the VisiOn system will lead you through a series of prompts to outline the source and destination point of data to be transferred between applications. Finally, STOP will permit you to interrupt any operation.

VisiOn filters the user's access to DOS through a special window called Archives. Archives is essentially VisiOn's organizing model, which is placed on top of the DOS 2.0 directory structure. Archives is modeled after the way information is typically stored in an office filing cabinet. In the VisiOn environment, a file is the data that is created with the VisiOn program. A folder is a collection of related files.

The VisiOn Archives has one special folder called the wastebasket folder. This is where files are placed to be disposed of. A file remains in the wastebasket until a second file is added. At that point the first file is permanently deleted. Archives frees the user from some of the file-naming restrictions of DOS and also will provide information

on each folder and file, including its type, and time and date that it was created or modified. It is possible to divide the Archives window into two panes so that the contents of several folders can be examined simultaneously.

Archives does not permit you to examine files that are not in VisiOn, but which may be in your DOS directories. In the future it will be possible, however, to transfer information into and out of the VisiOn system. VisiCorp has stated that independent software developers will be providing programs that modify MS-DOS files into a format that can be transferred into the VisiOn system.

The import and export of files from VisiOn will be done from the TRANSFER command.

VisiCorp claims that VisiOn now runs on the IBM PC XT, Eagle, and Compaq IBM compatibles; the Honeywell 7900, Texas Instruments Professional, and the Wang PC. Each of these systems must have 512K bytes of RAM, a bit-mapped screen, and a 5-megabyte hard-disk drive.

These specifications should be taken literally. I tried installing VisiOn on three separate IBM PCs with half a megabyte of RAM and hard disks that ranged from 5 megabytes to 33 megabytes, and I found that it was possible to install VisiOn on only one of these. A call to VisiCorp revealed that in order to run VisiOn on an IBM PC must be "100 percent XT compatible" and that the brand of your memory-expansion card may also affect VisiOn's ability to run your system.

The VisiOn user interface differs significantly from the Star/Lisa and Windows user-interface style. A good example of this difference is the process of closing a window on the screen. On Lisa and Macintosh the user clicks a small "close" box in the upper left-hand corner of the window. An animation effect then shows the window collapsing back into its icon. Reopening a window is done by double-clicking the icon. By contrast, in VisiOn closing (and opening) a window is a two-step process that involves selecting the close (or open) option from the menu bar at the bottom of the screen and then moving the mouse pointer and clicking it in the appropriate window. This involves two separate clicks and, potentially, moving

(continued)

Our multi-mode HERMES printers shake hands with all kinds of computers. Even some you've never heard of.

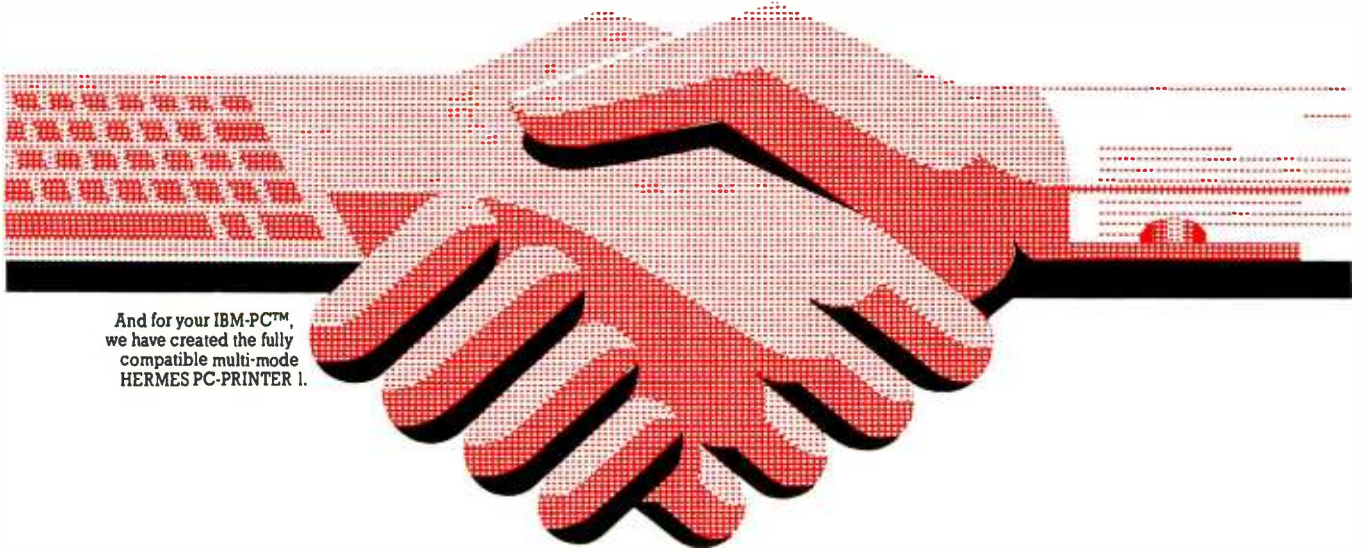

And for your IBM-PC™, we have created the fully compatible multi-mode HERMES PC-PRINTER I.

Fully compatible with your IBM-PC™, tested with Easywriter™, Multiplan™, Lotus 1-2-3™ and other software packages, the HERMES PC-PRINTER I allows you to convert your personal computer to a heavy duty professional system. IBM-PC™ users who only pick the best will also appreciate:

Its speed. Bi-directional, shortest path printing. 200 cps Data, 100 cps Near Letter Quality (single pass).

Its resolution. Finest print quality available on a matrix printer. So good you can even print signatures. Bit mapping graphics in single, double and triple density modes.

Its quality. Swiss high quality construction. Very high reliability for heavy duty use.

Its versatility. Choice of printing styles with the complete IBM™ character set tables (226 chars.). Wide range of automatic sheet-feeders with 1 or 2 bins + envelopes, single document inserter, roll-holder and tractor.

Its ease of use. Plug'n play installation. Plug it in, switch it on yourself.



To receive a sample of the finest quality matrix print-out and additional information on the HERMES PC-PRINTER I, please return the coupon below.

 **HERMES®**
The impressive printers

HERMES distributors:
 ME, NH, VT, CT, MA, RI: S & S Electronics, Inc., (617) 458 4100
 TX, AR, OK, LA: US DATA Associates, Inc., (214) 680 9700
 MD, DE, VA, DC, PA, S.N.J: MESA TECHNOLOGY Corp., (301) 948 4350
 NY State, NY City, N.N.J: TMA LOGON, (201) 646 9222
 Upstate NY: NACO ELECTRONICS Corp., (315) 699 2651
 MI, OH, KY, WV, W.PA: LOWRY and Associates, Inc., (313) 229 7200
 FL, GA, TN, AL, MS, NC, SC: GENTRY ASSOCIATES, Inc., (305) 859 7450
 CO, UT, ID, MT, NM, AZ: PAR Associates, (303) 371 4140

Please send me more documentation about your PC-PRINTER I.

Name	Title
Company	
Street	City
State	Zip
	Phone ()

Send to: HERMES PRODUCTS, Inc.
 Printer Division
 1900 Lower Road, LINDEN, NJ 07036, (201) 574 0300

AT A GLANCE

Name
Concurrent DOS

Manufacturer
Digital Research
POB 579
Pacific Grove, CA 93950
(408) 649-3896

Application programs
Existing MS-DOS or CP/M-86 programs

Consistent command structure
No

Graphics
Character-based

Hardware required
At least 256K bytes of RAM, two floppy-disk drives

Support color
Yes

Multitasking
Yes

CP/M-86
Yes

Memory management
No

Data transfer
Screen memory only

Mouse support
No

Price
\$295

the pointer back and forth across a great expanse of screen.

Changing the size or moving a window is also a more complex task in VisiOn. To resize a window you must first select the frame command at the bottom of the display screen, then select the window you wish to frame, then select the new upper-left-corner location, and finally select the lower-right-corner location. The multiple steps involved in resizing a window seem to make the whole process awkward and cumbersome.

VisiOn also has chosen to have its mouse-select button beep every time it is clicked. This becomes annoying. It is possible to change the beep to a screen flash at the point of the click; however, this isn't as elegant as the context-sensitive feedback of mice-clicks in Macintosh or Windows.

The VisiOn mouse has two buttons: the left one is a selection button and the right one is a "scroll" button. The addition of the scroll button appears to be an innovative alternative to the traditional window-scroll bars. To move a document in a VisiOn Window you simply hold down the scroll button and move the mouse in the direction you wish the document to scroll. The effect that is gained by this technique is natural and closely akin to holding your finger down on a piece of paper and sliding it along a desktop. It is possible to scroll both vertically and horizontally in this fashion.

CONCURRENT DOS

Although Digital-Research's Concurrent CP/M-86 is still a secondary operating system for the IBM PC, the company has

gotten several extensions of its operating system to market before Microsoft. Digital Research is already shipping its graphics, window, and network extensions. The company is now finishing work on an extension to Concurrent CP/M-86 called Concurrent DOS. The new operating system will run both CP/M-86 and MS-DOS software on the IBM PC and will allow the user to display up to four tasks running simultaneously on the same screen or on separate "virtual consoles" that can be arbitrarily selected (see table 4).

The initial release of Concurrent DOS will be a hybrid that will fall somewhere between DOS 1.1 and DOS 2.0. It will be able to read either 8- or 9-sector floppy disks and will access the root directory of an IBM PC hard disk; however, it will not support DOS 2.0 system calls.

Concurrent DOS has some novel aspects. For example, copy utilities (Copy and Pip) that in the past have been the property of each operating system are now both included with Concurrent. The commands that MS-DOS refers to as internal have been replaced with similar external commands. Most MS-DOS commands are available as part of Concurrent DOS; however, for obvious reasons the SYSCOM is not included. Memory allocations for CP/M-86 programs are done dynamically; however, memory must be allocated in each partition by the user for MS-DOS software using a MEM command.

In both Concurrent CP/M-86 and Concurrent DOS, the user can move between any of four different virtual consoles (these can be separate screen or

(continued)

Table 4: Some of the MS-DOS software that runs under Concurrent DOS.

dBASE II	Ashton-Tate
DR Draw	Digital Research Inc.
DR Graph	Peachtree Software Inc.
General Ledger	Continental Software
Home Accountant Plus	Multimate International Corp.
MultiMate	Microsoft Corp.
Multiplan	Lotus Development Corp.
1-2-3	Software Publishing Corp.
pfs:File	Software Publishing Corp.
pfs:Graph	Software Publishing Corp.
pfs:Report	Software Publishing Corp.
pfs:Write	Sorcim
SuperCalc 2	Sorcim
SuperCalc 3	VisiCorp
VisiCalc	Micropro Corp.
WordStar	

ATTENTION: Software Houses and Computer Manufacturers

DATA COPY SYSTEMS DELIVERS Perfect Duplicates



DCS offers the software industry the most reliable and fastest disk duplication service available anywhere. And we feature fast turnaround at reasonable prices.

We've invested in the most modern, state-of-the-art duplication and testing equipment on the market. We can duplicate disks for the **IBM PC, Apple, Radio Shack, Commodore, Atari, DEC Rainbow** and most other popular microcomputers and disk formats.

Our quality control standards are unmatched. We use only manufacturer-certified media which must pass our own stringent incoming inspection standards. Our automated equipment performs 100% bit-by-bit verification tests on every copy. And we run additional verification tests on samples from every lot.

In most cases, we even run samples on the computer they're meant for . . . just to make sure.

Whether you're an independent software author, a major software house or a computer manufacturer looking for a reliable East Coast source for disk duplication services, we want to go to work for you.

Circle 48 on inquiry card.

**HOW CAN WE
SERVE YOU?**
Let us know what we can do for you.

Write for our

Free

**DESCRIPTIVE
BROCHURE**



Or, if you need a quote on a specific job, call Paul Shahood at

(617) 295-7500

You'll get a **F-A-S-T** response



DATA COPY SYSTEMS

DATA COPY SYSTEMS, INC. / Wareham Industrial Park, 15 Kendrick Road, Wareham, MA 02571

SAVE OVER \$1500 ON YOUR NEXT IBM PC.

AND YOUR NEXT. AND YOUR NEXT. AND YOUR NEXT.



Until now, adding extra users to your office system has presented some real problems. Additional PCs are costly. And the problems get tougher when you need shared data access and communication between PCs. Alloy's revolutionary PC-PLUS solves these problems. For \$1195 for each user processor and the addition of a dumb terminal, PC-PLUS transforms your IBM PC into a powerful multi-user, multi-processor system.

In any system requiring more than one PC, PC-PLUS provides a more powerful and less expensive alternative. PC-PLUS is almost twice as fast as an IBM PC. And PC-PLUS is ten times faster than LANs (Local Area Networks) at

half the cost. It also eliminates the cost of LAN controllers, taps, and expensive cabling.

So whether you're adding your secretary or 15 colleagues, Alloy's PC-PLUS can do it at a much lower cost and with higher performance. Best of all, it's available right now. See PC-PLUS in action at Computerland®, Businessland, and at your local dealer. Or call Alloy today at (617) 875-6100.

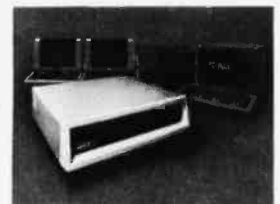

ALLOY
Computer Products, Inc.

THE BYTE COMPUTER SHOW
San Francisco, Sept. 6-9 **BOOTH 928**

Alloy Computer Products, Inc., 100 Pennsylvania Ave., Framingham, Massachusetts 01701. (617) 875-6100, TWX: 710-346-0394
In Europe: Alloy Computer Products (Europe) Ltd., Cirencester, Gloucestershire, England. Tel: 0285-68709, Tlx: 43340

Although Concurrent DOS doesn't support hierarchical files, it does offer 16 different "user areas"; it's possible to copy PC-DOS programs and data to a CP/M disk.

individual windows on the display) by holding down the Control key on the PC keyboard and simultaneously pressing the 0, 1, 2, or 3 key on the numeric keypad. Information about the currently active console is displayed in a status line along the bottom of the screen (if you are running an MS-DOS program in a console, the status line is returned to the program).

Although Concurrent DOS doesn't support hierarchical files, it does offer 16 different "user areas"; to take advantage of this feature it is possible to copy PC-DOS programs and data to a CP/M-formatted disk.

Because there are obvious opportunities for confusion (for example, both WSCOM and WSCMD on the same disk), Concurrent looks for files in a predetermined search path using both drive and file paths as criteria. If you have two files with the same name but different extensions, Concurrent uses that extension as a tie breaker. It will look first for a .cmd file (a CP/M program), then for a .com file (MS-DOS), then .exe (PC-DOS) and finally .bat (a PC-DOS batch file). It is possible to override this search pattern by specifying the extension.

Since many MS-DOS based applications write directly to the screen, Concurrent includes a SUSPEND command that will allow the user to put a program to sleep when its virtual console is not the displayed task. The problem of screen contention is not as great among CP/M applications because most of them are written in a way such that output from the application passes through the operating system before it is displayed. This also means that many CP/M applications will run in windows. A suspended MS-DOS application can continue to be viewed in a window.

USER INTERFACE

Concurrent CP/M handles window management with two utilities. WIN-

DOW is a noninteractive, command-line oriented program. WMENU is an interactive program that allows you to alter the size of windows, determine what portion of the virtual screen console is viewed by the window, hide windows, change their background and foreground color, and copy information from a window to a file or vice versa. After setting up your windows with the WMENU program (which is about 10K bytes in size), you can exit it, freeing that space in memory.

Since Concurrent DOS is limited to four virtual consoles (many more background tasks are running, but an arbitrary limit of four simultaneous applications has been established), it is also possible to display only four windows on the screen. These windows can be moved anywhere on the screen, their size can be changed, and they can overlap or extend off the sides or top and bottom of the display. If you have two monitors, it is even possible to display one virtual console on the color monitor and display three additional windows on the monochrome display.

When CP/M Windows is running, the active window is always designated by having an additional frame around its window area. At any time it is possible to zoom this window by pressing the Control and Delete keys simultaneously, so that it occupies the full screen. Pressing them again will return that window to its former position and display other windows.

There currently is no provision in CP/M Windows for a mouse, so interaction is done by entering commands from the keyboard or by selecting options from the small menu offered by the WMENU program.

CONCLUSION

Current generation graphics-oriented window software technology is literally begging for faster hardware. Either faster processors or the development of personal computers with graphics coprocessors and higher-resolution displays will make it more realistic to run multiple tasks and display them simultaneously.

Window-management software on the IBM PC does offer an interim solution toward a graphics-oriented and more interactive personal computing environment. ■

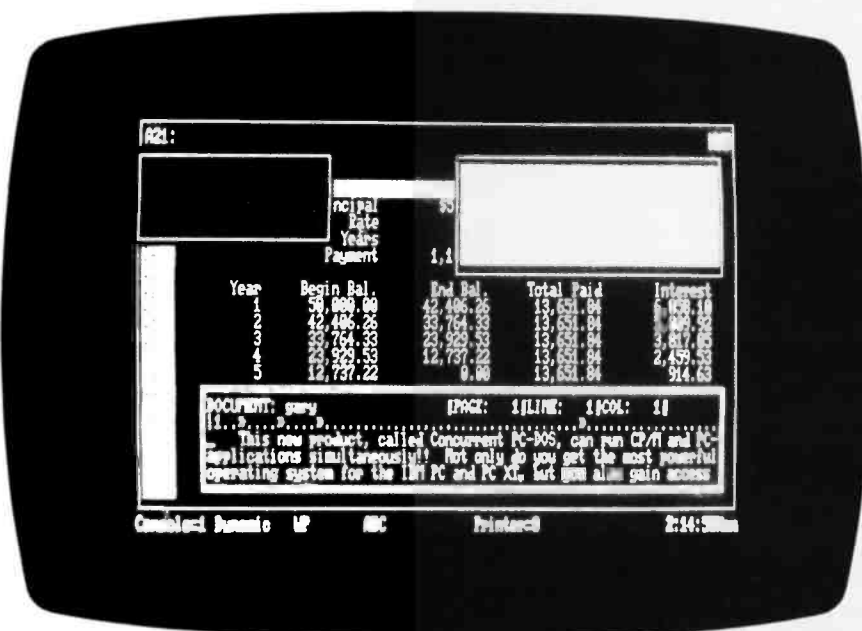

Photo 3: Concurrent DOS from Digital Research.

Introducing the new Project Scheduler 5000™

Help! The demands of managing a project have you frantically juggling people and resources. It's getting more complicated and you're about to drop the ball on profits and deadlines.

Successfully managing one project can be difficult. Successfully managing two or three projects can be overwhelming. But now, help is here for you. With Project Scheduler 5000 you can precisely forecast, schedule, control and track large projects easily and quickly. You can replace your frustration with a sense of self-satisfaction from a project well managed.

Main Frame Power — Personal Computer Simplicity

Project Scheduler 5000 brings mainframe capabilities to your personal computer.

This new generation in scheduling software makes possible what was, until now, only a dream: true interactive use and immediate response to changes and additions. You can schedule over 5000 activities spread over 10,000 time periods. What this means is that you can manage the largest projects with ease. While you probably don't need this power on a daily basis, it's nice to know that you have room to grow.

Interactive "What If" Capability

"What if" scenarios are an important source of information that allow you to make the best decision after trying the alternatives. Now you have time for this kind of in-depth planning, because updating and modifying are so simple with Project Scheduler 5000.

A scheduling package should do more than schedule. With Project Scheduler 5000 you never take the risk of making guesses instead of accurate decisions.

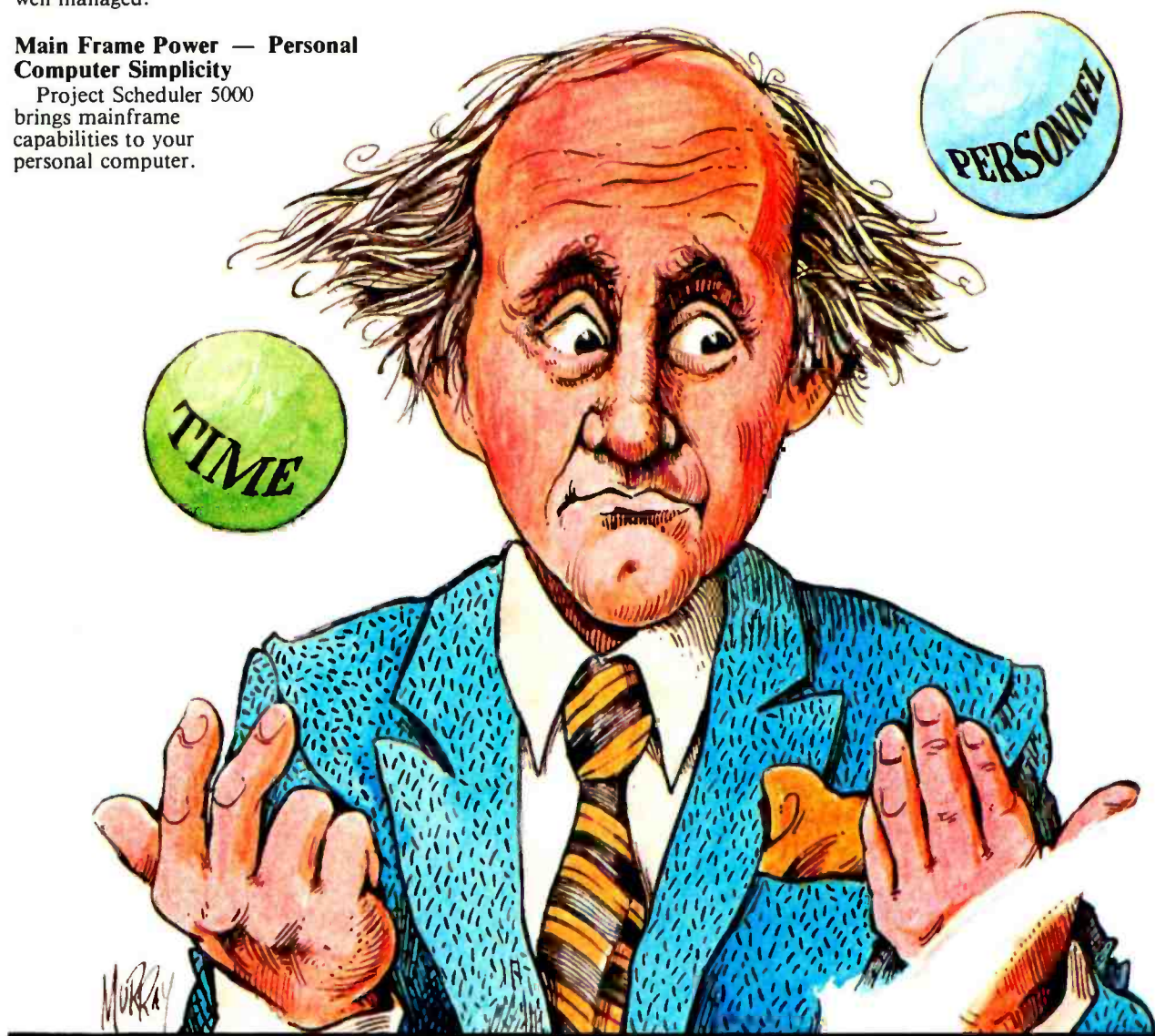

... the best solution to effective project management

On Time On Target

Project Scheduler 5000 gives you all the information you need when you need it. Instantly, you know the status of your project.



At a glance, unique plot symbols will let you know whether or not the project is on time and on target and if not, why. Meeting performance goals will become a habit.

Project Scheduler 5000 keeps you constantly informed through its partial complete capabilities. Partial complete status is displayed, reported and used to calculate "value earned".

Accurate Resource Assignment

Extensive resource categories allow you to schedule more efficiently. Using these categories, you can assign to an activity an almost limitless amount of resources. In addition, these resources can be assigned at any point within the activity timeline providing the accuracy you need to build realistic resource profiles by person, labor grade, or other types.

Integration Of Multiple Projects

Keeping track of how a resource is used from project to project can be extremely difficult. Not with Project Scheduler 5000. The program can combine projects to give you a complete overview of where and when resources are used. Graphic presentations can be condensed allowing you to visually compare multiple projects quickly and easily. Think of it! You can simultaneously manage several projects and be on time and meet or beat cost projections on each one.

Get The Picture Any Way You Want It

Hours, days, weeks, and months. You can select the resolution you need. In addition, you can break days into as many as 99 units to provide detailed shift or hour resolution. Get the big picture of your schedule on the screen or report by selecting a compressed format which displays up to 60 days, weeks or months of a project.

Fast Comprehensive Reporting

Communicating project information is no longer the time consuming task it used to be. An enhanced report generator synthesizes project information into reports on resource allocation, status, schedule and cost at both the project and the detailed activity level. You can interactively define special reports to give you all the detail you need. Reports and Gantt plots can be printed on hard copy or stored on disk for future use. Presentation quality graphics are available on a color plotter. Additionally, a spreadsheet interface provides labor and cost transfers for further analysis.

Integrated Graphics Power

Project Scheduler 5000 plus Graphics complements the outstanding scheduling and reporting features provided by Project Scheduler 5000. Using presentation quality financial line graphs, resource histograms, resource bar graphs and other high impact displays, Project Scheduler 5000 plus Graphics provides additional insight as you study in depth the effects of resource allocation, labor usage distribution and cost spreads.

With this control tool you can also track your original cost estimates against updated forecasts and expenditures. Project Scheduler 5000 plus Graphics will help eliminate the possibility that you'll overlook critical costs and deadlines.

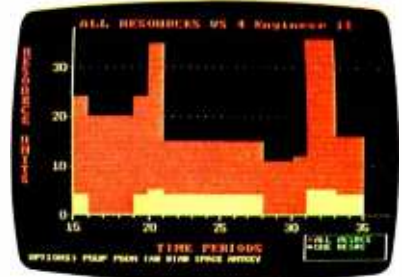

Available for PC or MS DOS:

IBM PC or XT
TI Professional
Wang PC*
Grid Compass*
DEC Rainbow*

*Project Scheduler 5000 plus Graphics available 4th quarter 1984.

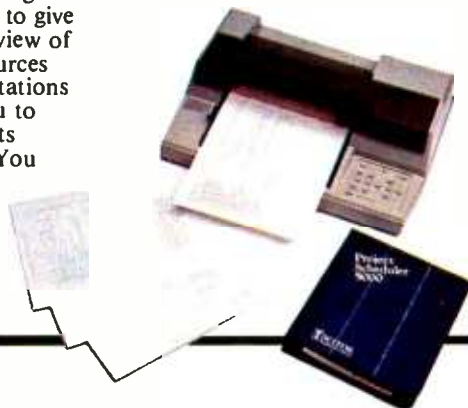

SCITOR

SCITOR CORPORATION
256 Gibraltar Drive
Sunnyvale, CA 94089
(408) 730-0400

ORCHID REWRITES AESOP'S FABLES



With PC TURBO...Speed Wins the Race.

In business, success comes to those who win the race against deadlines and competition. The IBM™ PC is a great tool, but valuable time can be wasted waiting for it to recalculate spreadsheets, retrieve data, or execute the newer and more complex software packages. PCTurbo™, new from Orchid, can help you win and enjoy the fruits of success.

PCTurbo is the ultimate IBM PC productivity enhancement. It boosts the execution speed of your PC so you can get more done in less time. And it's transparent to existing programs such as WordStar™, Lotus 1-2-3™, and dBase II™. So, with PCTurbo, your PC looks and acts the same as before; it just runs faster.

Who needs PCTurbo? Anyone who ever waits for their PC to finish executing so they can run something else. Programmers wait-

ing for compilers to finish before testing a new feature. Businessmen waiting for a data base to retrieve account information. Word processors waiting for the spelling checker to finish before printing.

PCTurbo does more than just speed up the PC. It extends the life of slower, older pro-

grams. It provides a base for new sophisticated software. And it protects your PC investment. You get your work done quicker and decisions made sooner. The very reasons you got a computer in the first place. Write or call for more information.

TECHNICAL DETAILS:

Hardware

- One slot plug-in board with high-speed 16-bit processor (8086 or 80186)
- Up to 640K on-board memory for a maximum of 1.28 Mbytes total PC memory.
- Simple "one step" installation.

Software

- Runs IBM PC-DOS 2.0/1 on either the IBM PC or XT.
- Provides disk caching, RAM disk using available PC memory up to 640 Kbytes.
- Concurrent program execution available soon.

Circle 129 on inquiry card.



ORCHID TECHNOLOGY
47790 Westinghouse Drive
Fremont, CA 94539
(415) 490-8586 Telex: 709289

PCTurbo is a trademark of Orchid Technology. IBM PC and XT are trademarks of International Business Machines Corporation. WordStar is a trademark of MicroPro. Lotus 1-2-3 is a trademark of Lotus Development Corporation. dBase II is a trademark of Ashton-Tate.

BY MORTON GOLDBERG

TWO LOGOS FOR THE IBM PC

Two Logos, one by Digital Research and another from IBM, share many features, but choosing the better package proves difficult

I have never been comfortable with BASIC. We get along all right for quick-and-dirty programs, up to 60 lines or so. Beyond that, it's strictly no go. For anything larger, I need a language that lets me work with modules to build a large program from a bunch of small ones. BASIC is hostile to this approach, especially in the case of subroutines. On the other hand, I strongly believe that programs should be coded and tested on an incremental basis. Changes in the program code should be made a little at a time and tested immediately. BASIC, because it is an interpreted language, makes this easy to do. Most modular languages, because they are compiled, are inferior to BASIC in this respect.

For a long time I have been searching for a language that is equally friendly to both modular design and incremental coding and testing. My quest has led me to try FORTH, LISP, and now, Logo. Proponents for each of these languages make similar claims: they all are supposed to have the power of a modular programming language coupled with the productivity of an interpretive language. A description of Logo by its originator, Seymour Papert, follows. (Papert always writes "LOGO;" but just about everyone else writes "Logo.")

Characteristic features of the LOGO family of languages include procedural definitions with local variables to permit recursion. Thus, in LOGO it is possible

*Logo is interactive,
modular, extensible,
recursive, and scoped
—all this and easy
enough
for children too.*

to define new commands and functions which then can be used exactly like primitive ones. LOGO is an interpretive language. This means that it can be used interactively. The modern LOGO systems have full list structure, that is to say, the language can operate on lists whose members can themselves be lists, lists of lists, and so forth.

... An example of a powerful use of list structure is the representation of LOGO procedures themselves as lists of lists so that LOGO procedures can construct, modify, and run other LOGO procedures. Thus LOGO is not a "toy," a language only for children. The examples of simple uses of LOGO in this book do however illustrate some ways in which LOGO is special in that it is designed to pro-

vide very early and easy entry routes into programming for beginners. ...

—From *Mindstorms: Children, Computers and Powerful Ideas* (New York: Basic Books, 1980, p. 217)

From the quotation, you can see that Logo must be the very model of a modern major computer language: interactive, modular, extensible, recursive, and scoped—all this and easy enough for children, too.

I have used two of the Logos on the market for approximately 10 weeks: DR Logo by Digital Research Corp. and IBM Personal Computer (PC) Logo by Logo Computer Systems Inc. (which has also produced Apple Logo). I believe I have learned enough during this period to make a fair assessment.

INSIDE THE SLIPCASES

Both Logos come packaged in a shrink-wrapped, 8- by 9.5-inch slipcase holding a binder. Nevertheless, they are easy to tell apart. IBM, showing its marketing skill, has colored the IBM PC Logo slipcase and binder a bright lemon yellow, which certainly stands out on the dealers' shelves. DR Logo comes in the same beige Digital Research uses for all

(continued)

Morton Goldberg (3628 Alpine Dr., Ann Arbor, MI 48104) does numerical analysis and research for the Environmental Research Institute of Michigan.

AT A GLANCE

Name

IBM Personal Computer Logo

Type

Interpretive programming language system

Version tested

1.0

Manufacturer

Logo Computer Systems Inc.
222 Brunswick Blvd.
Pointe Claire, Quebec H9R 1A6
Canada

Publisher and distributor

IBM Corp.
Personal Computer Sales
Boca Raton, FL 33432

Price

\$175

Format

5¼-inch floppy disk

Software required

None—comes complete with PC-DOS 2.0 operating system

Computer

IBM PC or PC XT with 128K bytes of RAM, one floppy-disk drive, color/graphics adapter with monitor (supports but does not require the following: up to 256K bytes of RAM, additional floppy-disk drives, fixed-disk drive, printer, game adapter, light pen, simultaneous use of monochrome adapter if available)

Documentation

Introductory manual, reference manual, quick-reference card

Audience

People who want an easy introduction to programming; educators who want a programming environment also designed to be a learning environment; programmers who would like to use a language supporting modern programming techniques for their personal programming

offerings. With both Logos, along with the 5¼-inch floppy disk containing the Logo interpreter, you get an introductory manual, a reference manual, and a quick-reference guide. They have some minor differences. IBM PC Logo's introductory manual is spiral bound; DR Logo's is not bound but is punched to share the binder with the reference manual. IBM PC Logo's quick-reference guide is an accordion-folded card; DR Logo's is a small, staple-bound book. And they have some not so minor differences. I paid only \$80 for DR Logo because I was able to buy it from a software discount retail store; I paid the full \$175 for IBM PC Logo—it seems IBM doesn't allow software with the IBM label to be sold at a discount. DR Logo comes with two copies of the floppy disk because Digital Research protects the disks from being copied; IBM PC Logo comes with one unprotected disk—you make your own backup copy.

Both Logos come with a license to use what is recorded on their disks. As usual, they lay all responsibility on the buyer, while absolving the software publisher from any responsibility whatsoever. The people at Digital Research ask that you register the license. If you do, they hint you might hear from them occasionally as to bugs, fixes, or updates. IBM requires no registration and makes it perfectly clear that you are on your own.

I think all software should come with a packing slip that tells the buyer exactly what the package includes. The slip would list what files are to be found on the disks, as well as all the tangible properties, such as user manuals. However, such packing slips are more the exception than the rule, and neither of the Logos has one. I had to figure out, as best I could, what it was I had actually bought and whether anything was missing.

The IBM PC Logo floppy disk isn't copy protected. To see what was on it, I booted PC-DOS, popped the floppy into a disk drive, and typed DIR A:. I found:

AUTOEXEC.BAT	starts Logo immediately upon system boot
LOGO.COM	Logo interpreter
COMMAND.COM	PC-DOS 2.0 command interpreter
DISKCOPY.COM	PC-DOS 2.0 disk copy utility
FORMAT.COM	PC-DOS 2.0 disk format utility
GRAPHICS.COM	PC-DOS 2.0 graphics printer driver
TOOLS.LF	a collection of Logo software tools
SAMPLES.LF	menu and loader for Logo demonstration programs
FILE1.LF	demonstration program—random rhyme generator
FILE2.LF	demonstration program—procedure tree generator
FILE3.LF	demonstration program—home inventory
FILE4.LF	demonstration program—tower of Hanoi
FILE5.LF	demonstration program—hangman game
FILE6.LF	demonstration program—recursive curves
FILE7.LF	demonstration program—musical memory game
INVENT.DAT	data file for use with FILE3.LF

I expected to find the Logo interpreter, of course, and I had hoped to find something like the demo programs, but I didn't expect to find so much of PC-DOS on the disk. It's there

(continued)

ALL THE BEST PRICES

MODEMS

ANCHOR

Volksmodem.....\$59.99
Mark XII.....\$269.00

HAYES

300.....\$199.00
1200B.....\$449.00
1200.....\$489.00

NOVATION

J Cat.....\$99.99
Smart Cat Plus.....\$359.00

MONITORS

AMDEK

3000.....\$149.00
300A.....\$159.00
310A.....\$169.00
Color II Plus RGB.....\$389.00
New Color 300,400,500,600,700.....Call
Color: 4 T-IBM RGB.....\$599.00

BMC

1201.....\$88.99
1201 Plus.....\$98.99
9191 Color Plus.....\$249.00

NEC

JB 1201 Green.....\$149.00
JB 1205 Amber.....\$159.00
JC 1215 Color.....\$269.00
JC 1216 RGB.....\$429.00

PRINCETON GRAPHICS

Max-12 Mono.....\$199.00
HX-12 RGB.....\$499.00
SR-12 RGB.....\$659.00

QUADRAM

8400 RGB.....\$499.00

ZENITH

ZVM 122 Amber.....\$99.99
ZVM 123 Green.....\$89.99
ZVM 124 IBM Amber.....\$149.00
ZVM 131 Color.....\$309.00
ZVM 133 RGB.....\$429.00
ZVM 135 RGB/Composite.....\$469.00

PRINTERS

DIABLO

36.....\$1399.00
620.....\$949.00
630.....\$1749.00
630-ECS.....\$2099.00

EPSON

RX80, RX80FT, RX100.....CALL
FX80, FX100.....CALL
LQ 1600.....CALL

IDS

Prism 80/132.....CALL

NEC

2050.....\$899.00
3550.....\$1669.00

OKIDATA

82, 83, 84.....CALL
92, 93, 2350, 2410.....CALL

OLYMPIA

Compact 2 Letter Quality.....\$469.00
Compact RO.....\$499.00
ESW 3000.....\$1399.00

CALL FOR YOUR FAVORITE PC/COMPATIBLE

ASHTON-TATE

Framework.....\$439.00
dBASE II.....\$299.00
dBASE II upgrade.....\$149.00
dBase III.....\$429.00
Friday!.....\$179.00

LOTUS

1-2-3.....\$319.00
Symphony.....\$549.00

MICROPRO

InfoStar.....\$299.00
DataStar.....\$179.00
WordStar.....\$299.00
MailMerge.....\$159.00
WordStar/MailMerge.....\$339.00
PRO PACK.....\$369.00
SpellStar.....\$159.00
CalcStar.....\$99.99

MICROSOFT

Multi Plan.....\$139.00
Multi Tool Word w/Mouse.....\$299.00

PEACHTREE SOFTWARE

Peachtext 5000.....\$229.00
Peachpak (GLAPAR).....\$219.00

PFS

File.....\$89.99
Report.....\$79.99
Graph.....\$89.99
Write.....\$89.99
Proof.....\$89.99
Access.....\$55.99

VISICORP

VisiCalc 4.....\$159.00

MICROMIM

R.Base 4000.....CALL

PROFESSIONAL SOFTWARE

PC Plus/The Boss.....\$299.00

FUNK SOFTWARE

Sideways.....\$49.99

CENTRAL POINT

PC Copy II.....\$32.99

DISKETTES

MAXELL

MD-1.....\$21.99
MD-2.....\$29.99

VERBATIM

SS/DD.....\$28.99
DS/DD.....\$34.99

ELEPHANT

SS/SD.....\$17.99
SS/DD.....\$21.99
DS/DD.....\$28.99

Circle 184 on inquiry card.



AST RESEARCH

MEGA PLUS II.....as low as.....\$299.00
I/O-PLUS II.....as low as.....\$139.00
SIXPAKPLUS.....as low as.....\$249.00

MAIN FRAME

AST-5251.....\$699.00
AST-SNA.....\$699.00
AST-BSC.....\$699.00
AST-3870.....\$749.00

MONOGRAPH PLUS

Video Board.....CALL

IDE Associates

IEDAboard MPR-64.....as low as.....\$219.00
IDEAplus XPR-64 CSP.....as low as.....\$279.00
IDEAmax ZPR-64 CSP.....as low as.....\$279.00
IDEAmax ZPR-OK CSPG.....as low as.....\$229.00
IDEAcomm CPR-3278.....\$799.00

IDEAdisk

5MB to 45MB Hard-drives with removable
Cart. backup.....as low as.....\$1399

QUADRAM

Quadlink 64K.....\$479.00
Quadboard II.....as low as.....\$309.00
New Expanded Quadboard.....as low as.....\$279.00
Quad 512 Plus.....as low as.....\$259.00
Quad I/O.....\$199.00

QUADCOLOR

Quadcolor I.....\$239.00
Quadcolor II (640 x 200).....\$449.00
Upgrade I-II.....\$299.00

QUADDISK

6, 12, 20, 27, 72 Meg.....starting at \$1799

CHRONOGRAPH

Clock/Calendar.....\$89.99

PARALLEL BOARD

Printer Interface w/8' Cable.....\$89.99

QUADJET

QJ9000 Ink Jet Printer.....\$749.00

MICROFAZER

Call for Configurations P/P. P/S. S/S. S/P
Starting at.....\$159.00

EFAZER

Epson Internal Buffers

8K.....\$69.99
84K.....\$149.00

KEYTRONICS

5150 Keyboard.....CALL
5151 Keyboard.....CALL

MEMORY CHIPS

4164 Ram Chips (set of 9).....\$49.99

COMPUTER MAIL ORDER

west

VISA

800-648-3311

In NV call (702)588-5654, Dept. 103

Order Status Number: 688-5654

P.O. Box 6889

Stateline, NV 89449

canada

Ontario/Quebec 800-268-3974
Other Provinces 800-268-4559

In Toronto call (416)828-0866, Dept. 103

Order Status Number: 828-0866

2505 Dunwin Drive, Unit 3B

Mississauga, Ontario, Canada L5L1T1

east



800-233-8950

In PA call (717)327-9575, Dept. 103

Order Status Number: 327-9576

Customer Service Number: 327-1450

477 E. 3rd St., Williamsport, PA 17701

No risk, no deposit on C.O.D. orders and no waiting period for certified checks or money orders. Add 3% (minimum \$5) shipping and handling on all orders. Larger shipments may require additional charges. NV and PA residents add sales tax. All items subject to availability and price change. Call today for our catalog. CANADIAN ORDERS: All prices are subject to shipping, tax and currency fluctuations. Call for exact pricing in Canada.

AT A GLANCE

Name

DR Logo

Type

Interpretive programming language system

Version tested

1.0

Manufacturer

Digital Research Corp.
Box 579
Pacific Grove, CA 93950

Price

\$145

Format

Copy-protected, 5¼-inch floppy disk

Software required

None—comes complete with SpeedStart CP/M operating system

Computer

IBM PC or PC XT with 192K bytes of RAM, one floppy-disk drive, color/graphics adapter with monitor (supports but does not require the following: up to 256K bytes of RAM, additional floppy-disk drives, game adapter, light pen, simultaneous use of monochrome adapter if available; limited support of printer)

Documentation

Introductory manual, reference manual, quick-reference guide

Audience

People who want an easy introduction to programming; educators who want a programming environment also designed to be a learning environment; programmers who would like to use a language supporting modern programming techniques for their personal programming

because IBM PC Logo requires PC-DOS 2.0. Rather than make those IBM PC owners who use an earlier version of PC-DOS buy 2.0, IBM has chosen to distribute the PC-DOS needed with IBM PC Logo.

The demonstration programs range in quality from bad to pretty good. The home inventory program is the worst of the lot. An excellent example of how not to design such a program, it is completely user-hostile. Since it is also the only demo program that uses IBM PC Logo's extensive disk I/O (input/output) capabilities, you might want to look at it for this reason. The random rhyme generator is primitive and silly. The hangman game is just primitive. The remaining demos are the ones I rate as being pretty good. Reading the code in SAMPLES.LF, which contains the control program for the whole set of demos, is instructive because it shows how to do menu-driven program chaining in Logo.

I am always pleased when demonstration programs, simple or otherwise, are included with a programming language. Logo Computer Systems has done its customers a favor by their inclusion, especially when it puts TOOLS.LF on the disk. This file comprises a set of useful and, in some cases, extremely powerful extensions to IBM PC Logo, among which I count such things as while-loops, until-loops, and mapping functions. Since such sophisticated extensions are not covered in the books on Logo with which I am familiar, their inclusion in TOOLS.LF is of great value to the neophyte Logo programmer.

While I had no trouble finding out what was on the IBM PC Logo disk, I cannot say the same for the DR Logo disk. When the DR Logo disk is booted, it puts you right into Logo. Although CP/M-86 is on the disk, I couldn't get at it to use its DIR command, and even if I could, I wouldn't trust the results. Remember, the disk is copy protected, and such disks often have strange directories. I must admit I'm not sure I know exactly what is on the DR Logo disk even now. The documentation says nothing about anything being on the disk similar to the tools or demo programs that come with IBM PC Logo. However, while I was working my way through the DR Logo primitives, I discovered a hidden treasure. When I tried the primitive getfs, the closest DR Logo comes to having a DIR command, I found a file with the suggestive name Blkjak.log. It proved to be a respectable implementation of blackjack with good graphics for the playing cards. The feeling of finding treasure didn't come until later, when I looked at the code. Blkjak is a far better example of Logo code than any of the IBM PC Logo samples. It is strange that Digital Research just leaves it on the disk to be discovered accidentally.

DOCUMENTATION

I have seen great improvements made in software documentation during my six-year involvement with personal computers. Two years ago I would have classified the documentation for both Logos as superior. By my current standards, they have good, say B+, documentation. But each achieves that rating in a different way.

The IBM PC Logo documentation is consistently good; it never rises above that level nor falls below it. It is carefully edited and has no typographical errors. However, the intro-

(continued)

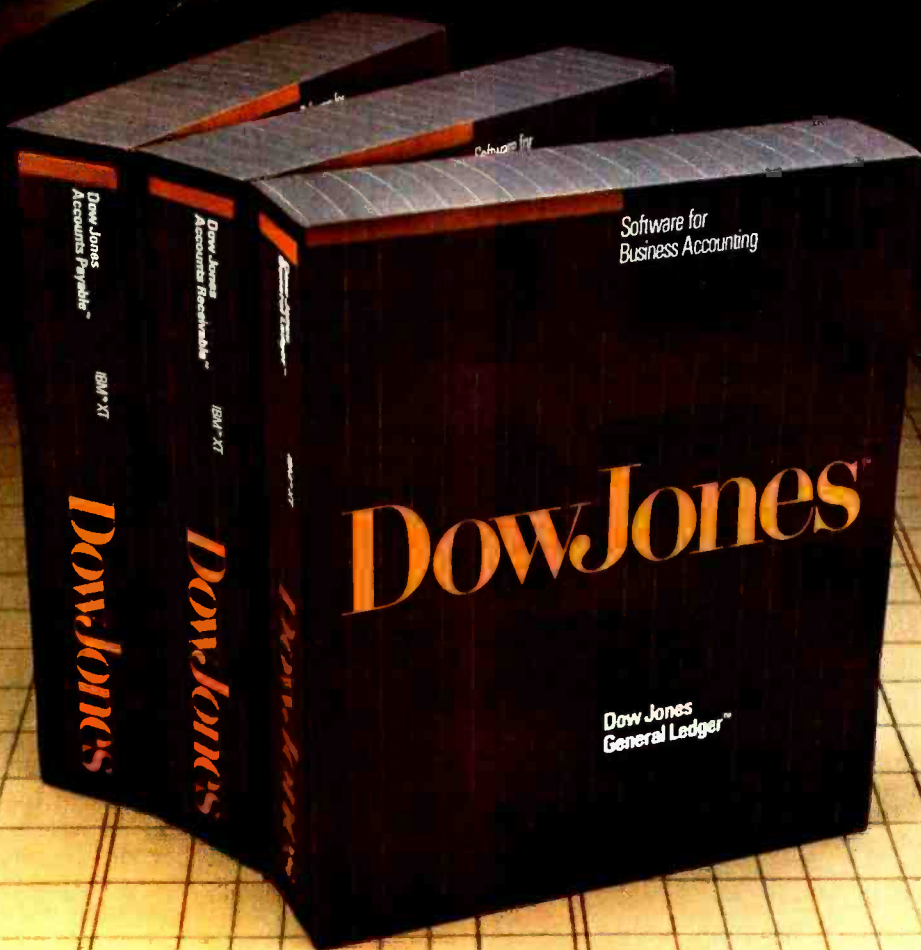

Dow Jones Accounting Series.™ Accounting software for small businesses who think big.

If you are serious about computerized business accounting, the only software to invest in is the Dow Jones Accounting Series. Your business is worth it.

No other accounting software combines the business expertise of Dow Jones with an easy-to-use format and development and support by top accountants. When you buy one of the core modules of the series — Dow Jones General Ledger,™ Dow Jones Accounts Receivable™ or Dow Jones Accounts Payable™ — you

are eligible for a free training seminar designed by Arthur Young, one of the nation's foremost accounting firms. And the Dow Jones Accounting Series is fully supported by a toll-free customer service hotline staffed by computer experts trained in accounting.

Big accounting power for the small business.

For a free brochure on Dow Jones business, investment and home software, call:
1-800-345-8500 ext. 244
(Alaska, Hawaii and foreign call
1-215-789-7008 ext. 244)

Copyright © 1984 Dow Jones & Company, Inc. All Rights Reserved.

Journal ID	Account	Debit	Credit
2	410 Sales - Commission		6,295.00
2	420 Sales - Products		572,000.00
2	430 Sales - Software		1,100.00
2	440 Sales - Other		75.00
2	450 Sales - Payable		75.00
2	460 Sales - Other		75.00
2	470 Sales - Other		75.00
2	480 Sales - Other		75.00
2	490 Sales - Other		75.00
2	500 Sales - Other		75.00
2	510 Sales - Other		75.00
2	520 Sales - Other		75.00
2	530 Sales - Other		75.00
2	540 Sales - Other		75.00
2	550 Sales - Other		75.00
2	560 Sales - Other		75.00
2	570 Sales - Other		75.00
2	580 Sales - Other		75.00
2	590 Sales - Other		75.00
2	600 Sales - Other		75.00
2	610 Sales - Other		75.00
2	620 Sales - Other		75.00
2	630 Sales - Other		75.00
2	640 Sales - Other		75.00
2	650 Sales - Other		75.00
2	660 Sales - Other		75.00
2	670 Sales - Other		75.00
2	680 Sales - Other		75.00
2	690 Sales - Other		75.00
2	700 Sales - Other		75.00
2	710 Sales - Other		75.00
2	720 Sales - Other		75.00
2	730 Sales - Other		75.00
2	740 Sales - Other		75.00
2	750 Sales - Other		75.00
2	760 Sales - Other		75.00
2	770 Sales - Other		75.00
2	780 Sales - Other		75.00
2	790 Sales - Other		75.00
2	800 Sales - Other		75.00
2	810 Sales - Other		75.00
2	820 Sales - Other		75.00
2	830 Sales - Other		75.00
2	840 Sales - Other		75.00
2	850 Sales - Other		75.00
2	860 Sales - Other		75.00
2	870 Sales - Other		75.00
2	880 Sales - Other		75.00
2	890 Sales - Other		75.00
2	900 Sales - Other		75.00
2	910 Sales - Other		75.00
2	920 Sales - Other		75.00
2	930 Sales - Other		75.00
2	940 Sales - Other		75.00
2	950 Sales - Other		75.00
2	960 Sales - Other		75.00
2	970 Sales - Other		75.00
2	980 Sales - Other		75.00
2	990 Sales - Other		75.00
2	1000 Sales - Other		75.00
2	Totals	0.00	7,012.30

By Trademark Software and Dow Jones & Company, Inc.
Available for the IBM® XT.

Circle 50 on inquiry card.

Fall 1984 • BYTE Guide to the IBM PC • 95

You would think when IBM needs EPROM Programmers, they would choose the best and the most expensive.

They don't. They only choose the best.

GTEK.



GTEK's Model 7228 EPROM Programmer (shown above), like all GTEK™ products, is IBM™ compatible. The 7228 features *Intelligent Programming Algorithms*. (It takes 7 minutes to program a 2764 EPROM using the standard algorithm. With the 7228's *intelligent* algorithm, the 2764 programs in *less than 60 seconds!*)

Device types on the Model 7228 are menu-selected and require no personality modules.

The 7228 supports Intel (both the MCS80™ and MCS86™ hex formats), Motorola™ (16, 24 and 32 bit hex formats), Tek™ and other data formats.

Many EPROM Programmers costing thousands of dollars more fail to provide the flexibility, performance and *speed* of GTEK's Model 7228, priced at just \$549!

When you need to work with 16 bit computers, utility software available from GTEK for the IBM PC™ IBM PCXT™ IBM 3270™ (and IBM compatibles) supports full 20 bit addressing.

Other IBM compatible products from GTEK include gang programmers, PAL programmers, cross assemblers, UV erasers, simulators, and cables.

For a complete listing of all GTEK products, and additional information, for IBM and IBM compatibles, call GTEK or look for us every month in BYTE Magazine.

GTEK Development Hardware/Software
P.O. Box 289, Waveland, MS 39576
601/467-8048
INC.

GTEK, IBM, IBM PC, IBM PCXT, IBM 3270, MCS80, MCS86, Motorola and Tek are all registered trademarks.

TWO LOGOS

DR Logo can't read data files created by other software you own.

ductory manual is too simple. The reference manual follows the same pattern as the Microsoft BASIC manual that comes with PC-DOS and is well organized and complete. I have yet to refer to it without being able to find what I am looking for. It gives plenty of examples, but I consider them uninspired. The two appendixes are particularly useful: one documenting the tools file found on the floppy disk and another on the Logo primitives that allow assembly language and machine code to be used with IBM PC Logo.

The DR Logo documentation is more uneven. The introductory manual is superb. It sets a faster pace than the IBM PC manual and is able to teach more of the language without being too long. It is written so carefully that it is not likely to lose even a rank beginner. Incorporated into the text are displays from its example programs. The programming projects it presents are slightly more difficult than the IBM PC Logo projects and, consequently, are more interesting to an adult. The DR Logo reference manual shows signs of hasty work, with many typographical errors. The programming examples are more ambitious than those in the IBM PC Logo reference manual, but they are sometimes botched. The manual contains no mention of the blackjack program provided on the language disk. At a certain stage of my development as a Logo programmer, I would have given up my DR Logo backup disk for an appendix with a good discussion of the internals of this program. And no mention is made of the Logo primitives for interfacing to machine-language code. The primitives exist, and they appear to be similar to the ones provided in IBM PC Logo, but they are only mentioned in the quick-reference guide, where the information given is scanty.

PROGRAMMING WITH LOGO

Well-prepared documentation is nice but not much assistance if the Logo interpreter doesn't work properly. For these two Logos, I have good news and bad.

First the good news. I find both Logos satisfy my expectations with regard to expressive power, and those expectations were high. Also, neither exhibits what I call the "Version 1.0 syndrome" the bug-infestation characteristic of newly released programming languages. Both Logos are robust; I have not been able to crash either one. I found one small bug in IBM PC Logo and only a few minor ones in DR Logo.

Both Logos do floating-point computations to a high degree of precision. DR Logo does floating-point arithmetic in accordance with the proposed IEEE standard; its floating-point routines carry approximately 19 digits internally and return 15-digit answers. IBM PC Logo has true variable-precision arithmetic. You can do arithmetic to a hundred digits or more if you have the patience.

Both Logos have built-in full-screen editors. Except for the way keys are assigned to the various editing functions, there

(continued)

Introducing the software that makes communications a piece of cake.

EasyLink™ Instant Mail™ Manager software is probably the only communications package you'll ever need. Designed to blend in perfectly with Western Union's EasyLink service, it makes the total communication process easy, instant, and automatic too.

All the right ingredients.

EasyLink Instant Mail Manager works with EasyLink service to provide automatic access and transmission of almost any type or length correspondence over the EasyLink network. So sending mail instantly to virtually any other phone-equipped PC or word processor is a snap.

You can even reach people without equipment. Thanks to EasyLink's instant access to Western Union's Worldwide communications services.

EasyLink Instant Mail Manager also lets you access your company's computer or connect instantly to other business and information services.

The frosting on the cake.

EasyLink Instant Mail Manager is more than simple "send and receive" software. With it, you also have complete word processing capabilities. So you can easily create, edit and change the format of

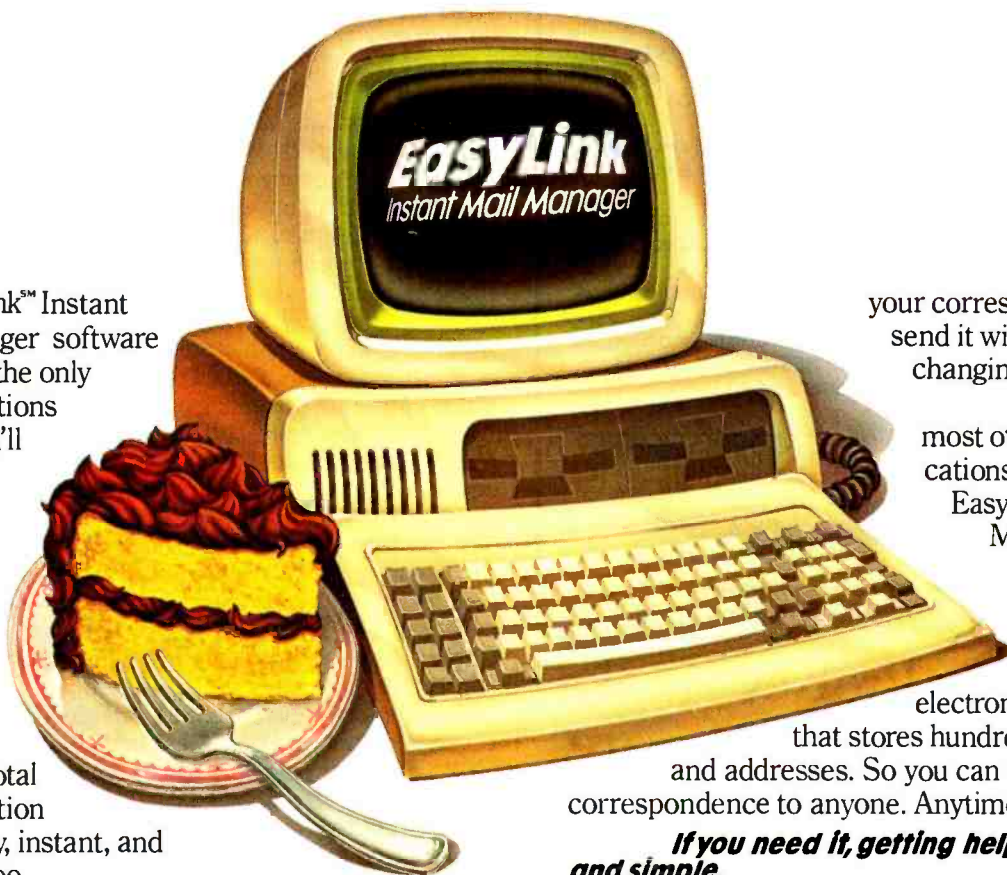

your correspondence, then send it without ever changing software.

And, unlike most other communications software, EasyLink Instant Mail Manager allows you to create and manage a permanent

electronic address file that stores hundreds of names and addresses. So you can instantly speed correspondence to anyone. Anytime.

If you need it, getting help is sweet and simple.

EasyLink Instant Mail Manager is set up to guide you step by step. From how to format messages to how you go about sending them.

EasyLink Instant Mail Manager software and EasyLink service. The perfect mix.

Available now at your computer software dealer or call 1-800-336-3797 ext. 1078 for more information.

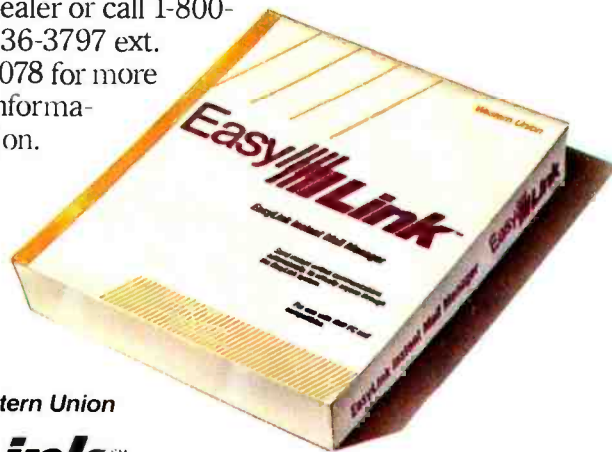

Western Union
EasyLink™

DUMP/RESTORE-XT Directory Management at Your Fingertips

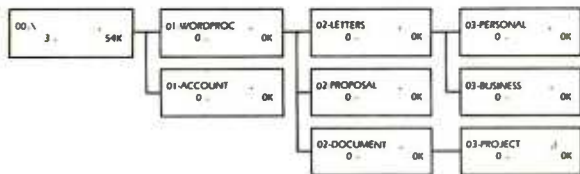

COGITATE's **DUMP/RESTORE-XT** is a package of utilities specifically designed to handle directory manipulation and file backups under MS-DOS.

▀ **COGTREE**-A graphic tree display. Hardcopies are available as well as file and directory dumps.

▀ **COGDIR**-A multiple wildcard directory utility; i.e.:
C>COGDIR\ACCOUNT*.DAT, *.IDX, *.BAK

The *.BAK excludes all .BAK files.

▀ **COGBKUP**-Reads lists created by COGDIR and compresses the files to the floppy diskette. Diskettes can be spanned and are serialized.

▀ **COGRSTR**-Reads diskettes created by COGBKUP and restores to hard disk based upon multiple wildcards.

The package includes other utilities to assist in file and directory manipulations. COGITATE's **DUMP/RESTORE-XT** is priced at \$90. Dealer inquiries welcome. MasterCard and Visa accepted.



COGITATE

24000 Telegraph Road
Southfield, Michigan 48034 USA
(313) 352-2345

TWO LOGOS

is almost no difference between them, though I prefer the DR Logo key assignments to those of IBM PC Logo. Because they are so alike, I have adopted below the fiction of a single Logo editor to describe both.

The editor is easy to learn and quite usable. It may lack the power of an editor such as FinalWord or SuperWriter, but it is more powerful than the screen editor built into Microsoft BASIC. You have the choice of editing a file or all or part of the Logo workspace, and I suppose you could use it as a general-purpose text editor, if you should want to. Its main limitations are a lack of any kind of search or search-with-replace command and an absence of commands to move or copy anything larger than a single line of text.

All the in-line editing commands work outside of the editor. If a command results in an error, you can recall it, edit it, and press the Enter key to resubmit it. This feature can be a blessing when you make a mistake in a long command.

Now the bad news. Design defects exist in both implementations. They are frustrating and quite inexplicable—at least to me; they may make perfect sense to the people who did the implementations. I'll list them, and you decide for yourself whether my complaints are legitimate.

The following characteristics of DR Logo bother me most. First, DR Logo uses just a linefeed character (0A hexadecimal) for an end-of-line marker, rather than a carriage-return linefeed pair (0D 0A hexadecimal), the standard end-of-line marker under CP/M. Whether you're doing output to a file with the SAVE command or to a printer with the COPYON and PRINT commands, you don't get carriage returns. The implication is that DR Logo is a Digital Research product that doesn't conform to Digital Research's own CP/M standards.

DR Logo can't perform any kind of stream (character-by-character) or record-oriented file I/O. This means it can't read data files created by other software you own, and it can't write files your other software can read.

And, of course, the copy-protected disk means changing disks—for large editing projects, for instance. If you want to run Logo, you boot the DR Logo disk. Then if you want to do some editing that's too much for the built-in editor, you boot the CP/M-86 disk. But when you've finished editing, you have to boot DR Logo again, and so on.

My complaints about the IBM PC Logo design make up a longer list. IBM PC Logo has only two sets of colors for the turtle's pen (DR Logo has four). While this color choice probably won't bother many people, it bothers me because my favorite graphics color scheme (a yellow turtle drawing bright red lines on a bright blue background) is missing.

This version of Logo doesn't execute an implicit SHOW command at top level. Let me explain the Logo jargon. You're at top level when the Logo interpreter is waiting for you to type something in response to its prompt. Suppose you type "2 + 2." DR Logo would respond with "4." IBM PC Logo responds with "I DON'T KNOW WHAT TO DO WITH 4." In IBM PC Logo, you're expected to type "SHOW 2 + 2." DR Logo automatically supplies the SHOW if you don't type it. This feature is what is meant by executing an implicit SHOW, clearly the right thing for Logo to do.

IBM PC Logo won't switch over to turtle-graphics mode if you are in 80-column text mode. If you try, it prints an error message. As a result, you must manually set the text width

ProKey™ makes good software even better!

Even the best software requires you to enter the same commands over and over again.

What if you could capture those commands the first time you typed them and play them back effortlessly, with one keystroke?

You can with ProKey, a powerful software enhancer that lets you define any key as an abbreviation for thousands of characters or command sequences.

Make the most of your software investment. Get ProKey! It will be the most productive \$130 you'll ever spend.

For more information, send for our free 16 page booklet, "Boost Your Productivity with ProKey."



RoseSoft™

4710 University Way N.E.
Seattle, WA 98105
(206) 524-8595

To run ProKey, you'll need an IBM PC, XT or PCjr., or any compatible, and MS-DOS. Corporate and OEM licenses available.

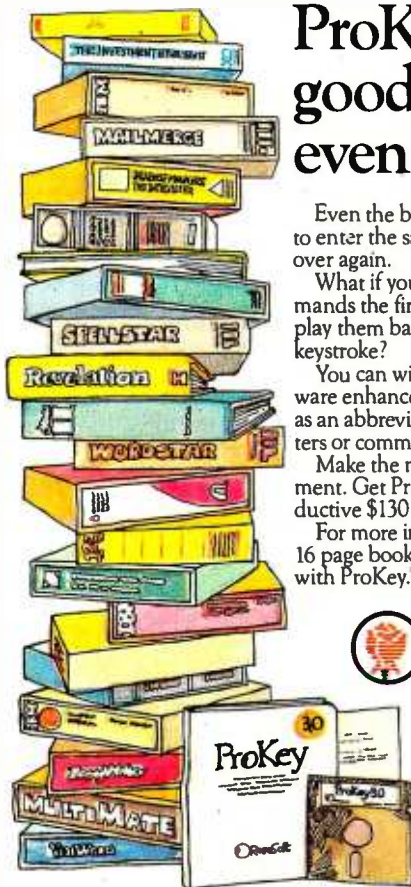

TWO LOGOS

to 40 columns and retype the graphics command it refused. DR Logo makes the changeover with no fuss at all.

IBM PC Logo has little in the way of primitives to support program debugging, which puzzles me. This lack seems inconsistent with the Logo philosophy. DR Logo has many debugging commands, some of them quite clever (see table 3).

Procedures can't be written in the indented style. Instead, IBM PC Logo forces you to write

```
TO DRAW.STAR :SIDE
RIGHT 18
REPEAT 5 [FORWARD :SIDE RIGHT 144 FORWARD :SIDE
LEFT 72]
LEFT 18
END
```

It won't accept this more readable format:

```
TO DRAW.STAR :SIDE
RIGHT 18
REPEAT 5
[
FORWARD :SIDE
RIGHT 144
FORWARD :SIDE
LEFT 72
]
LEFT 18
END
```

DR Logo allows you to write in either style.

IBM PC Logo doesn't allow comments. The TOOLS.LF file contains a procedure providing a dime-store way to add comments, but it's not a satisfactory substitute for true comment capability.

A LOOK AT LOGO PRIMITIVES

In Logo terms, the verbs that Logo "understands" at start-up are called primitives. You won't be too far off if you think of Logo primitives as being analogous to the keywords and functions of BASIC. The primary job of a Logo programmer is to "teach" the language new verbs by combining primitives and other objects (numbers, words, and lists) into procedures. Thus, the power of a Logo implementation is highly dependent on how many primitives it has. The two Logos under review are comparable by this measure. By my count, DR Logo has 187 primitives, and IBM PC Logo has 183.

Of these, 127 go by the same name and perform the same function in both versions. Fifteen more go by different names but perform functions that are the same or nearly the same. Having this large kernel of primitives in common makes translating a program from one Logo to the other easy. Further, because most of the kernel is mainstream Logo, you can adapt programs written in other Logo dialects to either of these two.

I have compiled tables summarizing all the primitives, and in doing so I have divided the primitives into categories according to their principal use. That wasn't always easy. Is file editing more of a file I/O primitive than it is an editor primitive? In such cases I virtually tossed a coin. Also, I had

(continued)

Your PC Can Be Your Next Smart Terminal.



Our software terminal emulators have the features that do the job: Full keyboard emulation. Multiple setups. TTY mode. "Smart" softkeys. Printer support. Help screens. And a friendly user manual.

Built-in text and binary file transfer is powerful and simple to use, and does not require any special host software. SmartTerm also features automatic file transfer and two different "error-free" protocols, including XMODEM.

SmartTerm 100 emulates DEC® VT100, VT102 and VT52 including 132-column display support. **SmartTerm 125** includes all the features of SmartTerm 100, plus VT125 ReGIS® graphic support. **SmartTerm 400** emulates Data General Dasher D100, D200 and D400.

Try SmartTerm for 30 days with full refund privilege. Available through your local software dealer, or Persoft, Inc., 2740 Ski Lane, Madison, WI 53713, (608) 273-6000, Telex 759491

persoft

* SmartTerm is a trademark of Persoft, Inc. • DEC, VT and ReGIS are trademarks of Digital Equipment Corp. • Dasher is a trademark of Data General Corp.

SAVE HUNDREDS OF \$\$\$ BY UPGRADING MEMORY BOARDS YOURSELF!

INTRODUCING...

IBM MEMORY EXPANSION KIT COMPAQ COMPATIBILITY

Most of the popular memory boards (e.g. Quadram™ Expansion boards) allow you to add an additional 64K, 128K, 192K, or 256K. The IBM64K Kit will populate these boards in 64K byte increments. The kit is simple to install—just insert the nine 64K RAM chips in the provided sockets and set the 2 groups of switches. Directions incl.

IBM64K (Nine 200ns 64K RAMs). . . . \$49.95

INDUSTRIES

Protect Yourself...

DATASHIELD® Surge Protector

Eliminates voltage spikes and EMI-RFI noise before it can damage your equipment or cause data loss. Six month warranty. Power dissipation (100 microseconds): 1,000,000 watts

Model 100. \$69.95

DATA SHIELD® Back-Up Power Source also available. Protect your PC or XT computer from black-outs and voltage sags.

PC200 (200 Watt Rating). \$349.95

XT300 (300 Watt Rating). \$489.95

\$10.00 Minimum Order — U.S. Funds Only
California Residents Add 6½% Sales Tax
Shipping — Add 5% plus \$1.50 Insurance
Send S.A.S.E. for Monthly Sales Flyer!

Spec Sheets — 30c each
Send \$1.00 Postage for your
FREE 1984 JAMECO CATALOG
Prices Subject to Change



1355 SHOREWAY ROAD, BELMONT, CA 94002
Phone Orders Welcome (415) 592-8097 Telex: 176043

THE LIGHT PEN FOR YOUR PC IS NOW EVEN BETTER!

- New photo-optical push-tip switch for super reliability.
- **30 DAY NO-RISK TRIAL PRIVILEGE**, and **TWO** year limited warranty.
- Ideal keyboard alternative for INTERACTIVE GRAPHICS, MENU SELECTION, EDUCATIONAL PROGRAMS, and just plain fun.
- Compatible with a growing library of software:
 - PC-DRAW (trademark of MICROGRAFX)
 - MICRO-CAD (trademark of COMPUTER AIDED DESIGN)
 - SARGON 3.0 (trademark of HAYDEN PUBLISHING)
 - and much much more. (Complete list on request).
- Very high performance and reliability for just \$195.00. (Optional three diskette software package is just \$39.00)
- Ultra-deluxe version soon available (\$295.00).
- Got another pen?? Ask about our trade-in special.



FTG
DATA SYSTEMS

10801 Dale St./P.O. Box 615
Stanton, CA 90680
(714) 995-3900

FTG will soon become PC INNOVATIONS

GET MORE FROM *dBASEII* ... AND GET IT FASTER WITH GRYPHON MICROPRODUCTS

- ***dB*Rx** is a package of *dB*BASEII and machine language routines, including *SQRT*, *EXP*, *LOG*, *LOG* BASE E, *SIN*, *COS* and *ARCTAN*, with precision to nine digits.
\$150
- ***dB*Rx/87** adds the speed of the 8087 chip to math routines, which include all *dB*Rx functions plus *X^Y*, *ADD*, *SUBTR*, *MULT* and *DIV*, with precision to 18 digits.
\$150
\$300 package includes 8087 chip
- ***dB*/RA** adds up to ten 1-, 2-, and 3-dimensional arrays and more than 65,000 memory variables to *dB*BASEII. Includes *FIND* functions for locating data instantly in arrays.
\$200
- ***RA+*** works within *dB*/RA, giving *dB*BASEII the added capabilities of instant screens, windows, animation and sound. Converts *DBF* files directly to arrays.
\$35
- ***dHELPER (Part 1)*** allows full error-checking of *dB*BASE programs, and produces formatted listings, a cross-referenced data dictionary and file analysis.
\$150

(limited \$45 trade-in on similar products from other vendors)



GRYPHON™
microproducts

P.O. BOX 6543 SILVER SPRING, MD. 20906
(301) 946-2585

TWO LOGOS

trouble at times coming up with a description for the action of a primitive that was both accurate and short. If I have botched a description, I apologize.

Tables 1 and 2 list the kernel primitives. Note that I have used the DR Logo names in table 1; the IBM PC Logo names differ only by being expressed in uppercase letters.

Tables 3 and 4 list the 45 or so primitives peculiar to each Logo. Even though they constitute only about a quarter of the total, the effects of these primitives are sufficient to give the two Logos distinct personalities. Clearly, Digital Research and Logo Computer Systems had different ideas on how Logo should be extended from the kernel of mainstream primitives. DR Logo was extended to be more LISP-like and to include more program-development tools. IBM PC Logo was extended to be better integrated into the PC-DOS environment; in particular, it was given primitives to perform file I/O.

I admit I am upset that IBM PC Logo, not DR Logo, has been extended to include file I/O. A BYTE article ("Digital Research's DR Logo," by Gary Kildall and David Thornburg, June 1983, page 208) led me to believe that Digital Research intended to break Logo out of the educational-software mold by implementing it as a serious personal computer applications language. Meeting this goal would have required major extensions to the file-handling capabilities of traditional Logo. I incorrectly assumed Digital Research was doing this. With such extensions, DR Logo might have been the leading edge of a major advance in personal computer programming languages.

SOME PERFORMANCE MEASUREMENTS

Performance testing, or benchmarking, is the sport of programmers. In this case, I raced DR Logo and IBM PC Logo against each other. I did it mostly for fun and admit I wasn't scientific in the way I went about it. Nevertheless, I got some intriguing results showing that the two implementations must differ much more internally than their surface differences suggest.

Listings 1 through 6 give the programs that I used for my tests. The programs are the IBM PC Logo versions; the DR Logo versions are the same except where noted in the footnotes. Table 5 shows the results. The column headings require no explanation, except the ones labeled Nodes Used, which relate to memory requirements. Both DR Logo and IBM PC Logo take memory as they need it from a memory pool, or workspace. The unit of allocation is called a node. In DR Logo a node is 6 bytes; in IBM PC Logo it is 5. How big a workspace you have depends on your system configuration. In my case, DR Logo's workspace is 10,780 nodes, and IBM PC Logo's is 31,093. Do not conclude from this that IBM PC Logo will run a program three times the size of the largest one DR Logo can run. While a larger workspace is better, maximum program size is not necessarily directly proportional to workspace size. The rate at which workspace is consumed is also important. As table 5 show, IBM PC Logo often consumes workspace at a considerably higher rate than DR Logo.

What happens when a program runs out of workspace? Both Logos stop while workspace is cleaned up by a garbage-collection routine. The pause, called recycling, is quite ap-

(continued)

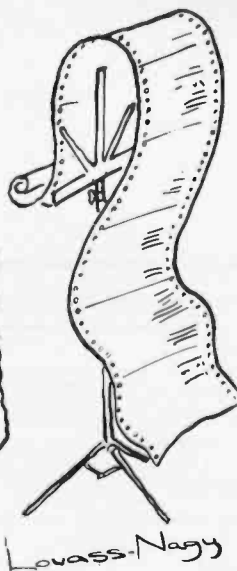

Before Johann Sebastian Bach developed a new method of tuning, you had to change instruments practically every time you wanted to change keys. Very difficult.

Before Avocet introduced its family of cross-assemblers, developing micro-processor software was much the same. You needed a separate development system for practically every type of processor. Very difficult and very expensive.

But with Avocet's cross-assemblers, a single computer can develop software for virtually any microprocessor! Does that put us in a league with Bach? You decide.

The Well-Tempered Cross-Assembler

Development Tools That Work

Avocet cross-assemblers are fast, reliable and user-proven in over 3 years of actual use. Ask NASA, IBM, XEROX or the hundreds of other organizations that use them. Every time you see a new microprocessor-based product, there's a good chance it was developed with Avocet cross-assemblers.

Avocet cross-assemblers are easy to use. They run on any computer with CP/M* and process assembly language for the most popular microprocessor families.

5 1/4" disk formats available at no extra cost include Osborne, Xerox, H-P, IBM PC, Kaypro, North Star, Zenith, Televideo, Otrona, DEC.

Turn Your Computer Into A Complete Development System

Of course, there's more. Avocet has the tools you need from start to finish to enter, assemble and test your software and finally cast it in EPROM:

Text Editor VEDIT -- full-screen text editor by CompuView. Makes source code entry a snap. Full-screen text editing, plus TECO-like macro facility for repetitive tasks. Pre-configured for over 40 terminals and personal computers as well as in user-configurable form.

CP/M-80 version \$150
 CP/M-86 or MDOS version \$195
 (when ordered with any Avocet product)

EPROM Programmer -- Model 7128 EPROM Programmer by GTek programs most EPROMS without the need for personality modules. Self-contained power supply ... accepts ASCII commands and data from any computer through RS 232 serial interface. Cross-assembler hex object files can be down-loaded directly. Commands include verify and read, as well as partial programming.

PROM types supported: 2508, 2758, 2516, 2716, 2532, 2732, 2732A, 27C32, MCM8766, 2564, 2764, 27C64, 27128, 8748, 8741, 8749, 8742, 8751, 8755, plus Seeq and Xicor EEPROMS.

Circle 17 on inquiry card.

Avocet Cross-assembler	Target Microprocessor	CP/M-80 Version	CP/M-86 IBM PC, MSDOS** Versions
XASMZ80	Z-80	\$200.00 each	\$250.00 each
XASM85	8085		
XASM05	6805		
XASM09	6809		
XASM18	1802		
XASM48	8048/8041		
XASM51	8051		
XASM65	6502		
XASM68	6800/01		
XASMZ8	Z8		
XASMF8	F8/3870		\$300.00 each
XASM400	COP400		
XASM75	NEC 7500		\$500.00
NEW! XMAC68K 68000			\$595.00

(Upgrade kits will be available for new PROM types as they are introduced.)

Programmer \$429
 Options include:
 Software Driver Package -- enhanced features, no installation required.
 CP/M-80 Version \$ 75
 IBM PC Version \$ 95
 RS 232 Cable \$ 30
 8748 family socket adaptor ... \$ 98
 8751 family socket adaptor ... \$174
 8755 family socket adaptor ... \$135

G7228 Programmer by GTek -- baud to 2400 ... superfast, adaptive programming algorithms ... programs 2764 in one minute.

Programmer \$549
 Ask us about Gang and PAL programmers.

HEXTRAN Universal HEX File Converter -- Converts to and from Intel, Motorola, MOS Technology, Mostek, RCA, Fairchild, Tektronix, Texas Instruments and Binary formats.

Converter, each version \$250

Call Us

If you're thinking about development systems, call us for some straight talk. If we don't have what you need, we'll help you find out who does. If you like, we'll even talk about Bach.

CALL TOLL FREE 1-800-448-8500
 (In the U.S. except Alaska and Hawaii)

VISA and Mastercard accepted. All popular disc formats now available -- please specify. Prices do not include shipping and handling -- call for exact quotes. OEM INQUIRIES INVITED.

*Trademark of Digital Research **Trademark of Microsoft



AVOCET SYSTEMS INC.™

DEPT. IBM PC-B
 804 SOUTH STATE STREET
 DOVER, DELAWARE 19901
 302-734-0151 TELEX 467210

FOR TRS-80 MODELS 1, 3 & 4
IBM PC, XT, AND COMPAQ

The MMSFORTH System. Compare.

- The speed, compactness and extensibility of the MMSFORTH total software environment, optimized for the popular IBM PC and TRS-80 Models 1, 3 and 4.
- An integrated system of sophisticated application programs: word processing, database management, communications, general ledger and more, all with powerful capabilities, surprising speed and ease of use.
- With source code, for custom modifications by you or MMS.
- The famous MMS support, including detailed manuals and examples, telephone tips, additional programs and inexpensive program updates, User Groups worldwide, the MMSFORTH Newsletter, Forth-related books, workshops and professional consulting.

MMS FORTH

A World of Difference!

- Personal licensing for TRS-80: \$129.95 for MMSFORTH, or "3+4TH" User System with FORTHWRITE, DATAHANDLER and FORTHCOM for \$399.95.
- Personal licensing for IBM PC: \$249.95 for MMSFORTH, or enhanced "3+4TH" User System with FORTHWRITE, DATAHANDLER-PLUS and FORTHCOM for \$549.95.
- Corporate Site License Extensions from \$1,000.

If you recognize the difference and want to profit from it, ask us or your dealer about the world of MMSFORTH.

MILLER MICROCOMPUTER SERVICES
61 Lake Shore Road, Natick, MA 01760
(617) 653-6136

TWO LOGOS

Table 1: Primitives found in both Logos.

Action of Primitive	Logo Name
ASSEMBLY LANGUAGE INTERFACE	
Similar to POKE in BASIC	.deposit
Similar to PEEK in BASIC	.examine
DEBUG SUPPORT	
List of all objects in workspace	.contents
Continue execution after pause	co
Suspend execution	pause
Make random number sequence repeat	rerandom
DISK AND FILE OPERATIONS	
Load file into workspace	load
write contents of workspace/package to disk file	save
EDITOR	
Invoke screen editor to edit procedure	edit (ed)
Invoke screen editor to edit variables	edns
KEYBOARD INPUT	
TRUE if keyboard entry available	keyp
Read in a single character ¹	readchar (rc)
Read in a list ¹	readlist (rl)
LISTS, WORDS, AND VARIABLES	
All of a list/word but the first item/character	butfirst (bf)
All of a list/word but the last item/character	butlast (bl)
Number of items/characters in a list/word	count
TRUE if argument is empty list/word	empty
First item/character in a list/word	first
Append 1st argument to head of 2nd	fput
Select nth item/character from list/word	item
Last item/character in a list/word	last
Make a list	list
TRUE if argument is a list	listp
Declare local variables	local
Append 1st argument to tail of 2nd	lput
Assign value to variable	make
TRUE if 1st argument is member of 2nd	memberp
Assign value to variable	name
TRUE if argument is variable with a value	namep
TRUE if argument is a number	numberp
Print arguments (add newline)	print (pr)
Splice two lists together	sentence (se)
Display argument	show
Value of a variable	thing
Print arguments (no newline)	type
Splice two strings into a word	word
TRUE if argument is a word	wordp
LOGIC FUNCTIONS	
TRUE if 1st argument less than 2nd	<
TRUE if 1st argument equal to 2nd	=
TRUE if 1st argument greater than 2nd	>
TRUE if all arguments are TRUE	and
TRUE if arguments are equal	equalp
TRUE if argument is FALSE	not
TRUE if one argument is TRUE	or

(continued)

Is Your PC Buried By Floppy Disk Back-Up?

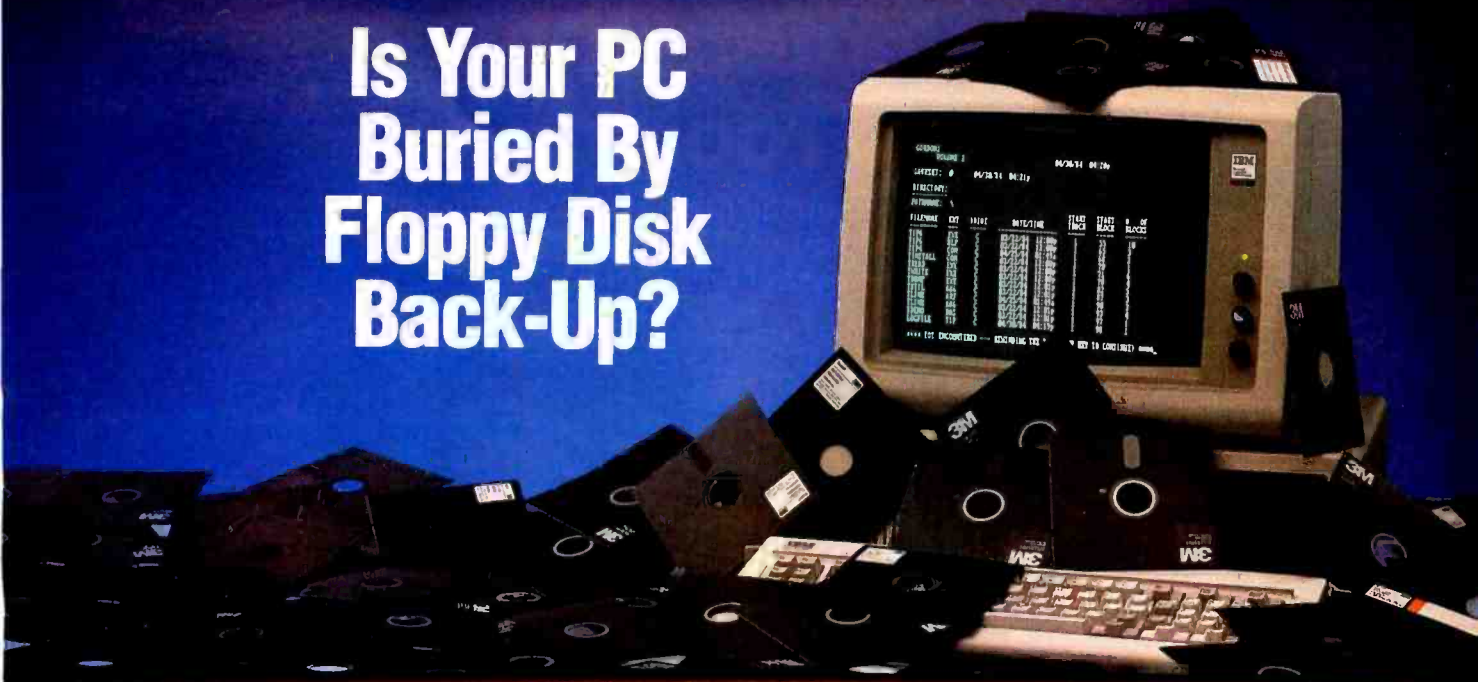

Dig Out With Model 70 PC Cartridge Tape System

Digi-Data's Model 70 PC cartridge tape system lets you back-up your PC's Winchester drive without getting buried in floppies. One cartridge holds 16.5 Mbytes of data, more than you can put on 51 floppy disks! And you can back-up your 10 Mbyte PC XT® drive in less than 15 minutes of *unattended* operation. That is a small fraction of the time it would take with the PC's floppy, with you standing there changing disks.

Our file-oriented structure makes it possible for you to back-up only what has to be changed on your disk. That saves still more time and storage capacity.

70 PC comes ready to run on your IBM PC XT and most compatibles like Compaq, Columbia Data Products and Eagle. Complete with controller board, driver software and cables.

Digi-Data's products also include 1/2 inch and 1/4 inch start/stop and streaming drives and systems.



**DIGI-DATA
CORPORATION**
®... First In Value

8580 Dorsey Run Road
Jessup, MD 20794
(301) 498-0200 Telex 87580

In Europe contact:
DIGI-DATA LTD
Unit 4
Kings Grove
Maidenhead, Berkshire
England SL6 4DP
Tel. 0628-29555-6
Telex 847720

Circle 46 on inquiry card.

® PC XT is a registered trademark
of IBM Corporation

Heath enters the board room

Now you can buy the finest PC compatible boards, accessories and software from a single, trusted source. The Heath Company. We guarantee these to be the *best of breed* for your PC.



Access 1-2-3 Smart Modem. Fast, Single stroke log-on to 40 entries.



AST Six-Pak Plus. Six most popular functions at a great price!



A Heath Exclusive! DG Game Port Adapter for joysticks and other analog inputs.



DG 64K Magic RAM. Add-on memory at a super price!

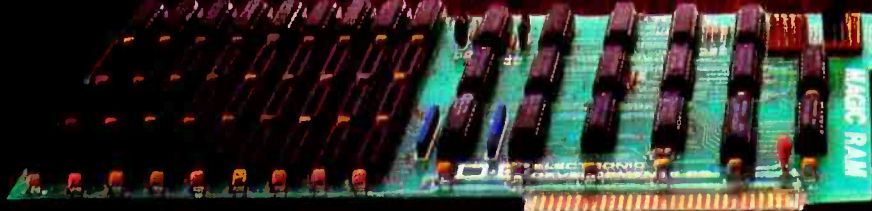

NEW MS-DOS® Course.

Now you can learn the operating system of the IBM and Zenith Data System PC's. Complete step-by-step self-study course shows you how.

*MS-DOS is a registered trademark of Microsoft Corporation.

When you buy PC compatible boards, you want them to work with no problems, no delays. Now Heath has taken the guesswork out of who has the best computerware at the right price. Heath has done the testing and evaluating for you and we offer nothing but the finest boards and accessories. And we back them all with our own 90 day money-back guarantee. So, forget the guesswork. Buying the best is easier...because the best comes from Heath.

Heath/Zenith
Heath
Company

See and buy the finest boards and other accessories for your Heath/Zenith or IBM PC.

Find them at these Heathkit Electronic Centers:

- PHOENIX, AZ
2727 W. Indian School Rd.
- TUCSON, AZ
7109 E. Broadway
- ANAHEIM, CA
330 E. Ball Rd.
- CAMPBELL, CA
2350 S. Bascom Ave.
- EL CERRITO, CA
6000 Potrero Ave.
- LA MESA, CA
8363 Center Dr.
- LOS ANGELES, CA
2309 S. Flower St.
- POMONA, CA
1555 N. Orange Grove Ave.
- REDWOOD CITY, CA
2001 Middlefield Rd.
- SACRAMENTO, CA
1860 Fulton Ave.
- WOODLAND HILLS, CA
22504 Ventura Blvd.
- DENVER, CO
5940 W. 38th Ave.
- AVON, CT
395 W. Main St., (Rt. 44)
- JACKSONVILLE, FL
8262 Arlington Expressway
- MIAMI, FL
4705 W. 16th Ave.,
Hialeah
- FT. LAUDERDALE, FL
7173 W. Broward Blvd.
Plantation
- TAMPA, FL
4019 W. Hillsborough Ave.
- ATLANTA, GA
5285 Roswell Rd.
- PEARL CITY, HI
98-1254
Kaahumanu St.
- CHICAGO, IL
3466 W. Devon Ave.
- DOWNERS GROVE, IL
224 Ogden Ave.
- INDIANAPOLIS, IN
2112 E. 62nd St.
- KANSAS CITY, KS/MO
5960 Lamar Ave.,
Mission, KS
- NEW ORLEANS, LA
1900 Veterans
Memorial Hwy.
- LOUISVILLE, KY
12401 Shelbyville Rd.
- BALTIMORE, MD
1713 E. Joppa Rd.
- ROCKVILLE, MD
5542 Nicholson Lane
- PEABODY, MA
242 Andover St. (Rt. 114)
- WELLESLEY, MA
165 Worcester Ave. (Rt. 9)
- FARMINGTON HILLS, MI
29433 Orchard Lake
Rd. (At 13 Mile Rd.)
- EAST DETROIT, MI
18149 E. Eight Mile Rd.
- ST. JOSEPH, MI
Lakeshore Dr.
- MINNEAPOLIS, MN
101 Shady Oak Rd.,
Hopkins
- ST. PAUL, MN
1645 White Bear Ave.
- ST. LOUIS, MO
3794 McKelvey Rd.,
Bridgeton
- GREENSBORO, NC
4620C W. Market St.
- OMAHA, NE
9207 Maple St.
- ASBURY PARK, NJ
1013 State Hwy. 35, Ocean
- FAIR LAWN, NJ
35-07 Broadway, (Rt. 4)
- BUFFALO, NY
3476 Sheridan Rd.,
Amherst
- JERICHO, LI, NY
15 Jericho Turnpike
- ROCHESTER, NY
937 Jefferson Rd.
- N. WHITE PLAINS, NY
7 Reservoir Rd.
- CINCINNATI, OH
10133 Springfield Pike
Woodlawn
- CLEVELAND, OH
28100 Chagrin Blvd.
- COLUMBUS, OH
2500 Morse Rd.
- TOLEDO, OH
48 S. Byrne Rd.
- OKLAHOMA CITY, OK
2727 N.W. Expressway
- FRAZER, PA
630 Lancaster Pike (Rt. 30)
- PHILADELPHIA, PA
6318 Roosevelt Blvd.
- PITTSBURGH, PA
3482 Wm. Penn Hwy.
- WARWICK, RI
558 Greenwich Ave.
- DALLAS, TX
2715 Ross Ave.
- FORT WORTH, TX
6825-A Green
Oaks Rd.
- NORTH HOUSTON, TX
5050 FM 1960 W. (#126)
- HOUSTON, TX
1704 W. Loop N.
- SAN ANTONIO, TX
7111 Blanco Rd.
- SALT LAKE CITY, UT
58 East 7200 South,
Midvale
- ALEXANDRIA, VA
6201 Richmond Hwy.
- VIRGINIA BEACH, VA
1055 Independence Blvd.
- SEATTLE, WA
505 8th Ave. N.
- TUKWILA, WA
15439 53rd Ave. S.
- VANCOUVER, WA
516 SE Chaklov Dr. (# 1)
- MILWAUKEE, WI
5215 W. Fond du Lac
Lakeshore Dr.

*Units of Veritechnology Electronics Corporation.

For more information write:

Heath Company
Benton Harbor, MI 49022

Circle 75 on inquiry card.

CB-101

TWO LOGOS

MATH FUNCTIONS

Multiplication	•
Addition	+
Subtraction	-
Division	/
Arc tangent	arctan
Cosine	cos
Exponential	exp
Truncate to integer	int
3.14159...	pi
Product of arguments ²	product
Division ³	quotient
Pseudorandom integer	random
Remainder from division	remainder
Round argument to nearest integer	round
Sine	sin
Square root	sqrt
Sum of arguments ²	sum

MISCELLANEOUS

Converts character to number	ascii
TRUE if game paddle button is down	buttonp
Converts number to character	char
Illuminates pixel at specified position	dot
Current setting of game paddle	paddle

PROCEDURE DEFINITION AND FLOW CONTROL

Attach a label to a list, execute the list ⁴	catch
Make a list duplicating a procedure definition	copydef
Accept argument as procedure definition	define
TRUE if argument is name of defined procedure	definedp
Signals end of a procedure definition ⁵	end
Current error list	error
Go to label	go
If-else construct ⁶	if
Execute argument if last test was FALSE	iffalse (iff)
Execute argument if last test was TRUE	iftrue (ift)
Make argument target for go	label
Exit procedure, return argument as value	output (op)
Execute list for specified number of times	repeat
Execute argument	run
Exit procedure, no value is returned	stop
Evaluate argument, save result for use by iff and ift	test
Definition list of procedure	text
Jump out of the specified catch list ⁴	throw
Signals start of a procedure definition ⁵	to
Suspend procedure for specified interval	wait

PROPERTY LISTS

Retrieve property from property list	gprop
Return full property list	plist
Add property to property list	pprop
Show all properties in workspace or package	pps
Remove property from property list	remprop

SCREEN CONTROL

Background color of graphics screen	background (bg)
Clear graphics screen	clearscreen (cs)
Clear text screen	cleartext (ct)

(continued)

MicroTime

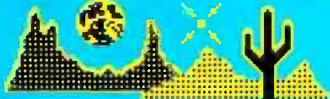

800-MICRO 84

SET-UP ASSISTANCE

SOFTWARE SUPPORT
ONE YEAR SERVICE CONTRACT AVAILABLE

LOWEST PRICES ALL MODELS



IBM-PC

Xerox-Americanare Maintenance

SYSTEM SALES

NEW LOWER PRICES



IBM® COMPATIBLE
FREE ON-SITE SERVICE FOR 3 MONTHS
SOFTWARE & HARDWARE SET-UP



ZENITH

Desktop PC-150 Portable PC-160

SYSTEM SUPPORT

COLOR GRAPHICS

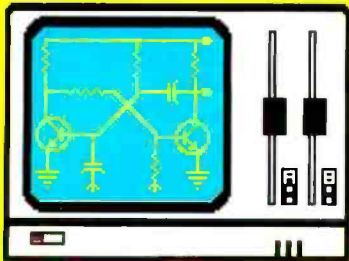

DEC APC

AUTOCAD & DIABLO INK JET

PERIPHERALS

AMDEK • AST • BENCHMARK • BLUECHIP
BPI • BROTHER • CITOH • DATAPRODUCTS
DATASOUTH • DIABLO • EPSON • HAYES
HOUST./INSTR • JUKI • MANN/TALLY
MOUNTAIN • NEC • NOVATION • OKIDATA
ORANGE • PANASONIC • PLANTRONICS
PROMETHEUS • QUADRAM • QUME
SILVER REED • STAR (GEMINI) • TAXAN
TRANSTAR • TOSHIBA • TTX • US ROBOTICS

800-642-7684

Apple is a registered trademark of Apple Computers, Inc.
IBM is a registered trademark of International Business Machines, Corp.

411 West Grant Road
Tucson, Arizona 85705



TWO LOGOS

Cursor position on text screen	cursor
Use full screen for graphics	fullscreen
Set background color of graphics screen	setbg
Set position of text cursor	setcursor
Use full screen for text?	textscreen

TURTLE COMMANDS

Move backward	back (bk)
Clear screen without changing turtle status	clean
Confine turtle to visible display	fence
Move forward	forward (fd)
Report turtle heading	heading
Make turtle invisible	hideturtle (ht)
Return turtle to origin with heading due north	home
Turn left	left (lt)
Report color of turtle pen	pencolor (pc)
Lower color pen	pendown (pd)
Lower erasing pen	penerase (pe)
Lower XORing pen	penreverse (px)
Raise current pen	penup (pu)
Report pen status	pen
Report turtle position	pos
Turn right	right (rt)
Set turtle heading	setheading (seth)
Set color of turtle pen	setpc
Set state of turtle pen	setpen
Set turtle at specified position	setpos
Set turtle ordinate as specified	setx
Set turtle abscissa as specified	sety
TRUE if turtle is visible	shownp
Make turtle visible	showturtle (st)
Set turtle to point toward specified position	towards
Allow turtle to go outside visible display	window
Apply toroid geometry to graphics display	wrap
Report turtle ordinate	xcor
Report turtle abscissa	ycor

WORKSPACE MANAGEMENT

Make package invisible to certain primitives	bury
Erase everything in workspace/package	erall
Erase procedure from workspace	erase (er)
Erase variable from workspace/package	ern
Erase all variables from workspace/package	erns
Erase all procedures from workspace/package	erps
Report how much workspace unused	nodes
Put procedure/variable in package	package
Put all unpackaged objects in package	pkgall
Show definition of procedure	po
Combine pops and pons	poall
Show all variables in workspace/package	pons
Show all procedures in workspace/package	pops
Show titles of all procedures in workspace/package	pots
Perform garbage collection on workspace	recycle
Undo action of bury	unbury

¹In IBM PC Logo, these primitives may also be used for file input.

²Not limited to two arguments.

³In DR Logo, quotient truncates its result to an integer.

⁴Catch and throw work together in a way similar to the "on condition" and "signal" statements of PL/I.

⁵To and end only function in edit or interactive mode; they are more markers than true primitives.

⁶If 1st argument is TRUE, execute 2nd; otherwise execute 3rd.

⁷May be abbreviated to TS in IBM PC Logo.

MicroAge®

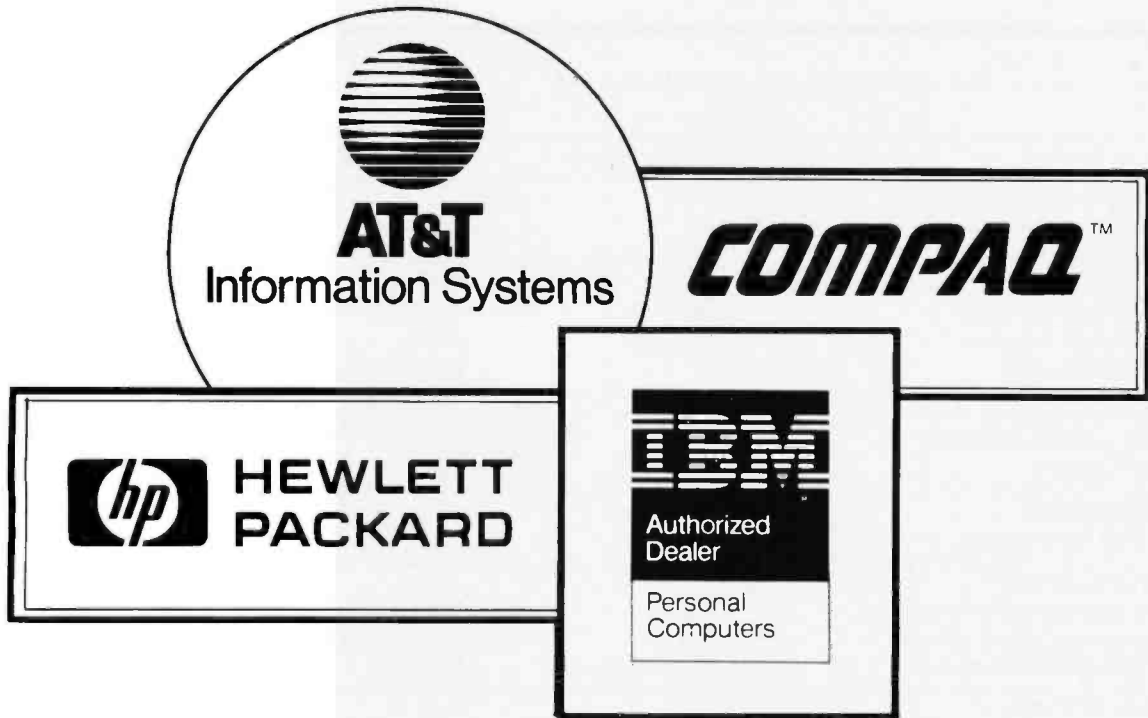

Masters of PC Technology

There's a difference between knowing how to operate a computer and knowing how a computer operates.

Don't settle for below average, straight out of the box, PC performance. At MicroAge we're masters of PC technology. We can make personal computers perform beyond your expectations. You get more computer for your money, more productivity for your time.

MicroAge . . . we know today's PC technology. We're already started on tomorrow's.

MicroAge®

COMPUTER STORES

"The Solution Store"®

For the MicroAge Computer Store closest to you call

1-800-525-4516

TWO LOGOS

Table 2: Primitives found in both Logos, but under different names.

Action of Primitive	DR Logo Name	IBM PC Logo Name
DISK AND FILE OPERATIONS		
Invoke editor to edit disk file	edf	EDITFILE
Show directory information ¹	getfs, spaced	DIR
Report size of file	sizef	FILELEN
Set default for disk drive	setd	SETDISK
Report default disk drive	defaultd	DISK
Erase file from disk	erf	ERASEFILE
MATH FUNCTIONS		
Number raised to exponent		POWER
Natural logarithm	log	LN
MISCELLANEOUS		
Emit tones from speaker	tones	TONE
PRINTER CONTROL		
Enable copying of text screen ²	copyon	DRIBBLE
Disable copying of text screen	copyoff	NODRIBBLE
Print graphics screen on printer	printscreen (ps)	PrtSc key
SCREEN CONTROL		
Set fore-/background colors for text ¹	textbg, textfg	SETTC
Set space for text on split screen	setsplit	SETTEXT
Mix text and graphics on one screen	splitscreen	MIXEDSCREEN (MS)
Use two monitors	twoscreen	SETSCREEN

¹The combined effect of both DR Logo primitives is more or less equivalent to the IBM PC Logo primitive.

²The IBM PC Logo dribble and nodribble primitives can be used with other output devices besides the printer.

parent, and, if frequent, can hurt a program's performance.

My performance-testing adventure started when I decided to see how the two Logos would perform on David Ahl's simple benchmark from *Creative Computing* ("Creative Computing Benchmark," February 8, 1984), which tests the speed and accuracy of floating-point computations, looping, and random-number generation. Although by no means an exhaustive benchmark, it was a good choice for testing Logo. Listing 1 gives my Logo adaptation of this benchmark.

Surprisingly, DR Logo did considerably better at this benchmark than IBM PC Logo. Normal use had not suggested any such discrepancy in performance. If anything, I had formed the opinion that IBM PC Logo was faster than DR Logo. I decided to investigate this unexpected result further.

Next, I selected two programs that are considered Logo classics: Flower and Tower. Flower is a turtle-graphics program that produces a picture of a flower, found in one form or another in just about every introductory Logo book. I originally wrote the version given in listing 2 as an example of how easy it is to produce a logically structured program with Logo. Tower (listing 3) is another program that appears repeatedly in the Logo literature. For a good analysis of Tower, see Brian Harvey's article in the BYTE special issue on Logo ("Why Logo?" August 1982, page 163). Tower is a classic example of a program that is trivial to write when you use

recursion, but moderately difficult to write when you are restricted to traditional iterative methods.

The results of timing Flower and Tower didn't clear things up at all. They not only conflicted with the Ahl's benchmark timings, they conflicted with each other. Whereas Ahl's benchmark had implied that DR Logo was twice as fast as IBM PC Logo, Flower implied they were about the same speed, and Tower implied IBM PC Logo was four times faster than DR Logo. Taken together, the three tests make a fine lesson in the unreliability of naive benchmarking.

If I hadn't taken data on memory use for Flower and Tower, I would have given the whole thing up as a bad job. That data showed IBM PC Logo was using memory at significantly greater rate than DR Logo. The startling difference in workspace requirements for the Flower program intrigued me enough to press on.

I could think of two ways to explain the conflicting timings: 1) under certain conditions, IBM PC Logo was consuming workspace so fast as to require recycling more often than DR Logo, and 2) some IBM PC Logo primitives were faster than the corresponding DR Logo primitives, while others were slower. Of course, these explanations are not mutually exclusive; both effects could be present.

I knew I would never be able to discriminate between the

(continued)

COHERENT™ IS SUPERIOR TO UNIX* AND IT'S AVAILABLE TODAY ON THE IBM PC.

Mark Williams Company hasn't just taken a mini-computer operating system, like UNIX, and ported it to the PC. We wrote COHERENT ourselves. We were able to bring UNIX capability to the PC with the PC in mind, making it the most efficient personal computer work station available at an unbelievable price.

For the first time you get a multi-user, multitasking operating system on your IBM PC. Because COHERENT is UNIX-compatible, UNIX software will run on the PC under COHERENT.

The software system includes a C-compiler and over 100 utilities, all for \$500. Similar environments cost thousands more.

COHERENT on the IBM PC requires a hard disk and 256K memory. It's available on the IBM XT, and Tecmar, Davong and Corvus hard disks.

Available now. For additional information, call or write,

Mark Williams Company
1430 West Wrightwood, Chicago, Illinois 60614
312/472-6659



COHERENT is a trade mark of Mark Williams Company.

*UNIX is a trade mark of Bell Laboratories.

Circle 185 on inquiry card.

SUPER SAVER

64K RAM Chips
(Min. 100) \$4.49 ea.



IBM PC 256K, Disk Drives, FDC, Monitor and Adaptor \$2350.00

SANYO 555-2 System with 128KB Memory, 2 160KB Slimline Drives, Keyboard, MS-DOS and Micropro Software \$1399.00

TAVA Standard Unit with 128 KB Memory, Floppy Drive Controller, Videoadapter, 2-320KB Slimline Drives, Monitor, Keyboard, Parallel Port & Serial Port \$1750.00

10MB Hard Disk Sub System for TAVA®, IBM®, and COLUMBIA®
Qty. \$899.00

Disk Drive for IBM PC \$149.00

Color Graphics Card for IBM PC \$199.00

Printers by Epson, Okidata, Brother Call

Floppy Drive Controller for IBM PC \$169.00

Color Monitor HX-12 by PGS \$459.00

Shipping and Handling extra.
All transactions based on cashier's check or wire transfer.

SCIENTIFIC RESEARCH CORP.

714/261-9137

TWO LOGOS

Table 3: Primitives found only in DR Logo.

Action of Primitive	DR Logo Name
DEBUG SUPPORT	
Enable split-screen debug mode	debug
Disable split-screen debug mode	nodebug
Disable trace mode	notrace
Disable single-step mode	nowatch
Show the call tree of a procedure	pocall
Show names of all primitives	poprim
Show names of procedures calling a procedure	poref
Show names of all "top level" procedures	potl
Enable trace mode	trace
Enable single-step mode	watch
DISK AND FILE OPERATIONS	
Rename file	change
Full disk copy	copyd
Copy file	copyf
Format a disk	initd
EDITOR	
Invoke editor for everything in workspace/package	edall
Invoke editor for all procedures in workspace/package	edps
KEYBOARD INPUT	
Read keyboard line as single word	readquote (rq)
LISTS, WORDS, AND VARIABLES	
Convert word to all lowercase	lowercase (lc)
Extract a substring/sublist	piece
Random permutation of a list	shuffle
Sort a list	sort
Convert a word to all uppercase	uppercase (uc)
Position in list of last match made with memberp	where
Protect argument from evaluation	quote
MATH FUNCTIONS	
Absolute value	abs
Convert from radians to degrees	degrees
Base 10 logarithm	log10
Convert from degrees to radians	radians
Tangent	tan
MISCELLANEOUS	
Code segment	.getcs
Data segment	.getds
Read byte from specified port	.in
Write byte to specified port	.out
Set segment for .deposit and .examine	.setseg
Comment	;
Reboot DR Logo	bye
Assign word to function key	fkey
Read position of light pen	lpen
TRUE if light pen data available	lpenp
PROCEDURE DEFINITION AND FLOW CONTROL	
TRUE if argument is the name of a primitive	primitivep

(continued)

When Lotus™ wanted better graphics for 1-2-3™, they chose a better graphics card—HERCULES™.



And then we became a standard.

When the IBM® PC was introduced over 2 years ago, the talented people at Lotus realized that it was limited by a lack of high resolution graphics. They knew that this was going to have an adverse effect on 1-2-3's graphics. And Lotus didn't want anything to hold back their revolutionary software.

So they turned to Hercules.

Lotus recognized that the Hercules Graphics Card delivered the performance they wanted. It offered high quality text and high resolution graphics on IBM's monochrome display. It completely replaced the IBM monochrome card. And it didn't cost an arm and a leg.

Since then, Hercules has sold a lot of Graphics Cards. So many that the Hercules Graphics Card has become the high resolution standard for the IBM PC. And this means that there is more high resolution graphics software available for Hercules than for any other graphics card you can buy.

Software like Microsoft® Word. Our high resolution makes Word's text much sharper and easier on your eyes. And there are other programs for business graphics, computer aided design, terminal emulation and programming.

Call for our free information kit. See why the company that made the first graphics card for the IBM PC still makes the best.



Hercules. We're strong on graphics.
800 255 5550 Ext. 409

Address: Hercules, 2550 Ninth St, Berkeley, CA 94710 Ph: 415 540-6000 Telex: 754063 Features: IBM monochrome display graphics resolution of 720x348; parallel printer port; text mode software compatibility; free software for programming; 2 year warranty. Foreign distributors: Compuserve/Canada; Reflex/U.K.; Computer 2000/W. Germany; Edisoft/France; SourceWare/Australia. Trademarks/Owners: Hercules/Hercules Computer Technology; Microsoft/Microsoft Corp; IBM/International Business Machines; Lotus & 1-2-3/Lotus Development.



Quick. Who

New Microsoft® Chart. Nothing draws conclusions better. Chart gives your IBM® PC presentation-quality business graphics. So you can be sure everyone gets the picture. Quick.

Illustrate your point.

Microsoft Chart helps you set up the chart that most clearly displays your information. Because Chart gives you the freedom to do what you want. Quickly and easily.

Start by picking the chart that makes your point best: line, bar, area, pie, column, high-low, and scatter charts are shown right on the screen. You can see how your

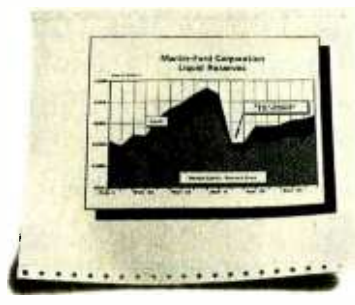
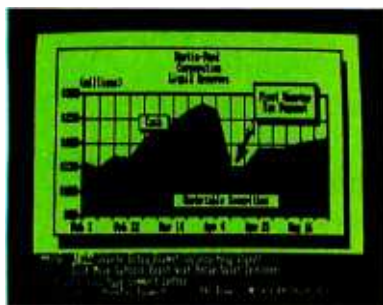

information looks in different charts, switching from one to the other on command.

Chart it and print it in minutes.

Then you can fine-tune the chart to get exactly what you want. Move any section. Position it, change its size, shape or highlight it. Your chart is displayed on the screen, so you can see how it looks with every change.

Like it? Print it. Chart works with over 20 printers and more than 10 color plotters.

Chart links with Microsoft Multiplan.®

CHART

Microsoft and Multiplan are registered trademarks and MS is a trademark of Microsoft Corporation. IBM is a registered trademark of International Business Machines Corporation. Lotus and 1-2-3 are trademarks of Lotus Development Corporation. VisiCalc is a registered trademark of VisiCorp. dBASE II is a registered trademark of Ashton-Tate.

gets the bonus?

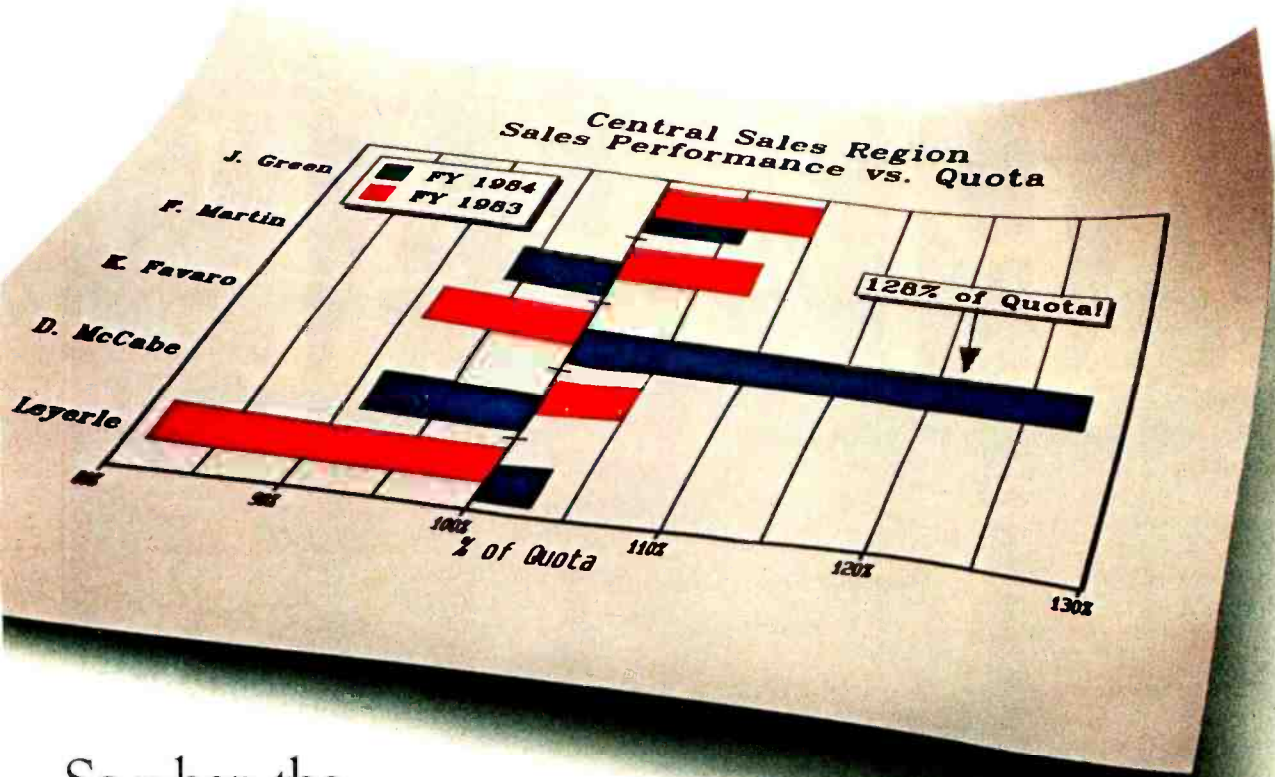

So when the numbers change, the charts change. Automatically. It also picks up information from Lotus™ 1-2-3,™ VisiCalc® and dBASE II.®

Small wonder Microsoft puts you on top of the charts. We designed the MS™-DOS operating system that tells the IBM PC how to think. And our BASIC is the language spoken by nine out of ten microcomputers worldwide.

So if you want to get the picture, quick, call (800) 426-9400. In Washington State, Alaska and Hawaii, call (206) 828-8088. Ask for more information on Microsoft Chart. And the name of your nearest Microsoft dealer.

MICROSOFT
The High Performance Software

An illustration of a person with long dark hair, seen from behind, sitting at a desk and using a vintage computer system. The computer consists of a CRT monitor, a system unit, and a keyboard. The background is a dark space scene with a glowing blue planet or nebula on the left and a futuristic spacecraft in the upper center. The word "APPARAT" is written in large, white, serif capital letters across the middle of the image.

APPARAT

APPARAT TAKES YOUR PC TO NEW REALMS.

4401 South Tamarac Parkway, Denver, CO 80237—Customer Service 303/741-1778
Apparat retail outlets—DENVER: 4401 S. Tamarac Pkwy. 303/771-2032 • 5224 W. Warren Ave. 303/985-1217
CHICAGO: 1844 S. Arlington Heights Rd. 312/640-0322



Imagine your PC with Appar add-ons. Imagine where it could take you.

Special values from the hard disk experts. For example, imagine your IBM PC or Portable PC with hard disk capability. Appar's external Hard Disk Subsystem is completely compatible, running DOS 2.0 or 2.1 without modification or device drivers. And now you can get more capacity—22 and 33 MB formatted configurations—for less money. 22 MB for \$2,295, 33 MB for \$2,995. Appar also offers internal or external 10 MB drives at similarly low prices.

XT owners—trade in your 10 MB drive for a larger Appar hard disk drive. Our 22 MB drive is \$1,299, but you pay just \$899 with a trade-in of your existing 10 MB drive. Our 33 MB drive is just \$1,799, but you pay just \$1,399 when you trade in your existing 10 MB drive. Call the Appar ordering hotline for trade-in details and shipping instructions.

TEAC or Panasonic floppies. These half-height floppies are perfect for your PC, PPC, or XT. Call for trade-in prices on full-height floppies.

New 28 pin EPROM programmer. Now Appar has a new Prom Blaster for the PC, XT, PPC and PCjr to program most 28 pin EPROMS (including the 2764, 128, 256), in addition to our original Prom Blaster that programs most 24 pin EPROMS ...each \$129. We also make an EPROM cartridge for the PCjr to accept your newly programmed EPROMS.

PPC and PCjr. Appar has developed new products for the IBM Portable PC. Now available is a 256K RAM card and a Combo card (P & S). Both fit the PPC short slots. New for the PCjr is a 128K RAM card and a Combo jr card (P & clk). Both fit the side attachment.

Other Appar add-ons. RAM cards for the PC and XT—64K \$189, expandable to 512K. COMBO II card for the PC and XT, 5 functions on one card—\$189. CRAMBO card for the PC piggybacks COMBO II on 64K RAM card—\$359. 64K internal PRINT SPOOLER with parallel interface—\$299. Stand-alone at \$319.

Warranty. All Appar manufactured PC boards sold after June 1, 1984 covered by our exclusive lifetime limited warranty covering parts and labor.



ORDERING AND DEALER INFORMATION

800/525-7674

Prices subject to change without notice.

TWO LOGOS

PROPERTY LISTS	
List of all objects having a specified property	glist
TURTLE COMMANDS	
Write text on graphics screen	turtletext (tt)
WORKSPACE MANAGEMENT	
Rearrange order in which procedures are displayed	follow
Disable storing of format information in workspace	noformat
Disable poprim command	poprim
Show all packages and their contents	popkg
List of all procedures in workspace/package	proclist

Table 4: Primitives found only in IBM PC Logo.

Action of Primitive	IBM PC Logo Name
ASSEMBLY LANGUAGE INTERFACE	
Call subroutine	.CALL
DISK AND FILE OPERATIONS	
Load binary data from file	.BLOAD
Save binary data to file	.BSAVE
List of all open files	ALLOPEN
Close file	CLOSE
Close all open files	CLOSEALL
TRUE if argument is a file	FILEP
Load a file into display memory	LOADPIC
Open file or device	OPEN
Show contents of file	POFILE
TRUE if end-of-file on read	READEOF
File or device specified by last SETREAD	READER
Current position in input stream	READPOS
Save graphics and text display in a file	SAVEPIC
Attach input stream to open file or device	SETREAD
Position input stream	SETREADPOS
Attach output stream to open file or device	SETWRITE
Position output stream	SETWRITEPOS
TRUE if end-of-file on write	WRITEOFF
Current position in output stream	WRITEPOS
File or device specified by last SETWRITE	WRITER
KEYBOARD INPUT	
TRUE if Caps Lock key reversed	CAPS
Enable/disable reversed Caps Lock operation	SETCAPS
Read in specified number of characters ¹	READCHARS (RCS)
Read in a single word ¹	READWORD (RW)
LISTS, WORDS, AND VARIABLES	
Format a number as scientific	EFORM
Format a number as fixed decimal	FORM
MATH FUNCTIONS	
Difference of arguments, prefix form	DIFFERENCE
Report precision of math operations	PRECISION
Set precision of math operations	SETPRECISION

(continued)

THE 8087 IS IN STOCK!

Micro Ware is the world's leading retailer of 8087s. We also have the most accurate statistics on chip reliability. They are: .01% infant mortality, .00% adult mortality and .02% 8088 incompatibility. As for ease of installation, we have never had a customer return a chip because of bent pins. We are so confident that you will be able to successfully install and use the chip that we offer a 180-day warranty with every chip we sell. That's 90 days more than anyone else!

To support the 8087 we stock the largest selection of 8087 software anywhere. This includes: three FORTRANs, three PASCALs, APL, Intel's ASM86, PL/M-86, several Cs, 87BASIC, 87MACRO and MATRIXPAK. For real time or multi-user applications we offer RTOS™ - our implementation of Intel's iRMX executive. Our new products include a professional debugger with 8087 support, an interface library which enables MS Fortran users to call the IBM Basic

Compiler Library, and a translator that converts object modules into readable assembly language files. If you have a question about which computer, language, compiler, operating system or application package is best suited to your problem, we can answer it. Just call:
Information and Orders—
617-746-7341
University, Corporate and Government Buyers—
617-746-7364

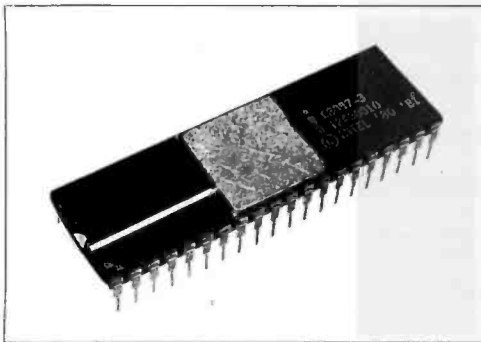

Micro Way™ 8087 Support

87FORTRAN/RTOS™ - our adaptation of the Intel Fortran-86 Compiler generates in line 8087 code using all 8087 data types including 80-bit reals and 64-bit integers. The compiler uses the Intel large memory model, allowing code/data structures of a full megabyte, and supports overlays. Includes RTOS and support for one year **\$1350**

87PASCAL/RTOS™ is Intel's ISO-Standard Pascal with 8087-8088 exceptions. These make it possible to use all the 8087 data types directly, while generating modules in one of the three Intel Memory Models. Includes RTOS and support for one year **\$1350**

RTOS DEVELOPMENT PACKAGE includes 87FORTRAN, 87PASCAL, PL/M-86, Utilities, TX Screen Editor and RTOS. . . **\$2500**

RTOS— REAL TIME MULTI-TASKING/ MULTI-USER EXECUTIVE

RTOS is a Micro Ware configured version of iRMX-86. Includes ASM-86, LINK-86, LOC-86, LIB-86, and the ROM Hex Loader **\$600**

MWS-286™ Configured to your specifications, our computer runs RTOS-286 or XENIX. Includes one Intel compiler, seven slot multibus chassis, hard disk, streaming tape backup and Intel Service Contract. Six to twenty times faster than your PC **CALL**

OBJ-ASM™ - a multipass object module translator and disassembler. Produces assembly language listings which include public symbols, external symbols, and labels commented with cross references. Ideal for understanding and patching object modules and libraries for which source is not available **\$200**

PC TECH JOURNAL REVIEW: "The Micro Ware package is preferable ... it executes the basic operations more rapidly and Micro Ware provides a free update service."

87BASIC™ includes patches to the IBM Basic Compiler and both runtime libraries for USER TRANSPARENT and COMPLETE 8087 support. Provides super fast performance for all numeric operations including trigonometrics, transcendentals, addition, subtraction, multiplication, and division. **\$150**

87BASIC/INLINE™ generates inline 8087 code! Converts the IBM Basic Compiler output into an assembly language source listing which allows the user to make additional refinements to his program. Real expression evaluations run five times faster than in 87BASIC. **\$200**

87MACRO™ - our complete 8087 software development package. It contains a "Pre-processor," source code for a set of 8087 macros, and an object library of numeric functions including transcendentals, trigonometrics, hyperbolics, encoding, decoding and conversions. **\$150**

87DEBUG™ - a professional debugger with 8087 support, a sophisticated screen-oriented macro command processor, and trace features which include the ability to skip tracing through branches to calls and software and hardware interrupts. Breakpoints can be set in code or on guarded addresses in RAM **\$150**

FOR→BAS™ - a library of interface routines which allow MS Fortran programs to call the IBM Basic Compiler library and access features such as the RANDOM NUMBER GENERATOR, SOUND, PLAY, DRAW and SCREEN commands **\$150**

8087-3 CHIP \$175
including DIAGNOSTICS and 180-day warranty

64K RAM Upgrade \$47.50

87/88GUIDE - an excellent tutorial on writing 8087 code and interfacing it with compilers. Full of code that runs! **\$30**

MATRIXPAK™ manages a MEGABYTE! Written in assembly language, our runtime package accurately manipulates large matrices at very fast speeds. Includes matrix inversion and the solution of simultaneous linear equations. Callable from MS Fortran 3.2, 87MACRO, 87BASIC, and RTOS. each **\$150**

MICROSOFT FORTRAN 3.2 ... \$239

MICROSOFT PASCAL 3.2 \$209
These IEEE compatible compilers support double precision and the 8087

MICROSOFT C COMPILER includes Lattice C and the MS Librarian. **\$350**

LATTICE C with 8087 support **\$350**

SCO XENIX™ MICROSOFT **595**

Unisource VENIX/86™ VantageCom, Inc. **800**

FLOAT87 for MS C **125**

SuperSoft Fortran 66 **299**

Computer Innovations C86 **345**

STSC APL★PLUS/PC **500**

TURBO PASCAL **45**

TURBO PASCAL with 8087 Support **85**

HALO GRAPHICS **CALL**

GRAPHMATIC **125**

ENERGRAPHICS **295**

Professional BASIC **295**

Kidger Optical Design Program **3000**

COSMOS REVELATION **850**

SuperCalc III with 8087 Support **CALL**

MAYNARD WS1 HARD DISK **995**

MAYNARD WS2 HARD DISK **1170**

256K RAM CHIPS **CALL**

MAYNARD ELECTRONICS Boards **CALL**

NO CHARGE FOR CREDIT CARDS

ALL ITEMS IN STOCK

CALL FOR COMPLETE CATALOG

IBM PC is a registered trademark of IBM Corp. 8087, iRMX-86, LINK-86, FORTRAN-86, ASM-86, LOC-86, PL/M-86 and LIB-86 are trademarks of Intel Corp. 87FORTRAN/RTOS, 87PASCAL/RTOS, 87BASIC, 87MACRO, MATRIXPAK, 87/88GUIDE, 87BASIC+ and MicroWay are trademarks of Micro Ware, Inc.

Micro Ware
P.O. Box 79
Kingston, MA
02364
(617) 746-7341

**You Can
Talk To Us!**

TWO LOGOS

MISCELLANEOUS

Exit from Logo to PC-DOS	.DOS
Set RS-232C port parameters	.SETCOM
Force parsing of procedure definitions	REPARSE

SCREEN CONTROL

Report number of monitors in use	.SCREEN
Report "scrunch" factor ²	.SCRUNCH
Set "scrunch" factor ²	.SETSCRUNCH
Set width of display (40 or 80)	SETWIDTH
Report color attributes of text display	TEXTCOLOR (TC)
Report width of display	WIDTH

TURTLE COMMANDS

Fill area with color	FILL
Report color palette	PALETTE (PAL)
Select color palette for turtle pen	SETPAL
Set shape of turtle as specified	SETSHAPE
Redefine shape table entry	SNAP
Stamp turtle image at current position ³	STAMP

¹These primitives can also be used for file input.

²The "scrunch" factor is the ratio of vertical turtle steps to horizontal ones—it determines how square a turtle-space square looks on the display.

³A stamped turtle image remains after the turtle moves away.

You can now learn C on your own with... Learning to Program in C

Thomas Plum's LEARNING TO PROGRAM IN C has been called the "best tutorial on the C language." The book explains hardware and its relationship with C. It also includes chapters on data, operators, statements and control flow, functions, software development, pointers and structures of most pieces of the C language. And it describes each language feature, illustrates its use, and describes how or why to use it. With it, you'll have all you need to *learn C on your own*.

Also Available

C PROGRAMMING GUIDELINES is a valuable compilation of standards for ensuring consistency in style and usage of C.

Order Now

LEARNING TO PROGRAM IN C (372pp, 7½" x 10") and C PROGRAMMING GUIDELINES (140pp, 7½" x 10") are each available for \$25.00 a copy. A FREE C Language Pocket Guide is included with each order. To order, call PLUM HALL 609-927-3770. Or complete and mail the coupon today.

Circle 145 on Inquiry card.

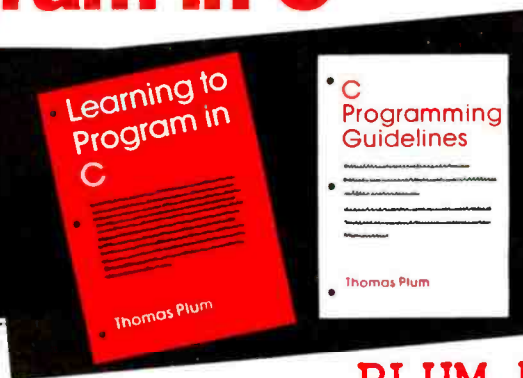

PLUM HALL

1 Spruce Av Cardiff NJ 08232
609-927-3770

Please send me:

_____ copies of Learning to Program in C @ \$25./copy.
 _____ copies of C Programming Guidelines @ \$25./copy.
 _____ information on C training courses.

In NJ, add 6% sales tax. Quantity discounts available.
Overseas, send \$30 U.S.

Check American Express Master Card Visa

Card # _____ Exp. Date _____

Signature _____

Name _____

Company _____

Address _____

City/State/Zip _____

Table 5: Logo benchmark results.

Program	Loops	IBM PC Logo		DR Logo		Remarks
		Time (sec)	Nodes Used	Time (sec)	Nodes Used	
Ahl.benchmark ¹	1000	690.7		351.5		several recycles executed
Flower	1	15.4	19416	17.4	27	turtle graphics
Tower ²	4	1.4	245	6.2	95	recursion test
	5	3.0	437	12.1	175	
	6	5.8	821	24.2	335	
Loop	500	2.2	59	10.8	11	empty repeat loop
	1000	4.2	59	21.3	11	
	2000	8.4	59	42.5	11	
Cntr	500	4.0	1060	18.2	511	repeat loop with counter
	1000	7.8	2060	36.7	1011	
	2000	15.7	4060	73.2	2011	
Fptest						IBM PC Logo precision = 10 DR Logo precision = 15
Add	100	7.0	1589	10.7	824	
	200	13.7	3089	20.6	1624	
	400	27.0	6089	41.2	3224	
Multiply	100	8.2	2971	10.2	824	
	200	16.2	5871	20.6	1624	
	400	32.6	11672	40.3	3224	
Divide	100	8.6	2179	9.8	819	
	200	17.3	4274	19.3	1619	
	400	34.6	8467	38.2	3219	
Square Root	25	11.7	8670	2.8	219	
	50	23.5	17475	5.2	419	
	100	42.6	34842	10.5	819	

¹The floating-point accuracy test results were 3.6e-5 for IBM PC Logo and 1.115e-10 for DR Logo. The random-number test results were 26.06 for IBM PC Logo and 1.62 for DR Logo. For both these tests, the smaller the result the better. ²For Tower benchmark, number shown under Loops is recursion depth.



IBM PC/XT COMPATIBLE

- Computer Case\$140.00
- Keytronic Keyboard\$180.00
- PC 65 Watt Power Supply\$150.00
- XT 100 Watt Power Supply\$190.00
- PC/XT Bare Board\$ 90.00
- Shugart SA455 320KB Floppy Disk\$169.00
- Shugart SA712 10MB Hard Disk\$625.00
- Shugart SA606 10MB Hard Disk\$375.00
- Hard Disk Controller\$325.00
- Floppy Disk Controller w/Serial, Parallel, Game Ports\$250.00
- Color Graphic Card\$210.00
- Monochrome Card\$225.00

OEM/DEALER INQUIRIES WELCOME
ELECTRADE CO. (408) 946-2541
 780 Trimble Rd., Suite 605
 San Jose, CA 95131

Circle 55 on Inquiry card.

**8051 & 8048/8041
 CROSS ASSEMBLERS
 FOR THE IBM PC/XT
 and COMPAQ COMPUTERS**

Save the cost of a development system by using your PC to develop software. Save time and improve programmer's productivity by using Cross Assemblers specifically designed for the 8051 & 8048/8041. MetaLink's Cross Assemblers:

- Provide software support for all five 8051 memory spaces
- Allow special bit address selectors for the 8051 Boolean Processor
- Recognize all Intel defined symbols for the hardware registers
- Include a detailed User's Manual and explicit error messages to simplify assembler usage

The Cross Assemblers are machine language optimized for extremely fast assemblies. They support all components in either the 8051 family or the 8048/8041 family. Standard Hex format is output for PROM programmers.

Only \$145.00

MetaLink Corp.

33 W. Boxelder Place, Suite 110
 Chandler, AZ 85224
 (602) 926-0797

VISA/Mastercard accepted

Circle 107 on Inquiry card.

**FUJI FILM
 FLOPPY DISK**

The Heavy-Duty Disks

MD1D - Single Sided - Double Density
 Reg. \$46.50 Special **18.90/** box of 10 ea.

MD2D - Double Sided - Double Density
 Reg. \$70.50 Special **21.90/** box of 10 ea.

Precision Data Products

P.O. Box 8367
 Grand Rapids, MI 49508
 Outside U.S.A. (616) 452-3457
 Michigan 1-800-632-2468
 Outside Michigan 1-800-258-0028

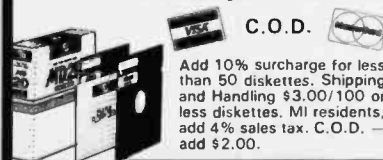

C.O.D.

Add 10% surcharge for less than 50 diskettes. Shipping and Handling \$3.00/100 or less diskettes. MI residents, add 4% sales tax. C.O.D. - add \$2.00.

Circle 146 on Inquiry card.



Why people choose an IBM PC in the first place is why people want IBM service...in the first place.

After all, who knows your IBM Personal Computer better than we do?

That's why we offer an IBM maintenance agreement for every member of the Personal Computer family. It's just another example of blue chip service from IBM.

An IBM maintenance agreement for your PC components comes with the choice of service plan that's best for you—at the price that's best for you.

Many customers enjoy the convenience and low cost of our carry-in service. That's where we exchange a PC display, for example, at any of our Service/Exchange Centers.

Circle 83 on Inquiry card.

And for those customers who prefer it, we offer IBM on-site service, where a service representative comes when you call.

No matter which you choose for your PC, an IBM maintenance agreement offers you fast, effective service.

Quality. Speed. Commitment. That's why an IBM maintenance agreement means blue chip service. To find out more about the specific service offerings available for your PC, call 1 800 IBM-2468, Ext. 104, and ask for PC Maintenance.

Blue chip service from **IBM**

Fall 1984 • BYTE Guide to the IBM PC • 119



In the battle of wits with your computer, you now have a powerful new ally. An information management system called CDI/100.

It brings our experience in the minicomputer world to your micro, giving you a fast, powerful,

flexible tool for creating, accessing and changing data base information. CDI/100 is so easy, novices can proceed with ease. And so flexible, experts can adapt and build specialized applications.

CDI/100 features include a relational data base management

system — the only one you'll find with variable length fields. Plus an open-ended file structure with a recordkeeping system that is virtually limitless.

Most revolutionary of all, CDI/100 allows you to use a host of existing application programs,



How to conquer your computer.

so you can easily transfer files or
add the programs of your choice.

To find out how you can
acquire an information manage-
ment system that lets you take
charge fast and efficiently, ask for a
test demonstration of CDI/100
wherever you buy your software.

Exceptional New Software Concept

- Everyone's Filing System
- English-like Inquiry Language
- Dynamic Menu System
- Integrated Help Features
- Relational Data Management
- Enhanced Basic Compiler
- Dictionary Supported Data Base
- Task Master

CDI
100™
CDI Information Systems, Inc.
1309 114th Ave. S.E.
Bellevue, WA 98004
(206) 455-5117
INCREASE YOUR PERSONAL POWER.™

Circle 31 on inquiry card.

Listing 1: *My adaptation of Ahl's simple benchmark program.*

```

TO AHL.BENCHMARK :M
  (LOCAL "N "A "S "R)
  MAKE "N 1
  MAKE "R 0
  MAKE "S 0
  PRINT [START TIMER]
  REPEAT :M
    |
    MAKE "A :N
    REPEAT 10
      |
      MAKE "A SQRT :A
      MAKE "R :R + RN
      |
      REPEAT 10
        |
        MAKE "A :A * :A
        MAKE "R :R + RN
        |
        MAKE "S :S + :A
        MAKE "N :N + 1
        |
    PRINT [STOP TIMER]
    PRINT ABS (1010 - :S / 5)
    PRINT ABS (1000 - :R)
  END

TO RN
  OUTPUT (RANDOM 32768) / 32768
END

TO ABS :X
  IF :X < 0
    [OUTPUT - :X]
  [OUTPUT :X]
END

```

Note: The ABS procedure is not required by the DR Logo version of Ahl.benchmark because abs is a DR Logo primitive.

Listing 2: *Flower, a turtle-graphics program.*

```

TO FLOWER
  START.UP
  BLOSSOM
  GREENERY
  TITLE
  CLOSE.DOWN
END

TO START.UP
  CLEARSCREEN
  HIDETURTLE
  FULLSCREEN
  PENUP
  FORWARD 30

```

```

  PENDOWN
  END

TO BLOSSOM
  SETPC 2
  CIRCLE
  RIGHT 18
  PETALS
  PENUP
  HOME
  PENDOWN
  END

TO GREENERY
  SETPC 1
  STEM
  LEFT 30
  LEAF
  LEFT 120
  LEAF
  END

TO TITLE
  SETPC 3
  PENUP
  SETHEADING 0
  BACK 15
  SETX XCOR - 24
  TURTLETEXT [FLOWER]
  END

TO CLOSE.DOWN
  HOME
  SETPC 2
  PENDOWN
  END

TO CIRCLE
  LOCAL "STEP
  PENUP
  FORWARD 18
  LEFT 90
  PENDOWN
  MAKE "STEP 18 * RADIANS 4
  REPEAT 90
    |
    FORWARD :STEP
    LEFT 4
    |
  PENUP
  RIGHT 90
  BACK 18
  PENDOWN
  END

TO PETALS
  REPEAT 5
    |

```

```

RIGHT 72
PETAL
|
END

TO PETAL
REPEAT 5
|
FORWARD 35
RIGHT 72
|
END

TO LEAF
RIGHT 45
REPEAT 90
|
FORWARD 1
RIGHT 1
|
RIGHT 90
REPEAT 90
|
FORWARD 1
RIGHT 1
|
RIGHT 45
END

TO STEM
FORWARD 30
BACK 100
END

TO RADIANS :D
OP PI * :D / 180
END
TO TURTLETEXT :TXT
LOCAL "N
MAKE "N 1
RIGHT 90
SHOWTURTLE
REPEAT COUNT :TXT
|
WRTWORD ITEM :N :TXT
MAKE "N :N+1
|
SETSHAPE "TURTLE
HIDETURTLE
END

TO WRTWORD :WD
IF EMPTY? :WD
|
FORWARD 5
STOP

```

```

|
SETSHAPE ASCII FIRST :WD
STAMP
FORWARD 5
WRTWORD BUTFIRST :WD
END

```

Note: RADIANS, TURTLETEXT, and WRTWORD procedures are not required by the DR Logo version of Flower because radians and turtletext are DR Logo primitives.

Listing 3: The Tower of Hanoi program.

```

TO TOWER :N :FROM :TO :EXTRA
IF :N = 0 [STOP]
TOWER :N-1 :FROM :EXTRA :TO
(PRINT "MOVE :N "FROM :FROM "TO :TO)
TOWER :N-1 :EXTRA :TO :FROM
END

```

Listing 4: A simple loop program (Loop).

```

TO LOOP :N
PRINT "START
REPEAT :N [IDLE]
PRINT "STOP
END

TO IDLE
END

```

Listing 5: A simple loop with counter program (Cntr).

```

TO CNT :N
LOCAL "I
MAKE "I 1
PRINT "START
REPEAT :N [MAKE "I :I + 1]
PRINT "STOP
END

```

Listing 6: Floating-point arithmetic test program (Fptest).

```

TO FPTEST :N :OPR
IF OR (:OPR = "+") (:OPR = "*")
|
DO.IT :N (SENTENCE [MAKE "I :I] :OPR ")]
STOP
|
IF :OPR = "/"
|
DO.IT :N [MAKE "I 1.0 / :I]
STOP
|
IF :OPR = "SQRT"
|
DO.IT :N [MAKE "I SQRT :I]
STOP
|
(PRINT [I DON'T KNOW HOW TO TEST] :OPR)
END

```

(continued)

```

TO DO.IT :N :RLIST
  (LOCAL "I ")
  MAKE "J 1.0001
  PRINT "START
  REPEAT :N
    |
    RUN :RLIST
    MAKE "J :J + 1.0
  |
  PRINT "STOP
  (PRINT [FOR j =] :J - 1 [i =] :I])
END

```

two effects if I continued to use typical programs as benchmarks. I needed to write programs simple enough for me to know exactly what was going on. The first of these were Loop and Cntr (listings 4 and 5). As it did with Tower, IBM PC Logo ran both programs four times faster than DR Logo did. For these programs, the Nodes Used results show recycling can never degrade the performance of IBM PC Logo relative to DR Logo. Loop will never recycle because it uses a constant amount of workspace. Cntr will eventually recycle, but DR Logo will be slowed more by this than IBM PC Logo because DR Logo uses up one part in 10,000 of its workspace in every iteration, while IBM PC Logo uses up only one part in 15,000. The tests with Loop and Cntr supported the idea that the speed of primitives determines performance more than the frequency of recycling does.

What primitives could have slowed IBM PC Logo down so much while running Ahl's benchmark? I recalled that IBM PC Logo uses true variable-precision floating-point arithmetic, which has a well-deserved reputation for being slow. Thus the floating-point arithmetic primitives were good candidates. I wrote a program to test them, and the result was Fptest (listing 6). While this program is more elaborate than it needs to be, it shows off Logo's ability to pass an arithmetic operator to a procedure, something most programming languages don't allow. The results from running Fptest strongly support the idea that IBM PC Logo's problem when running Ahl's benchmark is its floating-point arithmetic. However, note that IBM PC Logo's square-root primitive consumes workspace at a rate 40 times faster than DR Logo's, indicating that the recycling effect probably contributes as well.

CAN LOGO REPLACE BASIC?

Let me restate the question in the limited context of the IBM PC. Can either DR Logo or IBM PC Logo replace the Microsoft BASIC that comes with PC-DOS? For some applications it can, for others it cannot. BASIC is used (or abused, if you prefer) to program an incredibly wide range of applications. Indeed, the range is so wide that I am sure I don't know its real dimensions. The best I can do is mention some applications where I think Logo would work better than BASIC and others where I think BASIC would work better.

Since I know Logo was designed to serve education, I wasn't surprised to find that both of the Logos reviewed here live up to Logo's reputation as a superb tool for exploring and demonstrating fundamental concepts in such fields as mathematics, physics, and computer science. Logo is sheer delight when used for this purpose. I imagine it would function just as well when applied to other subject matter, say economics or biology.

A lot of Logo's value in education derives from its excellence as a language in which to write simulations. This area is one in which BASIC is widely used, but where both DR Logo and IBM PC Logo are superior. I find both versions of Logo better than BASIC for numerical computation. Since simulation and numerical computation are two of the most important applications for computers in science and engineering, it follows that either Logo could profitably displace BASIC in these fields.

These Logos should also be of interest to computer scientists and software engineers for rapid prototyping. Rapid prototyping allows you to try out your ideas in a series of small, quickly written programs before you incorporate them into a large and complex one. Prototypes developed in Logo are easy to translate into languages such as C, Pascal, or PL/I. This cannot be said for Microsoft BASIC. When there isn't much need for file handling, DR Logo has the edge over IBM PC Logo for prototyping because it provides the better development environment.

Microsoft BASIC will clearly outdo either of the Logos in most business applications that are mainly of a clerical or financial nature. BASIC's superior capability for handling files ensures this. File-handling superiority will probably tip the balance in BASIC's favor for text-processing applications as well, although both Logos are superior to BASIC in their ability to manipulate text data in memory.

WHICH LOGO IS BETTER?

The choice between Logos is another difficult question. Although the two Logos have much in common, each has strengths and defects not found in the other. Every time I am developing a program in one, I find myself wishing for features the other has. If I were forced to choose between them, I would probably choose DR Logo because it provides the better programming environment. But its I/O limitations would make this a hard decision. The pros and cons are so intertwined that I can easily understand someone else choosing IBM PC Logo instead.

My performance tests do not allow any absolute judgment to be made either. Programs that do a lot of number crunching run faster in DR Logo, but IBM PC Logo has variable-precision floating-point computation. Programs that do a lot of recursive list processing run faster in IBM PC Logo, but DR Logo has the better set of list-processing primitives. For many typical Logo programs, no significant difference will be apparent. The Flower program is a good example.

What I would like is a Logo with all the good features of the two reviewed here and none of the bad. That would be a dynamite programming language. Maybe such a Logo will be available for the IBM PC soon—perhaps even in a subsequent release of either DR Logo or IBM PC Logo. ■

BY JAMES L. WEINER

THE LOGICAL RECORD KEEPER: PROLOG ON THE IBM

*This very high-level language makes it easy to program
knowledge-intensive tasks*

More people are probably "programming" with spreadsheet software than in any traditional programming language. Spreadsheet software allows you to express a large number of real-world problems in terms the computer can understand and solve. After all, how many doctors, lawyers, and people in business need to calculate the factorial of a number? Home or business users deal with objects and relations in the world around them. They want to be able not only to track the deposits and withdrawals in their checking accounts but also to calculate the balance automatically.

The Japanese, who have recognized that computing is no longer reserved for programmers, are developing a new generation of computers to meet the challenge. To complement this new generation of computers, they chose a new logical programming language called PROLOG.

The Japanese effort, termed the "Fifth-Generation Project," is sponsored by both industry and government. The aim of this 10-year undertaking is not only to develop a new generation of computers but to develop integrated systems of software and hardware capable of what the Japanese call "knowledge information processing"—applied artificial intelligence. Because it's based on objects and relations, the stuff of logic, PROLOG is clearly the right language for the project.

*How many
doctors, lawyers,
and people in
business need to
calculate the
factorial of a
number?*

Initially developed by a group at Marseille, France, headed by Alain Colmerauer, PROLOG is based on ideas proposed by Robert Kowalski, then at the University of Edinburgh, who suggested using logical inference as a form of computation. The most efficient and well-engineered version of PROLOG was developed for the DEC-10 by a group headed by David H. D. Warren and which included Luis Pereira, Fernando Pereira, Lawrence Byrd, and David Bowen. Called the Edinburgh DEC-10 PROLOG, it was the first to support both an interpreter and a compiler as well as a sophisticated debugger.

At the University of New Hampshire, under my direction, a graduate student named Sidney Clark created a portable version of the Edinburgh DEC-10 interpreter for the IBM PC. UNH PROLOG will be available commercially early in the fall of 1984.

USING PROLOG: AN EXAMPLE

PROLOG is a programming language that uses familiar questions and answers in interaction with a common database. A user poses a question to the computer, and the computer, using PROLOG and its database, responds. Programs in PROLOG are rules, stored in the database, for transforming input to output. What makes PROLOG unique is that the system alleviates the need to explicitly state how to use knowledge in the database to answer a question. Thrown out of the vocabulary of programming are such constructs as IF...THEN...ELSE, FOR...LOOPS, and REPEAT...UNTIL. Programmers can focus on describing what a problem is and let the language determine how the database can solve it. While designing a programming example in PROLOG for this article, I have tried to convey both how PROLOG works and how simple it is to use. To some readers my example won't look like sound programming; to others, it will look like the only way.

Suppose we have a large record collection, and we maintain information about it in a three-drawer file cabinet, as shown in figure 1. The first drawer,

(continued)

James Weiner teaches in the computer science department at the University of New Hampshire. He can be reached at the UNH Computer Science Dept., Kingsbury Hall, Durham, NH 03824.

labeled "records," contains an entry on an index card for each record in the collection. The entry relates the title of the record with the ensemble that performed it, its conductor, the label on which it was recorded, its catalog number, and its location on the shelves. The index cards used to be ordered, but now they are in disarray. We use the information in this drawer mainly to retrieve a record from the shelf. Sometimes, though, we use the information to answer a question about a record: "Who conducted the Berlin Philharmonic performing Handel's 'Messiah' for RCA?"

Let's assume we enjoy listening to different recordings of the same composition. Another drawer, labeled "performance," relates composition titles to information about the recording. Similarly, we might like listening to a particular composition on a record that features one of our favorite soloists, and thus yet another drawer exists, this one labeled

"solo," that relates record, composition, and soloist. Examples of cards from each drawer are given in figure 2.

Applying PROLOG to this problem is simple. We enter the information on each card into a file that is loaded into PROLOG. (In PROLOG this is called "consulting.") To distinguish between entries from different drawers, we'll use the drawer label. For example, one entry in the "records" drawer might refer to the record entitled "Bach-Orchestral Suites" performed by the Academy of St. Martin in the Fields and conducted by Neville Marriner. The record's label is Argo, and its catalog number is zrg948. In PROLOG this entry might appear as: records ("Bach-Orchestral Suites," Academy of St. Martin in the Fields, marriner, argo, zrg948).

This recording features Bennett on the flute. To indicate the corresponding entry in the "solo" drawer, we must have an entry in the PROLOG file, such as: solo (bennett, argo, zrg948).

A composition performed on this record is Bach's "Orchestral Suite No. 2 in B minor." To indicate this, we need an entry in our PROLOG file such as: performance ("Orchestral Suite No. 2 in B minor," bach, argo, zrg948).

Each entry in our file is a fact about the record collection. For example, we know from our file that there was a performance of Bach's "Orchestral Suite No. 2. in B minor" on the Argo label, catalog number zrg948. Once consulted, these facts will be stored in PROLOG's internal database. Now let's invoke PROLOG:

-- UNH Prolog 1.3 --

| ?-

When invoked, PROLOG responds with a prompt that invites a question. Initially, PROLOG doesn't know much. We must consult our file of facts to add to PROLOG's knowledge. So we ask PROLOG to "consult the file 'records,' if you can":

-- UNH Prolog 1.3 --

| ?- consult(records).
| records consulted |
yes
| ?-

PROLOG responds with the fact that the "records" file was consulted; that is, the facts within it were added to the database. The "yes" indicates it tried to consult the file, and a new prompt invites another question." We can ask, "Did Bennett perform a solo on argo record, catalog number zrg948?":

| ?- solo(bennett,argo,zrg948).
yes
| ?-

PROLOG answers in the affirmative; it knows that Bennett performed a solo on Argo record zrg948. To answer, it has gone through very much the same process that you would go through by hand. In the same way you thumb through your index cards looking for one that matches the information in the question, PROLOG "thumbs" through its database looking for a fact that matches the question.

LOGICAL QUESTIONS

If all you could ask were yes/no questions, PROLOG would be relatively useless. But you can ask PROLOG more interesting questions; for example,

HIGH TECHNOLOGY AT AFFORDABLE PRICES

Dot Matrix Printers

C. Itoh Prowriter BPI (IBM-PC)	\$ 439.88
C. Itoh HotDot	509.88
C. Itoh A-10 Starwriter (18 cps)	549.88
DMX-80 (Panasonic 1090)	259.88
Epson RX/FX/LQ Series	CALL
Microline 92 w/IBM graphics	469.88
Microline 93 w/IBM graphics	699.88
NEC Pinwriter (80 col/PC)	759.88
NEC Pinwriter (132 col/PC) Series	999.88
NEC 2050 for IBM-PC (18 cps)	899.88
NEC 3550 for IBM-PC (33 cps)	1779.88
Qume LetterPro 20	709.88
Silver Reed EXP-770 (25 cps)	979.88
Silver Reed EXP-550 (17 cps)	559.88
Silver Reed EXP-500 (12 cps)	439.88
Silver Reed EXP-400 (10 cps)	329.88
Star Micronics PowerType (18 cps)	CALL
Star Micronics Printers	CALL
Toshiba P-1351	1439.88
Toshiba P-1340	819.88

Modems

Hayes Smartmodem 1200B	\$ 479.88
Novation SmartCat+, 1200bd	409.88
Novation Access 1-2-3	299.88
USR Password, 1200 baud	369.88

Monitors

Amdek 300G (green)	\$ 144.88
Amdek 300A (amber)	159.88
NEC JB-1205M (amber)	159.88
Princeton Graphics HX-12	509.88
Princeton Graphics Max-12	199.88
Roland DG-121 (green or amber)	149.88

IBM-PC Peripherals

64K Memory (4164/200ns) 9/pkg	\$ 69.88
Alloy 41 MB Disk/Tape System	CALL
Alloy PC Backup System	CALL
Hercules Graphics Card	379.88
Keytronics 5151 keyboard	219.88
Mouse Systems PC-Mouse (3.0)	199.88
Paradise MultiDisplay	449.88
NEW! Quadram 384K Quadboards	CALL
Quadram Quad 512 + (64K)	239.88
Quadram Quad 512 + (512K)	609.88
Quadram QuadColor-1	219.88
Quadram QuadLink	509.88
STB Graphics Plus II	479.88
STB Super I/O	169.88
STB Super RIO (64K)	299.88
Tandon TM 100-2 DSDD	229.88
Titan Cygnus I/O (clock/parallel)	149.88
Titan Cygnus I/O (clock/RS-232)	169.88

TECHNICAL SALES DESK

(603) 881-9855

TOLL-FREE ORDER DESK

(800) 343-0726

Hours: 9:00 to 5:30 EST, Mon-Fri

- FREE UPS ground shipping on all orders over \$50 (under \$50 add \$2.50 handling)
- MasterCard, VISA, American Express, Diners Club & Carte Blanche credit cards accepted
- No surcharges on credit card
- CODs accepted up to \$1000 (add \$10 for COD handling). Payable with certified check, money order or cash.
- Sorry, no APO/FPO or foreign orders

HIGH TECHNOLOGY AT AFFORDABLE PRICES

THE BOTTOM LINE

MILFORD, NH 03055-0423 □ TELEPHONE (603) 881-9855

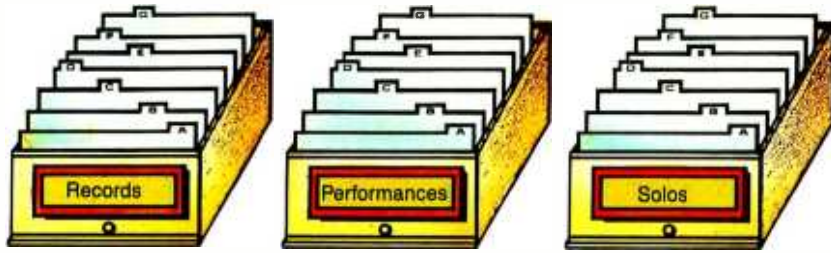

Figure 1: *The file cabinet.*

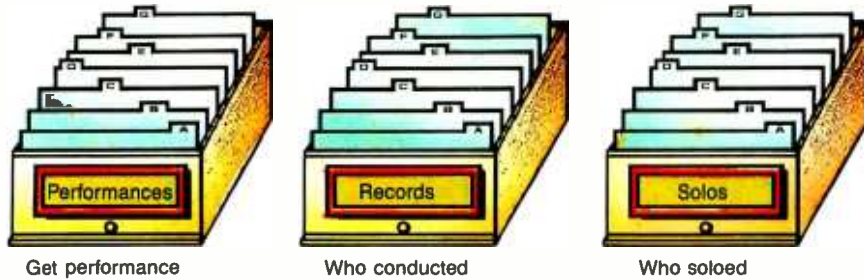

Figure 3: *Rephrasing the question.*

ILLUSTRATIONS BY CHRIS SPOLLEN

"What soloist performed on Argo record zrg948?"

```
| ?- solo(Soloist,argo,zrg948).
Soloist = bennett.
yes
```

Questions like the above involve a concept similar to that of "variables" in other languages. Variables in PROLOG are distinguished from other words by starting with an uppercase letter. (Other versions of PROLOG use different variable conventions. For example, MicroPROLOG allows variables X, Y, X0, Y0, X1, Y1, etc. MicroProlog is available from Programming Logic Systems, 31 Crescent Dr., Milford, CT 06460.) In this case, as PROLOG thumbs through its database, it is looking for an entry that matches all items except the one describing the soloist's name. When it finds a component of an entry that matches, it "sets" the variable "Soloist" to that matching component. For example, in the above, the variable "Soloist" is set to "bennett." PROLOG then responds with values of all the variables used. The period in "Soloist = bennett." is entered by the user, and it means, "This is the soloist that I was looking for." If the response had been a semicolon (;), which means, "This isn't the soloist I was looking for," PROLOG would have continued to search for another entry that

matched. In this case, since Bennett is the only soloist on the record, PROLOG would have eventually answered "no" to your ";" response.

If the file PROLOG originally consulted had information about another recording performed by the Academy of St. Martin in the Fields, this one entitled "Handel-Orchestral Works," two soloists would have been found. Both Nicklin and Davis performed oboe solos on this Philips recording, catalog number 6727. Let's exit PROLOG and add this information to the file:

```
records('Handel-Orchestal Works;
Academy of St. Martin in the
Fields; marriner, philips. 6727).
performance('Water Music; handel,
philips. 6727).
performance('Music for the Royal
Fireworks; handel, philips. 6727).
solo(nicklin, philips. 6727).
solo(davis, philips. 6727).
```

Then reinvoke PROLOG and reconsult the file:

```
| ?- consult(collection).
| collection consulted |
yes
| ?-
```

Now that we've these new facts, we can ask, "Who are the soloists on Philips record 6727?"

Bach Orchestra Suites
Academy of St. Martin in the Fields
Marriner
Argo zrg948
Shelf 6

Orchestra Suite No. 2 in B Major
Bach
Argo zrg948

Bennett
Argo zrg948

Figure 2: *Sample index cards.*

```
| ?- solo(Soloists,philips,6727).
Soloists = nicklin;
Soloists = davis;
no
| ?-
```

PROLOG finally responds with "no" only because we didn't accept the two possible answers. If we had typed a period (.) in response to any of the two choices, PROLOG would have responded with "yes."

Suppose we want to ask, "Did Bennett perform Handel's 'Water Music' on a recording conducted by Marriner?" No entries relate a soloist directly to music that he or she performed, only to the record on which he performed. To find out what compositions were performed, we have to search the "performances" drawer. If we want to find out who conducted that performance, we have to search the drawer labeled "records."

To answer the above question, we must rephrase it in terms that apply to our filing system. One way to rephrase this question is, "On what recording did Bennett perform such that that recording was of Handel's 'Water Music' and that recording was conducted by Marriner?" The information needed to answer this question is stored in three different drawers—the "performance" drawer, the "solo" drawer, and the "records" drawer. We need some way to go from one drawer to another (see figure 3). Clearly, the "link" between drawers is information about the recording, specifically the record label and catalog number.

(continued)

THE PROCESS BY HAND

Now let's run through the process of answering this question by hand. First, we thumb through the "performance" drawer for a performance of Handel's "Water Music." (See figure 4a.) When we find one, we note the record label and catalog number and thumb through the "records" drawer looking for that recording. Once we find it, we look to see if Marriner was the conductor. (See figure 4b.) If he wasn't, then we have to go back to the "performance" drawer again, forget about the recording we last noted, and find another recording of that piece. (See figure 4c.)

If the recording was conducted by Marriner, we head for the "solo" drawer, seeking the same recording, and check to see if it featured Bennett. (See figures 4d and 4e.) If it did, we have our answer; otherwise, we have to return to the "solo" drawer and find another entry for that recording—there could be more than one soloist on a recording. If there isn't another entry, we go back to the "records" drawer and look for another entry for that recording. Clearly, there won't be one, because the "records" drawer has only one entry per recording. So we have to go back to the "performance" drawer and start the process again.

With any luck, we remembered to mark each card in the "performance" drawer as we found a pertinent entry. If we didn't, then each time we have to go back to it, we must start thumbing from the beginning.

This process, called backtracking, is analogous to the way PROLOG processes questions. We can view each time we thumb through a drawer, go from one drawer to another, or go back to a previous drawer as part of a path through the filing system. PROLOG guarantees that if there is a path that leads to a solution to the question, it will find it. In this way, unlike with a conventional programming language, we don't have to tell PROLOG how to find a solution. In PROLOG, the above query would be expressed as follows:

```
| ?-performance('Water
Music',_,Label,Number).
| records(____,marriner,Label,
Number).
| solo(nicklin,Label,Number).
```

Label = philips.
Number = 6727.
yes

The underscore character () is used to represent some variable that we don't care to name, because we never need to refer to it again. These variables

refer to parts of an entry on which there are no restrictions; we don't care who composed the piece, what the title of the record was, or what ensemble performed it. Although the record label and catalog number are unimportant, PROLOG must use the same ones to link the three drawers together, so you must

ILLUSTRATIONS BY CHIS SPOLLEN

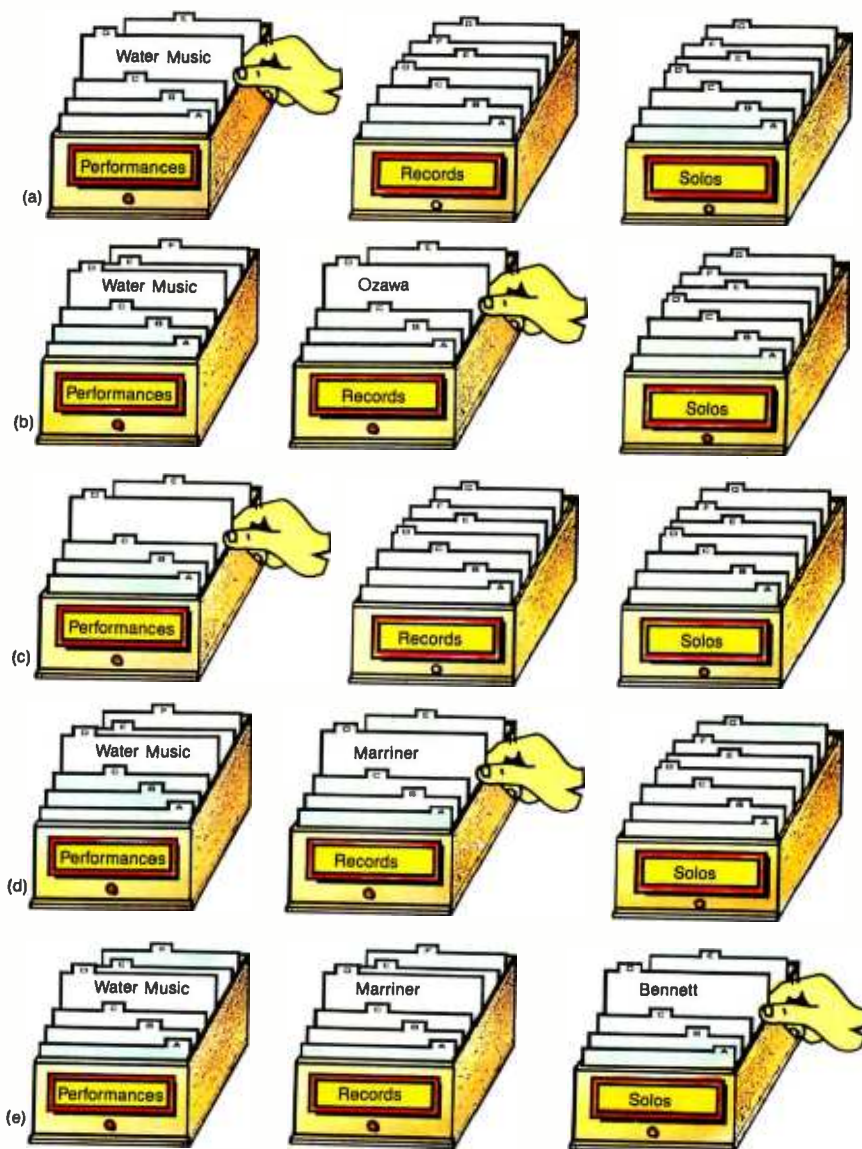

Figure 4: The process of answering the question.

PROLOG

guarantees that if there is a path that leads to a solution to the question, it will find it.

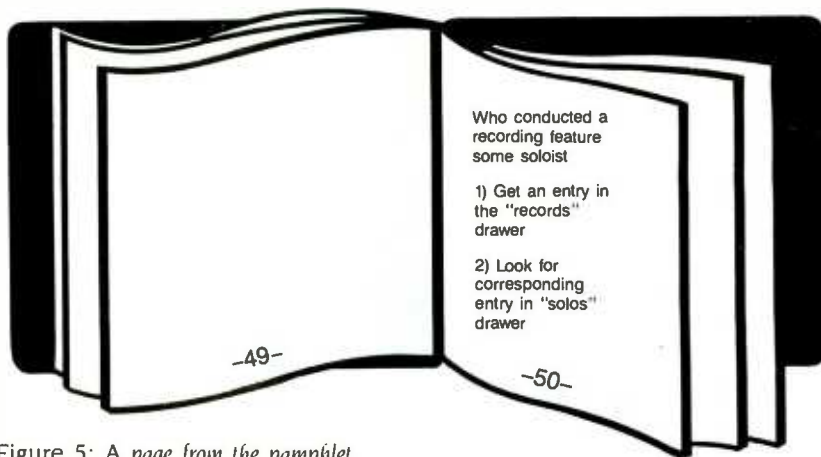

Figure 5: A page from the pamphlet.

name them. Unfortunately, PROLOG doesn't understand that the specific record label and catalog number are used temporarily to answer the question, so it displays them as part of the response.

REPHRASING A QUESTION

It's easy for the record collector to rephrase a question, but for others, it may be difficult. For them, the collector has written a small pamphlet containing possible general questions such as, "Who has conducted on recordings featuring some soloist?" The collector has included instructions on how to use the file system. An example of a page in the pamphlet is given in figure 5. To answer a question that needs rephrasing, we thumb through the pamphlet, looking for a page with our question, and then thumb through the file drawers following the instructions in the pamphlet.

Because we have rewritten each entry in our file drawers in PROLOG, we can do the same with each page in the pamphlet. Instead of being facts about the record collection, the entries are rules for finding out new facts using the record collection. The page shown in figure 5 would be rewritten in PROLOG as follows:

```
conductor__soloist(Conductor.
Soloist) :-
records(___.Conductor.Label,
Number).
solos(Soloist.Label.Number).
```

In PROLOG, the colon/hyphen (:-) is used to separate the "goal" of finding the conductor of a recording that features a specific soloist from the

"method" PROLOG must use for finding this information. Because the rule is given in a general form, we can ask several variations on it. For example, we ask, "Did Marriner conduct a recording featuring Bennett?"

```
?- conductor__soloist
(marriner.bennett).
```

Or, "What soloist was featured on a recording conducted by Marriner?"

```
?- conductor__soloist
(marriner.Soloist).
|
```

Or, "Was Bennett featured on a recording conducted by some conductor?"

```
?- conductor__soloist
(Conductor.bennett).
```

Finally, we can ask just the general question, "Who conducted a recording featuring some soloist?"

```
?- conductor__soloist
(Conductor.Soloist).
```

For each question, PROLOG thumbs through its database trying to match either a fact or the goal part of a rule. If it matches a rule, the method part, functioning as the rephrased question, is posed to PROLOG with the appropriate substitution of variables. That is, for the question

```
?- conductor__soloist
(marriner.bennett).
```

the rephrased question posed to PROLOG would be

```
records(___.marriner.Label,
Number).
solos(bennett.Label.Number).
```

This process is called "pattern-directed invocation."

The pamphlet also comes in handy when you're answering questions about what people work together. For example, having heard a rumor that Neville Marriner and Robert Davis are feuding, we may want to know if it is true. It couldn't be possible if the two have never worked together, so we want to know if they have. Picking up the pamphlet, we thumb through it to find a method for figuring out if the two have ever worked together. We find the following:

```
Do PersonA and PersonB work
together
1) See if PersonA soloed on a re-
cording. If so, then see if PersonB
soloed on the same recording.
```

In PROLOG this would appear as:

```
work__together(PersonA.PersonB) :-
solos(PersonA.Label.Number),
solos(PersonB.Label.Number).
```

The rephrased question would be:

```
solos(marriner.Label.Number).
solos(davis.Label.Number).
```

Clearly, this approach will not succeed, because Marriner is a conductor, not a soloist. Going back to the pamphlet, we look for another method to answer our question. On page 55 we find:

```
Do PersonA and PersonB work
together
1) See if PersonB soloed on a re-
cording conducted by PersonA.
```

(continued)

How to cure the, "Presentation must be ready tomorrow" headache:



Authorized Dealerships available.

Use one Penpad tablet.

It has great slide effects. Now, anyone can prepare 35mm slides, overhead transparencies, or a whole presentation on a video monitor by using the Penpad.

Penpad is the only graphics tablet in the world that lets you run your PC with one hand. Draw, paint, plot, cut, paste, and label your work in the easiest, most natural way possible—with pen and paper. Capture and personalize images from Lotus™ 1-2-3 and others. It can read your writing and display it in dozens of type styles.

With our custom graphics software, Pendraw™, an easy-to-use 4-color program, or our advanced, 16-color VIDEOGRAM™, you can do in hours what once took days or weeks.

There is no better remedy for the pains of an upcoming presentation, so take two aspirins and call your IBM PC dealer in the morning.

Lotus™ 1-2-3 is a trademark of Lotus Development Corp.

Pencept, Inc. 39 Green Street, Waltham, MA 02154 617/893-6390
In Canada call, Scarsdale Technologies (416) 441-1900

PENCEPT

Circle 136 on inquiry card.

PROLOG

This method is similar to the first, but it does not have the same flaw. In PROLOG, a method can consist of either rules or facts interspersed. This rule would appear as:

```
work__together(PersonA.PersonB) :-
  conductor__soloist(PersonB,
    PersonA).
```

From what we know, they do work together. Maybe the feud is still on!

If we exit PROLOG again, add the rules we encountered in the pamphlet to our file "collection;" reinvoke PROLOG, and reconsult the file. We can ask PROLOG for an answer to the above questions.

CONCLUSIONS

Owners of a personal computer need a language such as PROLOG that allows them to solve common but interesting problems without having to devote an inordinate amount of time to programming. One might think that a language like LISP, which is widely used in the Artificial Intelligence community, might be as effective as PROLOG for common real-world problems, but that's not the case. LISP is a much lower-level language. The main advantage that PROLOG has over LISP is the fact that patterns and pattern matching are so fundamental to PROLOG. The problem of representing knowledge in LISP is casting that knowledge into lists that LISP can process. ■

REFERENCES

1. Bowen, D. L., L. Byrd, L. M. Pereira, F. C. N. Pereira, and D. H. D. Warren. *PROLOG on the DECSystem-10 User's Manual*. University of Edinburgh, Scotland: Technical Report, Department of Artificial Intelligence, October, 1981.
2. Clocksin, W. F., and C. S. Mellish. *Programming in PROLOG*. New York: Springer-Verlag, 1981.
3. Kowalski, R. A. "Predicate Logic as a Programming Language." *Information Processing 74*. New York: North-Holland, 1974, pp. 569-574.
4. Roussel, P. *PROLOG: Manuel Reference et d'Utilisation*. Technical Report, Groupe d'Intelligence Artificielle, Marseille-Luminy, September, 1975.
5. Shapiro, E. Y. "A Subset of Concurrent PROLOG and Its Interpreter." Technical Report TR-003, ICOT—Institute for New Generation Computer Technology, January, 1983.
6. Warren, D. H. D. "Implementing PROLOG—Compiling Predicate Logic Programs." University of Edinburgh, Scotland: Technical Reports 39 and 40, Department of Artificial Intelligence, 1977.

Softline

FOR YOUR BOTTOM LINE.

Lotus 1-2-3 \$309	dBase III \$CALL	WordStar Professional \$359	MultiMate \$269
------------------------------------	-----------------------------------	--	----------------------------------

WORD PROCESSING/EDITORS

Easywriter II System (3 pak)	\$219
Fancy Font	\$159
Final Word	\$189
Microsoft Word	\$239
Microsoft Word/Mouse	\$299
Multimate	\$269
PeachText 5000	\$219
PFS: Write	\$ 95
VolksWriter Deluxe	\$169
The Word Plus (Basis)	\$109
Word Perfect (SSI)	\$CALL
WordPlus-PC with The Boss	\$319
WordStar	\$239
WordStar Professional (WS/MM/SS/Sl)	\$359
WordStar Options Pak (MM/SS/Sl)	\$189
XYWrite II+	\$229

SPREADSHEETS/INTEGRATED PACKAGES

Electric Desk	\$CALL
Framework	\$CALL
InteCalc	\$189
Jack 2	\$329
Lotus 1-2-3	\$309
Multiplan	\$135
Open Access	\$379
Ovation	\$CALL
Smart System	\$579
SuperCalc 3	\$239
Symphony	\$CALL
TKI Solver	\$269
VisiCalc IV	\$159

PROJECT MANAGEMENT

Harvard Project Manager	\$239
IntePerf/Plan	\$239
Scitor Project Scheduler	\$229
VisiSchedule	\$199

LANGUAGES/UTILITIES

Concurrent w/Windows	\$219
Digital Research C Compiler	\$219
Lattice C	\$309
Microsoft C Compiler	\$329
MS Basic Compiler	\$249
MS Fortran	\$239
Norton Utilities	\$ 59

COMMUNICATIONS/PRODUCTIVITY TOOLS

Crosstalk	\$119
Memory Shift	\$ 79
Move It	\$109
Prokey 3.0	\$ 95
Relay	\$ 99
Smartcom II	\$109

GRAPHICS/STATISTICS

Abstat	\$279
BPS Business Graphics	\$229
Chartman Combo (II&IV)	\$349
Chartmaster	\$259
dGraph	\$189
DR Draw	\$199
Energraphics w/Plotter	\$319
Execuision	\$279
Fast Graphs	\$219
Graphwriter Combo	\$399
PC Draw	\$279
PFS: Graph	\$ 95
Statpac-NWA	\$329
Statpac-Walonic	\$299

ACCOUNTING MODULES

Ask Micro Accounting	\$299
BPI Accounting	\$369
IUS EasyBusiness System	\$319
MBA Accounting	\$369
Open Systems Accounting	\$459
Peachpak 4 (GL/AP/AR)	\$239
Peachtree Accounting	\$399
Real World Accounting	\$469
Star Accounting Partner (GL/AP/AR/PAY)	\$269

DATABASE SYSTEMS

Alpha Data Base Manager II	\$179
Condor III	\$329
dBase II	\$289
DBplus	\$ 89
Friday	\$179
InfoStar	\$269
Knowledgebase	\$299
PFS: File/PFS: Report	\$169
Powerbase	\$289
QuickCode	\$169
R-base 4000	\$279
TIM IV	\$269
Versaform	\$249

PROFESSIONAL DEVELOPMENT

Management Edge	\$169
Think Tank	\$129

HOME/PERSONAL FINANCE

Dollars and Sense	\$119
Financier II	\$119
Home Accountant Plus	\$ 99
Sundex-CPA	\$109
Tax Preparer 84	\$189

HARDWARE PERIPHERALS*

AST Six Pack Plus (64k)	\$269
Quadboard (OK)	\$CALL
Hayes 1200B with Smartcom	\$399
Hayes Smartmodem 1200	\$499
Keytronic 5151 DLX	\$209
IRMA	\$995
Hercules Graphics Board	\$349
Epson FX-100 Printer	\$CALL
Comrex II Printer	\$CALL
C Itoh Prowriter	\$CALL
C Itoh Starwriter	\$1199
Okidata 93A	\$749
64K Memory	\$ 55

*Call for shipping.

R: base 4000 \$279	Volkswriter DLX \$169	AST 6 Pak Plus \$269	Smartmodem 1200B \$399
-------------------------------------	--	---------------------------------------	---

free!

Diskette Library Case

with your order



DISCOUNT COUPONS

With each order, we offer **discount coupons** worth up to **\$10** on your next order.

1-800-221-1260

In New York State call (212) 438-6057

TERMS
Checks—allow 14 days to clear. Credit processing—add 3% COO orders—cash, M.O. or certified check—add \$3.00. Shipping and handling UPS surcharge—add \$3.00 per item. (UPS Plus \$6.00 per item) NY State Residents—add applicable sales tax. All prices subject to change.



Softline

Softline Corporation
3060 Bedford Ave., Brooklyn, N.Y. 11210
TELEX: 421047 ATLN UI

**FOR 15 YEARS,
WE'VE BEEN
MAKING
THE WORLD'S
MOST POPULAR
MODEMS.**

**NOW YOU CAN
BUY ONE.**

Introducing the Maxwell Modem™ from Racal-Vadic.

It's not your fault you didn't buy one sooner. You couldn't. Unless you happened to be a major corporation. They're the ones who buy the most modems. And the modems they buy most are ours.

Now we've taken everything we know about modems and made one you can buy.

The Maxwell Modem.

It's designed expressly for personal computers. And the people who use them. It's rugged. Reliable. And it even operates over low-quality phone lines that other modems can't handle.

But best of all, it's uncomplicated. So you don't have to know how one works to work one. There's no control panel to control. No switches to switch.



The Maxwell Modem and George are trademarks of Racal-Vadic. IBM is a registered trademark of International Business Machines Corp. ©1984, Racal-Vadic.

Instead, every feature makes sense. Auto-dialing. Auto-answer. And complete unattended operation.

Our communications software is just as accommodating. It's called George.™ And we've made George so simple to use you may never have to open your manual.

The Maxwell Modem comes in two different versions and two different speeds: Internal modems for the IBM PC and compatibles, and desktop models for virtually every personal computer. Both are available with speeds of 300- or 1200-bps.

And every Maxwell Modem has diagnostic features built in. So we can test your modem right over the phone from our Remote Diagnostic Center. We'll even pay for the call.

So where can you get your hands on a Maxwell Modem? To find our dealer nearest you, just do what modems do.

Call 800-4-VADICS.

Racal-Vadic, 1525 McCarthy Blvd., Milpitas, CA 95035.

THE MAXWELL MODEM.

From Racal-Vadic.



BY WILLIAM J. CLAFF

AN INTRODUCTION TO PC ASSEMBLY- LANGUAGE PROGRAMMING

How to program the 8088

This is a guide for writing assembly-language programs or routines on the IBM PC. It is necessary to program in assembly language when an application must be as fast as possible or when the high-level language being used cannot perform the desired operation. High-level languages are also easier to comprehend when you understand assembly-language concepts. This article is not a primer. I am assuming that you have read a primer or manual and are left with unanswered questions. I hope this article will answer some of those questions and that, with one or more of the references listed at the end of the article, you will become a more polished assembly-language programmer. I will present specifics of the 8088 first, followed by a sample program and routine. The program is a useful utility illustrating DOS (disk operating system) function calls and string manipulation. The routine introduces a new technique for writing code to be called from BASIC.

THE 8088 CENTRAL PROCESSING UNIT

Figure 1 shows an elementary block diagram of the 8088. This processor has two separate processing units: the execution unit (EU), which executes instructions, and the bus interface unit (BIU), which is responsible for the 8088's communication with the outside world. The BIU is capable of coor-

*I assume you have
read a primer
and are left
with unanswered
questions. I hope this
article will answer
some of those questions.*

ordinating multiple EUs such as the 8087 numeric data processor (NDP) and the 8089 I/O processor. The only difference between the 8088 and the 8086 is their BIUs.

The BIU sits between the EU and the outside world. An EU provides a logical address to the BIU, which translates it into a physical address. This translation, called the physical-address computation, uses two 16-bit quantities: a segment register and an offset. The notation used for logical addresses is segment:offset. The segment registers (parts of the BIU) are code segment (CS), stack segment (SS), data segment (DS), and extra segment (ES). The offset is usually supplied by the EU.

The physical address is computed by shifting the segment register left 4 bits and adding the offset in the BIU's dedicated adder. Segments are 64K-

byte relocatable pieces of the 1-mega-byte physical-address space. They are located on 16-byte boundaries called paragraphs. Assembly-language programs are written in logical segments. Placement of these segments in memory is a function of the linker and the DOS. They can be overlapped, contiguous, or disjointed.

The address of the next instruction to be executed is CS:IP, (code segment: instruction pointer). For increased efficiency, the BIU pipelines bytes (prefetches them and puts them into a queue). To facilitate this calculation, the offset instruction pointer is kept in the BIU.

The EU contains eight 16-bit registers, any of which can be used in computations. Four of these registers comprise the data group. They are the accumulator (AX), base (BX), count (CX), and data (DX) registers. The high and low 8 bits of each data register also can be accessed. The two halves of the accumulator register are AH (accumulator high) and AL (accumulator low). The halves of the base, count, and data

(continued)

William J. Claff (7 Roberts Rd., Wellesley, MA 02181) is a member of the engineering department of Spinnaker Software Corporation, where he is the in-house expert on the IBM PC family. He also has run his own microcomputer retail and consulting business for the past six years. Mr. Claff holds a master's degree in applied mathematics from Harvard University.

EVEREX

EVER for EXcellence

132 Cols × 44 Rows +
Simultaneous Color
and Monochrome
Graphics Display +
One Card/
Single Slot =

The Graphics Edge™



The **GRAPHICS EDGE** is the leading edge. We've really pushed technology to the limit with this one, and here's why:

- it is software switchable from 80 cols x 25 rows to 132 cols x 44 rows, making it ideal for spreadsheet applications,
- drives both a color and a monochrome monitor **SIMULTANEOUSLY** and prints this same information in color on your color printer. Ideal for business applications involving heavy word processing combined with color graphics requirements,
- and runs Lotus 1-2-3™ with **FULL GRAPHICS** and also Microsoft Flight Simulator™ on either high-resolution IBM® Monochrome or color monitors.

And if that's not enough, there's more!

- it is **Fully Compatible** with IBM Monochrome and color adaptors, Colorplus™ and Hercules™

- will run all IBM Color Graphics Software on the IBM Monochrome Display, opening to you a wealth of IBM Color Graphics software applications,
 - supports all **BASICA** graphics commands on IBM Monochrome or color monitor without software patches,
 - 640H x 200V in 16 colors,
 - 16 shades of green in green monitors with composite output; and, . . .
- one printer port and one light pen interface.

No Other Card can give you So Much for So Little. At a Suggested retail price of \$499, you and your IBM PC will be performing to the fullest potential. **WHAT ARE YOU WAITING FOR!!!**

OEM Inquiries Welcomed.

**For more information, contact your nearest dealer.
OEM and Dealer Hotline 800-821-0806.
In California call 800-821-0807.**

Microsoft Flight Simulator is a trademark of Microsoft Corp.
IBM is a registered trademark of International Business Machines Corporation.
Lotus 1-2-3 is a trademark of Lotus Development Corporation.
Colorplus is a trademark of Plantronics.
Hercules is a trademark of Hercules Computer Technology.
Graphics Edge is a trademark of Everex Systems, Inc.

AD 88



Everex Systems, Inc.
Circle 61 on inquiry card.

891 Maude Ave., Mountain View, California 94043 (415) 967-1495

Price subject to change without notice.

registers are similarly named.

Two other general registers, the source index (SI) and the destination index (DI), comprise the index group. These registers are used primarily in string operations. Two segment registers are required to perform moves or comparisons on memory more than 64K bytes apart. This is why there is an extra segment in addition to the data segment. The destination in a string operation is always ES:DI (extra segment: destination index).

The last two general registers, the stack pointer (SP) and the base pointer (BP), comprise the pointer group. These registers manipulate the stack that holds subroutine return information. When a subroutine is invoked, SS:SP (stack segment: stack pointer) is used to store the return address on the stack. Stack pointer points to the top of the stack and is automatically decremented by calls and incremented by returns. The stack also is used to pass subroutine parameters. The base-pointer register is used to access these parameters.

Many of the registers in the EU have special uses. Table 1 shows these registers and their uses.

ADDRESSING

An offset is also known as an effective address. The EU generates an effective address using one of several methods called addressing modes. An effective address has one or more of the following: base, index, and displacement. A base can be either a base register or base pointer; an index can be either a source index or destination index; and the displacement is a 16-bit signed number.

If no segment register is specified, the data-segment register will be used. If the base-pointer register is specified as the base, the stack-segment register is used. Supplying a segment register that is not the default is called a segment-override prefix. The segment cannot be overridden for an instruction pointer, stack pointer, or destination-index registers in string operations. Figure 2 shows how the various addressing modes in the EU and the BIU combine to form the physical address.

There are three types of addresses: Short, Near, and Far. Short addressing is used for looping, conditional jumps,

and for some unconditional jumps. Near and Far addressing are used in calls and unconditional jumps that do not qualify for Short addressing. Short and Near addresses affect only the instruction-pointer register and are always relative.

Far addresses affect code-segment and instruction-pointer registers and are absolute. When the value of the code-segment register does not change, you have intrasegment addressing. When

(continued)

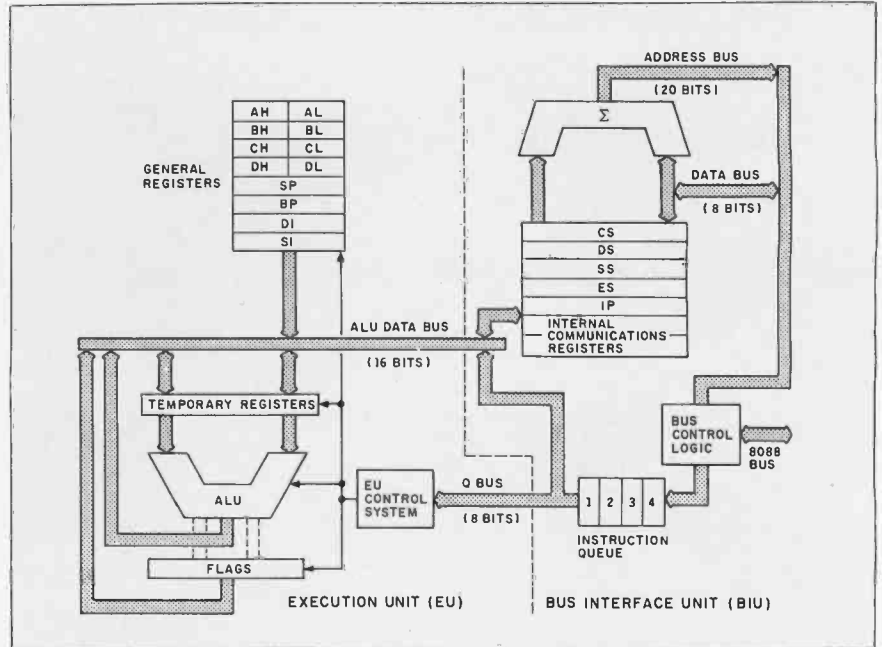

Figure 1: A block diagram of the 8088's two processing units (see reference 3).

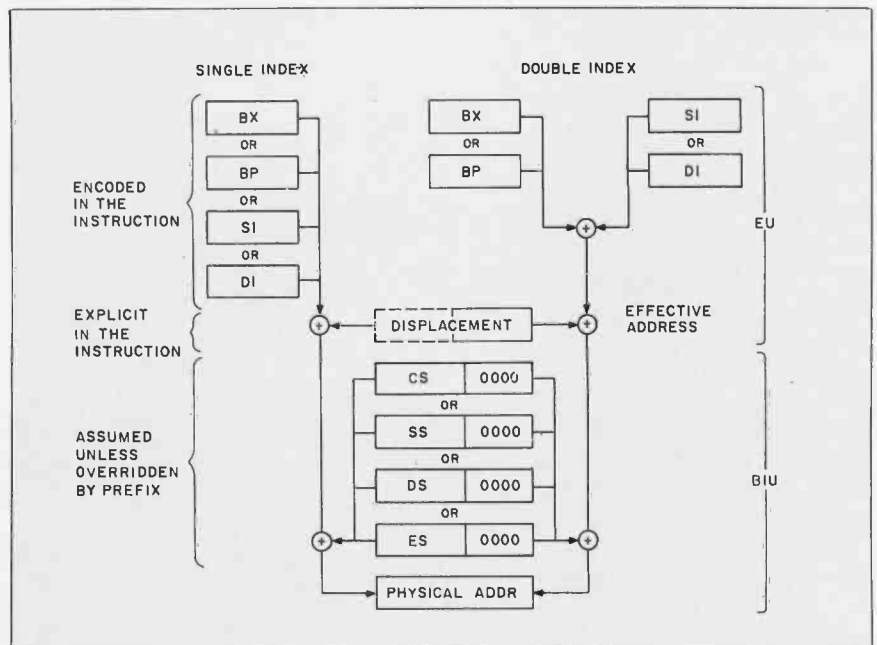

Figure 2: Addressing modes in the execution unit and bus-interface unit combine to form the physical address (see reference 4).

Two more great reasons to buy the Canon[®] AS-100 Microcomputer.

1. Incredibly low price.
2. Free software.



Now there's even more incentive to buy Canon's AS-100 Microcomputer.

Because not only will you get one of the most advanced, small business microcomputers you can buy, but with a price that's now dramatically reduced, you'll also get value that's just as far ahead of its time. Plus free business management programs.

That's an unprecedented saving on this elegantly compact, yet powerful microcomputer.

It has a high-speed, 16-bit microprocessor with standard 128K-bytes RAM expandable to 512K bytes.

A high-resolution, color display system for easy-to-read figures, charts and graphs (monochrome green display if you prefer).

The convenience and versatility of a lightweight keyboard that's adjustable for maximum comfort. Plus external storage capacity that includes 5¼-inch mini or 8-inch floppy disks, with hard disk drive

also available.

And if all this isn't reason enough, the AS-100 now comes fully equipped with a choice of popular business software packages. Software such as WordStar* for word processing, CalcStar* and SuperCalc 2*** for spreadsheet analysis and dBase II** for data base management. There's also a choice of Canon's exclusive software—Canowriter† and Canobrain II†.

Terrific savings and a choice of software packages.

Two more great reasons to buy the only microcomputer that comes with the assurance, reliability and technological quality of Canon.

The Canon AS-100.

For more information:
Call 1-800-323-1717, Ext. 302.
(In Illinois call 1-800-942-8881, Ext. 302.)
Or Write Canon U.S.A., Inc.,
Systems Division, P.O. Box CN 11250
Trenton, N.J. 08638.

*InfoStar, CalcStar and WordStar are trademarks of MicroPro. **Friday! is a trademark and dBase II is a registered trademark of Ashton-Tate. ***SuperCalc 2 is a trademark of Sorcim. †Canowriter and Canobrain II are trademarks of Canon, Inc.

Available through Canon authorized dealers.
Offer good through October 31, 1984.
© 1984 Canon U.S.A., Inc.

Canon Systems Division

Circle 28 on inquiry card.

The segmented addressing scheme of the 8088 differs from the traditional linear addressing scheme. . . . It shortens the instruction length. . . of data items.

the value of the code-segment register does change, you have intersegment addressing. A Near call puts only the instruction-pointer register for the return on the stack. A Far call puts both code-segment and instruction-pointer registers for the return on the stack. Consequently, there are different Near and Far returns. A Near call to a Far procedure, or vice-versa, is a disaster.

The segmented-addressing scheme of the 8088 differs from the traditional linear-addressing scheme in several ways. Segmented addressing shortens the instruction length and the size of data items required for addresses. This saves memory and speeds execution because fewer fetches are required. It also allows you to easily relocate logical segments. Linear addressing is superior for processing data that is larger than 64K bytes.

INTERRUPTS

The 8088 does not distinguish between

interrupts invoked with the assembly-language instruction INT or by the hardware. There are 256 interrupts, vectored through a table of double words located at hexadecimal 00000H:00000H (all locations mentioned in this article are hexadecimal). Each double-word entry in the table corresponds to the CS:IP (code segment: instruction pointer) of the subroutine that is invoked for that interrupt.

An interrupt is handled like a Far call except that the flags are also pushed on the stack before the return CS:IP (code segment: instruction pointer). In addition to Near and Far returns, there is an interrupt return. The 8088 uses interrupts 000H through 004H for division by zero, single stepping, nonmaskable interrupts, breakpoints, and overflows. Hardware interrupts IRQ0 through IRQ7 are mapped into interrupts 008H through 00FH by the 8259A interrupt controller.

MEMORY USAGE

The interrupt vector table is an example of a fixed portion of memory that is used in a particular way. To program the IBM PC effectively, you have to have an understanding of all such fixed areas.

The 8088 begins execution at 0FFFFH:00000H. On the IBM PC, this is an entry point into the BIOS (basic input/output system). This code is in ROM (read-only memory) at 0FE00H:00000H; therefore, it is called the ROM BIOS. It contains the basic code necessary to interface with all of the hardware devices. You can reach the subroutines of the ROM BIOS through software interrupts 010H through 01FH. The ROM BIOS

also uses memory at 00040H:00000H through 00040H:000FFH. Some of the values kept in this area include the current video mode and the keyboard buffer.

There is a version of ROM BASIC located at 0F600H:00000H. This BASIC and the disk-based BASICs also use memory at 00050H:00000H through 00050H:000FFH, as do some DOS functions.

The memory from 00060H:00000H through 00060H:000FFH is used under DOS 2.0 and DOS 2.1 to store various disk variables. When DOS is booted, the boot code loads the hidden files IBMBIOS.SYS and IBMDOS.SYS into memory directly above these reserved areas. IBMBIOS is also known as the RAM (random-access read/write memory) BIOS. It moves IBMDOS down to recover unused space and transfers control to DOS. DOS functions are invoked through interrupts 020H to 027H. DOS initializes devices, loads COMMAND.COM into memory directly above itself, and transfers control to COMMAND. To make more memory available to the user, COMMAND relocates a portion of itself, the transient portion, into high memory.

COMMAND is responsible for executing internal or external commands. For example, DIR is an internal command (the code for DIR is inside COMMAND), while CHKDSK is an external command (the code for CHKDSK is in a file called CHKDSK.COM). The macro-assembler, MASM (found in a file called MASM.EXE), is also an external command.

(continued)

ULTRA-RES™ GRAPHICS

Prices from \$995



ULTRA-RES,

a family of graphic controllers for IBM-PC / XT and S-100 systems.

Advanced feature display controllers for IBM-PC / XT and compatible systems. Features include NEC7220, programmable resolution to 1024x1024, slave controllers, transparent mode allows monochrome adapter and ULTRA-RES on same monitor, DMA compatible, light pen, externally powerable. Monitor protection circuits. Video outputs are TTL direct drive or analog. Software drivers.

C.S.D. Incorporated
P.O. Box 253
SUDBURY, MA 01776

(617) 443-2750

ULTRA-RES Trademark CSD Inc.
IBM-PC Trademark IBM

Now you don't have
to sacrifice print
quality for speed.

The Canon® Impact Matrix Series Printers.



High speed and high quality in one functional, compact unit. That's what Canon's Impact Matrix Printers offer you.

They print hard copy at a rapid 160 characters per second. While in the double pass mode you get an impressive, high-density 23 X18 dot matrix that gives near letter quality printing suitable for word processing.

Canon's unique technology has also dramatically reduced bothersome clatter down to a muted noise level of less than 60dB.

Even at high speed.

And that, unlike many other impact matrix printers, makes them a pleasure to work with.

Plus there's limitless flexibility with the optional down-loading function that lets you print

whatever character fonts your host computer can create. As well as a choice of four different character styles (all printable on the same line) that you can enlarge or condense.

The Impact Matrix Series Printers give you a convenient choice of special paper widths—the PW-1080A for 80-character column printout and the PW-1156A for 156-character column.

Exceptional quality and high speed.

The Canon® Impact Matrix Series Printers give you the best of both worlds.

For more information:
Call 1-800-323-1717, Ext. 300.
(In Illinois call 1-800-942-8881, Ext. 300.)
Or Write Canon U.S.A., Inc.,
Printer Division, P.O. Box CN 11250,
Trenton, N.J. 08638.

Canon Printer Division

Circle 29 on inquiry card.

© 1984 Canon U.S.A., Inc.

PROGRAM EXECUTION

When COMMAND loads code to execute an external command to perform a task, it first builds a 256-byte program segment prefix (PSP). The program segment, which has its origins in CP/M, contains important information about the task. Listing 1, PSP.INC, shows the layout of the program-segment prefix.

If the code is in a command (.COM) file, the contents of the file are put into memory at CS:00100H, where the code segment points to the program-segment prefix. A .COM file contains exactly one logical segment. When execution begins, CS=DS=ES=SS=PSP (code segment = data segment = extra segment = stack segment = program-segment prefix), IP (instruction pointer) = 00100H, SP (stack pointer) = 000FEH, and there is a zero word on the top of the stack.

If the code is in an executable (.EXE) file, then the file contains relocation information and one or more logical segments. In this case, when execution begins, DS=ES=PSP (data segment = extra segment = program-segment prefix) and CS:IP (code segment:instruction pointer) and SS:SP (stack segment:stack pointer) depend on the assembly and link conditions. It is common for the code segment to be PSP (program-segment prefix) + 00010H and IP (instruction pointer) to be 00000H.

A Near return is used to terminate execution of .COM files. A zero word is placed on the top of the stack, and the code at PSP (program-segment prefix) :00000H is an INT 020H instruction. INT 020H is the DOS terminate function. A jump to 00000H or an INT 020H will also terminate the program. I prefer INT 020H because it does not depend on the state of the stack.

For .EXE files, none of the .COM file methods work. INT 020H assumes that CS=PSP (code segment = program-segment prefix) because the original DOS, developed by Tim Patterson at Seattle Computer Products, supported only .COM files. To terminate an .EXE file, you have to transfer control to the INT 020H instruction in the program-segment prefix with CS=PSP (code segment = program-segment prefix). One common method is to push the initial data segment value and a 0 on the stack and do a Far return to terminate.

Listing 1: This program shows the layout of the program-segment prefix.

```

:.....
:PROGRAM SEGMENT PREFIX
:.....
TOP_OF_MEMORY      DB  2 DUP(?)      :int20
                   DW  ?
                   DB  ?
                   DB  5 DUP(?)      :ioct1
TERMINATE           DD  ?
CTRL_BREAK          DD  ?
CRITICAL_ERROR      DD  ?
                   DB  22 DUP(?)     :used by dos
ENVIRONMENT         DW  ?
                   DB  46 DUP(?)     :used by dos
FORMATTED_AREA_1   DB  16 DUP(?)
FORMATTED_AREA_2   DB  16 DUP(?)
                   DB  4 DUP(?)
UNFORMATTED_AREA   DB  128 DUP(?)
    
```

Because the stack may not be in the desired state, I prefer to store the initial data segment value and a 0 in a double word and to jump indirect through this double word to terminate.

PROGRAM WALKTHROUGH

Listing 2, MAKEBAT.ASM, shows a program that is executed with two parameters: an output filename and a search filename. The program creates a batch file with the output filename and writes a line in for each file that meets the search criteria. Each line has the form

```
%1 filename
```

For example, if we enter

```
MAKEBAT ALLASM.BAT *.ASM
```

this would create a batch file called ALLASM.BAT that might contain the lines

```
%1 MAKEBAT.ASM
%1 SEARCH.ASM
```

Entering the command ALLASM TYPE would cause each .ASM file to be typed in turn.

PROGRAMMING CONVENTIONS AND COMMENTS

Like most programmers, I follow certain rules to make my programs more understandable and maintainable. These rules are my own and I do not contend that everyone else should use them, but I do feel that each programmer should develop his or her own conventions. You are welcome to adopt or adapt mine as you see fit. You may already

have noticed one convention I use regarding hexadecimal numbers—I use leading zeroes so that word values are always five digits and byte values are always three digits.

A semicolon (;) indicates the beginning of a comment. A comment continues to the end of a line. In my programs the characters after the ; indicate the level of comment. The highest level begins ;=====, Major comments begin ;***** and minor comments start with ;-----, I don't generally make remarks on individual lines of code because the scope of such comments is usually too limited. I precede groups of lines with a minor comment concerning their function. Major comments precede groups of minor comments.

PROGRAM STRUCTURE

The 8088's assembly language is strongly typed. Each named item, data, or label has a type, and the assembly language will not let you misuse the item, data, or label. If you declare a variable to be a byte, the assembly language will not let you move that value into a word register. If you declare a label to be a Near procedure, the assembly language will not let you make a Far call to that label. You help the assembly language make these decisions by declaring data before its use.

There are two major classes of declarations—those that reserve memory and those that do not. I place definitions that do not reserve memory at the top of my programs.

Listing 2: This program creates a batch file and is executed with two parameters—an output filename and a search filename.

```

:=====STRUCTURES
:-----FILE CONTROL BLOCK
FCB          STRUC
DRIVE__NUMBER DB      ?
FILE__NAME    DB      8 DUP(?)
FILE__EXTENSION DB    3 DUP(?)
CURRENT__BLOCK DW     ?
REC__SIZE     DW     ?
FILE__SIZE__LO DW     ?
FILE__SIZE__HI DW     ?
FILE__DATE    DW     ?
              DB     10 DUP(?)
CURRENT__REC  DB     ?
RANDOM__REC__LO DW    ?
RANDOM__REC__HI DW    ?
FCB          ENDS

:=====PROGRAM SEGMENT PREFIX
PSP          SEGMENT AT 0
              INCLUDE PSP INC
PSP          ENDS

:=====SSEG SEGMENT
SSEG        SEGMENT PARA STACK 'STCK'
              DW     256 DUP (?)
SSEG        ENDS

:=====DSEG SEGMENT
DSEG        SEGMENT 'DATA'

:-----FILE CONTROL BLOCKS
FCBOUT     FCB    <>
FCBRES     FCB    <>
FCBSEA     FCB    <>

:-----ERROR MESSAGES
MSGCRE     DB     'UNABLE TO CREATE THE OUTPUT FILE.:00DH,00AH:'S'
MSGWRI     DB     'ERROR DURING WRITE TO THE OUTPUT FILE.:00DH,00AH:'S'

:-----OUTPUT LINE TEMPLATE
OUTLINE    DB     '%1 ?;????????;???' :00DH,00AH

:-----DOUBLEWORD FOR RETURN
RETURN     LABEL  DWORD
RETIP      DW     0
RETCS     DW     ?

:-----SEARCH FUNCTION. 011H FIRST TIME THEN 012H.
VARFUN     DB     011H
DSEG       ENDS

:=====CSEG SEGMENT
CSEG       SEGMENT 'CODE'

:.....PROCEDURES
          ASSUME CS:CSEG,DS:DSEG,ES:DSEG,SS:SSEG
TRAIL     PROC   NEAR
TRAIL     LABEL  NEAR
          CMP    BYTE PTR ES:[DI] - [I],
          JNE   TRAILX
          DEC   DI
          JMP   TRAILL
TRAILX    LABEL  NEAR
          RET
TRAIL     ENDP

:.....MAIN PROGRAM
          ASSUME CS:CSEG,DS:PSP,ES:PSP,SS:SSEG
CONDSEG   DW     DSEG
:-----ENTRY-POINT
IP        LABEL  NEAR
:.....INITIAL AND PSP PROCESSING
:-----ES=DSEG
          MOV    ES,CONDSEG
          ASSUME ES:DSEG
:-----FORM DOUBLEWORD FOR TERMINATE
          MOV    RETCS,DS
    
```

MAKEBAT begins with the definition of FCB, a structure that documents the layout of a file-control block. Later, the fields in this definition will allow easy access to quantities such as the REC__SIZE within a particular FCB. The definition starts with the STRUC statement and ends with the ENDS statement. DB and DW stand for define byte and define word. DUP is used to specify a repeating value. A question mark (?) means there is no default value.

The information I need from the command line is stored in the program segment prefix. All segments start with the SEGMENT statement and end with an ENDS statement. The INCLUDE statement brings in the PSP.INC file that was listed earlier. Declaring the segment to be AT 0 tricks the linker into not reserving any memory for this segment in the .EXE file.

The SSEG SEGMENT declares the amount of stack for the program. If there is no stack segment declaration, the linker will generate an error message. This message is really a warning because a stack is still created and usually no harm is done.

The DSEG SEGMENT declares all of the variables. Some variables, such as MSGCRE, have initial values. FCBOUT, FCBRES, and FCBSEA use the FCB definition. The empty angle brackets indicate that none of the fields are to be given initial values different from the defaults in the definition. I list my variables alphabetically so they are easier to find.

The first statement in the CSEG SEGMENT is an ASSUME. This promises the assembly language that each segment register listed will point to the logical segment named after that register. This information will help the assembly language generate segment-prefix overrides where appropriate.

For the same reason that I declare all data before code, I declare procedures before the main code. This should be familiar to Pascal programmers. In this program there is only one procedure, TRAIL. TRAIL is a Near procedure that decrements the destination index, while the byte before the destination index is the blank character. This is used in the main program to remove trailing blanks from the output line. Note the type override, BYTE PTR, in the compare

text continued on page 144



BEST FRIENDS

CF&A is the "best friend" your computer terminal will ever have. Whether it's a specialized desk for your IBM or Apple Personal Computer, a stand for Qume, NEC, Diablo, T.I. and a host of other printers, or a Classic Series Desk in a wide range of sizes and configurations, we have the perfect companion for your personal or business computer system. In addition, our DR Series offers desk height RETMA rack mount enclosures, as either freestanding modules or integrated into the desk. Remember Computer Furniture and Accessories . . . Quality, features and style to bark about at prices that won't make you howl.

CF&A

Computer Furniture and Accessories, Inc.
515 West 132nd Street
Gardena, CA 90248
(213) 327-7710

ASSEMBLY LANGUAGE

```

:----- GET DRIVE,FILENAME AND EXTENSION OF OUTPUT FILE
MOV     CX,(SIZE DRIVE__NUMBER) + (SIZE FILE__NAME) + (SIZE
        FILE__EXTENSION)
MOV     SI,OFFSET FORMATTED__AREA__1
MOV     DI,OFFSET FCBOUT
REP     MOVSB

:----- GET DRIVE,FILENAME AND EXTENSION OF SEARCH CRITERIA
MOV     CX,(SIZE DRIVE__NUMBER) + (SIZE FILE__NAME) + (SIZE
        FILE__EXTENSION)
MOV     SI,OFFSET FORMATTED__AREA__2
MOV     DI,OFFSET FCBSEA
REP     MOVSB

:----- DS=DSEG
MOV     DS,DSEG
ASSUME  DS:DSEG

:..... CREATE THE OUTPUT FILE
MOV     AH,016H
MOV     DX,OFFSET FCBOUT
INT     021H
OR      AL,AL
JZ      CREATED

:----- FAILED
MOV     AH,009H
MOV     DX,OFFSET MSGCRE
INT     021H
JMP     EXIT

:----- SUCCESS
CREATED LABEL NEAR
MOV     FCBOUT.REC__SIZE,I
MOV     FCBOUT.CURRENT__REC,0
MOV     FCBOUT.RANDOM__REC__LO,0
MOV     FCBOUT.RANDOM__REC__HI,0

:..... SEARCH FOR FILENAMES
NEXT LABEL NEAR
:----- SET DISK TRANSFER ADDRESS FOR RESULT OF SEARCH
MOV     AH,01AH
MOV     DX,OFFSET FCBRES
INT     021H

:----- PERFORM THE SEARCH
MOV     AH,VARFUN
MOV     DX,OFFSET FCBSEA
INT     021H
OR      AL,AL
JNZ     DONE

:..... BUILD OUTLINE FROM RESULT
:----- '%1 '
MOV     DI,OFFSET OUTLINE
MOV     AL,'% '
STOSB
MOV     AL,'I'
STOSB
MOV     AL,' '
STOSB

:----- DRIVE & ':'
MOV     AL,FCBRES.DRIVE__NUMBER
ADD     AL,'@'
STOSB
MOV     AL::
STOSB

:..... FILENAME & ':'
:----- MOVE ENTIRE FILENAME
MOV     CX,(SIZE FILE__NAME|
MOV     SI,OFFSET FCBRES.FILE__NAME
REP     MOVSB

:----- REMOVE TRAILING BLANKS
CALL    TRAIL

:----- ':'
MOV     AL::
STOSB
    
```

Now, You Can Buy an IBM-PC™ and OPTOMUX from Opto 22.

(Industrial Control has never been Easier!)



Opto 22, an IBM-PC Value Added Dealer, combines OPTOMUX and the IBM-PC to provide a powerful general purpose industrial control or data acquisition system. Optically isolated analog and digital I/O modules plug into a variety of mounting racks which communicate to the IBM-PC over a simple pair of twisted wires.

Opto 22 provides the software to program the PC in a high level language, commanding OPTOMUX to perform:

- Process Control
- Energy Management
- Machine Control
- Data Acquisition or any combination of analog or digital control.

Our application engineers are ready to answer any questions you may have regarding the use of the IBM-PC and OPTOMUX. Call us at 1-800-854-8851.*

opto 22

15461 Springdale Street ▪ Huntington Beach ▪ California ▪ (714) 891-5861

* In California use our direct line.

statement. This override is necessary because the operand is anonymous. An anonymous reference is composed only of registers and constants. The assembly language would not know the type of this operand without the type override. The assembly language knows which of the three types of return to generate by the type of the procedure.

The main program follows TRAIL. Notice that the ASSUME statement prior to the main code reflects the conditions at the start of execution for an .EXE file. The label IP (instruction pointer) is used on the ENDS statement at the end of the program to indicate where to begin execution. The first statement executed is

```
MOV ES,CONDSEG
```

Because CONDSEG is declared in the CSEG segment, the assembly language knows that this statement requires a segment-prefix override for the code segment. If it were not for the ASSUME statement, the line would have to be coded

```
MOV ES,CS:CONDSEG
```

A more common way of coding this operation is

```
MOV AX,DSEG
MOV ES,AX
```

I prefer my method because no free register is needed. Constants cannot be moved directly into the segment registers because of their location in the BIU.

Note that immediately after this statement there is an ASSUME to inform the assembly language that the extra segment is now associated with the logical segment DSEG.

STRING OPERATIONS

The filenames from the command line are moved from the program-segment prefix into the FCBS in DSEG with the string operation REP MOVSB (move string byte). The source index and destination index point to the source and destination. The REP prefix means that MOVSB will be executed CX register times. Because there is no segment-prefix override, CX register bytes will be moved from DS:SI (data segment:source index) to ES:DI (extra segment:destination index). The count register is set to a constant computed

(continued)

```

:..... EXTENSION & CARRIAGE RETURN & LINE FEED
:----- MOVE ENTIRE FILE EXTENSION
MOV     CX,(SIZE FILE_EXTENSION)
MOV     SI,OFFSET FCBRES.FILE_EXTENSION
REP     MOVSB
:----- REMOVE TRAILING BLANKS
CALL    TRAIL
:----- CARRIAGE RETURN
MOV     AL,00DH
STOSB
:----- LINE FEED
MOV     AL,00AH
STOSB
:..... WRITE OUTPUT RECORD
:----- SET DISK TRANSFER ADDRESS FOR WRITE
MOVE    AH,01AH
MOV     DX,OFFSET OUTLINE
INT     021H
:----- WRITE RECORD
MOV     AH,028H
MOV     CX,DI
SUB     CX,OFFSET OUTLINE
MOV     DX,OFFSET FCBOUR
INT     021H
OR      AL,AL
JZ      WRITTEN
:----- WRITE ERROR
MOV     AH,009H
MOV     DX,OFFSET MSGWRI
INT     021H
JMP     DONE
:----- SUCCESS
WRITTEN LABEL NEAR
:----- SET VARFUN FOR SEARCH CONTINUATION
MOV     VARFUN,012H
JMP     NEXT
:..... SEARCH IS COMPLETE
DONE    LABEL NEAR
:----- CLOSE THE OUTPUT FILE
MOV     AH,010H
MOV     DX,OFFSET FCBOUR
INT     021H
EXIT    LABEL NEAR
:----- JUMP TO DOUBLEWORD CONTENTS TO TERMINATE
JMP     RETURN
CSEG   ENDS
      ENDS IP

```

Table 1: The execution unit's registers and their uses.

Register	Operations
AX	word multiply, word divide, word I/O
AL	byte multiply, byte divide, byte I/O, translate, decimal arithmetic
AH	byte multiply, byte divide
BX	translate
CX	string operations, loops
CL	variable shift and rotate
DX	word multiply, word divide, indirect I/O
SP	stack operations
SI	string operations
DI	string operations



adds **VISION** to your PC

20/20 Vision for \$495.

Quick and versatile, PC-EYE converts your IBM PC or PC/XT into a high-performance image processing system. It improves productivity through better communications. \$495 for PC-EYE will allow you to capture any object that can be viewed with a standard EIA RS-170 compatible video camera. The image can then be displayed, stored, processed, printed, or remotely transmitted. High resolution and real-time display interaction allow simple adjustment of light, focus, or object position for superb quality pictures.

Adds computer picture power for . . .

- Graphic Presentations
- Personal Teleconferencing
- Document/Report Generation
- Surveillance/Security
- Measurement and Inspection
- Thermography

Uses are so varied that Chorus offers software developers the chance to promote their products in our PC-EYE Catalog. Special awards will be given periodically for the software judged most unique or of greatest interest.

Software makes it happen

Utility software is included with menu driven support for various graphics adaptors and printers. This support includes interactive control of image borders, white and black level, and image location within the borders. The user can direct input to

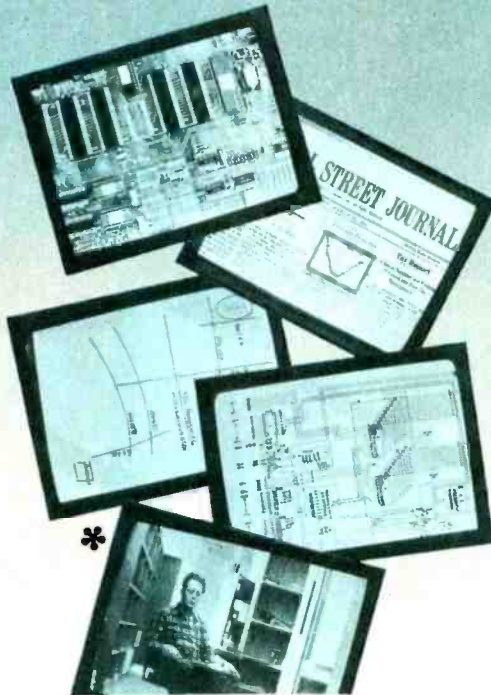

main memory or the graphics adaptor memory; compare images; and store images or set-up parameters on disc.

Software application packages soon to include PC-EYE support are: digital paint and drawing, slide generation, word processing, communications, and data base management.

Compare our specifications:

Input: Any EIA RS-170 (Monochrome or RGB) video source

Spatial Resolution: Up to 640 x 512 pixels

Intensity Range: 2, 4, and 16 levels (or pseudo-colors) standard; 64 levels optional

Capture Speed:

.33 seconds for a 640 x 400 x 16 level image

.1 second for a 320 x 200 x 4 level image

.6 seconds for a 640 x 400 x 64 level image

Input Channels: Four video plus external trigger

I/O Slots: 1 IBM PC or PC/XT compatible

Get started with the CHORUS family of products

We offer a selection of cameras, accessory kits, and compatible graphic adaptors. For our price/catalog and further details, write,

or call 1-800 OCHORUS
or 1-(603) 424-2900



*The B&W pictures are taken with a 35mm SLR camera. The pictures were captured with an RCA TC 1005 video camera on an IBM XT and sent to the monitor with a Tecmar Graphics Master™ graphics adapter in the 640 x 400 x 16 level mode via its composite output.

™Trademark for CHORUS DATA SYSTEMS' family of video capture products.

CHORUS

Chorus Data Systems, Inc., 6 Continental Blvd., P.O. Box 370, Merrimack, New Hampshire 03054



You're traveling through 140° terrain at 300 rpm.

**While some disks lose their way in the torrid zone of drive heat,
Maxell guarantees safe passage.**

A lifetime warranty. And manufacturing standards that make it almost unnecessary.

Consider this: Every time you take your disk for a little spin, you expose it to drive heat that can sidetrack data. Worse, take it to the point of no return. Maxell's Gold Standard jacket construction defies heat of 140°F. And keeps your information on track.

And Maxell runs clean. A unique process impregnates lubricants throughout the oxide layer. Extending media and head life. How good is Gold?

Maxell's the disk that many drive manufacturers trust to put new equipment through its paces. It's that bug-free.

So you can drive a bargain. But in accelerated tests, Maxell was an industry leader in error-free performance and durability. Proving that if you can't stand the heat you don't stand a chance.

maxell®
IT'S WORTH IT.



Maxell Corporation of America, 60 Oxford Drive, Moonachie, N.J. 07074 201-440-8020

Listing 3: An assembly-language routine for searching directories from BASIC.

```

=====STRUCTURES
:-----FILE CONTROL BLOCK
FCB          STRUC
DRIVE_NUMBER DB    ?
FILE_NAME    DB    8 DUP(?)
FILE_EXTENSION DB  3 DUP(?)
CURRENT_BLOCK DW   ?
REC_SIZE     DW   ?
FILE_SIZE_LO DW   ?
FILE_SIZE_HI DW   ?
FILE_DATE    DW   ?
             DB   10 DUP(?)
CURRENT_REC  DB    ?
RANDOM_REC_LO DW   ?
RANDOM_REC_HI DW   ?
FCB          ENDS

=====STRUCTURE FOR SEARCH PARAMETERS
SEARCHP     STRUC
             DW    ?      :BP
             DD    ?      :RETURN ADDRESS
REQUEST     DW    ?
ANSWER      DW    ?
SEARCHP     ENDS

=====CODE SEGMENT
:*****BASIC SEGMENT
BASIC       SEGMENT PARA
            ASSUME  CS:BASIC.DS:BASIC.ES:BASIC.SS:BASIC
:*****CSEG SEGMENT
CSEG        SEGMENT PARA
            ASSUME  CS:SEG
:*****BLOAD HEADER INFORMATION
             DB    0FDH      :BLOAD MARKER
             DW    00000H    :OFFSET
             DW    00000H    :SEGMENT
             DW    FINISH-START :LENGTH
START       EQU    $
:*****EXECUTION ENTRY POINT
             JMP    NEAR PTR SEARCH
:*****DATA
FCBRES      FCB    <>
FCBSEA      FCB    <>
FCBTMP      FCB    <>
VARFUN      DB    ?
:*****CS REGISTER ADJUST PROCEDURE
:-----CORRECTS FOR RELOCATION TO BLOAD OFFSET
:-----USES TWO PUSHES AND A FAR RETURN TO CHANGE CS:IP
ADJUST      PROC    NEAR
:-----USE DUMMY NEAR CALL AND POP TO GET CURRENT OFFSET INTO AX
             CALL  ADJUSTL
ADJUSTL     PROC    NEAR
ADJUSTL     ENDP
             POP   AX
:-----SUBTRACT REAL OFFSET TO DETERMINE BLOAD OFFSET
             SUB   AX,OFFSET ADJUSTL
             MOV   BX,AX
:-----CONVERT TO PARAGRAPHS AND COMPUTED ADJUSTED CS IN CX
             SHR   AX,1
             SHR   AX,1
             SHR   AX,1
             SHR   AX,1
             MOV   CX,CX
             ADD   CX,AX
:-----COMPUTED ADJUSTED RETURN OFFSET IN AX
             POP   AX
             SUB   AX,BX
:-----PUSH NEW CS:OFFSET AND DO FAR RETURN
             PUSH  CX
             PUSH  AX

```

by the assembly language as the sum of the sizes of three fields within FCB. The word "offset" in the assignment of the source index and destination index values tells the assembly language to code the offset of that variable into its segment (rather than the content). After the two filenames are moved, I no longer need a segment register pointing at the program-segment prefix so I set the data segment to point to DSEG and inform the assembly language with an ASSUME.

DOS FUNCTIONS

To reach DOS functions, place a function number in the AH register and do an INT 021H. Additional information is passed in other registers and varies by function. My first DOS function is to create the output file. This is function 016H and requires that the DX register point to the FCB. The AL register contains an error code that will be 0 if the file was created.

If there is an error I use function 009H to print my error message. The DX register points to the string to be printed and must end with a dollar sign. If there is no error I set the value of certain fields not initialized by an open or create. I also set the output record size to 1. The default record size is 128. Note the use of the FCB structure in assigning these values.

The disk-transfer address (DTA) is set by DOS function 01AH with the data register set to its value. The disk-transfer address is where subsequent reads or writes will take place. It is also the address at which directory searches place their result. The DOS function for the initial directory search request is different from the one for the continuation search request. The variable VARFUN has the value 011H the first time through the loop and the value 012H thereafter.

The output line is pieced together from the result of the directory search. The procedure TRAIL is used to eliminate unwanted trailing blanks. The disk transfer address for writing the line is set and the number of bytes in the output line is computed. The line is written using DOS function 028H. For this function the CX register is the number of records and the data register is the file control block. In this case the number of records is the line length

(continued)

Operations Research Software Systems for the IBM-PC

- Large Capacity
- Efficient

Our software systems have the extensive options, large capacities, speed and accuracy required for large-scale commercial applications without sacrificing the user-friendly features that are essential for general-purpose use.

LP88 — Linear Programming.

Solves linear programs with as many as 255 constraints and 2255 variables using the Revised Simplex Algorithm. \$88.00.

BLP88 — Linear Programming with Bounded Variables. Solves linear programs with simple upper and lower bounds without adding such bounds to the constraint set. \$88.00.

DLP88 — Dual Linear Programming. Converts linear programs to dual form and solves the dual problems. \$88.00.

TSA88 — Transportation Simplex Algorithm. Solves transportation problems with up to 510 sources and/or sinks using the Transportation Simplex Algorithm. \$88.00.

MILP88 — Mixed Integer Linear Programming. Solves mixed integer linear programs with as many as 45 integer variables using the "branch and bound" method. \$88.00.

SLP88/STSA88 — Student/Demonstration Systems. Small-scale student versions of LP88 and TSA88 supplied with a license to copy and use on up to 10 PCs. \$88.00.

LPX88/BLPX88/DLPX88 — Product-Form-of-the-Inverse Codes. Product-form-of-the-inverse versions of LP88, BLP88 and DLP88 for use on large problems with sparse arrays. \$88.00.

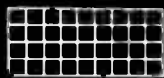

esp
**EASTERN
SOFTWARE
PRODUCTS INC.**

P.O. Box 15328
Alexandria, Va 22309
(703) 360-6942

ASSEMBLY LANGUAGE

```

ADJUSTF  PROC      FAR
          RET

ADJUSTF  ENDP
ADJUST   ENDP
:..... SEARCH
===== SEARCH PROCEDURE
SEARCH   PROC      FAR
:----- GET FRAME POINTER
          PUSH     BP
          MOV      BPSP
:----- SAVE REGISTERS
          PUSHF
          PUSH     AX
          PUSH     BX
          PUSH     CX
          CLD
:----- ADJUST CS
          CALL     ADJUST
:----- SET ES=CS
          PUSH     CS
          POP      ES
          ASSUME   ES:CSEG
:----- PARSE FILENAME INTO TEMPORARY FCB
          MOV      AH,029H
          MOV      AL,000H
          MOV      SI,REQUEST|BP|
          MOV      SI,|SI|||
          MOV      DI,OFFSET FCBTMP
          INT      021H
:----- SET DS=CS
          PUSH     CS
          POP      DS
          ASSUME   DS:CSEG
:----- COMPARE FCBTMP TO BCBSEA
          MOV      CX,(SIZE DRIVE__NUMBER) + (SIZE FILE__NAME) + (SIZE
          FILE__EXTENSION)
          MOV      SI,OFFSET FCBTMP
          MOV      DI,OFFSET FCBSEA
          REP      CMPSB
          JZ       MORE
:----- NEW REQUEST FCB
          MOV      CX,(SIZE DRIVE__NUMBER) + (SIZE FILE__NAME) + (SIZE
          FILE__EXTENSION)
          MOV      SI,OFFSET FCBTMP
          MOV      DI,OFFSET FCBSEA
          REP      MOVSB
          MOV      VARFUN,011H
MORE     LABEL    NEAR
:----- PERFORM SEARCH
          MOV      AH,01AH
          MOV      DX,OFFSET FCBRES
          INT      021H
          MOV      AH,VARFUN
          MOV      DX,OFFSET FCBSEA
          INT      021H
          MOV      VARFUN,012H
:----- TEST FOR SUCCESS
          OR       AL,AL
          JZ       SUCCESS
:----- FAILED BLANK RESULT
          MOV      VARFUN,011H
          MOV      AL,' '
          MOV      CX,(SIZE DRIVE__NUMBER) + (SIZE FILE__NAME) + (SIZE
          FILE__EXTENSION)
          MOV      DI,OFFSET FCBRES
          REP      STOSB
SUCCESS  LABEL    NEAR
:----- RESTORE ES
          PUSH     SS

```

```

POP      ES
ASSUME   ES: BASIC
:----- RESULT FILENAME INTO ANSWERS
MOV      CX, (SIZE DRIVE__NUMBER) + (SIZE FILE__NAME) + (SIZE
          FILE__EXTENSION)
MOV      SI, OFFSET FCBRES
MOV      DI, ANSER|BP|
MOV      DI, ES: |DI| |I|
REP      MOVSB
:----- RESTORE DS
PUSH     SS
POP      DS
ASSUME   DS: BASIC
:----- RESTORE REGISTERS
POP      CX
POP      BX
POP      AX
POPF
:----- RESTORE BP AND RETURN TO BASIC
POP      BP
RET      (SIZE SEARCH-6)
SEARCH   ENDP
:***** BLOAD TRAILER INFORMATION
FINISH   EQU      S
          DB      01AH
CSEG     ENDS
BASIC    ENDS
END
    
```

because the record size is set to 1. The program loops until it can't find any more directory entries. It then closes the output file with DOS function 010H.

Writing an entire program in assembly language is time consuming. Often it is more practical to write the program in BASIC and make assembly-language calls where necessary.

ROUTINE WALKTHROUGH

Listing 3, SEARCH.ASM, shows an assembly language routine for searching directories from BASIC. This procedure uses a relocation technique that is superior to the methods advocated in the IBM BASIC manual. It allows the user to BLOAD the assembly-language routine anywhere in memory. Hard-coded DEFSEG values are not used. The routine is not a POKE into memory from values in a DATA statement. This technique has two components: BLOAD and the ADJUST procedure.

The BLOAD prefix makes the routine look like a BLOAD file to BASIC after it has been converted from an .EXE file to a .COM-style file. This conversion is necessary because .EXE files have relocation information in them, while .COM files are simply memory images.

The ADJUST procedure adjusts the

code segment so that offsets compiled into the routine under the assumption that the code segment points to CSEG are maintained.

SEARCH begins with the FCB definition seen in MAKEBAT. SEARCHP is a structure that represents the layout of the stack after SEARCH has been called and the base pointer has been pushed. The components of SEARCHP will be used to get the parameter addresses off of the stack.

The BASIC segment represents BASIC. During the execution of BASIC, all segment registers point to the program-segment prefix of BASIC. This is reflected in the ASSUME statement.

Because SEARCH.ASM must be converted to a .COM file to be loaded, there can be only one logical segment. SEARCH will be loaded inside of BASIC, so I have nested the CSEG segment within the BASIC segment. The distinction between the BASIC and CSEG segments is important. All offsets assembled into the program will be from the beginning of CSEG. An unknown number of bytes will be between the beginning of the BASIC and CSEG segments at run time.

The first lines in CSEG define the 7 bytes of data that will make SEARCH

The adjusted code segment value is moved to the data segment.

Now all addresses refer to variables in CSEG.

The temporary FCB is compared to the request FCB. If they differ, this is a new request.

look like a BLOAD file to BASIC. A jump to SEARCH follows this prefix. This is done so the offset of the entry point is always known. Because of the one segment restriction, the data definitions also are made in CSEG.

ADJUST recomputes the code segment to adjust for the unknown number of bytes between the BASIC and CSEG segment. Offsets for variables within CSEG will be correct after this adjustment. The ADJUST procedure makes a Near call to a label within itself to get the offset from BASIC to that label. The offset from CSEG to the label is known, so the difference can be computed. This value is used to form a CS:IP (code segment:instruction pointer) for a Far return where the code segment points to CSEG. This procedure is not necessary unless there are references to data within CSEG.

SEARCH

The first two statements executed in the procedure are:

```

PUSH     BP
MOV      BP, SP
    
```

This preserves the BP register and sets what is known as the frame pointer. The frame pointer is used to access the parameter addresses that BASIC pushed onto the stack before calling SEARCH. SEARCH then calls ADJUST. The CLD (clear down) instruction is also issued so that all string operations will proceed from left to right.

The adjusted code segment value is moved to the extra-segment register so

(continued)

Listing 4: SEARCH. BAS.

```

1000 REM RESERVE MEMORY
1010 CLEAR.6H8000
1020 REM LOAD AT PARAGRAPH + 7
1030 SEARCH%=6H8000+7
1040 BLOAD "SEARCH.BLO".SEARCH%
1050 REM REQUEST STRING AND TERMINATOR
1060 REQUESTS="*.ASM"+CHR$(13)
1070 REM RESERVE SPACE FOR ANSWER
1080 ANSWERS=SPACES(12)
1090 REM CALL SEARCH
1100 CALL SEARCH%(ANSWERS.REQUESTS)
1110 REM IF ANSWER IS BLANK THEN DONE
1120 IF ANSWERS=SPACES(12) THEN 1190
1130 REM MAP DRIVE NUMBER FROM 0-3 TO A-D
1140 DRIVES=CHR$(ASCK(LEFT$(ANSWERS,1))+ASC("@"))
1150 FILENAMES=MIDS(ANSWERS,2,8)
1160 EXTENSIONS=MIDS(ANSWERS,10,3)
1170 PRINT DRIVES+" "+FILENAMES+" "+EXTENSIONS
1180 GOTO 1100
1190 END
    
```

The CLEAR statement reserves memory for the assembly-language routine.

ment. The address of the string is used with the DOS parse filename function to create an FCB. No error checking is performed.

The adjusted code segment value is moved to the data segment. Now all addresses refer to variables in CSEG. The temporary FCB is compared to the request FCB. If they differ, this is a new request. If they are the same, this is a continuation request. If the search is unsuccessful, the resulting FCB is blanked.

The original extra segment value is retrieved from the stack so the result can be moved to the answer string in the BASIC segment. Again, no error checking is performed. The answer string must be at least 12 characters long and must not be a literal.

The original data segment value and registers are restored as well as the base pointer. The RETURN statement also pops off the 4 bytes of parameter addresses.

The steps in assembling this routine are

- MASM SEARCH;
- LINK SEARCH;
- EXE2BIN SEARCH SEARCH.BLO

Use of this routine is illustrated in listing 4, SEARCH.BAS. The CLEAR statement is required to reserve memory for the assembly-language routine. The SEARCH routine must be BLOADED 7 bytes beyond a paragraph boundary because of the size of the BLOAD prefix. Notice that the program reserves the string space for ANSWERS by using SPACES(12) instead of a literal. ■

REFERENCES

1. Bradley, David J. *Assembly Language Programming for the IBM Personal Computer*. Englewood Cliffs, New Jersey: Prentice-Hall, 1984.
2. *IBM Technical Reference*. Boca Raton, Florida: IBM Corporation, 1981.
3. *Intel iAPX 86.88 User's Manual*. Santa Clara, California: Intel Corporation, 1981.
4. *Intel MCS-86® Macro Assembly Language Reference Manual*. Santa Clara, California: Intel Corporation, 1979.

that the destination index will point within CSEG. SI will still point within BASIC. SEARCH then takes the address of a 3-byte string descriptor from the

stack using the structure SEARCHP and the frame pointer. The first byte is the length of the string followed by the address of the string within the BASIC seg-

Order your personalized computer paper... NOW!

Printed with your name, business, club, anything. Paper is white, 20# bond. Choice of 5 ink colors. Fits all printers using 9½ × 11 continuous paper (8½ × 11 when detached). Limited offer of low prices, and special offer.

Satisfaction Guaranteed—
full refund if not satisfied by returning unused paper.

Special Offer
Order now and we'll send free samples of other computer paper specialties with your order.

Name _____
 Street _____
 City _____ State _____ Zip _____

Personalize as follows: Leave space between words.

(For more than one order use separate sheet for 30 character personalization)

Check ink color: Red Blue Gray Brown Canary Green

SHIPPING CHARGES: If Order is: Shipping Charge is:
 under \$50.00 \$6.00
 \$50.01 to \$80.00 \$8.00
 over \$80.00 \$9.00

500 sheets at \$19.95 \$ _____ Enclose check or money order. No COD'S. Texas residents add 5½% sales tax. VISA and MasterCard accepted. Send number, signature, and expiration date. Allow three weeks for delivery.

1000 sheets at \$29.95 \$ _____
 2000 sheets at \$43.95 \$ _____
 Shipping, handling \$ _____
 Total order \$ _____
 Mail order to: **Personalized Computer Paper/Dep't. B**
 P. O. Box 39716/San Antonio, Texas 78218/
 512-822-8712

BMDPC STATISTICAL SOFTWARE

CONFIDENCE AND CONVENIENCE



BMDP® is Data Analysis with Confidence. Researchers and statisticians know quality research demands quality analysis. That's why they rely on BMDP Statistical Software for all their data analysis needs.

BMDP is a comprehensive library of dependable statistical programs. You can use BMDP to perform many types of analysis. Capabilities of BMDP range from simple data display and description to the most advanced statistical techniques. In fact, BMDP provides the widest range of statistical approaches required to effectively analyze your research data:

- **Data Description**
- **Data in Groups**
- **Plots and Histograms**
- **Frequency Tables**
- **Missing Values**
- **Nonlinear Regression**
- **Analysis of Variance and Covariance**
- **Regression**
- **Multivariate Analysis**
- **Nonparametric Analysis**
- **Cluster Analysis**
- **Survival Analysis**
- **Time Series**

Powerful statistical and computing procedures make BMDP especially

appealing to the experienced data analyst. However, you need not be a seasoned statistician or computer expert to perform data analysis with confidence. English-based instructions make BMDP easy to learn and easy to use.

As the acknowledged leader in statistical methodology, BMDP has become the standard by which others measure their performance. The BMDP programs are known for superior technology and state-of-the-art methodology. BMDP is committed to developing new statistical methods for data analysis, and continues to lead the way in providing superior statistical software.



BMDP is Data Analysis with Convenience. With our latest advance, you can even perform complex statistical analyses without a large computer. BMDPC offers you both the confidence of BMDP and the convenience of using your own PC.

The same programs that have been trusted for more than 20 years by researchers worldwide are now available for the IBM Personal Computer and compatibles.

Best of all, the BMDPC programs are available in low-cost subsets. So, you can pick and choose programs for your PC. Pick the types of analyses you use most, and choose from our broad selection of statistical programs.

Put the statistical software of choice on your IBM®PC*, so you can perform data analysis with confidence and convenience.

Hardware Requirements

Minimum requirements for running BMDP on the PC include the following:

- a 5 megabyte hard disk
- the capacity for double-sided, double density floppy diskettes
- an 8087 floating point processor
- a PC/DOS 2.0 or later operating system
- 640 kilobytes of memory.

FOR MORE INFORMATION WRITE OR CALL

BMDP Statistical Software
1964 Westwood Blvd., Suite 202
Los Angeles, California 90025
Phone (213) 475-5700

Compared To FRIENDLY WRITER™ FRIENDLY SPELLER™ A Pencil Is Tough To Operate.

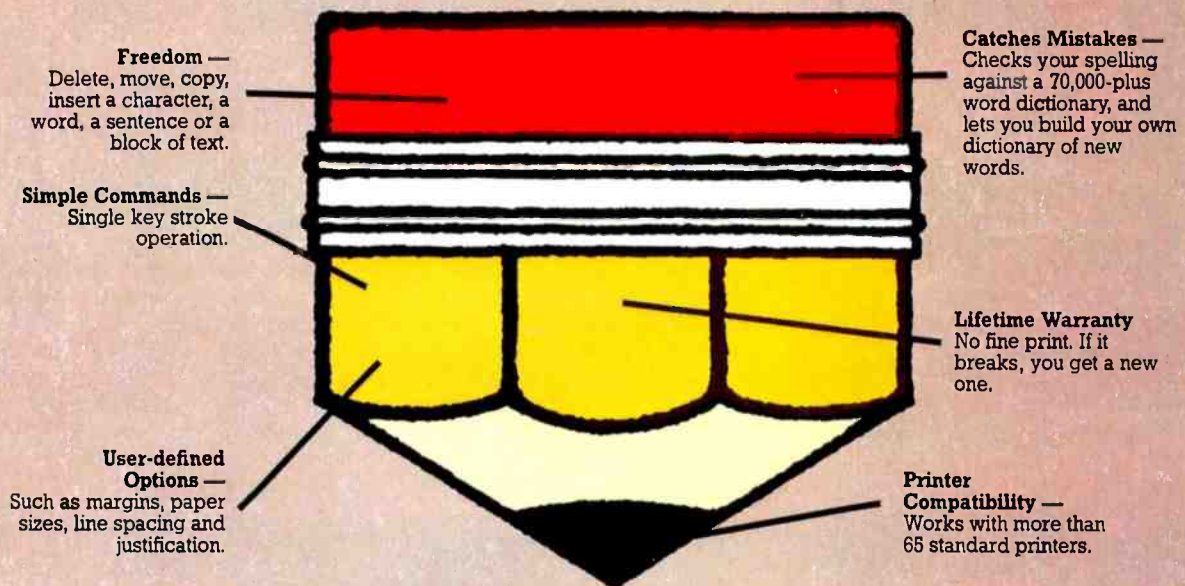

FriendlyWriter™/
FriendlySpeller™, the
word processor and
spelling-checker from
FriendlySoft is so easy to
use it makes writing with
a pencil seem difficult.

In about 10 minutes on
your IBM® PC, XT or PC
Jr, you can learn to write
rings around your pencil.
And you can check the
spelling of more than
70,000 words in another
few seconds.

FriendlyWriter/
FriendlySpeller is the
perfect word processing
package for home and
office. Visit a computer or
software dealer near you
and ask for a demonstra-
tion. If your dealer is not
stocking it, let us know.

FRIENDLY WRITER/FRIENDLY SPELLER

Only \$89.95

Suggested Retail Price

FRIENDLYSOFT, INC.

3638 WEST PIONEER PARKWAY, ARLINGTON, TEXAS 76013
(817) 277-9378

Price subject to change without notice.

FriendlyWriter/FriendlySpeller are trademarks
of FriendlySoft, Inc.

IBM is a registered trademark of International
Business Machines.

© COPYRIGHT FRIENDLYSOFT, INC. 1984

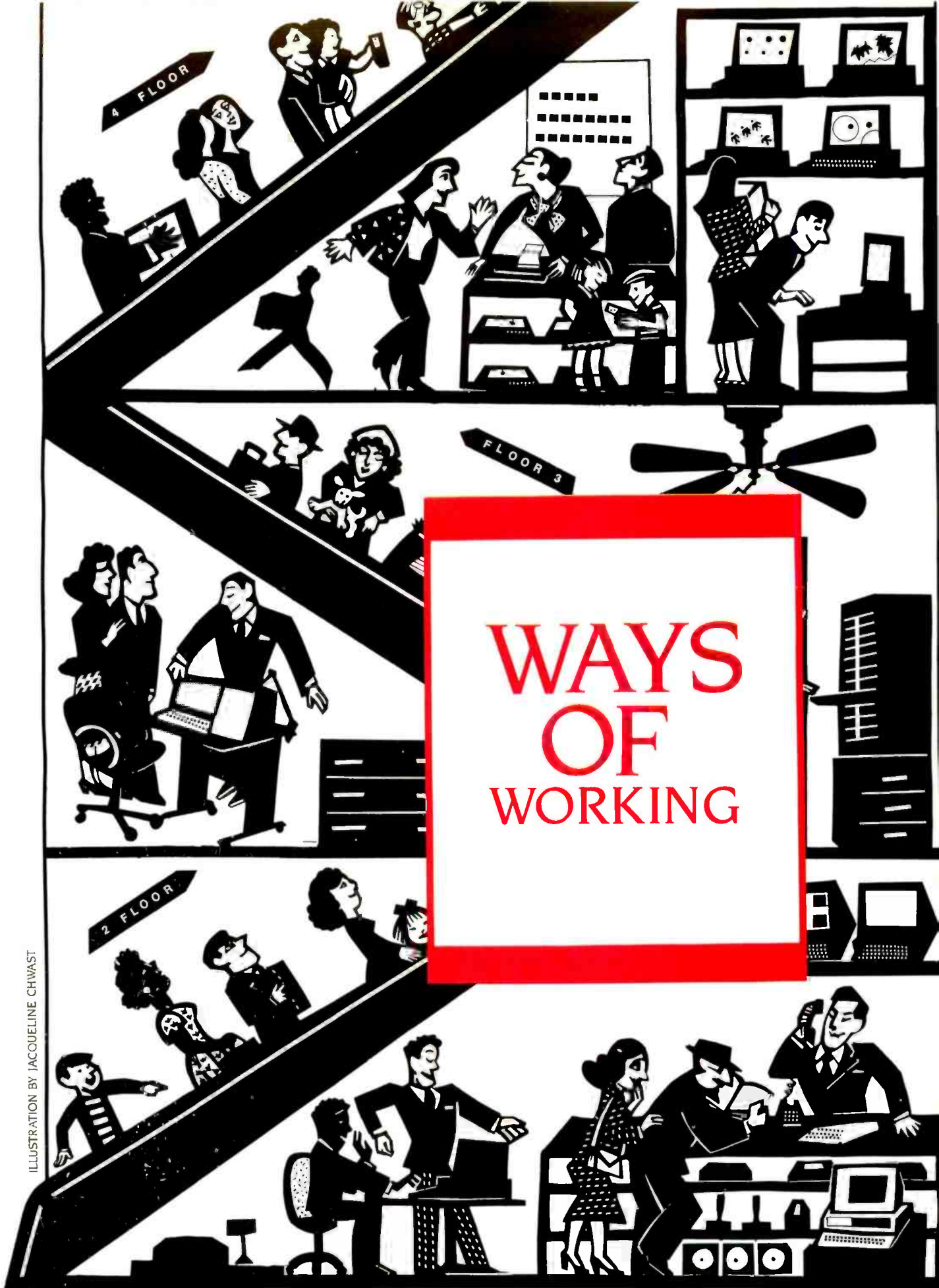

ILLUSTRATION BY JACQUELINE CHWAST

WAYS OF WORKING



LYNX by Honeywell the **Unmouse**™

The next time you get the chance, make a side-by-side comparison between an ordinary mouse and the LYNX desktop Trackball. You'll see why we call the LYNX the Unmouse.

We developed the LYNX to be the ultimate cursor control device. Engineered for comfortable operation, fast data output, and total reliability, the LYNX makes the mouse obsolete.

It's attractive, ergonomic housing gives you a comfortable palm rest, three user defined control buttons, and a simple fingertip roll-control for effortless cursor positioning. And the LYNX helps cut back on desk-top clutter with its tiny space-saving size. It fits on the busiest desk-top. Or it can be hand-held and even keyboard and panel mounted for total out-of-the-way convenience.

When it comes to data output speed, the LYNX runs circles around those other devices. Just set the DIP switches for the speed you need, all the way up to 19,200 baud.

And your LYNX is built to last. With its non-contacting optical encoding technology, LYNX withstands over 10,000,000 X or Y axis ball revolutions.

Choose the LYNX that's best for your needs. The standard model works off your computer's RS-232 port, and is an OEM's dream come true. The Smart LYNX

connects between the computer and keyboard, on the IBM®-PC and compatibles, which frees up your RS-232 port for other purposes. And because it requires no software support, the Smart LYNX can be used with any existing software. The Smart LYNX is user programmable from the keyboard.

The user-friendly LYNX is the perfect cursor control device for business and personal computers, CAD/CAM and graphics terminal users.



Find out how much the LYNX can do for your system. OEM's, retail stocking distributors and chain store operations, call or write today for more information.

Disc Instruments A **Honeywell** SUBSIDIARY
102 East Baker Street, Costa Mesa, California 92626
(714)979-5300 TWX(910)595-1987 Disc CSMA
IBM is a registered trademark of International Business Machines Corporation.



TECHNICAL AND BUSINESS GRAPHICS ON THE IBM PC

*A quick look at some spreadsheets
and graphics packages in a crowded field*

BY JACK BISHOP

Charts have always been powerful tools for analyzing and selling products. But today's microcomputer graphics programs can make visual aids even more appealing, since they are easy to develop. The popularity of the IBM PC, PC XT, and clones has resulted in the development of even more powerful charting programs for technical and business analysts.

Many spreadsheet programs include graphics routines. Whether you use a spreadsheet for engineering a circuit design or a corporate takeover, you might need the power of a separate charting program. A separate program gives you more flexibility and power, and it often adds fine touches that characterize a professional piece of work. These advantages are often offset by the ease of use of the graphics tied to a spreadsheet package. I would be surprised if any specialized charting pack-

age was able to handle all your charting needs, and you might find that buying more than one is not a luxury.

It is hard to tell which charting package is right for you, since no one package seems to meet a wide variety of needs. Here are six of what I consider to be the better packages: SuperCalc3, Lotus 1-2-3, GrafTalk, Business Graphics System, DR Graph, and ChartMaster.

To evaluate these programs, I used an IBM PC with 256K bytes and an 8087 chip. This configuration includes a 15-megabyte Falcon hard disk, a Color-Plus graphics card, an Epson MX-80 with Graftrax, and a Sakata 200 monitor. I also used the Hewlett-Packard HP 7470A and Enter Computer Sweet-P plotters.

(continued)

Jack Bishop is a management consultant. He can be reached at Box 311, Evanston, IL 60204.

AT A GLANCE

Name
SuperCalc3

Type
Spreadsheet: menu (of sorts)

Manufacturer
Sorcim
2310 Lundy Ave.
San Jose, CA 95131

Price
\$395

Hardware required
IBM PC, IBM PC XT, or clones (Compaq, Eagle PC or 1600, Hyperion, Columbia); two double-sided floppy disks or one double-sided floppy disk and a hard disk; IBM or compatible color/graphics board (optional); IBM graphics dot-matrix printer; Epson MX-80/100 with Graftrax; FX-80/100; RX-80; HP plotters (including 7470A, 7475A); IBM XY/749 plotter; CalComp M84 plotter

Software required
PC-DOS 1.1 or 2.0

Documentation
About 300 pages, spiral bound, with handy bookmark

Audience
Technical and business professionals who need spreadsheet power with extensive charting

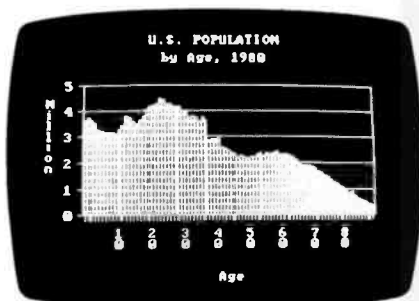

Photo 1: SuperCalc3 screen image of a multiyear bar chart. The screen display gives no hint of the excellent quality of the printed chart.

SUPERCALC3

SuperCalc3 began, without the trailing digit, many moons ago, when the world was either Apple or CP/M. Sorcim was one of the first companies to add really impressive features to a microcomputer spreadsheet. On-board HELP commands and extensive formatting of entries (including variable column widths, the dollar sign, commas, debit/credit/parentheses, and percents) contribute to the improved readability and professional character of the SuperCalc3 report.

The graphics capability was another welcome addition. SuperCalc3 sports all the basic charting routines (line, bar, pie) and a few specialty (high-low and area) charts. It is a single, self-contained product. You never have to leave SuperCalc3 to calculate, view, or print/plot the results.

SuperCalc3 uses a VIEW command to control six different charts for each spreadsheet. This capability is a real sleeper, since keeping track of charts and their source is a potential source of frustration and error. Because one chart can rarely cover all the analysis you need, this capability is even more valuable.

A chart that contains a lot of data allows a spreadsheet to shine. Developing a simple bar chart of the population age distribution is a simple, but surprisingly challenging, test for many products. The data entry and analysis is the sort of thing a spreadsheet cuts its teeth on. For data entry, you can set up SuperCalc3 to move from one cell to the next automatically. I wish more programs had that flexibility.

The VIEW command takes the data cell identities and other basics to develop each chart. I was surprised to find that titles for the charts must be kept in cells in the spreadsheet. I am still not too wild about cluttering up the spreadsheet with a series of extra titles designed for the charts. However, this is a minor inconvenience.

SuperCalc3's on-screen graphics are quite crude and have a decidedly "second-generation" quality. The letters are blocky, and the space devoted to the chart is limited. SuperCalc3 provides a clean, undistinguished chart on the screen, but it is nothing to brag about.

Lurking behind this plain facade of on-

screen graphics is a much more elegant SuperCalc3. The first indication of this beauty is its ability to select from eight type styles (fonts). The final plotted chart (figure 1) was a pleasant surprise.

This chart is a class act. It illustrates the two levels of titling, automatic legends, a variety of axis scaling, and the other basics. On the chart's field, SuperCalc3 will chart only the symbols or annotate data points with data values, to provide the small touches that help ensure that the message of the chart gets through. Upon close inspection, the chart is even more impressive. SuperCalc3 does not run the grid lines through the bars; it uses only the blank space between them. This rare feature makes for a particularly clean chart when you are using only a few bars.

Figure 2 is a simple two-line chart, but it illustrates SuperCalc3's power to perform a series of calculations, then chart the results without ever leaving the program. Its ability to space legends along the horizontal axes can be very useful in highlighting specific events, such as mergers or election years.

All in all, SuperCalc3's graphics are surprising. Its operation is essentially flawless, and it is easy to use in producing charts. For many technical and business uses, SuperCalc3 might be the only charting package you'll need.

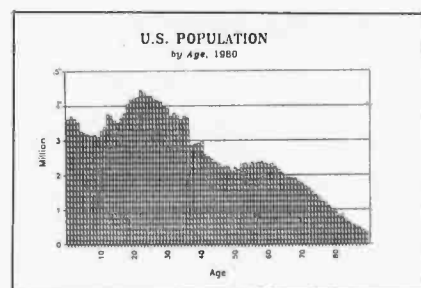

Figure 1: SuperCalc3 charts U.S. population.

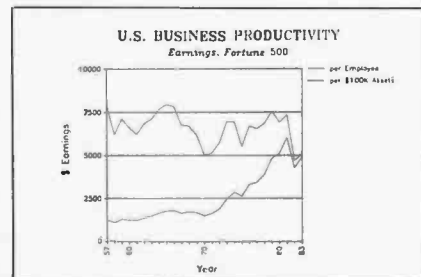

Figure 2: A SuperCalc3 two-line chart.

LOTUS 1-2-3

In a short period of time, Lotus 1-2-3 has captured the pocketbooks—and maybe even the hearts—of many microcomputer owners. Popularized by VisiCalc on the Apple, Lotus 1-2-3 brought the spreadsheet to the IBM PC market with some fine touches, such as its use of color, function keys, and its report-printing capability. The ability to have the spreadsheet integrated with graphics is a strong selling point for the spreadsheet itself.

The Lotus graphics offer multiple fonts for titling and a variety of chart types. The program is comparatively easy to use. However, you must leave Lotus 1-2-3 behind when you enter the print routines, which is somewhat bothersome. Some users will find the separate print routine an advantage, and most will probably not mind switching back and forth, but I like to have a hard copy of the chart in front of me while I continue to develop an analysis.

Lotus 1-2-3 handles a variety of charts, including line, bar, pie, and XY, with up to six data series on a single chart (generally more than anyone with good sense will use). The program shines when graphing a large amount of data developed from the spreadsheet. It does a superb job of developing and

charting Fortune 500 productivity.

Automatic placement of legends and sizing of titles makes Lotus 1-2-3 even easier to use. The ability to combine symbols with lines can be a substantial advantage for complex charts. While you can use only two fonts on any one chart, this is a modest limitation. Using more than two fonts (or more than four colors) on one chart usually is more for the fun of the creator than for clarity.

The pie chart (figure 4) lacks the ability to emphasize one segment of the pie. Similarly, the ability to distinguish between the segments of the chart is missing. The result is a basic chart with few frills. Including the percentages for each segment is, however, a nice touch. The ability to annotate your chart with the actual data values, plotted in a Lotus line or bar chart is also useful.

Lotus 1-2-3 performs best when you are developing a number of charts for later printing. The quality is excellent, and the range of capabilities is more than enough for most technical uses.

GRAFTALK

The operation of GrafTalk begins in a low-key way. The simple white text on a black background obviously was designed to appeal to engineers. This is a far cry, however, from the special charts you can develop with this package. I first saw GrafTalk on a Sony and fell in love with its crisp picture. With the addition of new menus, GrafTalk offers an easy-to-use package with extensive charting power.

The menus are an ideal way for us to develop a chart quickly. GrafTalk's menus are a mixed bag, both to me and (I guess) to the developers at the Redding Group. From my standpoint, the person the menus are designed to help (the client in a hurry) is most put off by having to remember a graphics language command (STATUS MENU) to get to the menus. Although it is simple, it is not English. The reason I think the developers have some reservations about menus is their suggestion in the manual that the full features of GrafTalk are not accessible from the menu. In addition, minor glitches in the release version of GrafTalk that I use appear in the menu section. GrafTalk can die in the middle of a chart for no apparent reason.

(continued)

AT A GLANCE

Name

Lotus 1-2-3

Type

Spreadsheet; menu (of sorts)

Manufacturer

Lotus Development Corp.
161 First St.
Cambridge, MA 02142

Price

\$495

Hardware required

IBM PC or IBM PC XT; IBM monochrome or color setup; Hercules or other graphics card; IBM printer

Software required

DOS 1.1 or 2.0

Audience

Technical and business professionals who need the power of a spreadsheet with sophisticated charting

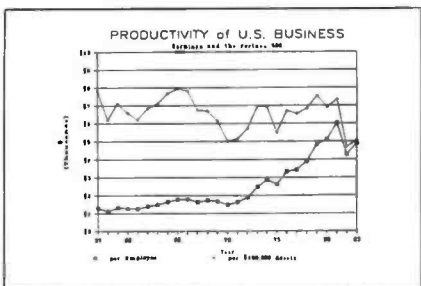

Figure 3: Lotus mixes symbols and lines.

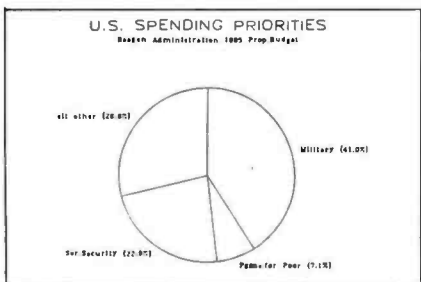

Figure 4: A Lotus pie-chart.

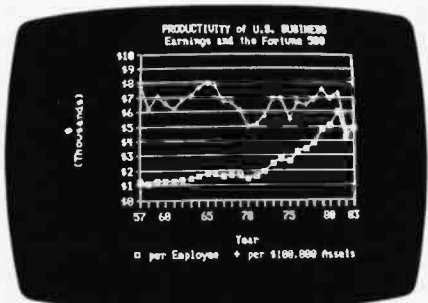

Photo 2: You could use a 35mm picture of the screen version of this productivity chart from Lotus 1-2-3 for a formal presentation.



Photo 3: Population distribution as a pie chart is simple and utilitarian with Lotus 1-2-3.

AT A GLANCE

Name

GrafTalk

Type

Graphics: menu and/or language

Manufacturer

Redding Group
609 Main St.
Ridgefield, CT 06877

Price

\$450

Hardware required

IBM PC, IBM PC XT, or any of the following: Compaq, Cannon As-100, Sord 23, Zenith Z-100, SONY SMC-70, DEC Rainbow, Epson QX-10, NEC PC-8801A, North Star Advantage, Otrona Attache, Sanyo MBC-1250, Sord M23, or Televideo 803

Software required

CP/M and MP/M: PC-DOS; other systems as standard above

Documentation

About 200 pages

Audience

Technical and business professionals who want a package moving toward the best of both worlds, menu and language

While the menus are nicely done in general, some rather gaping holes might trap the unwary. You cannot save the chart developed in a menu, nor can you save the commands. As a result, you do not have the use of the menu chart to steady you while you are learning the language. I did find a way to save the data entered from the menu (exit from the menu into the command language, save the data, then jump back into the menu), but all this foolishness is better left to the developers. GrafTalk does not yet support either a log axis or multiple fonts, both of which I was looking forward to seeing along with the new menus.

All these reservations aside, GrafTalk does a decent job with the productivity chart (figure 5). This chart, typical of a GrafTalk product, is clean and utilitarian. You can change both the height and width of the single font in the command language, but in the menu operation you can only rescale each type of character. I have yet to run into a limit on the number of data points, and a colleague regularly uses GrafTalk to chart a year of daily securities prices.

The power of the GrafTalk command language is revealed when the specialty chart arrives on the scene. Intel's sales for 10 years make a pedestrian bar chart—until a pie chart is dropped in the

middle of it to show the distribution of the sales dollar last year (figure 6). You can use the annotation capability to place a small label on the emphasized segment that represents research-and-development spending.

GrafTalk performs at its best for someone who wants to develop a special chart that combines many elements in unique and esoteric ways. While GrafTalk develops the run-of-the-mill chart with few hassles, I find it most useful for really special occasions.

BUSINESS GRAPHICS SYSTEM

Peachtree provides a series of products that are integrated to the extent that they can generate and read files created by each other. Each module is available on a stand-alone basis, and I evaluated the graphics program from this perspective. PeachGraph provides extensive menu operation and a few options that are definitely slanted toward the financial audience. PeachGraph is one of those unique packages whose limitations are balanced by the easy ability to develop charts that are difficult or impossible for its competitors.

The operation of the Business Graphics System is idiosyncratic. The process begins with the development of a LABEL file, which defines the parameters of the chart. You then go back to a main menu, then to a data file to add the data, back to the main menu, then to a display menu to show the chart. Bouncing from one menu to another can be reduced, but not by much, since you must type the name and type of file each time.

Getting beyond this maze, a single screen holds all the options. The operation within the menu takes some getting used to, as a return takes you out of the screen. (The cursor arrows are used to move around the menu, with the Delete key required to erase a command, rather than the more common Backspace key or AUTOERASE command.)

A major limitation in the Business Graphics System is found in the number of data points. With a maximum of 32 data points per series, the business user may feel cramped.

The pie chart (figure 7) approaches the subject uniquely. The legend is split to run down the right and left margins. This leaves the bottom of the chart free

(continued)

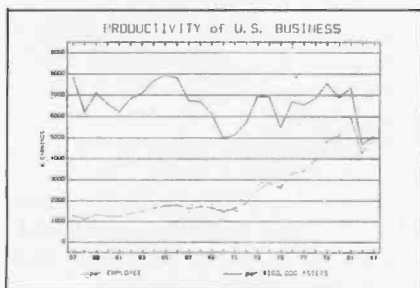

Figure 5: GrafTalk develops a clean and forceful chart from its new menu.

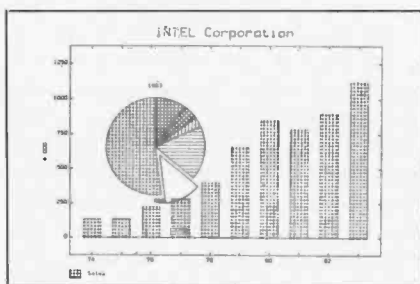

Figure 6: GrafTalk bar chart with pie chart.

THE CHOICE IS YOURS NOT OURS.



HR-25 at 23cps or HR-35 at 36cps ?

Twenty-Three or Thirty-Six? It's up to you! Whether you choose the HR-35 at 36 cps and priced at only **\$1245***, or the HR-25 at 23 cps costing less, you're getting the best price/performance ratio of any printers in their class on the market today.

And whether you're high or low volume, there's an HR to meet your needs.

Such features as the "no mess" daisy wheel, encased in clear plastic, enables print change in seconds.



Optional Tractor **\$149***

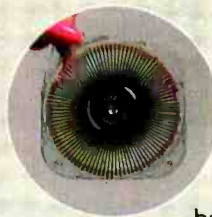

And, we offer ribbons in a variety of colors for those special printing applications. Add the optional Tractor and Cut Sheet Feeder and you have a package at a price that's unbeatable.

Best of all, they're backed by the Dynax reputation for quality and service response.

The Choice is Yours!

Optional Cut Sheet Feeder **\$269***



Manufactured by **brother**

Dynax, Inc.™



DYNAX, INC. OFFICES

*Suggested Retail Price

■ **HEADQUARTERS** 6070 Rickenbacker Rd., City of Commerce, CA 90040 • (213) 727-1227
 ■ **NEW JERSEY** One Madison St., East Rutherford, NJ 07073 • (201) 471-0100
 ■ **TEXAS** 6012 Campus Circle, Suite 250, Irving, TX 75062 • (214) 257-1700

■ **ILLINOIS** 543 W. Algonquin Rd., Arlington Heights, IL 60005 • (312) 981-5633
 ■ **MASSACHUSETTS** 400 W. Cummings Park, Suite 5300, Woburn, MA 01801 • (617) 933-8162
 ■ **N. CALIFORNIA** 1255 Oakmead Parkway, Sunhyvale, CA 94086 • (408) 730-1712

IBM SPECIALS

COMPUTERS

IBM PC-25K 2 Half HI Drives,
Controller, Color or Mono Card &
Parallel Interface 2259
IBM 128K XT 3995
TAVA IBM-Like 128K 2 Drives,
Monitor, Software CALL
Sanyo MBC 555-2 2 Drives... 1395

DISKETTES

Maxell 5 1/4" DSDD MD2 Box 10 ... 33

PRINTERS

Brother HR-15 15 cps 419
HR-25 25 cps 695
HR-35 35 cps 995
M-1009 CALL
2024L CALL
Epson FX 80 160 cps 459
FX 10C 160 cps 679
RX-80FT 120 cps 389
Okidata 92P 180 cps 439
93P 180 cps 749
NEC 3550 40 cps 1695
Star Micronics G10X 120 cps... 259
G15X 120 cps... 369
Delta 10 160 cps... 495
Radix 10 200 cps... 795
Powrtype 18 cps... 439
Silver Reed 550 495
HP Thinkjet 449

MONITORS

Amdex 310A 169
300G or A 145
IBM HI Res Green 239
Sakata SC100 259
Taxan 122 Mono Amber 159
Zenith 123 12" Green 95
122 12" Amber 95
135 13" Color 459

MODEMS

Hayes 1200 469
1200B 389
Anchor Mark XII 300/1200 269
Pro Modem 1200 349
Novation Smart Cat Plus 429
ASCII Pro Software IBM 139

DRIVES

CDC 9409-1800 215
Tandem TM 100-2 199
Teac 55B 159
Panasonic 154
Mitsubishi 10 Meg 995

ADD-ON

AST 6 Pac 269
Mega Plus 269
STB RIO+ 259
Super RIO 269
Graphix Plus 2 309
64K Memory Set 9 45
Titan PC Accelerator CALL

SOFTWARE ETC.

Ashton dBase III 429
Friday 189
Crosstalk XVI 149
Harvard Project Manager 269
Lotus 1-2-3 289
Upgrade 139
Symphony 489
Microsoft Multiplan 1.1 139
Mouse 139
Word with Mouse 258
Project 229
Micro Pro Wordstar 269
Pro Pak 369
Infostar + 289
Multimate 319
rbase 4000 289
Source Subscription 59
Volkswriter 114

COMPUTER PRICE CLUB

16783 Beach Blvd.
Huntington Beach, CA 92647
NO CLUB FEE



714-841-6160



PRICE & AVAILABILITY SUBJECT TO CHANGE

GRAPHICS PACKAGES

AT A GLANCE

Name

Business Graphics System

Type

Graphics; menu

Manufacturer

Peachtree Software Inc.
3445 Peachtree Rd. N.E., 8th Floor
Atlanta, GA 30326

Price

\$295 (PC-DOS)
\$125 (Osborne)

Hardware required

IBM PC or IBM PC XT, Osborne 1,
Zenith Z-100, or Epson QX-10; Epson
MX-80 printer; Hewlett-Packard plotters
(7470, 7220); Strobe s-100 plotter;
Houston Instrument (3.4.6.7.29)

Software required

MS-DOS or CP/M

Documentation

162 pages

Audience

Business professionals, particularly
financial



Photo 4: Ratio analysis is clearer on the plotter version than on this screen version of Peachtree's Business Graphics System. Both charts suffer from trying to put too much on one frame.

for a secondary title. You can also select the height and weight of the titling easily and give the characters some slant as well. (A slant to the title should not convey the impression that the figures are not level.) In addition, the placement of the legend provides enough room to include the amount and percentage, along with the identification of each segment.

The Business Graphics System clustered bar chart is distinguished by a three-dimensional effect. Again, the menu allows easy specification of the horizontal and vertical viewing angles. The result is a chart that is unusual and easy to read (figure 8).

The most intriguing chart is the CRITICAL RATIO chart. With this, you can create up to three sets of comparisons on one chart and specify the elements of each ratio. Business Graphics System takes the numerator

(continued)

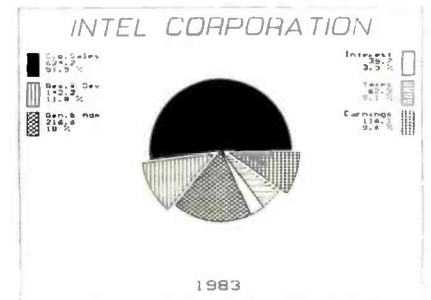

Figure 7: The Business Graphics System pie chart carries a lot of information in the labels.

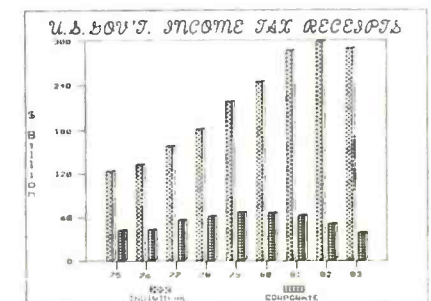

Figure 8: Three-dimensional bars add to a Peachtree chart's impact, while the script title is "a bit much" for most charts.

Thoughtware.

A New And Unique Series Of Personal Computer-Based Management Training Programs.

Management Diagnostic Series (\$350 each)

- 1.1 Assessing Personal Management Skills
- 1.2 Evaluating Organizational Effectiveness
- 1.3 Understanding Personal Interaction Styles

Management Training Series (\$450 each)

- 2.1 Leading Effectively
- 2.2 Motivating To Achieve Results
- 2.3 Defining Goals And Objectives
- 2.4 Improving Employee Performance
- 2.5 Performance Appraisal
- 2.6 Managing Time Effectively
- 2.7 Conducting Successful Meetings



Thoughtware Is The Future.

It's a new way to learn, a logical and innovative approach to management training. It will revolutionize management training now, and in the future.

Thoughtware utilizes the latest research in management development from leaders in the field, and has been tested nationally. The benefits of Thoughtware's computer-based Learning Programs are enormous.

Educationally, Thoughtware is self-paced and continuously interactive. Real situations are simulated. The animation and color graphics motivate and hold your interest. Skills are practiced until they're mastered. There's consistent quality of instruction

and increased training effectiveness. And even the capability to test yourself.

Economically, Thoughtware reduces training time and cuts the cost of training dramatically. And the more it is used by you and those who work with you, the more cost-effective it becomes. It also eliminates travel, living and instructor costs.

Operationally, training fits the schedule of the student, not the trainer, thus facilitating increased usage. There's minimal job interruption as training can take place on or off site, during or after regular hours.

®Thoughtware is a registered trademark of the Institute for Management Improvement.

Become a better manager by visiting your local IBM Product Center, computer dealer, or call toll-free 1-800-THT-WARE for the dealer nearest you.

Or write: Thoughtware Inc.
Suite S, 2699 So. Bayshore Dr.
Coconut Grove, Florida 33133.

Thoughtware Programs run on the following:
IBM® PC and compatibles with color graphics card.
Apple® II Plus and IIe.



Thoughtware

Expanding The Universe Of Learning.

Let the *ANGEL* do the waiting

It has been said that 30% of micro-computer users will eventually purchase a buffer. For business users, a buffer pays for itself in the time and money it saves the user not waiting for the print-out. The more you use your printer the more you need a buffer.

JAMMED PAGE RE-PRINTS



EASILY ACCESSIBLE SWITCHES



ANGEL is designed for all types of users - even those without technical background. All switches, including baud rate selection and parallel / serial configurations are externally accessible. Installation is a matter of connecting cables, setting up DIP switches and power on. Ligo Research makes available standard cables/adaptors for most popular computer/printers. Connection diagrams are also provided for users who want to make their own cables.

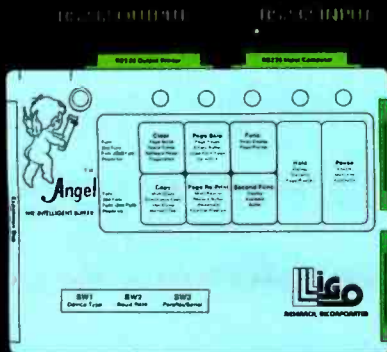

ANGEL HAS ALL INTELLIGENCES

ANGEL, The Intelligent Buffer is the perfect mate for your system. It has both RS232 Serial and Centronics Parallel interface, and can convert from serial to parallel and parallel to serial. It is truly a universal buffer that is compatible with most microcomputer systems. This versatility means when you upgrade your system you can use the same ANGEL.

ANGEL passes data to the printer exactly as received from the computer and is independent of software - including graphics. The ANGEL also features an innovative page mode which carefully monitors the page break data during printing. Under the page mode you can reprint the last page, jammed pages, do page skip as well as page pause for single-sheet feeding.

ANGEL is an intelligent buffer with 12 additional functions that may be activated when you need them; pause, hold, copy, clear, self-test, page reprint, page skip, page pause, multi-copy, continuous copy, space compression, hex dump, etc.

ANGEL comes with 64K bytes of memory, ample for most applications. Additionally, you may activate the space compression mode which in many cases extends the buffer capacity to more than 128K.



With such a good product available now, why wait for your printer to catch up? You can order the ANGEL from your dealer or call direct to 1-800-323-3304, TODAY!



396 E. 159th St., Harvey, IL 60426 • 1-800-323-3304, 1-312-331-8797 • Telex: 910 257-0850 LIGORSCH, HARV
 In Canada: Computer Age, Ltd., P.O. Box 730, Nobleton, Ontario, LOG 1N0 • 1-416-859-0370



Circle 100 on inquiry card.

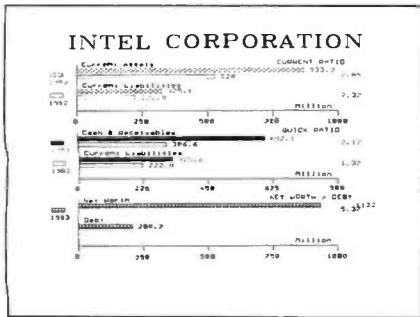

Figure 9: The Business Graphics System ratio chart offers a unique way to present key business ratios.

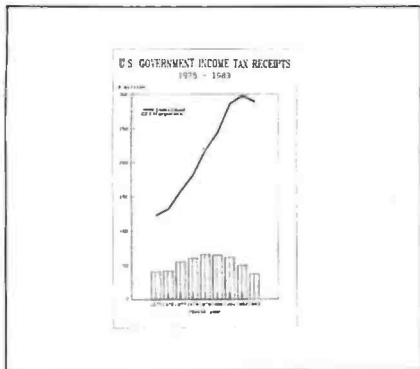

Figure 10: DR Graph combines the ability to vary the width of the line to enhance the concept of a combined line and bar chart.

and denominator to construct each chart, calculating the ratio and writing it in the margin. I can just see some of my accountant friends ripping up their green eyeshades in exaltation over this chart (figure 9). It is a clever, effective way to show a few key financial ratios.

In sum, PeachGraph shines in the development of specialized financial charts. Each chart provides a good, clean development of the subject. You can also develop charts with only text with the Business Graphics System. On the negative side, the few data points are a serious limitation on the usefulness of the system. I found Peachtree's menus more difficult to use than others, and their on-screen graphics are of limited use.

DR GRAPH

DR Graph provides an extensive varie-

ty of charting programs from a series of menus. Two of the biggest limitations for the technical user are its inability to handle more than 75 observations and its limited capability for specifying text as one of the variables to be plotted.

While I found the menus easy to use, data entry is a pain in the lower back. You enter the data one screen at a time, and you never know when you are reaching the end of the screen while you are looking at the data. It is easy to become engrossed in entering the data accurately, while DR Graph takes you to the top of the screen without warning and (I suspect gleefully) conspires to make you write over the data already entered.

On the other hand, the ability to set a number of annotations anywhere on the finished chart with one of several fonts represents one of the more interesting features of DR Graph. The program simplifies the selection of text sizes by allowing only four (designated 1, 2, 3, and 4). I found this a minor inconvenience since I really wanted to use a 2.5 size.

The menus give you substantial control over the chart's character, from font changes to a mixture of chart types. The charts DR Graph produces are clean and well laid out. With DR Graph, you can also combine line and bar charts. Few packages can do the same. Its ability to set the size of the line (including the width of the framing lines) is unique (figure 10). In a normal chart, the line would be lost in the chart, but DR Graph accommodates a variety of line widths to avoid such a problem.

A minor inconvenience occurred between the screen image and the plotted version of the chart. While all the labels of my pie chart fit well on the screen, the plotted version (figure 11) cropped a letter off each side. Similarly, the annotation ("Future Investment") did not overrun the segment in the screen version.

DR Graph presents a real anomaly. The charts are fine and the development is fairly easy, but the limited data capacity stops my evaluation short of a rave review. DR Graph is a solid package within its data and text limitations.

CHARTMASTER

ChartMaster does many things very (continued)

AT A GLANCE

Name
DR Graph

Type
Graphics; menu

Manufacturer
Digital Research
POB 579
Pacific Grove, CA 93950

Price
\$295

Hardware required
IBM PC or IBM PC XT; 8087 version available; versions available for 128K-byte or 192K-byte RAM

Software required
PC-DOS; CP/M-86

Documentation
130 pages

Audience
Business professionals

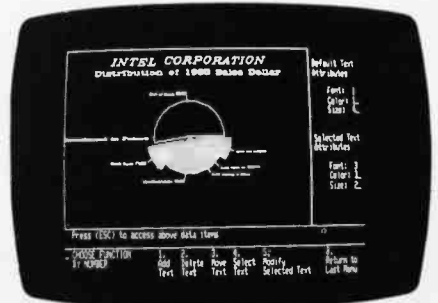

Photo 5: A DR Graph pie chart in the process of being annotated.

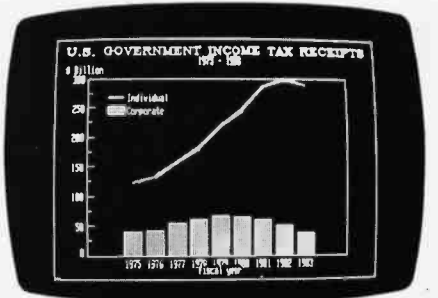

Photo 6: The screen image of a DR Graph chart.

AT A GLANCE

Name
ChartMaster

Type
Graphics; menu

Manufacturer
Decision Resources
Sylvan Rd. South
Westport, CT 06880

Price
\$395

Hardware required
IBM PC or IBM PC XT; monochrome adapter or Hercules color monitor or card; 192K bytes, 256K bytes for use with printer or Polaroid Palette

Software required
DOS 1.1 or 2.0

Documentation
130 pages

Audience
Technical and business professionals who want a fair degree of flexibility within a simplified menu operation

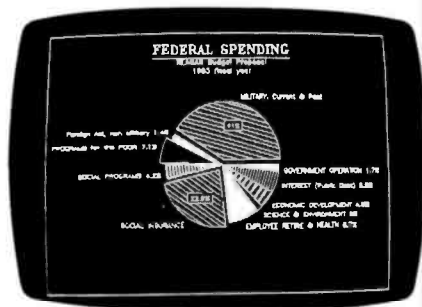

Photo 7: This black-and-white screen image of an 11-segment pie chart illustrates the shares of federal spending and the quality of ChartMaster.

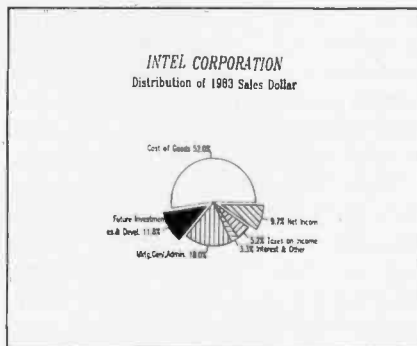

Figure 11: The pie chart from DR Graph trades some chopped-off labels for the ability to annotate the chart.

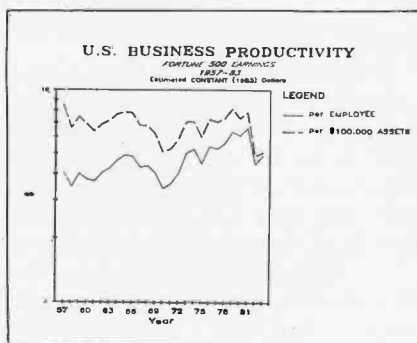

Figure 12: A paired line chart produced by ChartMaster.

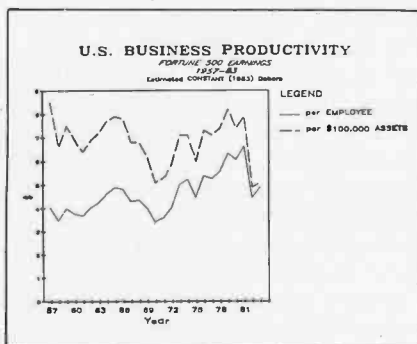

Figure 13: ChartMaster offers a logarithmic (ratio) scale.

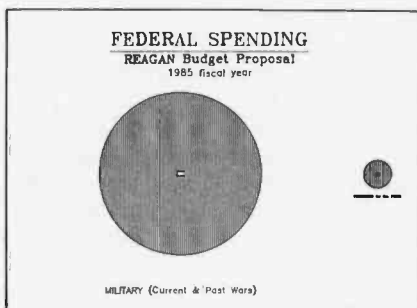

Figure 14: ChartMaster automatically generates a pair of proportional pies.

well, but it cannot do other things I would like. What you see is what you get. This is a menu-driven companion to SignMaster, which can be purchased (at about the same price) to develop text-only charts. SignMaster, like ChartMaster, operates easily and well.

A simple line chart of the productivity of U.S. business provides a good example of ChartMaster's capabilities (figure 12). Several different type styles, with and without italics and underlining, along with a number of different type sizes, provide you with custom-made charts. Data entry is simple, as is flipping back and forth between menus to develop the chart. In this case, constant dollar measures are used to eliminate the distortion because of inflation. You can overcome a second distortion, caused by a linear "Y" scale, by touching a few keys. Voila: you have a log scale and an excellent chart (figure 13).

The log scale is one of the several unique functions of ChartMaster, which is one of the only micro-based charting packages to support different scales on each of the "Y" axes. This capability means that you can chart two series with different scales without resorting to an index and losing some of your audience in the process.

A second unique ability of ChartMaster is illustrated in a pair of pie charts, unsegmented in this case (figure 14). Each chart is automatically drawn to scale and side by side. My only complaint about this chart is the scaling of the legends, which go beyond the limits of readability. The borders around the charts are a nice touch that adds to the chart's readability.

ChartMaster fits my own needs almost perfectly. Choosing from the items on the menu, I have yet to see ChartMaster fail to produce an excellent chart.

THE BOTTOM LINE

The power of charting to help you in analysis and presentation is within your reach, and the products are getting better by the day. With an IBM PC, you can create high-quality charts easily and quickly. Some charts will still be out of your reach, but these packages can do a great deal. I am still looking for a better package, but in the meantime, the programs that are available can get you started on the right track. ■

WORD PROCESSING REVISITED

A review of five new versions of familiar WP packages for the IBM PC—WordStar, Word, pfs:Write, MultiMate, and FinalWord

BY JANET CAMERON

Just a few years ago, we wordsmiths were satisfied with a word processor that would print out our text neatly. Today, though, our standards are considerably higher, and software manufacturers are responding with increasingly complex programs.

Part of the complexity of "installing" word-processing programs could be our own fault. Almost everyone who uses a word processor is spoiled. With our increasingly sophisticated palates, we have come to expect our word processor to be at least as good as a new and improved R2D2.

Some of them are. Some of them even do windows.

We demand an extremely high level of performance from word processors.

We pay for this with increased difficulty in learning and operation. New packages with varying degrees of user-friendliness are flooding the market; currently there are some 150 to 200 word processors available for the IBM PC alone.

Updates, too, are flying out of software manufacturers' doors faster than you can push Escape. Some programs offer significant improvements; some are simply gimmicky add-ons or "holding patterns," i.e., devices to keep users from switching their loyalties.

(continued)

Janet Cameron (POB 1069, Cambridge, MA 02238) is a professional business writer in the areas of printed circuit boards and micro-electronics.



ILLUSTRATION BY JACQUELINE CHWAST

AT A GLANCE

Name

WordStar 3.32

Type

Word-processing program

Manufacturer

MicroPro International Corp.
33 San Pablo Ave.
San Rafael, CA 94903
(415) 499-1200

Price

\$495; options package, \$345; both, \$695

Format

One 5¼-inch floppy disk; three additional disks for extended lesson tutorials; two additional disks required for optional speller/indexing programs

Language

Translation from 8080 machine language to 8086/8088 machine language (listing provided for some sections that may be customized by the user)

Computer

IBM Personal Computer (as reviewed)

Documentation

475-page loose-leaf manual including an installation, training, and reference guide; three disks with extended lessons; reference folder; key labels

Audience

Basic to sophisticated word-processing users, especially those who need to merge programs, create form letters, and use spelling and indexing capabilities

WordStar, Microsoft Word, pfs:Write, MultiMate, and FinalWord all are out with recent updates of their updates. Each of them has put in a few or many new bells and whistles. Each of them has deleted a few or many old bugs and gremlins. It seems that instead of trying to approach some sort of "standardization" in the way we operate word-processing software, the new wave of word-processing developers proceeds on the theory that whoever can achieve the ultimate in esoteric will achieve the ultimate in financial rewards.

I am a writer. I definitely am not a mathematical whiz-bang kid. Along with millions of others, then, I expect two things of a word processor: I want it to do a lot and I want it to be fairly easy to learn and operate. So far, although I've thoroughly tested more than two-dozen packages, I haven't found any such critter.

In researching this article, I used knowledge of and experience with these five packages, information from my anonymous calls to the manufacturers, opinions from friends who use these programs, and a recently published paperback, *The Ratings Book* (Wynnewood, PA: Software Digest, 1984), that features overviews of some 30 word-processing programs. I put the programs, in their updated forms, through some pretty strenuous paces on my machine, an IBM PC with DOS 1.1, 320K bytes of memory, and two disk drives.

WORDSTAR—VERSION 3.32

In spite of its reputation as hard to learn, MicroPro's WordStar is one of the easiest packages to get started. However, between the new version of WordStar and its options package, MicroPro must be attempting to earn a permanent place in the *Guinness Book of World Records*.

With WordStar and its options package, you receive six disks and two very thick and erudite manuals. Just making backups of this monumental mass of information costs a fortune. The increased benefits provided by this library of floppy disks is worth a lot, but users must be willing to wade through the newest WordStar changes, the new spelling checker (CorrectStar), the new index system (StarIndex), and the handy but involved WordStar tutorial.

WORDSTAR'S CAPABILITIES

There's not much you can't do with WordStar. Commands are initiated mostly with the Control key plus one to several keystrokes coupled with commands from one of the seven WordStar menus.

Beginning with the opening menu, a WordStar user can go to any of the program's seven help screens, open a file for editing, execute one of four file commands (print, rename, copy, or delete a file), see the file directory, set his level of help (from 0 to 3), or run either Mail-Merge or CorrectStar.

Besides the opening and help menus, WordStar users can access the editing and formatting screens and the print menu (which, strangely enough, is for special effects on the text and print defaults rather than for printing). Each screen is fairly self-explanatory. WordStar supports most of the best-selling printers on the market today.

All that is required to run WordStar is 64K bytes and one disk drive, but CorrectStar takes a major upgrade to 192K bytes of system memory and two disk drives. On my benchmark tests of all five packages (see table 1 on page 180), WordStar came out with medium-range times on all four criteria: loading and saving the document, searching for the final word *End*, and scrolling from the beginning of the file to the last line. When I write with WordStar, its speed seems acceptable.

Some basic features WordStar handles with ease include moving, copying, inserting, and deleting small amounts or blocks of text; automatic search and replace, word wrap, and hyphenation; dynamic page-break display and default resetting; cursor moves to any part of the text; and a variety of format settings and within-text changes. WordStar supports special features such as double strike, boldface, superscript, subscript, underlining, and strike out. The program automatically justifies the text unless you change the default.

With WordStar, you can perform simultaneous editing and printing, as well as microjustification. Directions for true proportional spacing on WordStar are available in books that explain how to modify the format portion of the program to achieve this result.

(continued)

How Can You Avoid Getting Trapped Under An Ancient Word Processor?

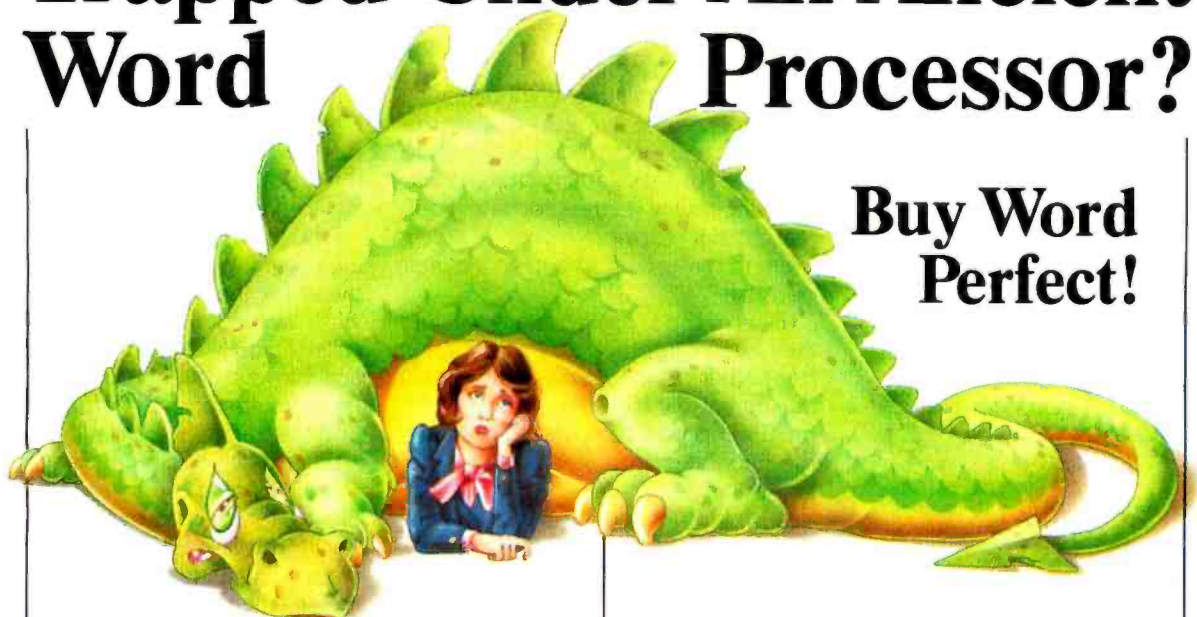

Buy Word Perfect!

Once upon a time, word processors were monstrous things. Dot commands, page orientation, and separate editing, formatting and printing programs turned them into lumbering beasts. Only a well-educated programmer would dare don his armor and tackle such a beast — not a pleasant task for a modern secretary, executive, or writer.

Then came WordPerfect and the beast was slain.

WordPerfect was designed to work for you not against you. WordPerfect has no command language to complicate your writing. Pressing a single key is all it takes to

bold, underline or center.

When writing, you don't want to worry about page formatting, making room for headers or footers, or

whether you are in "edit" or "create" mode. Your word processor should do it automatically and WordPerfect does. WordPerfect lets you think in terms of ideas, not pages. It is simple enough that you quickly forget about the mechanics and your writing flows easily.

So if you don't want to be caught under a word processing monster, try WordPerfect. We're certain it will improve the quality of your writing.

WordPerfect

You'll love it — not only for the features we've built in, but also for the antiquities we've left out.



SATELLITE SOFTWARE INTERNATIONAL

288 WEST CENTER STREET, OREM, UTAH 84057 (801) 224-4000 TELEX 820-618

SSI

AT A GLANCE

Name

Microsoft Word 1.1/2.0

Type

Word-processing program

ManufacturerMicrosoft Corp.
10700 Northup Way
Bellevue, WA 98004
(206) 828-8080**Price**

\$375 without mouse; \$475 with mouse

Format

Without mouse, two 5¼-inch floppy disks; mouse-driven system requires a third 5¼-inch floppy "mouse" disk and a mouse card

Language

C (user-configurable for typesetter interface but cannot be customized)

Computer

IBM Personal Computer (as reviewed)

Documentation

400-page loose-leaf manual, 120-page mouse installation guide, graphics mouse guide, mouse operations guide, reference folder, and key labels

Audience

Basic to sophisticated users; mouse-driven program appeals especially to users who want speedier operation and less typewriter orientation

MicroPro representatives say they are "working on" a toll-free telephone number for end-user support. Updates of WordStar and the add-on packages are available for fees varying from \$25 to \$85, depending on the program. WordStar is not copy-protected, enabling users to make backup copies for their own use.

Users of the MicroPro family will find they can merge not only information from other "Star" packages into WordStar, but also that this pioneering word-processing package can often handle the integration of other vendors' programs into its system. WordStar handily deals with the creation and manipulation of columnar text and figures.

Sophisticated .DOT commands enable the user to utilize microjustification, conditional page breaks, headers and footers, top and bottom margins, page numbers, margin offsets, line height and paper length, bidirectional printing commands, and a variety of other advanced formatting options.

File merging, support of a host of printers, an on-disk tutorial, column manipulation, and decimal tabbing are additional features appreciated by confirmed WordStar users. Although WordStar has been added to, subtracted from, and revamped as much as its own cut-and-paste feature, the latest version is a clean package that performs superbly.

Among the improvements of version 3.32 over 3.0 are more clearly written documentation (the new pictures are a big help), user-definable function keys (and they aren't too difficult to program), simpler installation, support for multicolor on color monitors, redesigned menus, and faster screen updating. The best of these features is the improved manual, although there are still voids and complexities that could have been eliminated by almost any beginning WordStar user. As with every package, there are problems and limitations.

WORDSTAR'S LIABILITIES

A sure way to be marked and deleted is to badmouth the American flag, Mom, apple pie, or the sacred cow of word processing, WordStar. The program has its liabilities, and they are as peculiarly confusing as MicroPro's continuing utilization of non-mnemonic commands.

The six-lesson tutorial, though quite time-consuming, is helpful in learning this heavy-duty program. But the documentation is difficult and puzzling to get through. I especially have difficulty trying to find the index.

With most of the other word-processing programs I use, there is an S command for the Search function. Not so with WordStar. It uses a command called Find. Even though WordStar practically invented word processing and set the defaults for many programs, I still find this difference irritating.

When I am totally immersed in the writing process, I find it almost impossible to return to WordStar's opening menu. The way WordStar is set up, most of its commands work off the opening menu; when I have a problem accessing it, I have a problem producing my document. In fact, getting back and forth between WordStar's menus is a real pain. There are several ways to get back and forth, including the CTRL-K commands, but they are awkward and frustrating.

Still, WordStar is a clean, satisfying, in-depth program. Writers, office workers with serious word-processing needs, and people who spend a lot of time preparing nonstandard reports, papers, articles, etc., will probably consider WordStar the respectable giant of word processing. And in spite of the huge amount of competing programs, MicroPro still has a winner.

**MICROSOFT WORD—
VERSIONS 1.1 AND 2.0
(WITH AND WITHOUT MOUSE)**

It sure will help when Microsoft gets a toll-free telephone number for Word users and writes some half-way decent documentation. New users of the clever little mouse especially will benefit from these improvements.

There's almost a consensus in informed circles that mice are the wave of the future. I'm not sure I'm happy about this trend. If you're accustomed to keyboards, operating the mouse takes some adjustment.

In my case, Microsoft Word's 122-page so-called "installation and operation manual" is a complete farce. A fine tutorial is really needed. In the newest version, the addition of a small folder about using the mouse doesn't help a

(continued)

WHEN SPREADSHEETS DON'T GIVE YOU THE PICTURE...

**LINE CHARTS
STATISTICS**

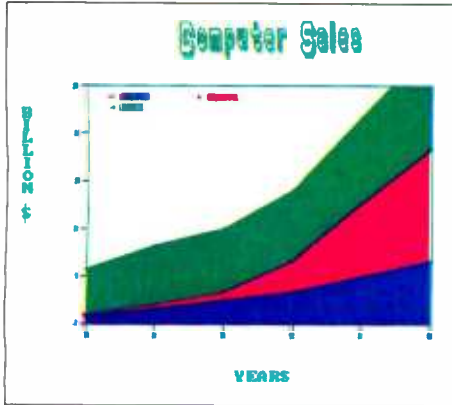

**GANTT CHARTS
PROJECT SCHEDULING**

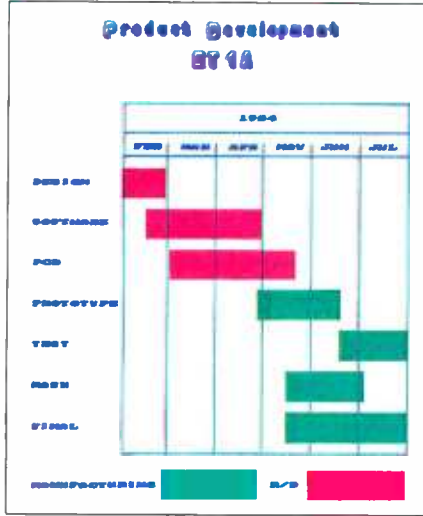

**3-DIMENSIONAL
BAR CHARTS**

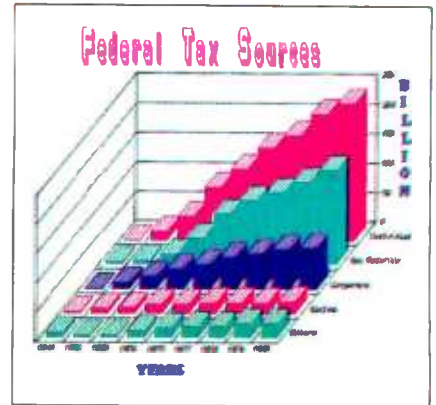

**MULTI-SCALE BAR CHARTS
NEGATIVE BAR CHARTS**

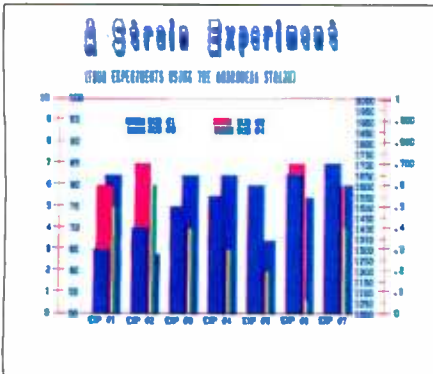

**FLOW CHARTS
ORGANIZATION CHARTS**

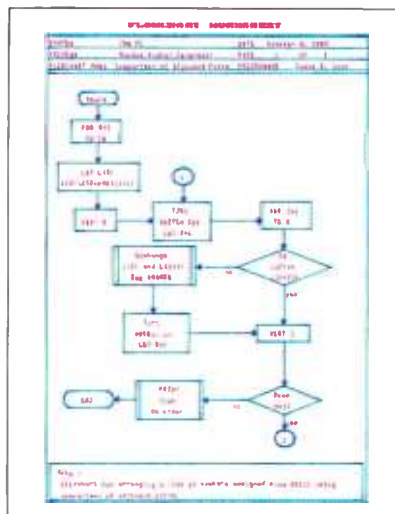

PIE CHARTS

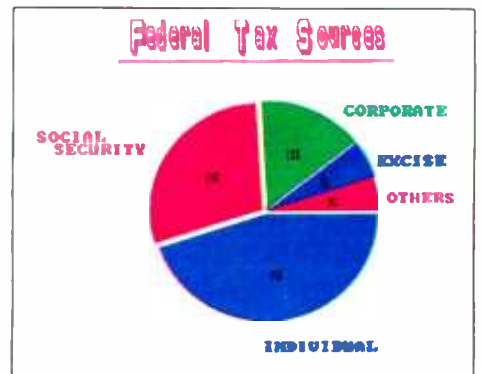

THE FIRST COMPLETE GRAPHICS PROGRAM DESIGNED FOR EVERY BUSINESS USE ON IBM-PC'S*

ENERGRAPHICS™

Dynamic and so easy-to-use, **ENERGRAPHICS** is already helping business managers at 40 Fortune 500 companies. **ENERGRAPHICS** is used in Finance, Marketing, Sales, Advertising, Research and Data Processing. Both VisiCalc® and Lotus 123™ spreadsheet files interface with **ENERGRAPHICS**. For the first time business executives can plan, project, present, analyze and report with the best looking professional graphics available on the IBM-PC and compatibles.

VisiCalc® is a registered trademark of VisiCorp.
Lotus 123 is a trademark of Lotus Development Corp.

Call 800-325-0174
(except in Missouri)
for our detailed

ENERGRAPHICS brochure

Circle 59 on inquiry card.

ENERTRONICS

Enertronics Research, Inc.
150 N. Meramec • Suite 207 • St. Louis, MO 63105 • (314) 725-5566
Fall 1984 • BYTE Guide to the IBM PC • 169

* HARDWARE CONFIGURATION: IBM-PC; 128K; Dual Disk Drive; Graphics Adapter; Dot Matrix Printer; and/or XY Plotter; Compaq, Columbia and Eagle Computers

StarPolish brings out the best of WordStar (version 3.30) with a true display of special print effects before you print. **Boldface**, underlines, _{sub}script, ^{sup}erscript and *italics* all appear in final format¹. What you see on the screen is exactly what you will get on paper. Word for word, line for line, space for space. There are no confusing control characters, like ^B or ^S, to clutter your screen and make the text hard to read. So you make fewer mistakes and correct them faster.

Use of WordStar with StarPolish is totally compatible with normal WordStar files and commands. You don't even have to remember command sequences because StarPolish HELP menus remind you, in terms you understand. And StarPolish puts

your PC function keys to work to give you the option of saving keystrokes. StarPolish also supports the full special print effects capability of your dot matrix or ink jet printer.

To make your WordStar shine for only \$125, ask your local dealer or call us today at (301) 340-8700.



TDI Systems, Inc.

620 Hungerford Drive
Suite 33
Rockville, MD 20850
(301) 340-8700

¹Photo display using PC with color monitor and color graphics interface card.

StarPolish is a trademark of TDI Systems, Inc. The StarPolish programs and the copyrights to the product are owned by Alethic Software Associates.

WordStar is a registered trademark of MicroPro International Corporation.

Circle 172 on Inquiry card.

WordStar[®] with StarPolish[™]

What you see is what you print

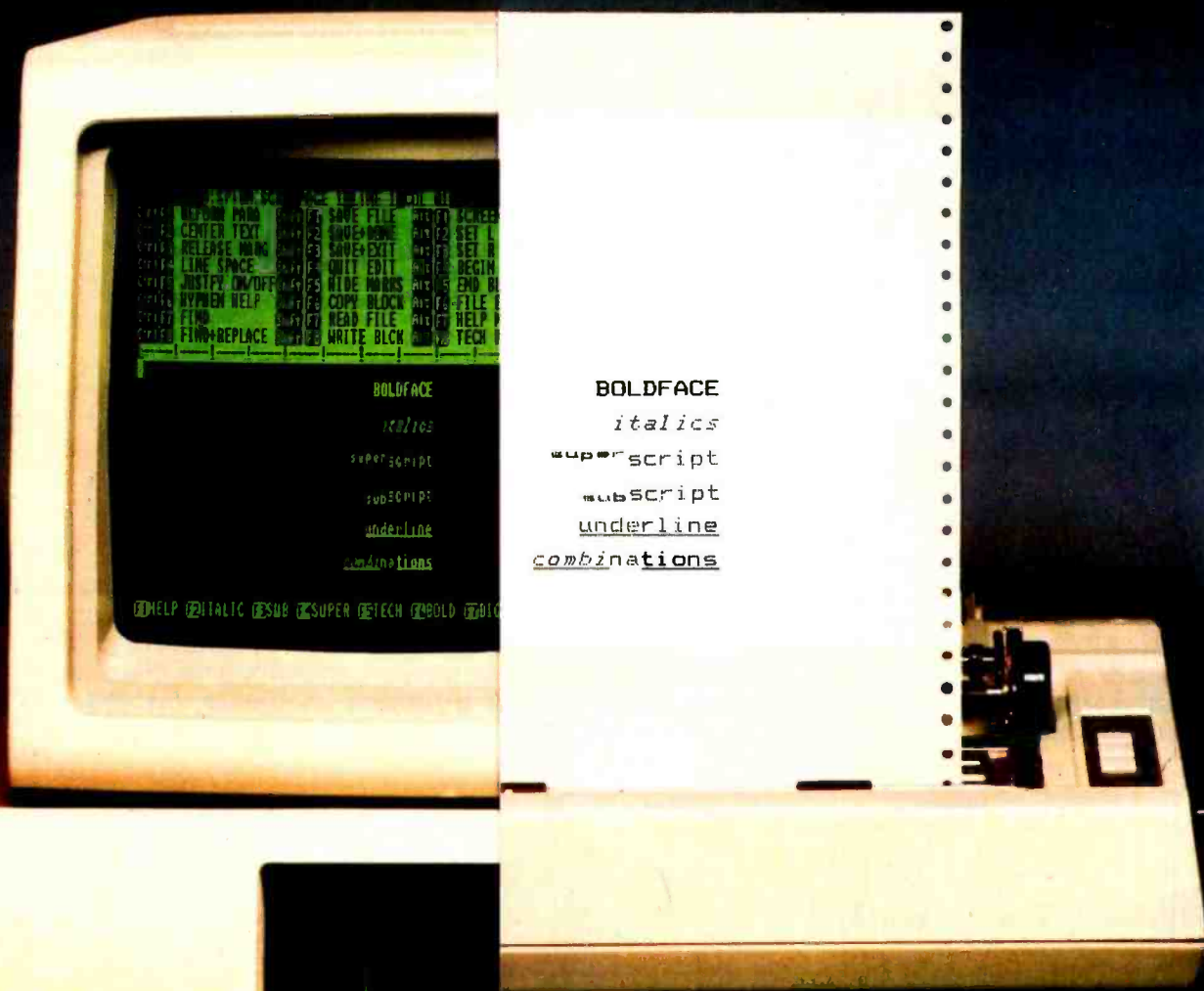

great deal. Clearer prose would help new users to get into the program with less than a lifetime of frustration.

Generally speaking, Word (with or without the mouse) is clever, put together well, and performs some extraordinary feats. Its highly touted windows are well worth the high touting. It's command structure is relatively easy to learn, and Word can fully utilize all the special characters (listed in its extensive help menu), hexadecimal codes, and up to 64 different type fonts.

Word's formatting and style-sheet capabilities are complete and more than satisfactory, though I found them hard to use fully while operating with the mouse. The biggest problem I have with Word is its many built-in redundancies, including having to use two disks to get into and out of the program; the multiple commands; confusing labels (Alpha, Gallery, Transfer, Division, etc.); and the use of the right, left, and both-together mouse buttons. Word's system disk contains copy-protected material and thus cannot be cloned. The program disk can be copied.

Instead of working to make the program more flexible in the context of current word-processing programs, Word's developers seem to be trying to completely reinvent word processing. At this time, I care not to start over from scratch. Those users who are just discovering the wonders of word processing may feel differently about Word.

Major enhancements in this revision include a built-in merge for customized form letters, built-in support for the Hercules graphics card, a mouse utility program that provides mouse support for several external programs, optional compatible spelling checkers, and the support of other computers and printers.

Now, without shuffling disks, Word's users can produce form letters; merge data from other Word documents, ASCII (American National Standard Code for Information Interchange) files, or from the keyboard; use direct output from other programs, such as dBASE II; and use English-like instructions with no restrictions on the contents or lengths of text fields to be inserted.

The utility program (called Mouse Menus) that comes with the new version of Word furnishes support for Multiplan, Lotus 1-2-3, WordStar, and VisiCalc.

Word's developers say users may create menus to use with other programs.

Two spelling checkers are now available (at additional cost) to Word users. Microsoft's package can run on more computers and is compatible with more printers than before. According to the manufacturer, with this current revision, Word has the capability to support vir-

tually every dot-matrix and daisy-wheel printer without requiring a special program. Only a printer-descriptor file (described in the manual) is required.

MICROSOFT WORD'S CAPABILITIES

Power and flexibility mark Word as a *(continued)*

One board speaks over 450,000 words.

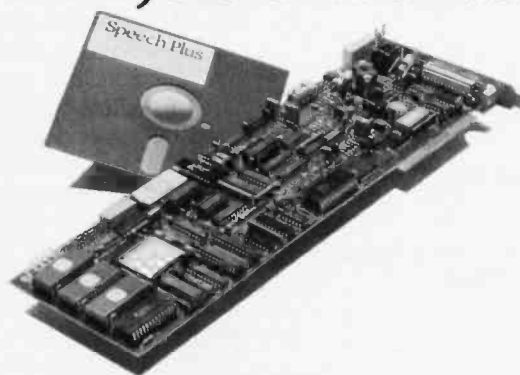

CallText™ Voice Synthesizers have an Unlimited Vocabulary

With CallText Voice Synthesizers, your computer can *speak* electronic mail, stock quotations, sales status, weather reports or any vital information. And CallText products include a telephone interface, so people can call in and listen as any ASCII text file is converted to speech in real time.

Advanced technology gives CallText Voice Synthesizers full command of the entire English language — nearly a half million words.

For a live, interactive demonstration of how data can be delivered in voice, call (415) 969-6257.

Features

- High quality text-to-speech conversion.
- FCC-registered telephone interface with Touch-Tone™ decoding and generation.
- Speaker amplifier for local monitoring.
- Two models now available:
 - CallText 5000, IBM PC/XT compatible card. Includes I/O drivers; BASIC, C, Assembly languages.
 - CallText 5050, RS-232C computer peripheral.



Speech Plus

INCORPORATED

Touch-Tone™ is a trademark of AT&T Information Systems

461 NORTH BERNARDO AVENUE, MOUNTAIN VIEW, CA 94043
TELEPHONE (415) 964-7023

AT A GLANCE

Name

pfs:Write 1.1

Type

Word-processing program

Manufacturer

Software Publishing Corp.
1901 Landings Dr.
Mountain View, CA 94043
(415) 962-8910

Price

\$140

Format

One 5¼-inch floppy program disk, one
5¼-inch floppy "sampler" disk

Language

Pascal and assembly

Computer

IBM Personal Computer (as reviewed)

Documentation

70-page manual, on-disk "sampler" tutorial

Audience

Basic word-processing users and those who
want form-letter capabilities

multifaceted program that's worth checking out. But there are hundreds of new things to learn if you choose this package for your own, especially if you opt for the mouse.

For those of you who aren't familiar with this little gadget, the Microsoft mouse is a hand-held device with buttons used either separately or in tandem to carry out commands. The underside of the mouse has a rolling ball that positions the mouse's cursor on the screen. By utilizing short directional moves and pressing one or both mouse buttons, the user points to and carries out Word's commands and functions. Essentially, the left button chooses the option you desire; the right button executes the command and puts you into the following level of command. Pushing them both simultaneously negates the previous order.

Some of the features programmed into Word include compatibility with hard disks; an "undo" facility with a scrap buffer; and highlighting of characters, words, sentences, and paragraphs for use with various modes (such as Move, Copy, Insert, and Delete). This program lets the user make the most of standard and advanced formatting with an ease up to this time unknown in the word-processing game.

Entering the program requires first inserting the Word system disk; then, when Word prompts it, the program disk. Backing out of the program requires the same hassle in reverse.

One thing Microsoft did right: it made the mouse very easy to install. You position and secure the printed circuit board that comes with the mouse into an expansion slot. Then simply attach the mouse's plug to the I/O (input/output) port and you're in business.

After you get into the program, things start to happen fast. A screen with a double border appears. One is a selector rectangle, the other is the movable mouse cursor. A visible ruler outlines the top of the screen; Word's menu, command, status, message, and information lines take up the bottom four lines. The working portion of the screen (19 lines) is a bit short, but the space seems adequate for my needs.

With the mouse-driven version, complete words prompt the user to choose Alpha (for entering or editing text copy), Delete, Format, Gallery (an alternative

command/style process), Help, Insert, Jump (go to), Library (set aside for future features), and Options (sets measurements, turns on and off the alarm and overtyping modes).

The Print command sets the parameters for hard copy. Transfer is used for loading and saving documents from a data disk. Undo and Window round out the first level of commands. And that's just the primer.

In my benchmark tests, Word, along with WordStar, came out just about average in speed of saving, searching, and scrolling to the end of the document. In loading the document, Word was slightly ahead of the other four.

Word handles all routine chores with ease and dispatch. Some of its more advanced features include glossary options (an abbreviated way to delete or copy repetitive words, strings, or blocks of text) and windows (up to eight horizontal and/or vertical divisions of the screen for cutting and pasting, viewing and editing text, documents, footnotes, and so forth). Word also automatically reformats copy as you are working and displays a rainbow of colors when used with an RGB (red-green-blue) monitor.

You can use the mouse to create and handle windows by pointing to an area in the double border (the window bar) and clicking the button, or point to the lower right-hand corner of the screen and turn the cursor into a four-headed arrow. You can also create and manipulate windows with Word commands when the mouse is not being used.

Besides the standard word-processing functions, ASCII-based Microsoft Word has the capability to handle footnotes, multiple columns, the transfer of WordStar files, horizontal scrolling, and special features such as italics, sub- and superscript characters, small caps, underlining, boldface print, and combinations of these features. Integration with laser printers will be available as this type of printer becomes more commonly obtainable.

In the works, according to Microsoft, is badly needed reference documentation, a toll-free user support number, and an indexing capability.

WORD'S LIABILITIES

I have many friends who like this program a lot. For me, however, this program, especially when operated with

WORD PROCESSING

the mouse, has many more limitations than benefits. I'd like to mention a few.

Generally speaking, this package (even without the mouse) is extremely frustrating to learn and operate efficiently. With the advanced Word features, the user has to go to several different places and utilize more than one command level to get results. In order to operate the program with the mouse, you need some more-than-basic manual skills or a course in remedial pointing. It's very frustrating to miss the mark with the mouse's selector and destroy what has taken a good bit of time and effort to achieve, or to continually run the mouse headlong into the keyboard and risk ruining the keyboard or the mouse module itself.

Memory requirement for the program is 128K bytes and one disk drive, but my experience with Word leads me to believe 192K bytes and two disk drives are almost essential. An item most of us find extremely irritating is Microsoft's policy of copy protection. Yes, the *program* disk can be copied for your own use, but the *system* disk, necessary to boot and quit from the program, cannot be copied.

In order to tap into the mouse system, you have to read between the lines in the mouse non-manual and read the minds of the developers. Every now and again, when you hit a dead end, the only way to move ahead is to insert DOS (disk operating system) and utilize its capabilities. I could not find this situation mentioned in the documentation.

Word often moves text off the screen while it is in its operating mode. This is terrifying to those who need security blankets to keep their equilibrium while producing long or complex documents. Inadvertently wiping out text you intended to be permanent is frightening.

With Word, deleting is a two-stroke process. With many, many packages, deleting is safely accomplished with one stroke and response to a safety-valve question. Saving is even more disconcerting and time-consuming. Not only does Word require three or four steps to save material, but after you have executed these commands, it pauses more than 10 seconds before putting the message on screen that it actually is saving the material. This will be a long and awkward delay for most users.

PFS:WRITE—VERSION 1.1

Pfs:Write continues to plug along as an elementary program for users who don't have enough time to major in word processing or who have basic needs and aren't into the one-upmanship game. This revised program has some major deficiencies, though, including its inability to justify text except line by line, its insecure nature, and its extremely complex deletion mode.

PFS:WRITE'S CAPABILITIES

The benefits of pfs:Write are many. The main advantage is its overall ease of operation. I get the feeling the developers set out to make the package as simple to use as possible. (What a novel approach.) For instance, this program's main menu really is self-explanatory; it offers six choices: Type/Edit, Define Page, Print, Get/Save/Remove, Clear, and Exit. Pfs:Write's Define Page menu lets users make formatting changes other than the default values. With this selector, you can set the margins (top, bottom, right, left), specify page length, put in headers and footers (up to two lines each), and have Write automatically insert the page numbers for you. There are some tradeoffs, however, such as the program's assuming that any number found in a footer is a page number. If you need to have the footer act as a footnote, you're out of luck.

Pfs:Write does a good job of automatically reformatting text when you change parameters through its Define Page feature. You can decide you want your material to be squashed down to a narrow column instead of given the space of a full-width page. With the Print menu you can set print parameters; cause the program to merge other documents, such as VisiCalc (as long as they have been printed to a disk file); and create a text file by printing to a disk. The Print function also enables you to add graphs from pfs:Write's fellow program, pfs:Report, if the material has been saved as a picture file. You can print an entire document, one or many pages, space your material, print envelopes from the addresses in your letters, change the position of your text on the paper, and print the document to almost any printer that you can con-

(continued)

IBM PC™



64K, 1/360K Drive
\$1650

Typical Configurations

IBM PC 64K

1 Drive, Monochrome Monitor & Card

\$1995Same w/256K & 2 drives . . . **\$2349**or add 10 meg Internal Hard Disk
with these features:

Plug compatible with IBM XT™

— Half height hard disk — One year warranty
— Uses IBM DOS 2.1 — Requires no extra power**\$3037** w/256KCompaq 256K, 2/360K drives . . . **\$2349**

Compaq 256K, 1/360K drive,

10 Meg Internal **\$2995**10 Meg Internal Hard Disk **\$895**64K RAM chips for PC's **\$49**Tandon TM 100-2, DS/DD **\$199**Control Data 9409, DS/DD **\$199**Taxan Monochrome **\$165**Amdek 310 A Monochrome **\$165**Princeton PGS HX-12 (RGB) **\$499**Quadram QuadColor I **\$209**Persyst mono card w/parallel **\$229**Quadram Quadjet **\$695**TI 855 **\$849**Juki 6100 **\$449**Okidata ML92P **\$449**Okidata ML93P **\$709**Epson FX-80 **CALL**Epson FX-100 **FOR**Epson LQ-1500 **PRICE**AST SixPack Plus (64K) **\$259**Quadram Quadboard (64K) **\$279**MultiMate 3.22 **\$299**Multiplan **\$145**ProKey 3.0 **\$89**Norton Utilities **\$55**dBase III **CALL**Open Access **\$299**Lotus 1-2-3 **\$339**Wordstar ProPack **\$399**

Prices subject to change without notice.

SHIPPING FREE WITHIN USA.

IBM is a trademark of IBM Corp. No surcharge for credit cards.

Quantity Pricing Available.

Corporate PO's accepted.

ORDERS ONLY, CALL**1-800-IBM-5150****PC'S LIMITED**

(512) 452-0323

CALL FOR LATEST PRICES

7801 N. Lamar, #F-1

Austin, Texas 78752

nect to your machine.

With the Print function, you can print more than one copy of your material. To take advantage of any of these features, or those from any other of this program's menus, however, you have to reprogram your thinking to use the Tab and F10 keys instead of the cursor and Enter keys.

More pluses for pfs:Write's Print mode include the ability to insert a command for special characters (such as italics or any others your printer will support), utilize more than one printer, pause between pages, and stop the print function at any stage simply by pressing the space bar (supposedly). When I tried this clever little "stop print" feature,

however, my printer kept on humming along.

Appending is exceptionally easy. Simply enter the command at the location in your working copy where the joined document is to appear, and pfs:Write makes it happen when you print it out.

The Get command works approximately the same way as the Save feature. Pfs:Write makes a working copy of your document so changes affect the backup instead of the original. The Remove command provides an exceptionally easy way to permanently erase a document or other on-disk file. But there is no going back, no undoing, no changing your mind. If you don't have a backup copy and you command the program to erase your copy, you'd better have some Valium or a stiff drink handy.

When I crank up pfs:Write, I like what I see on my screen. At the bottom, I see a ruler with decimal and text tabs, line and page numbers, amount of memory space left, cursor position, places for special editing functions, error messages, and special enhancements, such as Insert or Label. The program also tells me when I am in "working copy" mode and how to get to the help screen (F1).

The package's Insert function is fundamental and acceptable. The program's developers should get an award for the uncomplicated "labeling" method of changing, deleting, moving, removing, and copying blocks of text. Function keys are used for moving around in the text when you label (highlight) the areas you want to change. The Search function works only in forward gear, but the Search/Replace function (either manually or automatically) is almost sinfully simple.

The program creates standard ASCII files, supports a hard disk, several new machines (the IBM XT for one), DOS 2.0, and shows on-screen the location of page breaks (with cursor move only, not with page-up or page-down moves). A minimum of one disk drive and 128K bytes is necessary to run pfs:Write.

PFS:WRITE'S LIABILITIES

Even though the program is inexpensive and the manufacturer provides one backup, the fact that pfs:Write is copy-protected is inexcusable.

WIPE OUT STATIC FAST



It's easy with Staticide® Wipes.™

One quick application cleans CRT screens, copiers, keyboards, or any clear surface. And as it cleans, Staticide Wipes will eliminate static—the major cause of dust attraction on CRT screens, computer glitches, malfunctions and downtime. And these handy towelettes are non-streaking and will not leave a vision impairing residue. So instead of buffing down, you can get down to work! Consider the thousands of dollars you've invested in equipment. And how a few cents more will help keep it clean and operating, without the risk of harming sensitive electronic components.

Staticide WIPES
The towelette for cleaning and static control.

Staticide WIPES
A product of ACL, Incorporated
1960 E. Devon Avenue
Elk Grove Village, IL 60007
(312) 981-9212

Although the documentation summaries are good, the documentation itself (including the on-screen tutorials) leaves much to be desired. Yes, you can make a copy of "Sample," the on-screen tutorial, but who wants to? The tutorial teaches you about price lists before it even mentions cursor moves, and pfs:Write cursor moves aren't all that easy. In the book, the program's features are arranged from advanced to easy. Why? I found the material about form letters especially confusing. What should be elementary explanations are not. But the biggest problem I have with this pleasantly small, handy (not dandy) guide is that when I am searching for something, anything, the pages continually manage to get out of the spiral binding. Reinserting them is next to impossible. Thus I have a desk full of individual manual pages for this program.

To move the cursor more than one character at a time, it helps to have memorized the function keys. To move the cursor within a menu requires the use of the Tab key. The manufacturer provides a cheap cardboard template; when I tried to apply it over my function keys, it immediately tore.

The Get and Save portions of pfs:Write's Get/Save/Remove function aren't all they're cracked up to be. For a program with lots of built-in comfort, pfs:Write could excel here, but it doesn't.

Having to return to the main menu, push #4, type in the name of the document you're working on, and then press F10 is not only a huge waste of time but a sure exercise in how to forget what you were working on before you started into this process in futility. Then you have to reverse the procedure to get back into your document, consuming another few plodding minutes.

Pfs:Write's multiple-step Save procedure includes a sentence, "document about to be overwritten," each time you write the material to disk. "Press Escape to abandon this operation or F10 to continue." Sounds safe, eh? Wrong. To find out how safe it is, I pressed F10 in a couple of instances and instantly lost two hours' worth of data. After working with this problem, I concluded that the use of the term "overwritten" is questionable. Evidently, for some reason, the program doesn't always save newly entered material.

I got an additional dose of insecurity

when I twice lost some copy after pressing F10 to continue in the printing operation (instead of pressing Escape to "abandon this operation") and the program trashed my prose.

Since I have a penchant for doing funky things to formatting defaults, I found it extremely frustrating not to be able to permanently change them in pfs:Write. And the program operates in Strikeover mode when my personal preference is Insert, but since this program's Insert mode is simple to get into and out of, I adjusted fairly quickly.

Deleting is not easy with pfs:Write, especially in Command mode. There is a destructive backspace, but you have to remember to go past the last character to activate it. And deleting forward is jerky and sporadic. Right justification, boldface print, and underlining can be done after the fact—one line or word at a time. With the Shift and a function key, these enhancements eventually do happen. But not without effort.

Although pfs:Write came out in my benchmarks about average in all four tests, I found you can add another year or two to your life during the time it takes to save material.

Several other "couldn't's" include not being able to get pfs:Write to append files from other ASCII programs (it's supposed to do this); alternate the placement of page numbers or headers and footers; copy columns (it's supposed to be able to do this); save large deletions in order to move them; change formats within a document; and keep the original format of the file being appended to or merged with the pfs:Write file.

Updates are available for less than the package's original price, but at this writing, a toll-free user hotline is not in operation.

Nevertheless, in spite of (or maybe because of) pfs:Write's developers' persistence in retaining its KISS (keep it sim-

(continued)

The Personal EE/EPROM Programmer

FOR YOUR
IBM P.C.

\$395.00

PLUS POSTAGE
& HANDLING

*With Shooter
You Aim Low
in Price and High
in Quality!*

- RS-232 Port. Works with any computer or terminal.
- Stand-Alone. Copies & verifies.
- 32K/128K RAM Buffer.
- Upload/Download in Intel or Motorola Hex format.
- 90 Day Warranty

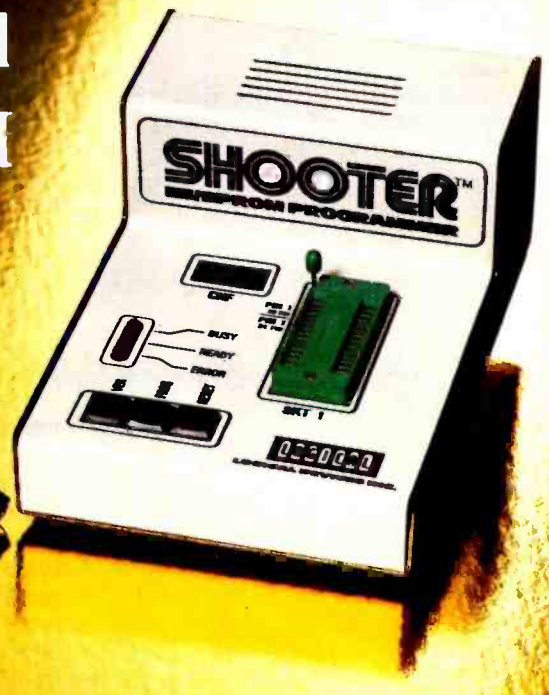

LOGICAL

LOGICAL DEVICES, INC.

1-800-EE1-PROM (331-7766)

FLA. (305) 974-0967 • TELEX: 383142 LOGICALTX
1321E N.W. 65th PLACE, FT. LAUDERDALE, FL 33309

Circle 101 on inquiry card.

AT A GLANCE

Name

MultiMate 3.20

Type

Word-processing program

ManufacturerMultiMate International Corp.
52 Oakland Ave. North
East Hartford, CT 06108
(800) 243-4646**Price**

\$495

FormatThree 5¼-inch floppy disks: boot/system,
utility, and speller/dictionary**Language**

Assembly

Computer

IBM Personal Computer (as reviewed)

Documentation469-page padded manual, reference card,
templates, and key labels**Audience**Sophisticated word-processing users who
want a Wang-like package with spelling-
checker capability

ple, stupid) policy, this firm has assured itself a permanent and unique place in the word-processing marathon. When Software Publishing or another company fixes this program's faults while keeping its assets, we'll really have something.

MULTIMATE—VERSION 3.20

MultiMate International Corporation's efforts to "modernize" its program have resulted in a good news/bad news effect. Now MultiMate is safer—the safest package of the five I compared; but it's also klunky—the klunkiest package of the five I tested. Would that the company had concentrated on reducing the number of steps required to use each of the program's handy features instead of providing so many safety backups of safety backups.

The consensus is that this Wang-like program has a multitude of benefits and a multitude of sins to contend with. And my investigation bears out this opinion. Wangs are known for their heavy use of dedicated keys for cutting and pasting, canceling, entering, etc.; MultiMate seems to have patterned part of its program around this concept.

MULTIMATE'S CAPABILITIES

MultiMate's documentation actually starts with what you need to begin; this marks a beatific trend I hope catches on. As soon as I got over the shock of it all, I realized it takes 192K bytes (256K bytes with DOS 2.0 or 2.1) to begin. So I went to the memory store and hiked up my memory past what MultiMate says is necessary.

It takes three disks—the DOS/boot/system disk, the utility disk, and the speller/dictionary disk—to do all of what MultiMate provides. Essentially, the DOS disk gets things up and running and does the major portion of the tasking. The utility disk handles the responsibilities of converting to standard ASCII files and recovering lost data or missing format lines. The speller/dictionary (accessed from the main menu) is self-explanatory and works satisfactorily.

The program is easy to install; the documentation has good basic directions. And typing *wp* to boot the system is a grand way to enter. Would that we could start them all this easily.

This package has good walk-through screens—many of them. My impression

of MultiMate's numerous help screens is that they are too numerous, and even with a chart in the manual, confusion reigns. It would have been easy and wonderfully clear had the developer simply put the key or keystroke combinations in boldface type followed by the explanation for each. For some reason, quick reference charts are few and far between. Why? Because MultiMate didn't do this. I did my own and found that within 15 minutes I had the most-used functions down pat. A template that does this is available from the company for \$6.95.

MultiMate's status line displays the document name, page, line, and column number. Its format line indicates the current line length, line spacing, and tab settings. It also puts an on/off sign on-screen to remind the user of the status of the Shift and Numlock. I had problems with the page-length parameter. This program sets a limit of 150 lines per page, but just try to get it to actualize this promise.

Defaults are easy to change. And the information this program's documentation offers the user is helpful and appreciated. Novices, however, might find the going a bit tough at first since the jargon in the manual is pretty intense and assumes everyone is familiar with word processing.

MultiMate has several points in its favor. Besides being very safe, it lets you customize the program both with its standard utility and its easy-to-use PAT (printer action table) functions. MultiMate is politely sparse with its error messages, too, and hurls them at you only when you've done a no-no.

MultiMate's ability to work with vertical and horizontal columns (including calculations) is a bonus. Unfortunately, moving the vertical columns doesn't always turn out new, perfectly aligned material.

This program handles formatting chores as if it were made to serve. Centering, underlining, boldfacing, justification, spooling, continuous automatic reformatting, visual page breaks, and getting back and forth between menus all are easily dealt with. Tabs, margins, hyphens (hard and soft), and line spacing are simple.

MultiMate has a vehicle (its library) that enables the user to create macros

(continued)

PRINCETON™
An Intelligent Systems Company

If you're looking for a quality monitor, look for this symbol.

HX-12. A high resolution monitor at a medium resolution price.



HX-12 is a high resolution RGB color monitor that's colorful enough for all your graphics needs and sharp enough for word processing.

With its own cable that plugs directly into the IBM PC, the HX-12 delivers a rainbow of 16 colors on a non-glare screen. All that includes clean whites without red bleed. In fact, all the colors are clean and crisp thanks to the HX-12's .31mm dot pitch and 690 x 240 (non-interlaced) resolution.

Shop around. Nothing else compares to the HX-12 priced at just \$695.

The SR-12 delivers even better resolution color for a better-than-ever price.

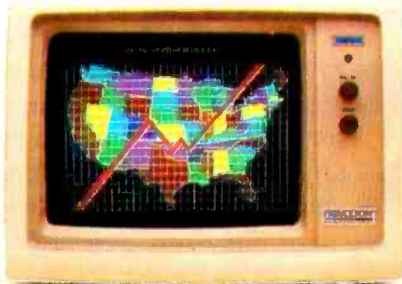

At first glance, the SR-12 might appear similar to the HX-12 with a non-glare screen and .31mm dot pitch supporting 690 horizontal resolution. But take a closer look. SR-12's scan frequency is 31.5 KHz, allowing the SR-12 to support 480 vertical resolution in non-interlaced mode. That means a high-quality, flickerless image with text that's up to monochrome standards. What's more, you get all that quality for \$799.

For full compatibility with all IBM software, get the **Princeton Scan Doubler**. Priced at \$249, it allows you to run the SR-12 from a standard IBM or IBM equivalent color card in the IBM PC.

You can't beat the SR-12 for resolution or price.

MAX-12. You won't find a better monochrome monitor for a better price.

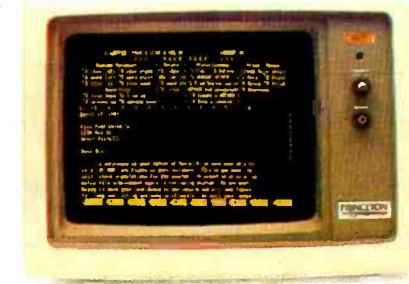

PGS combines easy-on-the-eyes amber phosphor and exceptional 800 x 350 resolution to give you the MAX-12, the best monochrome monitor for your money.

Check the non-glare screen. Dynamic focusing circuitry keeps the image sharp, not only in the center, but around the edges and in the corners. Then check the price. At \$249 the MAX-12 is less expensive than the leading green-on-black competitor. And there's more. The MAX-12 works with the IBM PC and other IBM compatibles.

For clarity, performance and price, your choice is clear. Make it the new MAX-12.

IBM® PC are registered trademarks of International Business Machines Corporation.

© Copyright 1984 Princeton Graphic Systems. All rights reserved.

Circle 147 on inquiry card.

PRINCETON™
An Intelligent Systems Company

Princeton Graphic Systems

170 Wall Street, Princeton, N.J. 08540
(609) 683-1660/(800) 221-1490 EXT. 29
Telex: 821402 PGS PRIN

Fall 1984 • BYTE Guide to the IBM PC • 177

Minis and mainframes have used WordMARC for four years. Now there's WordMARC word processing for your micro.

Originally created for minis and mainframes, WordMARC is now available for use on your micro*. And quite simply, it's the best office-quality word processing software package a micro user could buy. After all, it was the best word processor mainframe and mini users like universities, national laboratories, and Fortune 500 companies could find over the last four years. But, if you need more proof, read on.

□ *No Problems, No Nonsense, No Competition.* For starters, everything you see on your screen appears exactly as it will be printed

on paper. Scientific notation. Foreign language characters. Underlining. Subscripts. Everything. □ *A Partial List of Features. That's Right, Partial.* Menu driven w/function keys. Easy self-

paced tutorials. Spelling checker. Mail merge. Scientific notation. Foreign language characters. Automatic reformatting. Automatic pagination. Document recovery system. Document encryption. ASCII file handling. And so on. □ *If Word Processing's Your Call, Call 800-831-2400.*

Granted, just because the call is free is no reason for picking up the phone. You should stop and consider

our track record with minis and mainframes. You should stop and think what that can mean for your micro. And you should stop thinking about any other word processing software. OK. Now that you've done that, it's time to pick up the phone.

*WordMARC is compatible with the IBM PC or XT, as well as the Eagle, Compaq, Corona, Columbia, NCR PC, DEC Rainbow, and TI Professional computers. All versions of WordMARC on micro, mini and mainframe computers are compatible.

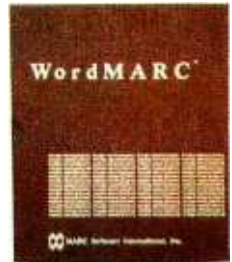

MARC Software International, Inc.
260 Sheridan Avenue, Suite 200
Palo Alto, California 94306
800-831-2400 □ In Calif., 800-437-9900

*WordMARC is a trademark of MARC Software International, Inc. © 1984 MSI, Inc. IBM PC and XT, Eagle, Columbia, Compaq, Corona, NCR PC, DEC Rainbow, and TI Professional computers are trademarks, respectively of International Business Machines Corporation, Eagle Computer, Inc., Columbia Data Products, Compaq Computer Corporation, Corona Data Systems, Inc., NCR Corporation, Digital Equipment Corporation, and Texas Instruments.

for often-used words, phrases, strings, and other information the operator desires to call up at the press of a key. Although the program's speed has suffered since its developers reinforced its safety level, it came out as fastest in my save-document benchmark test.

At this writing, MultiMate International is shipping an update, version 3.3. Because of deadlines, I was unable to review this latest revision. According to the company, 3.3 incorporates faster screen refreshing, microjustification, an on-disk tutorial with an instruction booklet, and the optional capacity for the user to utilize ellipses for visible spaces when desired.

MultiMate handles moving, deleting, and copying with highlighting; headers and automatic page numbers are supported with little problem. There are some deficiencies in this area, however, and they will be noted under the section on liabilities.

The package supports a host of printers and is hard-disk compatible. The program is not copy-protected, and free updates are available for six months. Thereafter, they can be obtained for a reduced price.

The biggest bonus MultiMate has is its pool of knowledgeable, polite, and patient support people at the far end of a toll-free number (800-243-4646). It may take you a year or two to get through the busy signals, though, and even when you do manage to break into the hotline, you may end up on hold for another decade or two.

MULTIMATE'S LIABILITIES

MultiMate's many hitches and glitches all combine to make it the most awkward package of all I tested. Now I can really relate to the theory that the sum of the parts equals more than the whole. Just naming a document with MultiMate is a chore if you take the manual's reserved character list as gospel. The symbol #, for instance, can't be used in the naming process, although I couldn't find information anywhere that mentioned that.

In the benchmarks, MultiMate came out last in speed of both searching and scrolling to the end of the document. Searching and highlighting can be done only in the forward mode.

Shortly after entering the program, my disappointment level rising, I compre-

hended that MultiMate's documentation had neglected to mention adjusting the contrast in order to see the highlighting so necessary to operation. Additionally, the manual takes up the subject of merging before it teaches basic editing functions.

Cursor control is difficult with MultiMate. Often the keystroke combinations designated to move the cursor around chunk by chunk don't do so. Sometimes Ctrl+End put me at the end of the text, sometimes at the end of the line.

The destructive backspace is slow, shaky, and tenuous, as if it doesn't intend to obey. If you want to change the default and permanently operate in the Insert mode, select another word-processing package. And don't try to tab over if you already have text on-screen.

When changing MultiMate files to ASCII and back again, I saw my copy turned into gibberish. During my investigation, I discovered that although this package lets users insert as many formatting changes as desired into a document, operators can "undent" (indent each line below the first paragraph line) or enumerate paragraphs (automatically number each succeeding section) only by doing it manually. With a package this powerful, why?

Although I understand MultiMate is coming out with an improvement, the spelling checker that came with my version had inherent in it so many gremlins, I never could get it to do anything worthwhile. It caused me nothing but problems.

The manual promotes MultiMate's shadow print, boldfaced, and draft print, but I had problems with these enhancements until a kind voice in the 800 nether-nether land explained that the program has an IBM bug in this area. He gave me detailed instructions as to how to subvert this and eventually I did manage. MultiMate does not do footnotes.

I started out with high hopes for MultiMate, but its disadvantages outweighed its great benefits. Too bad. The program has incredible potential.

FINALWORD—VERSION 1.16

Until recently, FinalWord was almost alone in its ability to index documents. Now there are others that have this capability, including PeachText, Samna,

(continued)

AT A GLANCE

Name

FinalWord 1.16

Type

Word-processing program

Manufacturer

Mark of the Unicorn
222 Third St.
Cambridge, MA 02142
(617) 576-2760

Price

\$300

Format

Two 5¼-inch floppy disks

Language

C (user-configurable but cannot be customized)

Computer

IBM Personal Computer (as reviewed)

Documentation

Hard-cover manual, approximately 300 pages (manual not completed at time of this writing)

Audience

Basic to advanced word-processing users, especially those who need sophisticated features such as the ability to create long documents, tables of contents, and indexes

Edix, and WordStar's StarIndex.

I have used FinalWord for well over a year now, but I haven't even touched its full range of features. Because I use it and rely on it, I have a strong love/hate relationship with it. For my purposes, its talents are exceptional and well worth the massive effort it took to learn it and get through its dozens of eccentricities.

The most recent revision of FinalWord consists of improved documentation, badly needed and a long time coming. Version 1.16's upgrades include the ability to wrap footnotes, produce unlimited end notes, support the new DEC (Digital Equipment Corporation) printers, and create foreign characters on the IBM PC. I prefer less bureaucracy in this program's handling of its swap file and buffer functions.

It's hard to believe, but the operation of this extremely powerful, sophisticated program requires only 64K bytes with DOS 1.1 and 128K bytes with DOS 2.0. FinalWord's capabilities are comparable to or greater than those of the other programs I tested, and the program uses less memory than most of them unless you use its indexing skills, which means you'll have to upgrade in a serious way.

This program's developers promote its safety with a swap file you can put data into and take out of with abandon, and buffers that hold editing changes like little pockets you can stuff with goodies. But because of some flaws in these functions, my experience with FinalWord hasn't been reassuring.

Mark of the Unicorn says it has repaired these irregularities. But since I can't go back and use the "nix fix" in the situation where I lost four days' worth of text (and FinalWord duplicated the tragedy on the backup disk), I can't swear to the perfection of the revised edition or the efficiency of the debug program.

Nevertheless, because of FinalWord's

advanced (by an order of magnitude) formatting talents, I rate it extraordinarily high in performance for users who need to be able to do esoteric formatting chores. I also recommend it for people who produce extremely long and complex documents and need to be able to create indexes and tables of contents.

FINALWORD'S CAPABILITIES

There are many, but I'll start with its versatility in letting users move the cursor from place to place with the Cntrl and arrow keys. I give FinalWord a solid A here. Moving, copying, and deleting blocks of text are tasks this package performs with speed and efficiency.

To its credit, this program isn't copy-protected. Generally speaking, Mark of the Unicorn offers free updates and fairly comprehensive documentation—especially in version 1.16.

It's possible FinalWord was a pioneer with advanced features, such as its Default Insert mode, windows, highlighting, replace functions, and mnemonic commands. Its abilities, too, in the areas of footnoting; headers and footers; "state-save"; use of the IBM function keys; text movement from one file to another while displaying both documents on-screen; and numbering system for pages, blocks of copy, footnotes, and chapters, are greatly appreciated by those who have used them.

Creation of ASCII files, spooling, user-definable keys, optional help screens, and microjustification and proportional spacing on printers that support these features all are important. But its advanced formatting capabilities are the hub around which FinalWord's reputation has been built.

Suppose you want to write poetry or produce a document (or part of one) with automatically numbered paragraphs. Suppose you want to change the formatting style numerous times

within your text. Suppose you want to do some wondrous, aesthetic things with your material. FinalWord provides these and dozens of other advanced formatting functions.

The program lets you automatically underline words and spaces or just text; utilize sub- and superscript characters or boldfaced print; center, double-space, or justify text; set line length and bottom and top margins; alternate page numbers or headers and footers; and cross-reference material. There isn't much in the way of enhanced formatting or printing that FinalWord can't carry out for you.

FINALWORD'S LIABILITIES

There are, however, some basic and elementary tasks that FinalWord's developers have either overlooked or deemed low-priority items.

From my office, Mark of the Unicorn's support number is a local telephone call—fortunately. During my learning curve, I literally spent hours on the phone with the company's technical people. At that time, they were neither knowledgeable nor patient. That situation has improved, but a toll-free number has yet to be instituted.

FinalWord cannot handle columnar material (either text or numbers), horizontal scrolling, automatic hyphenation, or continuous reformatting tasks. Although the program came out ahead in the "scroll to end of document" benchmark, it is terminally slow in its preprinting sequential-paging mode.

You don't see what you get with FinalWord except with its View Screen command, which whips by so fast it's almost worthless. Because this package performs so many advanced functions, not being able to see what you have done (or want to do) is a serious drawback.

FinalWord's most frustrating characteristic is its habit of beeping and putting up error messages at the press of a key. A great deal of the time, too, the machine totally hangs up, either from an incorrect combination of keystrokes or just plain orneriness. Literally hundreds of times, in order to get FinalWord to accomplish a task, I have had to switch off my system, turn to another job, then return later and begin all over again.

FinalWord is a very powerful package.

(continued)

Table 1: Benchmark results for the word-processing programs reviewed. All times are in seconds.

	FinalWord	WordStar	Word	pfs:Write	MultiMate
Load document	11.9	9.9	8.9	9.6	9.3
Save document	71.0	31.66	42.6	20.1	3.9
Search document	10.4	12.43	15.1	13.5	42.1
Scroll to end of document	45.8	30.76	39.0	65.0	104.0

Table 2: An evaluation of features and performance.

Name	FinalWord (Version 1.16)	pfs:Write (Version 1.1)	WordStar (Version 3.32)	MultiMate (Version 3.20)	Word (Version 1.1/2.0)
Price	\$300	\$140	\$495	\$495	\$375; \$475 with mouse
Hardware Configuration	64K, two 5¼-inch single-sided floppy-disk drives or 300K capability and printer	128K, one single-sided drive	64K minimum, two floppy-disk drives recommended, but one drive is practicable if WordStar is already installed	192K with one double-sided drive (DOS 1.1); 256K with two double-sided drives (DOS 2.0/2.1)	128K, one double-sided disk drive (mouse optional)
Maximum Number of Characters Directly Manipulable	varies according to disk size and user-set size of swap file	largest document, 32,000 characters	files up to 8 megabytes, depending on storage capacity	128K in document; each page 6K long	varies according to disk size
Command Structure	control keystrokes organized by three-level menus, user-definable function-key support	menu-driven with function keys	command-driven, but uses function keys	mainly menu-driven with a few keystroke commands	command mode, line-structure oriented
On-line Help?	yes; optional command menus at top of screen accessed by keystroke commands	yes; through function keys and info screens	yes; four levels of help from no help to maximum help (user can specify level)	yes; while editing, hit Shift and F1, and from main menu	yes; 50-page text on-screen Help screens
Longest Line Length	65,535 characters (no horizontal scrolling)	79 columns	256 characters	156 characters	22 inches horizontally and vertically
Use of IBM PC Function Keys	optional; use of Alt, Shift, Cntrl, and assignable keys	extensive	yes; mainly as user-definable macros for WordStar functions	strong use of function keys; combinations of Cntrl, Alt, and Shift (40 options)	minimal; used specifically to jump from window to window and for selection of text
Insertion of Nonprinting ASCII Control Characters?	yes	yes	yes, i.e., phantom spacing	no	yes
Formatting Scheme	both on-screen and embedded command formatting possible	mostly through Define Page and through Type/Edit	through Cntrl commands, formats on screen	mainly format lines placed in document page (text)	on-screen and through style sheets
Print While Editing?	yes	product spools through printer card but not via product itself except file by file	yes	yes; background capabilities	yes; has queuing capability
Change Default Parameters? How?	yes; through menu-driven configuration program	no	yes; through its install program	yes; through menus	yes; via various menus or special key codes
Automatic Formatting Capabilities?	extensive and complex capabilities through embedded commands	yes; in Type/Edit	some; user can change margins	yes; some	alternating headers and footers
Change from Single- to Double-Spacing?	yes; through formatting "style" function	yes; at print time	yes; .DOT commands	yes; by search and replace of format lines	yes; via command menu or Alt key code
Can Text Be Searched for Printing Attributes?	yes	yes	yes	yes	no
Features of Disk-File Format	in 1.16, users have option to use full 8-bit characters covering entire PC character set, or users can stick to 7-bit characters and use the eighth bit for on-screen highlighting	DOS to format disk	n.a.	nonstandard file format with conversion utility to create standard ASCII files	can automatically save files in ASCII format
Reviewer's Assessment	I like this program's features slightly more than I dislike its limitations	I like this program slightly more than I dislike it	I like this program much more than I dislike it	I dislike this program slightly more than I like it	I dislike this program's features more than I like its benefits

Performance BIOS

A low-cost way to improve the performance of your IBM PC.

- Plug-in replacement for the original BIOS ROM.
- Faster floppy disk writes.
- Faster console output.
- ANSI console driver in place of "dumbTTY."
- Serial printer support.
- Auto search for expansion BIOS ROMs.
- And more...

PC Performance Inc.

117 N. First St. • Ann Arbor, MI 48104
(313) 761-9347

BIG TIME STATISTICS GO SMALL

Statpro™ brings the power of mainframe statistics to your personal computer.

Now you can do serious statistical analysis on your IBM® or Apple® PC. Including descriptive statistics, regression, time series, ANOVA and multivariate analysis. What's more, Statpro lets you plot all your results in four-color charts and graphs.



You get all this in one integrated, easy-to-use, fully documented package.

For a Statpro demo, contact your local dealer.

Or Wadsworth Professional Software, Inc., Statler Office Building, 20 Park Plaza, Boston, MA 02116.

800-322-2208
(in Massachusetts, 617-423-0420)



Wadsworth Professional Software

Statpro is a trademark of Wadsworth Professional Software, Inc.
Apple is a registered trademark of Apple Computer, Inc.
IBM is a registered trademark of International Business Machines, Corp.

but it's extremely hard to learn and operate. However, your hefty investment in time and frustration will pay off handsomely, and you'll enjoy its sophisticated subtleties and considerable capabilities.

A ROUNDUP

These five programs appear to balance out in basic benefits and disadvantages. I wouldn't rate any of them unacceptable. Nor would I rate any of them way above the rest.

Particular features I like in WordStar are its compatibility with other programs, its capability to do just about anything you need a word processor to do, and the inherent integrity its developers adhere to in delivering on its promises to the user.

Advantages I appreciate most in pfs: Write include its built-in simplicity and its utility as a basic word-processing program.

Microsoft Word garners some favor because it is paving the way in flexibility. Microsoft's pioneering efforts may be the beginning of a whole different way for people to use word processors. MultiMate rates high in the areas of security and user support (through its toll-free user hotline).

Advanced formatting capabilities distinguish FinalWord. Even with all the recent enhancements to other word-processing programs, FinalWord still ranks high as one of the most able handlers of text-processing tasks.

Certainly, how much an individual likes or dislikes any word processor depends on the application for which it is used. At the moment, there is no ideal or near-ideal word-processing program to be had. As there is no camera that suits the majority of photographers, there probably never will be any software that fills most people's word-processing needs.

Along with many other word-processor users, I believe that some firm could make a serious financial killing were it to delete the disadvantages of these five programs and combine the benefits. My kudos will go to the developer who creates a word processor that has the ease of pfs:Write, the safety of MultiMate, the formatting capabilities of FinalWord, the flexibility of Microsoft Word, and the compatibility of WordStar. ■

DISK DRIVE ANALYSIS PROGRAM

... A UNIQUE APPROACH TO DISK RELIABILITY!

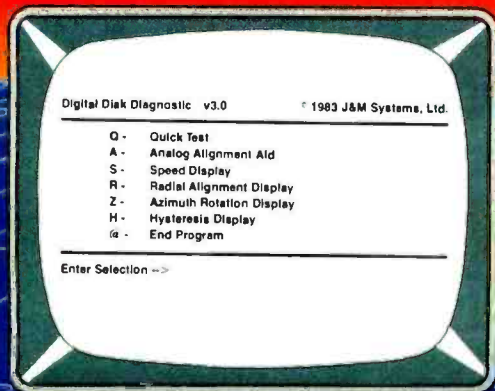

Select any one of seven tests to perform preventive maintenance or to isolate problems. Simple, single-letter commands make DDA easy to use. Use DDA to align the head, or adjust the speed.

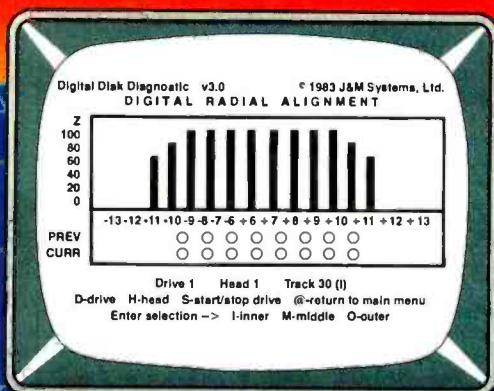

Use the DDA Radial Alignment Test to check the head alignment of your drives. No need for an oscilloscope or other expensive test equipment!

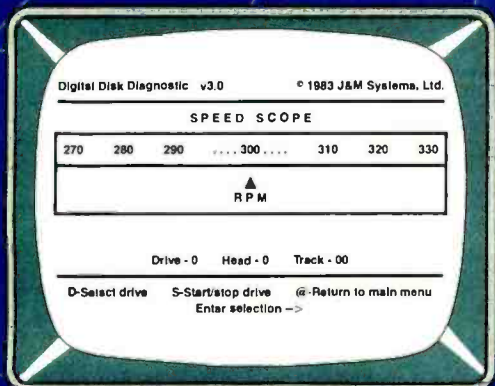

Check the motor speed of your drives. Or, you can even use the Speed Test to adjust the drive speed. No need for any test equipment!

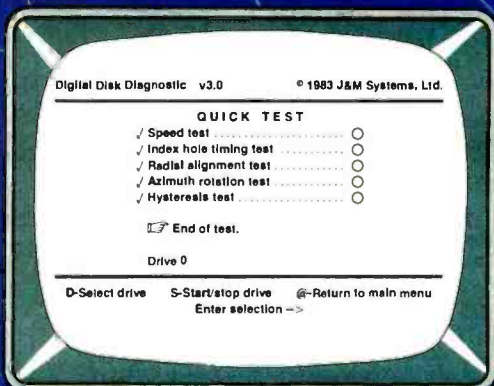

Use the Quick Test to quickly and automatically test five of the most important performance parameters of your drive. Monitor your drives for long term drift. Isolate problems quickly and automatically!

PROTECT YOUR DATA.

Now you can make sure your data is being recorded properly by the use of the revolutionary *Disk Drive Analysis Program*.

The Disk Drive Analysis Program from J & M Systems, tests your disk's performance and calibration without any additional equipment! It measures your disk's performance and displays it on your screen.

This is the most comprehensive disk diagnostic program available for your IBM microcomputer. You can even adjust drive alignment while watching the display!

Spot problems *before* they endanger your data! If you own a disk drive, you *need* the *Disk Drive Analysis Program*!

IBM

1 - 160K Drives	\$79
2 - 320K Drives (Also test 160K drives)	\$99

Price #

DDA also available for other models

J & M SYSTEMS IS THE DRIVING FORCE!



J & M SYSTEMS, LTD.

137 UTAH AVE • ALBUQUERQUE, N.M. 87108 • 505/265-1501

... AS A PC NETWORK MEMBER ONLY!

COMPLETE IBM™ PC SYSTEMS

IBM PC STARTER SYSTEM

IBM PC w/64K

(256K System Board Capacity)

- Floppy Drive Controller
- 2 Double Sided Double Density 320/360K Disk Drives
- Hercules Color Card with Parallel Port
- Zenith ZVM123 High Res Monochrome Monitor

The NETWORK has the perfect starter system for you! The combination of double sided disk drives and a color card enable you to run ANY program—from games and educational software to the most sophisticated business applications.

\$1,940.00* (48.00)

REFLECTS
IBM's
REDUCTION!

IBM PC PROFESSIONAL HARD DISK SYSTEM (XT)

IBM PC w/128K

(256K System Board Capacity)

- 1 Double Sided Double Density 320/360K Disk Drive
- Hercules Color Card with Parallel Port
- Zenith ZV123 High Res Monochrome Monitor

w/Everex Half Height Disk Subsystem:

- Half Height 10Mb Drive Allows Room for Addition of Tape Backup in PC!
- Automatic Hard Disk Boot Feature

This system increases productivity in any business or professional situation. The 10Mb hard disk eliminates cumbersome floppy disk changes, simplifies operations and dramatically speeds program execution time. The NETWORK's buying power provides you with better than XT performance at a price lower than you'd expect to pay for a standard PC.

\$2,675.00* (62.00)

REFLECTS
IBM's
REDUCTION!

*PC Network Members pay just 8% above this wholesale price plus shipping. These prices have been prepared in June, 1984 and may have been changed with new product announcements. Call for latest prices.

Custom Configurations

YOUR SYSTEM EXACTLY AS YOU WANT IT—With the NETWORK'S over 20,000 hardware and software products we can configure a system to your exact specifications ALL AT JUST 8% ABOVE THE DEALER WHOLESALE PRICE! Ask our trained consultants about any drive, monitor, multifunction card or any other component which will meet your unique requirements.

LATEST ISSUE REDUCTIONS!

As the NETWORK's volume grows our prices drop. The following popular products are now available at these new lower prices!

64K MEMORY EXPANSION KITS	\$ 42.75* set
Set of 9 chips Guaranteed for Life	
TANDON TM100-2 DRIVES	168.00* ea.
PANASONIC	275.00* pr.
1/2 Height Disk Drives with Mounting Kit	
AMDEK MONITORS	
V300G Composite Green	110.00*
V300A Composite Amber	120.00*
V310A IBM Amber	130.00*
HERCULES MONOCHROME GRAPHICS CARD	298.00*
HAYES 1200B	299.00*
Without Software	
NEC 3550	1,460.00*
33 CPS Letter Quality Printer	
HAYES SMARTCOM/II	68.00*
Communications Package	
BRAND NAME DISKETTES	20.00*
DS/DD Box of 10 Guaranteed for Life	

*NETWORK members pay just 8% above these wholesale prices plus shipping.

... WITH THESE 15 UNIQUE BENEFITS

1 COST + 8% PRICING—The NETWORK purchases millions of dollars in merchandise each month. You benefit in receiving the lowest price available and all at just 8% above published dealer wholesale price.

2 OUR 400 PAGE WHOLESALE CATALOG—Members receive our 400 page wholesale catalog containing over 20,000 hardware and software products for the IBM PC, APPLE and over 50 other popular computer systems. THE NETWORK'S CATALOG IS THE LARGEST SINGLE COMPILATION OF PERSONAL COMPUTER PRODUCTS AVAILABLE TODAY.

3 EXPERIENCED CONSULTANTS—The NETWORK hires consultants, not order takers, to aid you in product selection. Our consulting staff possess' in excess of 150 man years of personal computer product experience. **We back our consultants with our money back guarantee: IF ANY PRODUCT RECOMMENDED BY OUR CONSULTING STAFF FAILS TO PERFORM AS PROMISED—OR IS INCOMPATIBLE WITH YOUR SYSTEM—WE WILL TAKE IT BACK AT OUR EXPENSE FOR A 100% REFUND.**

4 IN-STOCK INSURED FAST HOME DELIVERY—The NETWORK maintains a giant multi-million dollar inventory of most popular products, allowing us to ship many orders from stock. Non-stock items are typically maintained in local warehouses just days away from The NETWORK and YOU. We pay all insurance expenses on your shipment. EMERGENCY OVERNIGHT SERVICE IS AVAILABLE ON REQUEST.

5 FREE TECHNICAL SUPPORT—The NETWORK supports every product it sells. We maintain a qualified TECH-SUPPORT staff to help you assemble your system, interpret vendor documentation and get your software and hardware to work. **WE WILL GIVE YOU ALL THE HELP YOU NEED, WHEN YOU NEED IT—FREE!**

6 OPTIONAL BUSINESS RENTAL LIBRARY—All members can join our BUSINESS RENTAL LIBRARY for just \$25 PER YEAR above the base membership fee. This entitles you to rent business software AT JUST 20% OF THE DISCOUNTED PRICE FOR A 12 DAY PERIOD. If you decide to keep the software, the entire rental fee is deducted from the purchase price. **VIP MEMBERS GET A FULL 21 DAYS for just \$30 above the V.I.P. base fee. This also includes the game library privileges for a \$5 combination savings.**

7 OPTIONAL GAME SOFTWARE RENTAL LIBRARY—The Game Rental library is available to members for just \$10 PER YEAR and permits evaluation (or just enjoyment) of any game or educational software product as above.

8 SPECIAL SAVINGS BULLETINS—THE PRINTOUT—The NETWORK seeks every opportunity to save money for its members. We buy excess dealer inventories, and store bankruptcy closeouts regularly. We then turn around and make this merchandise (only top quality name brand products) available to our members at fantastic savings via THE PRINTOUT, our newsletter and savings bulletins.

9 DISCOUNT BOOK LIBRARY—Working with numerous publishers and distributors, The NETWORK has assembled a library of over 1000 computer related books and manuals at savings of up to 75% from the normal store price.

10 MEMBERSHIP REFERRAL BONUS—Our most valuable source of new members is you! To date almost 40% of our members have been referred by word of mouth from other satisfied members. For those of you who refer new members, The NETWORK will credit a cash bonus to your account applicable to any future purchase.

11 CORPORATE ACCOUNT PROGRAM—Almost 50% of The NETWORK's members are corporate buyers and users (see opposite page left). The NETWORK can establish open accounts and assign designated account managers to expedite orders, and coordinate multiple location shipments.

12 QUANTITY DISCOUNTS—For large corporations, clubs, and repeat or quantity buyers The NETWORK can extend additional single order discounts, when available to us from our manufacturers and distributors.

13 PRICE PROTECTION—The PC Industry is crazy!! Prices change not yearly or monthly or even weekly but often day by day! These changes are sometimes up but are mostly down!!! **THE NETWORK GUARANTEES THAT IN THE EVENT OF A PRODUCT PRICE REDUCTION, BETWEEN THE TIME YOU PLACE YOUR ORDER AND THE TIME THE PRODUCT SHIPS YOU WILL ONLY PAY THE LOWER AMOUNT!!** And remember, for Clients who pay by Credit Card, we never charge your card until the product ships.

14 MEMBERSHIP SATISFACTION GUARANTEE—If for any reason you are not satisfied with your membership within 30 days, we will refund your dues IN FULL.

15 PRODUCT SATISFACTION GUARANTEE—If you are not satisfied, for any reason with any hardware component purchased from The NETWORK within 10 days of receipt, we will refund your entire purchase (less shipping) with no questions asked.

CALL TOLL FREE **1-800-621-S-A-V-E** (orders and memberships)
In Illinois call (312) 280-0002 validation code 392 only

Make Stat Magic

Statistics, reports and plots happen magically with SPSS/PC™ —the Statistical Package for IBM PC/XTs.*

SPSS/PC is the most comprehensive statistical package for performing simple or complex tasks, regardless of data size. It maintains feature and language compatibility with mainframe SPSS, while optimizing for the PC environment.

Statistics range from simple descriptive to complex multivariate, including Multiple Regression, ANOVA, Factor and Cluster analysis. Loglinear and nonparametric procedures are also included.

Simple facilities allow transfer of files between

SPSS/PC and programs like Lotus 1-2-3, dBase II and SAS. A complete Report Writer, Plotting facilities and a Communications program for mainframes round out a fully integrated product.

For more information, contact our Marketing Department without further ado. And see what a little stat magic can do for you.

SPSS Inc., 444 N. Michigan Avenue,
Chicago, IL 60611, 312/329-2400.

In Europe: SPSS Benelux B.V.,
P.O. Box 115, 4200 AC Gorinchem,
The Netherlands, Phone: + 31183036711
TWX: 21019.



SPSS inc. PRODUCTIVITY RAISED TO THE HIGHEST POWER™

*SPSS/PC runs on the IBM PC/XT with 320K memory and a hard disk. An 8087 co-processor is recommended. Contact SPSS Inc. for other compatible computers.

IBM PC/XT is a trademark of International Business Machines Corporation. dBase II is a trademark of Ashton-Tate. 1-2-3 is a trademark of Lotus Development Corporation. SAS is a trademark of SAS Institute, Inc. SPSS and SPSS/PC are trademarks of SPSS Inc. for its proprietary computer software.

© Copyright 1984. SPSS Inc.

UPDATE ON SIX DATABASE MANAGERS

A comparison of six popular DBMSs for the IBM PC



ILLUSTRATION BY JACQUELINE CHWAST

BY DAVID KRUGLINSKI

In 1981, no more than half a dozen software packages purported to be database management systems (DBMSs). Most of these ran under CP/M, then considered to be the universal standard for microcomputer operating systems. Then came the IBM PC, a pathetic little thing at first, with one single-sided disk drive, 64K bytes of memory, a weird keyboard, and no printer port. BASIC and a slow version of WordStar were the only software available. "This is a waste," I thought. "I'll stick to my CP/M machines."

Now, just three years later, the old machines are out the door, and I am contemplating getting a *second* hard-disk PC. Why the switch? Recently, one magazine's annual software review listed 115 DBMSs (surely there are 150 by now),

all running on the IBM PC and compatible machines. Each DBMS has its own personality, however, and the one you choose should match both the job to be done and your staff's skills. Because DBMS projects can require a few hours or several person-years, choosing the wrong program can be very expensive. Therefore, the more you know about DBMSs, the better equipped you will be to choose the right software for your data-management task.

This article describes six popular DBMS packages in three categories. Pfs: file/pfs:report and C.I.P. fall into the "entry-level" class, requiring minimum

(continued)

David Kruglinski is president of Tenon Software (1910 Fairview East, Seattle, WA 98102).

skills and expense. Condor 3 and R:base 4000 are "programmerless" DBMSs with more power than the first group. dBASE II and KnowledgeMan are complete programming environments that require a skilled programmer for setup, but permit clerical workers to do data entry and retrieval.

COMMON DBMS FEATURES

Any DBMS application could be programmed from scratch. DBMS software just makes development easier and faster, and it makes the resulting system

more flexible and expandable.

The DBMS's window to the world is the PC's screen. Figure 1 shows how the owner of a computer bookstore would set up the screen for an inventory system. Each title is represented by one record, and the information within the record is represented by fields such as PUBLISHER and CATALOG.NUMBER. All the records for all the titles are known collectively as a file. A group of files forms a database. Some DBMS publishers use different terms, but the concepts are the same. The list of all

fields in a record, along with their names and characteristics, is known as the data dictionary (table 1). The data dictionary contains more information than is apparent from looking at the screen.

Once you have defined the screen and data dictionary, you can enter, view, and update data on the screen, as shown in figure 2. You can also print a report, either to the screen or to the printer, as shown in table 2. The DBMS allows you to select the fields to be printed, the records to be printed, and the sort order. You could, for example, print only those titles with a retail price over \$10.

Both reporting and screen viewing can be classified as a query—a question about the data in the file. The report is an example of tabular query output. If the useful data in a record exceeds 80 or 132 columns, then a full-screen query is necessary. You could, for instance, ask to see books costing more than \$10, then have the DBMS display those records one screen at a time.

Basically, this is how all DBMSs work. You build the screen and data dictionary, enter the data, and print the reports.

DIFFERENCES AMONG DBMSs

Despite the similarities among DBMSs, each system has a unique set of capabilities. Here are some ways in which they differ.

Limitations. Some DBMSs impose severe restrictions on field length, record length, and number of fields per record. These limitations are obvious from the specifications outlined in table

—Book Inventory Record—

PUBLISHER ___	CATALOG.NUMBER ___
TITLE _____	REORDER.POINT ___
RETAIL.PRICE ___	YTD.QUANTITY.SOLD ___
QUANTITY.ON.HAND ___	QUANTITY.SOLD ___
SALES.DOLLARS ____	

Figure 1: Setting up a DBMS input screen.

Table 1: A typical DBMS data dictionary.

Field	Type	Length	Low Limit	High Limit
PUBLISHER:	Alphanumeric	3 chars		
CATALOG.NUMBER:	Numeric	4 digits	0	9999
TITLE:	Alphanumeric	30 chars		
RETAIL.PRICE:	Dollars	5 places	0.00	99.99
REORDER.POINT:	Numeric	4 digits	0	9999
QUANTITY.ON.HAND:	Numeric	4 digits	0	9999
YTD.QUANTITY.SOLD:	Numeric	5 digits	0	99999
SALES.DOLLARS:	Dollars	8 places	0.00	99999.99
QUANTITY.SOLD:	Numeric	4 digits	0	9999

Systems Reviewed

dBASE II
 Ashton-Tate
 10150 W. Jefferson Blvd.
 Culver City, CA 90230
 (800) 437-4329
 (213) 204-5570

Condor 3
 Condor Computer Corporation
 2051 S. State St.
 Ann Arbor, MI 48104
 (313) 769-3988

C.I.P.
 Concentric Data Systems Inc.
 18 Lyman St.
 Westboro, MA 01581
 (800) 325-9035
 (617) 366-1122

KnowledgeMan
 Micro Data Base Systems Inc.
 POB 248
 Lafayette, IN 47902
 (317) 463-2581

pfs:file/pfs:report
 Software Publishing Corp.
 1901 Landings Dr.
 Mountain View, CA 94043
 (415) 962-8910

R:base 4000
 Microrim Inc.
 3380 146th Pl., SE
 Bellevue, WA 98007
 (206) 641-6619

3. If you need 60-character product descriptions and a DBMS allows only 50 characters per record, you can eliminate that program.

Single vs. multifile. Suppose you have a file of company addresses and a file of product descriptions, one field of which contains the company name. A single-file DBMS lets you view and list the companies, then it lets you view and list the products. A multifile DBMS allows you to associate the two files based on company name. When the program needs the company name in the product file, it then goes to the company file to find its address. You can then print a list of products with company addresses. Despite this advantage, multifile DBMSs are more expensive and more difficult to learn than single-file systems. Remember that single-file programs cover a surprisingly large range of applications, so it might be easier and cheaper for you to combine

the company and product information in one file, even though it means duplicating addresses of companies offering more than one product.

One group of multifile DBMSs are referred to as relational systems. This means that files, known as relations, conform to a mathematical model so that certain relational operations can take place. This is a kind of electronic cut-and-paste allowing new relations to be created from existing relations. For example, if a company name is joined with a product name, the resulting relation contains a record for each company-product combination. Some relational DBMSs create a new physical file for each operation; others create a virtual file, thereby saving disk space and reducing redundancy.

Screen design. Each DBMS uses a different method for screen design. Sometimes you design the screen before the data dictionary, and some-

times you design the data dictionary first. Most packages let you design the screen as though you were using a word processor.

Query method. Here you find the biggest difference among DBMS products. Early DBMSs developed their own *ad hoc* query languages. For example, you could type

```
LIST CATALOG.NO, TITLE, PRICE
WHERE PRICE > 10 SORTED BY
CATALOG.NO.
```

This adapts to both tabular queries and full-screen queries. Query languages have been formalized by an IBM-developed standard called SQL (structured query language). SQL allows queries on multiple files, and it allows for subtotals and page headings. SQL and most other query "languages" require you to know the exact names of the fields and relations in the database.

Another query method, QBE (query by example), also comes from the IBM mainframe world. This is a wonderfully easy to use and useful system; unfortunately, it is not included in many DBMSs. Figure 3 shows an example. A real estate agent has asked to see all Sunnyvale listings with three or more bedrooms and costing less than \$130,000. The agent can run through the retrieved listings, using the same screen used for entering and updating those records. With a QBE system, you just move through the screen, filling in the blanks with conditions, all of which must be met for the selection to be displayed.

A new query method depends on advances in AI (artificial intelligence). The query language is English (or, presumably, French if you live in France), resulting in sentences like

LIST THE SALESPeOPLE AND
THEIR SALARIES

followed by

JUST THE ONES IN CALIFORNIA

An AI query language can handle multiple files and can look at the data within those files to make sense out of inquiries. The system will ask questions about words it does not understand and

(continued)

—Book Inventory Record—	
PUBLISHER BYT	CATALOG.NUMBER 960
TITLE Ciarcia's Circuit Cellar	REORDER.POINT 50
RETAIL.PRICE 8.00	
QUANTITY.ON.HAND 25	YTD.QUANTITY.SOLD 30
SALES.DOLLARS 240.00	QUANTITY.SOLD 15

Option: Revise (R), Delete (D), No Change (N), End (E) (save as shown)

Figure 2: Editing data using a formatted screen.

Table 2: A typical DBMS report or tabular query.

04/15/82 COMPUTER BOOK PRICE LIST Page 1			
PUBLISHER	CATALOG.NUMBER	TITLE	RETAIL.PRICE
BYT	960	Ciarcia's Circuit Cellar	8.00
BYT	1040	Layman's Guide to SBC's	10.00
BYT	4925	You Just Bought a Personal What	11.95
BYT	6745	Beginner's Gde to UCSD Pascal	11.95
BYT	8360	Threaded Interpreted Languages	18.95
OSB	1988	PET/CBM Personal Computer Guide	15.00
OSB	8806	Some Common BASIC Programs	14.99
OSB	8821	Z80 Assembly Language Prmgng	16.99
OSB	8828	Running Wild	3.95
OSB	8844	CP/M User Guide	12.99
OSB	8847	Business Systems Buyers Guide	15.00

remember the answers for later queries. AI is very new and has not been proved in the marketplace. The major question concerning the use of AI is whether queries can be phrased precisely enough.

Ease of Change. If you are just start-

ing a new DBMS application, you will make mistakes. For instance, you might allow five numeric digits for a zip code, then be faced with a Canadian address containing a six-letter postal code. You must be able to restructure the file, changing the field characteristics and

length, but preserving the already-entered data.

Report Generator. A query language produces tabular lists, but it does not exercise enough control over the output format. Most DBMSs have a special module for producing fancy reports with page headings, group headings, subtotals, computed fields, and page footings. Some DBMSs allow you to lay out the report on the screen, using horizontal scrolling for 132-column reports. Others have a special language to describe the report format.

Import/Export. If you are starting a DBMS system, you might need to use data from an existing program. The DBMS should allow input of a variety of data formats produced by BASIC and COBOL programs and other DBMSs. It is also becoming more and more important to transfer data to (export) and from (import) spreadsheets and word processors. Common formats are delimited ASCII (BASIC), fielded ASCII (COBOL), DIF (VisiCalc, Lotus 1-2-3), and SYLK (Multiplan).

```

QUERY: ESC executes. CTRL C aborts.
      F10 clears all. F1 for help.
** I: listings file**

listing number: |   |
address:        |   | listed: |   |
city: |Sunnyvale | sold: |   |

footage        bedrooms  baths  lotsize  corner  schools
|              |>=3    |      |      |      |
asking price:  |<130000 |      | sale price: |
listing notes: |              |      |
              |              |      |
listing agent: |              | agent number: 0
address:
city:
phone:
              zip:
              salary: $0.00
              rating:
    
```

Figure 3: A query-by-example (QBE) screen.

Table 3: DBMS benchmarks for performance.

Version	Condor 3 2.11	dBASE II 2.4A	R:base 4000 1.10	KnowledgeMan 1.06	C.I.P 1A	pfs:file pfs:report
Sort time	18 min	2 hr. 15 min	25 min	27 min		
Sequential pass (using index)	1 min. 16 sec	1 min. 39 sec	1 min. 30 sec	4 min. 30 sec		
Index build	1 hr. 3 min	12 min. 16 sec		14 min. 27 sec	35 min	
Join (using index)	1 min. 40 sec	31 min	16 min	8 min	1 hr. 5 min	
Query method	SELECT command	7 min. 30 sec	5 min. 34 sec	12 sec	26 min	
Report generator	80-column screen-oriented	LIST command	artificial intelligence	QRS multifile	menu	QBE
Passwords	no	REPQRT command + program mode	132-column screen oriented	QRS + program mode	menu	QBE select column def
Special features	POST for accounting transactions	no	file	file + field	132-column	no
Export/import files	delimited. fixed	screen painter	flexible "rules" for data entry	spreadsheet	no	keyword search
Change field length	delimited. fixed	training disks	DIF, SYLK delimited	DIF. delimited	DIF. delimited	ASCII out
Copy protect	difficult	delimited. fixed (DIF w/program)	80 characters	easy	pfs in	easy
Max records/file	unload/reload	moderate	difficult	easy	easy	easy
Max characters/record	no	APPEND command	unload/reload	REDEFINE command	yes	yes
Max fields/record	no	no	no	no	yes	yes
Max characters/field	65534	65535	unlimited	65535	65000	
Numeric digits	1024	1000	1530	65535	2000	
Date field	127	32	400	255	40	
Memory requirements	127	254	1500	65535	50	
List price	10/18	10	9/16	14	12	
	yes	no	yes	no	yes	
	64K/128K	128K	256K	192K	128K/192K	64K/128K
	\$650	\$495	\$495	\$500	\$395	\$140 pfs:file
			\$195 CLOUT	\$100 kpaint		\$125 pfs:report
			\$150 xtended report	\$225 kgraph		

Copy Protection. If you use a hard disk, you will be irritated by copy-protection schemes that make you load a special floppy disk for each protected program you run. Ironically, the most expensive DBMS programs are the least likely to be copy protected.

Password Protection. The newer DBMSs provide ways to protect individual files and even fields from unauthorized access and update. This feature is especially useful with hard disks.

Special Features. Some DBMSs have unique features such as built-in spreadsheets and training aids. Help screens, once rare, are now commonplace.

PERFORMANCE

As you would expect, DBMSs vary widely in performance. Table 3 presents some benchmark data for five of the six DBMSs. The main test file contained 5011 115-character records, and the secondary file contained 6233 27-character records. The benchmarks, run on a hard disk, involved sorting, indexing, and searching the main file and joining six main-file records with the secondary file. Pfs:file was excluded because it does not allow data import.

To understand the performance differences, you must understand indexes. An index is a disk-based data structure that allows quick access to a particular record in a file. If there is no index file, the DBMS must do a sequential pass to find the records for which you are looking. This is not as bad as it sounds, because sequential passes are very fast. For small files, it is sometimes better to forgo indexes because of the extra problems they create.

What is a "small file," and what problems do indexes create? A disk holds 360K bytes. Because there must be room for sorting and reorganizing, the largest practical file size is half a disk, or 180K bytes. Most DBMSs can sequentially search a floppy-disk-based 180K-byte file in a little more than a minute. If you can wait a minute, then 180K bytes is a small file. Indexed files provide instantaneous access if the query is made on a key field—one previously set up to be indexed. If a query is made on a nonkey field, it could take much longer than if the file were not indexed. You could index all the fields, but adding records would be slower. Also, some DBMSs do not allow you to

change the value of a key field. As a rule of thumb, don't use indexes unless you really need fast access.

Another choice you will have to make is whether to use a hard or a floppy disk. If you are really serious about data management for business, you will need a hard disk. Careful shopping can get you a complete IBM-compatible system with a 10-megabyte hard disk for less than \$3000. That's less than 8-bit floppy-disk-based systems cost in 1980. A hard disk will appear to run three times faster than a floppy disk, and it holds 30 times as much data. A hard disk also eliminates disk swapping and increases all-around dependability. All DBMSs do run with floppy disks, though, which gives you a chance to get started before committing to more expensive hardware.

Very few DBMSs do a proper job with deleted records. In most cases, if you delete a record, you will not be able to recover that disk space unless you perform a time-consuming reorganization. Reorganization time goes up with the number of indexes you use, and it is possible to get yourself into a jam if you do not have enough disk space to reorganize. Usually, if you delete a whole file, you can get the space back without reorganizing.

PFS:FILE/PFS:REPORT

Pfs:file from Software Publishing lets you do data entry and update, screen-oriented queries, and printed mailing labels, while pfs:report is necessary for tabular reports. They are generally used as a pair. What accounts for the spectacular success of these products? Probably because they're easy to use with the QBE query format.

Pfs:file combines data-dictionary definition and screen layout in one step. You simply move the cursor as necessary to type in a form. The tags become the field names. All the space between the tags is available for data entry, meaning that the program supports variable-length fields and records. In other words, you use only the disk space you need. For instance, "Reno" requires four characters, and "San Francisco" requires 13, so Reno will take up less space on the disk. You must, however, allow at least enough space for 13 characters on the form.

You can have several screens per record, and the last screen carries the label "ATTACHMENT" at the top left, allowing you to enter a full screen of text in a pseudo-word-processing mode with automatic word-wrap. If you insert

(continued)



Photo 1: PFS/File lets you enter data, update, and print mailing labels.

and delete words, you cannot expect the lower lines to be adjusted.

Pfs:report lets you define reports in a two-step process. First, a QBE select screen determines which records you will print. You use the same screen to specify which fields you will print and in what order. The program allows for headings, totals, subtotals, averages, counts, and page breaks. You must be careful with numeric data because pfs:file does not enforce numeric data entry. If you type "frog," the program converts the letters to a number and adds them into your total.

One special feature is the keyword field, which enables you to print multiple records for each individual word contained in that field. You could enter article abstracts, storing sequences of keywords in the first field. Then you could print a list of abstracts sorted by keyword.

The pfs products automatically index the first field of the record. Queries based on this field are instantaneous, but queries based on other fields are slower, depending on how deep the field is in the form. Deleted record space does appear to be reused. Both pfs:file and pfs:report are single-file systems, processing one file at a time and allowing no interaction between files. Reorganization is easy. All you have to do is keep the same tag names so that data in the new file comes across from the old. There is no provision for data import. Pfs:report does print to disk, however, allowing export to programs that can read fielded ASCII. Even though the disks are copy-protected, the programs do not require access to original disks after they are loaded to the hard disk.

You should use the pfs products if you want ease of use and if you don't mind waiting a minute or so to extract data from a large disk file. If you have very small disk files, you won't even notice the wait.

C.I.P: THE PUSH-BUTTON DBMS

C.I.P (Concentric Information Processor) from Concentric Data Systems is another single-file system that is easy to use and "visual." Because of the screen setup, a first-time user can be up and running in a matter of minutes. To choose from the menu, you just type

the first letter of the item or use the cursor keys.

File definition begins with the data dictionary, which allows you to specify the following:

- Length or "shape" of the fields
- Automatic field completion without Return key
- Field calculated from other fields
- Date
- Field must be full
- Key designation
- Numeric
- Required entry
- Key is unique
- Number of decimal places

You can then rearrange the data dictionary into a data-entry screen. This is a rather nifty visual process in which you drag field names and shapes around the screen à la Macintosh. Shapes are indicated by caterpillar-like strings of squares corresponding to field length.

C.I.P uses indexes and demands that at least one field be a key field. The trouble is that you can make full-screen queries only by using key fields. That means that you will have to do most of your querying via the report generator, which generates screen images that scroll up the screen instead of appear-

ing one at a time.

C.I.P handles report layouts the same way it handles screen layouts. You lay out the field shapes, headings, subtotal lines, and total lines on a scrolling 132-column screen. You have good control over numeric and data formatting, and you can highlight and right or left justify text. Since there is no query language as such, you must enter all record-selection criteria via the menu. This is awkward, but at least it is fool-proof. Wild-card matching is allowed, and you can select and sort reports by nonkey fields.

C.I.P's performance is a little disappointing. The six hours required to load the main test file did not bode well. C.I.P is, however, one of the few DBMSs that properly handle record deletions for indexed files. It uses a peculiar file structure that combines the indexes with the data and seems to do some compression. File sizes were smaller than I predicted by multiplying record quantity by record length.

Plan to use C.I.P when you need high-speed keyed access with frequent additions and deletions. The index system gives you quick access to ranges of key values. For instance, if you asked for "GREEN*," you would get all the last names beginning with GREEN, includ-



Photo 2: A first-time user can have C.I.P running in a matter of minutes.

ing GREENMAN, GREENWOOD, and so on. There is no need for a complete sequential pass here. Do not use C.I.P if you make frequent unstructured queries against nonkey fields.

CONDOR 3

Condor 3 has been around since the dawn of the microcomputer age, but it gets little recognition, even though DEC and Hewlett-Packard have endorsed it and it comes with the Seequa Chameleon. It is a stable, bug-free product whose performance specs are better than those of most of its competitors.

Condor is a full-blown relational DBMS designed to be set up and operated by nonprogrammers. The file-definition process starts with a screen that prompts you to define your field names. After you have "painted" the screen with the field names, Condor asks you for data-dictionary specifics that include field type (alpha, numeric, dollars, date), length, low limit, high limit, and default string. You can have only one screen per file, but the easy setup makes up for this restriction.

All of Condor's queries are two-step processes. First, in the SELECT process, you apply the record-selection criteria to create a new, temporary file. You can then list the new file, called RESULT, in

tabular form with specified fields, or you can view it in full-screen mode. You can either save the RESULT file or overwrite it with the next SELECT file. The UPDATE command allows you to edit a "live" file in full-screen mode.

The program also includes standard relational operators such as JOIN and PROJECT, and a COMPARE operator can subtract files. The POST operator totals transactions, adding them to a field in a master file or replacing an existing value there. This enables Condor to do accounting as well as information retrieval.

Condor allows command batch files, but the only commands available operate on entire files (relations). A batch file can request a variable from the keyboard and can set up a SELECT/LIST command pair, thereby automating queries.

One index per file is allowed, and you can create this index from a combination of several fields. The SELECT and UPDATE commands use this index automatically to reduce sequential passes through the file. For instance, you could quickly select all company names beginning with "Computer" with the command

```
SELECT COMPFILE WHERE NAME IS
COMPUTER*
```

Until recently, Condor was strictly command-driven; in other words, you had to know the commands.

The asterisk is a wild card as used in PC-DOS. The indexing scheme does not let you change the key fields, and you cannot recover space from deleted records. If a file is indexed, queries by another key result in a fast sequential scan, not a slow indexed scan. You can shuffle a file by adding, deleting, and rearranging fields, and the screen layout can be conveniently changed. It is more difficult, however, to change field lengths. To do so, you must unload the file to an ASCII file, change the data dictionary, and reload the file.

Condor's report generator is quite sophisticated. You can use all the usual subtotals, page headings, and so on. The report is laid out on the screen as it will appear on paper, but there is no horizontal scrolling to permit design of wide reports. Long report lines will wrap around to the next screen line.

Until recently, Condor was strictly command driven—in other words, you had to know the commands. A new version provides optional menus that steer you toward the right command and help you set up the command once you get there. This is a great training aid, but you can disable it once you become proficient.

R:BASE 4000

Microrim, a start-up company with lots of venture capital, is flooding the computer press with two- and four-page ads for its R:base 4000 relational DBMS. The ads compare R:base with dBASE II, but in reality, R:base is closer to Condor 3. Like Condor, R:base's commands are designed to operate on entire relations.

R:base makes you define the data dictionary before you design screens, and this approach makes sense. First you define the fields, called "attributes," for all the relations in the database, then you

(continued)



Photo 3: With R:base, you define the fields called attributes for all relations in the database.

group these into the proper relations. One attribute might occur in several relations, implying a link between those relations.

You then define the screens, called "forms." Each relation can have several forms. Querying is via the SELECT command, which follows the SQL format except that it does not permit multifile queries. You must use the JOIN command or one of R:base's unique relational operators—INTERSECT, UNION, or SUBTRACT. In any case, you must know all the attribute names.

The report generator is somewhat elementary, but Microrim is preparing a new add-on report module that will do subtotals and draw data from several relations. Speaking of add-on modules, the CLOUT query module is really something special. It accepts English-language queries by extracting data from multiple files.

Suppose you have an employee relation and one field in that file is a branch code. A second relation associates branch code with city name. If you ask CLOUT

WHO'S IN CHICAGO

the program searches all relations for instances of "CHICAGO," then works backward to answer your question. If it finds "CHICAGO" in the branch relation, it matches the branch code to employee, knowing by predefinition that "WHO'S" means "LIST EMPLOYEES." If you had another relation listing rock groups, CLOUT would have asked

Do you mean CHICAGO the City or the Rock Group?

R:base stores the data for all database relations in one PC-DOS disk file. This is good because it follows the original database concept of one integrated store of data. A problem occurs, however, when a relation is deleted, which frequently happens to the results of the JOIN and other operators. The disk space is not recovered. You must perform a complete reorganization, including rebuilding all the indexes for all the relations. You must go through this time-consuming process frequently to prevent disks from filling up. Be sure you have enough free space available before starting.

R:base's index structure is not the familiar B*-tree, but a simpler form that does not permit indexed-sequential processing. This means that a sort must precede every report. The sort does not eat up any permanent disk space, but it does take time.

Version 1.1 of R:base has added variables, IF statements, and WHILE con-

structs to the command file language. It is possible to generate accounting applications programs, but that is a misuse of R:base. One developer invested more than 100 hours in a simple after-the-fact payroll system and was thoroughly frustrated.

R:base offers new users lots of help. For example, entering

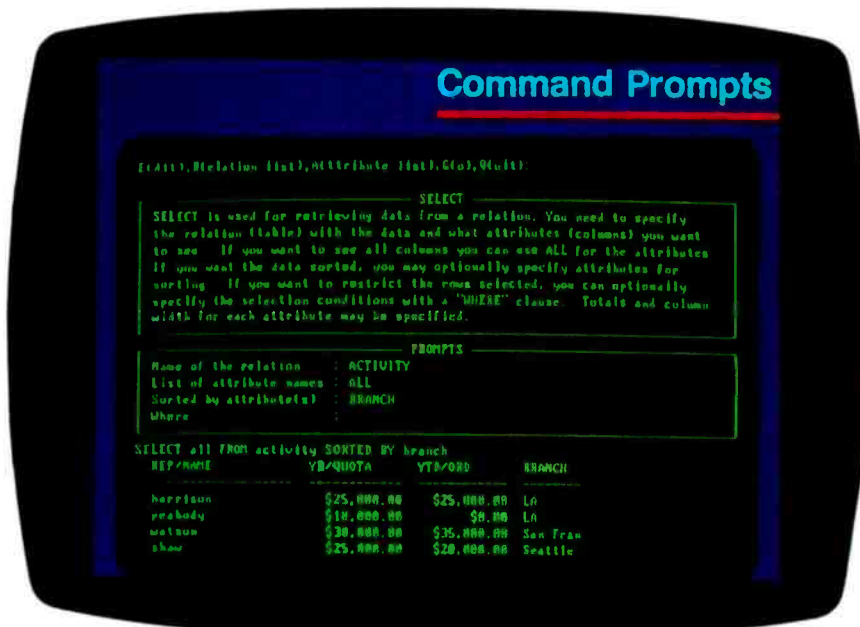

Photo 4: R:base querying is done through the SELECT Command.



Photo 5: KnowledgeMan from Micro Data Base Systems has a built-in spreadsheet.

DATABASE MANAGEMENT SYSTEMS

*Finding out about
Ashton-Tate's
dBASE II is simple.
At least half a
dozen books are
dedicated to it.*

HELP command

tells you everything you need to know about that command. In addition, a Prompt mode guides you through each command. Unfortunately, you do not always know what to do next because the global HELP command lists only R:base's available commands.

Changing the size of a field is really tricky. You must unload the whole relation to an ASCII file, delete the entire relation with all its attributes, key in all the attributes again, and reload the file. The program's alternate method is not any easier.

THE STANDARD BY WHICH OTHERS ARE JUDGED

Finding out about Ashton-Tate's dBASE II is simple. At least half a dozen books and several computer magazine issues have been dedicated to the subject. Classes and seminars on the program are also available. dBASE is really more of a programming environment than a DBMS. Of course, the DBMS elements are there, but the product has been successful because of its flexibility in developing computer applications. dBASE is distributed with a catalog listing hundreds of applications ranging from a \$75 personal credit-card register to a \$21,000 vending machine operator's management system.

Experienced dBASE users like the product because of the control it gives them over their data. In the Development mode, there is a direct link between keyboard, screen, and disk. You can create and rearrange files quickly and easily, and you can import and export ASCII files more rapidly than with any other product.

The dBASE programming language can operate on individual records in

several files at once, and it can control the screen, permitting full-screen cursor movement for data entry and editing. All this takes skill, but experienced dBASE programmers abound.

Even so, I have a few complaints about the program. Working with more than two files at once is awkward, and the 32-field-per-record limit is restrictive. You cannot recover space for deleted records, but multiple indexes are maintained through additions, deletions, and key-field updates. A major problem is the time required to rebuild an index after you have purged deleted records. One person reported a 20-hour rebuild time for a large file.

dBASE file definition starts with the data dictionary. If you do not make any changes, you end up with an ugly one-line-per-field default data-entry screen. To generate a nice screen, you must lay it out on grid paper, then code a succession of GET, SAY statements referencing the proper coordinates. An alternative is to use a stand-alone utility program provided by Ashton-Tate. This generates code that you incorporate into your programs.

Ashton-Tate also provides a set of dBASE lessons on disk. These are reported to be useful and might be an alternative to an expensive seminar.

A BETTER dBASE?

KnowledgeMan, alias Knowledge Manager and KMAN, comes from Micro Data Base Systems, author of the MDBS III extended-network DBMS. One might have expected an end-user version of MDBS III from Micro Data Base Systems, but the marketing department must have targeted Ashton-Tate's market as the most lucrative. The resulting product is not related to MDBS III at all, but is clearly intended to be a dBASE substitute.

A dBASE programmer would feel quite at home with KnowledgeMan. There have even been rumors of a dBASE-to-KnowledgeMan translator, which would swallow dBASE code and spit out KnowledgeMan code. KnowledgeMan has eliminated many of the frustrating dBASE restrictions. For instance, KnowledgeMan allows 255 fields per record versus dBASE's 32, and any number of files can be open at once, whereas dBASE allows only two. Knowl-

SQUEEZED FOR SLOTS?



- Six expansion slots plus power supply
- Brings system total to ten slots
- No special addressing, part of PC I/O bus
- Compatible with all PC expansion cards
- No noise—no fan

An expansion chassis is a must for anyone who needs to go behind the PC's minimum configuration. Simply plug the I-Bus Six-Pac Expansion Chassis into one slot of your PC—and you've doubled your expansion slots from five to a total of ten. There's no special addressing or software required. Cards plugged into the Six-Pac perform exactly as if they were in the main system unit.

And there's plenty of power, too, because chances are your PC will run out of power before it runs out of slots. The Six-Pac's 40W supply quietly powers its own slots, with negligible power drawn from the PC.

It's only \$795, including 18" shielded interface cable (or \$835 with a four-foot cable). Call us today for all the details.

Call toll free:

(800) 382-4229

in California call (619) 569-0646

The I-Bus Six-Pac Expansion Chassis

I-BUS
SYSTEMS

9235 Chesapeake Drive
San Diego, CA 92123

KnowledgeMan lets you write a program that sets up a spreadsheet and references cells directly through variables such as "#a1" (row 1, column a).

edgeMan adds a built-in spreadsheet plus optional integrated screen-painting and graphing utilities. Trig functions, nestable macros, DIF file import/export, and other useful tools have also been added.

KnowledgeMan's SQL query system is powerful but not efficient. Here's a sample two-file query that matches shareholders (SHARE relation) with multiple stock certificates (CERTIF relation) based on the common field SHNUMBER.

```
SELECT SHARE.SHNUMBER,
SHARE.LASTNAME,SHARE.
FIRSTNAME,CERTIF.NO FROM
SHARE FROM CERTIF WHERE
SHARE.SHNUMBER=CERTIF.
SHNUMBER
```

This is KnowledgeMan's equivalent of the JOIN command with no temporary file required. Listing 1 shows a short two-file program that lists a shareholder's name and the associated stock certificates. This program does the same thing as KnowledgeMan's JOIN command, but it does it much more quickly. Apparently, KnowledgeMan does not make effective use of existing indexes.

As with dBASE, deleted records do not release their space; instead of using the PACK command, though, you must use COMPRESS. KnowledgeMan does not seem to give the user the same hands-on contact with the data that dBASE does. In addition, displaying and modifying a file's structure is more difficult with KnowledgeMan, and you cannot see what is on disk unless you know the file names in advance. Because of its rich supply of features, however, KnowledgeMan still comes out ahead in applications development.

One special feature of KnowledgeMan is a built-in spreadsheet, which deserves some close inspection. You might think, "With VisiCalc, Multiplan, and 1-2-3, who needs another spreadsheet?" But take another look. KnowledgeMan lets you write a program that sets up a spreadsheet and references cells directly through variables such as "#a1" (row 1, column a). Thus, you can dump selected values and formulas onto the sheet, turn control over to the operator, then retrieve results from the spreadsheet for storage back in the database. Think of the possibilities!

KnowledgeMan is a tough nut to crack if you have not started with dBASE. The book *Using KnowledgeMan* is probably just around the corner, though. In the meantime, you can attend KnowledgeMan seminars and classes, which are appearing throughout the country.

CHOOSING YOUR DBMS

With all these options available, how do you choose a DBMS package? First, be sure you zero in on the right category. If you are a beginner, choose an entry-level package such as pfs or C.I.P. Others in this group are Personal Pearl, VisiFile, T.I.M. IV, Data Base Manager II, Friday!, EasyFiler, and Perfect Filer. You can't really go wrong with any of these programs if you realize that most let you access only one file at a time. All are as easy to use as present technology allows, and they solve a wide range of everyday business problems.

If you need more power, but you don't

want to learn programming, consider a multifile package such as Condor or R:base. These are relational DBMSs, which are satisfactory for information storage and retrieval, but are not ideal for more conventional accounting applications. Packages such as InfoStar, Power-base, Aladin, and DataPath offer innovative approaches to handling multiple files that are outside the realm of relational theory. You will have to study them all to find the one that suits your application.

If you need more flexibility, consider a DBMS with a built-in programming language. dBASE II and KnowledgeMan have similar languages and are based on relational theory. Dataflex, Sensible Solution, Mag Base, and Revelation automate the coding of data-entry procedures while still allowing programming flexibility. Each of these has its own way of doing things, so you must adapt your requirements accordingly.

A new crop of DBMS software consists of mainframe/minicomputer hand-me-downs. PC/Focus, Oracle, and Informix are the first entries. Informix is a fully relational package with all the record-deletion problems properly solved. The other two are too new to categorize.

Finally, there is MDBS III, the extended-network DBMS for application developers. It has started to show up in sophisticated accounting packages such as Solomon III. Use it only if you are the Defense Department or if you are planning to sell at least a hundred copies of your program. ■

Listing 1: KnowledgeMan program to display shareholder information.

```
/* KnowledgeMan program to display shareholder and certificate info */

USE ASHARE AS SHARE WITH "SASHNO.IND" /* shareholder file, indexed */
USE STOCK WITH "STSHNO.IND" /* certificate file, indexed */
CLEAR
E.SUPD=TRUE
SNUM = "XXXXXXXXXXXX"
WHILE TRUE DO
  AT 1,1 INPUT SNUM USING "dddddddddd" WITH "ENTER SHAREHOLDER NUMBER"
  IF SNUM = "000000000000" THEN BREAK; ENDIF
  PLUCK SNUM FROM SHARE /* use index to find shareholder record */
  ? NUMBER LASTNAME FIRSTNAME ZIP
  PLUCK SNUM FROM STOCK /* find first certificate record */
  WHILE STOCK.SHNUMBER=SNUM DO
    ? STOCK.SHNUMBER STOCK.CNUMBER STOCK.QUANTITY
    OBTAIN NEXT FROM STOCK /* find subsequent certificate records */
  ENDWHILE
ENDWHILE
ENDWHILE
STOP
```

BY STEPHEN S. FRIED

EVALUATING 8087 PERFORMANCE ON THE IBM PC

*Saving time in engineering and business is easy if you
choose the right translator*

If you're an IBM PC owner, you probably know that the 8087 is a coprocessor that plugs into an empty socket on the PC motherboard. You probably also know that it does arithmetic and can be purchased for less than \$200. But you may not realize that the 8087 is actually a full-blown 80-bit processor that performs numeric operations up to 100 times faster than the 16-bit 8086. It has the potential to do arithmetic at the same speed as a medium-size minicomputer, while providing more accuracy than most mainframes.

To an engineer or programmer, that's good news. But the 8087 can also work wonders with business applications. There is a difference, however, between the business user who needs performance and the engineer or programmer. The business user will typically buy a turnkey application, while the technical user will probably have to write his own. This means the business user can remain ignorant of the chip's existence, while the technocrat has the added burden of evaluating 8087 support.

In this article we'll take a look at applications areas that are fertile for the 8087 and the types of support that are available. I've divided up programming language translators based on the efficiency of the support they provide.

THE 8087 IN OPERATION

How good is the 8087 in practice? For the evaluation of simple expressions, the quality of the 8087 code generated

by the best products (in-line compilers) will run 105 times faster than that generated by the weakest products (interpreters and spreadsheets). However, even spreadsheets are good candidates for 8087 support if they are used extensively to compute trigonometrics or exponentials, as these library functions run uniformly faster on all 8087 products. Typical increases in speed of 20 to 1 are common for business problems that depend heavily on library routines such as rate of return calculations.

The real power of the chip is most evident in scientific and engineering applications. While using one of the best FORTRAN compilers available, a PC user recently discovered that his CRAY computer executed one of his applications only a factor of 180 faster than his PC. But because the CRAY was serving 100 users, the turn-around time was only a factor of 2 better than the PC. The application being run involved a million floating-point operations and took .34 seconds of CRAY central-processor time. I don't suggest that you attempt a problem that takes an hour of CRAY time, unless you plan to go on vacation for a week. But I do advocate the use of desktop microcomputers to solve problems that involve 100 million floating-point operations or less.

(continued)

Stephen S. Fried is a founder of MicroWare (POB 79, Kingston, MA 02364) and vice-president in charge of R&D. He holds a bachelor's degree in physics from Brown University.

The major difference between Intel and Microsoft code is the use of the 8087 stack. Intel uses it for storing temporaries such as common subexpressions, while Microsoft stores them on the 8088 stack.

TECHNICAL OVERVIEW

The 8087 is an 80-bit coprocessor that operates as an extension of an 8086 or 8088. It contains eight 80-bit registers which can each hold a single real number. The eight registers are set up as a stack: every time a number is loaded into register 0, its prior contents will be pushed into 1, and 1 into 2, etc. The processor is often referred to as a numeric data processor (NDP) because the basic 48 instructions it can carry out are oriented to numeric operations using the numbers in its stack. To the assembly-language programmer, the 8087 looks like an extension of the 8088 that has its own instruction set for manipulating real numbers instead of bytes and words.

The operations performed by the processor are broken into two classes: in-line and library. The in-line routines perform the basic arithmetic operations (addition, subtraction, multiplication, and division) and square roots, loads, and stores. These operations typically take 100 to 200 machine cycles (20 to 40 microseconds). The library operations include all the trigonometric, exponential, and other related transcendental functions and are really programs that use special primitive operations designed to speed up and improve the accuracy of the functions. The library operations also include programs for converting strings into temporary real numbers and vice versa (encoders and decoders). Most library operations take between 250 and 500 microseconds to execute.

The library functions can be either purchased or written by the user (it is a big task) and normally come with 8087 compilers or adaptations as part of the product. Several books and applications notes will help the ambitious user. Each of the library routines takes advantage of special primitives that do the time-consuming part of the job. For example, all trigonometrics are computed by first scaling angles into $\pi/4$ radians, then calling a partial tangent function which essentially computes the two sides of the corresponding right triangle. Applying Pythagoras at this point yields the sine, cosine, or tangent. The scaling operation, which is typical of the special 8087 calls, is critical for large angles (used by many people, including astronomers) and is done by one operation called a partial remainder. It does the job faster and with much greater accuracy than any algorithm running on an 8088.

The three primary benefits of using 80-bit registers for numeric computations are speed, extended floating-point range, and extended accuracy. Processes that previously had

to be factored to avoid overflowing now run simply by using the next largest format. The ability of the temporary real-number format to hold numbers up to 10 ± 4098 is sufficient to handle almost any real-world application. The added accuracy of the 80-bit format makes it possible to solve problems in which the propagation of round-off errors is significant.

The capability to invert large matrices is probably the biggest advantage of all. A study at the Avco Everett Research Laboratory revealed the startling fact that on the average 30 percent of mainframe time was eaten up inverting matrices and solving simultaneous linear equations. Faster matrix routines pay off in a hurry. More accurate ones not only execute faster but also extend the allowable size of the matrix that can be handled. For example, large structures are designed using finite element analysis. In a large structure, information about a small region of the structure has to propagate through the entire structure. This information will get lost through round-off errors unless a 64-bit or larger number format is used. The temporary real-number format of the 8087 makes it possible to extend the size of the structures that can be analyzed. Also, the matrix inversion process lends itself to parallel processing. One algorithm now available on the PC executes at 10 percent of the throughput of an IBM 360 or 25 percent of a Prime computer. One happy user pointed out that this routine in conjunction with an 8087 saved him \$4 per minute in rental fees!

CODE KINETICS

As an interdisciplinary scientist/engineer, I have benefited greatly from working in a number of unrelated fields. Often one field ends up giving incredible insight to another. Most of my "academic quality" research was done in chemical kinetics, the branch of chemistry involved in measuring the speed of reactions. Many reactions can be modeled as a series of processes that execute serially. That is, process one finishes before two, etc.

Often a single process takes the majority of the time. The slow running process can be thought of as a bottleneck. If it can be removed or circumvented, the whole process will go much faster. In chemical kinetics the step that holds back the process is usually referred to as the rate-limiting step. Identifying and understanding the rate-limiting steps are usually the keys to designing efficient chemical reactors and processors. In the case of code processes, the same is true. When people describe a program as "number intensive," "number bound," "floating-point bound," "I/O bound," or "integer bound," they are really describing a code process whose rate-limiting step is known to be floating-point arithmetic, I/O (input/output), or integer arithmetic.

Eliminating the rate-limiting step in the case of a tank containing hydrogen and oxygen is simple: you apply a match. In the case of a program that is number bound, you apply an 8087. The balance of this article is really a study in identifying rate-limiting steps in code produced by a variety of translators and interpreters.

8087 TRANSLATORS

To evaluate 8087 performance, I divided language translators

(continued)

into 4 classes: interpreters, native compilers with IEEE (Institute of Electrical and Electronics Engineers) libraries, native compilers that generate in-line code, and globally optimized programs that use pipelining. First, let's examine interpreters and see why adding an 8087 does not make a big improvement in simple expression evaluation but can make a substantial improvement in trigonometric and transcendental operations. Since most spreadsheets fall into the interpreter category, 8087 spreadsheet support, which should be available by time of publication, will primarily benefit bankers and financial analysts who do a lot of exponentiation.

Interpreters are a class of language translators that either parse program statements into immediate actions every time they are encountered or execute an intermediate form that is not machine executable. In contrast, native compilers translate a statement once and generate code that is directly executable on the target machine. The translation process itself is not always an incredibly heavy burden. But when you combine it with searching through a long table for the value of a variable, you end up losing a factor of 3 to 10 over a similar compiled program. To see why interpreters don't benefit from in-line 8087 instructions, let's examine a short BASIC program in detail. I have written three short programs to enable you to measure the time required to do a loop, look up a variable, and finally perform a floating-point operation. The first program prints the time and then does 5000 iterations of a meaningless loop:

```
5 DIM C(5000),D(5000)
6 DEFINT I
10 PRINT TIMES
20 FOR I=1 TO 5000:NEXT
30 PRINT TIMES
```

It takes 2.5 seconds to execute and tells you that the time to execute a raw loop with an integer index is $2.5/5000 = .5$ millisecond. Next you add an assignment statement to the loop. I have chosen a single-dimensioned array, since the majority of simple operations often appear in the innermost loops of programs whose operands are arrays:

```
40 PRINT TIMES
50 FOR I=1 TO 5000:C(I)=D(I):NEXT
60 PRINT TIMES
```

The above fragment takes 15 seconds longer to execute than the empty loop, indicating that the expression $C(I)=D(I)$ takes $15/5000 = 3$ milliseconds to execute. Because I am familiar with the way Microsoft BASIC executes an assignment, I know that most of the time is spent looking up where the variables are stored. This means it takes about .75 microsecond to look up a variable.

```
70 PRINT TIMES
80 FOR I=1 TO 5000:A=C(I)+D(I):NEXT
90 PRINT TIMES
```

Line 80 takes only 4 more seconds than the assignment in line 50, indicating that a floating-point addition takes $4/5000 = .8$ millisecond. You have to be careful in this assessment, as there is one extra variable lookup, which from the second program you know takes up to .75 millisecond. Therefore the add may actually take much less than .8 millisecond.

Let's examine what kind of improvement you could expect if you placed an 8087 in the machine. In fact, to make a point let's use the world's fastest floating-point processor, the V8-80087, a virtual processor that takes almost no time to execute an add. If you now examine the time to execute line 80, you discover the following:

	IBM BASIC Interpreter	IBM BASIC with V8-80087
loop	2.5 seconds	2.5 seconds
lookups	13.0	13.0
add	<u>4.0</u>	<u>0.0</u>
	19.5 seconds	15.5 seconds

You get only a 25 percent increase in performance. No matter how fast your numeric processor runs, you can never make a major impact on a process for which the rate-limiting step is not numeric. In this case the rate-limiting step is looking up variables. If you added a call to the screen, it would be I/O. Conclusion: 8087s do not speed up I/O-bound processes; for that you need an 8089 or 80286.

Now let us examine a BASIC interpreter program whose rate-limiting step is numeric. This time I will just list the test fragments, followed by the incremental run times.

```
6 DEFINT I
7 F=.512345!
10 PRINT TIMES
20 FOR I=1 TO 5000:NEXT
30 PRINT TIMES

40 PRINT TIMES
50 FOR I=1 TO 5000:E=F:NEXT
60 PRINT TIMES

70 PRINT TIMES
80 FOR I=1 TO 5000:E=COS(F):NEXT
90 PRINT TIMES
```

	IBM BASIC Interpreter	IBM BASIC with 8087
loop	2.5 seconds	2.5 seconds
lookups	9.0	9.0
cosine	<u>133.0</u>	<u>2.5</u>
	144.5 seconds	14.0 seconds

Looking at the summary for the interpreter without an 8087, you see there is a bottleneck. Ninety-three percent of the execution time is spent computing cosines. The right column contains the time required for a real 8087 to compute 5000 cosines. Notice the improvement in speed is 10 to 1. If you did a Gestalt benchmark for double precision, you would discover it should actually be a 20-to-1 improvement because the 8087 time does not change when you change precisions, while the IBM BASIC interpreter's time should double. The fact that changing the interpreter's precision does not slow up its execution speed correlates with the fact that the last eight places of double-precision calculations normally contain garbage. In other words, the PC Basic interpreter fakes double precision.

I repeated these runs with a recently developed BASIC compiler/interpreter, Professional BASIC from Morgan Computing, which has 8087 support. This product has some unusual run-time features that make it convenient for developing and

(continued)

Can your advertising
in BYTE work in the
"back of the book?"



YOUR
AD
HERE.

This October, 1983 ad



**pulled 2,391
sales leads.
On page 489.**

This is not an exception. In the same issue on page 409, WYSE Technology's ad generated 1,792 inquiries and the Prometheus ad – way back on page 495 – garnered 1,588.

Advertisers in BYTE receive an average of over 1,000 inquiries per page of advertising, an average of 1,300 for full-page or larger ads. And not just in special, front-of-the-book positions, but all through the pages of BYTE.

Why? Because more than 430,000 high-tech computer sophisticates pay to read BYTE – cover to cover every month – for the microcomputer information they want and need. They'll send advertisers over 6 million ad inquiries this year, and over a half a million BYTE readers will buy products from ads they've seen in BYTE.

Including yours.

Talk to us – we're the people who wrote the book on microcomputer marketing. Just call Pete Huestis, Advertising Sales Manager, at (603) 924-9281.

BYTE

THE INTERNATIONAL STANDARD



BYTE is published monthly by McGraw-Hill, Inc., with offices at 70 Main St., Peterborough, N.H. 03458

debugging code. The run-time structure of the language is essentially a P-code interpreter. With the 8087, the rate-limiting step for most calculations turned out to be integer arithmetic and the FOR loop structure, which is, in my opinion, overburdened by the size of the integers (4 bytes). On the average, Professional BASIC evaluated simple expressions 4.5 times faster than the IBM BASIC interpreter, but ran at only 25 percent of the speed of MicroWare's 87BASIC, an IEEE 8087 adaptation of the IBM BASIC compiler. This is in line with other P-code compilers that have 8087 support. The transcendentals and exponentials were on a par with well-written 8087 products.

Other products using run-time interpreters for which 8087 support is in the process of being developed include SuperCalc, VisiCalc, Visi OnCalc and Lotus 1-2-3. The Visi OnCalc spreadsheet is reported by VisiCorp to show only a 15 percent increase in speed using the 8087, although VisiCorp did not elaborate on whether this was for in-line or library operations. The new version of SuperCalc III shows improvements in execution speed that range from a factor of 2 to 20. In the case of a spreadsheet, it is obviously very important to make sure that your problem is number intensive as opposed to word intensive or symbol table intensive. Based on my conversations with Sorcim, it would appear that the "faster" spreadsheets are efficient enough to benefit from 8087 sup-

port and that their 8087 implementation really pays off in iterative financial analysis.

CODE GENERATION WITH NATIVE-CODE COMPILERS

Most conventional compilers perform floating-point arithmetic by calling routines from a library that comes with the compiler. Libraries are really object modules that have been bundled together to simplify the linking process. At link time the linker pulls the modules needed to support your program out of the library and builds them into your load module. There can be a little to a lot of overhead associated with library calls. It is all a function of the "linkage" between the program and the library and the way the library handles the 8087. As a general rule, compilers that generate library calls for simple operations run 4 to 6 times slower than in-line code.

From the user's standpoint, there are essentially three modes in which an 8087 can be run. If the problem you are solving spends the majority of its time executing library calls (exponentials or trigonometrics), then any good 8087 package will do, since the speed of the in-line operations will not be critical. In other words, with problems whose rate-limiting step is trigonometrics or exponentials, you do not need to

BASIC_C LIBRARY—BRIDGING THE BASIC GAP

Every day, programmers like yourself are making the jump from BASIC to C. With high level functions that work like BASIC and documentation that is written from the perspective of a BASIC programmer, the BASIC_C library provides the best path to help make your journey pleasant and fast!

BASIC'S POWERFUL FUNCTIONS IN C PROGRAMS—

The BASIC_C library provides most of BASIC's high level functions—string handling, sequential and random i/o, graphics and many more—all are designed to look and work like BASIC functions. Instead of wasting time trying to figure out how to clear a screen or locate the cursor, you can concentrate on learning what C is about. Source code for the whole library is included!

WRITTEN WITH BASIC PROGRAMMERS IN MIND—

Our documentation is oriented to those familiar with BASIC. A full chapter is devoted to a point-by-point comparison of BASIC and C. Each function's description contains at least one example written in BASIC and the equivalent C. Many customers tell us that the BASIC_C documentation is the best C tutorial they've seen.

Now you can edit, compile and test your program from inside the EC editor. In fact, EC gives you complete access to the operating system. Do a directory, copy or delete files, even run other programs without ever leaving EC!

MULTIPLE WINDOWS ... WITH A FILE IN EACH—

All windows can be shown on the screen at the same time; or the screen can be dedicated to one file, while the others are kept in the background—only a keystroke away. You can even cut and paste blocks of text between windows!

FULL SCREEN EDITOR FOR THE IBM—

EC uses all the PC's special keys so that editing is fast and intuitive. In addition to standard editing features, EC provides text and command macros, word wrap, paragraph reformatting, horizontal scrolling, and color video control.

DEMO DISK IS ONLY \$5—

Call or write for our full-featured demo. You'll get a standard version of EC that can handle up to 10K worth of text files and a complete set of documentation. See for yourself how pleasant it is to use an editor that gives you multiple windows and free access to your operating system.

EC DEMO DISK -	\$ 5
EC (pronounced e-see) - full screen editor	\$125
BASIC_C LIBRARY - including source code	\$175
BASIC_C & EC	\$275
BASIC_C & DeSmet C compiler/w debugger	\$325
BASIC_C & Computer Innovations C compiler	\$475
BASIC_C & Lattice C compiler	\$525
BASIC_C & EC & DeSmet C compiler/w debugger ..	\$425
BASIC_C & EC & Computer Innovations C compiler	\$575
BASIC_C & EC & Lattice C compiler	\$625

*EC runs on an IBM PC, or look-alike, with at least 128K RAM under DOS 1.1 or higher. To use the DOS interface feature you must have DOS 2.0 or higher and enough RAM to run the additional program.

IBM is a trademark of International Business Machines

C SOURCE
 12801 Frost Road
 Kansas City, MO 64138
816-353-8808

be concerned with the quality of in-line operations (adds, subtracts, multiplies, divides).

The worst 8087 compiler support products are those libraries that adapted the 8087 to the original IBM compilers without converting the entire library and compiler over to the IEEE number format. Because of the ugliness of the conversion process for the IBM FORTRAN library I/O routines, none of the products for this compiler is IEEE compatible. This means they all convert on the fly, back and forth between IEEE and Microsoft format every time a numeric operation is performed. This adds a lot of linkage time to all numerics, but the original routines in IBM FORTRAN were so bad that adding even this limited 8087-only support typically improved run times by a factor of 4.

The IBM Pascal was a much better organized and documented product than the FORTRAN. The Pascal shared a common code generator with the FORTRAN and was well enough documented so that a careful person could coax the first pass of the compiler into generating constants in the IEEE format. Once this hurdle was overcome, it was just a matter of figuring out how to patch an undocumented library with IEEE code. Fortunately for me, the Intel translators leave their signatures behind, and a few calls verified that ASM86 was the Intel assembler and IBM's secret object-file format was essentially Intel's. The IEEE library that I developed for IBM Pascal ran 50 percent faster on simple operations than the non-IEEE library I developed for FORTRAN.

Compiler-generated code can produce 30,000 to 40,000 floating-point operations per second. The best that IEEE-compatible 8087 libraries can do is 8000 operations per second. Yet there are many languages and products that get by quite well with this level of support and do not need the elegant code described in the following paragraphs. If you already own a compiler, the IEEE library approach may be adequate if your application's rate-limiting step is trigonometrics or exponentials, or if you use your compiler primarily for writing operating systems or compilers.

The best of the IBM libraries reside in the IBM BASIC Compiler. These libraries are so good that 8087 adaptations that convert on the fly run at about the same speed as the original library routines. Users who want to see an improvement in BASIC programs are advised to use libraries that are IEEE compatible. With IEEE libraries, it is possible to get increases in speed of between 4 and 20 to 1, depending on the ratio of simple operations to trigonometrics and exponentials. A number of good products are out that only have library support (that is, they do not generate in-line code). If the compiler generates IEEE constants, then the support will be within a factor of 8 to 1 of the best in-line code.

How does a compiler with an IEEE library perform a floating-point operation and assignment? Assume you have written a program to compute a simple sum. Along with subtraction, this is the most severe test of the libraries. Because it is the most common operation by far, it is the one that typically sets the performance of the library. Let's analyze the following line of code:

```
FOR I = 1 to 200000: A = B+C: NEXT I
```

Because of the speed of the 8087 it is often necessary to make 200,000 loops to get good measurements of code

speed. I did this in the actual program by setting up an outer loop with a limit of 20 and an inner loop with a limit of 10,000. I have written this line in BASIC syntax, but it just as easily could have been C, Pascal, or FORTRAN. Now look at the code generated by this line located in a MAIN program (it will differ in PROCEDURES, etc.). A typical compiler will either set two pointers to the numbers or pass in the actual values, then compute the sum and return, leaving the computed value in a "floating-point accumulator" located in memory or in the 8088 registers. For example, one compiler generates the following code:

```
MOV    SI,OFFSET B    ;load pointer to A into SI
MOV    DI,OFFSET C    ;load pointer to B into DI
CALL   SADD           ;|SI| + |DI| → FPAC
MOV    DI,OFFSET A    ;load pointer to C into DI
CALL   SASS           ;Assign FPAC to |DI|
```

For those of you afraid of assembly language, hang in a second: 8087 code is easier to read and learn than straight assembly language. The first two instructions take the address of the variables B and C and place them into 8088 pointer registers SI and DI. The next line calls a single-precision add routine. The result of a single-precision add is left in the FPAC (floating-point accumulator). The last two lines perform the assignment by taking the value out of FPAC and putting it in A.

Now let's examine the library routines SADD and SASS.

SADD:	schematic	comments	cycles
FLD SI	: SI	→ ST(0)	43
FADD DI	: DI + ST(0)	→ ST(0)	105
FSTP FPAC	:ST(0)	→ FPAC	89
RET			

The routine SADD first loads the 8087 top of stack, ST(0), with the value of the first operand. On the right side of each line I have written the number of machine cycles required to perform the operation. Operand one is pointed to by the SI register in the 8088. The first line tells the 8087 to use the value in SI as a pointer to a single real variable and load this value into ST(0). The actual code would contain an additional modifier, dword ptr, which would inform the assembler that the operand pointed to by SI is single precision. The next line tells the 8087 to get the value pointed to by DI, add it to ST(0), and leave the result of the addition in ST(0). The final line takes the result and stores it in memory at a location labeled FPAC. A quick analysis of these three instructions reveals that it takes 105 cycles to do the actual addition and another 130 cycles to move numbers into and out of the 8087. Put in other terms, a simple addition is less than 50 percent efficient if the operands have to be imported and the results exported on every addition. It turns out that for the library routines the code is worse because to complete the assignment you have to load the FPAC into A. This is done in SASS.

SASS:	schematic	comments	cycles
FLD FPAC	:FPAC	FPAC → ST(0)	43
FSTP DI	: DI	ST(0) → DI	89
RET			

(continued)

This adds another 130 machine cycles to the code. Adding up the cycles reveals:

linkage overhead	100 cycles
2 FLD	86
2 FSTP	188
1 FADD	105
	479 cycles

But you are still not done! In the case of Microsoft BASIC, each of these two library calls has an additional 50 cycles of linkage to execute going in and coming out. This adds 200 cycles to the total assignment time, which makes a grand total of 679 cycles to do an add and make an assignment. Dividing 679 by 5 cycles per microsecond results in an approximate add, plus assignment time of 134 microseconds, which agrees with the measurements on 87BASIC. For those of you who are perplexed, 200,000 adds in 32 seconds = 6300 adds per second = 1 add every 159 microseconds.

Finally, let's evaluate the numeric efficiency of the code generated by single-register 8087 libraries. This criterion tells you how much of the work that gets done is related to the numeric process at hand, as opposed to numeric I/O. Of the 679 cycles, only 105 involved arithmetic as follows:

FLD B	:B	→ ST(0)	43 cycles
FADD A	:ST(0) + A	→ ST(0)	105
FSTP C	:ST(0)	→ C	89
			237 cycles

Therefore, the numeric efficiency is $105/679 = 15$ percent.

NATIVE-CODE COMPILERS WITH IEEE CODE ROUTINES

The assignment just analyzed is handicapped by the fact that it is not amortized over more numeric operations. It still shows that in-line code will make a big improvement in numeric efficiency. In-line code can be approximated with run-time libraries that contain "code routines." Because of their ease of implementation, compiler-called code routines were the first forms of 8087 support to appear. Developing your own entails writing a library of subroutines, each of which performs a specific 8087 operation. The library must be written so that it can be called from the target language, which must use IEEE constants if the method is to avoid "conversions on the fly."

Code routines never caught on because they are neither user-friendly nor transparent. I use them for experimenting with 8087 code because the set I developed is easy to interact with and debug using the IBM BASIC compiler. The technique is most effective where it can be used to eliminate compiler-generated "numeric I/O" by allowing the user to write globally optimized code. For example, if you plan to use the variable C in a series of calculations, then you would compute its value and then leave it on the 8087 stack, as follows:

```
100 CALL FSRLD(B): rem ST0 now contains B
120 CALL FSRADD(C): rem ST0 now contains B+C
```

And then do some intermediate calculations:

```
130 CALL FDUP: rem ST0 and ST1 now contain B+C
140 CALL FSQRT: rem ST0 contains sqrt(B+C)
150 CALL FDIVP: rem ST0 contains ST0/ST1
```

before making the assignment.

```
160 CALL FSRSTP(A): rem assign ST0 to A
```

The syntax here uses F for all library routines and follows it with an SR if a memory reference is made to a single real number. If you analyze the same calculation performed by the compiler's call to its run-time library, you would see it involves twice as many 8087 operations and takes twice as long to run. This code routine technique can prove valuable if the compiler you own does not have in-line support, and if you can identify the most heavily executed code lines. Rewriting the key section(s) with code routines can usually make a factor of 2 improvement over compiler-generated library calls. Products that use this technique exist for IBM BASIC and Pascal.

UPPER LIMIT ON 8087 SPEED

For a compiler to generate really fast 8087 code, it must do two things: eliminate the wasted time in run-time library linkage and keep floating-point variables on the 8087 stack as long as possible. Before exploring these techniques, let's review other 8087 facilities. The 8087 has eight registers ST(0) . . . ST(7), which can be used for general-purpose storage of floating-point numbers. Any number that stays on the 8087 stack gets treated as if it were an 80-bit number for the duration of its stay on the stack. Keeping variables on the stack reduces not only 8087 I/O overhead but the accumulation of round-off errors. If you can keep numbers on the stack for many iterations without doing any loads or stores, then the throughput will quickly approach the speed of a stack operation. Because the number of cycles required to perform a stack operation is well known, we can easily place an upper limit on the speed of the 8087. This is a convenient yardstick for the code in table 1 we are about to analyze.

Notice in table 1 that I included the square root as a simple operation. The 8087 is unusual in that it does square roots as fast as division, and several hundred times faster than algorithms executed by the 8088. In typical code, it is rare to see a sequence of additions or subtractions without any multiplications or divisions. So it is deceptive to think about the upper limit as 59,000 floating-point operations per second (FLOPS). In fact, a series of tests reveals that, in an average expression, the throughput for stack operations actually is about 45,000 FLOPS. This roughly corresponds with the average of the times for the four primary operations.

IN-LINE 8087 SUPPORT

The best 8087 code is generated by native-code compilers, which emit 8087 instructions in-line. The quality of the code generated by these products is so good that the kinetics of

Table 1: Upper limit on 8087 throughput for stack operands.

Operation	Machine Cycles	Microseconds	Rate FLOPS
ADD	85	17	59,000
SUB	85	17	59,000
MULTIPLY	138	27	44,000
DIVIDE	198	40	25,000
SQUARE ROOT	183	36	28,000

the problem is more complicated than just identifying a rate-limiting step. Many factors now start to play a role. These include the form of the problem being solved, the memory model being used by the compiler, interleaving of 8088 instructions with 8087 instructions (pipelining), the quality of the translation of expressions into 8087 code, 8087 stack use for common subexpressions, and the use of the stack for global variables that are "hot." Ultimately, the key to improving 8087 performance revolves around minimizing 8087 I/O.

Now let's see how two of the best compilers use the stack in the programs they generate. In this section I'll concentrate on the evaluation of a single expression. It is a "fair" expression, which means I did not go overboard and choose an expression with five common subexpressions, which would show off the 8087 and the better 8087 code quality of one of these two compilers. The expression is typical of those that evaluate the properties of materials using polynomial expansions. Equation 1 is the expression I will evaluate. Equation 2 is an equivalent representation.

1) $H = (C0 + (X-K) \cdot (C1 + (X-K) \cdot (C2 + (X-K) \cdot (C3 + (X-K) \cdot C4))))$
 2) $H = C4 \cdot (X-K)^4 + C3 \cdot (X-K)^3 + \dots + C0$

Equation 1 is preferable for this test because it replaces the computation of powers with multiplies, which execute a factor of 10 faster in the 8087. In these equations, (X-K) is called a common subexpression. A good compiler factors out common subexpressions so that they have to be evaluated only once. Both of the compilers we will study do this. The only difference in the generated code is where the common subexpressions go. Let's examine the impact of the different strategies on the number of machine cycles required to calculate H.

First I'll use code generated by the Intel FORTRAN-86 compiler version 2.2. It is a four-year-old product developed by Intel to run on its development system and to demonstrate the power of the iAPX 86/88 concept. The compiler recently "migrated" under license to PC users running MicroWare's RTOS operating system. When this compiler came out, it was benchmarked by Intel against minicomputers and other 16-bit microcomputers and was shown to be superior for floating-point purposes.

In the upcoming section I will provide a guided tour of how Intel generates code for the example expression. To make this less painful, I have added comments to some of the code and also a stack chart on the right side of the code to help the reader visualize the activity on the 8087 stack. The stack is composed of eight registers, which are labeled ST(0) through ST(7) and are often abbreviated as ST0 through ST7. As you proceed along the code line, I will define the common subexpression and label it CSE. The compiler will also build partial results, which I will label F1 through F3. Each line is labeled with a number followed by an 8087 operation, which has optional operands that are followed by the state of the stack after the operation has occurred. I also included some schematics of the operations in the first 4 lines. Line 0 defines the initial state of the stack. All registers start out empty (MT) in line 0.

Line	op	Operands	ST(0)	ST(1)	ST(2)	Comments
0			MT	MT	MT	MT
1	FLD	K	K	MT	MT	:K → ST(0)

2	FSUBR	X	X-K	MT	MT	:X-ST(0) → ST(0)
3	FST	ST(1)	X-K	X-K	MT	:ST(0) → ST(1)
4	FMUL	C4	C4*(X-K)	X-K	MT	:C4*ST0 → ST(0)
5	FADD	C3	C3+C4*(X-K)	X-K	MT	:F1 = C3+C4*(X-K)

Looking at equation 1, you see that the innermost factor is C3+C4*(X-K). This factor contains the common subexpression (X-K), which is computed in lines 1 and 2. Once evaluated, it is saved on the stack for future use. This is done in line 3, using an operation that copies ST0 into ST1. The next line forms the product C4*(X-K) and leaves it in ST(0). Note that (X-K) rides on top of the calculations being done in ST(0). Line 5 completes the first factor. The balance follows:

6	FMUL	ST0,ST1	(X-K)*F1	X-K	MT	
7	FADD	C2	C2+(X-K)*F1	X-K	MT	:F2 = C2+(X-K)*F1
8	FMUL	ST0,ST1	(X-K)*F2	X-K	MT	
9	FADD	C1	C1+(X-K)*F2	X-K	MT	:F3 = C1+(X-K)*F2
10	FMULP		(X-K)*F3	MT	MT	
11	FADD	C0	C0+(X-K)*F3	MT	MT	
12	FSTP	H	MT	MT	MT	

Looking over the second half, you see that it essentially repeats until you get to line 10. The compiler cleans up the stack for the next user by including two instructions that pop the stack (they also end in P).

Based on the fact that the line executes nine floating-point operations, I determined the number of FLOPS, and on the basis of the fact that it was replacing 12 instructions, I computed an "effective" FLOPS, which is labeled EFLOPS.

	Operations/second
EFLOPS	46.880
FLOPS	35.090

The code generated by Microsoft was identical for both versions of Microsoft's compiler (3.1 and 3.2). The major difference between Intel and Microsoft code is the use of the 8087 stack. Intel uses it for storing temporaries such as common subexpressions, while Microsoft stores them on the 8088 stack. You can see this by comparing lines 4 and 5 in the Microsoft code with line 3 in the Intel code. The most unusual thing about the Microsoft code is that it places copies of the subexpression (X-K) on the stacks of both the 8088 and 8087.

Line	op	Operands	Microsoft-Generated Code			
			ST(0)	ST(1)	ST(2)	ST(3)
0			MT	MT	MT	MT
1	FLD	X	X	MT	MT	MT
2	FSUB	K	X-K	MT	MT	MT
3	FLD	ST0	X-K	X-K	MT	MT
4	FSTP	[BP-8]	X-K	MT	MT	MT
5	FLD	[BP-8]	[BP-8]	X-K	MT	MT
6	FMUL	C4	C4*CSE	X-K	MT	MT
7	FADD	C3	C3+C4*CSE	X-K	MT	MT
8	FLD	[BP-8]	[BP-8]	C3+C4*CSE	X-K	MT
9	FMULP	ST1,ST0	[BP-8]*C3+..	X-K	MT	MT
10	FADD	C2	C2+[BP-8]*C3..	X-K	MT	MT
11	FLD	[BP-8]	[BP-8]	C2+[BP..	X-K	MT
12	FMULP	ST1,ST0	[BP-8]*C2..	X-K	MT	MT
13	FADD	C1	C1+[BP-8]*C2..	X-K	MT	MT
14	FMULP	ST1,ST0	(X-K)*(C1+..	MT	MT	MT
15	FADD	C0	C0+(X-K)*(C1..	MT	MT	MT
16	FSTP	H	MT	MT	MT	MT

(continued)

From a code efficiency standpoint, the cost of placing temporaries in memory and on the stack is 16 instructions for Microsoft as compared to 12 for Intel. This amounts to a 30 percent increase in code size and a corresponding increase in the number of machine cycles needed to execute it. When you analyze the number of cycles that each compiler takes for this job, you will see that the improvement is roughly 30 percent in favor of Intel. This also demonstrates that the difference between the best (the Intel code line for this expression can be shown to be optimal!) and good does not make for a huge difference in performance for well-optimized in-line 8087 code generators. Once you are in the ball park, the law of diminishing returns starts to apply to code generators. Also in fairness to Microsoft and Intel, code quality is not the only factor by which to make a purchasing decision. On the average Microsoft code is actually more compact than Intel because Microsoft chose the Medium memory model, while Intel uses the Large model, which will be described later in the article. Designing a compiler involves hundreds of trade-offs, none of which should make or break a product.

Before leaving the example, I will analyze both code lines with an eye toward calculating the time spent doing I/O to memory versus arithmetic operations. This is easy. Just open any Intel user manual on the iAPX 86/88 series and turn to the section on the 8087. Most have a table listing all the operations and the number of cycles needed for each instruction as a function of the operand size and location. In my analysis, I segregated 8087 operations that do I/O only from arithmetic operations and then added up the cycles in each category. Every operation that references memory requires an effective address time (EA in table 2) to be calculated, as per Intel instructions. To complete the analysis, I transferred the 30 cycles it takes for an instruction of the form FOP mem (OP symbolizes arithmetic operations) to do I/O from the arithme-

tic side to the I/O side. The analysis is displayed in table 2.

You can immediately produce all kinds of significant statistics. First, both compilers generate very good code, especially when compared to that generated by library calls. As the expression being evaluated makes better use of the 8087 stack, the numeric efficiency of the code generated by Intel increases, approaching 90 percent for problems that have large numbers of CSEs. The Microsoft code generation is fixed at 60 percent for identical problems, because there is no reduction in the time spent addressing variables on the 8088 stack, which is in memory. What you are witnessing here is a battle between hardware and software. Hardware designers speed up machines by building devices that have special instructions for doing "upper-level" activities. These special instructions save time by cutting down on the number of bus cycles needed to execute them. Software designers always like to write universal code that can be ported to as many devices as possible. For universal code to maintain its portability, it cannot take advantage of these special instructions.

There are some other very significant differences between Intel and Microsoft that affect performance and are important to understand. The first involves calls to library functions. All Intel compilers use a common set of 8087 libraries to do such chores as trigonometrics, transcendentals, and exception handling. The numeric parameters are always passed to these libraries on the 8087 stack, dramatically reducing the overhead of a library call but requiring the compiler to keep track of the current depth of the 8087 stack. Microsoft uses the 8088 stack or registers in the 8088 for passing parameters to library calls. The Intel technique is faster but much trickier.

The second difference involves memory models. When Intel developed the iAPX 86/88 architecture, it created four memory models for writing programs. These are called Small, Compact, Medium, and Large. The 8088 can address a megabyte

Table 2: Analysis comparing time spent on I/O to memory versus arithmetic operations.

		Intel				Microsoft					
		Cycles	(EA)	no.	I/O OPERATIONS Total	Operation	Cycles	(EA)	no.	Total	
FLD	mem	46	5	1	51	FLD	mem	46	9	5	275
FST	sti	18		1	18	FSTP	mem	102	7	2	218
FSTP	mem	102	5	1	107						
+ arith I/O cycles					180	+ arith I/O cycles					180
					356						673
ARITHMETIC OPERATIONS											
FSUBR	mem	110	5	1	115	FSUB	mem	110	5	1	115
FMUL	mem	120	5	1	125	FMUL	mem	120	5	1	125
FMUL	sti	130		2	260	FMULP	sti	142		3	426
FMULP	sti	142		1	142	FADD	mem	110	5	4	460
FADD	mem	110	5	4	460	- I/O cycles = 6*30					-180
- I/O cycles = 6*30					-180						
Numeric Cycles					922						946
Total Cycles					1278						1619
Numeric Efficiency					72.14%						58.43%

of RAM (random-access read/write memory) broken up into 64K-byte segments. Segments can be located at any multiple of 16 bytes in the 8088 address space and are addressed in the processor by four segment registers. The convenient "cell" into which programs can be broken is the segment. Depending on how a program is broken into segments, it can be classified as falling into one of these four models. In general, the "smaller" the model used, the fewer number of times the values in the segment registers change. As a result, smaller programs run faster. In effect, Small programs still hold onto the 8-bit architecture of the 8080. The storage that can be accessed is increased as the models get larger. This is accompanied by a reduction in execution speed.

Most of the compilers on the PC market fall into one of the Intel memory models. The IBM FORTRAN and Pascal and Microsoft FORTRAN and Pascal fall into the Medium model. The latest FORTRAN, version 3.2, has an extension—mega-byte arrays—a feature that is not defined by the Intel models. The Intel FORTRAN uses the Large model with a similar extension for large arrays. In the comparison of the two compilers, I attempted to verify the use of these models and get an estimate of the decrease in numeric speed resulting from the use of the larger model.

The Medium and Large models are very similar. Both break up the program code into as many 64K byte segments as the

user would like. Essentially, the user can use up to 64K bytes for any main program or subroutine. In the Medium model a single data segment is used to store all constants and data. In addition, the user can define common and memory areas. The Large model associates a data segment with every code segment. From a code standpoint, the main difference between Large and Medium or Compact is that any time a subroutine is called using pass by reference (the FORTRAN standard), the compiler must pass 4 bytes of address information (Large) instead of two (Compact).

A secondary effect is that any time an expression is evaluated that contains dummy arguments (those passed in), for each dummy argument used the 8088 must calculate the effective address of the parameter used. This calculation would take additional time if it were not for 8087 pipelining: in a typical situation, the address calculation (8088) and the previous 8087 operation are done concurrently. The following listing compares the first three instructions of the example (direct addressing) with the code generated when dummy arguments are used (indirect addressing):

INDIRECT ADDRESSING	DIRECT ADDRESSING
LES BX,[BP+PARAM+24H]	:set address
FLD ES:[BX].K	FLD K :8087 operation
LES BX,[BP+PARAM+20H]	:set address

(continued)

How can your microcomputer talk to an IBM mainframe?

CLEO.



The communications features of the CLEO-3270 Software package allows your microprocessor to emulate a cluster of IBM terminal devices. The CLEO software provides the cluster emulation and makes the ASCII devices look like an IBM 3278 CRT and 3287 printer.



If your IBM mainframe doesn't support remote 3270 clusters, you need remote batch communications. CLEO-3780 Software is your answer.

For full details contact CLEO, a div. of Phone 1, Inc. 461 N. Mulford Rd., Rockford, IL 61107: (815)397-8110 Telex 703639.



Circle 142 on inquiry card.

Computers for Less

 <p>IBM P.C. 2-Drives, Color card monitor, Parallel port \$2395 call for other configurations</p>	 <p>TAVA PC™ 128K Complete System Only \$1795 call for complete details.</p>
<p>Printers</p> <p>Brother HR-15 \$399.00 Epson FX-100 675.00 Juki 6100 399.00 Gemini 10X 269.00 Okidata 93 645.00</p>	<p>Modems</p> <p>Hayes 1200 \$469.00 Hayes 1200B 399.00</p> <p>IBM Accessories</p> <p>AST Six Pak Plus 249.00 Teac 55B 179.00 Maxell DS/DD 27.00</p>

Call for pricing on our complete line of fine computing products

YOU CAN'T BUY COMPUTERS FOR LESS
(619) 579-2730

3855 Avocado Blvd., Suite 140-227 La Mesa, California 92041



Prices subject to change without notice
Prices reflect 2 1/2% cash discount • Quantities Limited



Circle 42 on inquiry card. Fall 1984 • BYTE Guide to the IBM PC • 207

Table 3: Comparison by class of translators that support the 8087.

Translator	EFLOPS	time	Efficiency
Native compiler with optimized in-line code			
Intel FORTRAN-86	46.800	51	1.04
Microsoft FORTRAN 3.1/3.2	37.060	65	.82
Native compiler with 8087 IEEE library and code routines			
87BASIC/87BAS+	15.000	160	.33
Native Compiler with 8087 IEEE libraries			
87BASIC	8391	286	.186
LATTICE C	7500	320	.166
Native compiler with 8087 non-IEEE libraries			
87FORTRAN (REAL*4)	4403	545	.07
P-code compiler interpreters with 8087 libraries			
Professional BASIC	2000	1200	.045
SS FORTRAN	5800	414	.129
Pure interpreter—no support			
IBM BASICA	444	5400	.0098

```
FSUBR ES:[BX].X      FSUBR X      :8087 operation
LES BX,[BP+PARAM+8H]  :set address
FST ST1             FST ST1      :8087 operation
```

Note the overlapping of 8088 and 8087 instructions in the indirect case. It is also important to understand that it is possible to convert a pass by reference call into a pass by value call by simply assigning the incoming dummy argument to a local variable. When this is done, the code generated by the Intel Large model reverts back to direct addressing. I conclude that there is no penalty to Large model programs in which the majority of data references are made to the "local" data segment.

Summarizing, the Microsoft compiler produces uniformly good code independent of the complication level of the expression. Its efficiency is roughly 60 percent. The Intel code starts out at the Microsoft efficiency level and improves as the number of parameters that stay on the stack increases, asymptotically approaching 90 percent. Neither compiler does a good job with true mainframe optimizations, such as placing global real variables on the Numeric Data Processor stack, although the Intel compiler does keep real variables on the stack through basic blocks and passes parameters to library functions on the stack without unloading the stack. The biggest difference between the products is the use of memory. Intel uses the Large model, which allows each subroutine to have local data storage in an associated data segment, whereas Microsoft uses the Medium model, which requires all data to go in a single segment. The other difference is the linker. Microsoft generates only .EXE files, whereas Intel generates .EXE files and absolute files. The latter make it easy to place data in out-of-the-way places, like the RAM above the screen bank (B000 hexadecimal) but below the ROM (read-only memory) BIOS (basic input/output system). Including bank

A000 hexadecimal, this opens up 256K bytes to user storage that IBM has reserved but not yet used.

8087 ASSEMBLY-LANGUAGE SUPPORT

It is very easy to evaluate simple expressions using your own in-line code. Two approaches to generating 8087 code with the IBM assembler include the use of macro libraries and a preprocessor that converts 8087 opcodes into 8088 escape codes. For those users who own RTOS (MicroWare's real-time operating system), the choice will be the Intel assembler (ASM-86), which also serves as the definition for the language and mnemonics Intel invented for dealing with the 8088. It comes with an exhaustive library of "8087 common elementary functions" and an 8087 debugger.

The MS-DOS areas that require substantial additional user effort are debugging with Debug (which skips over 8087 escape codes and does not display the 8087 registers) and the development of trigonometric and transcendental libraries. Two products from MicroWare reduce these IBM 8087 support deficiencies. The first is a debugger, called 87DEBUG, that lets the users "watch" the 8087 as their codes execute. The second is a library of 8087 routines called 87MACRO which provides functions similar to the Intel libraries. For users who want to write their own routines, the suggested reading is the 87/88 Guide and Intel Application Notes. In any case, users who learn to write code for the 8087 will find it a valuable asset in generating special routines and in understanding the code generated by their compilers.

Table 3 compares the effective numeric efficiency of a number of different translators for the evaluation of the double-precision expression in equation 1, described earlier. The times given in the table are in seconds for 200,000 evaluations of this expression. The time to execute loops has been subtracted. The column labeled EFLOPS contains the number of floating-point operations per second, adjusted for the fact that some of the compilers eliminate common subexpressions. Note that about a 105 to 1 spread exists from the slowest to the fastest. The slower products are obviously very inefficient; this does not mean they have poor 8087 support, but that they are I/O bound as opposed to 8087 bound. It also points out that the 8087 is not a panacea, but rather a numeric processor that works best with very tight code. The effective numeric efficiency was computed by dividing EFLOPS by 45,000, the number of mixed stack operations that the 8087 can do in a second. I chose this definition because it can be applied across a spectrum of products. For products that use the 8087 stack effectively, the effective numeric efficiency depends on the expression used to evaluate it and goes up as the number of common expressions increases. The definition can result in efficiencies that are greater than one.

Table 3 ignores the other half of the story: library functions such as COS and EXP. If these functions are well written, they should perform with the same accuracy and speed in all implementations (even the interpreters). However, a number of these languages do not support, or do a poor job handling, double-precision variables. Therefore, the quality of double-precision arithmetic and the accuracy of functions turn out to be a whole new story. If accuracy is critical for your application, verify that the product in question meets the Intel/IEEE standard and allows the use of temporary real variables. ■

EXTRA POWER FOR SPECIAL NEEDS:

THE XT/370, 3270 PC AND CS 9000 SERIES

THE MICRO AS MAINFRAME/THE MAINFRAME AS MICRO	
The IBM XT/370 Personal Computer by Ernest Sabine.....	210
Number Crunching on IBM's New S9000 by David J. States.....	218
The Mainframe Connection: IBM's 3270 PC by Larry Augustin.....	231
MAXIMIZING THE PC FAMILY: COMMUNICATIONS AND COMPATIBILITY	
Modems: The Next Generation by Mark Klein.....	238
Moving Data Between PCs and Mainframes by Jay Siegel.....	248
Testing for IBM PC Compatibility by Robert A. Stillman.....	256
What's New	266

ILLUSTRATION BY ROBERT TINNEY

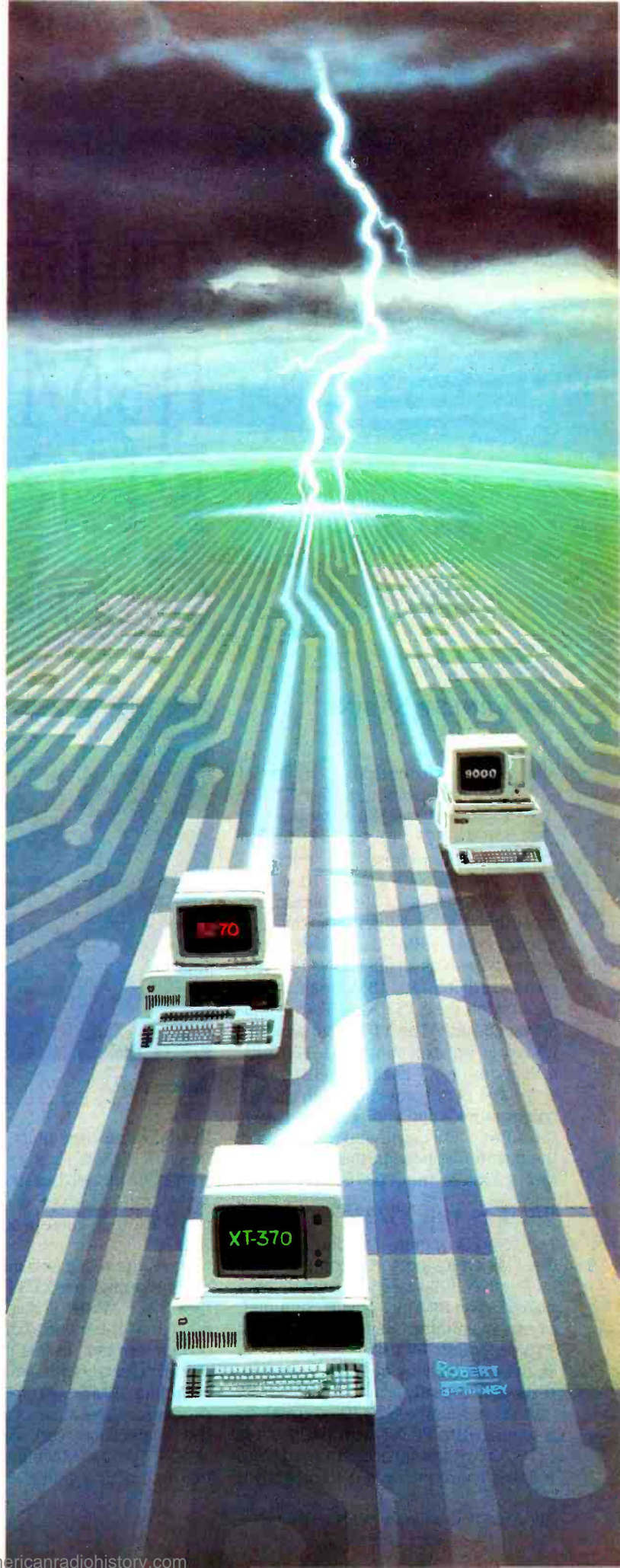

ROBERT
TINNEY

THE IBM XT/370 PERSONAL COMPUTER

BY ERNEST SABINE

IBM's two extensions to its line of personal computers, the XT/370 (or 5160 Model 588 or Model 568) and the 3270 PC (or 5271 Model 2, 4, or 6), address the micro-to-mainframe link for the IBM 370, 43XX, and 30XX series of general-purpose computers. Each allows simultaneous operation of an IBM PC as a stand-alone computer and as an interactive terminal networked to an IBM mainframe. Beyond this the XT/370 and 3270 PC differ significantly. The XT/370's major emphasis is on executing IBM 370 programs on the XT itself. The 3270 PC's emphasis is on providing high-quality color graphics and interaction between the XT PC-DOS-based applications and the mainframe host. In this article we'll take a look at the XT/370.

WHAT IS THE XT/370?

The XT/370 operates in one of three ways: as an XT personal computer, an interactive full-screen terminal connected to an IBM mainframe computer, or as a mainframe-like system executing 370 programs. By using a "hot" (ESC) key, you can run in one or all three contexts concurrently.

In PC mode, the XT/370 operates as a regular IBM PC XT with 640K bytes of RAM (random-access read/write memory) and one or two 10-megabyte



Photo 1: *The XT/370 from IBM.*

fixed-disk storage units controlled by PC-DOS 2.0. It is slightly slower than the vanilla XT model, because some of the RAM operates more slowly to accommodate other microprocessors in the XT/370.

When operating as a mainframe computer terminal, the XT/370 emulates an IBM 3277 Model 2 display: a 24-line, 80-character-per-line, monochrome full-screen terminal. In this mode, you can interact directly with a mainframe host, including IBM's 370, 43XX, or 30XX processors. Because of a third mode, the mainframe can operate under VM/SP (Virtual Machine/System Product) interacting with the user through

CMS (Conversational Monitor System). CMS provides a timesharing environment for editing, compiling, debugging, and executing programs in a variety of languages. Under CMS, your XT/370 can store and retrieve data on magnetic tape and disk, route input and output to and from record equipment, such as card readers and line printers, or to other mainframes as well.

When operated in the System/370 mode, the XT/370 uses 480K bytes of real main storage. The system contains hardware that can map 4096K bytes (4 megabytes) of virtual memory onto the real memory using the 370 relocation method. The keyboard and display

A qualified success, IBM's XT/370 represents a genuine advance in desktop computing

operate as an IBM 3277 Model 2, and the disk and fixed-disk storage are accessible as CMS virtual-disk storage. Added to these features are a link to the IBM mainframe allowing access to its virtual disks for retrieving and storing programs and data, and access to printers for high-speed listings. The mainframe link can also upload/download files between the XT/370 and the mainframe host. If the XT/370 is locally attached—that is, connected through a mainframe channel—data is transferred at rates exceeding one million bps (bits per second).

THREE ADDITIONAL BOARDS

You can buy an XT/370 as a package, or you can upgrade an existing XT or IBM PC. The 10-megabyte fixed-disk version is the 5160 Model 588. If you need 20 megabytes (two fixed disks), you need the Model 568 without disks and the 5161 Model 3 expansion unit with two fixed disks. To upgrade an existing XT, get the XT/370 Option Kit—feature 3891. The kit even includes a new nameplate. Make sure your original computer has 256K bytes of RAM on the motherboard. In addition to the XT/370 or upgrade, you'll need software for terminal and 370 modes and manuals for diagnostics and reference.

The XT/370 includes a monochrome display and an adapter board. You can use a color monitor, but its color and graphics features are unavailable in ter-

minal or System/370 mode. The three boards that operate the two extra modes are the XT/370's most significant feature. One board operates the System/370 processor, another serves as both System/370 main storage and XT storage, and the third provides a mainframe connection.

The processor card (PC/370-P card) contains three microprocessors and a 370-page table with room for 1024 entries. A 370 VM/CMS page contains 4096 bytes, so the processor card supports a 1024 by 4096 or 4-megabyte virtual-address space. The processor card must be installed in slot 4 of the XT.

The processor card uses two Motorola 68000 chips and an Intel 8087 chip for the System/370 operation. One 68000 performs instruction fetch, decoding, and emulation of most 370 fixed-point instructions. It also uses its registers and program counter to emulate both the 370 general-purpose registers and program status word (PSW).

The second 68000 manipulates the 370-page table, processes exceptions (invalid op codes, zero divide, etc.), and emulates system-related fixed-point 370 instructions. This includes the supervisor call (SVC x'0a') op code used to pass requests from application programs to the CMS monitor and the DIAGNOSE (x'83') instruction. On a mainframe the DIAGNOSE instruction passes function requests beyond the

CMS monitor to the VM control program monitor, and on the XT/370 DIAGNOSE communicates function requests from the System/370 mode to PC-DOS.

The 8087 processor performs 370 floating-point instructions. Its registers emulate the 370 floating-point registers.

The memory card (PC/370-M card) contains 512K bytes of parity-checked RAM. It must occupy slot 3 of the XT. The memory is accessible from both the XT's 8088 processor and the System/370 processor card. The 8088 has priority over the processor card to ensure that time-critical operations, such as interrupt processing, are carried out properly.

When accessed by the 8088, the memory on the PC/370-M card is addressed as locations 256K on up, with the last 128K bytes mapped out. When accessed by the processor card, the first 480K bytes appear as locations 0 to 480K bytes of System/370 memory. The remaining 32K bytes are used for storing 68000 microcode used to emulate the 370 functions and interface operations with PC-DOS as carried out by the second 68000. The memory on this card operates slightly slower than the XT memory on the motherboard. This

(continued)

Ernest Sabine is a division leader in the systems development division at the Charles Stark Draper Laboratory (Information Systems Department, 555 Technology Sq., M.S. 33, Cambridge, MA 02139).

XT/370: The Missing Link BY PAUL E. HOFFMAN AND G. MACK HICKS

IBM's introduction of the XT/370 will affect more people than just those who work with the IBM 370 mainframes.

If you're confused by the introduction of a "desktop" 370, remember first who IBM is: a company with 370,000 employees and an annual gross income of more than \$40 billion. If you are familiar only with IBM's microcomputers, you may not realize that, in spite of all the interest and excitement generated by the PC family, it represents only about 5 percent of IBM's income.

IBM's announcement of the XT/370 last October illuminates two major marketing strategies for the PC and 370 lines. First, IBM treats the PC as little more than a box that can be easily expanded with more powerful central processors. Second, the 370, IBM's primary mainframe offering, can now be on any user's desk as a real computer, not simply as a terminal. IBM recently stated that its major push for the rest of the eighties is toward intelligent workstations instead of completely centralized mainframes or completely decentralized microcomputers.

If you dismiss the XT/370 as simply part of a new method that IBM has devised to sell terminal equipment to 370 mainframe owners, you have missed the point. IBM would be happy to start you on an XT, upgrade you to an XT/370, and then eventually hook you into a 370 for software distribution. Thus, even if you do not currently use a mainframe computer, IBM's microcomputers give you an upward path to them. You are not required to use a mainframe 370 in order to use an XT/370.

DOWNLOADING PROGRAMS, NOT JUST DATA

Because the XT/370 uses the exact same instruction set as the 370 mainframe, you can copy executable programs from the mainframe to the microcomputer and run them directly. For example, imagine it is just before noon, and the mainframe 370 is becoming terribly slow. You really want to run a large database job, but you are afraid it may take hours at the current load. Instead of being tied to the mainframe, you can simply make a copy of the

database-management system on your XT/370 and run the job on your own system.

In fact, you do not need to download the program from the mainframe: if your office mates have it on their systems, they can give it to you on an ordinary floppy disk. You might even buy an XT/370 simply to run all of the thousands of programs that are already available for its mainframe namesake.

In the future you can expect IBM to use the XT/370 to distribute business software electronically. This, of course, will introduce further software licensing problems. IBM requires a separate license for each XT/370 on which a mainframe program runs. It has begun distributing directions for downloading programs onto the XT/370 with the standard software documentation. Other software vendors will probably do the same soon.

THE VM/PC OPERATING SYSTEM

Your interface with the XT/370 is almost identical to your interface with a 370. VM/PC (Virtual Machine/Personal Computer) control-program commands on the XT/370 are directly compatible with VM/SP (Virtual Machine/System Product) commands on the 370. This is important to microcomputer users for two reasons. First, if you already use VM/SP on a 370, you will be completely comfortable with your new XT/370. Second, while you can run PC-DOS on this new computer, IBM downplays its importance. (Anyone who feels that IBM has a long-term commitment to Microsoft and MS-DOS should take note.)

The user's interface to VM/PC and VM/SP is called CMS, which stands for Conversational Monitor System. You give commands to CMS in a fashion similar to the way you give commands to CP/M or MS-DOS: you respond to a prompt by typing in a command followed by a number of arguments. CMS runs under CP, the control program. (In fact, the command syntax of Digital Research's CP/M was derived from IBM's CP.) CMS is the most popular operating system within IBM and is used extensively by its huge marketing staff.

CMS is also used on many of IBM's other large computers, including the 360, the 4300, and the 308X series. If you've used any of these computers, you will have no problems using the XT/370. Though certain programs do not run on the XT/370, the problem is with the current version of VM/PC, not the hardware. Future versions of the VM/PC will be able to run even more programs.

Two of VM/SP's major tools are its editor, XEDIT, and its batch programming language, EXEC. With these tools, any programmer can create a wide variety of environments for users, such as interactive help and menu-driven processing. The distinction between the editor and the batch processor is blurred, since you can give the editor a list of commands to perform on a set of files and even execute operating-system commands from within it. XT/370 users are given both of these programs as part of VM/PC.

One of the unique features of the XT/370 is its ability to access disks on the mainframe as if they were its own. For instance, when you download Pascal/VS from a 370, you can choose to copy only a few of the program libraries. Then, simply link the disk on which they reside on the mainframe to VM/PC with a command. When Pascal/VS looks for the libraries, it will go through its normal search order, first on the XT/370, then on the mainframe.

VM VS. PC-DOS PROGRAMS

Because VM programs use virtual memory, a program has available an almost unlimited amount of memory space. Most PC-DOS programs address only 128K bytes; imagine similar programs that can use up to 4 megabytes, or 32 times as much memory. With virtual memory, the limited text editors and formatters of PC-DOS could become incredibly powerful tools.

Other business programs, such as spreadsheets and database managers, also thrive with the significant increase in available memory. When VM program designers work, they do not need to worry about memory limitations nearly as much as their microcomputer peers. This results in more powerful programs

that are laden with features.

THE FUTURE

Although many people think of the PC as a full-blown microcomputer, IBM conceives of it as an easily upgradable box with many expansion slots, a bit of memory, some mass storage, and an insignificant central processor. (In fact, when you run VM/PC, you use the 8088 as an I/O processor.)

You will see a number of impressive innovations on the PC in its configuration as an XT/370. More people who work in companies with 370s but have no access to the computer will have XT/370s on their desks and will use them for the majority of their business communications.

It is always difficult to tell which of IBM's new products it intends to push and which are red herrings. For instance, many people felt that IBM "legitimized" the UNIX market with its PC/IX announcement; since then, almost nothing has been heard of the product. However, the XT/370 is certainly going to be important to IBM, because it gives IBM an easy way to let users reduce the strain on their 370 mainframes and inexpensively gives end users more power at the same time.

The XT/370 is a strong entry into the new market of decentralized mainframes. Instead of coming up with a new mainframe, IBM designed a new microcomputer that works with the already established line. In fact, it also used an already existing communications path between the two computers, so that the IBM PC/XT could be easily integrated into the current 370 environment. Both mainframe users and microcomputer users will soon see the results of this development, and within a few years, it may be hard to tell the two sets of users apart.

Paul E. Hoffman (2000 Center St., Suite 1024, Berkeley, CA 94704) is the coauthor of the MS-DOS User's Guide, recently published by Osborne/McGraw-Hill. G. Mack Hicks (26 Carl St., San Francisco, CA 94117) is a senior systems consultant for the Bank of America.

allows it to meet the timing constraints designed in the processor card.

The 3277 emulation card (PC/370 EM card) must occupy slot 2 in the XT. It contains the circuitry and coaxial connector for attaching the XT/370 to an IBM mainframe. The coax, which can be up to 2000 feet long, is run to an IBM 3274 Display Control Unit with a type B terminal adapter. The 3274 may be locally attached to a high-speed data channel (about 1 megabyte per second) or connected through a synchronous data link control (SDLC) telecommunications link, typically at 4800 or 7200 bps.

TWO OPERATING SYSTEMS

The software for the XT/370 includes PC-DOS 2.0 and a "Licensed Product," Virtual Machine/Personal Computer (VM/PC), which operates only on the XT/370 version of the XT. While operating as a personal computer, the XT/370 requires only PC-DOS. You'll need both software components for operating your XT/370 as either a 3277 display terminal or in System/370 mode.

Besides supporting the XT/370 as a personal computer, PC-DOS performs the same functions on the XT as the VM control program does on a mainframe 370: file handling, paging I/O, display and keyboard I/O, and file transfers between the XT/370 and the mainframe. Requests for I/O by a 370 program are reflected to PC-DOS by interrupts generated when the 370 DIAGNOSE instruction is executed. This instruction is used by the CMS monitor to pass system-related function calls to the VM control program monitor on a mainframe. On the XT/370, PC-DOS processes the interrupt, and the associated I/O parameters are passed to an I/O driver running under PC-DOS.

VM/PC is a "skinny" version of IBM's VM/CMS mainframe timesharing operating system. It allows 3277 display terminal emulation, includes utilities for moving CMS formatted files between the XT and the mainframe, and transfers files on the XT between CMS and PC-DOS.

Using the PC-to-mainframe link, an XT/370 CMS application program can access CMS files on the mainframe, record by record. Print files, created by the CMS application, can be spooled either to a printer connected to the

XT/370 or to the mainframe for high-speed output.

VM/PC also supports CMS I/O devices such as the console (the keyboard and display), local CMS virtual disks on fixed-disk and floppy-disk drives, and local printing. It also enables you to remotely access CMS files and the printer spool on the mainframe. The full CMS and control-program command repertoire is available, including the full-screen XEDIT file editor, the EXEC2 command language (a more powerful batch-like command processor), and the DEBUG subcommand environment. VM/PC also includes a 370 Processor Control debug function that provides access to the 370 registers, program status word (PSW), and main storage. It also allows execution and tracing of 370 programs in single step and stop-on-address-compare modes.

Besides XT/370 resident software, VM/PC includes a remote server program that operates on the mainframe host. The remote server coordinates data transfer at the mainframe end, between the XT/370 and the host.

VM/PC provides a full CMS environment, but you may want to run other 370 applications under CMS as well. You can download any 370 program running on the mainframe to the XT/370 and it will operate correctly if its I/O is restricted to the XT/370 CMS devices; its real and virtual storage requirements do not exceed 416K bytes and 4 megabytes, respectively; and it has no time or operating system's internal dependent code.

Compilers, data management, financial analysis, and other types of packaged applications software present a special case if they are sold, leased, rented, or otherwise licensed for use on the mainframe only. Third-party 370 applications software vendors will have to establish additional policies for distributing their products on the XT/370. Most mainframe pay-for-use software packages lack copy protection. IBM has already established a pricing policy on its software products, which includes a gentleman's agreement on distribution to paying XT/370 customers only.

The XT/370's functions add considerable storage requirements to those of PC-DOS. Table 1 presents the RAM and fixed-disk requirements for both PC-

(continued)

DOS and VM/PC. Free storage on the fixed disk can be severely constrained if several of the commonly used compilers are included. For example, if you run both the COBOL and PL/I compilers, less than 50 percent of a 10-megabyte fixed disk is left for source, data, and other user files. Using a single disk can also constrain performance, especially if you load your compilers frequently. In that case, you may need two fixed disks, one for the operating system and compilers and the other for user files.

OPERATING THE XT/370

Because the XT/370 has multiple modes, you can operate it as a personal computer or a remote terminal hosted to a System 370. Here are a few typical operational scenarios:

- CMS/PC-DOS bridge. By capturing data from PC-DOS, perhaps on disk, you can import it to the local CMS for subsequent processing. Exporting data would reverse the operation.
- Local CMS editing/remote computing. By using XEDIT on the XT/370 for file editing, you avoid response-time delays because of a mainframe's heavy workload. You can also SPOOL source programs and data to the mainframe for processing.
- Local compilation and testing/remote computing. You can go the above step one further on the XT/370 by using a local copy of a 370 compiler.
- Local computation/remote database. You can compile data locally or extract object programs from the mainframe and run them under CMS on the XT/370. You can also access files from a large, perhaps shared, database on a mainframe.
- Local database/remote computation. Using local data on the XT/370, you can execute central-processor or large memory-intensive programs on the mainframe. The results can be returned to the XT/370.
- Local computation/local database. You can use the XT/370 locally to process sensitive or proprietary data and programs.

while another mode is still executing. Although you can run a local and remote CMS session and move files across the systems concurrently, you'll probably find it difficult to work on parallel activities. The easiest way to take advantage of multiple operations is to spin off the printing, file access and transfer, and remote batch jobs that don't require your interaction. It would be less confusing to use multiple sessions if the file and spooling functions were unified so the user could "reach out and touch" software tools and data from one environment while operating in another. Some commands used in CMS have similar counterparts in the CP monitor,

which leads to occasional confusion as to whether you're in the VM/CP or CMS environment.

Like any computer, the XT/370's performance depends on the characteristics of the workload. Any computer can be made to look either very fast or slow with a careful selection of programs.

For raw number crunching in System/370 mode, the XT/370 operates at approximately 0.2 million instructions per second (MIPS), slightly slower than an IBM 4331-1 mainframe carrying a \$70,000 sticker price. The floating-point speed derives from the math chip on the processor card.

Table 1: XT/370 storage requirements.

MAIN STORAGE:		
Use		Storage (K bytes)
Processor control storage		32
VM/PC control program		64
370 CMS/user memory		416
	Total	512

FIXED DISK:		
Use		Storage (megabytes)
PC-DOS 2.0		0.1
VM/PC system		1.5
	Total	1.6

OTHER 370 SOFTWARE FOR FIXED DISK:		
Software		Storage (megabytes)
ASSEMBLER H		0.2
BASIC processor and library		0.5
COBOL compiler and library		1.0
FORTRAN VS compiler and library		1.5
PASCAL VS compiler		1.2
PL/I optimizing compiler and libraries		3.0
DCF (SCRIPT VS)		0.6

Table 2: List prices for a basic XT/370.

Hardware		
5160 model 588 (XT/370)		\$8085
5151 monochrome display		275
5152 80-cps graphics printer		449
4900 mono display/printer adapter board		250
5162 printer cable		45
	Subtotal	\$9104
Software		
DOS/BASIC 2.1		\$ 65
VM/PC		1000
	Subtotal	\$1065
Manuals		
XT/370 Hardware Maintenance		\$ 60
XT/370 Technical Reference		28
	Subtotal	\$ 88
Total cost for base unit		\$10,257

With VM/PC you can switch modes

THE XT/370

For raw number crunching, the XT/370 operates at approximately 0.2 million instructions per second, slightly slower than a \$70,000 IBM mainframe.

When executing CPU-bound code, using a general mix of LOAD/STORE/BRANCH type of 370 instructions, the system executes at approximately 0.1 MIPS. For short, interactive programs such as a text editor or data entry, this speed is quite adequate. Compiling large source programs can take much longer than the same activity conducted on a 370 mainframe.

A more subtle performance phenomenon occurs when you're executing programs using extensive 370 supervisor instructions. These instructions change the state of control registers and page tables and cause 370 system state changes, all of which require more microcode and time than a simple LOAD or STORE.

I/O-intensive programs accessing a fixed disk will run quite slowly because PC-DOS performs the I/O through the XT 8088's 8-bit data path. I/O access to data on the mainframe through the coax/3274 controller link can be quite fast if the 3274 is attached to a channel and the mainframe is not heavily loaded. A remote 3274 will suffer from telecommunications data rates so slow as to require short records or transmission to be infrequent.

COSTS

Operating the XT/370 requires you to purchase both XT-related hardware and software. You'll also incur the costs of connecting to the mainframe. Table 2 lists the base price of an XT/370 with

(continued)

Don't let the competition sneak up on you.



©1983 Art Clokey

Be up and running with The Assistant Controller™ Flexible Accounting Systems from Lake Avenue Software

Written entirely in dBASE II by CPAs. Source Code and Modifications Available. Fully Integrated or stand-alone. Accounts for up to 999 departments. Automatically consolidates reports. Complete Audit Trail. Detects out-of-balance transactions. For PC-DOS, MS-DOS and CP/M Systems. \$475 per module.

- General Ledger
- Financial Reporting
- Accounts Receivable
- Accounts Payable
- Payroll
- Professional Time & Invoicing
- Job Costing

The Assistant Controller™ Series

LAKE AVENUE SOFTWARE

77 North Oak Knoll, Suite 105 • Pasadena, CA 91101 • (818) 792-1844

dBASE II is a registered trademark of Ashton-Tate.



TOTAL CONTROL

WITH LMI FORTH

PC FORTH™
IBM PC & XT,
HP-150,
Macintosh,
Apple II,
CompuPro,
Sage & CP/M-68K,
Wang PC,
 All CP/M and
 MSDOS computers.

Try the professional language offering the utmost performance in the shortest development time. Transport your applications between any of our enhanced 83-Standard compilers or expanded 32-bit versions. Choose from our wide selection of programming tools including native code compilers, cross-compilers, math coprocessor support, and B-Tree file managers. All fully supported with hotline, updates, and newsletters.

Laboratory Microsystems Incorporated
 Post Office Box 10430, Marina del Rey, CA 90295
 Phone credit card orders to (213) 306-7412



a monochrome display and a 10-mega-byte fixed disk. The \$10,257 price tag does not include PC-related software and extra hardware, which could bring the actual purchase price up into the \$12,000 to \$14,000 range. Clearly, the XT/370 is to be used in the IBM mainframe environment, where monthly budgets for system hardware may fall in the \$20,000 to \$2,000,000 range. If you already have an XT system, you can upgrade it to the XT/370 for \$3790. (Order the IBM Personal Computer XT/370 Option Kit, feature 3891.)

The additional mainframe costs include coax cable and 3274 port connections. They can run from \$100 to \$200 per terminal. The number of XT/370s actively connected to a 3274 control unit affects total performance. Extensive file transfers will slow 3274 performance and cause poor response times from other terminals connected to the same 3274.

If you use leased software, add it to your operating costs. IBM's policy on VM/CMS licensed program products is to charge a monthly usage fee for each

XT/370 using the software. Table 3 shows the monthly charge for some of IBM's commonly licensed products.

Balance against these costs the potential savings in mainframe costs that using the XT/370 can mean. If you purchase the XT/370 in lieu of an IBM display terminal, you'll save about \$2000. You'll realize an indirect saving by reducing the load or response time of the shared mainframe. This can, in turn, postpone mainframe upgrade expenditures. The most important savings, and the most difficult to measure, are

The Fifth Generation By David L. Cohn

Once again, the Japanese are taking an American idea, modifying it, and selling it back to us. In the past, it was TVs, stereos, and automobiles. Now, it is computer "generations."

Generations began simply enough. When transistor-based computers were introduced in the late fifties, a major change took place. Suddenly, the old vacuum-tube machines were obsolete and a new era had dawned. The old machines became the first generation, and the new machines the second.

In the mid-sixties transistors gave way to integrated circuits, and IBM's System/360 heralded the arrival of a third generation. The increased circuit integration of the IBM System/370 earned it the title of fourth generation. Since then, there's been chaos. No new technology has been anointed as the fifth generation.

The family tree seemed so pat. A new generation was declared whenever circuit technology changed the nature of computers. At each step, computers became more available and more important. Unfortunatly, since the System/370, computers have improved through evolution, not revolution. There have been no new generations... or have there?

The Japanese have been watching. They saw that no one had used the fifth-generation label. They grabbed it and turned it to their own purposes. They would have us believe that fifth generation means artificial intelligence and talking computers and listening computers and fancy software and robots and... Enough!

"Generations" refers to circuit technology, not applications. Sure, applications are important; sure, the Japanese

pose a threat. Sure, we must reclaim our technology leadership. But let's start at the beginning; let's reclaim our terminology leadership.

THE REAL FIFTH GENERATION

The fifth generation means microprocessors! There, I said it. In the past, hardened computerists, those who dealt with mainframes, would have laughed at such a statement. "A microprocessor isn't even a computer," they would say. "Clearly, it can't be the next generation of computers."

Although that might have been true of the 6502s and even the 8088s, it's no longer true. The IBM PC XT/370 is a real computer with a real operating system and real programs. It even offers virtual memory.

Perhaps the greatest problem with declaring microprocessors as the fifth generation is that they, too, are based on integrated circuits. Consider this, however: the large-scale integration (LSI) circuits of the fourth generation evolved from the small-scale integration circuits of the third generation. What mattered was that this evolution in component technology changed the nature of computers. The same thing is true of the transition to microprocessors. Although they evolved from LSI technology, they have undeniably altered the concept of a computer.

But why declare the XT/370 the fifth generation of computers? Why not the PC? Or the Apple II? Or the Altair? Because the XT/370 brings the microprocessor directly into the world of the big computer. It cannot be dismissed as a hobbyist's toy. With its System/370 instruction set, its powerful system software, and its high-speed communication, it can

act as an integral part of a larger computer.

Just as each of the first four generations marked a distinct role for computers, so does the IBM PC XT/370. Soon these machines will be connected into networks of interoperating systems. In fact, one of the nicest features of the XT/370 is its high-speed communication with a host computer. When the host is running IBM's virtual machine (VM) operating system, an XT/370 can access host files as if they were local. All of VM's file protection and multiple-access features are still in place, but the processing is done in the small computer.

If my argument has a weakness, it is that the IBM XT/370 is not really "a microprocessor." In fact, it uses three microprocessor chips and a fourth coprocessor. These function as two cooperating computers to form the full system.

The familiar 8088 processor on the PC motherboard is really a slave computer in the XT/370. It acts as an I/O (input/output) processor to the XT/370 processor. The 8088 takes care of the keyboard, screen, disks, and communications hardware. Most of these devices use standard PC-DOS routines to respond to XT/370 processor requests. The major additions to the XT/370 include the new 3277 emulator board, which allows high-speed communication with an IBM host.

The other two microprocessors and the coprocessor (an 8087 and two 68000s) form the XT/370 processor. The System/370 instruction set is too complex to be controlled by a single chip—that is, by a single chip using 1982 circuit technology. (It takes a while to go from chip design to finished computer.) IBM decided to divide the instruction set into three pieces

in your own improved productivity. An XT/370 user can now compute at a pace independent of mainframe load and availability.

A NEW DIRECTION

As a personal computer, the XT/370 fits close to the top of the IBM PC line. Most of its memory is slower, its fixed disk has less free space available, and the loss of three board slots restricts the number of board-level products that you can add.

Within the VM/CMS environment, the

XT/370 can only benefit by its coexistence with a personal computer operating system and from the thousands of available microcomputer software packages. Software innovation over the past five years has come for the most part from the microcomputer end of the industry. Mainframe software innovation suffers the inertia of having to support older software and hardware technologies even on new hardware. For most mainframe users, however, the XT/370 link—though it's designed to be used with a mainframe—is not general

and incorporate each piece on a separate chip. The three sets include the popular nonmathematical instructions, the popular mathematical instructions, and everything else.

The first instruction set is on a modified 68000 chip. Its microcode has been altered so that it responds to System/370 instructions rather than 68000 instructions.

A modified Intel 8087 is used for the important mathematical instructions. The chip now does arithmetic according to the IBM standard rather than the IEEE standard. The differences are in the details, but the XT/370 will produce precisely the same numerical results as a large IBM mainframe.

The leftovers in the third set are accommodated on a second 68000. This one uses standard 68000 instructions to do these odd jobs. It's a bit slow, but these instructions aren't used much.

THEORY AND PRACTICE

Together, the three processors make up the central processing unit of a mainframe System/370 computer. They can run almost all programs on an XT/370 that can run on a mainframe 370.

The major limitation relates to memory addressing. Even though the memory shared by the XT/370 processor and the 8088 contains 512K bytes, the XT/370 can use 4 megabytes. If the XT/370 wants data not in the physical memory, the 8088 fetches it from a DOS file on the disk. In this way, the XT/370 processor can address up to 4 megabytes of "virtual memory." However, a large 370 has 16 megabytes of virtual memory. Therefore, the unusual program that needs more than 4 megabytes won't run on an

IBM PC XT/370.

For an operating system, IBM has developed VM/PC (Virtual Machine/Personal Computer). This popular software is really two pieces: VM/CP (Control Program) and VM/CMS (Conversational Monitor System). CP is the basic interface to the hardware and CMS is the user interface.

For the IBM PC XT/370, portions of the control program run on the XT/370 processor and portions on the 8088. This software was created especially for the XT/370. CMS is a direct descendant of the mainframe CMS. All other software comes straight from the big System/370s: the same compilers, the same editors, the same applications.

On mainframe System/370s, it is possible to use environments other than CMS. In fact, some researchers even run UNIX. On the XT/370, IBM supports only CMS. However, provisions exist to create other environments, and someone may choose to create them.

Thus, the IBM PC XT/370 is a true System/370. It marks the first time mainframe power can sit on a desktop. It certainly won't be the last. DEC is preparing a desktop VAX. IBM may use its XT/370 chip set in other packages. It may even be possible to fit the entire System/370 instruction set onto one chip using 1984 technology. In any case, the IBM PC XT/370 is a definite step forward in computer technology, the first of a new breed of computers—the Fifth Generation.

David L. Cohn is an associate professor of electrical engineering at the University of Notre Dame (Dept. of Electrical Engineering, UND, South Bend, IN 46556).

Table 3: Monthly charges for licensed XT/370 software.

370 Product	Monthly Charge per XT/370
ASSEMBLER H	\$9
BASIC	\$21
COBOL (Compiler)	\$19
COBOL (Debug)	\$21
DCF/SCRIPT	\$18
FORTRAN (VS)	\$17
PL/I (Compiler and Library)	\$29

enough to support their software. The IBM MVS and DOS users and people who use incompatible mainframe systems will have to wait for the next upgrade.

The market will determine the value of the XT/370. Unfortunately, the large and growing number of IBM mainframe VM/CMS sites has a relatively small budget and attendant hardware. For IBM, the value, beyond revenue, of the XT/370 is its position as a desktop version of a mainframe system. This presents direct competition to desktop 370 vendors such as Canaan Systems and Spartacus Computer and indirect competition to vendors of plug-compatible mainframe and desktop-to-mainframe systems alike.

Viewed as the first in a series of desktop systems, the XT/370 is a qualified success. The hardware and software design teams at IBM deserve credit for fitting all of the 370's features into the XT. Future advances and integrations might result in an even better computer. For example, IBM might add:

- Speed—there's never enough
- More RAM storage—at least 1 megabyte for VM/CMS; more for MVS
- Greater and faster fixed-disk storage
- Better I/O support—a 16- or 32-bit data bus
- MVS operation—needs a "skinny" MVS
- Autonomous operation—comes as a result of more storage above
- Color display support—3270 PC and 3279 display
- Networking support with integrated remote file management. ■

NUMBER CRUNCHING ON IBM'S NEW S9000

*IBM joins with MIT's National Magnet Lab
to develop spectrometers for imaging systems*

BY DAVID J. STATES



Photo 1: IBM's scientific computers, the S9000 series. At right is the S9001, at left is the S9002.

The National Magnet Lab NMR group, which builds and supports high-performance nuclear magnetic resonance (NMR) spectrometers for research use, has recently collaborated with IBM in the development of NMR imaging systems. In the past, the lab has used minicomputers such as the PDP 11/34 to control spectrometers, but for this project we elected to use the IBM S9000. While the S9000 is a desktop computer, it is based on the Motorola 68000 processor and has considerable processing power. This was enhanced by the SKY MNK-V array processor from SKY Computers (figure 1). The 24-bit address

space of the 68000 and the S9000's ability to support large amounts of RAM (we use as much as 2 megabytes in some machines) make the S9000 suitable for running the large control and analysis programs used in NMR spectroscopy and imaging.

Figure 2 is a block diagram of the electronics in our imaging spectrometer. NMR signals are generated by exciting a sample in a high magnetic field with RF (radio frequency) pulses from the transmitter. These signals are amplified in the receiver, digitized, and averaged. NMR imaging uses magnetic-field gradients to label nuclei spatially. In modern

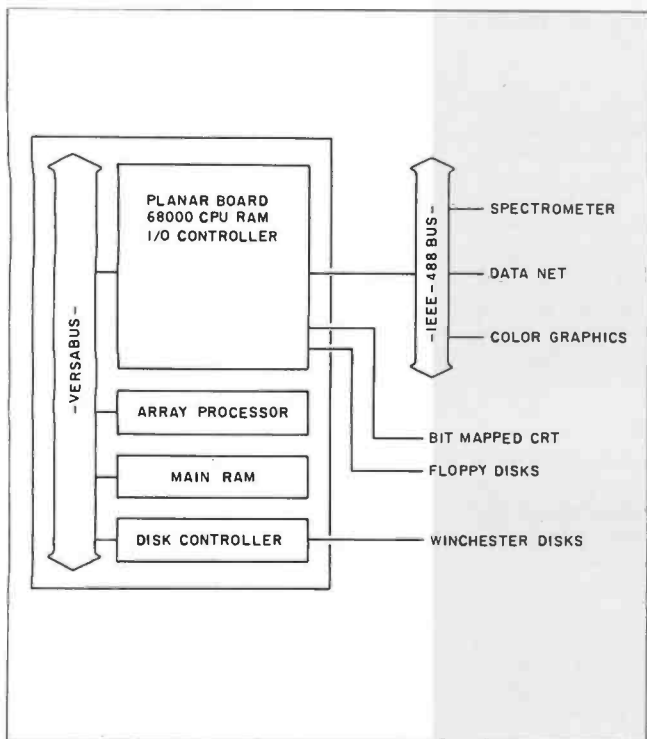

Figure 1: The architecture of the S9000 computer system used in the MIT NMR project. The 68000 CPU and SKY MNK-V array processor share access to memory over the VERSABus. You can use as much as 2 megabytes of memory in imaging applications.

NMR spectroscopy, experimental control and data processing are performed digitally. Our design emphasizes modularity and standard interfaces so we can customize the spectrometer by swapping modules. The use of multiple independent processors simplifies design and eliminates bus contention problems.

NMR includes two important time scales. The first is the time scale of nuclear spin motion in the magnetic field, typically involving fractions of microseconds. The RF hardware and custom-built pulse programmer in the spectrometer deal with these extremely rapid events. The second time scale deals with repetitive-signal averaging and the user interface, events that take about a second. This regime is coordinated by the host computer.

Our control program is based on a powerful command parser. Making all aspects of spectrometer control accessible through the command language gives us versatility, and a sophisticated set of control-flow operations in the command language let us program and execute complex experimental protocols easily. The command interpreter allows us to define symbols and macros of commands. Loops, branches, and conditional branching are supported within macros, and macro calls can be deeply and recursively nested.

In a typical experiment, the pulse programmer is triggered, the signal average records from 1000 to 16,000 data points, and a subset of this data is sent back to the host to be displayed. When signal averaging is complete, the entire data set is sent to the host, stored on disk, and manipulated in a variety of ways such as scaling, baseline correction, Fourier transformation, data smoothing, and application of resolu-

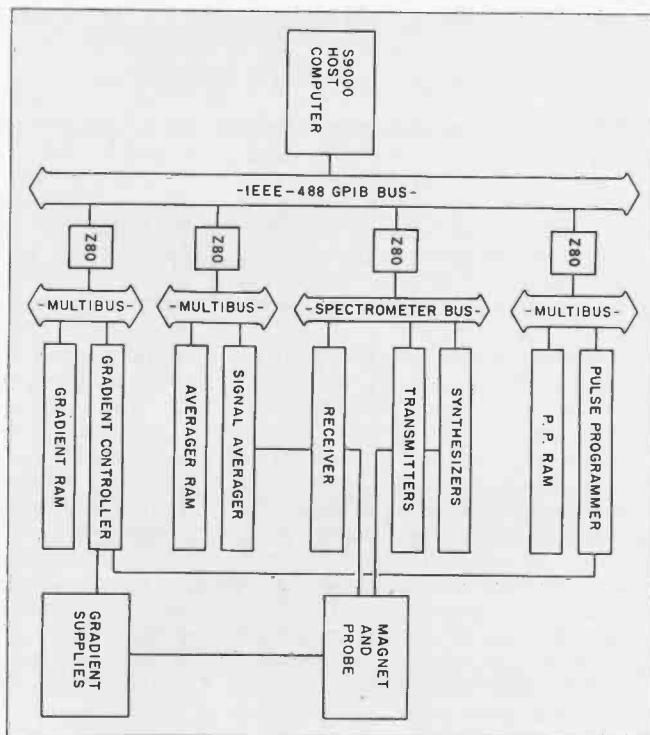

Figure 2: The electronics of a state of the art NMR imaging spectrometer. Nuclear spins in the sample probe are excited by RF pulses from the transmitter, and their response is recorded by the receiver and signal averager.

tion enhancements.

Because some experiments run for hours, we needed the ability to perform simultaneous data acquisition and analysis. This is achieved through multitasking. One task runs the command interpreter and interacts with the user, while a second monitors the actual hardware.

The hardware-control task is responsible for real-time chores such as polling devices and fetching data during free periods of the signal-averaging cycle. Since these free periods might be as short as 100 milliseconds (ms) and as much as 8K bytes might have to be fetched, a reasonably fast transfer is necessary. The IEEE-488 general-purpose instrumentation bus (GPIB) from National Instruments serves this purpose and is supported by a fast direct memory access (DMA) port on the S9000. The CSOS operating system provides asynchronous I/O (input/output) and intertask signaling capabilities necessary to coordinate the activities of the main command interpreter and the subordinate hardware-control tasks.

Our spectrometer control program, RNMR, was developed by Dr. David Ruben at the National Magnet Lab (NML) and consists of approximately 20,000 lines of FORTRAN code and an additional 2000 lines of assembly-language support

(continued)

David J. States, M.D., Ph.D., wrote this article while he was doing research at the Francis Bitter National Magnet Laboratory at MIT. IBM was collaborating with the laboratory in imaging medical applications.

States has begun his internship at the University of California, San Diego, Medical Center (225 Dickinson Rd., San Diego, CA 92110).

Scientific Computing: The Shortcomings of the Micro

The university computing centers of the sixties provided a haven for the growth and development of computing technology, primarily applied to scientific number crunching. Similarly, the minicomputers of the seventies were developed and applied with great success in scientific work. Microcomputers with significant computational power have recently appeared, and they are becoming increasingly attractive as scientific processors. The desktop IBM S9000 and SKY array processor used in this project perform the computations we need in our work at a real rate of better than 2 microseconds per floating-point operation. To appreciate how impressive this is, remember that the ENIAC, that room-sized behemoth that gave birth to electronic computing, required 200 milliseconds to do the same operations. In an hour of processing, the S9000/SKY system will do more computation than the ENIAC did in its entire lifetime! Raw arithmetic benchmark speed is not the only requirement of a scientific computer, however.

Scientific work usually involves work with floating-point numbers, big programs written in FORTRAN, and the manipulation of substantial data sets. Program development is often a major part of the task. Where are micros weak? First, there have been problems with support, documentation, and access to experienced users. Microcomputer compilers have also not been up to snuff, and FORTRAN is probably the worst offender. If program development is your work, compilation speed and reliability is essential. Micro compilers and linkers operating off floppy disks are just not fast enough. Computing speed has also been an issue. Floating-point arithmetic has, in the past, been too slow on micros to be useful. The storage capacity of floppy disks has also been insufficient for reasonable-sized programs (or even source listings). And then there are bugs.

What is the cost of a bug? With a major demonstration and site visit coming up on December 4, I came into the lab on December 1 and found my computer hung up. I tried rebooting, but that didn't work. I tried going back to backup copies of the software. That didn't work. I figured that maybe my machine was flaking out, so I tried running the program on two others. Still no dice. Panic! Why does my program load, begin execution, and then just hang up? About 3 a.m. on December 2, I finally found the answer. It was not my program after all. There was a small

error in the system relative time clock that caused it to return a year and 100 milliseconds when you asked for a 100-millisecond delay during the month of December. With the last month of the year, the carry got screwed up. Logical, right? No problem. By 3:30 a.m. I had everything converted over to absolute times and running perfectly. Of course, my hairline had receded a quarter inch, and I had barely spoken to my wife for two days.

A scientific computer cannot tolerate bugs. To date, micros have accepted far too many. In this regard, the big companies have a tremendous advantage and responsibility. I was disappointed with the extent to which even IBM was willing to cut corners on reliability and documentation in the early stages of the S9000 project. Perhaps it is unfair to compare a brand-new little machine with the mature VAX system, but the VAX is the current standard, and it has very few bugs.

COMPILER AND DATA STORAGE

Most scientific computing is performed with floating-point numbers. These numbers exploit our usual concern with relative rather than absolute precision, and they allow for a wide range of absolute values in the real world. In floating-point format, numbers are represented as the product of a power of two and a fraction. The exponent is used to obtain the range, while the fraction provides relative accuracy. For example, the number 12.0 is 1.5000 times two to the third power. In IEEE standard floating-point format, this would be coded as follows:

Sign	Exponent	Fraction
bit 31	30-23	22-0
12.0 = 0	10000010	(1)1000000000000000000000
+	(3 + 127)	(1.5)

where the exponent is shifted by 127 so that both large and small numbers may be represented, and the leading 1 in the fraction is implicit.

To add a pair of numbers, each must be separated into its exponent and fraction, the exponents must be compared, and one fraction must be shifted relative to the other so that they are aligned (in effect, multiplication by powers of two). Then the fractions can be added, and a new exponent must be calculated. Finally, the sum and exponent must be recombined to return the result as a new floating-point number. Microcomputers

usually perform floating-point arithmetic slowly because they must perform the bit manipulations in software. Larger computers do this in dedicated hardware, with a great improvement in speed.

COMPILERS

Scientific programming necessarily involves the use of compiled code to achieve adequate speed. With large programs, there is also a premium placed on the speed and reliability of the compilation. Micro compilers usually fail in two respects—they are slow, and they are buggy. They are slow because micros do not always have that much central-processor power and because most micros operate off floppy disks. Reading and writing work files on a floppy disk slows the whole process down to the lackadaisical speed of floppy-disk I/O. Also, interactive work on a timeshared system may not accumulate much total central-processor time, but what is used will be clustered into bursts of compilations and links. A micro capable of providing the same average computational rate will not compete in real response time. Hard disks and a 68000 processor go a long way toward overcoming these speed problems.

DATA STORAGE

Scientific computing often requires more storage capacity at greater speeds than micros have been able to provide. For data, the requirements are obvious, and most workers are quite aware of how much storage space they will need. Program development also requires storage space, but this requirement is often overlooked. For example, 10,000 lines of source code (a moderate-sized project) might contain 100,000 characters. Compiling it will generate object and/or listing files of comparable size. Allowing for a couple of backup copies, library files, sources for library files, the compiler, and the linker, the capacity of most floppy disks is rapidly exceeded. I/O to floppy disks is also slow. The one- and two-second delays every time you need a new piece of data off the floppy disk add up and take their toll in aggravation and lost productivity.

We overcame these problems by configuring our program-development stations with 10-megabyte hard disks. These give adequate storage space and cut access times dramatically. The hard disks allow you to scan through files about as fast as a video screen can display the data.

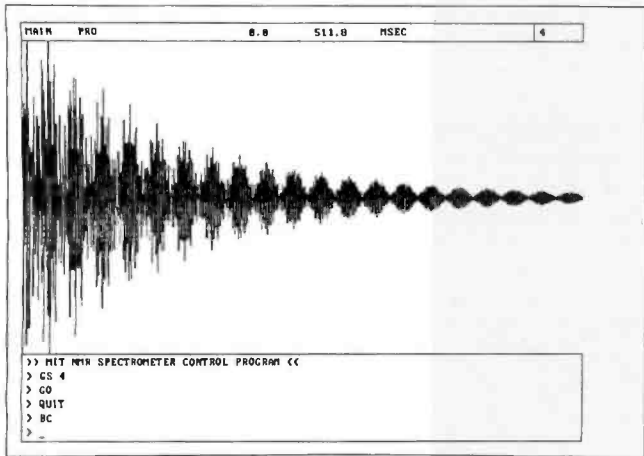

Figure 3: The raster graphics display of the S9000. You can draw data very rapidly by writing directly to the RAM, which is mapped bit by bit to the screen pixels.

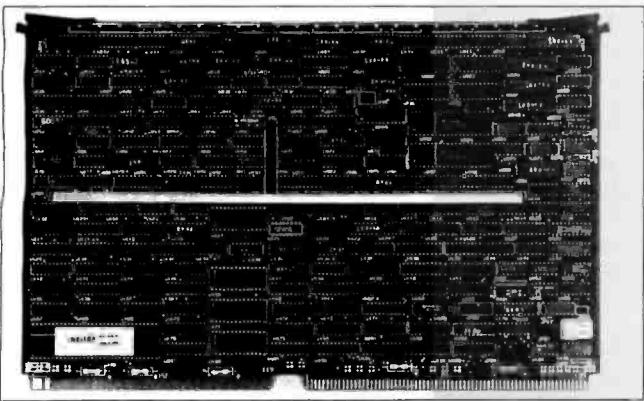

Photo 2: The SKY MNK-V array processor performs floating-point operations at high speeds.

routines. In the course of my work, the program was adapted to the S9000. On the S9000, Pascal routines can be substituted for much of the assembly code, a tribute to the value of mixed-language environments. The massive amount of directly addressable RAM (random-access read/write memory) on the S9000 greatly simplifies other aspects of programming and offers flexibility not available on the PDP-11.

The PDP-11 restricts processes to 32K bytes of address space. Since this is insufficient even for a single data set (8K points \times 8 bytes/point = > 64K bytes), the PDP-11 versions of RNMR were heavily overlaid and included an internal virtual-memory subsystem. None of this was necessary on the S9000. In fact, I/O optimization was largely irrelevant because most data could be maintained in core throughout execution. Because little disk I/O is necessary and we use an array processor for most data manipulation, the response time is much faster on the S9000 than it is on any of the PDP-11 systems or our VAX 11/730.

The bit-mapped graphics display of the S9000 (figure 3) has proved its value in our application. This is the one place where a significant amount of assembly-language code was written (a package developed in collaboration with Richard

Mushlin and Jim Cooper at IBM Instruments). By addressing the screen RAM directly and using address-register manipulations, we are able to scale and display a data set with full-screen resolution (768 by 480 points) in less than 200 ms. For interactive tuning of the spectrometers, such speed is critical. On the PDP-11 and VAX systems, the graphics display must be addressed over an external port, and a display update takes one to two seconds.

THE SKY MNK-V ARRAY PROCESSOR

To achieve the processing power we needed for interactive data analysis, we included the SKY MNK-V array processor from SKY Computers in our S9000s (see photo 2). NMR is nearly an ideal application for array processing because most of our computations involve manipulations on large linear arrays of data. The SKY product is a pipelined floating-point processor, which can increase the speed of floating-point arithmetic on the S9000 by a factor of more than 100. Physically, it is a single PC board that plugs into the VERSA-bus, and it operates as an intelligent I/O device. Rather than dedicating RAM to the array processor, the SKY board shares memory with the host 68000, performing DMA transfers to get data as needed. This architecture meshes well with the S9000 and its very large RAM. It also simplifies and reduces the cost of the array processor.

SKY provides a library of vector-manipulation routines, including integer-to-floating conversions, vector-vector and vector-scalar arithmetic, matrix-manipulation primitives, FFTs (fast Fourier transforms), convolutions, and polynomial evaluation. The company also offers an extended library with vector trig functions, exponentials, square roots, and more matrix-manipulation tools.

Accessing the array processor efficiently is easy if you want to perform functions provided in SKY's library. For example, a Fourier transform (FT) is a common mathematical transformation used in signal processing and image analysis. In simple terms, it converts from waves in a time series to frequencies in a spectrum. The FORTRAN code necessary to perform an FT with the SKY array processor is as follows:

```
CALL VFFT(vec__in,incr__in,vec__out,incr__out,len)
CALL VWAIT
```

where `vec__in` is the input data, `incr__in` is the increment between data points in the input vector, `vec__out` and `incr__out` specify the output vector, and `len` gives the number points.

The increment specifications are a rather clever feature allowing you to access a matrix of data in either rows or columns without transposing it. For imaging and other multi-dimensional applications, this can save a lot of unnecessary data shuffling. The `VWAIT` call tells the host to wait for the array processor to finish before proceeding. The array processor is able to act on its own through the FT, but, of course, the results will not be valid until it is done. Since the FT might take a few milliseconds, you might want to do some other work with the host while waiting. In that case, you can delay the `VWAIT` call.

Does the SKY board give us much processing power? You

(continued)

bet. A 1024-point complex FFT takes only 82 ms, including a bit reversal and swap needed to set up the data for the FFT (both are in the SKY library). The same FFT on a VAX 11/780 with DEC's FP accelerator takes 230 ms (FFTCC from the IMSL subroutine library). We could do better by coding the FFT in assembly language, but the advantage of the VAX is supposed to be ease of programming.

Optimizing use of an array processor is not the same as optimizing your typical computation. To get some feeling for why, let's examine the processing times required (table 1).

The SKY board achieves its speed by pipelining. In other words, the different parts of several floating-point calculations are overlapped in dedicated hardware instead of waiting for each operation to complete sequentially. This makes arithmetic processing of numbers faster than the rate at which data can be moved in or out of the SKY board. To speed up processing, a second level of pipelining is used in I/O operations. Data movement on and off the array processors is handled by DMA controllers, which operate independently of the arithmetic processor. The slowest step is actually keeping everything coordinated.

To optimize performance, the name of the game is to maximize the computation done per instruction by using long vectors of data. You also want to get as much done between the times you must stop and wait for completion. Resynchronization waits must be introduced any time you need to use the result of an array-processor calculation in the host. A third goal is to minimize the amount of I/O needed to complete a given calculation. Arithmetic on complex numbers is thus comparatively cheap (twice the time of a real operation rather than the usual factor of about six).

Using the on-board scratch-pad memory can also decrease I/O delays. To see how this is done, consider a simple problem—multiplying a vector by a matrix. The crudest algorithm would be to follow a typical pencil and paper approach

```
For i = 1 to n_rows
  Vector_multiply ( Row__i * Vec__in => Temp )
  Vec__out(i) = Sum__of__elements ( Temp )
End loop
```

where the matrix is represented by a series of row vectors Row__1 to Row__n, Vec__in is the input vector, and Vec__out is the result. The crude algorithm would require four vector moves and two instruction packets per row. You can double the speed by using the dot-product routine that SKY provides to combine the two operations.

```
For i = 1 to n_rows
  Vec__out(i) = Dot ( Row__i, Vec__in )
End loop
```

This still requires moving two vectors per row into the SKY board. You can gain another factor of two by using the scratch pad.

```
Move ( Vec__in => scratch__pad )
For i = 1 to n_rows
  Vec__out(i) = Dot ( Row__i, scratch__pad )
End loop
```

Note that even in the most efficient algorithm, the speed of the calculation is determined by the I/O delays, not the speed of the floating-point operations. Array-processor performance figures quoted in millions of floating-point operations per second (MFLOPs) ignore this fact and might be quite misleading.

Unfortunately, to use the scratch pad you have to delve into SKY's "Advanced Programming" routines and worry about a lot of details the standard library takes care of for you. It is analogous to assembly language versus FORTRAN. Chances are you will not have to worry about this, though, as the second algorithm will run a length 100 real vector through a 100-by-100 matrix in about a tenth of a second.

You must compromise when using an array processor. Array processors work well with computations that involve linear access to arrays of data, but they will not help with sorts, parsing, or algorithms with complex control branching. The SKY array processor, like most low- to moderate-cost units, works only on single-precision floating-point numbers. If you need double precision, you are out of luck. Similarly, the SKY board will do fast integer-to-floating conversions, but if you want the calculation done in integer format, it will not help you. (Of course, the 68000 is pretty fast by itself for integer work.) The SKY libraries offer a good set of basic operations, but functions not supported by the library require more work.

The S9000 is not the only computer SKY supports. SKY array processors are available for the Multibus and DEC's Q-bus, as well as the VERSAbus, all for about \$6000. In addition, they have a slower, less expensive floating-point processor that supports double-precision arithmetic. SKY has subroutine libraries that operate under many different operating systems, including several flavors of UNIX.

PROGRAM DEVELOPMENT

Bringing up 20,000 lines of code on a new machine is no small task, and programs will continue to evolve once they are running. The capabilities of the S9000 as a program-development station are, therefore, almost as relevant to the project as its ability to run the program in the first place.

CSOS is the operating system IBM supplies with the S9000. While IBM does offer XENIX (a Microsoft UNIX derivative), CSOS remains the focus of most of its development work. CSOS is not a finished product, yet it comes to market at a time of great opportunity. CP/M and MS-DOS clearly do not exploit all the power available in a processor like the 68000. Nor is UNIX the be-all and end-all of operating systems.

(continued)

Table 1: Basic steps and times for optimizing an array.

Operation	Time*
Send commands asynchronously	290 μsec
Wait for completion	235 μsec
Tell the SKY board to repeat the last command	20 μsec
Move a word of data (on or off the SKY board)	1 μsec
Floating-point divide of on-board data	7 μsec
Add, multiply, or compare on-board data	0 μsec†

*Times were calculated by performing the relevant operation 1000 times on a length 1000 vector and dividing the number of seconds needed to perform the task by one million. Command-processing times were obtained by extrapolating to zero-length vectors.

†These operations are pipelined and are faster than data movement.

When you're last
to the party,
you better bring

something special. Like a 10 Megabyte Winchester for \$888.

Hard Right

The great price is just the beginning. You see, the reason we're late is we took a little more time getting ready. For two years we have searched for the right components at the right price. Anybody can buy controllers and drives, make up a name, and presto, they are in the hard disk business. In fact, some of the biggest names in the industry have done just that. To do it right, takes much more than just bundling the nearest components.

Anybody Want a V-8?

Adding a hard disk to an IBM PC can be very much like stuffing a V-8 engine in the back seat of your VW bug. There is room to put it there, and you will have one fast beetle — but you create a whole new set of problems. Like excessive power drain. IBM didn't plan for a hard disk in your PC, so they put in a meager 63.5 watt power supply (XT's have 130 watt power supplies). Most of the hard disks out there need so much power to run them that you can barely add any expansion boards and still have enough power to operate with. And all that power results in excess internal heat — reducing the life of electronic components.

Cool & In Control

Qubie has attacked the power/heat problem with a state of the art controller and drive that draw less power than any on the market today. Start with our controller. It uses LSI (Large Scale Integration) technology to lower the number of components on the board and provides significantly faster performance. Fewer components require less power. Less power means less heat. More power left for other expansion boards, and lower operating temperatures inside your PC. Our half-height drive draws the same amount of power as a floppy disk, and is the lowest power consuming drive on the market today.

Portable Plus

We selected a half-height drive that can be used in an IBM PC, Compaq, or a PC portable. In fact we use the same drive and controller used in the Compaq Plus computer. The drive's specially plated media allows it to stand up to the rigors

of the real world. It can even operate at any angle. No need to treat your PC or Compaq like a piece of antique china just because you have added a hard disk. And no need to spend hundreds more when you can get the same components at a Qubie price.

Complete Package

Included in the package is everything you need to install it yourself. 10Mb winchester drive, controller, cables, mounting hardware, and step by step instructions to explain the installation. We also include the popular 1dir "visual shell" software. It will allow you to take full advantage of the many features of DOS 2.0 or 2.1 without having to invest the time to figure out the manuals.

Need More Power?

If you have some power hungry expansion boards already in your PC, you may need more power in order to add a hard disk system. If so, no problem. For \$88 we have an auxiliary power supply which plugs onto the back of your PC and provides all the power needed to run your hard disk drive. This is a IBM PC only problem as all the popular compatibles have substantially bigger power supplies than does the IBM PC.

Why Buy From Us

Because besides having the best hard disk system on the market, we stand behind it and you. You get direct technical support after the sale. *If at any time during the one year warranty period your system should require service, we will fix it or replace it within 48 hours.* Notice there are no hidden charges in our price. No extra for freight, credit cards, COD fees, or insurance. If you still are not convinced, and are ready to buy another brand of hard disk, ask them if they will take our acid test.

The Acid Test

Qubie gives you a 30 day satisfaction guarantee on our hard disk system. If for any reason you are not satisfied with your purchase, you may return it for a complete refund including the postage to return it. If you can, get any of our competitors to give you the same guarantee. Buy both and return the one you don't like. We know which one you will keep.

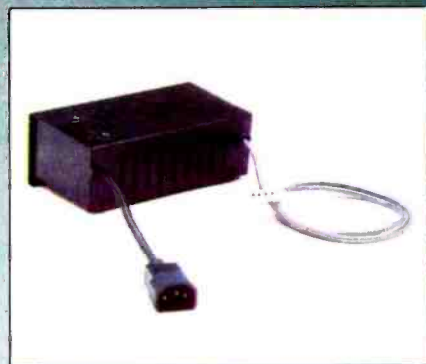

Optional Power Supply

SYSTEM REQUIREMENTS: Any IBM PC with 64k RAM, PC DOS version 2.0 or 2.1. Compatible owners call for application information.

Qubie PC10 with 10 Megabyte 1dir "visual shell" software, installation hardware, and instructions. 1 year warranty. \$888

Qubie QS10 Optional Hard Disk Power Supply for users with fully loaded PC's. Instructions. 1 year warranty. \$88

HHBZL Half-Height bezel for drive, \$15

Circle 151 on Inquiry card.

DEALER AND QUANTITY PURCHASERS INQUIRIES INVITED

IBM is a trademark of International Business Machines Corporation.

Order Today, Shipped Tomorrow!

Price includes UPS surface freight and insurance. Add \$5.00 for two day air service. For fastest delivery send certified check or credit card. Personal checks take 18 days to clear. Calif. residents add 6% sales tax. Corporations and Institutions call for purchase order details.

(800) 821-4479

Toll Free Outside California

(805) 987-9741

Inside California

QUBIE'

4809 Calle Alto
Camarillo, CA 93010

Tempo House, 15 Falcon Road,
London SW11 2PH, United Kingdom

© Copyright Qubie 1984



1dir Directory System Included

tems. UNIX is full of bizarre and obscure abbreviations, its file system is not particularly robust, the framework of inter-task communications is limited, it has no asynchronous I/O facilities, and it is unable to service many real-time applications. CSOS needs some work, but it might be a better alternative to these systems.

CSOS includes a solid basic environment for multitask programming. It supports assigned priorities, interrupts, and asynchronous event handling, and it provides useful timer and semaphore managers for synchronization and communication tasks. Asynchronous I/O is fully supported and functional to the disks, terminal ports, and GPIB port. Device drivers follow a uniform format, making device-independent code easy to write.

The major limitation of CSOS is its lack of a dynamic loader, which is related to the S9000's lack of memory-management hardware. The lack of a dynamic loader is critical because it prevents you from running multiple copies of the same image simultaneously. In particular, you cannot run a second copy of the command interpreter to do multiuser or batch-mode processing, despite the S9000's ability to support two or three interactive users or batch-mode processing while a user is editing.

The user interface in CSOS also needs work. All commands must be uppercase, and abbreviations are not allowed. It has no facilities for defining command symbols or for redirecting input or output streams. Logical name handling is static and limited to disk devices. Although it does have a minimal shell script facility, it will only execute a list of commands in strict sequence. It contains no branching, loops, or error status, and calling one shell script from another is illegal. At least it will process command arguments and substitute them in the shell script as directed. Many of the utilities are not set up to execute directly from a command line. Instead of parsing the command line for options and switches, they prompt you for the information. Hence, they cannot be incorporated into automated shell scripts.

It is not fair to compare the S9000 to the VAX, but I am going to do it anyway. All of the features mentioned above are available in VAX/VMS, and they are useful. The IBM people tell me that these are all cosmetic, and in a dedicated application, your program will replace CSOS as the real user interface. Cosmetic or not, it's nice to work in the VAX/VMS environment.

The CSOS file system is another weak spot. CSOS has all the tools to create a hierarchical directory structure (as in UNIX or VMS), but IBM has not done it. On a floppy disk, having all your files in a single directory is not too much of a bother, but this is not acceptable with a 10-megabyte hard disk. The IBM directory utility does not help matters. It dumps the file names in random order on the screen and does not even bother to compress blanks between the file name and the extension. Alphabetic listings are provided as an option, but they are abysmally slow. I ended up writing my own directory utility because I got tired of waiting for IBM's.

The CSOS intertask communication channels are not very helpful because they do not support asynchronous I/O. Since asynchronous operation is the basic reason for undertaking multitask program development, this is a fairly significant limitation. You can use semaphores to coordinate asynchro-

nous message exchange through shared memory, which is a good alternative to the CSOS intertask channels. No default memory protections are applied, so all of the RAM is, in effect, global-shared memory. Memory protection is available, but it is undocumented at present.

If cost is a consideration, CSOS will run on a bare-bones S9000 (central-processor board alone with no peripherals). In contrast, the XENIX operating system requires hard disks, a memory-management unit, and additional RAM.

In summary, CSOS provides the basic tools expected of a real-time multitask operating system and has performed solidly for us. In the final analysis, I am able to do things in CSOS that would be impossible under UNIX or many other operating systems. CSOS is not yet a finished product, and future releases of the user interface will probably be much better. (The current version 1.1 is worlds better than the 1.0 release.)

DOCUMENTATION

Software is only as good as its documentation. The documentation that came with our first S9000 was poor, especially coming from a company like IBM. In version 1.1 of the operating system, IBM has gone a long way toward repairing its most glaring faults. The language reference manuals are reasonable, although they are not exceptional in clarity or scope. The basic installation guide, operator's manual, and diagnostics are clear and complete. The organization of the manuals could use some work. For example, most error codes are documented in one appendix, while others are scattered through the manuals. Since you may not know precisely which utility generated an error code, finding its description can be difficult.

IBM includes step-by-step instructions on how to rip the guts out of your S9000 and put it all back together again, which is important because we have handled most of our servicing by shipping boards back and forth to IBM's Instrument Service Center in Danbury, Connecticut.

The internals and hardware documentation were non-existent at the outset, but that seems to be changing. I don't know why IBM people are so secretive about the workings of their computers. Even prying loose a list of I/O addresses was painful. (IBM now includes it in the documentation.) The S9000 is called "a laboratory computer." In a laboratory setting, you must frequently interface weird things to the computer. Without documentation, there is no way to do this. Scientists are also a curious bunch, and many of us just want to know what is going on inside our boxes. As a collaborative research site, we normally have access to internals documentation that is not available to the average customer. In IBM's case, schematics are never available.

EDITORS

IBM supplies two editors for the S9000. The first, ED, comes with CSOS and was written by the S9000 group. They should not have bothered. The keyboard layout is illogical, the command set is primitive, and there are no macro or key-redefinition facilities with which to expand it. In a candid moment, even the IBM staffers will admit that ED is painful to use.

The second editor, PE, is the IBM PC Personal Editor ported

(continued)



Show your colors.

The new Epson® JX-80™ 7-color printer.

Say more faster. With greater clarity and comprehension. And with a lot more impact. Say it in color.

Join the color revolution.

The revolutionary JX-80 gives you seven vivid colors to breathe life into charts and give soul to text.

But that's just for starters.

The JX-80's exclusive SelecType control panel makes choosing and mixing any of nine popular type-faces (the JX-80 prints 144 different faces in all) as easy as pushing a few

buttons on the printer.

Color it hot.

The JX-80 prints graphics or text in black and white at speeds of up to 160 characters per second exactly like our legendary FX-80™ dot matrix printer. So, like all Epson printers, it's supported by virtually all software and personal computers. Switch to color, however, and the JX-80 is supported by all popular color software such as Lotus® Symphony.™

And of course, the JX-80 is backed by the one-year Number One Warranty, and priced right.

See your nearby Epson dealer. Get the full story in black and white.

And yellow and cyan and magenta and violet and green and orange...

Number one. And built like it.

EPSON®
EPSON AMERICA, INC.

2780 Lomita Boulevard • Torrance, CA 90505 • Call (800) 421-5426 for the Epson dealer in your area. In California call (213) 539-9140.

Epson is a registered trademark, and JX-80 and FX-80 are trademarks of Epson America, Inc. Lotus and Symphony are trademarks of Lotus Development Corporation.

to the S9000. It offers a more varied command set and the ability to edit multiple files simultaneously. Most important, it has user-definable initialization and key-definition facilities, which allow you to create macros, associate them with keystrokes, set tabs and margins, and so forth. The initialization file supplied by IBM is limited and for some unknown reason, tries to make PE look like ED.

With a little work, you can create a respectable editor with a rich command set, help facilities, and just about any other features you might want. My version of the editor defines

keystroke-motion, text-movement, and text-deletion commands, which operate by character, word, or line. In a couple of keystrokes, I can move blocks of text and do text justification. I built in several customized program-development modes for each of the languages to do automatic indenting and setup of skeleton comment blocks.

THE CSOS COMPILERS

The high-level languages of the S9000 are one of its strong points. IBM offers Pascal, C, and FORTRAN as a package of



Photo 3: A closer look at the keyboard for the S9000.

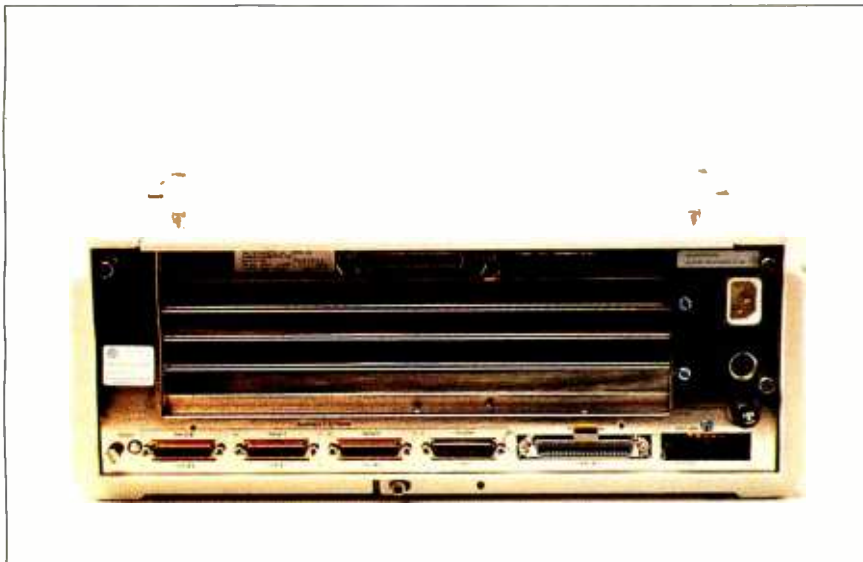

Photo 4: A rear view of the interface for the S9000.

Integrating the S9000

With four operational NMR spectrometers and three more in various stages of construction, the National Magnet Lab supports a reasonable-sized labwide computing facility. We have a VAX, two PDP-11s, and four S9000s. To optimize utilization of resources, we have developed a data-communication network tying these processors together. In this way, a single tape drive, a line printer, an electrostatic printer/plotter, and the big disk on the VAX are made available to all users, and data may be processed on an available processor while another is running a spectrometer.

This is not your average office-mail network. Mail messages and text files are typically a few hundred to a thousand bytes of data. We deal with 50K-byte to 10-megabyte data sets, and we would like to pass them around as quickly as possible. We implemented our data network on the IEEE-488 GPIB bus and achieve high data-transmission rates (200K bytes per second disk to disk) without sacrificing standardization.

Because we have seven computers from two manufacturers and run four operating systems (VAX/VMS, RSX-11, CSOS, and XENIX), you might wonder how we ever got our software running. This is a significant question. I/O interfaces are different for each of these operating systems, and even the disk file formats vary. RSX-11 (the DEC PDP-11 operating system) uses fixed-length records or variable-length records with fixed headers. CSOS and XENIX use fixed-record data files or stream text files with records delimited by carriage return characters. The VAX uses all sorts of formats.

First, we decided that we did not need to couple the network tightly into the various operating systems. We needed

mutually supported languages. You can write routines in any language and call them from almost any other. They all use the same code generator, and they share a common object file format, object librarian, and linker. BASIC is supported on the S9000 (see *BYTE*, February 1984), but it is not compatible with the other languages. IBM has committed itself to supporting the CSOS compilers on its XENIX systems, so code should be freely transportable.

The ability to mix languages is extremely valuable because, like it or not, no perfect programming language exists. Pascal might be great at providing a clean control flow, but doing

arithmetic on complex numbers can get a bit cumbersome, and I/O is limited. FORTRAN is good at coding math and has a rich I/O library, but whoever wrote FORTRAN specifications forgot about pointers and data structures.

Pascal is the "native" language of the S9000. Its compiler is the fastest, and it produces the most compact code. Much of the system software is written in Pascal. The S9000 Pascal is a variant of UCSD Pascal with nice UNIT and INTERFACE features built in. String handling is also done well. Although I was born and bred a FORTRAN programmer (real program-

(continued)

into a Laboratory Computing System

high data-transmission rates, but making the link transparent to the user was not really a requirement. Therefore, we decided to deal with the links as file servers. We also simplified the control structure by using the VAX as the central node of a star architecture. Our application rarely requires communication between peripheral nodes, but when it is necessary, it can be routed through the VAX.

We also attempted to keep programming modular. A file server sends raw data. It does not worry about what format the data is in or how such formats might be transformed. The network operates independently of file formats, and no special provisions are necessary to transmit text versus binary data. Another reason for this setup is speed. Disk I/O is done with block I/O, and the network transmits data about as fast as any of the disks are able to deliver it. We do not have time to mess around with reformatting.

At each node on the network, a small program monitors the network and delivers file data as requested. These programs must respond to only four basic command packets—open a file, close a file, read data, and write data—so they are fairly straightforward. The major complications involve error handling. To function reliably, the network must withstand a variety of insults, including system crashes at the individual nodes and timeouts that occur when the low-priority bus monitor gets locked out by a higher-priority job. The network monitors must also recover gracefully from requests to access nonexistent or inaccessible files and from file read/write errors. Debugging the attachment of a new node monitor is much easier if the network is resistant to internal protocol errors. We elected to enforce a strict handshaking protocol in which every command packet

generates a return status packet. In this way, both parties involved in an errant transaction will be signaled to take corrective action.

Most of the file reformatting is handled on the VAX. Since the RSX-11 file system is a subset of the VAX's, all PDP-11 files can be sent directly to the VAX without modification. With its variety of formats, the VAX I/O services are able to read and reformat most of the CSOS and XENIX files.

Data-format conversions remain a problem. The two largest computer companies on earth cannot agree on how to represent an integer in binary format. Digital Equipment Corp. (DEC) counts bytes from right to left, while IBM counts them from left to right. Floating-point numbers are even worse. The S9000 uses the IEEE standard format. On paper, DEC's form looks pretty close, but then the bytes are reordered, and there is an offset difference in the exponent. Operating on raw binary data, there is no general way to determine what reformatting must be done because you do not know what type of data you have. There are two solutions to the data-reformatting problem. The first is to transmit ASCII data (at least the S9000 and DEC agree on that). The second option is to write custom data-transformation routines that operate on specific binary data files and know about their internal structure. The latter approach is inconvenient but necessary when speed is a consideration.

We implemented our network on National Instruments' (NI) IEEE-488 (GPIB) bus, a standard bus originally designed for the control of electronic instrumentation. The bus permits asynchronous byte parallel transmission at rates of up to 500K bytes per second. The S9000 supports the GPIB bus as a built-in feature. A number of interface cards are

available for the Unibus and Multibus. We chose NI interfaces for the DEC computers. NI supplies good software support, and its hardware has been quite reliable. The S9000 port, on the other hand, was an unending source of frustration. Initially DMA did not work at all and was prone to causing crashes later on. The more sophisticated aspects of the device driver had bugs, and in slave mode, it dropped bytes of data. IBM seems to have finally solved the hardware problems. XENIX on the S9000 will only attach to the bus as a master. Since you cannot have two masters on the bus simultaneously and the VAX is already acting as controller, this creates a problem. We deal with it by buffering the XENIX system through a custom box that acts as a slave on two independent GPIB buses. This is hardly ideal.

The GPIB bus does impose some limitations on the network. Principle among these is distance. IEEE specifications allow for a maximum of 20 meters of cable. In practice, we are able to exceed this a little, but it is still necessary to have all the computers in the same or adjacent rooms. NI sells repeaters that allow links over a kilometer, but they cost \$2000 a shot and reduce the data-transmission rates to 150K bytes per second.

A second interactive network sprang up spontaneously around the lab. This is based on RS-232C lines and terminal-emulator programs. A terminal emulator is a program that echoes I/O from your keyboard and a terminal line and from the line back to your screen. By connecting the terminal line to another computer or modem, you can log in and run on another computer without ever leaving your own host. If the terminal emulator can copy text files to and from the line, you have a functional and absolutely general network.

The 68000 instruction set is powerful, and the addressing modes are quite rich, with a variety of PC and address-register offset and indexing options. . . . The 68000 is a 16-bit processor with 24-bit addressing and some 32-bit instructions.

mers don't write Pascal), this compiler converted me.

FORTRAN 77 is fully supported on the S9000, and the FORTRAN compiler has proved to be reliable and reasonably quick. For a number of reasons, FORTRAN is not quite as compact or efficient as Pascal. The FORTRAN run-time library is an addition to the Pascal library, so the linked images are a little bigger. FORTRAN uses static rather than dynamic storage allocation, so data space is also not as efficiently used as it is in Pascal. Finally, by default, FORTRAN uses long-word integers (4 bytes), while Pascal uses short words (2 bytes). Unless you ask for short-word integers, the compiler will have to generate the additional code and storage needed to deal with long words.

FORTRAN has several pseudostandard features that the S9000 FORTRAN does not support. These include bit-wise logical operations on integers, variant argument lists, interchange of character and numeric data in argument lists, the free use of long variable names, hexadecimal and octal format conversions, and the ability to get record lengths on variable-length reads. None of these are part of the FORTRAN standard, but they are useful, and many FORTRAN compilers do support them (including, for example, the VAX FORTRAN 77). You can obtain bit-wise logical operators by equivalencing to logical variables and record lengths on variable-length reads by dropping into Pascal or assembly language, but you will have to live without the rest.

My experience with the S9000 C compiler is relatively limited. It seems to be reliable, but like many versions of C, the linked image files are enormous (the C printf function links most of the I/O library to every program). In evaluating a compiler for scientific work, it is important to remember that the C language specification requires that all floating-point operations be performed in double precision. Single-precision arithmetic might be slow on a microcomputer, but double precision is ridiculous. On the S9000, the stack-handling conventions of the C compiler and the Pascal and FORTRAN compilers disagree. You can call C routines from Pascal if you declare them to be C externals, but you cannot call them from FORTRAN.

The 68000 assembler, ASM, is an interesting development.

It has structured control flow. That's right, you can place IF THEN ELSE constructs, DO WHILEs, and REPEAT UNTILs directly into your assembly-language code. It also supports the usual macro facilities and other directives. Nothing will ever make assembly language into Pascal, but these features can be quite useful in avoiding the usual catastrophic jumble of assembly code.

The 68000 instruction set is powerful, and the addressing modes are quite rich, with a variety of PC and address-register offset and indexing options. After working with the 68000, I was a bit disappointed when I went back to the VAX to code a short routine. The 68000 is a 16-bit processor with 24-bit addressing and some 32-bit instructions. It is not a full 32-bit processor. In particular, multiplies and divides on 32-bit integers must be broken down to 16-bit operations. The VAX offers a full 32-bit instruction set and offset indirect addressing (the address stored in the memory location pointed to by a register plus offset). The latter is very useful in argument lists and is not available in the 68000.

The S9000 language system has a couple of annoying limitations. It is impossible to access or initialize FORTRAN common blocks in assembly language, and you cannot code real numbers in ASM data statements. On many other systems (such as the VAX), you can use assembly language to great advantage in initialization data structures with bit masks, pointers, and functions on which FORTRAN stumbles. The subroutine call-sequence convention is also not great. Arguments are pushed onto the stack rather than into a separate register as an argument pointer. This prevents optimization through the use of prebuilt argument lists. It also makes it easy to corrupt the stack. Pascal's rigid type checking avoids most such problems, but in FORTRAN it is easy to put the wrong number of arguments in a call statement or to substitute a character string for a numeric data type, either of which will crash the system. A minor bug in the S9000 linker forces you to link assembly code into the beginning of a large program if it is going to call globally defined subroutines. If your program code does not exceed 32K bytes, or if your assembly-language subroutines make only local subroutine calls, you will never have to worry about it.

IBM has recently released a real symbolic debugger, which works with all the compiled languages. You can load a program, run it, check trace points, break at specific points including line numbers, examine variables by name, and trace back through subroutine calls. This is a very useful little tool to have around.

When I began my work, there was no way to get a machine-code listing of the compiler output. A disassembler now exists and should be available soon.

EXPANSION CAPABILITIES

In assessing any computer system, expansion capability is a consideration. IBM offers a number of peripheral devices for the S9000, including printers, 5¼-inch and 8-inch floppy disks, up to 40 megabytes of hard-disk capacity, two A/D (analog/digital) converters (high precision and high speed), and support for up to 5 megabytes of RAM. The hard disks are based on standard interfaces, so alternative vendors might have products available if you buy one IBM disk and

(continued)

Computing Horsepower from Hauppauge!

- The 87 Chip: The easiest to install 8087 PC upgrade. And the most reliable. \$175.
- The 87 Software: The easiest to use math libraries. With source code. \$295. Complete with 87 Chip.

- Hauppauge support: One year of automatic upgrades for the continuous competitive edge. Insist on Hauppauge for quality 8087 products. Available from dealers throughout the United States and Canada.

358 Veteran Memorial Highway, Suite MS1
Commack, New York 11725
516-360-3827

HCW

Hauppauge Computer Works Inc.
AVAILABLE FROM YOUR LOCAL COMPUTER DEALER. In Canada Contact: Kanatek Micro Box 12029 Kanata, Ontario K2K1X3 613-829-9165
Circle 73 on Inquiry card.

want to add more later. The S9000 comes with the IEEE-488 GPIB port, a parallel printer port, and three RS-232C ports, all of which could be used to add peripherals.

The standard S9000 backplane will support five expansion slots. The hard-disk controller occupies one, and you can put up to 1 megabyte of memory into each of the others. In our application, the SKY array processor fills one slot. The S9000 is based on a derivative of the Motorola VERSAbus, but IBM modified several critical features. If you are going to look at non-IBM VERSAbus equipment, tell the vendor you intend to use it with an S9000 and see if he will support it.

CONCLUSIONS

The S9000 is a supermicro available in a reasonable and complete product package. It sports a real-time multitasking operating system, excellent compilers, and the backing of the biggest name in the game. By adding an array processor from SKY Computers, we were able to achieve truly spectacular number-crunching capabilities and have been able to integrate the S9000 into a major scientific data-processing application.

Would I recommend the S9000? As a dedicated processor, yes. It is a powerful computer, and its large memory is a real advantage in running large programs. CSOS supports real-time work that would be impossible under UNIX, and once

the applications software is written, you do not have to deal with the CSOS user interface. I did not like all the hardware glitches we ran into, but most have been cured, and the service has been excellent. The bottom line is that we have an inexpensive machine that does the calculations we need very quickly.

Would I recommend the S9000 as a general-purpose scientific computer? My major word of caution applies to micros in general. Be aware that raw number-crunching power is not the only thing you need in a general-purpose computer. Think about program development, data communication, peripheral devices, and access to knowledgeable people before you buy any system. The S9000 with CSOS offers an excellent set of compilers and will provide a good single-user operating environment. The S9000 will probably be a pretty good XENIX system with multiuser support, but IBM has to deliver the machines first.

Whether or not the S9000 is the super-PC of 1984, the MIT NMR project does demonstrate that, properly equipped, a microcomputer can take on real-world computing tasks with demanding computational requirements and handle them with finesse. The world of minicomputers and even super-minicomputers should take good notice. Because after all, the supermicrocomputers are only going to continue getting better and better. ■

The Most Affordable Disk MakerTM in the Universe

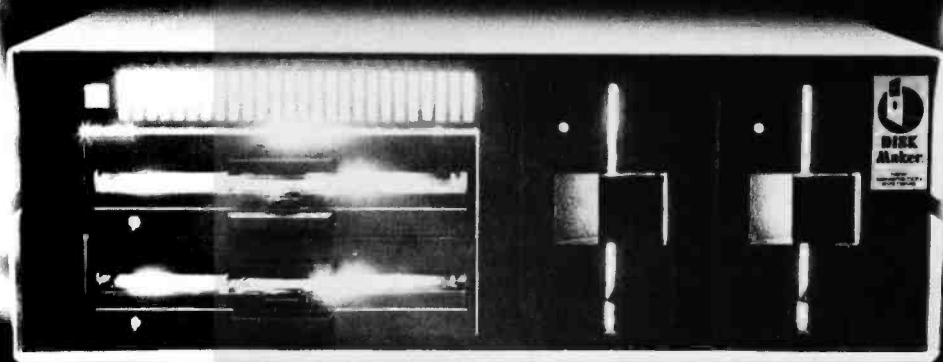

Disk Maker II shown with opt. dr

Download fast, read over 100 formats easily, reformat rapidly

The more disk formats you work with, the more our Disk MakerTM system saves time and money by reading and/or writing disks in any of over 100 formats. No modems, no patches, no other special software necessary.

Disk Maker II is a complete, stand alone system with one 8" DSDD disk drive, one 48 tpi 5 1/4" DSDD disk drive, 6 MHZ Z80B, 64K CP/M system with Disk MakerTM software. (96 tpi and second 8" drive optional.) Just plug in your terminal and make disks! Bundled software includes MicroShellTM/MCALL-II communications software.

Supported with comprehensive, easy-to-read manual, software updates (\$25.00, all formats in revision), and additional drives and hard disk options.

Disk MakerTM
prices from
\$1,495

Disk Maker I runs as a peripheral with an S-100 system and comes with S-100 controller board, one 48 tpi DSDD 5 1/4" disk drive, dual drive cabinet and power supply, cables and Disk Maker software. 96 tpi and 8" drives are optional. Circle 123 on inquiry card.

**NEW
GENERATION
SYSTEMS**

1800 Michael Faraday Drive, Suite 206, Reston, VA 22090
(703) 471-5598 Order Line: (800) 368-3359
Dealer inquiries welcomed.

THE MAINFRAME CONNECTION: IBM'S 3270 PC

High-quality graphics and multihost communications characterize IBM's 3270 PC

The remarkable market success of the IBM PC not only created an industry standard, but brought the PC under widespread scrutiny. It soon became painfully obvious that the PC was lacking in one major area—it couldn't talk to IBM mainframes. Sure, it could operate as a dumb terminal at 1200 bps (bits per second), but many computers can do that. It could also transfer files at 1200 bps (if you don't mind the wait), but again, that's nothing special. What was needed was a way to use the PC's intelligence in conjunction with that of a host mainframe, a way to make the two work together, not just transfer data back and forth.

Other manufacturers quickly saw the gap that IBM left open. They realized that the key to making PCs and mainframes talk swiftly was improving the data rate. You simply couldn't do much at asynchronous communications data rates: they're just too slow. The solution was to communicate over the standard IBM 3270 terminal interface. Third-party manufacturers began to develop 3278 terminal interface cards for the PC. As the number of 3278 interface cards increased, so did the potential of the PC as an intelligent workstation.

IBM is now in the workstation market with a series of new PCs designed to operate as workstations. The 3270 PC is the top of this new line of terminals.

The IBM 3270 PC plugs directly into an existing IBM mainframe 3270 interface. Its features allow simultaneous operation as both a PC running PC-DOS and as a 3278 Display Station Model 2, 3, 4, or 5. When used with the 3270 PC color display, it provides high-resolution color graphics. All this is packed into what looks like a standard PC XT chassis (including a 10-megabyte hard disk).



Photo 1: A shared screen on the new IBM 3270 PC. Four host programs can run at one time.

SESSIONS AND WINDOWS

The 3270 PC has a number of special features. The first of these, a session, is one of a set of areas in which your machine can operate. IBM windows manage different sessions and let you view several sessions running simultaneously on the screen. To tie all the sessions together, two types of intersession communication are possible: window-to-window copying and file transfer.

There are three types of sessions: host sessions, regular sessions, and notepad sessions. A host session involves connection to a System 370 host computer as a 3278 terminal. By means of its Distributed Function Terminal (DFT mode), the 3270 PC allows you to have as many as four host sessions active simultaneously, while being connected to the host through a single port. The DFT

mode requires some special software for the host's communications controller. In other words, although you have only a single terminal, you can log on to the host using as many as four different identifiers simultaneously. The second type of session is in the normal PC-DOS. There is nothing unusual about this session; it's exactly the same DOS (version 2.0 or greater) as on the IBM PC. The notepad session involves notepads, which are simply screen-sized places that can be used to make notes and save reminders, places to store temporary information. For instance, it is

(continued)

Larry Augustin (856 Twin Oaks Dr., Dayton, OH 45431) just graduated from the University of Notre Dame with a degree in electrical engineering. He will enter a master's degree program at Stanford University in the fall.

Two intersession communications are possible: window-to-window copying and file transfer.

possible to copy a directory of your files to a notepad for quick and easy reference. You can have as many as two active notepad sessions.

Sessions are managed by the use of windows. A window is a partial view into a much larger picture (see photo 1). A window can be as large as the full screen or as small as a single character. The 3278-2 terminal's display is 80 columns by 25 rows. By using windows, only a portion of that full screen is displayed at any one time. For example, assume that you had logged on to a host using four different identification numbers. Normally, this would require four separate terminals, but with the 3270 you can create four separate windows on one monitor. Each of these windows can be configured to take up one-fourth of the physical monitor, or approximately 40 columns by 12 rows. In each window part of the full screen of data associated with each connection to the host can be displayed. To view all the screen activity of a particular host, you can pan a window from side to side using the cursor movement keys. You can pan character by character or even pixel by pixel if your 3270 PC is equipped with the All Points Addressable (APA) adapter.

By pressing a key, you can jump from one window to the next. Pressing another key allows you to expand any window to the full screen size. Pressing the same key again returns the window to normal size. You can modify or save the size, position, foreground color, and background color of windows with only a few keystrokes.

The last feature I'll discuss here is intersession communications. As previously mentioned, the 3270 PC offers two communications techniques: window-to-window copying and file transfer.

Window-to-window copying is exactly what it sounds like. A block is first

marked in a source window and then a destination is marked in another (target) window. The process is very similar to the block copy of IBM's Personal Editor. But there is one major restriction on the target session: You cannot copy to a window running a PC-DOS session. When you are copying window to window, you are, in fact, copying to the screen of the terminal associated with that session, and therefore, you are subject to certain restrictions. For instance, in copying to a host session you are copying to the screen of a 3278 terminal and cannot copy onto protected fields. In general, if you cannot edit a portion of a screen, you also cannot copy to it. Table 1 summarizes the various source and target possibilities.

In the tests that I performed, I was able to copy blocks of text (limited by the screen size) from the PC's Personal Editor screen to the host's XEDIT screen (XEDIT is the System Product Editor running under VM/CMS). Since the extended character set of the PC allows you to display a wide variety of symbols, I copied some of the more unusual ones (happy faces, musical notes, etc.) to a host session with XEDIT running. All characters copied successfully; any characters not normally part of the EBCDIC (extended binary-coded-decimal interchange code) were copied as blanks.

By using the SEND and RECEIVE commands, you can transfer files between PC-DOS sessions and host sessions. Sending a file transfers it from a personal computer DOS session to a host session. Receiving a file means transferring it from a host session to a personal computer DOS session. In order to transfer files between sessions, you'll need special software on your mainframe. This software was unavail-

able to me at the time I wrote this article.

SOFTWARE FOR THE 3270 PC

The 3270 PC requires a number of pieces of software. The first of these is the IBM 3270 PC control program. The control program is an integral part of the 3270 PC. Without it, the machine can operate only as an IBM PC: no windowing, notepads, or host sessions. Along with the control program come a number of helpful, but not absolutely necessary, programs for saving screen profiles, restoring screen profiles, transferring files, and performing other handy chores. The control program does include the SEND and RECEIVE commands.

This control program is a complicated piece of software, not an "insert-and-go" program. Because it must handle a wide variety of communications controller hardware, it must be configured to each user's computer. You must first build a system disk from a program provided with the 3270. This configurator and its associated software may reside on a hard disk, but the system disk is built on a floppy disk. You can then copy the custom control program to the hard disk if desired.

To load the custom control program, you need a special program loader that causes the system to reboot. This, of course, causes your AUTOEXEC.BAT file to execute again, a potential source of trouble if you want your AUTOEXEC file to load the control program (visions of a system stuck infinitely rebooting itself). IBM was smart enough to foresee this possibility, and if the reboot is caused by the control program loader in an AUTOEXEC file, the loader knows enough not to reboot a second time.

The configurator itself is relatively easy to use, thanks to a series of help panels, but the control program requires that a number of parameters be fixed at the outset, which can reduce the flexibility of your 3270 PC. For example, once the control program is configured, the number and type of available sessions are fixed. If your system is configured with one notepad session, then the only way to add another notepad session is to reconfigure the control program. One caution: both the configurator and the control program

(continued)

Table 1: Window-to-window copying and restrictions.

Source Window Type		Host 3278	PC-DOS	Notepad
Target Window Type	Host (3278)	: Y	: Y	: Y
	PC-DOS	: N	: N	: N
	Notepad	: Y	: Y	: Y

Y - Yes, copy is allowed
N - No, copy is illegal

WITH OUR REAL-TIME OPERATING SYSTEM AND YOUR IBM® PC, YOU COULD CONTROL THE WORLD.

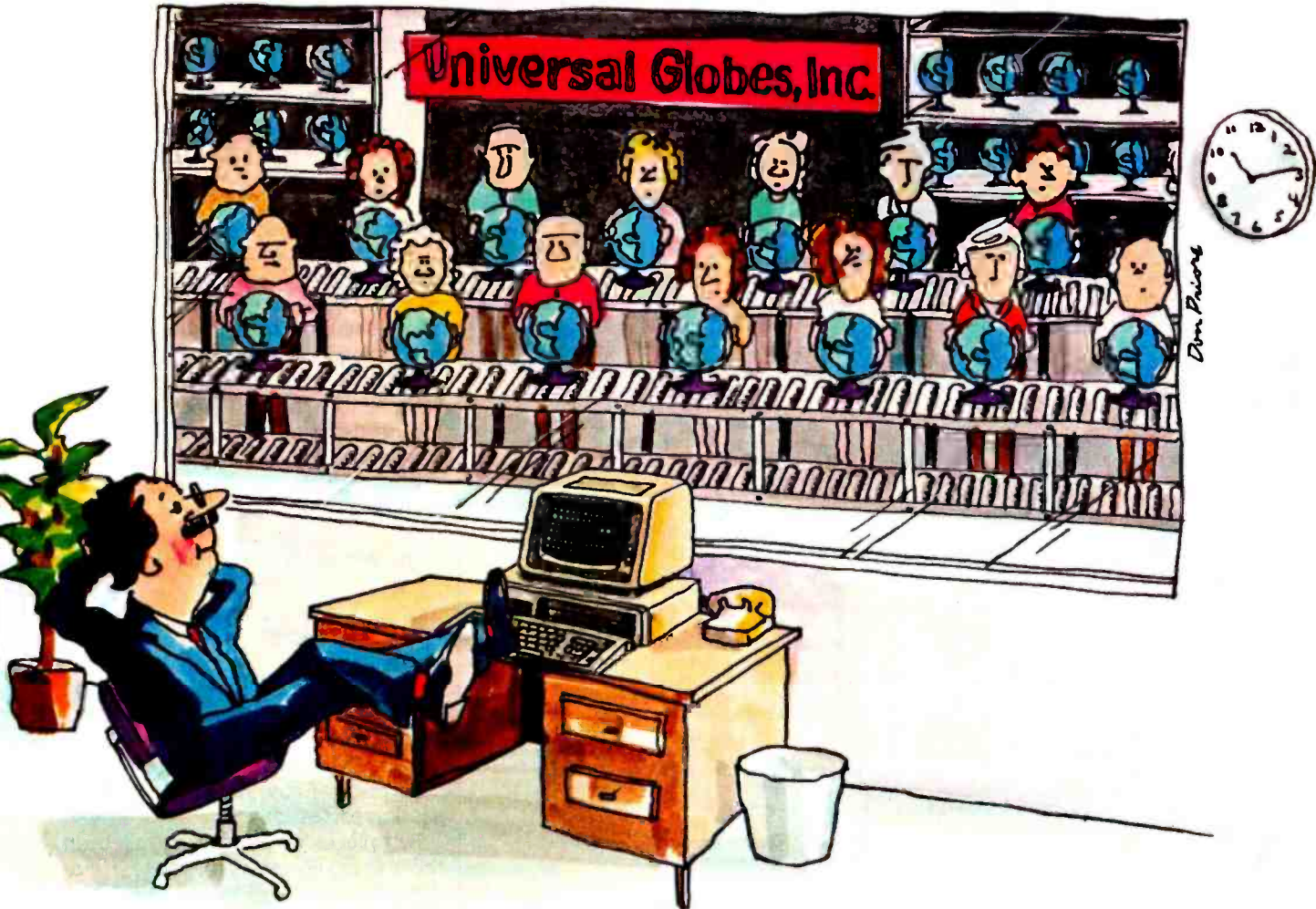

Factory automation is just one of the many control and data acquisition applications you can run with our MTOS-86/PC operating system and your IBM® PC (or equivalent). Chemical process control is another. Alarm reporting systems are a third. The list is virtually endless.

MTOS-86/PC is the newest member of our MTOS-86 family of real-time multi-tasking operating systems. The fastest, most efficient O/S software on the market today.

Within your IBM PC, MTOS-86/PC fully controls the PC and its peripherals, including keyboard, disk drives, timer, interrupt controller and process input/output systems. It allows custom drivers to be attached for special hardware and can easily be configured for your application.

MTOS-86/PC comes on diskette in the PC format. It includes executive, console driver, debugger, high-speed file system, a run-time interface for the Intel® C compiler and a test/demonstration program.

Price for a single copy, including user manuals, is \$495. Inexpensive technical support is available, too.

For more information, contact Industrial Programming Inc., 100 Jericho Quadrangle, Jericho, NY 11753. (516) 938-6600. Telex: 429808 (ITT).

ipoi Industrial Programming Inc.

The standard-setter in operating system software

Fall 1984 • BYTE Guide to the IBM PC • 233

IBM is a registered trademark of International Business Machines Corporation.
Intel is a registered trademark of Intel Corporation.

Circle 86 on inquiry card.

PERIPHERAL POWER

THE 3270 PC



1. **Model # 5VA&T** - Designed to house one full size or 2 half height 5 1/4" floppy disk drives in the vertical position. As an added feature, the mounting holes are duplicated in reverse so the user can mount the drives door left or door right. The power supply is a custom linear, proven in thousands of installations over the years!
Retail....\$60.00, (\$67.00 for half hgt version) 1 year warranty
2. **Model # 5DVA&T** - The 5DV is custom designed for 2 full size 5 1/4" floppy disk drives to mount vertically. The mounting holes are duplicated in reverse so the drives may be mounted door left or right. The power supply is our custom linear.
Retail....\$85.00 1 year warranty
3. **Model # FD-PC8** - This unique enclosure is designed to match the styling and size of the IBM-PC and can mount on top of, under or along side the PC. It is designed to house Shugart 8 inch half height floppy disk drives, and affords mainframe compatibility using 8 inch floppy diskettes.
Retail....\$399.00 1 year warranty
4. **Model # DH8A&T** - The DH8 is designed for one or two standard size 8 inch disk drives such as Shugart 800 series, Qume DT-8, and SIEMENS. The power supply is 206 series commercial grade with a 2 year warranty! Cooling fan standard. There is a space designed in above the disk drive area for mounting circuit boards if needed. Specify double or single sided connectors.
Retail....\$295.00 2 year warranty
5. **Model # FD-PC-jr.** - For those needing expansion of their PC-Jr., here is a matching enclosure to house your disk drive. We have the controller available also. The case has an injected molded front bezel to duplicate the looks of the jr.
6. **Model # FD-PC5** - This unique enclosure is designed to match your IBM-PC perfectly. Injected molded front bezel, with all steel 18 gauge construction for shielding and strength. It boasts a custom linear supply that delivers 5 amps continuous current. The FD-PC5 is pre-drilled to hold any 5 1/4" half height floppy or hard disk or any 5 1/4" full size floppy or hard disk. We even have adaptor brackets to mount a Syquest 5meg removable!
Retail....\$295.00 1 year warranty
7. **Model # 5DHHHA&T** - The 5DHHH is designed to house 1 or 2 half height floppy or hard disk drives in the horizontal side by side mode. A lit on-off switch is mounted in the front where it's convenient, and uses our custom linear power supply. A blank plate is available for one drive installations.
Retail....\$125.00 (floppy model)
\$195.00 (hard disk model)
1 year warranty
8. **Model # SH8A&T** - Will house one full size 8 inch floppy or one or two half height 8" floppy disk drives. Uses a commercial grade 206 series supply, and carries a full 2 year warranty!
Retail....\$199.00
9. **Hard disk & Floppies**, we carry only the top brands like Shugart and Qume! Don't be fooled by the cheap imitations. We carry only the best, with the strongest warranty around. For example, all Shugart disk drives carry a 1 year warranty. So call for the latest pricing to upgrade your PC, Zenith, Heath, Radio Shack, TI or one of the many other computer systems on the market!
10. We also carry data cables for your system. We can custom make them to your specs, or allow us to help you choose what's right for you.

Floppy Disk Services, inc. is entering our 6th year of supplying disk drives and custom enclosures to the computer industry. Companies that demand quality such as CBS-TV, IBM and NASA to name a few, purchase our products. Space restrictions do not allow us to show all our products, so call toll free for our FREE catalog of products. Or better yet, let one of our sales staff help you make the right choice Ask about our REPLACEMENT warranty policy.

Dealer inquiries invited. All products available in OEM quantities. Prices and specs subject to change without notice.



39 Everett Dr., Bldg. D
Lawrenceville, N.J. 08648
(609) 799-4440

TOLL FREE (800) 223-0306

Circle 66 on inquiry card.

require a great deal of memory. Don't try to reconfigure your control program if you are already operating under the old control program. Before reconfiguring, reset your computer with DOS only.

The control program can be updated by IBM's Patch Installation Service, a program that runs under DOS to install or remove changes to the control program. It also provides a historical record of the revisions and applied patches. The original software, as I received it from IBM, already had a history of three applied patches.

A number of additional programs provide extra functions. Most notable of these are Save and Restore. The IND-SAVE command allows you to save (in a file) screen profiles, notepad contents, and auto-key recordings. (Auto-keying enables you to program a key to replay a series of keystrokes, usually a pattern that you use often. For instance, you can program a key to replay your log-on statement to the host, allowing you to log on using only a single keystroke.) The INDRSTR command allows you to restore the screen, notepad, or auto-key recording from the saved file. A screen profile describes the size, position, color, and windows configured on your computer. When the control program is loaded, these are set to the defaults. Saving and restoring allows you to re-create easily your own personal screen profile. If you occasionally need to save information typed on notepads, saving and restoring makes this possible as well. By using Save and Restore, you can keep track of auto-key programs from session to session.

Two pieces of software installed on the host are necessary for you to realize the full potential of the 3270 PC. The first is a modification to the 3274 communications controller software on your host. The second is the send and receive software necessary for file transfer.

To operate multiple host sessions on the 3270 PC, you'll also need a special update to the 3274 communications controller software. (I wrote this overview from my experience with the 3270 PC running only a single host session. Notre Dame does not yet have the necessary host software.) As mentioned earlier, file transfer also requires the installation of a module on the host. Neither of these pieces of software is

necessary to the 3270 PC for you to begin its operation as a terminal, but they do add to its already long list of impressive features.

ADDITIONAL 3270 PC HARDWARE

At first glance, the 3270 PC Model 5271-6 (models 2 and 4 are available without the 10-megabyte hard disk) resembles an IBM PC XT with a special keyboard and monitor. Internally, IBM has added three cards and possibly made some changes to the system board as well. The three cards that make up the heart of the 3270 PC are the Display Adapter, the Distributed Function Communications Adapter, and the Keyboard/Timer Adapter. The Display

Adapter can drive either the 3270 PC color display or the IBM monochrome monitor. In addition to these necessary cards, two special function cards are available to help drive the display: the All Points Addressable (APA) Adapter mentioned earlier and the Programmed Symbols (PS) Adapter.

The most impressive combination of these pieces is the Display Adapter driving the 3270 PC color display. Anyone who has used the typical IBM PC color monitor will appreciate the high resolution and brilliant color of this display. When used only for text, the quality of its displayed characters is as good as the IBM monochrome monitor. If you add color, the screen suffers no loss of resolution. Programs such as IBM's Pro-

fessional Editor and the Norton Utilities take on a whole new look when used with this monitor.

Not as noticeable at first, but equally impressive, is the 3270's Distributed Function Communications Adapter. This card controls the 3270 PC's host interface and makes multiple host sessions possible with the appropriate mainframe software.

The Keyboard/Timer card appears to satisfy some timing requirements in the I/O (input/output) channel or to provide timing information to the display and communications cards. It also drives the monster keyboard available for the 3270 PC. The keyboard combines all the functions of a 3278 terminal keyboard

(continued)

Programming Languages for the IBM 3270 PC By T. Lowell Wolf

The IBM 3270 PC is very similar to the IBM PC. PC-DOS 2.0 makes the operating environment highly compatible with IBM PC software. An important key to the operation of the 3270 PC is the control program that operates in conjunction with DOS to support its windows. You can define as many as 10 screen configurations and then save them as PC-DOS files that you can invoke on command. You can print the screen, or any window, on a local or remote printer. The 3270 PC also provides a Help function to display active functions and sessions, as well as a tutorial to explain and simulate system features. Send and receive functions enable you to exchange data between the host and the PC. Path names are supported, as is the option to convert from ASCII to EBCDIC. Most DOS applications designed to use the IBM monochrome display controller will be compatible. PC-DOS software that uses the IBM graphics display controller, however, will not run in the PC-DOS window.

IBM has licensed a number of programming-language products for the 3270 PC from Digital Research Inc. Chances are you'll choose a programming language based on your experience. In the 3270 mainframe-oriented environment, the choices are typically as follows:

Level II COBOL: This full ANSI '74 implementation has passed the U.S. Federal Compiler Test at "high" level. COBOL is chosen most often by large companies

because of its portability.

PL/I: Based on ANSI Subset G standard. PL/I is often used by scientific and general-purpose mainframe and minicomputer programmers.

Assembly language: Though assembly language maximizes computer performance, assembly-language programming should be minimized to avoid machine dependencies.

Other languages are more popular with recent graduates and programmers with minicomputer or microcomputer orientations:

C: A full implementation of the Kernighan and Ritchie UNIX standard. C is a high-performance language that still retains portability.

Pascal/MT+: A native code compiler based on the ISO standard. Pascal/MT+ is used for software development on CP/M and CP/M-86 machines. Pascal remains a classic teaching language in computer science curricula.

CBASIC: Like Pascal/MT+, the CBASIC compiler has been used extensively by independent software vendors for years in both 8-bit and 16-bit environments. CBASIC offers the commercial extensions required for sophisticated spreadsheet and accounting applications.

In addition to compilers, IBM licensed a number of programmer productivity aids from Digital Research. For applications involving extensive data file manipulation, Access Manager provides a multi-

keyed ISAM (indexed sequential-access method). Access Manager can be used through high-level subroutine calls from all compiled languages except COBOL, which includes ISAM as a language construct.

Display Manager makes it possible to develop interactive program screens without the tedious work of defining numerous print/read statements. An interactive editor is used to type literals directly on the screen "mask." Form-filling applications are quickly implemented with an additional bonus that the subroutine library calling procedure results in less actual code than normally required for print statements.

IBM also offers the DRI object module librarian, linkage editor, and symbolic debugger.

The IBM 3270 PC offers an inexpensive option for offloading busy mainframe development systems. COBOL shops will find that Level II COBOL (developed by Micro Focus) observes the same standards and conventions used by the IBM mainframe COBOL compilers. Coupled with the Animator interactive symbolic COBOL debugger, Forms II screen and forms generator (this produces COBOL source code), the 3270 PC becomes an excellent environment for the development of mainframe COBOL programs.

T. Lowell Wolf is product marketing manager for compilers at Digital Research Inc. He can be reached at POB 579, Pacific Grove, CA 93950.

and a standard PC keyboard, with mixed success. For instance, the keyboard offers two sets of cursor keys, one for use as a PC and the other for use as a terminal. When you are operating it as a terminal, you use the PC's cursor keys as a numeric pad. The feel of the keyboard is excellent, and if you like the feel of the PC's keyboard, you will like

this one even better. But it is huge (22 by 9 inches), easily dwarfing the PCjr's.

Can an IBM PC XT be upgraded to a 3270 PC merely by installing these three cards? I performed a number of experiments to see exactly how compatible the two computers' chassis are. Unfortunately, no circuit or timing diagrams are available for the cards or system unit

of the 3270 PC, so I was forced to rely upon a few simple tests. I removed the Display Adapter and Keyboard/Timer card from the 3270 PC and placed them in a regular XT chassis. When I started the XT, I received check-out diagnostic errors, but was able to finish booting the computer with no problems. Every time I rebooted the XT, it issued diagnostic errors, but the monitor seemed to operate correctly from that point on. I had to install the Keyboard/Timer card as well. When it was not present, the color display failed to operate. Because of both its name and the fact that it must be installed in slot J8, which has special timing requirements on a normal XT, I suspect that this card affects timing in the I/O channel.

In addition, I also installed the communications adapter in an XT chassis and turned on the system. Because the control program is necessary to drive the card, I installed it at boot time as well. The results were similar to what I described above. The operating system issued a diagnostic message, but appeared to operate normally thereafter. The Keyboard/Timer card was again necessary.

Certainly, the check-out diagnostic errors indicate some differences between the two units, but the fact that the cards seem to operate normally thereafter indicates that there is hope. A detailed analysis of the circuit and timing diagrams of the cards and the 3270 PC (both unavailable at this time) should eventually reveal the answer.

The APA and PS Adapters add functions to the color graphics monitor. The APA card allows you to control the graphics monitor. It must be plugged into a slot next to the Display Adapter and connects to the latter with a special edge connector. In high-resolution, full-screen, two-color graphics mode, the APA Adapter is capable of displaying 252,000 picture elements (PELs) in a 720 by 350 pixel matrix. Without this card, the graphics monitor is not pixel-addressable. The APA Adapter also supports the PC color graphics monitor resolution of 320 by 200 pixels (64,000 PELs), allowing many programs written for that monitor to run on the 3270 PC. The PS Adapter allows you to use 3270 programmed symbols in host applications. It stores as many as six symbol sets on the 3270. It too must be

Winchester power for your PC



The proven Winchester subsystem drives for your IBM or compatible PC. 10, 15, 25, or 33 megabytes of big system storage in a DiskSystem™ you simply plug into your system and it's ready to use. At prices that make the speed and storage of a Winchester practical. Only \$1495 for a 10 megabyte DiskSystem, \$1795 for 15 megabytes, \$2245 for 25 megabytes, or \$2795 for 33 megabytes. DiskSystems can be bootable from the Winchester. See your dealer today for DiskSystem power for your PC.

I Interface Inc

21101 Chabotte Street
 Cupertino Park, CA 95130
 (415) 341-7914 • telex 669294Z

Dealer Inquiries Invited

DiskSystems is a copyright of Interface Inc. IBM is a registered trademark of IBM Corporation. Prices are suggested retail and are subject to change without notice.

I have used 3278 terminal emulators before, but none that operated with the reliability and ease of the 3270 PC.

adjacent to the Display Adapter and connects via two edge connectors to the adapter.

One limitation affecting both the PS and APA adapters is the number of slots in the computer's chassis. Slots in the chassis of a Model 5271-6 are assigned as follows:

- * 1 – Distributed Function Communications Adapter
- 2 – Free (Possible upgrade to APA or PS Adapter)
- * 3 – Display Adapter
- 4 – Memory Expansion Adapter
- * 5 – Fixed-Disk Adapter
- * 6 – Floppy-Disk Adapter
- 7 – Printer Adapter
- * 8 – Keyboard/Timer Adapter

Notice that there is only one free slot. Because of this, either the PS or APA Adapter card, but not both, can be supported. The items marked with an asterisk are essential to the computer. Although you can remove the memory-expansion card, without this extra memory-configuring the more complex versions of the control program are impossible. Slot 7 is a short slot, so removing the printer adapter won't provide the necessary space.

SUMMARY

The 3270 PC introduces high-resolution graphics and a simple connection to an IBM mainframe. I have used 3278 terminal emulators before, but none that operated with the reliability and ease of the 3270 PC. The computer interfaces quite naturally with the host. The resolution and brightness of the color monitor are truly amazing. If you demand high-quality graphics or need host-to-PC communication, the 3270 Personal Computer is a must. ■

HIGH PERFORMANCE PRINTING

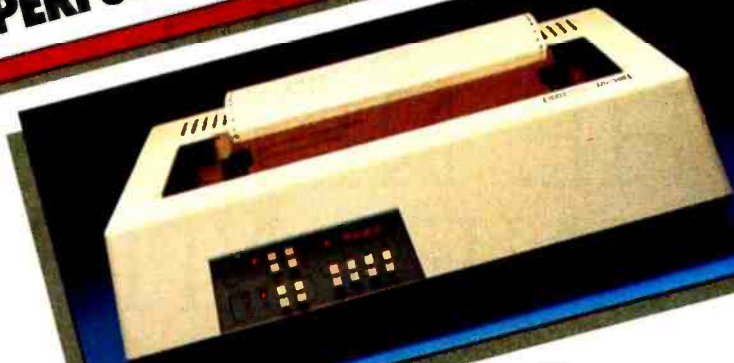

NOW AVAILABLE FOR YOUR IBM PC*



A first-class computer deserves a first-class printer. A proven high performance printer with abilities that match its reputation. A Datasouth. High performance Datasouth printers come in two models. The DS180 is a legendary workhorse that delivers crisp data quality printing at 180 CPS. The new multimode DS220 cruises at 220 CPS for data quality tasks and at 40 CPS for letter quality word processing. Both models print dot-addressable graphics. Visit your dealer and choose the high performance Datasouth printer your IBM PC deserves.

datasouth

HIGH PERFORMANCE MATRIX PRINTERS

Datasouth printers are available nationwide through participating dealers

* A trademark of IBM

Datasouth Computer Corporation
Box 240947 Charlotte, NC 28224
Call Toll Free
1-800-222-4528

MODEMS: THE NEXT GENERATION

New modems, with call-progress signal detection, alternate voice and data using smart interfaces

I'm a Telecommunications junkie. I think of the local Telenet number as my own, checking in daily for my electronic mail. I use my modem several times a day, and I'm an active participant in several computer teleconferences. I pay attention to modem technology.

I examined six modems designed to work with the IBM PC and compatibles (table 1): five in-board modems and a sixth free-standing modem that attaches to any RS-232C port—it will work with just about any computer.

I chose to review the Hayes Smart-modem 1200B because it seems to be the most popular modem in this marketplace. I selected the others on the basis of their claims for new technology or because they seemed well matched to the IBM PC. There are, however, many other modems on the market that will work with the PC.

WHAT I'M LOOKING FOR IN A MODEM

Currently, I look for an affordable modem with easy connections to both the phone and my computer. A modem should provide alternate voice and data modes and be able to switch between them. Finally, I need feedback, a way of monitoring the modem as it dials and connects to a remote modem.

First, let's talk about price. All of these new modems are hundreds of dollars less than the fancy Vadics (\$895 for the

VA212) that I use. No one should have to spend more than about \$500 for a 1200-bps (bits per second) modem today. Perfectly serviceable 1200-bps sets are selling for less than \$300.

Next, I want easy connections. I want to be able to use either an ordinary single-line residence phone with an RJ11c (modular) plug or a typical six-button office set. Can it connect to an office PBX (Private Branch Exchange)? That may be an important question for some users.

I want either a smart cable/connector for a free-standing modem or a no-complications fit into a computer expansion slot for an in-board modem. This can be a problem with the narrow slots on an IBM PC XT.

How will the modem affect my voice calls? I have one phone line in my office, as many businesses do, so I need to use it for both voice and data. Can I switch between the two modes without having the phone hang up on me? Can I use the modem to dial my voice calls? Can I turn my modem and computer into an attack dialer (one that automatically redials a busy line until it makes connection)?

The problem is at the answer end, where often you have no way of telling if an incoming call is voice or data. I've cursed when I've finally gotten through on a voice call and heard only that high-pitched tone of a computer expecting data. But I've been on the other end

too, picking up my phone with a friendly hello when the incoming call is data expecting my computer modem's answer tone. What's necessary is a quick and convenient way for the answering user to switch modes.

And finally, feedback (in tech jargon, "line status sensing" or "call-progress signal detection"). During dialing, I want to hear and see what is happening. Is there a busy signal? Is that voice response at the other end? How many rings before answering? When nothing is happening on my screen, I want the reassurance of knowing that the line is still in place, that "carrier" (an analog signal sent over the telephone network) has not been dropped.

Since some modems can report what's happening at the remote (called) location, the local computer's telecommunications software can branch to the appropriate logic path. For example, in at least some parts of the country, MCI and Sprint (long-distance calling services) can begin billing after a given number of rings, whether or not the call is successfully completed. Software could instruct the modem to hang up before exceeding the billing ring limit.

Another example: computers and modems are being set up to place a series of unattended calls, usually at low night rates. If a person answers, rather than another computer, the calling sequence can be disrupted and the calling computer might lock up. If the local modem can distinguish voice, busy, and no-answer signals at the remote end, local software could abort the call cleanly and move on to the next number.

With voice sensing, computers can control complex number sequences on the alternate long-distance services. Some of these services have voice responses in the middle of the dialing sequence; these voice responses request or acknowledge tone information. If the modem can recognize the voice signal in a timely way, the correct code can be sent by the local computer within the allowed time. Electronic banking is an application that uses combinations of tone entry and voice response to acknowledge transactions.

THE SOFTWARE GENERATION

The first time I saw the Prentice X100, I shuddered. I didn't see a light or a switch anywhere on it. How was I to tell

if carrier dropped? How was I to change from 1200 to 300 bps without a toggle switch?

Well, the X100 is tucked away on the floor behind my desk. All of its information comes to me in comprehensible words on the screen. I never have to turn my head away from the video in front of me. There are no blinking lights for me to interpret. If there is a vestigial twitch of my head toward a nonexistent

carrier-detect light, I ignore it.

No two modems came with the same software, although Novation comes bundled with Crosstalk (the IBM PC communications package), and Cermetek will sell you Crosstalk at a big discount, if you buy its modem. Bizcomp tells you how to configure its product for Crosstalk.

The software that did come bundled with each product (see table 1) varied

widely in performance, ease of use, flexibility, setup requirements, and documentation. However, there is a definite trend toward on-screen labeling of the function keys, with powerful command strings built into each key.

More and more manufacturers are settling on the Hayes instruction set in the ROM (read-only memory) firmware as a standard. In some cases, there is a superset or subset of the Hayes set. This de facto standard lets me use the same communications software and the same macros on different hardware.

I'll admit my perception of the different modems was strongly affected by the power and flexibility of the software I used with them. To wash out the software differences and focus on the hardware, and to write macros that use new feedback features such as call-progress signal detection, I used a small set of generic telecommunications software packages (table 1).

PRENTICE X100 POPCOM

My favorite modem is the X100 POPCOM from Prentice. It has all the features I want and works with all three of my computers (PC, PCjr, and Radio Shack Model 100). The innovative plug, the modem's small size, and the smart RS-232C interface make this the easiest free-standing modem to install that I've ever seen.

The RS-232C connector worked with every cable I tried—3-line, 25-line, straight-through, or crossed-transmit-and-receive data lines, even odd combinations of those cables. Prentice has figured out how to handle not only both modem data lines and computer data lines, but mixtures of the control signals as well.

Complete call-progress signal detection is another X100 feature I love. I wrote a macro that lets my telecommunications software branch as necessary and keeps me informed along the way. The combination of call-progress detection and voice/data switching lets me use the X100 as a "demon dialer." Attack dialing, in which your phone keeps trying a remote

(continued)

Mark Klein (8 Bay Rd., Newmarket, NH 03857) works for IE Systems, a communications software house in Newmarket, NH. He is a contributing editor to BYTE.



Photo 1: The thickness of the board configured with a speaker may concern you if you own an XT. From the top: Hayes, Microcom, Novation, Bizcomp, and Cermetek.

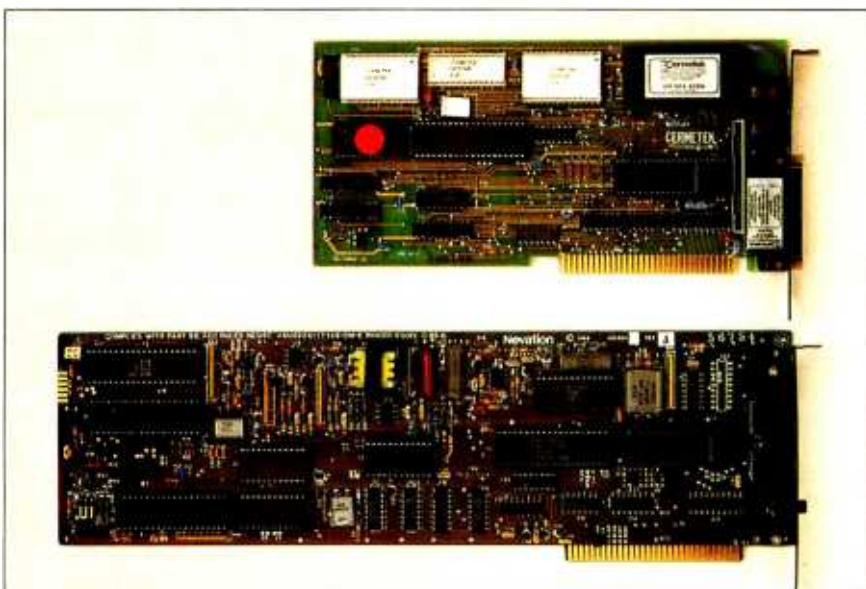

Photo 2: The length of the Cermetek compared to the Novation.

Table 1: Modems surveyed.

Company	Modem Model	Software Supplied	Software Used	Suggested Retail Price
Prentice Hayes	X100 POPCOM Smartmodem 1200B	none Smartcom II	Acculink Smartcom II	\$475 \$599
Bizcomp	PC:Intellimodem	PC:Intellcom	Crosstalk	\$499
Novation	ACCESS 1-2-3	Crosstalk	Crosstalk	\$595
Cermetek	INFO-MATE 212PC	Modem-Mate	Acculink	\$480
Microcom	ERA 2	ERA 2	ERA 2	\$499

number until it completes a call, threatens to tie up our entire phone system, unless modems and auto-dialers can sense voice or busy signals. Some restrictions now apply to attack dialing; more will be forthcoming as the problem worsens.

When I have to make a call to a number that is likely to be busy, I let the X100 dial for me. When I hear the other party answer, I pick up the phone and begin talking. A pleasure! I even set the number of retries on busy to a value below the FCC limit of 15.

Voice/data switching eliminates the need for two phone lines when two people are sending files between their computers. Does this sound familiar?

"OK, I'm going to switch now. Mark? Mark? Mark, pick up the phone. Mark, are you there? My end is not working."

With an X100 at both ends, switching to voice mode is a cinch—just pick up the phone.

If you were in data mode, the X100 stops sending carrier, goes "on-hook," and sends the PHONE message to the local screen. The X100 at the other end senses the loss of carrier, but instead of hanging up like older modems, it holds the line for a software-specified length of time and turns on its speaker. Your not-so-frantic "Mark, pick up the phone" comes through loud and clear.

When the remote operator picks up his or her phone, the remote modem goes "on-hook," sends a PHONE message to the screen, and establishes voice connection. The X100s are out of the way. Of course, by reverting to data mode you can push the modems back to handshake mode again.

I put the X100 over one last hurdle. Since it has an RS-232C port, I connected the X100 to a Tektronix Model 834 bit-error-rate tester. I ran the test all afternoon and evening without seeing an error. Because the other modems I

was trying out are all in-board models, I have no basis for comparison, but the X100 looked good to me and has worked well.

BIZCOMP'S PC:INTELLIMODEM

Bizcomp's PC:Intellimodem is an in-board modem that supports the full range of call-progress signal detection and has an extensive instruction set. PC:Intellimodem senses voices and switches between voice and data.

I had two problems with the board, one minor and one annoying. The minor problem was with the PC:Intellicom software that was bundled with the modem. I addressed the modem as COM2:, which is the default setting from the factory. When I tried to run the software, I was unable to communicate with the modem. A quick call to the factory uncovered the bug: if another device was attached to COM1: (a common situation), and if cable from that device "jumped" some of the RS-232C control lines, then the program wouldn't work.

At the time of the Bizcomp trial, the Prentice X100 was plugged into COM1. As soon as I unplugged the COM1: cable, the PC:Intellicom software could communicate with the board. The software was written in BASIC, so when Bizcomp sent me a two-line patch, the fix was easy. While I was waiting for the mail to bring the patch, I used Crosstalk to drive the modem, with no problems.

The feedback problem was more annoying. The PC:Intellimodem has a buzzer instead of a speaker. During auto-dialing, the buzzer was satisfactory, but whenever there was voice response, the "zzst" drove me up the wall.

Turning off the buzzer was another problem. The Intellicom software and Crosstalk turned on the buzzer during dialing and turned it off after the data

connection was established. (Crosstalk used a monitor-on dialing prefix that I gave it at setup, using instructions in the Bizcomp manual.) Evidently, both software packages left the buzzer active after hanging up the phone. In the midst of some other program, I picked up the phone only to hear that "zzst" from the buzzer with every word I spoke. Probably, I could write a script file with Crosstalk that would turn the buzzer off, but I didn't bother. Too much trouble.

A good feedback feature on the Intellimodem is a red LED (light-emitting diode) sticking out the back end of the board and visible from the rear of the computer. You can write software to switch that light to indicate the state of several of the RS-232C lines, including the ring indicator (RI), the data carrier detect (DCD), transmit data (TXD), and receive data (RXD). If you encountered a problem, knowing the status of those signals might help.

Another interesting design feature of the Bizcomp Intellimodem is a third RJ11 modular plug socket. Most modems have two, one for the telephone company line ("to wall") and one to the telephone ("to phone"). The third socket is for a telephone handset. With the Bizcomp software, a function key switches from data to voice and activates the handset. Bizcomp recommends using the handset and telephone company line sockets.

Trouble starts when you're working at your computer, using any program other than the communications software, and the phone rings. If you only have a handset in the top socket, and no phone in the second socket, Bizcomp tells you to exit from your applications program, call up the communications software, press the function key, and then use the handset to answer the call. Do they really expect someone to go through that rigamarole? The manual suggests that if you are expecting a phone call, you should plug a phone into the middle socket. Well, if the whole phone is there, who wants the handset, too? Seems cumbersome to me.

Overall, except for the buzzer, I like the PC:Intellimodem. Good communications software can get around the other problems, and it does have call-progress signal detection.

(continued)

MICROcentre™ Work Stations

**Engineered
to Optimize
Business
Efficiency**



Microcentre™ workstations are the ultimate choice of any business where operating efficiency is as essential as computer power.

Within seconds Microcentre opens your business day, ready to give you full command and comfortable access to your system, with all components positioned at your fingertips.

A conveniently located surge, spike and noise protecting power center* allows you to activate your entire computer system at the turn of a switch. Now you're ready for a productive business day.

With the same ease used to access your computer, you can confidently exit your workstation by locking your valuable hard-

ware and software, with the stylish European locks provided by Microcentre.

Although generous in features, each Microcentre model is frugal in the use of floor space and can be readily relocated to give maximum flexibility for your computer use.

Since you cannot select the right workstation unless you have a choice, Microcentre offers a variety of models, colors, in premium quality laminates and beautifully hand-finished woods to meet your specific requirements.

The unparalleled efficiency and superior quality of Microcentre guarantee a sound investment and a workstation you can depend on.

EXECUTIVE 102 (Walnut)

Model 103*

Model 104 NEW!



\$1495 (Sugg. retail)



\$995 (Sugg. retail)



\$595 (Sugg. retail)

MICROcentre™
Continental Engineering Group, Inc.
Patent Pending

For more information call Continental Engineering Group, Inc. or your local dealer.
Outside California: 1-800-821-6279
(Call in CA: 818) 390-8371
Dealer inquiries welcomed.

*Circle 109 on Inquiry card

CERMETEK INFO-MATE 212PC

This modem is smaller than the others—nearly half the size of the full-length cards—with the lowest chip count of any of the board modems. It will fit easily into an IBM PC XT slot without bothering the board next door.

Cermetek shrank its board by using

some custom logic chips and by leaving off a speaker. By now, you know how I feel about having my sound. However, Cermetek almost makes up for this omission by including two valuable features.

First, a DB25 connector at the back end of the card can be turned into another RS-232C port when you're not

using the 212PC as a modem. You can select the modem or RS-232C port using software or a pair of the 10 option switches set with jumper connectors.

Four more option switches set the I/O (input/output) port address, so that the 212PC does not limit you to just COM1 and COM2. Some IBM-compatible computers have serial ports built into their motherboards, so that plug-in modems can't use those addresses. Cermetek also lets you address its board at 3F8 and 2F8 (hexadecimal). If your communications software can talk through these ports (special versions of Crosstalk can, as well as the Modem-Mate package that is bundled with the 212PC), you can sneak in an extra I/O port and bring a smile to the face of an RS-232C junkie.

Cermetek is an experienced modem manufacturer, and this is reflected in the sophistication of the command set. There are several test modes: analog loop, analog loop self-test, digital loop, remote digital loop, remote digital loop self-test, and end-to-end self-test. A "quiet" command, ZZZZ, silences the transmitter but keeps the modem off the hook. With INFO-MATE 212PCs at both ends, this command lets you use the telephone connection for voice in between data transmissions.

And finally, the 212PC has call-progress detection. The dialing commands are flexible. The modem can wait for a dial tone or wait for a fixed time without monitoring for a dial tone. Unless you specify tone or pulse dialing, the 212PC uses adaptive dialing. In this mode, unique to Cermetek, the modem automatically selects tone or pulse dialing according to what it senses on the line. After dialing is complete, status messages appear. Each R indicates a remote ring; V is for voice; B is for busy; W means that the other end answered, but at the wrong speed; and A indicates data call connection. Multiple status messages are allowed, and a response such as

221-4567RRRV
A

means that the number 221-4567 was dialed and rang three times, and then a voice was detected. The modem con-

(continued)

What do you get when you cross 1200 baud, free on-line time, and extra features at a price Hayes can't match?

Data Rate?

The MultiModem gives you a choice—either 1200 or 300 bits per second. So you can go on-line with the information utilities. Check out bulletin boards. Dial into corporate mainframes. Swap files with friends.

On-Line Time?

With the Multi-Modem you get CompuServe's DemoPak, a free two-hour demonstration of their service, and up to seven more free hours if you subscribe. You also get a \$50 credit towards NewsNet's business newsletter service.

Features & Price?

Of course, the MultiModem gives you automatic dial, answer, and disconnect. Gives you the Hayes-compatibility you need to support popular communications software programs like Crosstalk, Data Capture, our own MultiCom PC, and dozens of others. Gives you a two-year warranty, tops in the industry.

But Better?

Yes. The Multi-Modem gives you features the Hayes Smartmodem 1200™ can't match. Features like dial-tone and busy-signal detection for more accurate dialing and redialing. Like a battery-backed memory for six phone numbers. All at a retail price of just \$549—compared to \$699 for the Smartmodem.

What do you get? The new MultiModem, from Multi-Tech Systems. Isn't this the answer you've been looking for?

For the name of your local distributor, write **Multi-Tech Systems, Inc.**, 82 Second Avenue S.E., New Brighton, MN 55112. Or call us at (612) 631-3550.

MultiModem.

Now available in IBM PC Card Version



The right answer every time.

Circle 119 on inquiry card.

Trademarks—MultiModem, MultiCom PC: Multi-Tech Systems, Inc.—CompuServe: CompuServe Information Services, an H & R Block company—NewsNet: NewsNet, Inc.—Crosstalk: Microstul, Inc.—Data Capture: Southeastern Software—Smartmodem: Hayes Microcomputer Products, Inc.

The cost breakthrough. The technology breakthrough. Interactive video systems from Visage.

Would you like to reduce your training costs and improve your training yield?

Are you looking for a way to disseminate information effectively?

Do you need a system to manage a visual database?

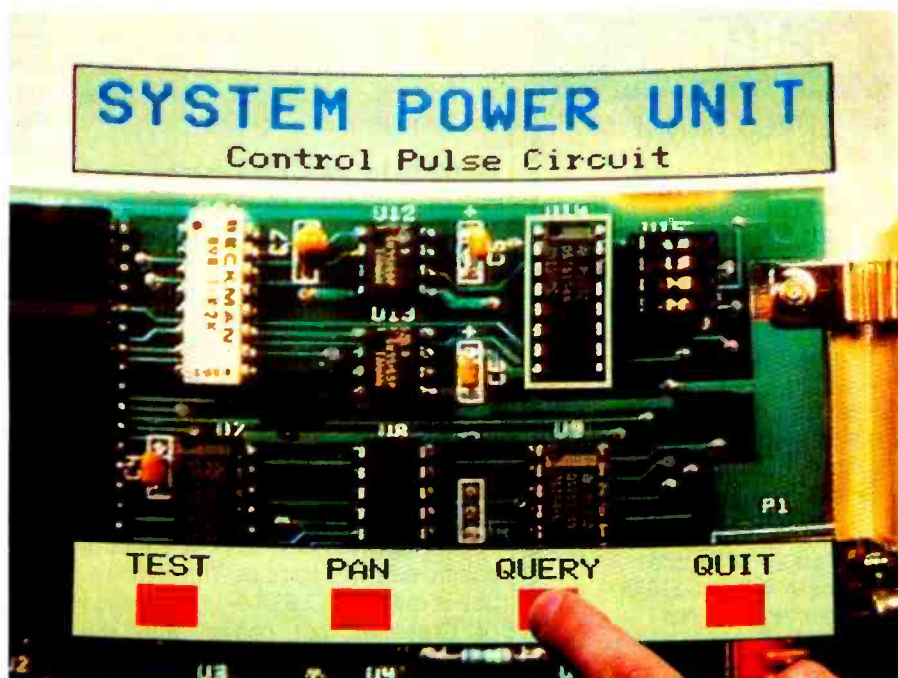

Visage is a company totally devoted to interactive video systems and support, all based on the IBM PC™ and compatibles. We can bring our state-of-the-art technology into your business, and give you the software tools to develop your application quickly and easily.

Uniting laser video discs and computers, the Visage V:Link™ line of products opens the door to realistic, cost-effective interactive video applications. With such features as universal video disc player control, digital data decoding and graphics overlay, the V:Link interactive video system delivers more performance for the dollar than any other medium. Add V:Link software, such as high-level program development tools and sophisticated graphics development package, and you have an unbeatable system for the creation of interactive video programs. V:Link interactive video hardware and software is already being used in the development of such applications such as:

- Field service instruction for complex equipment repair.
- Industrial training for sales, assembly, management, and more.
- Point-of-sale demonstrations, displays, and information distribution.
- Visual databases for archive storage and retrieval.

Visage is the company to supply your interactive video needs. Whether you have a direct or O.E.M. interest, we have systems available now. No one else can offer such powerful features at such an attractive price. If you are a pacesetter, get in touch with the industry leader in interactive video.

© 1984 Visage, Inc.
IBM is a registered trademark of International Business Machines Corp.
V:Link is a trademark of Visage, Inc.

Circle 67 on inquiry card.

VISAGE™

INTERACTIVE VIDEO SYSTEMS

Visage, Inc.
12 Michigan Drive
Natick, MA 01760
(617) 655-1503

Fall 1984 • BYTE Guide to the IBM PC • 243

DeSmet

C

The fastest 8088 C Compiler available

FULL DEVELOPMENT PACKAGE

- C Compiler
- Assembler
- Linker and Librarian
- Full-Screen Editor
- Newsletter for bugs/updates

SYMBOLIC DEBUGGER

- Monitor and change variables by name using C expressions
- Multi-Screen support for debugging PC graphics and interactive systems
- Optionally display C source during execution
- Breakpoint by Function and Line #

COMPLETE IMPLEMENTATION

- Both 1.0 and 2.0 DOS support
- Everything in K&R (incl. STDIO)
- Intel assembler mnemonics
- Both 8087 and Software Floating Point

OUTSTANDING PERFORMANCE

Sieve Benchmark

COMPILE	4 Sec. RAM —
	22 Sec. FDISK
LINK	6 Sec. RAM —
	34 Sec. FDISK
RUN	12 Sec.
SIZE	8192 bytes

**DeSmet C
Development Package \$159**

To Order Specify:

Machine _____

OS MS-DOS CP/M-86

Disk 8" 5¼ SS 5¼ DS

CW A R E
CORPORATION

P.O. BOX 710097
San Jose, CA 95171-0097
(408) 736-6905

California residents add sales tax. Shipping: U.S. no charge. Canada add \$5, elsewhere add \$15. Checks must be on a US Bank and in US Dollars.

tinued monitoring and, finally, received an answer tone. Such a sequence could appear if the remote phone is answered manually and then switched into data mode.

Now, if the index in the manual only had page numbers next to the topics (an editor's oversight I'm sure) or if the modem just had a speaker. . . .

NOVATION ACCESS 1-2-3

Novation is clever. Using custom logic chips, it makes a board modem that has nearly half the chips of the Hayes, and only a few more than the Cermetek. The firm uses a full-length board, but it's thin and I still get my speaker. Tucked away on the lower corner is a three-prong connector, and Novation supplies a cable to hook its board to the speaker on the PC motherboard. Makes sense, doesn't it?

Novation bundles its board, the PC 1200B, with Crosstalk XVI, a powerful communications package. The combination is called ACCESS 1-2-3. The version of Crosstalk that comes with the package has some special features to take advantage of the hardware.

First, there is a Port 3 address, for IBM compatibles (Novation gives you one extra port). Second, there is some call-progress display. During dialing, the status line will show the presence of a busy signal or the absence of a dial tone. And there's the rub. I'm spoiled. I want the full call-progress detection of the X100.

The rest of the package is good. There are several test modes: hardware integrity, analog loopback, local digital loopback, and remote digital loopback. Novation has the usual two modular jacks for telephone handset and phone line. RJ11, RJ12, and RJ13 jacks, both C and W, will work. The command set is complete, and Crosstalk knows how to exercise the commands. This is a solid package, but not quite as state-of-the-art as some of the others.

MICROCOM ERA 2

The Microcom ERA 2 at first seems like a plain-vanilla, Hayes-compatible modem with no special call-progress detection. It uses the Hayes instruction set, has a speaker, and comes in a pretty box with a good manual. (The ERA 2 also is available as a stand-alone model, which I did not review.) But

because of Microcom's Network Protocol (MNP), it has some very special capabilities.

With Microcom's modems you can establish a reliable link between two computer systems for all the traffic between them. For this kind of dance, though, it takes two to tango. If The Source had an ERA 2 at its end, and I had one at mine, it could mean the end of that pesky line noise that often shows up on my screen as random characters when I'm in the midst of some crucial search.

Well, that low noise state may be coming. UNINET has several Microcom modems in place, accessible by local phone calls in Atlanta, Boston, Chicago, Dallas, Houston, New York, San Francisco, Washington, and other cities. Users with ERA 2 or modems incorporating MNP (such as the internal modem on the IBM PCjr) can use what Microcom calls Reliable Mode.

The ERA 2 is flexible about link protocol. You can set up the communications so that your modem tries to establish an MNP link, but will drop back into normal interactive mode if it is unable to make a Reliable Mode connection. Otherwise, the modem is straightforward.

Like the Hayes 1200B, it uses a Z8 microprocessor and has sockets for modular plugs from both the telephone company's wall line and the phone itself. The on-board speaker is very thin, but because about two-thirds of the components live on a piggyback board, the overall board is wide. Also, like the Hayes, it needs an empty slot next to it in an XT chassis.

From my viewpoint, if you work in an environment that needs accurate trans-action processing despite a noisy line, installing Microcom modems at each end makes sense. If you can't control the remote end, there is little advantage to the ERA 2. If the MNP protocol continues to penetrate the market, the protocol may find more widespread use on the public data networks and common carriers. Until then, call-progress signal detection is more useful.

HAYES SMARTMODEM 1200B

This is the standard. A passenger in the seat next to me on the Eastern shuttle between Boston and New York was traveling with a Compaq. After he

watched me work with my Model 100 from Radio Shack, we started talking shop. I asked what modem he had inside his box. "Hayes," he answered, with a look that said, "Doesn't everyone get

a Hayes?"

The Hayes speaker on the board is large, making the modem wider than a regular PC board. But since the speaker is at the end of the board nearest the

front of the computer, the modem can occupy a slot next to a short card (such as the IBM floppy-disk controller) without the speaker's height affecting

(continued)

The Computer-Modem Dialogue

The RS-232C interface between the computer and modem uses a standard vocabulary. When a free-standing modem with an RS-232C port is connected by cable to the RS-232C (DCE) port on the computer (DTE), this vocabulary seems appropriate. But when the modem is on a board inside the computer, when no RS-232C port is in sight, and when the actual interface deviates from the RS-232C standard, more patience is required to unravel the signals. My math teacher from years ago would call this a clean-sheet-of-paper, cold-glass-of-lemonade, no-distractions job.

RS-232C signals fall into four groups: ground, data, control, and timing. Ground may include pins 1 and 7, but usually just 7. Data signals through pins 2 and 3 transmit and receive information. Timing signals are irrelevant here. It's the control signals we need to talk about: request to send (RTS), clear to send (CTS), data set ready (DSR), data terminal ready (DTR), ring indicator (RI), and data carrier detect (DCD).

Whether the modem is in-board or free standing, an 8250 UART (Universal Asynchronous Receiver-Transmitter) is between the modem processor and the computer's address, data, and control buses. The UART reformats bytes of data from parallel format (bits are side by side) to serial format (bits in a row) for transmitting. Each of the in-board modems has an 8250 on the printed-circuit board. A free-standing modem connects to an asynchronous communications board or multifunction board with an 8250 on it. If an 8250 or modem is to interface with the public-switched telephone network, four signals are required by the RS-232C standard: DSR, DTR, RI, and DCD.

DSR and DTR are equipment-readiness indicators. In contrast, the RTS/CTS pair is used as a channel-readiness indicator. DTR and DSR are used with automatic dialing and automatic answering equipment. For example, after the modem has dialed the call, established the connection, and is in data-transmission mode, DSR is turned on. The modem tells the computer that it's ready to go. Similarly, if the modem is connected to the telephone network and the computer

turns off DTR, the modem is disconnected from the communications channel.

That's how it's supposed to go in theory; understanding actual practice requires close reading of the manuals. For example, the Hayes 1200B ignores RTS, CTS, and DSR. When DTR is off you completely disable the modem so that it will accept neither commands nor auto-answers. DCD indicates the presence of carrier.

The Prentice X100 has a richer, more complex instruction and register set. Like the Hayes, it doesn't use RTS. But you can set three modem modes in software to define the control lines. Dumb Terminal mode holds DSR, DCD, and CTS true, so a simple three-wire cable can be used. Smart Modem mode can set CTS false when the local phone goes off the hook, allowing convenient voice/data switching. Also in this mode, DSR and DCD go false when carrier is lost. Bell 212 mode follows the conventions of AT&T modems, with CTS going true 200 milliseconds after carrier is detected.

The Cermetek 212PC has a hardware option switch, a jumper that chooses between normal RS-232C operation for CTS, DSR, and DCD, or having those signals forced to the same state as DTR.

What's the significance of this diversity? Manufacturers are choosing slightly different ways to implement the "smart" features on their modems. Users must decide which modems have the features they want, which communications software packages support those features, and how they must set up the modem so that the software can access the signals it needs. (Crosstalk, for instance, controls the DTR line and expects to see DCD true only when carrier is actually present. Modem features such as "DTR override" and "DCD forced true" must be disabled if Crosstalk is to work. Fortunately, the modem manuals have the information you need to do this; I used Crosstalk successfully with several of the new modems and with the 1200B.)

For more technical details, see *Data Communications for Microcomputers*, by E. A. Nichols, J. C. Nichols, and K. Musson (McGraw-Hill, 1982).

GLOSSARY

RTS—request to send, an RS-232C control signal sent from the computer to the modem, asking the modem for permission to transmit data (used with clear to send, CTS).

CTS—clear to send, an RS-232C control signal sent from the modem to the computer, saying that the modem is ready to receive data from the computer; sometimes indicates local phone is on or off hook.

DSR—data set ready, an RS-232C control signal sent from the modem to the computer, saying whether or not the modem is connected to the (telephone) communications channel (used with data terminal ready, DTR).

DTR—data terminal ready, an RS-232C control signal sent from the computer to the modem.

DCD—data carrier detect, an RS-232C control signal sent from the modem to the computer, indicating that carrier is present (used with DTR).

RI—ring indicator, an RS-232C control signal sent from the modem to the computer, indicating that the modem is receiving a ringing signal from the telephone network.

DCE—data communication equipment, such as a modem.

DTE—data terminal equipment, such as the IBM PC (RS-232C ports on the PC are configured as DTE).

Carrier—an analog signal sent over the telephone network.

Modulation—the process of modifying the carrier so that it varies according to changes in another analog signal (the modulating wave).

RXD—receive data.

TXD—transmit data.

Printer sharing systems for multiple computers and printers.

Add MultiSpool – the hardware spooler that's truly flexible. Now, thanks to MultiSpool, there's no more need to buy individual spoolers, no more wasted computer time or memory. With its enormous memory-sharing power, this dynamic six-port switching device not only lets you network any combination of computers and printers; it also provides the spooling function within that network.

With its 60K of buffer memory, controlled by 4K of memory management firmware, MultiSpool can orchestrate up to five computers or



five printers simultaneously. Only this degree of flexibility can meet the ever-changing port-expansion needs of today's multiuser environment.

Note, too, that MultiSpool mixes four serial and two Centronics-compatible ports. It also handles X-on, X-off protocols and DTR. So, with the unit's dipswitch, you can configure each port to accommodate either a computer or printer; and you can define the discipline of that port.

Best of all, MultiSpool sells for just \$1,295 – even less if you don't need all six ports. And that, we're sure, is music to your ears.



Digital Laboratories Inc.

600 Pleasant Street, Watertown, MA 02172. (617) 924-1680

NEW-GENERATION MODEMS

the adjacent board.

The modem handles both single- and multiline connections. It can be addressed as either COM1 or COM2, but not as COM3 or higher. A register controls the testing feature of the 1200B. Hayes calls this "self-test," rather than "loopback." One setting of the register tests the originate mode, and one tests the answer mode.

The Hayes Smartmodem lacks call-progress detection. Without it, the modem cannot sense either busy signals or voice. It must be programmed to wait for carrier for a specified length of time. If carrier is not detected within the preset time, the modem hangs up (goes on hook). Hayes ships the modem with a default setting of 30 seconds, which to me seems to be a long time to tie up the phone line in an automatic dialing environment. Further, the 1200B cannot detect the presence of a dial tone. Instead, it waits a programmable length of time (the default setting is two seconds) and then assumes the dial tone is present. This usually works, but there could be problems when dialing through a cranky PBX.

The Smartmodem 1200B works well. It has a speaker for audible feedback, the Hayes instruction set, excellent documentation, a good reputation, and Smartcom II, a well-integrated communications package.

If you can get along without call-progress signal detection, then the Hayes Smartmodem is an OK choice.

SUMMARY

At least these modem manufacturers are not copycats. Each has built its product with a slightly different set of features, some using custom logic chips and a different board design.

Since several of the powerful, standard communications software packages will drive any of these modems, I have tried to steer clear of the software variable. Consider the software that comes bundled with the modem. For a typical installation, the call-progress detection features that are available and supported in software will be the most important factors in a buying decision. "Know what you need," and "try it before you buy it" are still wise maxims in the modem market. ■

My LIBRA software system means as much to my business as my business means to me.

Software: Unequaled in comprehensive application for small business. Fully integrated, adaptable to the way you do business.

General ledger, payroll, billing, payables, receivables, estimating, costing, sales analysis, inventory control, property management, time accounting, client write-up, broadcast, tax preparation . . . and more.

Hardware: Available for the IBM PC-XT. . . and soon for the IBM System 36.

Training: LIBRA Support provides a total instructional and hands-on training program.

Call toll free
800-453-3827

IN ALASKA/HAWAII 800-453-7790



LIBRA is a major supplier of business application software and an authorized IBM Value-Added Dealer.



©1984 LIBRA PROGRAMMING, INC.

1954 EAST 7000 SOUTH SALT LAKE CITY, UT 84121-3094 (801) 943-2084

Become a dBASE II[®] expert without cracking a book.



dBASE II is, quite simply, the best-selling database management system (DBMS) made for any computer, ever. And with over 150,000 users so far, it's become the standard for managing data with a microcomputer.

Jump into dBASE II, disk-first.

The best way to learn to use dBASE II is to use dBASE II. Our on-disk tutorial is a hands-on interactive learning system that will get you up to speed on dBASE II, quickly and easily. Then you can use your new-found knowledge to create a full business information system that does exactly what you need done. A system that will handle today's problems, yet grow with you.



dBEST deal in town.

When you buy dBASE II, you'll be getting the most advanced information management tool available for your micro for only \$700 (suggested retail price). At the same time, you'll be getting the most advanced teaching tool (the dBASE II On-Disk Tutorial) for free.

For the name of your nearest dBASE II dealer, contact Ashton-Tate, 10150 West Jefferson Boulevard, Culver City, CA 90230, (800) 437-4329, ext. 217. In the U.K., call (0908) 568866.

ASHTON-TATE

dBASE II is a registered trademark of Ashton-Tate.
©Ashton-Tate 1983

BY JAY SIEGEL

MOVING DATA BETWEEN PCs AND MAINFRAMES

*Moving shared data around once you access it is still a problem
in an industry without standards*



Sooner or later all of us will be moving data, and not just from the word processor to the printer but from one applications program to another, between microcomputers, and in many cases to and from a mainframe.

During the seventies many major U.S. corporations relied on remote computer services for both information and applications software. The success of the microcomputer in the eighties may have slowed the rapid growth of these remote services, but it has also opened up new markets and opportunities. Many timesharing data vendors have introduced software that makes it easier for a microcomputer to access data on their mainframes. The major stumbling block to the proliferation of this service has been incompatible data structures among the different microcomputers.

I'll focus on the hows and whys of transporting data between programs and computers. I'll also outline some of the database services that I find helpful in my work.

Accessing a remote computer is relatively easy. What is not always as easy is downloading data from a remote computer to a microcomputer in a form that can be used in particular applications programs such as VisiCalc, SuperCalc, and Lotus 1-2-3.

TECHNICAL ISSUES: FORM AND STRUCTURE

Coding data electronically is at once an obvious and an elusive concept. Data has a format and structure that ties together the bits and bytes of computer information. This structure makes data meaningful and, correspondingly, difficult to move around between either programs or computers:

One program's data format is another program's gibberish.

The IBM PC stores data as 8 bits or 1 byte. A byte is a sequence of eight 0s and/or 1s, which makes for a total of 256 different combinations of 0s and 1s. These binary numbers can represent a computer chip's instructions or data (text and numbers). To represent text, such binary numbers must be translated into the letters, numbers, and symbols (such as commas, semicolons, and quotes) that compose data. These numbers are translated in most microcomputers using a nearly universal code called ASCII (American National Standard Code for Information Interchange). ASCII uses 7 bits and provides a translation for 128 characters: 54 letters (upper/lower-case), 10 digits (0 through 9), and assorted punctuation marks, symbols, and control codes.

IBM never joined the ASCII convention and adopted another coding scheme called EBCDIC for its mainframe computers. (Pronounced Eb-suh-dick, it stands for extended binary-coded decimal interchange code.) The difference between ASCII and EBCDIC is one of the first, but not the most significant, barriers to communications between IBM mainframes and microcomputers.

ASCII uses only 7 bits, while most microcomputers store information in 8-bit bytes. That small difference creates a major problem in moving data. Some applications programs use this "free," or unused bit, making it an integral part of

(continued)

Jay Siegel (POB 60997, Palo Alto, CA 94306) is a managing director of Quantitative Software Reports. He formerly worked for Data Resources Inc. and taught economics at the University of Toronto.

ILLUSTRATION BY SETH JABEN

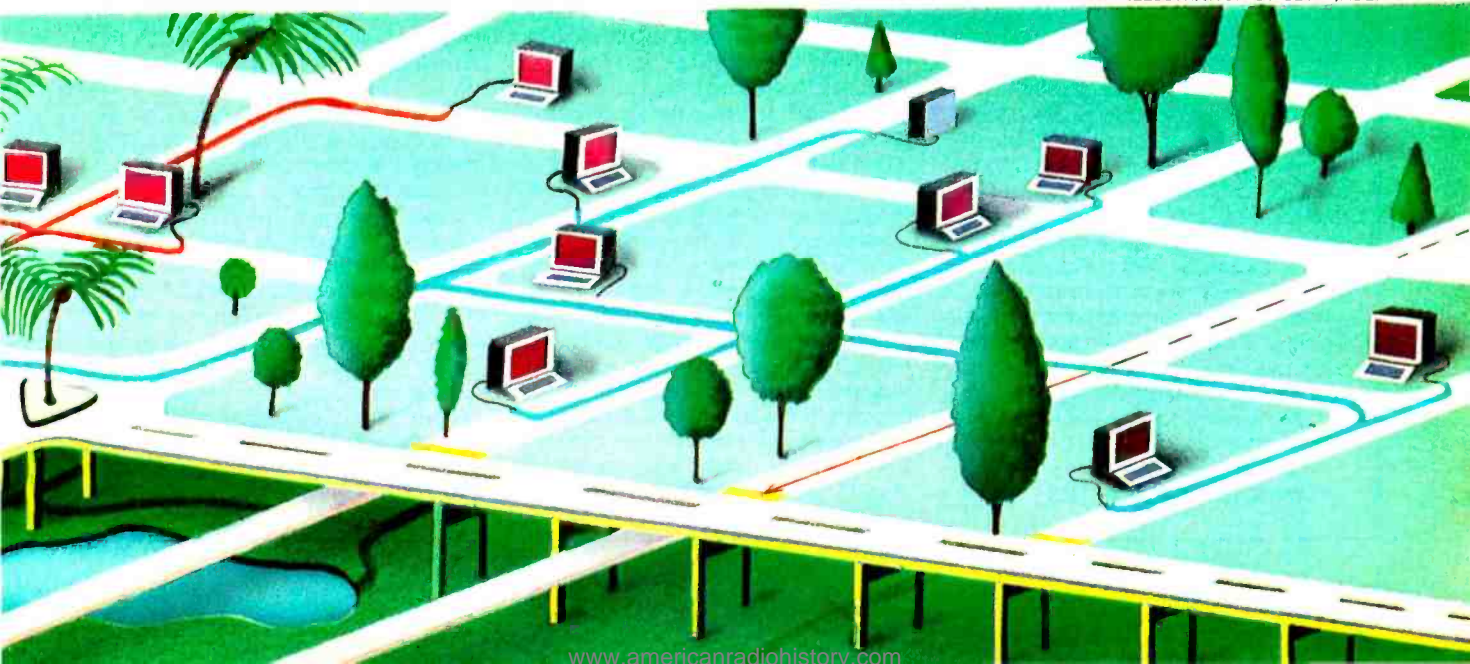

the data for that program. WordStar uses this eighth bit in document files to format the text on the screen or for the printer.

IBM extended ASCII on the IBM PC to encompass this free bit and thereby increase the number of characters that can be coded and displayed to 256. IBM used the extra 128 characters to extend the set of symbols to include a musical note, a happy face, line graphics, foreign letters, and other symbols. IBM refers to this translation as Extended ASCII, a superset of standard ASCII.

Data files are of two types—stream or rectangular. A stream file is a simple sequential flow of bits. A stream file has no internal structure that can't be represented by specific ASCII characters: a centered heading or a paragraph separated by a blank line or indicated by indentation, for example. The data itself determines how the document ultimately looks when printed on a piece of paper. Essentially, you create that structure as you enter the information.

A rectangular data set has an internal structure that groups the data into subsets, often called fields, and the fields into records. A rectangular data file can be thought of as a matrix with the columns representing data fields and the rows records. This structure is identical with a spreadsheet's data structure. In fact, the relationship between the spreadsheet structure and rectangular data files will prove to be very important in many of the methods of moving data between microcomputers and downloading information.

ASCII provides a standard form for reading data. However, how the letters are grouped and whether or not digits are to be read as numbers or text are determined by the format of the file. There are basically two types of formats—fixed and free. Fixed formats define the data characteristics for specific locations in the data field: for example, columns 7 through 10 might be text and columns 11 through 12, numbers. The advantage of a fixed format is its precision. There is a negative side to this, however, as this precise description must be known by the program that is reading the data.

Free formats use delimiters to separate fields and identify text by surrounding it with quotes. The most common free format is the comma separated value (CSV) format, in which the comma is the delimiter separating fields and quote marks surround text.

DIF, which stands for Data Interchange Format, was developed by Software Arts, the creator of VisiCalc, as a standard ASCII format for interchanging data between applications programs. DIF was designed to handle spreadsheet data and can describe labels (text) and numbers along with their row and column location. (DIF was explained in detail in an article, "DIF: A Format for Data Exchange Between Applications Programs," November 1981 BYTE, page 174.) DIF cannot, however, convey the formulas or format instructions in a spreadsheet. Sorcim, the creator of SuperCalc, has developed SDI (Super Data Interchange), an extension of the DIF con-

Lotus's Symphony Offers Downloading Options

Symphony, the new product by Lotus Development Corporation (Cambridge, MA), the creator of 1-2-3, opens up new possibilities for downloading via the data-capture method. Symphony is an integrated product that provides spreadsheets, word processing, graphics, database management, and communications in a single environment.

The spreadsheet is the basic data structure (the metaphor, to use the current buzzword) for storing data. To download data from a remote source, Symphony uses the capture option to store data in a range in the spreadsheet. If the data is to be captured from a stream format file, then the range encompasses a single column of the spreadsheet. If the data is in rectangular format, then the range name will encompass two or more columns.

Symphony's communications module provides all of the standard options: the user can set word length, stop bits, modem speed, handshake protocol, etc. It also conforms to the XMODEM file-transfer protocol to directly transfer file from most of the major microcomputers.

However, the integration of the commu-

nications module with the other Symphony functions amplifies the program's capabilities. For instance, Symphony's expanded macro abilities make it possible to automate a complete telemarketing application. Given a prospect's name, the database manager locates the telephone number, which is then dialed automatically by the communications module. When the phone is answered, the modem is switched to voice mode, and the database manager displays a call report form on the screen to record the results of the phone call. This is then updated in the call report data range.

In Symphony, the central role of the spreadsheet in defining data has very important implications for downloading. In the communications mode, Symphony can capture to a range, which the user specifies, data that is being sent from the remote computer and displayed on the monitor. The format of the data captured is linked to the spreadsheet database structure. If the data to be transferred is one column wide, then the specified range will be a single column and data will be stored in stream format (variable-length

records, stored by rows within the single column).

However, if the data encompasses several columns, then a rectangular data structure is specified by using multiple columns. For example, if the data coming from the remote computer service is captured to a range containing eight columns, each of width 10, then the first 10 characters go into the first column, the next 10 into the second column, and so on.

Symphony's word processor can be used to clean up the downloaded information, if need be, to get rid of extraneous information or realign the data in the spreadsheet format. The word processor within Symphony cannot edit control characters, so there may be some minor problems with downloaded data.

Symphony is the first communications software program to give the user the option of defining the format of the downloaded data to be either stream or rectangular files. Symphony's spreadsheet data structure makes downloading via the data-capture method simple yet comprehensive.

cept to include spreadsheet formulas and format instructions. SDI lets you transfer a complete SuperCalc workspace in ASCII form.

DIF has attained the position of the de facto standard for exchanging data between programs. Most spreadsheet programs and several database-management programs can read DIF files.

COMMUNICATIONS SOFTWARE

Moving data between computers is most often done with communications software. Though it's possible to hook up two IBM PC microcomputers directly through their serial ports and transfer files between them using the COPY command, the process is much easier if you use communications software.

Communications software is a must in order to move data between your microcomputer and a remote computer service. Such software performs, primarily, two services: terminal emulation and file transfer.

The primary objective of a communications program is to turn your IBM PC into a "dumb terminal," one that can communicate with other computers through the serial port and over the telephone via a modem. However, good communications software turns the IBM PC into a "smart terminal," one that can upload and download files and handle a wide range of communications protocols.

Two fundamental issues affect the transfer of files (downloading/uploading) between computers: coordination and error checking. Most communications software can capture the information being sent from a remote computer as it is being displayed on the IBM PC's monitor. The captured data is then stored in a file on disk.

Pressing the Page Down key in PC-Talk III (developed as Freeware by The Headlands Press Inc.), for example, initiates data capture. The user will be asked for a filename, and all subsequent data displayed on the monitor is saved to the specified file. Pressing the Page Down key a second time signals PC-Talk III to stop capturing data and close the active file. Starting and finishing your transfer with the exact information requires coordination between your microcomputer and the remote computer.

Quite often unrelated information is captured in the beginning and at the end of the file. These unwanted characters can be edited out of the file later with your word processor.

The data-capture method of transferring information saves everything being sent between the two computers. If there is an error in the transmission, the garbled characters are indiscriminately saved in the file. When you are transferring text data, this is only a minor problem. However, when you transfer numerical data, a single garbled bit can change the entire meaning of the data file.

Direct file transfer solves the two problems inherent to the data-capture method, coordination and error checking, but the two computers must use the same file-transfer protocol. This protocol establishes the beginning and end of a file and usually includes an error-checking procedure. The XMODEM protocol developed by Ward Christensen is the de facto microcomputer standard for direct file transfer. The XMODEM protocol breaks the file into small blocks of data, calculates a numerical value for each block, which serves as a check value, and sends the check value along with each block to the receiving computer.

The receiving computer then calculates the characteristic of the block it has received and compares its own check value with the one it received along with the block of information. If the two values agree then the block is saved; if there is a difference the block is re-sent.

PC-Talk III adheres to the XMODEM protocol. By appending "=X" to the end of the name of the file to be transferred, you signal PC-Talk to wait until the sending or receiving computer activates the Page Up or Page Down key and then automatically transfers the file. Any errors in the block detected during transmission result in its being re-sent. Direct file transfer can occur between different software programs other than PC-Talk III as long as they support the same protocol.

TRANSFERRING DATA BETWEEN APPLICATIONS PROGRAMS

Most applications programs store their data in binary form and in a format that is convenient for the program. The only way another program can access that data is if it knows the original program's format. Most applications programs, for example, adopt a unique extension to their filenames—WKS for Lotus 1-2-3, CAL for SuperCalc, and VC for VisiCalc worksheet files. In other words, a SuperCalc file is saved differently from a Lotus file. A file called Forecast in Lotus will be saved:

(continued)

ENHANCE WordStar with

P-r-o-p-o-r-t-i-o-n-a-l Spacing on WordStar

You are reading text **printed by WordStar in proportional spacing**, providing a **professional, easy to read, typeset appearance**.

Justified proportional spacing from WordStar's print command, multiple columns on a page, and more. Works on

all versions of WordStar, with Diablo, Xerox, Qume, NEC, and most other daisywheel or thimble printers.

"The best and least expensive method of dramatically improving the appearance of any WordStar text" - LIST

Disk version (CP/M, MS/PC-DOS) automatically modifies WordStar \$75 including manual. Manual only (100 pages - with full details for implementing PS using Install) \$25. No technical skill is needed. Text can be right justified. Printer does not require PS logic. Prices include shipping in U.S. NYS add tax.

Okay! My check is enclosed for \$..... (or charge my VISA/MC acct # exp).

Writing Consultants

Suite 259, 11 Creek Bend Drive - Fairport, NY 14450

1-800-828-6293 (in NYS 1-716-377-0130)

phones open 24 hours - dealers please call or write

FORECASTWKS: in SuperCalc it will be saved: FORECASTCAL. Neither filename is readable by the other program. The solution to this data incompatibility is to produce a standard ASCII format version of the file to be transferred. Most applications programs allow this. Lotus, for example, provides two choices: it uses a utility program to produce a DIF file from the WKS file, or prints the data to disk producing a PRN (print) file in fixed ASCII format. One of the incongruities of Lotus 1-2-3 is that it can read (import) a free-format ASCII file, but it can produce only a fixed-format ASCII file. This is unfortunate since the free-format (CSV) file is one of the most common formats for data transfer between applications programs, both mainframe and microcomputer. SuperCalc's utility, SDI, transforms data to and from CAL and DIF and CSV files.

Ashton-Tate's database-management program dBASE II can both read and write free-format CSV files. A free-format ASCII file can be created from a dBASE file by copying that file using the Delimited With "" option. The dBASE II program uses the name of the data file and appends the extension TXT for the name of the ASCII file, which will be created in a CSV file. Either Lotus 1-2-3 or WordStar, using mail merge, can then read this file. Using the dBASE II Append From . . . Delimited option moves data from a CSV to a dBASE II data file. In version 2.4 on the IBM Personal Computer, the Delimited With "" option produces CSV files with the trailing blanks in any field eliminated. (Trailing blanks were not eliminated in earlier version of dBASE II.)

Moving data between word-processing programs can be

A Sampling of Remote Computer Services

Most remote computer services distribute public information electronically, along with proprietary information that they have gathered or licensed from other sources.

The following is a brief outline of remote vendor services from major financial suppliers with which I am familiar. I have purposely disregarded the traditional home-user services such as CompuServe, The Source, and Dow Jones, in favor of talking about business-oriented database vendors.

DIALOG INFORMATION SERVICES

Dialog Information Services provides on-line access to a wide range of databases containing materials on education, science, business and finance, current affairs, social sciences, law, medicine, the arts, and humanities.

The business and finance databases on Dialog include ABI/Inform and Disclosure II. ABI/Inform abstracts articles from more than 550 publications about business management and administration and offers 200,000 citations. The abstracts can be saved by your microcomputer in simple stream format via the data-capture method.

The Disclosure II database provides abstracts of reports filed with the Securities and Exchange Commission (SEC) by more than 8500 publicly owned companies. This information includes the 10-K and 10-Q financial reports, 8-K reports of unscheduled material events or corporate changes, 20-F financial reports, proxy statements, management discussions, and registration reports for new corporations. These reports are presented in a standard table format for

each company. However, capturing the data as a text file in stream format poses a problem, for in this form it cannot be entered easily into a spreadsheet program. Lotus Development's Symphony has a unique downloading procedure that should enable you to download the Dialog Disclosure II tables directly to a spreadsheet (see "Lotus's Symphony Offers Downloading Options," page 250).

Dialog charges by connect time, and the hourly rate depends on the database you access.

WHARTON ECONOMETRIC FORECASTING

Wharton Econometric Forecasting Associates provides a vast array of economic, financial, and demographic data covering both historical and forecasted periods. Formerly available only to timesharing services, Wharton's information is now accessible to microcomputer users in two forms: downloaded and on data disks for the IBM PC. "Download" is a Wharton program that runs on its mainframe and interacts with the microcomputer to manage the downloading process. It first asks for the series name to be downloaded, then creates a DIF (Data Interchange Format) file for that series or formats a printed report. It coordinates the display of the DIF file on your microcomputer's monitor so that it can be easily captured by the microcomputer and stored to disk. Almost all of the Wharton data can be downloaded. The Wharton Download program will work with any terminal emulation software that can communicate with a TSO (timesharing operation) system.

Wharton charges only for the connect time. There are no data transaction or

stripping charges.

I.P. SHARP

I.P. Sharp Associates is a Canadian-based company that provides a telecommunications network and remote computing services for Sharp APL, the first commercial timesharing system for APL (A Programming Language). Sharp also provides extensive databases containing more than 50 million reports of public data covering economic, financial, demographic, energy, and aviation data in different time periods.

Sharp downloads via Microcomm, a software package written in BASIC (with some modules written in assembly language), which runs on the IBM PC and costs \$50. Data is formatted in DIF files on the mainframe and downloaded to standard PC-DOS files, making the vast majority of Sharp's economic and financial data available to microcomputer users. Sharp charges only for connect time.

Microcomm is menu driven and completely automates the downloading process. You don't need to know APL as the program is a PC-DOS program and interacts with Sharp in standard ASCII format. However, you do have to be familiar with the Sharp system and the method for querying its databases in order to access the desired data.

DATA RESOURCES

Data Resources Inc. (DRI), one of the nation's largest suppliers of on-line economic data, sells its forecasting services by subscription. Forecasts are available about the national economy, state and regional areas, and specific industries and activities as well as many foreign countries. These

forecasts supplement the historical data available through DRI.

DRI has developed a microcomputer product called VisiLink (distributed by VisiCorp) to help the microcomputer owner access the DRI timesharing computer. Information is downloaded in packages called DataKits.

VisiLink DataKits are combinations of data and accompanying analyses focused on specific applications. DataKits are downloaded in ASCII in the VisiCalc worksheet format. The DataKit can be loaded directly into VisiCalc and the resulting worksheet saved as a DIF file transportable to many different applications programs. Furthermore, many applications programs can read VisiCalc worksheets directly.

Downloading data via the VisiCalc format enables DRI to transfer spreadsheet formulas as well as data, something not possible with DIF. In addition, VisiCalc is the only major spreadsheet program that stores its spreadsheet data and relationships in ASCII format.

DRI offers three kinds of DataKits: a data retriever pack, a data forecast pack, and an analysis (application) pack. The data retriever is designed for downloading a series of historical information from the DRI data banks. The user is limited to 24 quarterly reports (6 years) and 10 series in one kit. There is a fixed charge of \$3 per series in a retrieval DataKit. Forecast data is available in predefined DataKits grouped by areas of interest. You can choose one of three forecast scenarios: control (the forecast DRI considers the most likely), a best-case forecast, or worst-case forecast. Forecast DataKits are naturally more expensive than retrieval kits.

Analysis DataKits are for the following applications: product-line forecasting, cost analysis, financial statements, industry detail, etc. Prices of application DataKits vary and depend on the complexity of the forecast. They range from around \$75 to more than \$200.

CHASE ECONOMETRICS

Chase Econometrics, part of Chase Econometrics/Interactive Data Corp., a subsidiary of the Chase Manhattan Bank, also provides microcomputers access to its data. The downloading system is called CEDAF for Chase Econometrics Data Access Facility. CEDAF is part of an economics workstation sold by Chase Econometrics/ IDC, which includes an IBM XT, Lotus 1-2-3, an econometric analysis

package, and other utilities. CEDAF is designed to download data for the applications programs on the workstation. It is not a stand-alone program.

The data banks can contain, literally, millions of time-period series, each one with a unique mnemonic. CEDAF contains a query language that allows the user to give an English-language description of the data requested to which the system responds with several series that satisfy the given descriptors. By adding more descriptors, the number of series drops until only a handful are left.

To use CEDAF you must install the workstation, be a subscriber to Chase Econometrics, and pay for the connect time and a data-transaction charge, which depends on the value of the data being downloaded.

Interactive Data Corporation currently has two microcomputer products: PC Screen and DataSheet. Both are dedicated applications packages that link the microcomputer into the IDC databases. These packages are designed to take full advantage of the microcomputers' full screen interface.

PC Screen works with a mainframe's Compustat financial data and, as its name implies, is a screening program used for investment analysis—especially mergers and acquisitions. PC Screen lets you set up screen criteria so that you can identify, quickly and easily, the companies within the Compustat file that meet your criteria.

DataSheet is designed for data sharing within large corporations.

ADP

ADP (Automatic Data Processing) provides on-line access to extensive databases for the financial analyst and the business economist: Compustat, Disclosure II, stocks, bonds, futures, foreign exchange, and the Townsend-Greenspan historical and forecast economic databases. ADP was one of the first value-added resellers of Lotus 1-2-3.

Downloading data on ADP with its program Datapath is a three-step process: first, you define the data to be downloaded by creating a range name in a Lotus 1-2-3 worksheet that starts with the underline character; for instance, GNP would be a range called GNP. Data ranges can be anywhere in the worksheet and can be referenced by formulas in other cells. In essence, one constructs an entire Lotus template.

Second, Datapath's terminal-emulation

mode automatically connects with the ADP network. The program asks for the name of the worksheet that defines the data to be downloaded.

Third, the data automatically is downloaded into the predefined Lotus worksheet. If the downloaded data is referred to by formulas in the worksheet, the entire worksheet will be calculated automatically. Thus, if investors are interested in a ratio analysis of a company's performance, they can build a Lotus 1-2-3 template and request from Disclosure II the balance-sheet for that company. Datapath will download the data to the 1-2-3 worksheet, and 1-2-3 will calculate the ratio formulas automatically.

ADP also offers an on-line Applications Library of predefined Lotus templates, similar to the DRI VisiLink product. Templates from the Applications Library cost from \$20 to \$100. A balance-sheet template costs \$20, while a ratio-analysis template costs on the order of \$40.

ADP charges a minimum of \$100 per month per corporate account (not per user within the account), a subscription fee for each database accessed, and a data-transaction charge that varies depending on the data being accessed.

Remote Computer Services

ADP Network Services
175 Jackson Plaza
Ann Arbor, MI 48106
(313) 769-6800

Chase Econometrics/Interactive Data Corp.
486 Totten Pond Rd.
Waltham, MA 02154
(617) 890-1234

Data Resources Inc.
24 Hartwell Ave.
Lexington, MA 02173
(617) 861-0165

Dialog Information Services
3460 Hillview Ave.
Palo Alto, CA 94304
(415) 858-3810

I.P. Sharp Associates
Suite 1900, Exchange Tower
2 First Canadian Place
Toronto, Ontario
Canada M5X 1E3
(416) 364-5361

Wharton Econometric Forecasting
Associates
3624 Science Center
Philadelphia, PA 19104
(215) 386-9000

more difficult than you'd expect from programs designed to manipulate just words. Many word-processing programs do not store text in ASCII format. WordStar saves the document as a single stream file with a new line indicated by a single linefeed character, whereas, in ASCII format, a line is indicated by a pair of characters: the carriage return and linefeed combination. This creates a problem for moving ASCII files to and from WordStar. WordStar provides a nondocument editing option to create files in standard ASCII format. However, once you are in the nondocument mode, all of your editing must be done in this mode to maintain the file's ASCII format. Editing in the nondocument mode is neither as simple nor as convenient as in a WordStar document file.

Conversion programs are available in the public domain that convert WordStar files to standard ASCII and vice versa. These programs have been published in most of the magazines devoted to the IBM PC and are available from most user groups or from a number of bulletin boards.

MultiMate, a popular dedicated word-processing program, stores text in a special form that is more akin to a database manager than a word-processing program. MultiMate does provide a utility that will convert its documents to standard ASCII files and from ASCII to MultiMate files. However, this utility will not work with mail merge information—names and addresses to be merged with MultiMate form letters.

MOVING DATA BETWEEN MICROCOMPUTERS

The new integrated programs often diminish the need to transfer data between programs by simply offering more functions in a single program. However, transfer problems still exist between different microcomputers. Moving data between microcomputers that read the same disk format is a simple matter of physically moving the floppy disk from one computer to another. The IBM PC has established a de facto standard because of the widespread use of MS-DOS on many different microcomputers. (MS-DOS is Microsoft's disk operating system on which it based PC-DOS.) In addition, programs like Zeno Copy from Vertex Systems can read and write many different disk formats on the IBM PC.

Data files that are being transferred between computers to be used in the same applications program (for example, a WordStar document on a CP/M computer for editing on an IBM PC running PC-DOS, a mailing list in dBASE II, etc.) are best transferred as binary files using a transfer protocol such as XMODEM. Occasionally, you will run into a problem between the versions of the applications programs on the two systems. For instance, when transferring a binary SuperCalc workspace from an Osborne CP/M system running an early version of SuperCalc to an IBM PC with a later version, it is best to use the SDI format to transfer the entire worksheet as an ASCII file. If the SuperCalc version number differs, then you must use the appropriate (SDI) utility to convert the workspace to an ASCII file and transfer the file, and then use the same utility program on the second computer to reconvert the ASCII file into the application format.

With the increasing popularity of lap computers, moving data between computers will become more and more common. Most lap computers come with a word processor and communications software and often include a built-in modem. In such an environment, moving a word-processed document from the lap to the base computer is a straightforward matter. But, using it with the base station word-processing program may not be as easy as you would expect. The lap computer operates with ASCII files and will transfer standard ASCII files to the base station. The problem may be that the base station's word processor does not format ASCII files (WordStar, for example). In all likelihood the ASCII file will have to be converted to run with the base station's word-processing program.

Transferring documents from your lap computer to the desktop computer is a two-step process: first transfer the lap computer's ASCII file to the base computer, then transform the file to a WordStar or other word-processor format using a utility program written for that purpose. If your word processor stores files in standard ASCII format, this simplifies the transfer of document files between your lap and desktop computers.

MOVING DATA BETWEEN MAINFRAME AND MICROCOMPUTER

A wide range of timesharing databases are available to microcomputer users today. You can link your microcomputer to a timesharing vendor in three different ways for different purposes: you can capture information being displayed on your microcomputer's monitor; using vendor-provided downloading software, you can interlock with the vendor's timeshar-

SAVE!!!
 WHOLE STORE
 ON SALE THIS MONTH
 5% OFF

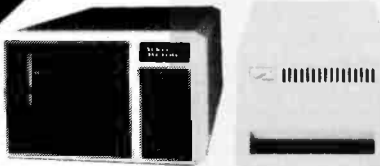

Hard Disk Drive With Winchester Technology
 Hard Disk Drive With Whitney Technology
 Hard Disk Drive With R.L.L. (Run Length Coding) Technology
I WILL BEAT ANY PRICE IN U.S.A.

Outstanding Quality Products, Latest Technology
 Satisfaction Guaranteed, 7 Days Trial
 The Best Hard Disk Drive Subsystems in the World
 Complete and Ready to Run, Full Year Warranty

10 MB 5 1/4"	\$ 1,195.00	16 MB 5 1/4"	\$ 1,995.00
25 MB 5 1/4"	\$ 2,295.00	30 MB 5 1/4"	\$ 2,395.00
40 MB 5 1/4"	\$ 3,495.00	65 MB 5 1/4"	\$ 3,995.00
92 MB 5 1/4"	\$ 4,995.00	184 MB 5 1/4"	\$ 8,995.00
368 MB 5 1/4"			\$ 17,995.00
MX-4 Multiple User Kits (Network Station)			
Printer Server Automatic Despools			
Letter Quality Printer 55 cps			
Dot Matrix Printer 120 cps			
Electronic Cash Register			
*I.B.M. PC 2DD/256K/Video Board with Printer Port/Monitor			
*I.B.M. XT 128K/Video Board with Printer Port/Monitor			
*Televideo 1605			
Multiple User Kits for Commodore (Disk Drive 1541)			
Memory Chip 4164			
Teac Disk Drives FD-55B, 360K			
IBM PC			
Memory Chip for the 4164-150			

The above hard disk drives are compatible with: Access Matrix (ACTRIX)/IBM & Compatibles/Apple II, II+, IIe, III, III+, IIc & Apple Compatibles/Altos/Atari 800/
 Texas Instruments/Osborne/DEC/Kaypro/Epson QX-10/S-100/NEC PC 8000/
 North Star/TRS-80 I, II, III/Zenith Z89, 90, 100, 150/Xerox 820/Toshiba T300/
 Televideo 802 & 802H/Sanyo 550 & 555/Commodore 64 & VIC-20/etc.

These drives can be used as networking stations up to 64 users on one single drive and up to seven operating systems on the same drive.
 Removable hard disk (removable cartridge) available. Tape back up available.
 Software available for IBM, Apple, Commodore, Televideo, etc.
 Prices include software, cables, interface (host adapter), and books.
Free shipping and delivery.

MANDINGO COMPUTERS & CAMERAS
 900 CASCADE DRIVE • FORT WASHINGTON, MARYLAND 20744
 (301)292-5632 (301)292-6732

MOVING DATA

Occasionally, a captured file may have lines that end with only a linefeed character.

ing system, eliminating incompatibility problems; and you can use an applications program that the vendor may provide to link the microcomputer to the mainframe.

The microcomputer's communications software captures data from a remote computer, allowing you to save to disk what is being transmitted to the microcomputer. The transmitted file is in ASCII stream format and, in many cases, will have to be edited with a word processor to remove extraneous information. It may also need reformatting to make it acceptable to the targeted microcomputer applications program. Almost any word processor that can edit and store ASCII files will suffice. However, you may have to remove or add control characters, and many word processors are unable to edit control characters.

Occasionally, a captured file may have lines that end with only a linefeed character, not the carriage return/linefeed combination required for standard ASCII files. The remedy for this problem is to use a word processor to locate all occurrences of the lone linefeed character and replace them with the carriage return/linefeed combination. This cannot be done in WordStar but can be done in Edlin or PCWrite.

Some vendors offer dedicated downloading of data via a special communications software program designed to work only with their timesharing/database systems and sold as a microcomputer software product. With one of these packages running on the PC and connected to the respective vendor's remote computer service, nearly all of the problems connected with downloading discussed above are eliminated. The disadvantage of these systems is that they work only with the vendor that provides them. One of their major benefits is that they permit you to upload data from your microcomputer to the remote computer service. The dedicated software program contains the necessary information for the PC to link up with a special program on the mainframe to run the downloading procedure in reverse.

All of the data timesharing vendors have built their businesses by supplying value-added software that manipulates your data, increasing its usefulness to your business. Your microcomputer uploads data to the remote computer service, which runs its applications programs on your information and returns the results to your terminal. The advantage is that the communications process is transparent, and incompatible files don't exist.

Users do lose control over the remote computer and are permitted to download only information or results for which they've contracted. Usually, when contracting for such services, you are required to buy terminal equipment compatible with the remote service's communication protocol—an IBM or an Apple, for example. Because of IBM's increasing market share in the business segment of the economy, more and more remote services are using it as a standard. ■

New Release
4.1

We've continually improved Microstat since it was introduced in 1978, and the latest release includes many new features you've wanted.

Interactive and Batch Processing	Data sets that can exceed memory
Expanded Data Management	Multiple Regression (including Stepwise)
Subsystem with New Data Transforms	Scatterplots (including best fit regression)
Reading data files created by other programs	Correlation Analysis
3 types of Analysis of Variance	12 Nonparametric tests
Time Series	8 Probability Distributions
Crosstabs and Chi-Square	Descriptive Statistics
Factorials, Permutations, and Combinations	Easy Installation
Hypothesis Tests	

Microstat's algorithms have been designed to prevent numeric overflow errors and yield unsurpassed accuracy. Microstat's price is \$375.00 including the user's manual and is available for the Z80, 8086, 8088 CPUs and CP/M86, CP/M86, MS-DOS, and PC-DOS. To order, call or write.



6413 N. College Ave.
Indianapolis, IN 46220
(317) 255-6476



Trademarks: Microstat (Ecosoft), CP/M (Digital Research), MS-DOS (Microsoft), PC-DOS (IBM), Z80 (Zilog), 8086, 8088 (Intel).

the proven statistical analysis package

StatPacTM

designed specifically for micros
modeled after SPSS*

StatPac is convenient. Comprehensive. Inexpensive. Tested in the field for more than four years, StatPac has been updated, debugged and enhanced. So it's well established and easy to use. It even has built-in word processing for better file handling and editing.

StatPac is the answer for social scientists, market analysts, medical researchers... anyone in the survey and research community. It can handle up to 5,000 cases and manipulate 255 variables on a standard IBM PC.

**Call 800-328-4907
or write for a free brochure.**

*SPSS is a trademark of SPSS, Inc.

WALONICK ASSOCIATES

5624 Grand Avenue South
Minneapolis, MN 55419
(612) 866-9022
1-800-328-4907

BY
ROBERT A. STILLMAN JR.

TESTING FOR IBM PC COMPATIBILITY

Determining how compatible a computer is compared to the IBM PC has now been simplified with two new programs

The IBM PCs and IBM XTs have set an industry standard that has generated numerous IBM PC clones. The question always asked about a clone is, How compatible is it with the IBM PC? The answer, in turn, determines what hardware and software will be available for the clone. We at Award Software have developed a series of tests aimed at confirming a computer's compatibility with the IBM PC.

Figure 1 shows an architectural model of the IBM PC and IBM XT. It consists of four levels: hardware, low-level support routines (ROM BIOS), PC-DOS I/O (input/output) device drivers (IBM-BIO.COM), and the PC-DOS (IBM-DOS.COM) operating system. If the hardware were completely compatible, then IBM ROMs (read-only memory) and DOS (disk operating system) could be used on the computer. However,

copyright laws prohibit this approach, and a ROM BIOS (basic input/output system) must be implemented by the vendor (and must be sufficiently distinct from IBM's as some vendors have found out) to provide interfaces identical to the IBM ROM BIOS. Last, the MS-DOS I/O.SYS module must be implemented (and again must be distinct enough to avoid copyright infringement) to provide a PC-DOS interface.

The three areas of compatibility testing addressed in this article are hardware, ROM BIOS, and PC-DOS interfaces. The hardware testing covers the major LSI (large-scale integration) chips (Intel 8088, 8259, 8255, NEC 765, etc.), I/O ports, and how the chips are inter-

(continued)

Robert A. Stillman Jr. is an executive vice-president of Award Software Inc. (236 N. Santa Cruz Ave., Los Gatos, CA 95030).

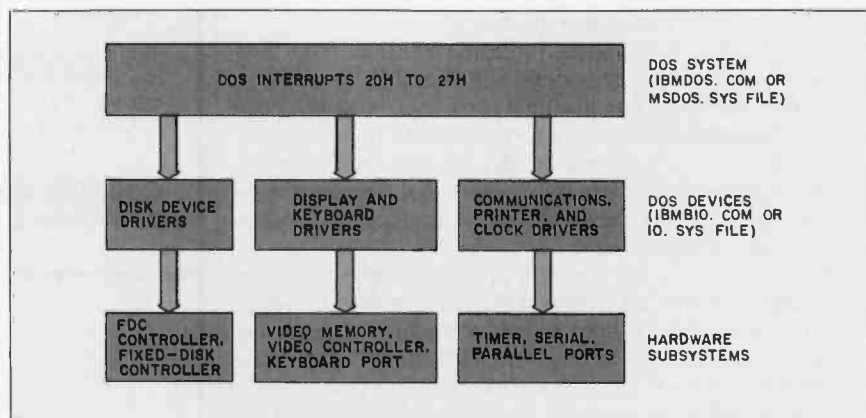

Figure 1: An architectural model of the IBM PC and XT.

SINCE 1981, OUR CLIENTS HAVE GOTTEN EXACTLY WHAT THEY DESERVE.

COMPETITIVE PRICES, PROFESSIONAL SUPPORT AND EXPERT SERVICE.

When it comes to giving you exactly what you deserve, no one comes through like Oryx Systems. That's because since we opened for business in 1981, we've been totally committed to making a difference in the way you purchase computers, software, and accessories.

We are pleased to report that our staff has grown ten-fold since 1981. And last year we found it necessary to move to a larger store in order to serve your needs more efficiently. We continue to be encouraged by our steadily increasing client list, which now numbers over 15,000 in 50 states and 35 countries. All because we've been able to give you exactly what you deserve.



Our first store, 1981.

You deserve competitive prices. Not only this month on a few obscure items, but every month, on the most popular, most requested products available. In fact, our product list of over 6,000 items is one of the largest in the computer mail order business. Which means that you can get the jump on new products as soon as the manufacturer introduces them.

You deserve professional support. Sure, we're in the business of *selling* computers. But we're also in the business of *supporting* those orders with knowledgeable people. People that possess an unfailing attention to detail and customer satisfaction.

You deserve expert service. Getting what you deserve means working with professionals. It means trusting your order to a company that's reliable ... with routine orders as well as with the tough ones. And the confidence that comes with knowing that what we promise, we will deliver.

A number of companies have already found that they can get what they want and what they deserve from Oryx Systems. And that they can rely on us for providing competitive prices, professional support and expert service. From a simple box of diskettes, to a complete multi-user system, the following companies have found that they get what they deserve from Oryx Systems.



1-800-826-1589
ORYX SYSTEMS, INC.
 CRAFTSMEN OF THE NEW TECHNOLOGY



101 First Street
 Wausau, Wisconsin 54401

Technical Support
 715-848-1374

Circle 131 on inquiry card.

Our new store, 1984.

Quadram Quadcolor I monitor \$199	Key Tronic 5151 Keyboard \$219
PGS Monitors HX12 RGB Color \$499	Central Point Copy II PC \$ 34
Hayes Smartmodem 1200 \$499	Ashton Tate d-Base II \$319
Tecmar Graphics Master \$499	Cdex All Training Progs, ea.... \$ 52
Hercules Graphics Board \$359	CompuView Vedit \$130
Tandon TM 100-2 Disk Drive \$209	Enertronics Energraphics \$265
Software Publishing Corp. PFS: Report, Access, ea \$ 79	Living Videotext Think Tank \$139
PFS: File, Graph, Write / ea \$ 89	AST Research Six Pak Plus 64K (S/P, Clk. exp to 384K) \$269
	Megapak 256K Exp. 269



connected. The internal bus structure and timings are not addressed. The ROM BIOS is the set of primitive I/O software routines used to organize the hardware into a somewhat manageable form. The IBM PC and IBM XT ROM BIOS is a single-task/single-user I/O scheme. Even though interrupts are used, only one process is running at a time. (One exception does occur with the timer interrupt.) The PC-DOS is an IBM version of Microsoft's MS-DOS. This is the major operating system used on the IBM PC and XT.

Microcomputers found to have an exceptional degree of hardware and software compatibility with the IBM PC are Columbia, Compaq, Corona, Eagle, Mitsubishi, Stearns, and Seequa.

GENERAL TEST ASPECTS

PC-TEST includes 50 programs written in C to investigate the hardware and ROM BIOS interfaces. Each individual test is designed to look at a particular software interface and/or hardware subsystem. Listing 1 is an example listing, which checks the BIOS.

DOS-TEST has 40 C programs used to verify the PC-DOS implementation. It exercises all MS-DOS user-documented Interrupts and Function calls. It verifies IBM PC keyboard and video interfaces. It also verifies that all the IBM PC supported disk organizations are correct.

The motivation for developing PC-TEST and DOS-TEST was to validate implementations of IBM PC ROM BIOS and DOS BIOS developed by Award Software for IBM PC clones. Also one of our utilities, Crossdata, which transfers CP/M-80, CP/M-86, and Concurrent CP/M-86 files to PC-DOS files and back again, makes extensive use of the ROM BIOS interfaces. So to aid our porting of Crossdata and validating of IBM PC compatibility, PC-TEST and DOS-TEST were written. PC-TEST and DOS-TEST are currently available to interested OEMs (original equipment manufacturers).

PC-TEST and DOS-TEST were written to be run against an IBM PC or IBM XT. Some tests check whether the system conforms or not and draw a conclusion. Some tests require visual confirmation by the tester. All tests identify themselves and explain what the test is about and areas of testing. All tests report register clobbering when detected and

Listing 1: Example test case for IBM PC compatibility included in PC-TEST.

```

.....
-TEST ID- BIOS.DISPLAYIO.16 - BL__IO__16
-PURPOSE- Test characters and attributes for black/white display
-VERSION- A
-TEST PROCEDURE- Program writes attributes for all characters. Tester verifies visually for
each character. Shown is each character for all b/w attributes and modes and the ordinal value
of the character for cross reference. Set 40 or 80 columns via mode command for test of 25
by 40 and 25 by 80 screen sizes.
.....

#include "srvrrvc"

unsigned char curpage = 0;
int poscurs(y,x)
  unsigned char x,y;
  {
    srv.ah = 2; srv.dh = y; srv.dl = x; stv.bh = curpage;
    sint(0x10,0x7ff);
  }

int clrexit()
  {
    curpage = 0;
    srv.ah = 6; srv.al = 1; srv.bh = 7; srv.ch = 0; srv.cl = 0;
    srv.dh = 24; srv.dl = 79; sysint(0x10,&srv.&rrv);
    poscurs(24,0);
  }

main ()
  {
    unsigned char cont,c;
    unsigned int i,j,k;
    printf("TEST BIOSLOW.INT10.16 - Test of char/attribute video i/o
interrupt n");
    timestamp();
    printf("\nHit key to continue ");
    if ((tbdos(0x8) & 0xff) == 'c') cont = 1;
    else cont = 0;
    getkey();
    srv.ah = 6; srv.al = 0; srv.bh = 7; srv.ch = 0; srv.cl = 0;
    srv.dh = 24; srv.dl = 79; sysint(0x10,&srv.&rrv);
    poscurs(0,0);

    printf("Hit key to continue ");
    poscurs(2,0);
    printf("The character is shown with \n");
    printf("Intensity off/ blink off. then \n");
    printf("Intensity on/ blink off. then \n");
    printf("Intensity off/ blink on. then \n");
    printf("Intensity on/ blink on. ");
    poscurs(9,0);
    printf("BLACK CHAR ON BLACK \n");
    printf("UNDERLINE \n");
    printf("WHITE CHAR ON BLACK \n");
    printf("BLACK CHAR ON WHITE \n");
    printf("WHITE CHAR ON WHITE \n");

    for (i=0;i<256;i++) {
      for (j=0; j < 5; j++) {
        switch (j) {
          case 0: c = 0; break;
          case 1: c = 1; break;
          case 2: c = 7; break;
          case 3: c = 0x70; break;
          case 4: c = 0x77; break;
        }
      }
    }
  }

```

```

};
for (k=0; k<4; k++) {
  switch (k) {
    case 0: srv.bl = c; break;
    case 1: srv.bl = c | 8; break;
    case 2: srv.bl = c | 0x80; break;
    case 3: srv.bl = c | 0x88; break;
  }
  poscurs(9 + j, 20 + k * 2);
  srv.bh = 0; srv.cx = 1; srv.al = i; srv.ah = 9;
  sint(0x10,0x7ff);
};
};
srv.ah = 11; srv.bh = 0; srv.bl = 0; sysint(0x10,&srv,&errv);
poscurs(15,0); printf("VAL %xH ",i);
poscurs(16,0); printf("VAL %d ",i);
if (cont) {
  if (bdos(0xb) & 0xff) break;
}
else if ((bdos(0x8) & 0xff) != 0) break;
};
clrexit();
}

```

report error values when results differ from those generated by an IBM PC. These tests are designed to be run by a systems programmer or technician who understands the internal structure of the IBM PC. The goal of the tests was to aid in determining where any incompatibility existed, not just that an incompatibility existed.

HARDWARE COMPATIBILITY TESTING

IBM PC and IBM XT hardware compatibility testing consists of verifying that the LSI chips and I/O addresses given in table 1 are the same. Also hardware compatibility requires that the monochrome and graphics memories exist at the proper addresses and that

the character and attribute (or pixel) memories have identical organization. PC-TEST checks hardware compatibility by looking for correct operations from the integrated chips that identify that the right chip is present at the proper I/O address. Display memory use is tested by putting patterns directly into the video memory and having the tester verify the pattern.

To run all IBM PC versions of interrupt-driven operating systems, such as QNX, Concurrent CP/M-86, etc., the above tests must pass. Otherwise you must obtain special versions of those operating systems. (Many times they do not exist.)

You can check I/O bus and timing compatibility by plugging in commercially available boards and verifying

their operation. Another method would be to take timing pictures using logic analyzers and verify them against an IBM PC or IBM XT.

ROM BIOS COMPATIBILITY TESTING

The ROM BIOS has two types of interface. The most commonly used and recommended one is via software interrupts. The other type is direct addressing of RAM (random-access read/write memory) used by the ROM BIOS (not recommended).

Using just software interrupts permits a wider range of computers upon which a particular software package will run. More computers are compatible in this area than the hardware area. Also, a number of computers use a different I/O and chip set to implement the system.

Table 2 lists the software interrupts provided by the IBM PC ROM BIOS. These software interrupts are passed parameters in registers. Some of the software interrupts use other interrupt vectors to obtain other parameters.

The major ROM BIOS functions used by software packages are the Video, Disk, Printer, Communications, Keyboard, Timer, and Equipment interrupts. These interfaces are described in the IBM Personal Computer and XT *Technical Reference Manuals'* ROM BIOS listings, Appendix A.

The Video interrupt (10 hexadecimal) provides 15 functions that allow for mode of screen display, cursor addressing, lightpen feedback, scrolling, teletype output, character and attribute read/write, graphics read/write, and

(continued)

GRAPHS WITHOUT GRAPHICS?

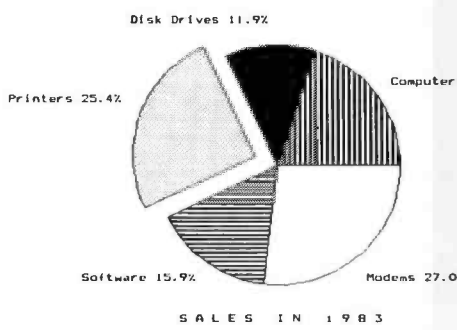

No need for color monitor or graphics board. Make graphs on dot matrix printers.

Easy to Use on PC's and Compatibles. Excellent Manual. PC-DOS, MS-DOS, or CP/M.

DataPlotter™

Line Graphs & Scatterplots . . . \$69
Bar Graphs & Pie Charts . . . \$69
Both for \$99



(Prices include manual)
Add \$3 shipping,
\$6 outside US and Canada.

Specify type of Printer:
(201) 226-7552 Visa, M/C

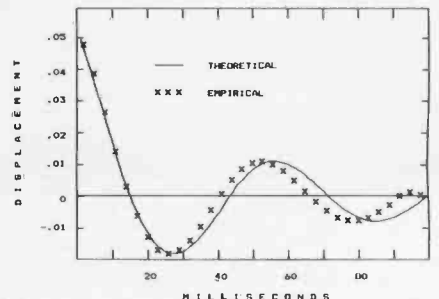

palette and color selection. PC-TEST verifies all these uses in a series of 17 tests. Attribute values have been a particular problem on some implementations. However, all of the manufacturers of microcomputers we have examined have cleared up these problems.

The Disk interrupt (13 hexadecimal) provides five functions for floppy disks and 14 functions for fixed disks. Fixed-disk functions 9 through 14 are used by IBM for manufacturing and diagnostic testing and are not generally incorporated in software packages. Both the floppy and fixed disks use parameter tables at interrupt vector 1E hexadecimal and 41 hexadecimal, respectively. These are pointers to tables in ROM or RAM that describe motor timings, sectors per track, tracks per disk, and so on.

PC-TEST extensively tests these parameters because many software packages, like our Crossdata program, alter these parameters to read foreign disks. Also, these parameters are altered to implement many of the copy-protection schemes used to protect software from duplication on the IBM PC. This is the major area of incompatibility found on computers because a number of vendors have implemented higher-storage floppy-disk systems. These systems, in turn, exhibit internal timings and responses different from those of the IBM PC, and the copy-protection subsequently fails. Another major area of incompatibility is in error reporting. Some copy-protection schemes rely on certain error codes being reported by the IBM PC, and some systems do not

Table 1: Major hardware components of the IBM PC.

Identification	I/O addresses	Use
Intel 8088, 8086	—	Processor
NEC 765	3F4H, 3F5H	Floppy-disk controller
74LS Latch	3F2H	Floppy-disk secondary control
Intel 8255	60H, 61H, 62H, 63H	I/O ports for speaker, keyboard, equipment configuration, RAM parity enable
Intel 8253	40H - 43H	Real-time clock, speaker timer, DMA (direct memory access) refresh
Intel 8237	0 - 0FH	DMA controller
74LS Latches	80H - 83H	DMA page registers
Intel 8259	20H, 21H	Interrupt controller
74LS Latch	0A0 - 0AFH	NMI control
Fixed Disk	320H - 32FH	Fixed disk controller
Intel 8255	378H - 37AH, 3BCH - 3BEH, 278H - 27AH	Printer controllers
National 8250	2F8H - 2FEH, 3F8H - 3FEH	Serial communications chip
Motorola 6845 Latches	3D0H - 3DFH	Color/ graphics controller
Motorola 6845 Latches	3B0H - 3BFH	Monochrome display controller

initially report the error codes the same way as the PC.

The Printer interrupt (17 hexadecimal) provides three functions for as many as three parallel ports. PC-TEST verifies these functions for the specified logical parallel port and checks for compatibility in error-code reporting.

The communications interrupt (14 hexadecimal) provides four functions for as many as two serial communications ports. PC-TEST verifies these functions for the specified logical serial ports and checks for compatibility in error code reporting.

The major area of divergence for

microcomputers is in the keyboard-handling interrupt (16 hexadecimal). PC-TEST does an exhaustive keystroke test, with input from the tester, to ensure all shift states and keycode combinations occur. The test looks at the actual internal shift states as well as keycodes returned. Most of the computers listed earlier in the article as compatible pass these tests. Some initially failed to report proper internal shift states, but the failure has since been corrected. All reported the proper keycodes that are used by the vast majority of the software packages.

The Equipment interrupts (11 hexa-

THE \$2395 DEVELOPMENT SYSTEM

Turns any personal computer into a complete micro-computer DEVELOPMENT SYSTEM. Our integrated control/display program runs under PC/MS-DOS, CP/M, or TRS-DOS, and controls the UDL via an RS-232 port.

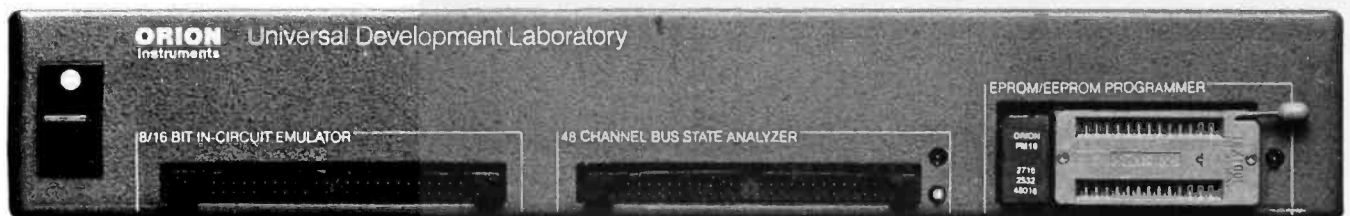

Up to 128K bytes of ROM EMULATION (8K standard) allows you to make program patches instantly. Since the target ROM socket connects data and address lines to both the analyzer and the emulator, no expensive adaptors or personality modules are needed.

The powerful BUS STATE ANALYZER features four-step sequential triggering, selective trace, and pass and delay counters. \$99 symbolic trace disassemblers are available for Z-80, 8048, 6500, 6800, 8031, 8085, 3870, Z-8, 1802, 8088, & 8086.

The PROM PROGRAMMER also doubles as a STIMULUS GENERATOR. For a brochure and list of cross assemblers call or write:
172 Olla Ave., Woodside, CA 94062
(415) 851-1172

ORION
Instruments

TESTING COMPATIBILITY

Table 2: ROM BIOS interrupt use in the IBM PC.

Interrupt	Use
0	Divide by zero from 8088/8086
1	Single step (used by DEBUG)
2	Nonmaskable (parity error)
3	Breakpoint (used by debugger)
4	Overflow
5	Print screen
6-7	Reserved
8-0FH	Hardware interrupts from 8259
10H	Video interrupt—15 functions available
11H	Equipment map
12H	Memory size
13H	Disk interrupt—6 floppy- and 14 fixed-disk functions
14H	Communications interrupt—4 functions
15H	Cassette
16H	Keyboard interrupt—3 functions
17H	Printer interrupt—3 functions
18H	ROM basic entry
19H	Bootstrap loader
1AH	Time-of-day interrupt—2 functions
1BH	Keyboard break interrupt
1CH	Timer tick interrupt
1DH	Video initialization parameter list pointer
1EH	Disk parameter list pointer
1FH	Graphics character pattern pointer
20H-3FH	DOS interrupts
40H	Disk interrupt reroute for fixed-disk systems
41H	Fixed-disk parameter list pointer
42H-FFH	Reserved or used by DOS, BASIC or user-supplied interrupts

decimal and 12 hexadecimal) tell the type of equipment and amount of memory available. PC-TEST reports the equipment list and the memory used. No problems were seen on the computers listed earlier.

The Timer interrupts (1A hexadecimal and 1C hexadecimal) yield a free running clock and a timer tick. PC-TEST programs verify the accuracy of the clock and the implementation of the timer.

Other interrupt vectors used are the 8259 interrupt chip vectors, trap and single-step interrupts, divide-by-zero interrupts, and print-screen interrupts. PC-TEST checks all of the above except the trap and single-step interrupts. They are most easily verified by using DEBUG. Again the microcomputers listed earlier provided no problems. However, the print-screen interrupt interferes with the Intel 188 processor chips, and systems that use the more advanced Intel processors may be incompatible.

PC-DOS COMPATIBILITY TESTING

Most software packages that do not

directly address the screen or use the ANSI (American National Standards Institute) escape sequences to address the screen do use the standard MS-DOS function calls. If the package does not use function keys, then it probably runs on any MS-DOS machine. However, most packages for the PC require screen addressing and function key codes. They use the Video software interrupt as the only lower-level machine interface (with perhaps an Equipment check) and use only standard MS-DOS calls. If the computer supports the Video interface, the screen character set, and the function key codes, then a large set of software packages will run on the machine.

One potential area of incompatibility is the inability to read and write all supported IBM PC floppy-disk layouts. These layouts are 48-tpi (tracks per inch), single- and double-sided, eight- and nine-sectored disks. This inability may be caused by having a 96-tpi drive and not being able to write on a 48-tpi disk or by not reading eight-sectored

(continued)

Personal Computer SMARTWARE™

Spreadlink™

IBM PC/XT, PCjr

\$195

Mainframe Data to Your PC . . .

Instead of entering data by hand from external sources into your spreadsheets or databases, Spreadlink reformats your data and allows you to load your information directly into 1-2-3, VisiCalc, MultiPlan, dBase II, and many other packages for direct use. Your files can be from mainframes, commercial databases, mini-computers, other personal computer, or any application packages that create ASCII standard text files (such as word processors).

You get to preview your data, edit rows and columns with Spreadlink, and then Spreadlink automatically converts it into the right format for your application. Since Spreadlink lets you save your edit format as a command file, you can automate your reports for the next time. Spreadlink allows any mix of labels and values without any special formatting or separators. . . it also adjusts to column variations caused by stacking several dissimilar reports in one file. We use Spreadlink to move data from our Mini to our controller's PC for monthly reports. . . and it only took our controller 15 minutes to learn and start using.

FEATURES

- Converts standard ASCII text files to native file for Lotus 1-2-3, VisiCalc, Multiplan, dBase II, and DIF.
- Screen preview of your data allows you to edit out unwanted rows or columns or data. Convert only the data you need, or just take all of it automatically.
- File size is only limited by the disk space available.
- No pre-editing or programming required. Reports do not need to be in columns and rows.
- Requires no installation or adaptation on the host computer.
- Requires 64K memory, one disk drive, any version of MS or PC DOS.

APPLICATIONS

Download the last year's financials from your IBM 3033. Using Spreadlink, load the data to your 1-2-3 model for analysis to determine next year's plan. Take expense figures out of a memo in a word processor text file and use it as input to your VisiCalc expense tracking model. All completely automated, no technical knowledge required.

© 1983 Smartware

SMARTWARE, INC.

557 Howard Street
San Francisco, California 94105

DIAL: 800-SMARTWARE
Visa and MC accepted
(In California: 974-1500)

Send me a catalog!

BY1

NAME _____

COMPANY _____

ADDRESS _____

CITY _____ STATE _____ ZIP _____

Fall 1984 • BYTE Guide to the IBM PC • 261

SAVE BIG ON COMPUTER PRODUCTS

MODEMS

Smartmodem 300	200
Smartmodem 1200	489
Smartmodem 1200B	425
Micromodem II E	240
Smartcom II Software (for IBM PC)	90
Cables to Hayes Modems	CALL
NOVATION	
SmartCat Plus (NEW)	CALL
J. Cat 300B direct	99
103 SmartCat 300B Smart	159
103/212 Smart 300/1200 B	379
AppleCat II 300 baud for Apple	200
212 AppleCat 300/1200B for Apple	390
Access 1-2-3 1200B for IBM	379

MONITORS

SUPER SPECIAL!! COMREX	
12" Green Hl. Res.	75
AMDEK	
V300G 12" green	122
V300A 12" amber	145
V310A 12" amber (for IBM)	160
Color I+ 13" composite	280
Color II+ 13" RGB	425
Color IV 13" RGB analog	740
Monitor Cables	
CB 5690 Apple II to Monitor	7
CB 5691 IBM to RGB	19
CB 5692 for TI-99/4A or Commodore	15

QUADRAM

MICROFAZER	
QRMP-8 Par/Par	135
QRMSB-8 Ser/Par	145
QRMSB-8 Ser/Ser	145
QRMPB-8 Par/Par	145
QUADBOARD (for IBM PC)	
QR 5310 (no mem. installed)	210
QR 5384 64K (mem. installed)	270
QR 4084 64K (mem. installed)	270
QR 8201 Quadcolor-1	200
QR 8202 Quadcolor-2 (upgrade kit)	200
QUADLINK	
QR 3000 for IBM	475
QR 3010 for Compaq	475
QR 3020 for Columbia	475

AST

Six Pak Plus	270
Mega Plus II	270
1/0 Plus II	172

SAVE 31%-43%
OFF MFR. SUGG. RETAIL PRICES ON

PRINTERS

EPSON • OKIDATA • DIABLO
SCM • DELTA • GEMINI • TTX
RADIX • COMPUTE-MATE
MANNESMANN TALLY

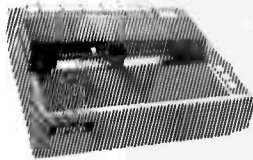

CALL FOR PRICES



DISKETTES

10 - 5 1/4" Floppy Diskettes			
SS/SD	SS/DD	DS/SD	DD/DD
Webash \$13.00	\$16.00	\$17.50	
Maxell NA	29.00	26.00	
Dyanex NA	23.00	30.00	
10 - 8" floppy diskettes			
Dyanex NA	32.00	37.00	

HUGE DISCOUNTS all
RIBBONS • DUST COVERS
PAPER • POST CARDS • LABELS
for almost every make and model

HEWLETT-PACKARD

CALCULATORS

HP-11C	56	HP-15C	90			
HP-12C	90	HP-16C	90			
HP-41C				145	HP-41CX	245
HP-41CV	168	HP-97	560			

all software & accessories too

PORTABLE COMPUTERS

HP-71B	389	HP-75D	799
--------	-----	--------	-----

series 70 software & peripherals discounted too

HP-2225B ThinkJet Printer (HPIL) 375



SHARP CALCULATORS

EL 5100	43
EL 5500 T	70
EL 512 T	28

SHARP

HAND HELD COMPUTERS

pc 1250A	80
pc 1260	CALL
pc 1261	CALL
pc 1500A	160

PRINTERS DISCOUNTED TODAY

CABLES — INTERFACES

accessories for Computer Printers	
GRAPPLER PLUS	105
16K BUFFERED GRAPPLER	165
Apple Oupling GX	65
Cardco G	65
CB5608 10 ft. Par. Cable for IBM	25
CB5622 10 ft. 36x36 Parallel	32
CB5629 10 ft. 25x25 RS-232	25
CB5618 6 ft. TI-89/4A parallel cable	25
CB5620 8 ft. par. TR880 mod. I-III-IV22	CALL
ALL OTHER CABLES	CALL

TESTING COMPATIBILITY

formats at all.

Another area of incompatibility arises from the manufacturer not partitioning the fixed disk in the same manner as the IBM XT does. The IBM XT allows as many as four different bootable disk partitions. Each operating system may use one partition only. Thus a fixed disk may contain a DOS, CP/M-86, and/or Concurrent CP/M-86 partition.

The DOS-TEST programs check four areas of MS-DOS: the display, communications, printer, and keyboard characteristics; the disk organization; DOS interrupts; and the remainder of DOS functions that are invariant Microsoft functions.

The display testing consists of displaying the characters as shown in the IBM *Technical Reference Manual*, Appendix C. These tests use DOS interrupt 21 hexadecimal functions 2 and 6. The keyboard tests in DOS-TEST verify that the extended keycodes are identical. The physical keyboard layout may be different, but the ASCII (American National Standard Code for Information Interchange) and extended codes must be identical to pass the tests. The keyboard tests use DOS interrupt 21 hexadecimal functions 1, 6, 7, 8, A, B, and C. The other character device operations are tested via DOS interrupt 21 hexadecimal functions 3, 4, 5, and 9.

DOS-TEST includes programs for the testing of disk organization as noted above. Also, one program checks the fixed-disk partitioning. This test uses Disk ROM BIOS interrupts because the partition table exists outside of the system.

The remainder of the DOS-TEST programs exercise DOS interrupts 20 hexadecimal (program terminate), 22 hexadecimal (terminate address), 23 hexadecimal (control break exit address), 24 hexadecimal (critical error handling vector), 25 hexadecimal (absolute disk read), 26 hexadecimal (absolute disk write), 27 hexadecimal (terminate process and remain resident), and 21 hexadecimal (DOS function calls not included above).

Checking for IBM PC and IBM XT compatibility is tedious at best. PC-TEST and DOS-TEST were designed to be specific engineering test tools to pinpoint areas of compatibility and incompatibility. ■

CALL TOLL FREE 800-621-1269 EXCEPT Illinois, Alaska, Hawaii

Corp. Accts. Invited. Min. Ord. \$15.00. Mastercard or Visa by mail or phone. Mail Cashier's Check, Mon. Ord., Pers. Check (2 wks. to clear) Add \$4.00 (1st item) (AK, HI, P.R., Canada add \$10.00 first item) \$3.00 ea. add'l shipg. & handl. Shipments to IL address add 7% tax. Prices Subj. to change. WRITE for free catalog. RETURN POLICY: Defective Only. Most products replaced within 30 days of purchase with identical merchandise only. Computer and large peripherals replaced only when defective on arrival (within 3 work days of delivery). Other problems covered by mfr. warranty. ALL ELEK-TEK MERCHANDISE IS BRAND NEW, FIRST QUALITY AND COMPLETE.

ELEK-TEK, inc.

6552 N. Lincoln Ave., Chicago, IL 60645
(312) 631-7800 (312) 677-7660



BASIC Discovers Shorthand.

Programming in BASIC just got smarter, easier, faster . . . and five great reviews. Before you write another program in BASIC, you might be wise to start with a little reading.

Five major computer publications have something good to tell you. About the BASIC Development System (BDS). And about making your programming in BASIC more efficient than you ever dreamed.

BDS is a powerful, integrated set of software tools that quickly gets you beyond the BASIC basics. It gives you everything from Cross-Referencing to Scrolling Keys that let you scroll by page or line. It gives you Compress and Uncompress commands, Variable Dump, Single Step Trace and more.

BDS also gives you something else. A 30-day money back guarantee.

Finally, BDS gives you great references. From reviewers who've lived with it and loved it. For example: "I wonder how I ever got along without it." John M. Woram, *PC Magazine*, September 1983.

We'll send you the reviews just for writing us. Or, for only \$79, we'll send you BDS itself. And a 30-day money back guarantee.

BETA TOOL SYSTEMS

BTS

8972 E Hampden Ave. • Suite 179
Denver, Colorado 80231 • (303) 793-0145

BDS is available for IBM PC and COMPAQ computers.
VISA/MC accepted. Please add \$3 for shipping.

Announcing 4 New Collector Edition

BYTE COVERS

The 4 Byte covers shown below are the newest additions to the Collector Edition Byte Cover series. Each full color print is 11" x 14", including a 1 1/2" border, and is part of an edition strictly limited to 500 prints. Each print is a faithful reproduction of the original Byte painting, printed on museum quality acid free paper, and is personally inspected, signed and numbered by the artist, Robert Tinney. A Certificate of Authenticity accompanies each print.

Collector Edition Prints are carefully packaged flat to avoid bending, and are shipped first class within one week of receipt of order. The price of each print is \$25. All 4 prints are available as a set (Set 21-24) for only \$80.

Other Collector Edition Byte Covers are also available from Robert Tinney Graphics. For a color brochure, or to order one or more of the prints shown, please check the appropriate box in the coupon below.

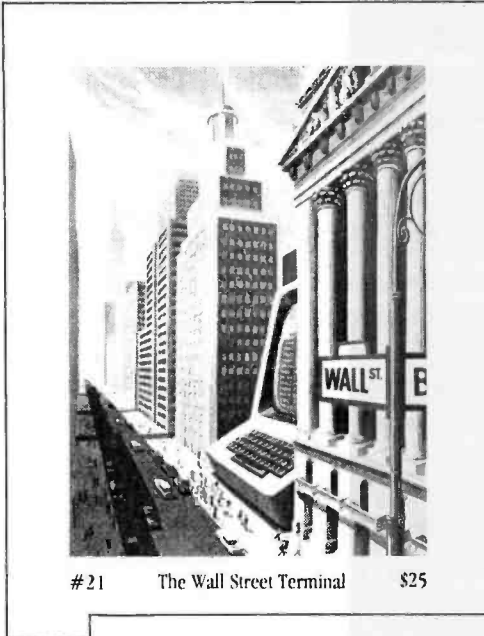

#21 The Wall Street Terminal \$25

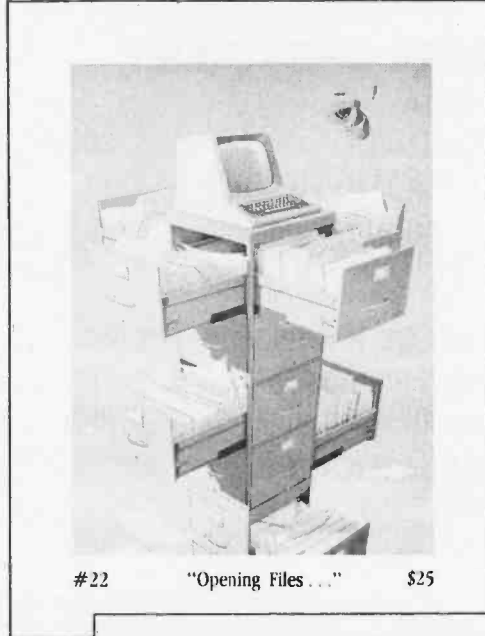

#22 "Opening Files ..." \$25

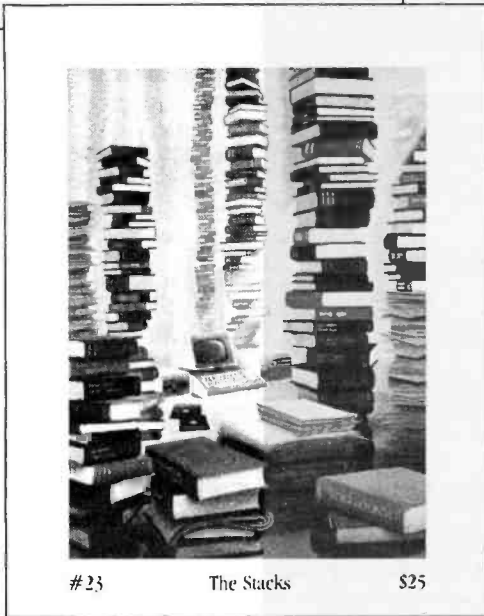

#23 The Stacks \$25

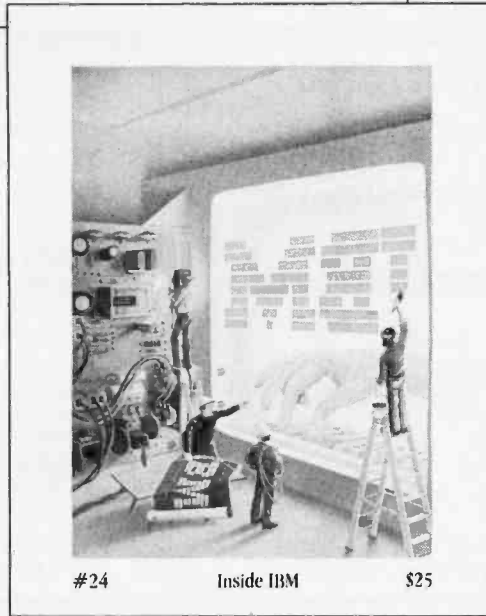

#24 Inside IBM \$25

Please send me the following Prints (\$25), or Sets (\$80).

QTY.	TITLE & PRINT NO.	AMOUNT
_____	_____	\$ _____
_____	_____	\$ _____
_____	_____	\$ _____
postage & handling \$3.00 (Overseas \$8.00)		\$ _____
TOTAL		\$ _____

Please send me your color brochure.

I have enclosed check or money order.

Visa MasterCard

Card No. _____

Exp. Date: _____

SHIP MY PRINTS (OR BROCHURE) TO:

Name: _____

Address: _____

City: _____

State: _____ Zip: _____

Mail this coupon to:

robert tinney graphics
1864 N. Pamela Drive
Baton Rouge, LA
70815

FOR VISA OR MASTERCARD ORDERS
or for more information
CALL 1-504-272-7266
Daytime or Evenings

Perfect Compatibility

IBM & ACP

When you need competitive prices, prompt service and complete support, call us.

HARDWARE SPECIALS

CONTROL DATA

Full Size 320K DS/DD \$ 209*

*"The drive IBM trusted with its logo"

TEAC

Half-Height 320K DS/DD \$ 179

"The #1 Rated Half-Height Drive"

AST MEAGAPLUS II w/256K \$ 434

64K RAM Chips 200ns Pre-Tested \$ 55

AST SIXPACK w/384K \$ 569

MAYNARD ELECTRONICS

10MB HARD DISK

(XT Lookalike) \$ 995

SOFTWARE SPECIALS

LOTUS 1-2-3/WORDSTAR

PROPACK \$ 679

LOTUS 1-2-3/HERCULES

GRAPHICS CARD \$ 679

MULTIMATE w/80K Word Speller . \$ 295

An advanced word processor with all the features of a dedicated stand alone system.

dBASE II/QUICKCODE/dUTIL \$ 450

dB/COMPILER \$ 450

Neither dBase II nor Run-Time required.
30% less storage, faster execution
assembly language interface

EASYWRITER II/SPELLER/MAILER . . . \$ 195

HARDWARE

COMPUTER SYSTEMS

IBM

PC w/256K 2 DS/DD Disk Drives \$ Call

COMPAQ

w/256K 2 DS/DD Disk Drives \$ Call

COMMUNICATION PRODUCTS

HAYES

Smartmodem 300 \$ 209

Smartmodem 1200 \$ 489

Smartmodem 1200B w/Smartcom II . \$ 419

Smartmodem-to-IBM 6 ft. Cable . . . \$ 25

Smartcom II \$ 109

NOVATION

Access 1-2-3 (w/Crosstalk XVI) . . . \$ 379

TAC

Irma (Emulates 3278 Terminal) . . . \$ Call

Irma Line (For Remote Emulation) . . \$ Call

We carry a wide variety of Mainframe Communication and Local Area Networks. For advice about which will suit your needs best give us a call and let us review them with you.

FLOPPY & HARD DISK DRIVES

CONTROL DATA

Full Size 320K DS/DD \$ 209

Half-Height 320K DS/DD w/Bracket . . \$ 189

DAVONG

5 MB to 32 MB Hard Disk Int./Ext. . . \$ Call

(Includes power supply, controller & software)

TALLGRASS

12-70 MB Hard Disk w/Tape Backup . . \$ Call

TEAC

Half-Height 320K DS/DD w/Bracket . . \$ 179

Half-Height 640K DS/DD w/Bracket . . \$ 265

MAYNARD ELECTRONICS

10MB Hard Disk WS-1 (XT Lookalike) . \$ 995

10MB Hard Disk WS-2 (XT Lookalike) . \$1195

DISKETTES

SCOTCH 3M

DS/DD Box of 10 \$ 35

VERBATIM

DS/DD Box of 10 \$ 35

DISK CONTROLLERS

MAYNARD ELECTRONICS

Standard Disk Controller \$ 115

with Parallel Port \$ 135

with Serial Port \$ 145

Sandstar Modular Disk Controller . . . \$ 209

All Sandstar Modular Options Avail. . \$ Call

EXPANSION BOARDS

MAYNARD ELECTRONICS

Modular Memory Brd. w/64K to 576K . \$ 219

Modular Multifunction Board \$ 95

- Next Day Shipping
- No Credit Card Surcharge
- Company P.O. Accepted

We have built our reputation on offering quality products, prompt service and effective solutions. We understand your need for well-informed people who will work with you to meet your goals. Therefore we have developed a unique approach to sales. Our salespeople are well educated in the computer field and will speak with you not as salespeople, but rather as consultants. They will review your options and suggest alternatives to help you construct a system to best suit both your immediate and future needs. We also have a skilled technical staff that will guide you through any problems you may encounter after receiving your equipment.

HARDWARE CONT.

AST RESEARCH

(All AST boards include SuperDrive, SuperSpool and 1 year warranty)

SixPack Plus w/64K to 384K	\$ 269
MegaPlus II w/64K to 512K	\$ 269
Memory Board II w/64K to 384K	\$ 239
I/O Plus II	\$ 139
MegaPack w/128K or w/256K	\$ Call
Parallel, Serial, Game Options	\$ 35

ORCHID TECHNOLOGY

Blossom w/64K to 384K	\$ 269
-----------------------	--------

TECMAR

Captain w/64K to 384K w/Software	\$ 269
----------------------------------	--------

QUADRAM

Quadboard w/64K to 384K	\$ 279
-------------------------	--------

PRINTERS & PLOTTERS

C. ITOH

Starwriter Letter Quality 40 cps	\$1195
Printmaster Letter Quality 55 cps	\$ Call
Cut Sheet Feeder (Feeds 200 sheets)	\$ 445

EPSON

(All Printers include GRAPHTRAX-Plus)

RX-80 (120 cps, 80 cols)	\$ Call
RX-80 F/T (120 cps, 80 cols)	\$ Call
RX-100 F/T (100 cps, 132 cols)	\$ Call

FX-80 F/T (160 cps, 80 cols)	\$ Call
FX-100 F/T (160 cps, 132 cols)	\$ Call
Epson-IBM Cable	\$ 30

HEWLETT PACKARD

HP-7470A Two Pen Plotter	\$ Call
HP-7475 Six Pen Plotter	\$ Call
HP-IBM Cable (works w/Lotus 1-2-3)	\$ 50

NEC

NEC 3550 Letter Quality 35 cps	\$1699
NEC 2050 Letter Quality 18 cps	\$ 895
Bi-Directional Tractor	\$ 235
Cut Sheet Feeder (Feeds 200 Sheets)	\$ 445
NEC-IBM Cable	\$ 30

OKIDATA

Microline 83A (120 cps, 132 cols)	\$ 575
Microline 92 (160 cps, 80 cols)	\$ 445
Microline 93 (160 cps, 132 cols)	\$ 699
Microline 84 (200 cps, 132 cols)	\$ 879
Plug n' Play	\$ Call
Okidata-IBM Cable	\$ 30

SILVER-REED

EXP 550 (20 cps, 132 cols)	\$ 595
----------------------------	--------

MONITORS

AMDEK

Video 300 Green Screen	\$ 140
Video 300A Amber Screen	\$ Call

Video 310A IBM Monochrome in Amber	\$ 170
------------------------------------	--------

PRINCETON GRAPHICS

HX-12 RGB Hi Resolution Color	\$ 499
Max-12 IBM Monochrome in Amber	\$ Call
SR-12 Hi Resolution Color	\$ Call

VIDEO—MONITOR BOARDS

HERCULES Graphics Card	\$ 359
-------------------------------	--------

PC COMPONENTS Bi-Graphix I	\$ Call
-----------------------------------	---------

PARADISE SYSTEMS Multidisplay	\$ 399
--------------------------------------	--------

PC+ PRODUCTS Colorplus	\$ 419
-------------------------------	--------

STB Graphix Plus	\$ 299
-------------------------	--------

QUADRAM Quadcolor I	\$ 199
----------------------------	--------

TECMAR Graphics Master	\$ 499
-------------------------------	--------

MISCELLANEOUS

Cables (all extension cables)	\$ Call
8087 Co-processor	\$ 199

KEY TRONIC

Deluxe Keyboard (KB 5151)	\$ Call
---------------------------	---------

KOALA —Touch Tablet w/Software	\$ Call
---------------------------------------	---------

KRAFT —Joystick	\$ 49
------------------------	-------

T.G. —Joystick	\$ 49
-----------------------	-------

MICROSOFT —Mouse w/Software	\$ 159
------------------------------------	--------

MOUSE SYSTEMS —PC Mouse	\$ Call
--------------------------------	---------

SOFTWARE

ALPHA

Database Manager II	\$ 199
Apple—IBM Connection	\$ Call

ASHTON TATE

dBase II	\$ 285
dBase III	\$ Call
Friday	\$ 179
Framework	\$ Call

ATI

All Software Training Pkgs	\$ 55
----------------------------	-------

CENTRAL POINT SOFTWARE

Copy II PC	\$ 35
------------	-------

FOX & GELLER

Quickcode	\$ 169
dGraph (Requires Graphics Card)	\$ Call
dUtil (Utilities For dBase II)	\$ 25
OZ (Management Control)	\$ Call
FINANCIER —Financier II	\$ 119
FUNK —Sideways	\$ 49
HAYES —Smartcom II	\$ 109
IMSI —4 Point Graphics (Rated #1)	\$ 119

INDIVIDUAL SOFTWARE

Tutorial Set (IBM PC/XT and DOS)	\$ 79
Typing Instructor	\$ 49

INFORMATION UNLIMITED SOFTWARE

EasyWriter II System (See Specials)	\$ 195
Accounts Receivable	\$ 299
Accounts Payable	\$ 299
General Ledger	\$ 299
Payroll	\$ 369

INFOCOM —Zork I, II, III	\$ 29
---------------------------------	-------

LATTICE

C-Compiler	\$ 299
C-Food Smorgasboard	\$ 110

LIFETREE

Volkswriter	\$ 115
Volkswriter Deluxe w/TextMerge	\$ 179

LIGHTNING SOFTWARE

Master Type (Best Typing Tutor)	\$ 39
---------------------------------	-------

LOTUS DEVELOPMENT

Lotus 1-2-3 (Version 1A)	\$ Call
Symphony	\$ Call
Symphony Upgrade	\$ Call

MICRO DATA BASE SYSTEMS

Knowledgeman	\$ 299
--------------	--------

MICROSOFT

C-Compiler	\$ 349
Flight Simulator	\$ 35
Multiplan (New Version)	\$ 149
Multi-Tool Word	\$ 249
Multi-Tool Word w/Mouse	\$ 299
Pascal Compiler	\$ 250

MICROPRO

Wordstar w/Tutorial on Disk	\$ 259
Wordstar/MailMerge/CorrectStar/ StarIndex (ProPack)	\$ 369

MICRORIM

R.base 4000	\$ 299
Clout	\$ 139

MICROSTUF

Crosstalk XVI (for Hayes Smartmodem)	\$ 109
---	--------

MORGAN COMPUTING

Trace 86 (Assembly Language Debug)	\$ 99
Ted (Program Editor)	\$ 79
Professional Basic (170K Work Space w/8087 Support)	\$ 259

MULTIMATE INTERNATIONAL

Multimate (See Specials)	\$ 295
--------------------------	--------

PETER NORTON

Norton Utilities	\$ 55
------------------	-------

POWER BASE SYSTEMS

Power Base	\$ 269
------------	--------

ROSESOFT

Prokey (Newest Version)	\$ 95
-------------------------	-------

SOFTWARE ARTS

TK!Solver	\$ 299
-----------	--------

SOFTWARE PRODUCTS

Open Access	\$ 399
-------------	--------

SATELLITE SOFTWARE INTERNATIONAL

Word Perfect (includes Speller)	\$ 279
---------------------------------	--------

SORCIM

Supercalc 3	\$ 219
-------------	--------

SOFTWARE PUBLISHING

PFS/File	\$ 95
PFS/Graph	\$ 95
PFS/Write	\$ 95
PFS/Report	\$ 79

TALL TREE SYSTEMS

J-Format 2.0	\$ 40
--------------	-------

WORDTECH SYSTEMS

dB/Compiler (True dBase II Compiler)	\$ 450
---	--------

WANG PUBLICATION

Random House Proof Reader 50K speller	\$ 45
--	-------

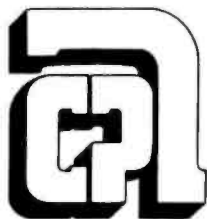

APPLIED COMPUTER PRODUCTS INC.

1916 Welsh Road #6, Philadelphia, PA 19115

215-934-6990

1-800-223-3860

Our Policy

• We accept VISA, Mastercard, Money Orders, Certified Checks, Cashiers Checks, Personal Checks, Wired Funds. • We do not charge your card until we ship. • No surcharge added on VISA and Mastercard. • Allow one week for personal and company checks to clear. • COD maximum \$500 Cash or Certified check on delivery. • Please use local phone number for order status inquiries. • Prices subject to change without notice. • Returns may be subject to restocking fee.

SHIPPING (U.S.). For monitors, printers, and hard disk drives add 2% to all orders. Blue label and Next Day Air available. For all other items add \$4. Most orders shipped next day.

PERIPHERALS

CallText Permits Data Access Over Telephone

CallText 5000 is a text-to-speech converter and telephone interface that lets you access text data in voice by means of a Touch-Tone telephone. It provides voice output with unlimited vocabulary, and you can program it to answer the telephone, initiate calls, obtain text data from a host computer, and supply text in voice to a caller. CallText converts serial ASCII English text to speech in real time and automatically answer incoming calls. It has an on-board speaker and I/O drivers callable from BASIC, C, and assembly-language programs running under MS-DOS. Priced at \$2700, it connects to the telephone network through a modular jack and to the computer through an RS-232C serial port. Contact Speech Plus Inc., 461 North Bernardo Ave., Mountain View, CA 94043. (415) 964-7023.

Circle 252 on inquiry card.

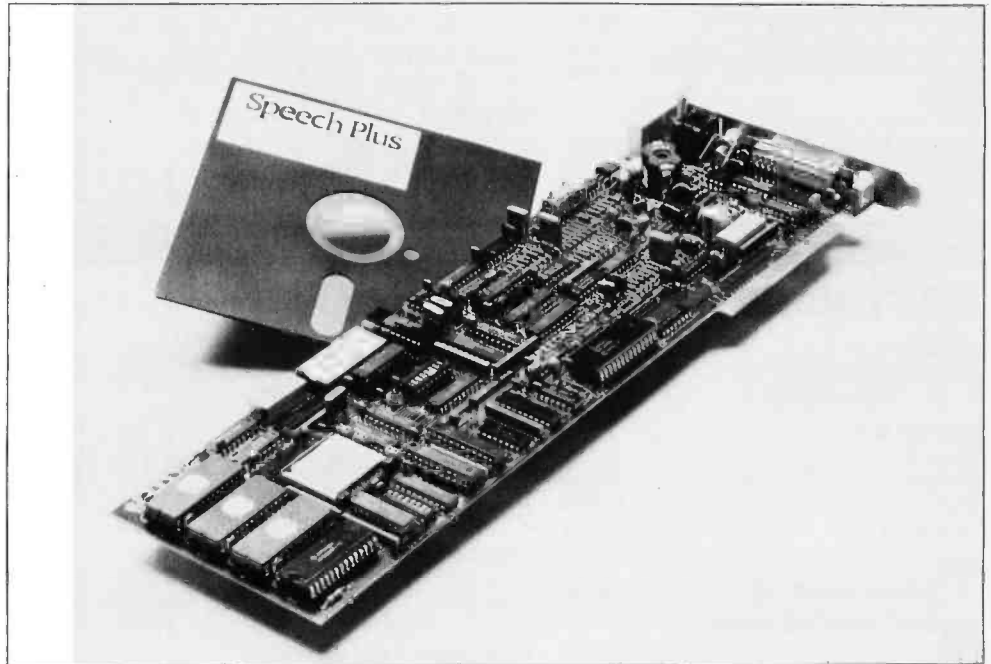

Disk Subsystems Use Kodak Drives

Data Technology's TeamMate line of disk subsystems for the IBM PC are based on Eastman Kodak's 3.3-megabyte (unformatted) flexible disk technology. The TeamMate subsystems offer 2.78 megabytes of on-line formatted storage capacity, and they can serve as a Winchester backup. TeamMate configura-

tions include internal- or external-mount Kodak drives, two external drives, or a combined 10-megabyte Winchester drive with the Kodak drive for backup. The software controllers are transparent, providing easy installation without software drivers or formatted disks. For storage and retrieval, the drives

use a closed-loop servo tracking system. A user-initiated command will switch the motor speed for reading either 48- or 96-tpi media. Prices begin at \$895. Contact Data Technology Corp., 2775 Northwestern Parkway, Santa Clara, CA 95051. (408) 496-0434. Circle 253 on inquiry card.

Hard-Disk Subsystems

Micro-Design markets a line of hard-disk subsystems for IBM PC, PC-compatibles, Apples, and Radio Shack computers. Its Data and SQ series incorporate removable 5-megabyte cartridges, on-line access and off-line storage, and expandability. Microprocessors handle the interface to the computer and

embedded servo mechanisms ensure position accuracy when reading or writing data. The line includes units that mix removable and fixed storage media, with storage capacities ranging as high as 22 megabytes. Prices for the Data series begin at \$2995; the SQ series starts at \$1795. The Pro

Series of 10-, 20-, and 33-megabyte models are available for internal installation or in IBM-style cases. Prices start at \$1299. Contact Micro-Design, 6301 Manchaca Rd., Austin, TX 78745. (800) 531-5002; in Texas, (512) 441-7890. Circle 255 on inquiry card.

Multifunction Card Has Real-Time Clock

Seattle Computer's RAM+6 multifunction card gives IBM PC users a time-of-day clock with battery backup, room for up to 348K bytes of RAM, and ports for a parallel printer, an RS-232C serial device, and game connection. Memory options for RAM+6 include 64K, 128K, 192K, 256K, 320K, and 348K bytes. This board is provided with software that lets you designate a portion of memory to be used for disk emulation. Another software package lets you assign up to 64K bytes of memory, in 1K-byte increments, as a printer buffer. RAM+6 prices begin at \$395 with 64K bytes of memory. Contact Seattle Computer, IBM PC Products, 1114 Industry Dr., Seattle, WA 98188. (800) 426-8936; in Washington, (206) 575-1830. Circle 256 on inquiry card.

SOFTWARE

Single-Board Modem Fits in PC

The single-board MultiModem PC fits inside the IBM PC and does not require a serial card. An auto-dial/auto-answer 300/1200-bps communications system. MultiModem has an internal speaker for call-progress monitoring. Its commands are Hayes Smartmodem 1200/1200B compatible. It comes with communications software that provides automatic log-on, diagnostics, error-protecting file-transfer protocol, log-on macro

encryption for password security, and the ability to copy communications to the printer, disk, or both while on-line. MultiModem and its software can be configured as either COM1, COM2, COM3, or COM4. With documentation, it's \$549. Contact Multi-Tech Systems Inc., 82 Second Ave. SE, New Brighton, MN 55112, (612) 631-3550. Circle 251 on inquiry card.

PC-to-Mainframe Connection

The Quad3278 plugs into the IBM PC and creates an IBM PC-to-mainframe connection. This hardware/software package will permit the PC, PC XT, and PC-compatibles to communicate with an IBM mainframe via a 3270 coaxial network. It provides 3278 Information Display emulation and a screen-capture ability that lets you retrieve, store, and print pages of infor-

mation from the mainframe. You can toggle back and forth between PC stand-alone and mainframe modes. With documentation, it sells for \$1195. A starter kit, which includes 100 feet of coaxial cable, is \$95. Contact Quadram Corp., 4355 International Blvd., Norcross, GA 30093, (404) 923-6666. Circle 254 on inquiry card.

Memory Board Has Clock/Calendar

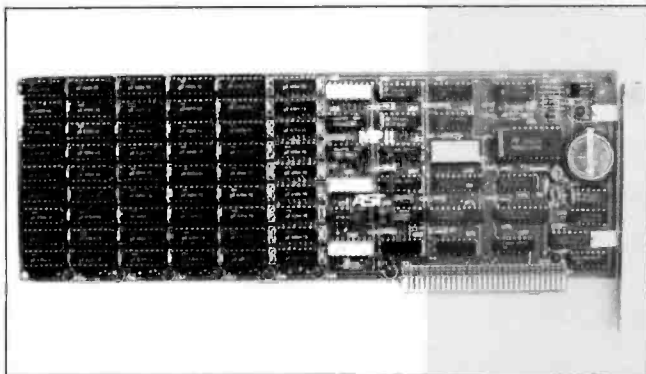

AST Research calls its MPII a "no frills" expansion card for the IBM PC XT. The MPII comes with 64K bytes of dynamic RAM, utility software, and a clock/calendar. Its memory capacity is upgradable to 348K bytes in 64K-byte increments. The price for the MPII ranges

from \$345 to \$845, depending on memory. The 64K-byte increments are \$100. A version without the clock/calendar is available. Contact AST Research Inc., 2121 Alton Ave., Irvine, CA 92714, (714) 863-1333. Circle 257 on inquiry card.

System Allows Sharing of Printers

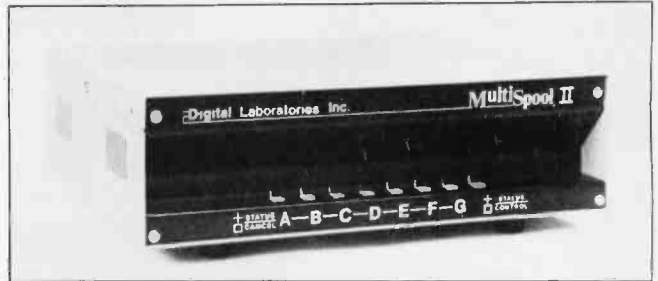

Digital Laboratories is selling a family of printer-sharing systems for microcomputers, minicomputers, and mainframes. The MultiSpool Printer Sharing Systems can route the output from as many as 17 computers

to as many as 5 serial or parallel printers. Prices begin at \$595. Information is available from Digital Laboratories Inc., 600 Pleasant St., Watertown, MA 02172, (617) 924-1680. Circle 269 on inquiry card.

APL Interpreter Written in C

Portable Software has announced the availability of PortaAPL, an APL interpreter written in C for easy portability between different computers. Currently, interpreters are available for the IBM PC, Sanyo PC, DEC VAX, and Motorola 68000. The implementation is identical on all machines, and a system command is available for porting workspaces to different types of computers. PortaAPL does not support shared

variables, but it does include a full-screen editor. It has an ASCII character set option and a Host File System option. PortaAPL provides access to machine-language functions. The price for the IBM PC version of PortaAPL is \$195. Source and OEM licenses are available. Contact Portable Software, 60 Aberdeen Ave., Cambridge, MA 02138, (617) 547-2918. Circle 280 on inquiry card.

Spellbinder for PCjr, Compatible Machines

Lexisoft is offering version 5.3 of Spellbinder for the IBM PC, PCjr, and compatibles. This version includes a spelling and grammar checker, automatic hyphenation, footnoting, augmented forms-handling, and a revised manual. The program also interfaces with database-management, spreadsheet, and accounting programs. The suggested retail price is \$495. Information is available from Lexisoft Inc., POB 1378, Davis, CA 95617, (916) 758-3630. Circle 264 on inquiry card.

Want to Program In Plain English?

Plain English is claimed to be the first programming language using simple English language commands such as "save by customer number in accounts receivable and repeat." The language runs under all MS- and PC-DOS systems and includes four accounting modules as example programs. List price is \$595. Contact Common Language Systems Inc., 100 East Sybelia Ave., Maitland, FL 32751, (305) 628-5973. Circle 262 on inquiry card.

(continued)

SOFTWARE

Planner Software Fills Address Book

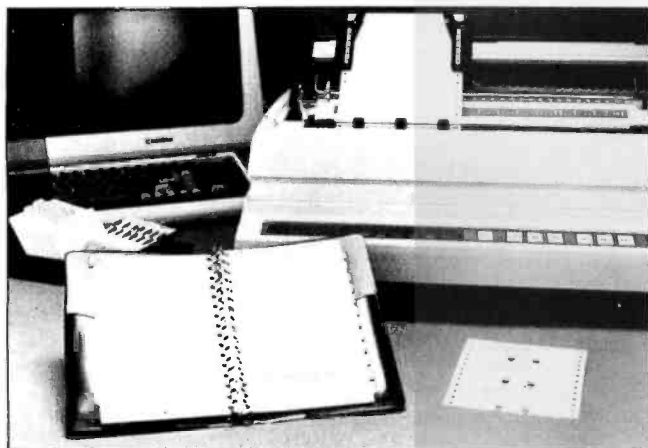

Personal Planner is a program for keeping name and telephone lists and printing them on Recordplate forms for use in an address book. The program also can produce form letters using the address list. It runs on all IBM PC models, in-

cluding PCjr. and compatibles. List price is \$99, including the address book and 100 Recordplate forms. Contact National Microware, 2102 Business Center Dr., Irvine, CA 92715. (714) 752-2344. Circle 263 on inquiry card.

Mini-based Editor Ported to IBM PC

UniPress Software has developed a Gosling EMACS screen editor for the IBM PC. The company says that the MS-DOS version is a full-function Gosling EMACS, including full-screen editing, multiple windows, full keybindings, automatic parentheses checking, extensibility through macros,

and a built-in compiled MLISP programming language. Cost is \$375 for a binary version and \$995 for source code. A minimum of 384K bytes of RAM is required. For information contact UniPress Software Inc., 1164 Raritan Ave., Highland Park, NJ 08904. (201) 985-8000. Circle 259 on inquiry card.

PC Article Database Free of Charge

LETUS A-B-C, a database containing abstracts of articles and letters from major IBM PC magazines, is available without charge under the user-supported software concept. The database covers all articles and letters from the 1982 and 1983 editions of *Softtalk*, *PC*, *PC Age*, *PC World*, and *PC Tech Journal*. It includes articles on the IBM Personal Computer that appeared in *BYTE* magazine. Designed to be used with PC-File, LETUS A-B-C lets you

search the database by any keyword, subject, title, or author. You can obtain LETUS A-B-C by sending three double-sided double-density floppy disks in a self-addressed, stamped mailer to LETUS A-B-C, 3790 El Camino Real, #2006, Palo Alto, CA 94306. (415) 493-4306. (A donation of \$10 per disk is requested.) You can also remit \$40 and the disks will be mailed to you. Circle 279 on inquiry card.

Make Your IBM Into a DEC

The EM100 is a software program for the IBM PC, PC XT, and Portable PC that allows those computers to communicate with DEC hosts as VT100 terminals. EM100 sells for \$225. Information is available from Diversified Computer Systems, POB 7575, Boulder, CO 80306. (303) 443-6255. Circle 258 on inquiry card.

Database Program Supports LANs

Metafile version 8.0, a relational database system, claims compatibility with most PC local-area networks, including PCnet, Novell Sharenet, and 3COM. The program, which costs \$995, allows users to share logical and physical devices such as hard-disk drives and letter-

quality printers among several computers. Transaction-level locking is used for data integrity. For information, make contact with Sensor-based Systems, 1701 East Lake Ave., Glenview, IL 60025. (800)323-3731; in IL (312) 724-0310. Circle 268 on inquiry card.

A Clean Slate for Commercials

Clean Slate is designed to estimate and control costs of film and video-tape commercials. It costs \$795 and runs on any IBM PC or compatible computer and can be modified for special requirements. Information is available from InfoCus Systems, POB 556, Middle Village, NY 11379. (212) 849-9672. Circle 273 on inquiry card.

dBasell Program Tracks Prospects

Prospects Unlimited keeps files of information on customers and prospects for salespeople. It also can be used as a tickler file, time manager, and label generator. It is written in dBasell and sells for \$349. For information, make contact with ACS Consultants, Suite 207, 199 California Dr., Millbrae, CA 94030. (415) 697-3861. Circle 271 on inquiry card.



Modular Software for Businesses

Interactive Business System is a set of interrelated modules that can handle accounts receivable, accounts payable, inventory control, payroll, fixed assets, and general ledger. The complete system retails for \$795; demonstration disks and manual are available for \$25 from Performance Engineered Programming, 3970 Syme Dr., Carlsbad, CA 92008. (619) 434-6023. Circle 267 on inquiry card.

SOFTWARE

Calculator Program

Evergreen Software Products' PC-Calculator performs all the standard functions of a desktop calculator as well as solving trigonometric, statistical, and financial problems. The program can support a line printer. PC-Calculator will run on any IBM PC or compatible with at least 96K bytes of memory. It retails for \$39.95. Contact Evergreen Software Products, POB 438, Lancaster, NY 14086, (716) 683-4603.

Circle 277 on inquiry card.

Mapping Program Uses Standard Information

Atlas is an interactive, menu-driven program from Strategic Location Planning for generating maps and data displays based on state, county, congressional district, advertising region, census tract, or custom data. It requires PC-DOS 2.0, 192K bytes of RAM, and an HP-7470A or HP-7475A plotter or a dot-matrix graphics printer. Price is \$225, and information is available from Strategic Locations Planning, 2471 Golf Links Circle, Santa Clara, CA 95050, (408) 247-1956.

Circle 270 on inquiry card.

Integrated Systems Can Run on PCjr

IOAS-3 is an integrated software package for the IBM PC, PC XT, PCjr, and compatibles that sells for \$199. It includes a database manager, IDM-X; a spreadsheet, SS-X; and a word processor, WORD-X. Minimum memory needed is 128K bytes, and any version of PC-DOS can be used. The system comes in three versions: IBM PC XT, PCjr with monitors, and PCjr with television display. It supports both monochrome display and color monitors. For information, contact Micro Architect Inc., 6 Great Pine Ave., Burlington, MA 01803, (617) 273-5658.

Circle 260 on inquiry card.

Baby 34 Lets RP GII Programs Run on PC

Baby 34 is a software system that allows programs in the RPG II language to run on the IBM PC and PC XT. Available for \$2500 to \$3000, depending on options, Baby 34 provides for program conversion between the PC and the IBM System 34 by use of the data exchange utility (DEU). Also included are an operations control language (OCL), an RPG II compiler, RPG II run-time support, a screen-format generator, source entry utility (SEU), and RPG II sort. A data file utility is optional. Contact May-Craft Information Systems Inc., 4312 Beltwood Parkway South, Dallas, TX 75234, (800) 527-7456; in Texas, (214) 392-3766.

Circle 276 on inquiry card.



Cope with Linear and Integer Programming

Management Analytic Support has announced the release of Cope, a software package for solving linear and integer programming problems on the IBM PC. Cope features conversational English interaction with the computer and menu-driven applications development. Variable names may be as long as 16 characters. Problems may be saved on disk, reloaded, and

modified from within Cope. Cope is available for three ranges of applications: 50 constraints by 100 variables, 100 by 200, and 150 by 300. The pricing is \$285, \$365, and \$475, respectively. Contact Management Analytic Support Inc., 6826 Dean Dr., McLean, VA 22101, (202) 293-1624.

Circle 274 on inquiry card.

Video Makers Get Help with Budgeting

The DataMogul Budget program is designed to prepare, revise, and print budgets for film and videotape production. It runs on all versions of the IBM PC and compatibles. Special forms are available for specific budgeting. The basic program lists for \$1100, and the forms range in prices from \$100 to \$500. Information is available from Quantum Films, Suite 24, 8344 Melrose Ave., Los Angeles, CA 90069, (213) 852-9661.

Circle 272 on inquiry card.



New Program Can Aid Mail-Order Businesses

Data Consulting Group has introduced its PC Mail Order System for the IBM PC and compatibles. The program allows logging details of sales, printing sales reports, printing labels and lists, maintaining inventory controls, and creating invoices. It sells for \$295. Information is available from Data Consulting Group, 12 Skylark Dr., #18, Larkspur, CA 94939, (415) 927-0990.

Circle 261 on inquiry card.

The Micromint Collection

Micromint. Supporting the varied projects that appear in Steve Ciarcia's monthly article in BYTE Magazine, "Ciarcia's Circuit Cellar." Offering a wide range of computers and peripherals designed to meet the exacting demands of the hobbyist as well as worldwide corporate clients.

TERM-MITE ST SMART TERMINAL BOARD

As featured in Ciarcia's Circuit Cellar BYTE Magazine, January & February 1984

All you need to build a Smart Video Terminal equivalent to the types advertised for \$1,000.00 or more is a Term-Mite ST circuit board, scanned or parallel keyboard, video monitor and power supply.

- Uses brand new Nat'l Semi NS455A Terminal Processor.
 - 24 lines by 80 characters, 25th reverse-video status.
 - Upper & lowercase, Line (block) graphics.
 - Selectable data rate, parity & display options
 - Reverse video, half intensity, double height & width, underlined, blinking and/or blank character.
 - Separate sync or composite video output. Self Test.
- Term-Mite ST Video Display Terminal Board
BCC22 Assembled & Tested \$284.
BCC23 Complete Kit 244.

MPX-16 MICROCOMPUTER IBM PC COMPATIBLE



As featured on the cover of BYTE Magazine. Also featured in Ciarcia's Circuit Cellar November, December 1982 & January 1983

The Computer With A Split Personality
—Use it as an IBM PC look alike that directly boots PC DOS 1.1, and accepts all expansion boards designed for the IBM PC.

—Use it as a powerful 8088 single board computer for all your OEM applications. Just add serial terminal, disk drive and power supply. Directly boots CP/M-86.

Buy the MPX-16 in the form that best meets your needs or budget. As a bare board, as a wave soldered board that contains all components less ICs, as an assembled and tested circuit board or as a complete system.

- Directly boots PC DOS 1.1 and CP/M-86.
- Most IBM PC software executes with no modifications.
- IBM PC bus compatible + 9 expansion slots.
- Intel 8088 16-bit microprocessor.
- Optional Intel 8087 math coprocessor
- 256K bytes on board memory.
- Up to one megabyte of system memory.
- Up to 64K bytes of system ROM EPROM.
- 2 RS-232C Serial & 3 Parallel I/O ports.
- Disk controller for 5 1/4" or 8" drives.
- Sixteen levels of vectored Interrupts.

MPX-16 Circuit Board Assembled w/64KRAM.....	\$1,200.
OEM 100 quantity price	900.
MPX-16 Circuit Board Assembled w/256K RAM	1,400.
MPX-16 Semi-Kit (wave soldered circuit board w/all components) Less ICs	595.
Complete Kit of ICs w/256K RAM	595.
MPX-16 Unpopulated (bare) PC Board	300.
CP/M-86 Operating System + Manuals	80.
MPX-16 Switching Power Supply	300.
MPX-16 Technical Reference Manual	50.
MPX-16 Metal Enclosure with Fan	300.
Tandon TM 100-2 Double Sided Density Drive	300.
IBM PC Keyboard Interface Adapter	100.

Shipping & handling additional on all MPX-16 orders.

IBM PC is a trademark of International Business Machines Inc.
CP/M-86 is a trademark of Digital Research Inc.
Z8 is a trademark of Zilog Inc.

Circle 112 on inquiry card.

Z8 BASIC SYSTEM CONTROLLER NEW!!!

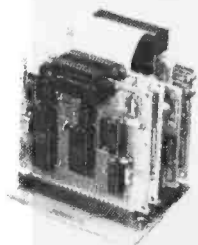

As featured in Ciarcia's Circuit Cellar BYTE Magazine, July & August 1981

The Z8 Basic System Controller is an updated version of our popular BCC01. The price has been reduced and features added. The entire computer is 4" by 4 1/2" and includes a tiny BASIC interpreter, up to 6K bytes of RAM and EPROM. One RS-232C serial port with switchable baud rates and two parallel ports. BASIC or machine language programming is accomplished simply by connecting a CRT terminal. Programs can be transferred to 2732 EPROMs with an optional EPROM programmer for auto start applications. Additional Z8 peripheral boards include memory expansion, serial and parallel I/O, real time clock, an A/D Converter and an EPROM programmer.

- Uses Zilog Z8 single chip microprocessor.
- Data and address buses available for 124K memory.
- Can be battery operated.
- Cross assemblers for various computers.

BCC11 Assembled & Tested \$149.
New Low Price

Z8 MEMORY, I/O EXPANSION CASSETTE INTERFACE

- 8K bytes of additional RAM or EPROM.
- Three additional 8 bit parallel ports.
- Cassette interface—300 baud K.C. Standard.
- Software real time clock.

BCC03 w/4K RAM Assembled & Tested \$150.
BCC04 w/8K RAM Assembled & Tested 180.

Z8 EPROM PROGRAMMER

- Transfer BASIC or Assembly Language application programs from RAM to 2716 or 2732 EPROM.
- Comes with programming & utility routines on EPROM.
- Requires BCC03 Z8 Expansion Board for operation.

BCC07 Assembled & Tested \$145.

Z8 ANALOG TO DIGITAL CONVERTER

- Uses Analog Devices 7581 IC, 8-channel 8-bit.
- Adds process control capability to the Z8 system
- Over 1,000 conversions per channel per second.
- Monitors 8 analog signals in one of two 10v ranges.

BCC13 Assembled & Tested \$140.

Z8 SERIAL EXPANSION BOARD

- Adds additional RS-232C and opto-isolated 20 ma. current loop serial port to the Z8 System.
- Runs at 75 to 19,200 baud in all protocols.
- Comes with listings of sample serial I/O routines.

BCC08 Assembled & Tested \$160.

Z8 16K MEMORY EXPANSION BOARD

- Add up to 16K of additional memory, RAM or EPROM, to your Z8 System Controller in any multiple.
- Accepts 2016, 6116, 2716, or 2732 memory types
- Four 16K cards may be installed on the Z8 System bringing the total memory to 64K.

BCC14 Assembled & Tested w/8K RAM \$120.
BCC16 Assembled & Tested w/16K RAM 155.

COMING SOON! FORTH LANGUAGE VERSION OF THE Z8

With the new Z8 with on board 4K FORTH you can program high speed control functions in a few simple high level language commands. Perfect for data reduction, process control and high speed control applications.

BCC20 Z8F FORTH Microprocessor chip \$150.
BCC21 Z8F FORTH System Controller
(This board is a BCC11 with a BCC20 Installed)
Assembled & Tested 280.

Z8 CROSS ASSEMBLERS

From Micro Resources

IBM PC, APPLE, 6502 Systems 5V4, CP/M 2.2 B \$ 75.

From Allen Ashley

TRS-80 Model I, III, Northstar 5V4 75.
CP/M 2.2 B 150.

Z8 FIVE SLOT MOTHER BOARD

- Expand your Z8 BASIC System with minimum effort.
- Contains five slots complete w/44 pin connectors.

MB02 Assembled & Tested \$69.

TRIPLE VOLTAGE POWER SUPPLIES

+5V @ 300 ma. + / -12V @ 25 ma. UPS01 Assembled & Tested \$35.
UPS02 Complete Kit 27.
+5V @ 1 Amp. +12V @ .5 Amp. -12V @ 50 ma. UPS03 Assembled & Tested 60.
UPS04 Complete Kit 50.

SPEECH SYNTHESIZERS

MICROVOX TEXT-TO-SPEECH SYNTHESIZER

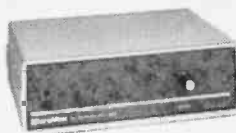

As featured in Ciarcia's Circuit Cellar BYTE Magazine September, October 1982.

Microvox is a second generation professional voice quality text-to-speech synthesizer that is easily interfaced to any computer, modern, RS-232C serial or parallel output device and provides speech of unbelievable clarity.

- Unlimited vocabulary.
- 64 programmable inflection levels.
- 6K text-to-speech algorithm.
- Full ASCII character set recognition and echo.
- RS232C and parallel output.
- 1000 character buffer, 3000 optional.
- Adjustable baud rates (75-9600).
- Spelling output mode.
- 7 octave music and sound effects.
- On board audio amplifier & power supply.
- X-On-X-Off handshaking.

MV01 Assembled with 1K buffer \$299.
MV02 Complete Kit with 1K buffer 219.
Add \$15.00 for 3K buffer option.

VOTRAX SC-01A PHONETIC SPEECH SYNTHESIZER IC

The SC-01A Speech Synthesizer is a completely self-contained solid state device that phonetically synthesizes continuous speech of unlimited vocabulary. Used in our Microvox and Sweet-Talker.

SC01A Quantity 1-99 \$44. ea.
100 + 32. ea.
1000 + 24. ea.

MICRO D-CAM DIGITAL TV CAMERA

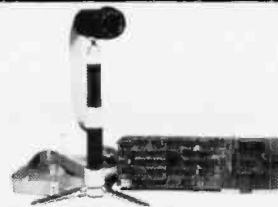

As featured in Ciarcia's Circuit Cellar BYTE Magazine, September & October 1983

GIVE YOUR COMPUTER THE DIMENSION OF SIGHT

- Interprets, enhances and stores images.
- 256 x 128 digital image sensor.
- Plug-in boards for the IBM-PC, APPLE II or e.
- Software includes utilities for auto exposure, multi-level greyscale, screen dump and image enhancement.

- Includes interface card, 4 foot extension cable, camera assembly, manual, and software on diskette.

DC01 IBM PC Assembled & Tested \$299.
DC02 IBM PC Complete Kit 264.
DC03 APPLE II Assembled & Tested 299.
DC04 APPLE II Complete Kit 264.

300 BAUD ANSWER/ ORIGINATE MODEM KIT

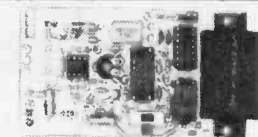

As featured in Ciarcia's Circuit Cellar BYTE Magazine, March 1983

Micromint's latest 300 Baud Modem Kit is crystal controlled, uses the TI TMS99532 IC, contains just 25 parts and requires no calibration or adjustments. Use with acoustic coupler or in direct connect mode.

MD04 Complete Kit as shown \$60.
MD05 Transformer for Direct Connect Mode 9.
AC01 Acoustic Coupler Kit 20.

E-Z COLOR GRAPHIC INTERFACE WITH SPRITES

APPLE II E-Z Color plug-in board with Graphics Editor on 3.3 disk
E201 Assembled & Tested \$150.
E202 Complete Kit 125.

APPLE II E-Z Color Plus
• Allows the use of a single monitor or TV set.
E211 Assembled & Tested w/Graphics Editor \$200.

KRELL LOGO for E-Z Color and E-Z Color Plus Supports Sprite Graphics

E221 Krell LOGO w/full documentation \$89.

Animation Software for E-Z Color Plus
• Draw with Sprites using Joystick or Koala Pad.
• Animate Sprites from your own BASIC program.
E231 Animation Software \$49.

ST00 E-Z Color Graphics Board
• With Sound generator & joystick interface.
• MBASIC Graphics Editor on 8" diskette.
E204 Assembled & Tested \$289.

MICROMINT INC. 561 Willow Avenue, Cedarhurst, NY 11516

To Order: Call Toll Free 1-800-645-3479
For Information Call: 1-516-374-6793
Call: Monday-Friday, 9-5 PM

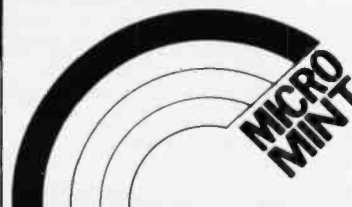

MEGA-BYTES FOR MICRO-BUDGETS

expand your system...shrink your cost.

Why pay more for top quality products when our prices are consistently among the lowest anywhere?
We invite you to compare prices, then call us.

Prices listed are valid thru Sept. 1984. Please call for new prices.

MISC. PERIPHERALS	SALE PRICE
HAYES SMARTMODEM 1200B (IBM-PC).....	\$399.50
HAYES SMARTMODEM 1200 (RS-232).....	489.50
HAYES CHRONOGRAPH.....	189.50
ROLAND DG XY800 6 PEN PLOTTER.....	799.50
BAUSCH&LOMB DMP-29 PLOTTER.....	1885.00
PENCEPT PENPAD 320.....	900.00

EPSON PRINTERS	SALE PRICE
MX-100.....	\$475.00
FX-80.....	489.00
FX-100.....	689.00
RX-80.....	309.00
RX-80 FT.....	375.00
LQ-1500.....	1135.00

DYSAN DISKETTES (Boxes of 10 each)	SALE PRICE
104/1 5 1/4" SINGLE SIDE, SINGLE DENSITY.....	\$31.20
104/1D 5 1/4" SINGLE SIDE, DOUBLE DENSITY.....	32.98
104/2D 5 1/4" DOUBLE SIDE, DOUBLE DENSITY.....	38.99
3740/1 8" SINGLE SIDE, SINGLE DENSITY.....	32.39
3740/1D 8" SINGLE SIDE, DOUBLE DENSITY.....	40.19
3740/2 8" DOUBLE SIDE, SINGLE DENSITY.....	40.19
3740/2D 8" DOUBLE SIDE, DOUBLE DENSITY.....	46.89

COMPUTERS AT LOW PRICES

CALL FOR CONFIGURATIONS AND OPTIONS

MEMOTECH MTX-512
SHARP PC-5000 PORTABLE
LEADING EDGE PC
IBM PC-XT

PRINCETON GRAPHICS SYSTEMS

HX-12 Limit - One to a Customer..... Cash Price \$459.00

GREAT LAKES (PEGASUS) HARD DISK SYSTEMS SALE PRICE

10 MEGABYTE INTERNAL.....	\$1149.00
10 MEGABYTE EXTERNAL.....	1295.00
23 MEGABYTE EXTERNAL.....	1895.00
40 MEGABYTE EXTERNAL.....	2449.00
65 MEGABYTE EXTERNAL.....	3249.00
140 MEGABYTE EXTERNAL.....	4995.00
TAPE DRIVE 23 MEGABYTE INTERNAL.....	950.00
TAPE DRIVE 23 MEGABYTE STAND ALONE.....	1249.00

ORDERS ONLY 800-858-4810
IN CALIF. 800-821-6662



COMMERCIAL BUSINESS SYSTEMS
2858 S. ROBERTSON BLVD., LOS ANGELES, CA 90034



INFORMATION
(213) 559-0596

Phone orders accepted on Visa and Mastercard only. California residents add 6.5% sales tax. No C.O.D. Actual shipping and handling charge added to all orders. Prepaid orders as follows: Money orders or cashier's check—merchandise shipped upon receipt. Personal checks must clear before shipping. 20% restocking fee. Prices and availability subject to change. \$100 minimum order.

LycO Computer Marketing & Consultants

MANNESMANN
SPIRIT 80.....\$299.00
MTL-160L.....\$559.00
MTL-180L.....\$775.00

NEC
NEC8023.....\$369.00
NEC8025.....\$699.00

CITOH
GORILLA GX-100.....\$169.00
GORILLA SERIAL.....\$199.00
PROWRITER II.....\$575.00
8600.....\$899.00
SHEET FEEDER.....\$425.00
620.....\$929.00
630.....\$1699.00
8510 SP.....\$499.00
P510 SCP.....\$559.00
A10 LETTER QUAL.....\$499.00

PROWRITER 8510.....\$335.00
PRINTMASTER.....\$1199.00
STARWRITER.....\$929.00

STAR MICRONICS

GEMINI 15X.....\$379.00
DELTA 10.....\$449.00
DELTA 15.....\$525.00
RADIX 10.....\$575.00
RADIX 15.....\$675.00
POWERTYPE.....SCALL
SWEET P (Model 100).....\$549.00
STX80.....\$149.00

GEMINI 10X
..\$259.00

PANASONIC

1090.....\$279.00
1091.....\$309.00
1092.....\$459.00

SAVE ON THESE IN-STOCK PRINTERS

LEGEND

880.....\$259.00
1000.....\$279.00
1200.....CALL
1500.....CALL
1018.....CALL

BLUE CHIP

M12010.....\$279.00
M12010 C-64.....\$279.00
D4015.....\$1399.00

EPSON

RX-80.....\$269.00
RX-80FT.....\$299.00
FX-80.....\$439.00
FX-100.....\$639.00

OKIDATA

80.....\$199.00
82A.....\$299.00
83A.....\$569.00
84.....\$959.00
92.....\$409.00

SAKATA

SC100 COLOR.....\$229.00
SG1000 GREEN.....\$99.00
SA AMBER.....\$109.00

NEC

JB1260 GREEN.....\$99.00
JB1201 GREEN.....\$145.00
JB1205.....AMBER.....\$145.00
JC1215 COLOR.....\$269.00
JC1216.....\$399.00

AMDEK

VIDEO 300.....\$139.00
VIDEO 300A.....\$149.00
COLOR 1+.....\$269.00
COLOR 11+.....\$399.00

ZENITH

ZVM 122A AMBER.....\$95.00
ZVM 123G GREEN.....\$85.00
ZUM 124IBM-PC.....\$129.00
ZUM COLOR.....\$275.00
ZUM 133 RGB.....\$389.00
ZUM 135 RGB.....\$449.00
ZUM 136.....\$589.00

TAXAN

100 GREEN.....\$115.00
105 AMBER.....\$125.00
210 RGB COMPOSITE.....\$269.00
400 RGB MEDRES.....\$295.00
410 RGB HI RES.....\$349.00
420 RGB HI RES (IBM).....\$475.00
121 GREEN.....\$145.00
122 AMBER.....\$149.00

MONITORS

CATALOG AVAILABLE
HARD DISK DRIVES

10 MEG.....\$975.00
20 MEG.....\$1399.00
30 MEG.....CALL
* D.O.S. EXTRA

DISKETTES ELEPHANT

5 1/4" SSSD.....\$16.75
5 1/4" SSDD.....\$19.95
5 1/4" DSDD.....\$25.95

MAXELL

5 1/4" MD-1.....\$24.75
5 1/4" MD-2.....\$34.75



TO ORDER

CALL TOLL FREE

800-233-8760

Customer Service 1-717-327-1825 Jersey Shore PA 1774C



or send order to
LycO Computer
P O Box 5088

POLICY

In stock items shipped within 24 hours of order. Personal checks require four weeks clearance before shipping. No deposit on C.O.D. orders. Free shipping on prepaid cash orders. * within the continental U.S. PA residents add sales tax. All products subject to availability and price change. Advertised prices show 4% discount offered for cash add 4% for MasterCard or Visa. DEALER INQUIRIES INVITED.

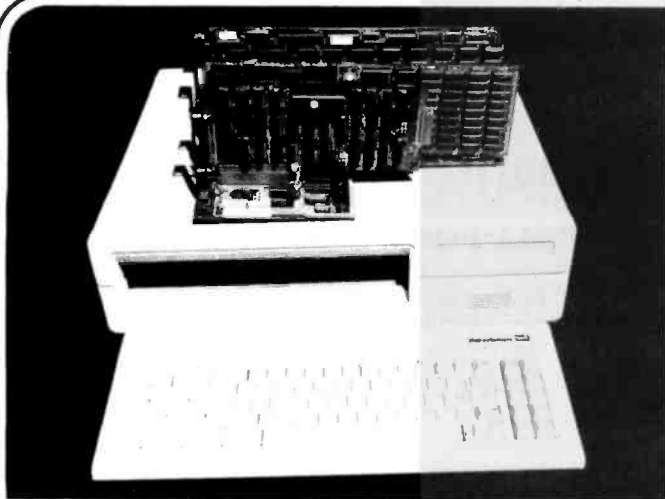

Build Your IBM™ PC Compatible at Competitive Prices

MULTIFUNCTION BOARD

- 2 serial ports, 1 parallel port real time clock, 64k RAM up to 256k RAM **249.00**
- Floppy disk drive controller board **169.00**
- Hard disk controller board **299.00**
- Color graphic board **219.00**
- Monochrome + color + graphic board **329.00**
- Panasonics disk drive, 320k, half height **159.00**
- Hard disk drive 10 MB **699.00**
- 100W power supply with fan **169.00**
- Case **119.00**
- Manual **25.00**
- Keyboard **149.00**
- High resolution color RGB monitor **449.00**
- High resolution green monitor **129.00**
- Monitor stand **19.95**
- Hayes 1200B modem **449.00**
- Hayes 1200 modem **475.00**

MOTHER BOARD:

- 8088 CPU with socket for co-processor 8087
- 8088 is supported by 8259A interrupt controller and 8237 DMA controller
- 2 (two) 28 pin sockets for ROM
- 8 (eight) expansion slots
- No RAM on board (RAM is on multifunction board)

Bare Board	69.00
Ready Board	199.00
(with IC sockets, resistors, capacitors, connectors, crystals, transistors soldered)	
Tested Board (w/o ROM)	399.00
IC kit	199.00

IBM is the trademark of International Business Machines.
Prices subject to change without notice.



4962 El Camino Real • Los Altos, CA 94022
(415) 962-9265 1-(800) 821-3628
TLX: 171947 HANDWELL LTOS

Come visit us in our New York City Showroom

21-55 44th Road
Long Island City, New York 11101, USA
(212) 937-6363

Se Habla Español



Cable: COMSYSTEC NEWYORK
Telex: CSTNY 429418

OUR SPECIALTY: IBM COMPATIBLE PRODUCTS, GRAPHICS, DATABASE, 68000 UNIX, EXPORT

IBM PC & COMPATIBLES
Columbia, Corona, Zenith,
Leading Edge, Televideo, Sanyo,
Tava, & IBM PC

OTHER POPULAR COMPUTERS

Epson, Cromemco, NEC PC,
Altos, North Star, Dual 68000,
DEC Rainbow, OSM

PRINTERS EPSON, OKIDATA full line

Prism 132	200 cps, 132 col.	1,100
Toshiba P1340	80 col., 160 cps.	799
Microprism	110 cps, 80 col. graphic.	379
Dataproduct	8000 series.	CALL
	8010 180 cps, graphic.	545

Letter Quality

NEC 2050	20 cps for IBM PC.	840
3550	35 cps for IBM PC.	1,610
C. Itoh F-10	40 cps.	999
Juki 6100	18 cps.	459
Qume 11/40	w/IBM interface.	1,420
Star Power Type	18 cps.	399
Diablo 630	ECS/IBM ext. char. set.	2,100
Dynas HR35	33 cps.	910
Cromex Comwriter III	740
Transtar 315	graphic, color.	479

Call

AN AFFORDABLE CAD SYSTEM FOR ENGINEERS & DESIGNERS

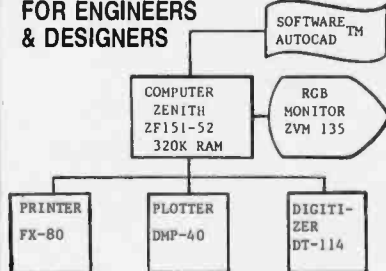

AutoCAD™ is a two-dimensional computer-aided drafting and design system suitable for many applications including drawings for architectural, mechanical, electrical, PCB layout, chemical, structural, and civil engineering.

For the configuration as shown in the above flowchart,

**SPECIAL
CALL FOR \$5,800.00**
(cables included)

Package with 10 MB hard disk also available

***** CALL FOR DETAILS *****

POWERFUL ADD-ON BOARDS

from AST, PERSYST, PLANTRONIC, TECMAR, QUADRAM, HERCULES, TITAN

MORE FOR YOUR IBM PC

MONITORS

(TERMINALS: HAZELTINE, ZENITH, WYSE, VISUAL.)	CALL
Panasonic amber super resolution monitor.	199
Cumrex CR6800 14" RGB high resolution monitor.	489
NEC JC1216 RGB monitor, 640x300 resolution.	435
JB1201 20 Mhz green monitor.	185
Princeton Graphic HX12 RGB monitor.	490
SR12 RGB high resolution monitor.	630
Amdek 300 12" green monitor.	155
Color IV Xtra high resolution monitor, color.	710
Zenith ZVM 123 Green Monitor.	87
ZVM 122 Amber monitor.	135
ZVM 135 RGB monitor for IBM PC.	475

PLOTTERS/DIGITIZERS

Amdek	6-pen X-Y Plotter.	895
Houston Instrument	DMP-29 8-pen X-Y Plotter.	1,795
	DMP-40 1 pen plotter.	795
	DMP41, DMP42 22x34", 24x36" plotter.	CALL
	DMP-51, DMP-52 22x34", 24x36" plotter.	CALL
	HIPAD DT-11AA Digitizer.	725
	HIPAD DT-114 4-button digitizer.	CALL
Hewlett Packard	7470A 2-pen plotter.	940
	7475A 6-pen plotter.	1,640
Calcomp M84	8-pen plotter.	1,650

MODEMS

HAYES	Smartmodem 300/1200 bps.	499
	1200B modem for IBM PC.	CALL
USR	300/1200 bps w/64K, parallel port.	550
	Password 300/1200 bps modem.	339
NOVATION	Smartmodem 300/1200 bps modem.	415
	PC Cat 300/1200 bps modem.	450

Prices subject to change. American Express, Visa/Mastercard add 3%. F.O.B. point of shipment. 20% restocking fee for returned merchandise. Personal checks take 3 weeks to clear. COD on certified check only. N.Y. residents add sales tax. Manufacturers' warranty only. International customers, please confirm price before order. Accept P.O. from Fortune 500, schools and gov't.

Computer Channel
21-55 44th Road
Long Island City, NY 11101
For Information CALL (212) 937-6363
To order CALL 1-800-331-3343

TELEX:
429418
CSTNY

AB Computers

THE VALUE LEADER SINCE 1976

COMPUTERS

IBM—Popular IBM options from AB include the PC, PC XT and our special PC+ package:

Computer	Ram	Drive	Ports	Price
IBM PC	256K	360K	0	CALL
IBM PC +	256K	3.3 MB	0	CALL
IBM PC XT	256K	10 MB (Hard)	1PL/2 SER	CALL

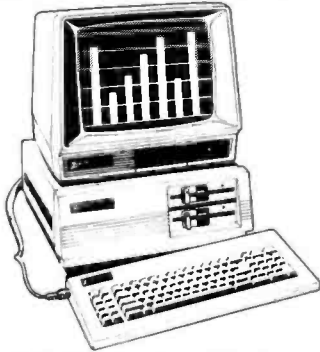

Zenith—All Zeniths fully software & hardware compatible with the PC and XT superior keyboard:

Computer	Ram	Drive	Ports	Price
ZF 151-21	128K	360	1PL/2 SER	\$1649
ZF 151-52	320K	720	1PL/2 SER	2099
ZW 151-52	320K	10.6 MB + 360	1PL/2 SER	3375
ZF 161-52*	128K	360	1PL/2 SER	1799
ZF 161-52*	320K	720	1PL/2 SER	2249

Sanyo—We have Sanyo 550 & 555 PC's. Built-in software includes MDOS Version II, Wordstar, CalcStar, Basic, more. Great Prices.....CALL

DISKS AND ACCESSORIES

VERBATIM—Verbatim DATALIFE Minidisks are super quality, super durable. Price per 5 1/4" mindisk (sold in boxes of 10)

	Qty. 10	Qty. 50	Qty. 100
SS/DD	1.95	1.90	1.85
DS/DD	2.60	2.55	2.50

* AB'S OWN DISKETTES—Top disk quality at a low, low price buy 100 (DS/DD) and pay only \$1.35 per disk.

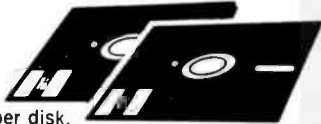

Plus, before September 30, get a free Amaray Mediamate 5 disk file in the bargain!

AB carries all major brands 3M, Verbatim, Maxell, Wabash, BASF, Sentinel, Dysan... in all popular sizes and configurations CALL for super prices.

DISK STORAGE

Mini Flip 'N File (50 5" disks).....	\$17.45
Rolltop 100 (100 disks, 10 dividers).....	28.99
Mini Kas-ette/10 (for 5" disks) 1/2.25 10/2.05 ea	

* Amaray Mediamate 5 'til Sept. 30, only 11.99

PLUS—

"HEAD" disk cleaning kit (w/2 disks)	11.99
IBM drive analyzer.....	22.50

(includes diagnostics and head analyzer)

COMMUNICATIONS

Anchor Mark XII Smart modem	\$270.
Hayes Smartmodem 1200B	459.
<small>(includes Smartcom II software)</small>	
"Crosstalk" software	135.
AB communication software	29.
<small>(works with Anchor Hayes others)</small>	

SOFTWARE

Lotus 1-2-3	\$345.
Lotus Symphony	479.
Multi-Mate	325.
Multiplan (Microsoft)	179.
Wordstar	335.
dBASE II (Ashton-Tate)	CALL
dBASE III (Ashton-Tate)	CALL
Microsoft "WORD" (with MOUSE)	325.
Peachtree Peachtext 5000	189.
<small>(includes word processor thesaurus spell checker list manager spreadsheet, more.)</small>	
Peachtree MS-DOS	
Gen'l Ledger 8	349.
Accts. Receivable 8	349.
Accts. Payable 8	349.
Inventory 8	349.
Sales Invoicing 8	349.
Payroll 8	349.

Spinnaker Software—full line for IBM PC. CALL

UNIX (Mark Williams)

COPY PC (lets you copy protected disks for back-up Personal use only)

PLUS many other software specials.....CALL

FREE CATALOG!

This ad space can accommodate only a few of the exceptional values available from AB. Our latest catalog is packed with fantastic buys, top brands, thousands of items. For a free copy call or write.

MONITORS

USI—20 MHz band width, 1000 lines resolution. Easily capable of 80 character display.

* 1200G (Pi-2)—12" green phosphor SPECIAL \$85.

* 1200A (Pi-3)—12" amber phosphor SPECIAL 89.

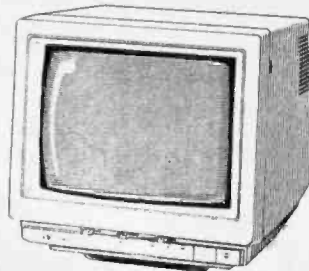

AMDEK

Video 310A—12" amber, 18 meg. TTL-IBM. \$155.

Color II+—13" RGB TTL input

ZENITH

ZVM-124—12" amber, 22 MHz, TTL for IBM

ZVM-135—High res. RGB + composite monitor

ZVM-135-1—Cable for RGB monitor

OUTPUT DEVICES

Printers by Star, Epson, Okidata, Brother:

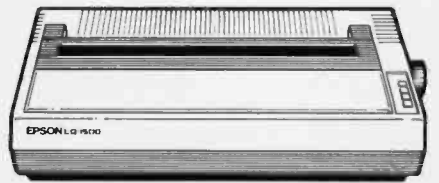

Star Micronics Gemini 10X

10 carriage, #PT 120 CPS

Epson LQ-1500- NEW 24-pin

letter quality dot matrix

Epson RX-80—1.4" for feed, GaltraX

Okidata 92

Brother HR-25 Daisywheel—23 CPS Bi-Directional

Brother HR-15 Daisywheel—13 CPS Bi-Directional

PLOTTERS BY AMDEK, SWEET-P:

Amdek Amplot II—Six Pen

* SWEET-P 100—Single Pen (with 3 color pens)

SPECIAL 539.

* SWEET-P 600—Six Pen

SPECIAL 939.

Microfazer Printer Buffers (Quadram):

MP Parallel 8K-\$145, 16K-\$155, 32K-\$175, 64K-\$205

IBM Parallel Printer Cable

INPUT DEVICES

* OBERON Optical Scanning Wand—Now, scan typed lines for fastest input. Handles 10 pitch characters, most common fonts. Great for mail list updates, much more. RS-232

Zenith keyboard

Keytronics 5150 keyboard

/ETC.

* Data Technology "TEAM MATE" drive—super new system using Kodak disk technology breakthrough. Puts 3.3 MgB on 5 1/4" floppy, formats to 2.8. For PC XT owners, an alternative to hard disk. 4 disks back-up 10 megabytes.....CALL

Panasonic, Amdek, Hitachi & Others—1/2 height, double side drives

* Great Lakes Winchester (10 MB, Tandem)999.

Quadronics Quadboard—Parallel port, serial port, clock/calendar.

No RAM-\$229, w/64K-\$279, w/384K-\$499

Hercules graphics board

Votrax speech synthesizers—Personal Speech System

AST—full line of IBM cards & boards.....CALL

AST—full line of IBM cards & boards.....CALL

POWER DEVICES

Datashield back-up power source

200 PC-200 watt

300 XT-300 watt

"BITS" Power back-up-250W. True uninterruptible695.

Brooks power strip BN6-6

AB SATISFACTION GUARANTEE

Every product sold by AB Computers is factory packed and comes with the manufacturers warrantee. However, if an item is defective when received, you may return it to us within 15 days for repair, adjustment or replacement at our option. Returns must be accompanied with copy of your invoice, letter detailing defect, blank warrantee card and all original factory packing. To expedite handling, please call for return authorization number. (Sorry, no returns on computer software, once opened.)

Ordering Information: Prices shown include cash discount. Add 3% for credit card purchases (Mastercard or VISA). Personal checks take 15 days to clear; no waiting on certified checks or money orders. Add \$1.50 shipping and handling on all orders. Mail, APO/FPO, Air may require additional charges. PA residents add 6% sales tax. All items subject to availability. Prices subject to change. Additional discounts available to qualified educational institutions.

AB Computers

THE VALUE LEADER SINCE 1976

252 BETHLEHEM PIKE

COLMAR, PA 18915

OR USE OUR ORDER LINE, MONDAY-FRIDAY

9 A.M. — 6 P.M. EST

215-822-7727

Sav-On Computer, Inc.

ORDER DESK
TOLL FREE

800-345-7100

OUTSIDE
CALIF.

CUSTOMER
SERVICE
ORDERS
INSIDE CALIF.

213-675-2115

IBM COMPONENTS

AST RESEARCH

6 Pac Plus (64K)	\$269
IO Plus	119
Mega Plus	269
Mega Pac	269
Additional Ports	44

QUADRAM

Quad Color 1	\$218
Quad Color 2	228
Quad Board I	238
Quad Board II	268

IBM

Color Card	\$244
Monochrome Card	318

HERCULES

Graphics Card	\$339
---------------------	-------

USI

Paradise System Multi Display Card	\$399
---	-------

PLANTRONICS

PC +, w/Software	\$388
------------------------	-------

MEMORY

64K Upgrade	\$49
128K Upgrade	95

MATH CO-PROCESSOR

Intel 8087	\$175
------------------	-------

KEYTRONICS

5150 Keyboard	\$189
5151 Keyboard	239

TG

Joy Stick	\$39
-----------------	------

KOALA

Graphics Tablet	\$89
-----------------------	------

COMPUTERS

SANYO

MBC550	CALL
MBC550-2	Priced Too Low
MBC555	To List.
MBC555-2	

COMPAQ

Portable (1 Drive & 128K) ..	\$1975
Portable (2 Drives & 256K) ..	2375
Compaq Plus	Call

IBM

IBM PC	CALL
IBM PC/XT	We Will Try To Beat
IBM Portable	Any Advertised Price

KAYPRO

Kaypro II	\$1148
Kaypro 4+	1694
Kaypro 10	2494

APPLE

Apple IIe (Starter System) ..	\$1325
MacIntocsh	2294
Apple IIc	Call

FRANKLIN

ACE 1000	\$789
ACE 1200-OMS	1589

COLUMBIA

1600-1	\$2594
1600-4	3874

5 1/4 DISK DRIVES

TANDON

100-2	\$209
101-4	279
55-2	219

TEAC

55B	\$168
55A	160
55F	199

MPI

B52	\$189
-----------	-------

SHUGART

SA455	\$219
SA465	229

CDC

9409	\$228
9409T	299

MICROSCI

A-2	\$199
-----------	-------

MODEMS

HAYES

300	\$205
1200	488
1200B	399
Micro Modem (IIe)	238

ANCHOR

Mark VII 300	\$94
Mark XII 1200	268

NOVATION

Access 123	\$448
J-Cat	129

RIXON

PC212A (1200SA)	\$408
P212A (IBM PC)	408

U.S. ROBOTICS

Password (1200B)	\$339
------------------------	-------

APPLE COMPONENTS

TG

Joy Stick	\$39
Select Port.	39
Paddles	39

MICROTEK

Bam 16	\$58
Ser. Int.	89

MICROSOFT

16K Card	69
Soft Card	239

KENSINGTON

Sys Saver	\$69
-----------------	------

MICROMAX

View Max 80 (80 Col. Card) ..	\$138
View Max 80E (for IIe)	128

TERMS

We accept Visa, MC, CODs, Wire Transfers. No Surcharge for Credit Cards. UPS, Federal Express, Emery shipping available. CA residents please add 6 1/2% sales tax to order. Prices subject to change without notice. Not responsible for typographical errors.

SAV-ON IS SETTING THE NEW PACE IN LOW PRICED COMPUTER PRODUCTS
We Could Now Be The Largest
 WE WILL TRY TO MATCH OR BEAT ANY ADVERTISED PRICE ON ANYTHING

5 1/4 DISK DRIVES

QUENTIN RESEARCH

Apple Mate \$194

RANA SYSTEMS

Elite I \$240

Elite II 335

Elite III 455

DISK DRIVE CONTROLLERS

Rana (Controls 4) \$89

Maynard 160

Maynard (w/Serial Port) 230

Maynard (w/Parallel Port) 210

Quentin 65

Vista 219

DISKETTES

MAXELL

5 1/4 DS/DD \$37

5 1/4 SS/DD 24

DATA LIFE

5 1/4 SS/DD \$22

5 1/4 DS/DD 30

DYSAN

5 1/4 SS/DD \$32

5 1/4 DS/DD 38

DISKETTES

GENERIC

Box of 10 DS/DD \$20

WE CARRY MUCH MORE THAN ADVERTISED • GIVE US A CALL TODAY!
Single Computer Outlet!!!
NO GIMMICKS • NOTHING FREE • JUST LOW PRICES AND FIRST CLASS SERVICE

PRINTER INTERFACES

CABLES

IBM to Printer \$26

Kaypro to Printer 26

Centronics to Centronics 26

RS232 Cable 26

FOURTH DIMENSION

Card & Cable \$48

MICROTEK

Dumpline GX \$88

Dumpline GX EXP to 64K 148

16K Upgrade 14

OKIDATA OPTIONS

Tractor for 82 & 92 \$59

Serial Interface 98

ORANGE MICRO

Grappler + \$113

Grappler + w/16K 178

PRINTERS

DYNAX

Dynax (Parallel) \$469

Dynax DX15 (Serial) 525

Dynax DX25 728

STAR MICRONICS

Gemini 10X Call

Gemini 15X Call

Power Type \$478

OKIDATA

82A (120cps, Parallel and Serial Interface) \$298

83A (15" Carriage) 568

84P (200cps, Friction and Tractor) 989

92P (160cps) 428

93P (160cps, 15" Carriage) 738

EPSON

RX80 (120cps) \$318

RX80FT (120cps, Friction and Tractor) 418

FX80 (160cps) 518

FX100 (160cps, 15" Carriage) 728

NEC

8023A-C (120cps) \$398

8025 (15" Carriage) 698

JURY

6100 (18cps and Letter Quality) \$448

DISK DRIVE CABINETS

PC PRODUCTS

5 1/4 Single Cabinet w/Supply ... \$69

5 1/4 Dual Thinline Cab. w/Supply . 79

5 1/4 Dual Cabinet w/Supply 79

MONITORS

USI

PI 1 (9" Amber) \$119

PI 2 (9" Green) 129

PI 3 (12" Amber, 20 MHz) 118

PI 4 (12" Green) 124

PRINCETON GRAPHICS

HX12 \$469

SR12 649

Max12 199

IBM

Color \$699

Monochrome 319

AMDEK

300G \$139

300A 149

310A (Monochrome) 178

Color I+ (Composite Video) ... 289

Color II+ (RGB Video) 418

ZENITH

ZVM122 \$108

ZVM123 108

BMC

12AUW \$78

12EUN 108

9191 (Color) 238

TAXAN Call SANYO Call

HITACHI Call

GORRILLA

Green \$109

Amber 109

Sav-On Computer, Inc.

Circle 159 on Inquiry card.

12595 CRENSHAW BLVD., HAWTHORNE, CA 90250

OPEN: 7:30am till 6:00pm Mon.-Fri.
9:00am till 2:00pm Sat.



IBM COMPATIBLE

A word for this Punch/Reader Combo is

Speed! Model 510 punches paper tape at 110cps, reads at 150cps. This rugged machine is computer compatible offering RS232C, current loop, parallel inputs. The ASCII-to-Baudot code conversion permits direct keyboard entry for Telex/TWX transmission. Plus: 256 character storage, 75-9600 baud rate, 5-8 level tape, stock. ADDMASTER CORP. 416 Junipero Serra Dr., San Gabriel, CA 91776 * 213/285-1121.

FORTRAN OR PASCAL PROGRAMMER?

READ
THIS
AD



PRINTER RIBBONS

	PRICE	PER RIBBON	PER DOZEN
ANADIX 9500	10.50		109.80
APPLE DMP	5.25		52.20
C. ITOH PROWRITER	5.25		52.20
EPSON MX-FX 70/80	5.00		48.00
EPSON MX-FX 100	6.75		69.00
GEMINI 10-10X-15-15X	2.50		23.40
IBM HARMONICA 1/2"	6.75		78.00
IBM HARMONICA 3/4"	7.95		92.40
IBM 4-COLOR	15.75		180.00
IDS MICROPRISM-480	5.75		58.80
IOS PAPER TIGER 460/560	6.75		78.00
IDS PRISM	7.95		92.40
IDS 4-COLOR	15.75		180.00
NEC - 3500 M/S Non Flip	6.25		69.00
NEC - 3500 NYLON	9.00		96.00
NEC PC-8023A	5.25		52.20
OKIDATA 80/82/83/92	2.50		23.40
OKIDATA - 84	5.00		57.00
RADIO SHACK DMP-2100	7.50		87.00
RADIO SHACK LP VI & VIII	5.75		58.80
SILVER REED EX 550 S/S	5.00		57.00
SILVER REED EX 550 NYLON	9.00		105.00
TOSHIBA - 1350	7.50		87.00
XEROX 610/620 M/S	5.95		66.00

Add \$3.00 Ship. & Hand. — To Order Call
Toll Free 1-800-742-1122
In MI (313) 569-3218 or Write for our Catalog

DWIGHT COMPANY, INC.

15565 Northland Drive - West Town
Southfield, Michigan 48075-6496

Circle 4 on inquiry card.

Circle 51 on inquiry card.

MAKE YOUR OWN BANNERS



IBM MICRO, COMPATIBLES & APPLE IIe OR III USERS -

Easy to use software works with PC-DOS 1.1 (IBM or compatible) or DOS 3.3 (Apple) and printer. Prints high resolution font - all ASCII characters.

ONLY \$24.95

To order phone our Order Desk at (217) 359-5888 and use your Mastercard or Visa or send check or money-order for \$24.95 (IL Residents add 6% tax) plus \$2.50 for postage and handling to: Advanced Analytics Technology Corp. Business and Technology Center 701 Devonshire Dr. C-30 Champaign, Illinois 61820

* Apple is a registered trademark of Apple Computer Inc.

GRAPHICS

- Text/graphics generics
- 2D interactive
- 2D plots (full support) including auto-scaling, auto-axis generation, auto-labeling, tabular/log/parametric curves, splines, bars, pies, you name it, we have it.
- 3D Plots incl. 2 hidden line removal options—not just old-fashioned wire frame.

PEN PLOTS

- Standard plotter primitives plus
- FULL 2D support plus
- Interface to screen graphics,
- Limited 3D.

Clear and complete documentation.

GRAFMATIC \$135.

PLOTMATIC 135.

MICROCOMPATIBLES

11443 Oak Leaf Drive
Silver Spring, MD 20901
(301) 593-0683

Circle 115 on inquiry card.

SL-MICRO

STATISTICAL LANGUAGE
for MICROCOMPUTERS

features

VALUE and VAR LABELS
DATA TRANSFORMATION
FREQUENCIES CROSSTABS
PEARSON CORR REGRESSION
CONDESCRIPTIVE

Only \$250. Manual \$15
Available for IBM PC, CP/M
or MS-DOS. Many Formats.

QSC BOX 23056
LANSING, MI 48909
PHONE (517) 641-4428

Circle 153 on inquiry card.

d BASE III

(IBM PC) **\$365.00**

FRAMEWORK

(IBM PC) **\$450.00**

d BASE II **\$265.00**

VISA/MC WELCOME

Cabrillo Software

a division of Cabrillo Computer Service

484 Mobil Ave., Suite 42
Camarillo, CA 93010

(805) 484-5353 in Calif.

(800) 321-5753 in USA

SPECTACULAR



LOWEST PRICES

maxell DISKS

LIFETIME WARRANTY

\$180 ea MD-1 5 1/4" (SS/DD) Qty 20 **\$240** ea MD-2 5 1/4" (DS/DD) Qty 20

5 1/4" MDI-DDM SS/DD/96TPI .. \$2.65

5 1/4" MD2-DDM DS/DD/96TPI .. \$3.30

8" FD-1 SS/SD or DD .. \$2.85

8" FD-2 DS/DD .. \$3.30

1-800-328-3472

Dealer inquiries invited. COD's and charge cards accepted. All orders shipped from stock within 24 hrs.



North Hills Corporation

3564 Rolling View Dr.
White Bear Lake, MN 55110
MN Call Collect 1-612-770-0485

Circle 124 on inquiry card.



DUST COVER PROTECTION WITH ANTI-STATIC, LINT FREE NYLON PACK CLOTH

IBM PC™ Keyboard	14.00
IBM PC Monitor	16.00
IBM PC Drive	16.00
IBM PC Mon./Dr. Comb. (1 pc.)	28.00
IBM Graphics Printer	16.00
Apple IIe Comb.	28.00
Apple Printer Image Writer	16.00
Apple Disk II™ . 9.00 . . 2 stacked	14.00

Silver Gray with Black Trim

CHECK/VISA/MC

Plus \$2 Ship. & Hand. — R.I. Res. Add 6% Sales Tax

ComputerAid

P.O. BOX 293, BARRINGTON, R.I. 02806
FOR QUANTITY DISCOUNTS (401) 245-0532

Circle 38 on inquiry card.

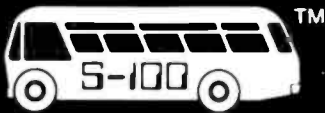

S-100
ESTABLISHED 1977

SALES 800 - 528-3138
TECHNICAL 602-991-7870
MODEM ORDERS 602-948-1387
TELEX: 16 5025 FTCC SEC PHX.

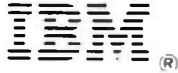

BUILD YOUR OWN P.C.

- IBM-PC W/ 64K RAM, PC-DOS 2.1, 1 DSDD DRV. & CONTROLLER W/ K.B. \$1,896
- 1 TANDON TM 100-2 DSDD DRV. \$189
- STB GRAPHICS PLUS II MONO. & COLOR GRAPHICS W/ CLOCK, PRT PORT \$322
- 64K RAM 4164-150 NS 9 CHIPS/SET \$49.95
- U.S.I 20MHz 12" AMBER MONITOR \$109
- PGS HX12 HI-RES RGB MONITOR \$495
- INTEGRATION, BURN-IN & TEST \$95
- 5Mb REMOV. CARTRIDGE H.D. IN P.C. (WILL BOOT FROM THE HARD DISK) \$1,249

TECMAR FOR IBM-PC

- CAPTAIN 64K, IS, IP, CLK/CAL \$272
- CAPTAIN ABOVE W/ 384K \$557
- 1st MATE 64K, IS, IP, CLK/CAL \$272
- 1st MATE ABOVE W/ 265K \$412
- WAVE 'XT' MEMORY 8D 64K \$209
- WAVE ABOVE W/ 256K \$349
- DYNAMIC MEMORY W/ 256K \$342
- INTERNAL REMOV. H.D. IN PC - INSTALLS DIRECTLY INTO PC, STORES 30X MORE THAN FLPYS & IS 9X FASTER \$1,496
- 10Mb H.D. IN MINI-CAB. - HIGH DENSITY PRIMARY STORAGE, 4 CONFIG. POSS., STORES 30X MORE THAN FLPYS. \$1,871
- 5Mb REMOV. H.D. & 33Mb IN EXPAN. CHASIS - HIGH DENSITY PRIMARY STORAGE, MANY CONFIG. POSS., STORES 100X MORE THAN FLPYS., 5 ADDITIONAL SLOTS FOR OPTS. \$4,121
- 5Mb REMOV. H.D. MEDIA \$85
- EXPANSION CHASSIS W/ 8 SLOTS \$709
- 5" & 8" FLYP ADAPTOR - SS or DS, SD OR DD, COMPLETE SFT SUPPORT GRAPHICS MASTER - HIGH RES. COL. (640X400), MONO (720X700), RGB, NTSC COMPOSITE & IBM MONO. MON., 128K, LT, PEN INTERFACE \$521
- 2ND MATE MULTIFUNC. BD. - 2S, 2P, C, VEC, INTERRUPT., PAL LOCK-OUT OPT. \$221
- BOSUN "XT" MULTIFUNC. BD. - IS, IP CLK/ CAL, PAL LOCK-OUT OPT, AUTO-TIME & RAMPOOLER SFT. \$146
- SCRIBE TENDER - IP & IS CABLE, IP & 2S PORTS, MULT. I/O CAPABILITIES \$176
- TIME MASTER - SETS TIME/DATE AUTO., 5 YR BATT, ALARMS AVAIL. \$101
- EXTENDER 8D. \$60
- jrCAPTAIN 64K P. C. 1 YR BATT LIFE \$255
- jrWAVE 64K \$239
- jrCADET 64K ADD ON PIGGYBACK BD. FOR jr CAPTAIN/WAVE \$159
- jr 2ND MATE 64K, P. C. 1 YR BATT LIFE \$119

Mac Drive

- 73200 - 10Mb FIXED H.D. \$1,496
- 73020 - ABOVE W/ 5Mb REMOV. H.D. \$2,468
- 73010 - 5Mb REMOV. H.D. \$1,496
- 73210 - 2.5Mb REMOV. H.D.'s \$2,468

COLUMBIA

- 1600-1 W/ K.B. 5150, U.S.I. 12" AMBER MONITOR \$2,549
- 1600-4 ABOVE W/ 12Mb H.D. \$3,995
- 1600-VP PORTABLE \$2,295
- PRINCETON GRAPHICS HX-12 HI-RES RGB MONITOR \$495

- Votrax** PERSONAL SPEECH SYSTEM \$285



- MULTI-FUNC. ADD-ON CARDS:
IBM PC I/O PLUS II (W/ SUPER DRV/ SPOOL) "I/O-PG" C, IS, IG, IP \$225
IBM PC MEGAPLUS II (W/ SUPER DRV/ SPOOL) "MGII-064PG" 64K, C, IS, IP, IG \$421

- MEGAPLUS II FIELD EXPAN. OPTIONS:
MPK-256 EXPANDS FROM 256K-512K \$336
IBM PC COMBOPLUS (W/ SUPER DRV/ SPOOL) "MC-064SPC" 64K, C, IS, IP \$336

- IBM PC SIX PAK PLUS "SPK-064G" 64K, C, IS, IP, IG \$378

- IBM PC EXPAND MEM. (W/ SUPER DRV/ SPOOL) "MP-064" 64KB PARITY \$251

- IBM PC ADVANCED COMMUN. PRODUCTS:
AST-3780 BISYNC EMUL. \$803
AST-SNA SNA/SDLC EMUL. \$761
AST-5251 5251 EMUL. \$761
AST-3270 BSC 3270 BISYNC \$761



- RIO PLUS: RS232 S, P I/O, G, CLK/ CAL. 64K & PC ACCEL. \$257
STB-RIO+64 ABOVE W/ 256K

- GRAPHIX PLUS: RGB & MONO., P, LT, PEN INTER., CLK OPT, STB-CLR \$259
GRAPHIX PLUS II: RGB & MONO., PRINTER & LT. PEN PORTS \$325

- SUPER RIO: RAM-10 MULTI-FUNC. W/ 64K (UPGRD TO 768K), 2S, 1P (IBM COMPAT.) 1G, CLK/ CAL. \$273
STB-SRIO-64 \$162
STB-PB-64 PIGGYBK (EXPAND. TO 512K)

- SUPER I/O: 4 FUNC. - WILL FIT XT, RS232 S, 1P, 1G, CLK/ CAL STB-SI/O \$149
PC ACCELERATOR: COMB. DISK EMULATOR & SPOOLER SFT. STB-PCA \$52
MEMORY EXPAN. BD: 64K (EXPAND TO 384K) STB-164 \$192



STAND-BY POWER W/ YUASA BATTERY

- SB-400-LVC 1HR+ @ 400 WATTS \$395
SB-1000 1/2HR+ @ 1000 WATTS \$695

- ISOBAR LINE FILTERS:
IBAR 2-6 2 OUTLETS & 6 FT. CORD \$40
IBAR 4-6 4 OUTLETS & 6 FT. CORD \$60
IBAR 8-15 8 OUTLETS & 15 FT. CORD \$75



- HAYES COMMAND COMPATIBLE W/ HELP MENU \$329



U.S. ROBOTICS

FREE TELPAC SOFTWARE INCLD.

- TELPAC MSDOS/IBM-PC \$79
- PASSWOP 1200 AUTO ANS./DIAL \$359
- AUTO DIAL 212A (HAYES COMPAT.) \$459
- IBM PERSONAL MODEM W/ SOFTWARE \$297
- IBM PERSONAL MODEM W/ 64K, PRT PORT, CLOCK, S.W. \$469
- IBM PERSONAL MODEM W/ 256K, ETC. \$759

TERMINALS & MONITORS

- COMREX CR6600-Y, HI-RES, P-39 \$125
- PRINCETON GRAPHICS HX12 HI-RES RGB \$495
- TAXAN RGB 420 (IBM LOOK-ALIKE) \$495
- USI AMBER 12" HI-RES MONITOR (20MHz) \$109

DISK DRIVES

- MAXTOR XT-1065 5 1/4" 65Mb H.D. \$2,249
- QUANTUM Q640 5 1/4" 40Mb H.D. \$1,395
- SEAGATE ST419 5 1/4" 20Mb H.D. \$1,195
- SEAGATE ST212 5 1/4" 1/2HI 12Mb 5 1/4" H.D. CNTRL FOR IBM-PC SUPPORTS ST506 INTERFACE DRIVES \$319

ASK ABOUT SUBSYSTEMS FOR IBM Tandon 100-2 5 1/4" DSDD \$189

Qume 6 MONTH WARRANTY
142 DSDD 5 1/4" 1/2 HI \$179

TOSHIBA
FOR IBM-PC & PORTABLE
HIGHEST ENGINEERING QUALITY
5 1/4" 1/2 HI FLYP, DIRECT DRV. 1 YR WARR. \$155



- MD1D 5 1/4" SSDD 80X/10 \$19.95
- MD2D 5 1/4" DSDD BOX/10 \$28.95
- MD2D 96PTI 5 1/4" DSDD 80 TRACKS 80X/10 \$35.95
- FD2D-1024N 8" DSDD BOX/10 \$33.95

DATA MAG "DYSAN QUALITY" ECONOMIC PRICE
5 1/4" SSDD SOFT BOX/10 \$15.95
5 1/4" DSDD SOFT BOX/10 \$21.95

SOFTWARE

- ACCOUNTING PEARL FOR IBM-PC \$635
- COMP. INNOVAT. "C" COMPILER \$299
- COMPUVIEW TRANSYS MS DOS - CP/M86 FILE TRANSFER \$159
- COMPUVIEW VEDIT-86/MS-DOS \$185
- KNOWLEDGEMAN 8086 DATA BASE MGR. \$345
- LOTUS 1-2-3 \$369
- MICROSOFT'S BASIC COMPILER \$292
- PERSONAL PEARL DATA BASE MGR. \$215
- SORCIM SUPERCALC-3/IBM-PC \$245



- MICRO PRO PRO-PAK W.S., S.S., M.M., STAR INDEX \$399
- MICROPRO CORRECT STAR \$135

DIGITAL RESEARCH

- PERSONAL BASIC \$109
- CBASIC INTERPRETER \$149
- CBASIC COMPILER \$439
- "C" LANGUAGE COMPILER \$259
- PASCAL MT+ \$295
- SPEED PROGRAMMING PKG. \$149
- PL/1 W/ PROG. UTILITIES \$649
- CI\$ COBOL \$625
- LEVEL II COBOL \$1,169
- LEVEL II ANIMATOR \$689
- FORMS 2 \$149
- DR ASSEMBLER PLUS TOOLS \$149
- ACCESS MANAGER \$295
- DISPLAY MANAGER \$369
- MICRO/ SPF \$329
- SELECT WORD PROCESSOR \$365
- CONCURRENT CP/M W/ WINDOWS \$109
- CP/M-86 \$44
- DR. LOGO \$75
- PC ACCOUNTING PACK W/ CCP/M \$697

Subject to Available Quantities
Prices Quoted Include
Cash Discounts
Shipping & Insurance Extra

S-100 DIV./696 CORP.
14425 North 79th Street
Scottsdale, Arizona 85260

FULL DEALER SUPPORT
VISIT OUR SHOWROOM
Hrs. 8:30AM - 5:00PM M-F

Circle 189 for Dealer inquiries, Circle 190 for End-User inquiries.

**35mm COLOR SLIDES
FROM YOUR PC**



\$ 49.95 + \$ 3.00 Shipping and Handling
Check or Money Order

- Allows CRT photos in full room light
- Eliminates reflections
- Makes slides or prints
- Easy to use
- Maintains accurate focus distance
- Attaches to your 35mm camera
- Fits CRT image up to 7¼" x 10¾"
- Specify lens thread size

49mm 52mm

SECTOR SYSTEMS CO.
P.O. Box 751, Marblehead, MA 01945
(617) 631-2878

Circle 160 on inquiry card.

? HELP-WP

**▶ ATTENTION
WRITERS:**

**BLACK &
WHITE**

- ▶ Allows user to see 12 PAGES OF LAYOUT ON THE SCREEN AT THE SAME TIME!
- ▶ Works with DOS format text files from most word processors and editors on the IBM PC, XT, & Jr.
- ▶ Configures to the major printer control commands of your word processor.
- ▶ Faster than printing—saves time and paper.
- ▶ An indispensable aid in formatting tables and illustrations.
- ▶ Print layouts on the Epson printer equipped with graphics option.
- ▶ Color - Graphics adaptor required.

25.00 check or money order
CHELSEA-SKYE
PO BOX 634
SOCORRO, NM 87801

Circle 32 on inquiry card.

SPECTACULAR



LOWEST PRICES

3M DISKETTES

LIFETIME WARRANTY

\$ 168 ea 5¼" SS/DD (744) Qty 20 **\$ 219** ea 5¼" DS/DD (745) Qty 20

- 5¼" SS/QD/96TPI ... \$2.55
- 5¼" DS/QD/96TPI ... \$3.20
- 8" SS/SD ... \$2.00
- 8" SS/DD ... \$2.45
- 8" DS/DD ... \$2.95

1-800-328-3472

Dealer inquiries invited. COD's and charge cards accepted. All orders shipped from stock within 24 hrs.



North Hills Corporation
3564 Rolling View Dr.
White Bear Lake, MN 55110
MN Call Collect 1-612-770-0485

Circle 125 on inquiry card.

FREE SOFTWARE

RENT THE PUBLIC DOMAIN!

User Group Software isn't copyrighted, so no fees to pay! 1000's of CP/M and IBM software programs in .COM and source code to copy yourself! Games, business, utilities! All FREE!

CP/M USERS GROUP LIBRARY

Volumes 1-92, 46 disks rental—\$45

SIG/M USERS GROUP LIBRARY

Volumes 1-90, 46 disks rental—\$45

Volumes 91-172, 40 disks rental—\$45

SPECIAL! Rent all SIG/M volumes for \$85

MOST FORMATS AVAILABLE! SPECIFY.

IBM PC-SIG (PC-DOS) LIBRARY

Volumes 1-135, 5¼" disks \$135

Public Domain User Group Catalog Disk \$5 pp. (CP/M only) (payment in advance, please)
Rental is for 7 days after receipt, 3 days grace to return. Use credit card, no disk deposit.

Shipping, handling & insurance—\$7.50 per library.

(619) 941-0925 information,

(619) 727-1015 anytime order machine

Have your credit card ready!

Public Domain Software Center

1533 Avohill Dr.
Vista, CA 92083



Circle 144 on inquiry card.

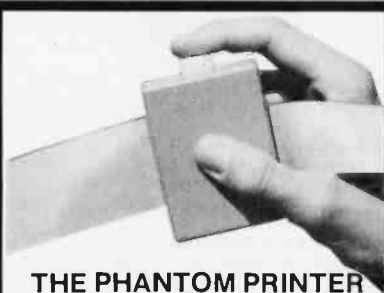

THE PHANTOM PRINTER

Press the switch - the computer "prints" to the Phantom Printer at blazing speed. You can stop the real printer, even disconnect and carry it away. Press the switch again - it's a regular printer cable. Just **\$49.95**. Call now Toll Free 1-800-824-7888. Ask for Operator 157 (AK. HI 1-800-824-7919) visa/mc 24hrs

Avocado Computer
17352 Yorkshire Ave.
Yorba Linda, CA 92686
714-528-1025

Circle 15 on inquiry card.

→ All **LOMAS DATA PRODUCTS** ←

16-Bit, S-100 Bus: Systems & Boards

*** **FIREBALL DISCOUNTS** ***

25% off List Price (UPS extra) for Cashier's Check or Money Order

+++

You save **MONEY** = We save **TIME**

+++

See → **LOMAS** ← ad in **BYTE**

or request complete specifications

⚡

↳ **LIGHTNING SPEED** /

80286-CPU & 80287-NDP: \$1468.75

!! **THUNDERING PERFORMANCE** !!

80186 & I/O & 256K-DRAM & 5.25"/8"

disk controller & CCP/M-86: \$1196.25

Configured for **SanTec-S700** printer:

TeleVideo-GA970C VDT: \$1121.75

Spellbinder-5.30 W/P: \$371.25

HIERATIC COMPUTER SYSTEMS

BOX 133; MEDFORD, MA 02155

(617) 391-8659

Circle 80 on inquiry card.

**State-Of-The-Art
INTELLIGENT
PRINTER BUFFER**

- TWO printers controlled simultaneously
- SMART-MERGE (allows address lists and form letters to be merged in the buffer)

INTELLIGENT, microprocessor controlled:
*ABORTS a job instantly *VERIFIES job stats instantly *CHECKS status of available memory *TWO-WAY communication via a unique ASCII command structure.

SMARTY is available with either centronics or serial interface and 64K or 256K of RAM. SMARTY is also available as a board level product for integration into your system or in an attractive 5" x 7" box with its own power supply. Suggested retail price: \$349.00. Major credit cards accepted. Call for dealer and OEM discounts!

Phoenix Electronic Development Corporation
618 Venice Boulevard
Marina del Rey, CA 90291
(213) 827-2511

Circle 141 on inquiry card.

"THE COLLECTOR"

SERIES™

By Trainsoft™

4 YEARS IN DEVELOPMENT

NOW AVAILABLE FOR THE IBM® PC

(Requires DOS 2.0/2.1 with 128K Single Disk Drive w/IBM/EPSON printer)

Organize Your Collectables

- Toy Trains
- Dolls
- Hummels™
- Antiques
- Household Inventory
- You Name It

\$65⁰⁰ IL Res. Add 6.25%

For Additional Info: write/call
The Third Rail®
P.O. Box 143 O'Fallon, IL 62269
(618) 632-7424

Circle 178 on inquiry card.

**CROSS
SOFTWARE
for the NS32000**

INCLUDES:

- Cross Assembler *
- Cross Linker *
- Debugger *
- N.S. ISE Support *
- Librarian *
- Pascal Cross Compiler *
- C Cross Compiler *

U.S. prices start at \$500

SOLUTIONWARE

1283 Mt. View-Avviso Rd.
Suite B

Sunnyvale, Calif. 94089

408/745-7818 * TLX 4984284

Circle 166 on inquiry card.

California Digital

17700 Figueroa Street • Carson, California 90248

NEC RGB COLOR MONITOR \$259



The NEC JC-1401D is a 13" medium/high resolution RGB monitor suitable for use with the Sanyo MBC-550/555 or the IBM/PC. The monitor features a resolution of 400 dots by 240 lines. Colors available are Red, Green, Blue, Yellow, Cyan, Magenta, Black and White. These monitors are currently being used in applications far more critical than microcomputers. The NEC monitor carries the Liton-Monroe label and was originally scheduled for use in their "Office of the Future" equipment. A change in Monroe's marketing strategy has made these units excess inventory which were sold to California Digital. We are offering these prime "new" RGB monitors at a fraction of their original cost. Sanyo compatible NEC-1401/S, IBM/PC Computer compatible NEC-1401/PC

MONITORS

Amdek 310A amber	superior resolution	158.99
Amdek Color II	RGB color	418.98
BMC 9191M	RGB color	399.97
NEC JC1401D	RGB color	259.96
Princeton HX - 12	RGB, non-glare	467.95
Princeton Max - 12	monochrome	189.94
Zenith 122 amber	monochrome w/cable	99.90
Zenith 123 green	monochrome w/cable	99.90

MODEMS

\$355



CTS 212AH	communication soft.	355.00
Hayes 1200	external modem	489.95
Hayes 1200B	Internal w/Smartcom II	399.59
Novation Access 123	includes Crosstalk	395.89
Signalman Mark 12	300/1200 baud	269.90
US Robotics 212A	Hayes compatible	459.75

ACCESSORIES

Keytronics 5150	ergonomic keyboard	175.00
Keytronics 5151	separate cursor pad	219.00
Microsoft	Mouse w/software	129.79

\$139



TEAC DISK DRIVE

Control Data	9409 IBM approved	239.90
Control Data	9428 half height	229.90
Mitsubishi	5851 half height	189.99
Panasonic	JA551 half height	159.00
Qume	142 half height	199.95
Shugart	SA455 half height	199.45
Tandon	100-2	179.95
Teac	FD55B half height	139.00

AST \$265 SIX PAK PLUS

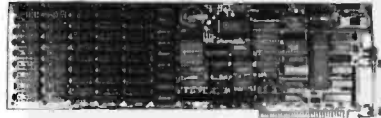

MULTIFUNCTION CARDS

AST SixPackPlus	64K with software	265.00
AST SixPackPlus	384K fully populated board	499.00
AST MegaPlus II	64K to 512K with MegaPak	269.00
AST MegaPak	256K piggyback / MegaPlus	279.00
Persyst Board	64K with software	319.00
Quadboard	64K with six functions	249.00
STB RIO Plus	64K with PC accelerator	279.00
STB Super I/O	serial/par I/game port	184.99

VIDEO CARDS

AST Monograph Plus	monochrome/graphic	449.79
Hercules Graphic	two year warranty	339.89
PC Peacock Color	mono. RGB, graphics	269.00
Plantronics ColorPlus	printer port / software	379.98
Quad Color I	expandable, high res.	209.75
STB Graphics Plus	with software	379.67

Franklin 10MB ext.	controller, power	1195.45
Franklin 10MB int.	3X speed of XT	995.95
Maynard 10MB Int.	full XT emulation	998.97

MEMORY

4164 Memory Chips	150 or 200 ns	5.95
64K Set (9 chips)	with instructions	48.95
8087 CoProcessor	arithmetc chip	199.54

Epson Comrex PLOTTER \$189

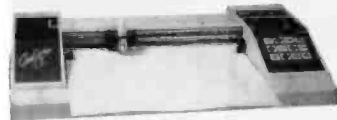

The Comrex Comscriber I is the ideal solution to make short work of translating financial and other numeric data into a graphic presentation. Complete with menu driven software for use with either IBM/PC or Appie II. Along with this are included multicolor plotter pens, demonstration software and interface/cable.

The Comscriber I was originally priced to sell at \$795. This is your opportunity to purchase a high value graphic plotter at only \$189. IBM/PC COM-C1PC; Appie COM-C1A2

PRINTERS

Epson RX-80	with quiet mode	284.90
Epson RX-80 F/T	friction and tractor	339.90
Epson FX-80	with pin and tractor	519.90
Epson FX-100 F/T	international sets	689.90
Epson LX-1500	67 cps letter quality	1189.90
Gemini 10X	friction and tractor	277.75
Gemini 15X	wide carriage	379.75
Okidata 80	affordable	279.00
Okidata 82A	parallel Interface	299.00
Okidata 83A	wide carriage w/tractor	559.00
Okidata 84	200 char/sec.	975.00
Okidata 92	Okigraph graphics	427.00
Okidata 93	wide carriage w/tractor	595.00

LETTER QUALITY

Brother HX-15	wide carriage	450.50
Brother HX-25	high speed	749.50
Comrex CR-II	Includes 5K buffer	459.95
Diablo 620	35 cps	875.90
Diablo 630	serial and parallel	1699.90
Juki 6100	14 cps. 15" carriage	435.45
SilverReed 500	w/micro justification	429.95
SilverReed 550	w/multistrike ribbon	499.95

IBM PC \$1679



System I includes 64K byte of memory one 320K byte double sided disk drive, and keyboard. Monitor and video board available. System II includes 256K byte of memory two 320K byte disk drives, Sakata color monitor, color card with printer port all for only \$2659.

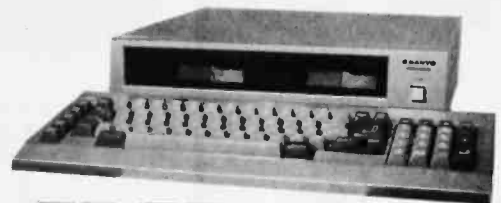

FREE \$895 SANYO IBM COMPATIBLE

The Sanyo MBC-550 Microcomputer includes 128K byte of memory, a 5 1/4" disk drive along with a parallel printer port. The computer outputs both RGB color and monochrome composite video. Extensive software such as Sanyo Basic, Wordstar, Calcstar and Easy Writer I is included with the MBC-550.

Along with all this California Digital offers "FREE" your choice of either a second disk drive, or a high resolution green or amber screen monitor. All at the super low price of only \$895.

Double sided 320K/byte disks drives are available at only \$99 per drive additional.

Sanyo 550	FREE monitor or drive	895.00
Sanyo 550-2	one double sided drive	949.00
Sanyo 550-2 Plus	two double sided drives	1095.00
Sanyo 555	two sgl. drives, bonus soft.	1095.00
Sanyo 555-2	two dbl. drives, bonus soft.	1249.00
Memory Upgrade	256K total memory	99.95
Serial Card	modem interface	85.00
DOS 2.11	compatible, IBM DOS 2.0	75.00

DOUBLE SIDED DISKETTES

Calif. Digital	CAL551	error free diskettes	24.95
Dyan	104/2D	superior quality	42.50
Maxell	MD2	high reliability	37.95
Memorex	3491	electronically bonded	32.95
Scotch	745/01	86 Proof	37.95

SOFTWARE

dBase II	data base manager	385.85
dBase III	new release	CALL
Framework	... by Ashton Tate	595.95
Lotus 123	super spreadsheet	319.89
Symphony	... by Lotus	549.95

TOLL FREE ORDER LINE
(800) 421-5041
 TECHNICAL & CALIFORNIA
(213) 217-0500

Shipping: First five pounds \$3.00, each additional pound \$.50. Foreign orders: 10% shipping, excess will be refunded. California residents add 6 1/2% sales tax. • COD's discouraged. Open accounts extended to state supported educational institutions and companies with a strong "Dun & Bradstreet" rating.

The Source For All IBM Compatible Products

PC UPGRADE

- ★ 64K of Memory
- ★ 9 - 4164
- ★ 1,000 pcs

1 set for **\$47**
2 sets for **\$90**

IBM PC

- ★ 256K Disk Controller
- ★ 1 - 360K Disk Drive
- ★ Keyboard

List \$1995 **\$1695**

IBM PC XT

- ★ 256K, 10 Meg Hard Disk
- ★ 1 - 320K Drive ★ Keyboard

List \$4395 **\$3795**

TEAC DISK DRIVE

- ★ FD55B
- ★ Slimline, 360K

List \$299 **\$155**

MULTI- DISPLAY CARD

- ★ Monochrome or Color Composite or RGB Video
- ★ Light Pen & RF Mod Ports
- ★ Parallel Printer Port
- ★ 640 x 200

List \$459 **\$299**

PC PEACOCK COLOR BOARD

- ★ IBM Color Card Compatible
- ★ With Parallel Centronics Printer Port

List \$399 **\$219**

EPSON PRINTER

- ★ FX80
- ★ 160 cps
- ★ With Near Letter Quality Printing

List \$599 **\$439**

OKIDATA PRINTER

- ★ ML93A
- ★ 160 cps
- ★ 15" Wide Carriage

List \$995 **\$639**

SANYO COMPUTER

- ★ MBC555-2
- ★ 2 - 360K Disk Drives
- ★ Bundled Software

List \$1595 **\$1275**

LOTUS

- ★ Lotus 123
- ★ PC Spread Sheet

List \$495 **\$309**

★ Symphony
List \$695 **\$529**

PIPELINE COLOR CARD

- ★ Same as IBM
- ★ Color Composite Video

List \$249 **\$189**

ANCHOR MODEM

- ★ Mark XII
- ★ 1200 Baud
- ★ Hayes Compatible

List \$399 **\$239**



The Source!



- We Accept MC, Visa, Wire Transfers, Certified Checks
- COD's Available
- All Prices Reflect a Prepaid Discount

- Shipping Minimum 4.50
- Purchase Orders Accepted
- This Ad Supersedes all Others

Prices Subject to Change

The Source



CALL TOLL-FREE (800) 841-0905 For Lowest Prices & Fast Delivery

IBM & COMPATIBLE COMPUTERS

IBM

PC w/64K, 1 Drive	\$1567
PC w/64K, 2 Drives	1743
PC XT, 256K 10 Meg Disk	3795

COMPAQ

Compaq 12BK, 1 Drive	\$1950
Compaq, 256K, 2 Drive	2295

COLUMBIA

1600-1, 2-Drives (360K)	\$2495
1600-4, 12MB Hard Disk	3875
MPC-XP Portable	2395

SANYO

MBC 550, 1-Drive, software	\$ 699
MBC 555, 2-Drives, 160K ea.	1035
MBC 550-1, 1-Drive, 320K	979
MBC 555-2, 2-Drives, 320K ea.	1275
Optional Serial Port	89
Optional Drive w/Software	199

TAVA

2-Drives, 128K, 2 Ser. 1 Par. Port, Color Graphics Card & Hi-Res. Green Monitor	\$1789
---	--------

MODEMS

HAYES MICRO INC.

Smart Modem 300	\$ 205
Smart Modem 1200	489
1200B for PC	399

ANCHOR

Mark VII 300 Baud	\$ 89
Mark XII 1200 Baud	239

PROMETHEUS

ProCom 1200	\$ 349
-------------	--------

RIXON

PC212A, 1200 Baud Stand Alone	\$ 399
-------------------------------	--------

U.S. ROBTICS

Password, 1200 Baud	\$ 319
---------------------	--------

DISKETTES

PIPELINE

Dbl./Dbl. Reinforced Hub 1 year warranty	\$ 18
Flip File Holds 70 (smk. plexiglass)	16

PRINTERS

OKIDATA

ML 92A (160 cps)	\$ 405
ML 93A (160 cps)	637
92 & 93 Plug & Play	49

STAR MICRONICS

Gemini 10X, 120 cps	\$ 249
Gemini 15X, 120 cps, 15" car.	389

JUKI

6100, 18 cps ltr. qual.	\$ 439
Tractor Feed	129

EPSON

RX80	\$ 269
RX80FT	309
RX80	439
FX100	659

MONITORS

AMDEK

300G, 12" Green	\$ 129
300A, 12" Amber	139
310A, 12" Amber Monochrome	165
Color I + Color Composite	299
Color II + RGB w/Cable	409

PRINCETON GRAPHICS

PGS HX12	\$ 469
PGS MAX12	189
PGS SR12	640

IBM COMPATIBLE DISK DRIVES

TANDON

TM-55-2, 1/4 Height (360K)	\$ 195
TM-100-2 (360K)	\$ 179

TEAC

FD55B, 1/4 Height (360K)	\$ 155
--------------------------	--------

MATSUSHITA

Same as Panasonic, 1/4 Ht. 360K	\$ 145
---------------------------------	--------

CDC

9409, (360K)	\$ 199
--------------	--------

INTERFACE CARDS FOR IBM AND COMPATIBLES

AST RESEARCH

SixPac + 64K Par. & Ser. Software	\$ 259
Mega + 64K exp. to 512K Ser. Port	259
MegaPack 256K option for Mega	269
I/O + Ser. & Optional Par. Game	149
Additional Ports	49

QUADRAM

Color I	\$ 209
Color II	229
Quadlink	449
64K	279
Quad Board II	269

HERCULES

Color Graphics Card	\$ 329
---------------------	--------

PLANTRONICS

Color +	\$ 379
---------	--------

IBM

Dos 2.1	\$ 57
Monochrome Monitor or Adaptor	229

FLOPPY DISK CONTROLLERS

Maynard	\$ 169
Maynard w/Ser. Port	229
Maynard w/Par. Port	229
Sigma Controller	159

DUST COVER

Covers Monitor, Mainframe & Keyboard	\$ 19
--------------------------------------	-------

MORE ACCESSORIES

Koala Graphics Tablet	\$ 85
8087 Co-Processor	179
Kraft Joystick	39
Par. Printer Cable	29

USI

Paradise	\$ 299
----------	--------

PC

Color Card	\$ 189
------------	--------

The Source!

Circle 143 on Inquiry card.



ORDER DESK:
(213) 970-0177
(800) 841-0905
(OUTSIDE CALIFORNIA)

MAIL ORDER:
1142 Manhattan Avenue, CP21
Manhattan Beach, CA 90266

CUSTOMER SERVICE:
(213) 970-0177

RETAIL STORE:
New Location Opening Soon
Call for Details

IBM PC \$1899

256K, two disk drives 360K each,
Drive Controller and Keyboard

IBM PORTABLE \$2199

256K, two disk drives

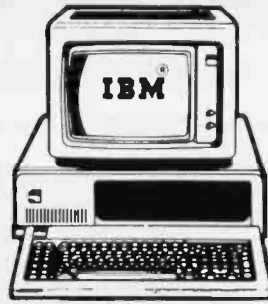

IBMPC w/10MB \$2599

256K, one floppy Drive, Keyboard
10 MB Hard Disk with Controller

BOOTS FROM HARD DISK Backup also available

IBMPC w/30MB \$3999

256K, one floppy Drive, Keyboard
30 MB Hard Disk with Controller
and Booster Power Supply

BOOTS FROM HARD DISK Backup also available

★ PRICE WAR ★ CALL US LAST WITH YOUR BEST QUOTES ★

PRINTERS	HARD DRIVES	NETWORKING
EPSON FX-80 \$489 FX-100 \$599 LQ-1500 CALL OKIDATA 92P \$399 INCLUDES PLUG & PLAY 93P \$649 84P \$799 NEC 2050 \$799 3550 \$1,499 DYNAX DX-15 \$399 BROTHER HR-25 \$649 HR-35 \$999 IDS PRISM 132C COLOR PRINTER \$1,499 SHEET FEEDERS AND TRACTORS CALL	UP TO 140 MB BACKUP ALSO AVAILABLE CALL EVEREX 10MB \$899 w/Controller and 2 Year Warranty MAYNARD 10MB/30MB 10MB/WS-1 \$899 10MB/WS-2 \$1,049 30MB CALL TALL GRASS TECHNOLOGY 20 MB w/20 MB Backup \$3,299 35 MB w/45 MB Backup \$4,495 70 MB w/60 MB Backup CALL FLOPPY DRIVES TEAC HALF 55B-DSDD \$149 HEIGHT 55F-QUAD \$199 Full Hr - DSDD \$199 CDC Half Hr. - DSDD \$179 TANDON 100-2 Full Hr. DSDD \$179 ★ \$UPER \$PECIAL\$ ★ 64K RAM Set of 9 chips \$45 IBM PC Color/Graphics Card \$199 MonoChrome/Printer Card \$199 PGS HX-12 \$449 TEAC Disk Drive FD55B, 360K slimline, PC Compatible \$149 KEYTRONIC Deluxe Keyboard KB5151 \$199 ERA 2 MODEM PC Internal 1200 Baud w/software, 4 Yr. Warranty \$329 COMPAQ 256K, 2 Disk Drives \$1,999	ORCHID TECHNOLOGY PC Net PLUS Starter Kit \$999 CORVUS OMNINET SANTA CLARA SYSTEMS PC Terminal CALL MULTI-DISPLAY CARDS AST MonoGraph Plus w/clock & PP \$369 Serial Port Option \$30 QUAD Color I .. \$199 Color II .. \$199 EVEREX Graphics Edge \$399 TECMAR Graphics Master \$449 HERCULES Mono Graphics \$329 Color Graphics \$199 NEW STB Graphix Plus II \$349 PLANTRONICS Color Plus \$366 PARADISE Multi-display Card \$299 Tseng Labs Ultra PAK \$499 MULTI-FUNCTION CARDS NEW QUADBOARD 0-K (to 384K) \$199 AST SIX PAK with 64K (to 384K) \$249 EVEREX Magic Card 0-K (to 384K) \$229 MISC. ADD ONS PRACTICAL PERIPHERALS MICROBUFFER CALL CABLE Parallel or Serial \$20 IBM PC DOS 1.1 .. \$20 DOS 2.1 .. \$50 IBM PC Floppy Drive Controller \$139 COMPUTER POWER ACCESSORIES DIRECTOR \$109 STANDBY POWER SUPPLY 200 WATTS.....\$299 300 WATTS.....\$399 Surge Protection, up to 30 minutes Standby Power

PARTIAL LISTING ONLY - PLEASE CALL OR WRITE FOR FREE CATALOG.

STATIC RAMS

2114	1024 x 4 (450ns)	8/9.95
2114-25	1024 x 4 (250ns)	8/10.95
2114L-2	1024 x 4 (200ns) (LP)	8/13.95
TMM2016-200	2048 x 8 (200ns)	4.15
TMM2016-150	2048 x 8 (150ns)	4.95
TMM2016-100	2048 x 8 (100ns)	6.15
HM6116-4	2048 x 8 (200ns) (cmos)	4.75
HM6116-3	2048 x 8 (150ns) (cmos)	4.95
HM6116LP-4	2048 x 8 (200ns) (cmos) (LP)	5.95
HM6116LP-3	2048 x 8 (150ns) (cmos) (LP)	6.95
HM6264	8192 x 8 (150ns) (cmos)	39.95

LP = Low Power

DYNAMIC RAMS

4116-250	16384 x 1 (250ns)	8/7.95
4116-200	16384 x 1 (200ns)	8/12.95
4116-150	16384 x 1 (150ns)	8/14.95
4164-200	65536 x 1 (200ns) (5v)	5.95
4164-150	65536 x 1 (150ns) (5v)	6.95
TMS 4164-15	65536 x 1 (150ns) (5v)	8.95

5v = Single 5 volt supply

EPROMS

2708	1024 x 8 (450ns)	3.95
2716	2048 x 8 (450ns) (5v)	3.95
2716-1	2048 x 8 (350ns) (5v)	5.95
TMS2532	4096 x 8 (450ns) (5v)	5.95
2732	4096 x 8 (450ns) (5v)	4.95
2732-250	4096 x 8 (250ns) (5v)	8.95
2732-200	4096 x 8 (200ns) (5v)	11.95
2732A	4096 x 8 (250ns) (5v) (21vPGM)	9.95
2732A-2	4096 x 8 (200ns) (5v) (21vPGM)	13.95
27128	16384 x 8 (300ns) (5v)	29.95

5v = Single 5 volt supply 21vPGM = Program at 21 Volts

SPECTRONICS CORPORATION

EPROMERASER PE-14, 9chipcapacity 83.00

8000

8039	5.95
8080	3.95
8085	4.95
8087	CALL
8088	29.95
8155	6.95
8748	24.95

8200

8203	39.95
8205	3.50
8212	1.80
8216	1.75
8228	3.49
8237-5	21.95
8243	4.45
8250	10.95
8251	4.49
8253	6.95
8253-5	7.95
8255	4.49
8255-5	5.25
8259	6.90
8259-5	7.50
8275	29.95
8279	8.95
8282	6.50
8284	5.50
8286	6.50

Z-80

Z80-CPU	3.95
Z80-PIO	3.95
Z80A-CPU	4.49
Z80A-CTC	4.95
Z80A-PIO	4.49
Z80A-SIO/O	12.95
Z80B-CPU	9.95

6500

6502	4.95
6522	6.95
6502A	6.95

6800

6802	7.95
6809E	14.95
6821	2.95
6845	14.95
6850	3.25
6883	22.95

DISK CONTR

1771	24.95
1791	24.95
1793	26.95
2791	54.95
2793	54.95

INTERFACE

8T28	1.89
8T97	.89
DM8131	2.95
DP8304	2.29
9334	2.50
9368	3.95

CLOCK CHIPS

MM5369	3.95
MM58167	12.95
MSM5832	3.95

DATA ACQ

ADC0804	3.49
ADC0809	4.49
ADC0817	9.95
76488	5.95
AY3-8910	12.95

CRYSTALS

32.768 khz	1.95
1.0 mhz	3.95
1.8432	3.95
2.0	2.95
2.4576	2.95
3.276	2.95
3.579545	2.95
4.0	2.95
5.0	2.95
5.0688	2.95
6.0	2.95
6.144	2.95
8.0	2.95
10.0	2.95
10.738635	2.95
14.31818	2.95
15.0	2.95
16.0	2.95
17.430	2.95
20.0	2.95

74LS00

74LS00	.24	74LS157	.65
74LS02	.25	74LS158	.59
74LS03	.25	74LS161	.65
74LS04	.24	74LS163	.65
74LS05	.25	74LS164	.69
74LS08	.28	74LS165	.95
74LS09	.29	74LS169	1.75
74LS11	.35	74LS173	.69
74LS14	.59	74LS174	.55
74LS20	.25	74LS191	.89
74LS21	.29	74LS193	.79
74LS27	.29	74LS194	.69
74LS30	.25	74LS195	.69
74LS32	.25	74LS221	.89
74LS33	.55	74LS240	.95
74LS38	.35	74LS241	.99
74LS42	.49	74LS242	.99
74LS47	.75	74LS243	.99
74LS51	.25	74LS244	1.29
74LS53	.39	74LS251	.59
74LS74	.35	74LS257	.59
74LS75	.39	74LS258	.59
74LS76	.39	74LS259	2.75
74LS85	.69	74LS260	.59
74LS86	.39	74LS266	.55
74LS90	.55	74LS273	1.49
74LS92	.55	74LS279	.49
74LS93	.55	74LS280	1.98
74LS107	.39	74LS283	.69
74LS109	.39	74LS290	.89
74LS112	.39	74LS293	.89
74LS122	.45	74LS299	1.75
74LS123	.79	74LS323	3.50
74LS125	.49	74LS365	.49
74LS126	.49	74LS367	.45
74LS132	.59	74LS368	.45
74LS133	.59	74LS373	1.39
74LS136	.39	74LS374	1.39
74LS138	.55	74LS377	1.39
74LS139	.55	74LS390	1.19
74LS148	1.35	74LS393	1.19
74LS151	.55	74LS640	2.20
74LS153	.95	74LS670	1.49
74LS154	1.90	74LS682	3.20
74LS156	.69	74LS688	2.40

DISCRETE

KBPO2 Bridge	.45
1N751 5.1v zener	.25
1N759 12v zener	.25
2N2222	.15
PN2222	.20
2N2905	.25
2N2907	.50
2N3055	.79
2N3904	.10
2N3906	.10
1N4004	10/1.00
1N4148	25/1.00

RESISTORS

1/4 WATT 5% CARBON FILM ALL STANDARD VALUES FROM 1 OHM TO 10 MEG OHM

50 PCS./VALUE	.025
100 PCS./VALUE	.02
1000 PCS./VALUE	.015

DIP

SWITCHES

4 POSITION	.85
5 POSITION	.90
6 POSITION	.90
7 POSITION	.95
8 POSITION	.95

MISC.

ULN2003	2.49
3242	7.95
MC3470	4.95
AY5-1013	3.95
COM8116	10.95

IC SOCKETS

8 pin ST	1.99	100
14 pin ST	.13	.11
14 pin ST	.15	.12
16 pin ST	.17	.13
18 pin ST	.20	.18
20 pin ST	.29	.27
22 pin ST	.30	.27
24 pin ST	.30	.27
28 pin ST	.40	.32
40 pin ST	.49	.39
64 pin ST	4.25	call

ST = SOLDERTAIL

8 pin WW	.59	.49
14 pin WW	.69	.52
16 pin WW	.69	.58
18 pin WW	.99	.90
20 pin WW	1.09	.98
22 pin WW	1.39	1.28
24 pin WW	1.49	1.35
28 pin WW	1.69	1.49
40 pin WW	1.99	1.80

WW = WIREWRAP

16 pin ZIF 6.95 call

24 pin ZIF 7.95 call

28 pin ZIF 8.95 call

ZIF = TEXTTOOL (Zero Insertion Force)

ORDER TOLL FREE

800-538-5000
800-662-6279
(CALIFORNIA RESIDENTS)

LINEAR

TL084	2.19
LM301	.34
LM307	.45
LM311	.64
LM317T	1.19
LM319	1.29
LM324	.55
LM339	.99
LF351	.60
LM353	1.00
LM358	.69
LM380	.69
LM386	.89
LM393	1.29
TL497	3.25
NE555	.34
NE558	1.50
NE564	2.95
LM565	.99
LM566	1.49
LM567	.89
LM572	2.75
NE592	7.00
LM723	.45
LM741	.39
LM1303	1.95
MC1408L8	2.95
LM1458	.59
LM1488	.69
LM1489	.69
XR2206	3.75
XR2211	5.25
CA3146	1.85
LM3914	3.95
75150	1.95
75154	1.95
75188	1.25
75189	1.25
7805T	.75
7808T	.75
7812T	.75
7815T	.75
7805K	1.39
7812K	1.39
78H05K	9.95
78L05	.69
78L12	.69
7905T	.85
7912T	.85
79L05	.79
79L12	.79

T = TO-220	K = TO-3
L = TO-92	

HEAT SINKS

TO-3 style	.95
TO-220 style	.35

74S00

74S00	.32	74S86	.50
74S02	.35	74S112	.50
74S04	.35	74S124	2.75
74S05	.35	74S138	.85
74S08	.35	74S157	.95
74S10	.35	74S175	.95
74S11	.35	74S240	2.20
74S20	.35	74S280	1.95
74S32	.40	74S287	1.90
74S74	.50	74S288	1.90

7400

7400	.19	7447	.69
7402	.19	7473	.34
7404	.19	7474	.33
7405	.25	7475	.45
7406	.29	7476	.35
7407	.29	7486	.35
7408	.24	7490	.35
7410	.19	7492	.50
7411	.25	7493	.35
7414	.49	74121	.29
7416	.25	74123	.49
7417	.25	74132	.45
7420	.19	74151	.55
7425	.29	74154	1.25
7430	.19	74157	.55
7432	.29	74164	.85
7438	.29	74168	1.00
7442	.49	74192	.79
7445	.69	74193	.79

CMOS

4001	.25	4069	.29
4011	.25	4070	.35
4013	.38	4071	.29
4015	.39	4081	.29
4016	.39	4093	.49
4017	.69	14411	11.95
4020	.75	4511	.85
4024	.65	4518	.89
4027	.45	4520	.79
4040	.75	4553	5.79
4042	.69	4584	.75
4046	.85	74C00	.35
4049	.35	74C04	.35
4050	.35	74C74	.35
4051	.79	74C925	5.95
4066	.39	74C926	7.95

PERIPHERALS

JDR HALF-HEIGHT DISK DRIVE

* TEAC MECHANISM - DIRECT DRIVE
* 100% APPLE COMPATIBLE - 35 TRACK
* 40 TRACK WHEN USED WITH OPTIONAL CONTROLLER
* 1 YEAR WARRANTY

40 TRACK CONT

Tektronix 40XX Terminal Emulation

EMU-TEK™ IS NOW AVAILABLE FOR IBM PC, XT, AND MOST COMPATIBLES

- Access powerful mainframe graphics using:
 - PLOT 10 (trademark of TEKTRONIX, Inc.)
 - DISPLA (registered trademark of ISSCO)
 - DARC (available from QUESTEL, Inc.)
 - and most similar packages and services.
- Upgrade with complete software compatibility.
- Increase versatility with options such as:
 - High resolution board support
 - Local pen-plotter support
 - Hard copy on matrix printer
 - Advanced communications program features
 - Other terminal emulations, including:
 - VT100 (trademark Digital Equipment Corp.)
 - RETRO-GRAPHICS (trademark Digital Engineering, Inc.)

• **30 DAY NO-RISK TRIAL PRIVILEGE.**



FTG DATA SYSTEMS

10801 Dale St./P.O. Box 615
Stanton, CA 90680
(714) 995-3900

FTG will soon become PC INNOVATIONS

Circle 63 on inquiry card.

*IBM® PC Compatible



E-PROMS — Call! Lowest Prices Anywhere

*4164-150/200 480
2764-250 675
6116-LP3 499
HMM 256K. Call for quote
TTL Parts — now avail Call

Disk Drives: (F.O.B. Tampa)

*TM-100-2 169⁹⁵
*Half-Heights-2 169⁹⁵

*10 mb Microscience w/cable & controller 959⁹⁹

Add \$3.95 shipping to all orders • Prices subject to change • P.O.'s on approval • C.O.D. OK • All new, no surplus, no seconds. QUANTITY DISCOUNTS.
4920 Cypress St., Ste. 100, Tampa, FL 33607
In FL and for info, call 813-875-0299

FOR ORDERS ONLY, 800-237-8910



8 AM-7 PM EDT

Circle 134 on inquiry card.

MEMOREX

SPECIAL OFFER ON DATA RELIABLE DISCS



Memorex seals its floppy discs with a process it developed, called Solid-Seam Bonding. This seals shut every inch of every seam of every Memorex floppy disc.

PLUS! If you call, write, or utilize reader service in response to this ad—we'll send you our full-range catalog of computer supplies with Special Offers good for further savings on Memorex diskettes and many other quality products.

LYBEN COMPUTER SYSTEMS

1250-E Rankin Dr., Troy, MI 48083
Phone: (313) 589-3440

Simply #1 in Service & Reliability

CERTIFIED 100% ERROR-FREE

Circle 102 on inquiry card.

μP / EPROM / BIPOLAR / PAL PROGRAMMER

S 100 BUS AND IBM PC BUS

- PC compatible PROM 2000 card
- S100 compatible PROM 200 card
- Zero Insertion socket on external box
- PROM type software selectable
- Personality box for EPROMS (24 pins & 28 pins)
- 2758 2516 2716 2732 2732A 2764 27128 27256 MC6874
- EPROM version of microprocessor
- 8748/8749/8751
- 16 20 and 24 pins Bi-POLAR PROMS
- 20 and 24 pins Programmable Logic array (PAL)

Advanced Microcomputer Systems, Inc.

6802 N.W. 20th Avenue
Fr. Lauderdale, Florida 33309
Phone (305) 975-9515



Circle 6 on inquiry card.



N-CODE™

PROTECTS YOUR FILES

- Super-fast Data Encryption
- Unique Code for each User
- Multi-layered Security
- YOU select Coding Keys
- Guards your IBM-PC files
- 30-day Money-back Guarantee

\$199 each. Demo Disk \$10.

For Orders/Free Brochure:

(301) 564-8669



K + L Software

White Flint Mall

P.O. Box 2303

Kensington, MD 20895



Circle 93 on inquiry card.

DUST COVERS

For Personal Computers and Small Business Systems, Peripherals, Game Units — Protective, Long-Lasting Vinyl! Resists Both Dust and Liquids.

— CHOICE OF COLORS —

Amdek	Franklin Ace
Apple	IBM
Atari	Kaypro
BMC	Okidata
Columbia	Rana Systems
Commodore	Star Micronics
Corona	Televideo
Eagle	Texas Instruments
Epson	PLUS OTHERS

GROUP/VOLUME DISCOUNTS AVAILABLE

FOR FREE BROCHURE WRITE:

ENCHANTED FOREST
P.O. Box 5261, Newport Beach, CA 92662
(118 Onyx)

Dealer Inquiries Invited

Circle 6 on inquiry card.

PERIPHERAL SWITCH

AUTOMATIC SWITCHES FOR IBM PC

Fast, easy, automatic way to share a printer or modem among many computers. No software required. RS232 or centronics. It scans for peripheral request, connects to the peripheral, handles all hardware handshaking, and releases the port. LEDs display channel selected and busy status. Attractive aluminum box. # channels-price: 2-\$200 4-\$250 6-\$300 8-\$350

MANUAL SWITCHES FOR IBM PC

Uses PC board and aluminum box. # lines switched RS232-10 Cent-20 RS232 1:2 \$59(wow) 1:4 \$89 Centronics 1:2 \$99 1:4 \$179

Free book with each order entitled *Serial and Parallel Explained*



ROSE ELECTRONICS MC AND VISA (713)240-ROSE

P.O. Box 742571 Houston, Tx 77274

Circle 155 on inquiry card.

COMPUTER PRODUCTS-GUARANTEED SAVE UP TO 50%

*COMPUTERS

IBM PC and compatibles, North Star, NEC Portable and more Call

*PRINTERS

Dynax DX-15 (L.Q.) parallel or serial \$425.00

Brother HR-25 parallel or serial \$695.00

Okidata 92 (160 c.p.s.) Call

Panasonic 1091 dot matrix multifunction printer Call

*PERIPHERALS

Drives: Tandon, Teac, NEC, Panasonic and more

Boards, monitors, plotters, cables and more at lowest prices

*ACCESSORIES

Printer Stand, computer covers, all models Call

Roll-Top Diskettes File (holds 100) \$34.95

L.F. High Quality 5 1/4" disks with hub rings, SSD \$1.75, DSD \$2.25

3 1/2" diskettes, mag tapes, disckpacks, data cartridge, etc. Call

*SOFTWARE

Peachtree Accounting-GL, AR, AP, Inventory Control, Payroll, Job Costing \$385.00/ea.

Back to basics ser. for IBM PC (accounting)

Home Software Library for IBM PC and PC jr \$285.00

dBASE III, upgrade to dBASE III, Rbase, Peachtree 5000 Call

Harvard Project Manager and other software at bargain prices

*TRAINING COURSE AND HANDBOOK

Lotus 1-2-3, dBASE II, Wordstar, Accounting and others \$65.00/ea.

Everyman's Database Primer (Book) \$14.95

Educational software and much more Call

MANY OTHERS, AT LOWEST PRICE, PHONE OR WRITE

Mail or Phone Your Order:

LF COMPUTER PRODUCTS

8660-D Miramar Rd. Suite 265, San Diego, CA 92126

(619) 566-6823 — Phone order full rebate

Mastercard/VISA add 3%. Shipping & Handling \$3.95, Calif. Res. add 6% Sales Tax. All Products Manufacturer Guaranteed.

Circle 94 on inquiry card.

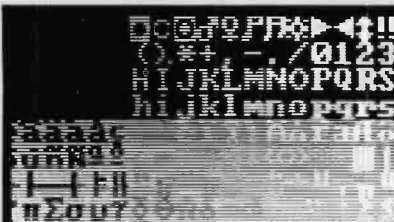

THE GRAYSCALER

The Grayscale works with your color graphics card, substitutes sixteen brightness levels for color. Gives any composite green, white or amber monitor the crispness & power of RGB at a fraction of the cost. Software transparent. Just **\$59.95**. Call Now Toll Free 1-800-824-7888. Ask for Operator 157 (AK. HI 1-800-824-7919) visa/mc 24hrs

Avocado Computer
17352 Yorkshire Ave.
Yorba Linda, CA 92686
714-528-1025

Circle 16 on inquiry card.

IBM COMPATIBLE ACCESSORIES

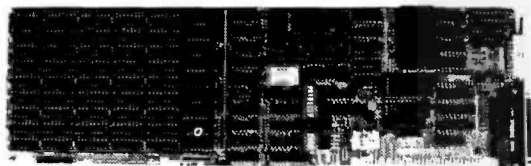

SIGMA DESIGNS, INC.

MAXIMIZER COMPAREI

\$259⁹⁵
(64K)

OPTIONS:

MAXIMIZE YOUR IBM PC OR XT!

MAXIMUM FLEXIBILITY-All of the most asked for support features on one card plus SOFTDISK and SPOOL software to increase your PC's productivity!

MAXIMUM PERFORMANCE PER DOLLAR-Compare features with the best selling multifunction card and save!

MAXIMUM RELIABILITY-The MAXIMIZER features the highest quality 4-LAYER board construction, sockets for all RAM, and is backed by a full

ONE YEAR WARRANTY

	MAXIMIZER	AST 6-PACK +
Maximum Memory	384K / 512K ¹	384K
RS-232 Serial	2 ²	1
Parallel Port	1	1
Clock Calendar	YES	YES
Game Adaptor	Optional	Optional

¹ with optional 128K MAXISTACK

² second serial port optional

- 2nd Serial Port **\$49⁹⁵**
- Game Adaptor **\$29⁹⁵**
- 128K MAXISTACK **\$159⁹⁵**
- Additional 64K RAM **\$49⁰⁰**

PC PEACOCK

COLOR GRAPHICS ADAPTER
BY MA SYSTEMS

- ★ FULL IBM COMPATIBILITY
- ★ HIGH RES. 640x200 ★ MED. RES. 320x200
- ★ COMPOSITE AND RGB OUTPUT FOR ALL STANDARD MONITORS
- ★ LIGHT PEN INTERFACE
- ★ CHOICE OF 16 COLORS IN HIGH RES. MODE!
- ★ PARALLEL PORT STANDARD!

★ 2 YEAR WARRANTY!



**YOUR BEST BUY
NOW ONLY \$239⁹⁵**



ACCESSORIES

VERBATIM DATALIFE DS/DD

10/ \$34⁹⁵ 100/ \$280⁰⁰

Parallel Printer Cable **\$39⁹⁵**

HAYES SMARTMODEM 1200B **\$419⁹⁵**
includes Smartcom II

SMART CABLE **\$84⁹⁵**

Universal RS-232 Interface -
Instantly connects any RS232
computer and peripheral.
(Specify Male or Female)

ORDER TOLL FREE
800-538-5000
800-662-6279
(CALIFORNIA RESIDENTS)

DISK DRIVES

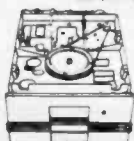

TANDON 5 1/4"

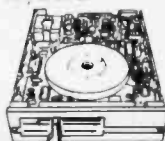

TEAC HALF HEIGHT

FULL-HEIGHT

TANDON TM100-2 DS/DD \$199⁹⁵

HALF-HEIGHT

TEAC FD-55B DS/DD \$159⁹⁵

MATSUSHITA JA551-2 DS/DD \$149⁹⁵

TEAC FD-55F DS/Quad \$200⁰⁰

JFORMAT-2 **\$59⁹⁵**

Support for quad density drives from
Tall Tree Systems

CABINETS

Dual Slimline cabinet with power supply **\$89⁰⁰**

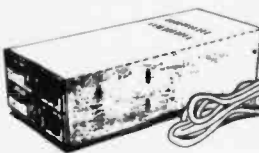

Above cabinet with 2 FD-55B
disk drives and cable

**SPECIAL
\$395⁰⁰**



FROM
JDR MICRODEVICES

PROTOTYPE BOARDS

IBM-PR1 **\$27⁹⁵**

General purpose development board
with convenient lines for power and
ground. Holes on .1" centers.

IBM-PR2 **\$29⁹⁵**

As above, with modular signal decoding
area providing buss buffering, block de-
coding, and additional decoding.

Both cards feature high-quality glass epoxy
with plated-through holes, solder mask on 2
sides, silk-screened legend for all signals,
and gold card-edge contacts. Mounting
bracket and instructions included.

8087 5MHz \$175
4164 200ns 9/\$49

130W POWER SUPPLY
XT COMPATIBLE
UPGRADE YOUR PC
INSTRUCTIONS INCLUDED

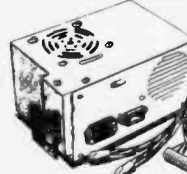

+ 5V - 15A
+ 12V - 4.2A
- 5V - .5A
- 12V - .5A

\$175⁰⁰

ONE YEAR WARRANTY

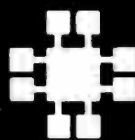

JDR Microdevices

1224 S. Bascom Avenue, San Jose, CA 95128

800-538-5000 • 800-662-6279 (CA)

(408) 995-5430 • Telex 171-110

© Copyright 1984 JDR Microdevices

VISIT OUR RETAIL STORE

HOURS: M-W-F, 9-5 T-Th., 9-9 Sat. 10-3

PLEASE USE YOUR CUSTOMER NUMBER WHEN ORDERING

TERMS: Minimum order \$10. For shipping and handling include \$2.50 for UPS Ground and \$3.50 for UPS Air. Orders over 1 lb. and foreign orders may require additional shipping charges - please contact our sales department for the amount. CA residents must include 6% sales tax, Bay Area and LA residents include 6 1/2%. Prices subject to change without notice. We are not responsible for typographical errors. We reserve the right to limit quantities and to substitute manufacturer. All merchandise subject to prior sale.

B·O·M·B

BYTE'S ONGOING MONITOR BOX

ARTICLE#	PAGE	ARTICLE	AUTHOR(S)
1	30	IBM Forecast: Market Dominance	Killen
2	42	A Tale of Two Operating Systems	Daney, Foth
3	59	The Future of UNIX on the IBM PC	Phraner
4	65	Five Window Managers for the IBM PC	Markoff
5	91	Two Logos for the IBM PC	Goldberg
6	125	The Logical Record Keeper: PROLOG on the IBM	Weiner
7	134	An Introduction to PC Assembly- Language Programming	Claff
8	155	Technical and Business Graphics on the IBM	Bishop
9	165	Word Processing Revisited	Cameron
10	187	Six Database Management Systems	Kruglinski
11	197	Evaluating 8087 Performance on the IBM PC	Fried
12	210	The IBM XT/370 Personal Computer	Sabine
13	218	Number Crunching on IBM's New S9000	States
14	231	The Mainframe Connection: IBM's 3270 PC	Augustin
15	238	Modems: The Next Generation	Klein
16	248	Moving Data Between PCs and Mainframes	Siegel
17	256	Testing for IBM PC Compatibility	Stillman

IBM Special BOMB Card Explanation

Just as with your regular issues of BYTE, the editors would like to survey how effectively each article in our BYTE Guide serves our audience. Fill out the card opposite the tabulation of your votes in the December issue of BYTE.

First-place winner will receive a bonus of \$100, second-place performer will receive \$50, and the article that scores third will be mentioned in these pages.

BYTE Back issues for sale

	1976	1977	1978	1979	1980	1981	1982	1983	1984
Jan.				\$2.75	\$3.25	\$3.25		\$3.70	\$4.25
Feb.			\$2.75	\$2.75	\$3.25	\$3.25		\$3.70	\$4.25
March			\$2.75		\$3.25		\$3.70	\$3.70	\$4.25
April			\$2.75	\$2.75	\$3.25	\$3.25	\$3.70	\$3.70	\$4.25
May		\$2.00	\$2.75	\$2.75	\$3.25		\$3.70	\$3.70	\$4.25
June		\$2.00	\$2.75	\$2.75	\$3.25		\$3.70	\$3.70	\$4.25
July	\$2.00	\$2.00	\$2.75	\$2.75	\$3.25		\$3.70	\$4.25	\$4.25
Aug.		\$2.00	\$2.75	\$2.75		\$3.25	\$3.70	\$4.25	\$4.25
Sept.		\$2.75	\$2.75	\$2.75	\$3.25		\$3.70	\$4.25	
Oct.			\$2.75	\$2.75	\$3.25	\$3.25	\$3.70	\$4.25	
Nov.				\$3.25		\$3.25	\$3.70	\$4.25	
Dec.		\$2.75	\$2.75	\$3.25	\$3.25	\$3.25	\$3.70	\$4.25	

Prices include postage in the US. Please add \$.50 per copy for Canada and Mexico; and \$2.00 per copy to foreign countries (surface delivery).

Check enclosed

Payments from foreign countries must be made in US funds payable at a US bank.

VISA

Master Card

Card # _____

Exp. _____

Signature _____

Please allow 4 weeks for domestic delivery and 12 weeks for foreign delivery.

Circle and send requests with payments to:

BYTE Back Issues
P.O. Box 328
Hancock, NH 03449

NAME _____

ADDRESS _____

CITY _____

STATE _____ **ZIP** _____

R·E·A·D·E·R S·E·R·V·I·C·E

Inquiry No.	Page No.	Inquiry No.	Page No.	Inquiry No.	Page No.
1 A.S.T. RESEARCH	80, 81	32 CHELSEA-SKYE INC.	278	62 EXPOTEK	78
2 AB COMPUTERS	273	33 CHORUS DATA SYSTEMS	145	64 FTG. DATA SERV.	100
3 ACL INC.	174	34 CIE TERMINALS	55	63 FTG. DATA SERV.	284
4 ADDMASTER CORP.	276	35 COGITATE	98	65 FLAGSTAFF ENGINEERING	70
5 ADV. ANALYTICS TECH. CORP.	276	36 COMMERCIAL BUSINESS SYS.	271	66 FLOPPY DISK SERV. INC.	234
6 ADVANCED MICRO SYSTEMS INC.	284	37 COMPUMAIL	282	181 FRIENDLYSOFT	152
7 ALLOY COMPUTER PRODUCTS	86	38 COMPUTER AID COVERS	276	68 GENICOM	13
9 ALPHA SOFTWARE CORP.	49	* COMPUTER CHANNEL	272	69 GREAT LAKES COMPUTER	33
10 AMERICAN MITAC CORP.	45	39 COMPUTER FURN. & ACCESS.	142	70 GRYPHON MICRO PROD.	100
11 APPARAT INC.	114, 115	184 COMPUTER MAIL ORDER	93	71 GTEK INC.	96
13 APPLIED COMP. PROD. INC.	264, 265	47 COMPUTER PRICE CLUB	160	72 HANDWELL CORP.	272
14 ASHTON-TATE	247	42 COMPUTERS FOR LESS	207	73 HAUPPAUGE COMP. WORKS	229
15 AVOCADO COMPUTER	278	43 CORECO INC.	74	74 HAYES MICROCOMP. PROD.	16, 17
16 AVOCADO COMPUTER	284	44 CUESTA SYSTEMS	67	75 HEATH COMPANY	104, 105
17 AVOCET	101	48 DATA COPY SYSTEMS	85	* HERCULES COMPUTER TECH.	57
18 BAY TECHNICAL ASSOC.	15	45 DATASOUTH COMP. CORP.	237	* HERCULES COMPUTER TECH.	111
19 BETATOOL SYSTEMS	262	46 DIGI-DATA CORP.	103	78 HERMES PRECISA INT'L	83
20 BIBLE RESEARCH SYSTEMS	77	41 DIGITAL LABORATORIES	246	79 HEWLETT-PACKARD	22, 23
21 BIT SOFTWARE INC.	77	193 DISC INSTRUMENTS	154	80 HIERATIC COMP. SYS.	278
22 BMDP STATISTICAL SOFTWARE	151	194 DISC INSTRUMENTS	154	81 HOOLEON COMPANY	47
23 BORLAND INT'L	CLII	50 DOW JONES SOFTWARE	95	82 I-BUS SYSTEMS	195
25 BOTTOM LINE, THE	126	51 DWIGHT CO. INC.	276	83 IBM-(IS)G SERVICES	119
* BYTE BACK ISSUES	286	52 DYNAX INC.	159	84 IBM CORP.	6, 7
* BYTE ADV. MESSAGE	200, 201	53 EASTERN SOFTWARE PROD.	148	85 IBM NDD--SYS. SUPPLIES	58
* C WARE	244	54 ECOSOFT	255	86 INDUSTRIAL PROGRAMMING	233
26 C-SOURCE	202	55 ELECTRADE CO.	118	87 INTERFACE INC.	236
27 C.S.D. INC.	138	56 ELEKTEK	262	88 INTERFACE INC.	236
152 CABRILLO SOFTWARE	276	57 EMERALD SYSTEMS CORP.	38	89 I&M SYSTEMS	183
* CALIF. DIGITAL	279	58 EMPRESS TECH. INC.	38	90 I&M SYSTEMS	183
28 CANON U.S.A.	137	* ENCHANTED FOREST	284	91 IAMECO ELECTR.	99
29 CANON U.S.A.	139	59 ENERTRONICS	169	191 IDR MICRODEVICES INC.	283
30 CAPITAL EQUIPMENT CORP.	46	60 EPSON AMERICA	225	192 IDR MICRODEVICES INC.	285
31 CDI	120, 121	61 EVEREX SYSTEMS	135	93 K&L SOFTWARE	284

BYTE ADVERTISING SALES STAFF:

J. Peter Huestis, Advertising Sales Manager, 70 Main Street, Peterborough, NH 03458, tel. (603) 924-9281

NEW ENGLAND

ME, NH, VT, MA, RI
Paul McPherson Jr. (617) 262-1160
McGraw-Hill Publications
575 Boylston Street
Boston, MA 02116

ATLANTIC

NY (NORTH), NY, NYC, CT
Dick McGurk (212) 512-3588
Leah S. Goldman (212) 512-2096
McGraw-Hill Publications
1221 Avenue of the Americas—39th Floor
New York, NY 10020

EAST

PA (EAST), NJ (SOUTH),
MD, VA, W.VA, DE, D.C.
Daniel Ferro (215) 496-3833
McGraw-Hill Publications
Three Parkway
Philadelphia, PA 19102

SOUTHEAST

NC, SC, GA, FL, AL, TN
Maggie M. Dorvee (404) 252-0626
McGraw-Hill Publications
4170 Ashford-Dunwoody Road—Suite 420
Atlanta, GA 30319

MIDWEST

IL, MO, KS, IA, ND, SD, MN, WI, NB
Jack Anderson (312) 751-3740
McGraw-Hill Publications
Blair Building
645 North Michigan Ave.
Chicago, IL 60611

GREAT LAKES, OHIO REGION

MI, OH, PA (ALLEGHENY), KY, IN,
EASTERN CANADA
Dennis Riley (313) 352-9760
McGraw-Hill Publications
4000 Town Center—Suite 770
Southfield, MI 48075

SOUTHWEST, ROCKY MOUNTAIN

UT, CO, WY, OK, TX, AR, MS, LA
Alan Morris (214) 458-2400
McGraw-Hill Publications
Prestonwood Tower—Suite 907
5151 Beltline
Dallas, TX 75240

SOUTH PACIFIC

SOUTHERN CA, AZ, NM, LAS VEGAS
Page Goodrich (714) 557-6292
McGraw-Hill Publications
3301 Red Hill Ave.
Building #1—Suite 222
Costa Mesa, CA 92626

Karen Niles (213) 480-5243, 487-1160

McGraw-Hill Publications
3333 Wilshire Boulevard #407
Los Angeles, CA 90010

NORTH PACIFIC

HI, WA, OR, ID, MT, NORTHERN CA,
NV (except LAS VEGAS), W. CANADA
David Jern (415) 362-4600
McGraw-Hill Publications
425 Battery Street
San Francisco, CA 94111

Bill McAfee (415) 964-0624
McGraw-Hill Publications
1000 Elwell Court—Suite 225
Palo Alto, CA 94303

WEST COAST SURPLUS

AND RETAIL ACCOUNTS
Tom Harvey (805) 964-8577
3463 State Street—Suite 256
Santa Barbara, CA 93105

Post Card Mailings

National
Bradley Browne (603) 924-6166
BYTE Publications
70 Main Street
Peterborough, NH 03458

International Advertising Sales Representatives:

Mr. Hans Csokor
Publimedia
Reisnerstrasse 61
A-1037 Vienna, Austria

Mrs. Gurit Gepner
McGraw-Hill Publishing Co.
PO Box 2156
Bat Yam, 59121 Israel
866 561 321 39

Mr. Fritz Krusebecker
McGraw-Hill Publishing Co.
Liebigstrasse 19
D-6000 Frankfurt/Main 1
West Germany
72 01 81

Mrs. Maria Sarmiento
Pedro Teixeira 8, Off. 320
Iberia Mart I
Madrid 4, Spain
45 52 891

Mr. Andrew Karnig
Andrew Karnig & Associates
Kungsholmsgatan 10
112 27 Stockholm, Sweden
08 51 68 70

Mr. Ken Davey
McGraw-Hill Publishing Co.
17 rue Georges Bizet
F 75116 Paris
France
720 33 42

Mr. Arthur Scheffer
McGraw-Hill Publishing Co.
34 Dover St.
London W1X 3RA
England 01 493 1451

Mr. Savio Pesavento
McGraw-Hill Publishing Co.
Via Flavio Baracchini 1
20123 Milan, Italy
86 90 656

Seavex Ltd.
05-49/50 Tanglin Shopping Center
19 Tanglin Rd.
Singapore 1024
Republic of Singapore

Seavex Ltd.
Room 102, Yu Yuet Lal Bldg.
43-55 Wyndham St. Central
Hong Kong

Hiro Morita
McGraw-Hill Publishing Co.
Overseas Corp.
Room 1528
Kasumigaseki Bldg.
3-2-5 Kasumigaseki,
Chiyoda-Ku
Tokyo 100, Japan
581 9811

READER SERVICE

Inquiry No.	Page No.	Inquiry No.	Page No.	Inquiry No.	Page No.
94 L.F. COMPUTER PRODUCTS	284	130 ORION INSTRUMENTS	260	* RACAL-VADIC	132, 133
95 LABORATORY MICROSYS	215	131 ORYX SYSTEMS	257	155 ROSE ELECTRONICS	284
96 LAKE AVENUE SOFTWARE	215	132 PC NETWORK	184, 185	156 ROESOFT INC.	98
97 LARK SOFTWARE	259	133 PC PERFORMANCE	182	189 S-100 DIV. 696 CORP.	277
98 LIBRA PROGRAMMING	246	134 PC PIPELINE	284	190 S-100 DIV. 696 CORP.	277
99 LIFETREE SOFTWARE INC.	75	135 PC'S LIMITED	173	158 SATELLITE SOFTWARE	167
100 LIGO RESEARCH INC.	162	136 PENCAPT INC.	130	159 SAV-ON COMPUTERS	274, 275
101 LOGICAL DEVICES	175	137 PERSOFT	99	8 SCIENTIFIC RESEARCH CORP.	110
102 LYBEN COMP. SYS.	284	* PERSONALIZED COMP. PAPER	150	* SCITOR	88, 89
103 LYCO COMPUTER	271	138 PERSYST. INC.	28, 29	160 SECTOR SYSTEMS CO.	278
104 MANDINGO COMPUTER	254	139 PERSYST. INC.	28, 29	161 SEEQUA COMP. CORP.	11
105 MARC SOFTWARE	178	141 PHOENIX ELECTRONIC DEVL P.	278	162 SIGNAL TECHNOLOGY	21
106 MAXELL DATA PRODUCTS	146	142 PHONE I. INC.	207	163 SMARTWARE INC.	261
107 METALINK CORP.	118	143 PIPELINE COMPUTER	280, 281	164 SOFTCRAFT INC.	64
108 MICRO AGE COMP. STORES INC.	107	145 PLUM HALL INC.	117	* SOFTLINE CORP.	131
109 MICRO CENTRE	241	146 PRECISION DATA	118	175 SOFTWARE GROUP, THE (Insert)	64 A-D
111 MICRO MART, INC.	52, 53	147 PRINCETON GRAPHIC SYS.	177	177 SOFTWARE LINK, THE	50
112 MICRO MINT	270	139 PERSYST. INC.	28, 29	166 SOLUTIONWARE CORP.	278
113 MICRO-TAX	39	144 PUBLIC DOMAIN SOFTWARE CTR.	278	167 SPEECH PLUS	171
* MICROCOMPATIBLES	276	148 QUADRAM CORP.	8	168 SPERRY COMP. SYS.	25
115 MICROCOMPATIBLES	276	149 QUADRAM CORP.	63	169 SPSS	186
* MICROSOFT CORP.	112, 113	150 QUBIE DISTRIBUTING	79	165 STSC	27
116 MICROTOME	106	151 QUBIE DISTRIBUTING	223	172 TDI SYSTEMS, INC.	170
117 MICROWARE	116	153 QUESTIONNAIRE SERV. CO.	276	173 TECMAR INC.	CIV
118 MILLER MICROCOMP. SERV.	102			* TEXAS INSTRUMENTS	40
119 MULTITECH SYSTEMS	242			178 THIRD RAIL, THE	278
120 MULTIMATE INT'L	68, 69			179 THOUGHTWARE INC.	161
121 NATIONAL INSTRUMENT	4			* TINNEY, ROBERT GRAPHICS	263
122 NEC INFORMATION SYS.	CIII			180 VENTEL INC.	34
123 NEW GENERATION SYS.	230			67 VISAGE	243
124 NORTH HILLS CORP.	276			182 WADSWORTH PROFESSIONAL SOFTWARE	182
125 NORTH HILLS CORP.	278			183 WALONICK ASSOCIATES	255
126 OKIDATA	5			188 WESTERN UNION	97
127 OPTO-22	143			185 WILLIAMS, MARK CO.	109
128 OPTO-22	143			186 WINTEK CORP.	19
129 ORCHID TECHNOLOGY	90			187 WRITING CONSULTN.	251

 TO GET FURTHER information on the products advertised in BYTE, fill out the reader service card with your name and address. Then circle the appropriate numbers for the advertisers you select from the list. Add a 20-cent stamp to the card, then drop it in the mail. Not only do you gain information, but our advertisers are encouraged to use the marketplace provided by BYTE. This helps us bring you a bigger BYTE. The index is provided as an additional service by the publisher, who assumes no liability for errors or omissions.
 *Correspond directly with company.

SUBSCRIBERS ONLY! USE AIMS

BYTE'S AUTOMATED INQUIRY MANAGEMENT SYSTEM

**Available 24 hours a day and
7 days a week**

GET PREPARED...

- 1) Write Your Subscriber Number, As Printed On Your Subscriber I.D. Card, In Boxes In Step 4 Below. (Do Not Add 0's.)
- 2) Write Numbers For Information Desired In Boxes In Step 6b Below. (Do Not Add 0's.)

CALL AIMS...

- 3) Now, On a Touch-Tone Telephone Dial: (413) 442-2668 And Wait For Voice Commands.

ENTER YOUR SUBSCRIBER AND ISSUE NUMBERS...

- 4) When AIMS Says: "Enter Subscriber Number" ...
 (Enter by pushing the numbers and symbols [# or * enclosed in the boxes] on telephone pad ignoring blank boxes)
 Enter # #
- 5) When AIMS Says "Enter Magazine Code & Issue Code" ...
 Enter # # #

ENTER YOUR INQUIRIES...

- 6a) When AIMS Says "Enter (Next) Inquiry Number" ...
 Enter One Inquiry Selection From Below ... (Ignore Blank Boxes)
- b) Repeat 6a As Needed (Maximum 17 Inquiry Numbers)

- | | | | |
|---|---|--|--|
| 1. <input type="checkbox"/> <input type="checkbox"/> <input type="checkbox"/> # # | 6. <input type="checkbox"/> <input type="checkbox"/> <input type="checkbox"/> # # | 10. <input type="checkbox"/> <input type="checkbox"/> <input type="checkbox"/> # # | 14. <input type="checkbox"/> <input type="checkbox"/> <input type="checkbox"/> # # |
| 2. <input type="checkbox"/> <input type="checkbox"/> <input type="checkbox"/> # # | 7. <input type="checkbox"/> <input type="checkbox"/> <input type="checkbox"/> # # | 11. <input type="checkbox"/> <input type="checkbox"/> <input type="checkbox"/> # # | 15. <input type="checkbox"/> <input type="checkbox"/> <input type="checkbox"/> # # |
| 3. <input type="checkbox"/> <input type="checkbox"/> <input type="checkbox"/> # # | 8. <input type="checkbox"/> <input type="checkbox"/> <input type="checkbox"/> # # | 12. <input type="checkbox"/> <input type="checkbox"/> <input type="checkbox"/> # # | 16. <input type="checkbox"/> <input type="checkbox"/> <input type="checkbox"/> # # |
| 4. <input type="checkbox"/> <input type="checkbox"/> <input type="checkbox"/> # # | 9. <input type="checkbox"/> <input type="checkbox"/> <input type="checkbox"/> # # | 13. <input type="checkbox"/> <input type="checkbox"/> <input type="checkbox"/> # # | 17. <input type="checkbox"/> <input type="checkbox"/> <input type="checkbox"/> # # |
| 5. <input type="checkbox"/> <input type="checkbox"/> <input type="checkbox"/> # # | | | |

END SESSION...

- 7) End Session By Entering ...
 * # #
- 8) Hang Up After Hearing Final Message

If you are a subscriber and need assistance, call
(603) 924-9281.

If you are not a subscriber fill out the subscription card found in this issue or, call BYTE Circulation 800-258-5485.

NO OTHER LETTER-QUALITY PRINTER CAN TOUCH OUR NEW SPINWRITER FOR SPEED AND EASE- OF-USE.

Introducing the Spinwriter 8850.

Our newest, and fastest, Spinwriter® printer operates at over 550 words-per-minute. And is extraordinarily easy to operate.

For one thing the Spinwriter 8850 takes care of basic settings such as pitch and forms length automatically. Of course you can also change either



printer available for the IBM® PC. It's still one of the few that works with all IBM PC software, as well as all other popular packages. You'll notice even its looks are compatible.



THE 8850
JOINS THE
HIGHLY-RELIABLE
SPINWRITER LINE

one at the touch of a button. It also has a unique control panel.

With large, legible alphanumeric LED's to indicate the specific operating status.



UNIQUE LED DISPLAY TELLS USER EVERYTHING FROM THE FACT THAT PAPER IS OUT



TO THE FACT THE COVER IS OPEN

And, of course, the 8850 has all the features, quality and reliability that make a Spinwriter a Spinwriter. **The first choice of IBM PC users.**

The Spinwriter printer was the first totally plug compatible letter-quality

printer also give you capabilities you won't find on other printers. Like a selection of 80 different print styles.

And, nine easily installed forms handling options that can accelerate your printed output even more. Spinwriter printers also have an enviable record for reliability.

In fact, several

CHANGE FORMS LENGTH
AT THE PRESS OF A BUTTON.

years without a failure is not unusual. No wonder there are more Spinwriter printers hooked up to IBM PC's than any other letter-quality printer.

How to get up to speed.

For more information on the Spinwriter 8850 or our two companion



THE 8850 PLUGS RIGHT INTO THE IBM PC.

models, just call NEC Information Systems at: 1-800-343-4419; in Massachusetts call (617)264-8635.

Also available at:
Entre, 1-800-HI
ENTRE: Sears Business System Centers, 1-800-228-2200; and Computeland stores, (In California) 1-800-321-1101; (Outside California) 1-800-423-3308.

Find out why more and more IBM PC users are saying, "NEC and me."

NEC AND ME

NEC Information Systems, Inc.
1414 Mass. Ave.
Dept. 1610
Boxborough, MA 01719



Spinwriter is a registered trademark of NEC Corp. IBM is a registered trademark of International Business Machines Corp.

Circle 122 on inquiry card.



WHAT A PAIR ! Tecmar's Graphics Master™ & Lotus 1-2-3¹

Graphics Master is the only board that creates *both monochrome and color* graphics for Lotus 1-2-3.

You can also run IBM compatible software because Graphics Master emulates both the IBM Color Graphics Adapter and the Monochrome Adapter.

We are pleased to announce that Graf-Talk² and MetaWindow³ software take full advantage of Graphics Master's high resolution graphics.

Graphics Master is the only board that will do all of the following with appropriate software:

- High resolution color graphics - 640 x 400, 16 colors
- High resolution monochrome graphics - 720 x 700
- Run software for IBM Monochrome Adapter
- Run software for IBM Color Graphics Adapter



TECMAR
the power behind the PC

Tecmar Inc. 6225 Cochran Road Solon (Cleveland), Ohio 44139-3377 Phone: (216)349-0600 Telex: 466692

1 Registered Trademark of the Lotus Development Corp. 2 Registered Trademark of the Redding Group Inc. 3 Registered Trademark of the Metagraphics Corp.

Circle 173 on Inquiry card.