

Computers & Electronics

DECEMBER 1983

\$1.75

The World's First 16-Bit CMOS Microprocessor

Memory-Efficient Timex Programming Techniques

Testing Spectravideo's Home Computer

Hewlett-Packard's Touch Command Computer

NOW!

**Personal
Computers
that Listen
to You**



Also in this Issue:
How Computers Calculate

303092 DRK 6450M091 141D DEC84
L DARKNELL JR
6450 MYRTLEWOOD DR
CUPERTINO CA 95014
12#R3



0

**DUE TO
CIRCUMSTANCES
WITHIN OUR
CONTROL
YOUR PICTURE
HAS JUST BEEN
IMPROVED.**

INTRODUCING MAXELL HGX GOLD.

No matter how good your VCR may be we've just made it better. With new Maxell HGX Gold Video Tape. Because it's better than any tape you've ever owned.

New smaller magnetic particles allow us to more densely and evenly pack the oxide layer of this new tape.

So you get richer, crisper colors, clearer, cleaner sound and better resolution than ever before.

In addition, through a revolutionary new process called molecular fusion the oxide layer is bonded to the base film with a new polymer resin, which virtually eliminates dropouts. This not only extends the life of HGX Gold, but due to decreased particle build up, extends the life of your video heads, as well.

All of which makes HGX Gold a picture perfect investment. **VHS** 



maxell
IT'S WORTH IT.

The Informer Lets You Hear What's Going On When You Aren't There.

Your Phone Becomes an Open Ear

You're away from home. A premonition grabs you. Is the baby asleep, or is he squalling?

If you have an Informer on your phone, the answer is as quick as a phone call from any phone in the world.

Call your number. Use a special "beeper" that comes with your Informer. Your call is routed into the Informer, which responds to your remote signal by opening a super-sensitive microphone. That microphone transmits to you, wherever you are, every sound in the room, up to 100 feet away!

FCC-Approved American-Made

The Federal Communications Commission has approved the Informer. That means you now can have the safety and security of being able to know what's going on in your home or office. For example —

- You left some papers at the office. You're on your way back to pick them up. A strange light is burning in your office. Is it the cleaning service — or an intruder? Call, and let your Informer report to you.

- You're at the airport. Uh-oh. Did you leave the water running? A neighbor has a key, but you don't want him in your house unless it's an emergency. Nothing to it: call home, and the Informer will pick up the sound of water, if it's running.

- Your mother lives alone and is up in years. She refuses to have anyone check on her during the night. You connect an Informer to her phone. You'll know, quickly, if she's all right.

- The automatic alarm goes off in your store. Should you go in there? It's far safer to let the Informer tell you if someone is in there.

- You own a mountain cabin. You're closing it up for the season. Every now and then it's reassuring to call the cabin. The Informer will tell you, by reporting any strange sounds, if all is well.

- YOU CAN ADD A HUNDRED MORE USES!

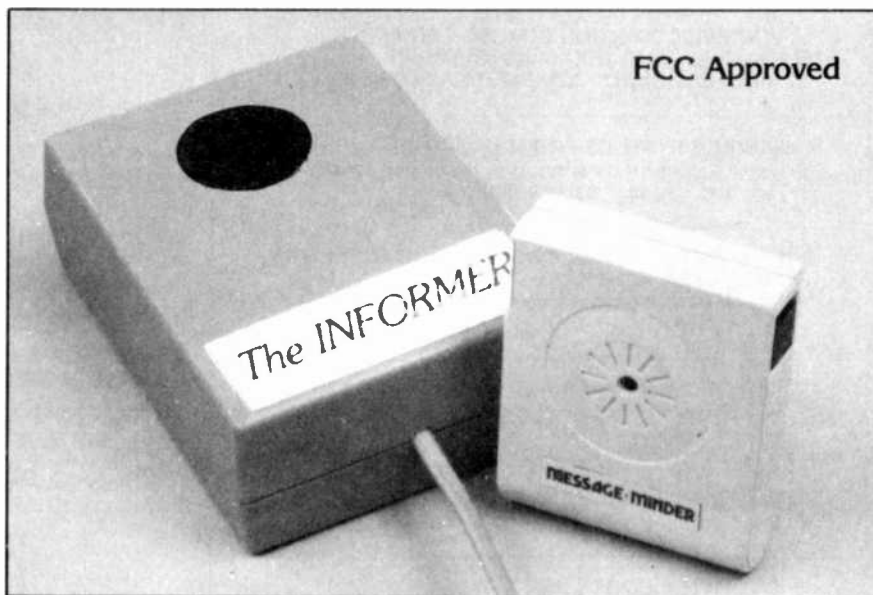

FCC Approved

Pick up every sound in the room — even a whisper.

Compact, Super-Sensitive Electronic Instrument

The Informer is only 3" x 4". But what power it has! The state-of-the-art microphone hears everything, even a whisper.

Connecting it takes only a couple of seconds. It uses a standard modular phone plug and needs no separate power source.

WANT TO TRY IT? WE'LL TAKE THE RISK.

Try the Informer for 30 days. If you decide you don't want it, send it back and we'll refund every cent you paid. We'll bet, though, that after 30 days you'll want several more.

NEW! The SUPER-Informer

This unbelievable unit makes its own automatic outgoing calls, in synthesized English, when a pre-programmed problem occurs — such as a fire, a dramatic change in temperature, a power outage, or a burglar alarm ring. It also tells you the time, in English. It automatically dials, with one key, any of eight numbers in its memory. And of course it also does everything the standard Inquirer does.

Circle No. 17 on Free Information Card

The Informer \$149.95

two for \$129.95 each
(+ \$2.75 per total order for shipping)

The Super Informer \$229.95

two for \$209.95 each
(+ \$2.75 per total order for shipping)

For fast delivery on credit card orders
call toll-free 24 hours a day, 7 days a week:

800-443-0100

Ask for Extension 111

Or send check or money order.
(Be sure to add shipping cost.)

For information Call: 201-370-1234

The Informer and The Super Informer
are electronic marvels from

NEW HORIZONS

Dept. C12

5-31 Fiftieth Avenue
Long Island City, NY 11101
TELEX: 4993183 HORIZONS

©1983 New Horizons

Computers & Electronics

DECEMBER 1983

VOLUME 21, NUMBER 12

FEATURE ARTICLES

34 EARS FOR YOUR COMPUTER
Ed Teja/How various computer voice-recognition systems operate.

**40 VOICE-RECOGNITION BOARDS FOR APPLE/
FRANKLIN AND TEXAS INSTRUMENTS
"PROFESSIONAL" COMPUTERS** / Joe Desposito

47 NUMBER SYSTEMS FOR MICROCOMPUTERS
Randy Carlstrom/How binary, decimal, octal & hexadecimal systems work in relation to your computer.

**56 HEWLETT-PACKARD'S NEW "TOUCH-SCREEN"
COMPUTER**
George Mitchell/Microcomputer reacts through a touch-sensitive CRT screen.

68 "ARTIFICIAL" EXPANSION OF TIMEX-1000 MEMORY
W.A. Largent, Jr./Memory-efficient program techniques add to your storage capabilities.

73 BY ITS JOYSTICK YE SHALL KNOW IT
C & E staff reviews Spectravideo's SV-318 personal computer.

76 COMPUTER BOOKS
A potpourri of the most recent computer books on the market.

82 FAIL-SAFE REAL-TIME CLOCK FOR TRS-80
John C. Mein/Low-cost accessory keeps time even when computer is turned off.

94 1983 ANNUAL EDITORIAL INDEX

COLUMNS

22 LES SOLOMON ON COMPUTER HARDWARE
An Eye- and Temper-Saving Proposal.

24 BITS & BYTES / Sol Libes



30 COMPUTER VIDEO GAMES

86 THE ELECTRONICS SCIENTIST
Forrest M. Mims, III/The World's First 16-Bit CMOS Microprocessor/Experimenting With a Piezoelectric Speaker.

DEPARTMENTS

4 EDITORIAL
Art Salsberg/The Year That Was

5 LETTERS

8 NEW PRODUCTS

96 OPERATION ASSIST

97 ADVERTISER'S INDEX

107 COMPUTER MART/ELECTRONICS CLASSIFIED

COVER PHOTOGRAPH BY TRUMAN MOORE

COPYRIGHT © 1983 BY ZIFF-DAVIS PUBLISHING COMPANY. All rights reserved. Computers & Electronics (ISSN 0032-4485) December 1983, Volume 21, Number 12. Published monthly by Ziff-Davis Publishing Co., at One Park Ave., New York, NY 10016. Richard P. Friesé, President; Selwyn Taubman, Treasurer; Bertram A. Abrams, Secretary. One year subscription rate for U.S. and Possessions, \$16.97; Canada, \$21.97; all other countries, \$24.97 (cash orders only, payable in U.S. currency). Second Class Postage Paid at New York, N.Y. 10016 and at additional mailing offices. Authorized as second class mail by the Post Office Dept., Ottawa, Canada, and for payment of postage in cash. POPULAR ELECTRONICS including ELECTRONICS WORLD trademark registered. Indexed in the Reader's Guide to Periodical Literature. Ziff-Davis also publishes Boating, Car and Driver, Cycle, Flying, Popular Photography, Skiing, Stereo Review, Electronic Experimenter's Handbook, and Tape Recording & Buying Guide. **POSTMASTER:** Send address changes to COMPUTERS & ELECTRONICS, Circulation Dept., P.O. Box 2774, Boulder, CO 80302. Please allow at least eight weeks for change of address, enclosing, if possible, an address label from a recent issue. **Permissions.** Material in this publication may not be reproduced in any form without permission. Requests for permission should be directed to Elizabeth Amado, Rights and Permissions, Ziff-Davis Publishing Co., One Park Ave., New York, NY 10016.

Now from Timex...a powerful new computer.

72K **COLOR** SOUND UNDER \$200*

Timex introduces a second generation of home computers designed with one purpose in mind: to be useful.

With 72K on-board memory, it's powerful enough to solve more problems in your home. Entertain you with brilliant color graphics and 8-octave sound.

Plus do word processing in addition to spread-sheet functions.

And while it does more, it does it with even greater simplicity.

Its one-touch keyboard means you don't have to know typing. New Timex Command Cartridges can be used without any knowledge of programming.

Finally, A home computer you can really use in your home: the Timex Sinclair 2068.

72K on-board memory.

More memory than any computer in its class. And more memory means you can do more.

8-octave sound.

Can be used to create four sounds simultaneously over a wide frequency range.

Unique one-touch entry.

Requires no typing skills; makes programming easier to learn.

Word processing capability.

This program provides a 64-character wide screen when used with a video monitor. An 80-column printer that provides hard copy will be available early 1984.



Sleek new compact design.
Fits easily on any desk or table.

Raised typewriter keyboard.
With full-travel keys is based on world's most popular electronic keyboard design.

Timex Command Cartridges.
Provide faster, easier program loading, take up less space.

TIMEX SINCLAIR 2068

To purchase the Timex Sinclair 2068 computer see your local dealer, or call 1-800-24-TI-M-EX.

WILLIAM S. DAVID *Publisher*

ARTHUR P. SALSBERG *Editorial Director*

LESLIE SOLOMON *Technical Director*

JOHN R. RIGGS *Managing Editor*

JAMES KIEHLE *Art Director*

A. W. BURAWA *Senior Editor*

JOSEPH DESPOSITO *Technical Editor*

JOSEF BERNARD *Technical Editor*

ANDRE DUZANT *Technical Illustrator*

ROBERT LASCARO *Assistant Art Director*

CARMEN VELAZQUÉZ *Production Editor*

JEFF NEWMAN *Editorial Assistant*

Contributing Editors: Walter Buchsbaum, Len Feldman, Julian Hirsch, Sol Libes, Forrest M. Mims, III

Editorial and Executive Offices
One Park Avenue, New York, N.Y. 10016 212 725-3500

Advertising Sales Offices

New York

Tom Ballou 212 725-3578
Ken Lipka 212 725-3580

Midwestern

Robert Vanek, Suite 1400, 180 N. Michigan Ave., Chicago, IL 60601 312 346-2600

Western

Joe Mesics, J.E.M. Associates, Francisco Bay Office Park, 1750 Montgomery Street, San Francisco, CA 94111 415-989-4643

Representation in Japan

J.S. Yagi, Iwai Trading Co., Ltd. 603 Ginza Sky Heights Bldg., 18-13, Ginza 7-Chome, Tokyo, Japan 104

Consumer Computers & Electronics Magazine Division

Larry Sporn *President*

Jeff Hammond *Vice President, Marketing*

Carole Mandel *Vice President, Circulation*

Eileen G. Markowitz *Vice President,*

General Manager

Peter J. Blank *Creative Director*

Ziff-Davis Publishing

President Richard P. Friese; President Consumer Magazine Division Albert S. Traina; Executive Vice President, Marketing and Circulation Paul H. Chook; Senior Vice President Phillip T. Heffernan; Senior Vice President Sidney Holtz; Senior Vice President Edward D. Muhlfeld; Senior Vice President Philip Sine; Vice President Baird Davis; Vice President George Morrissey; Treasurer Selwyn Taubman; Secretary Bertram A. Abrams

Editorial correspondence: COMPUTERS & ELECTRONICS, 1 Park Ave., New York, NY 10016. Editorial contributions must be accompanied by return postage and will be handled with reasonable care; however, publisher assumes no responsibility for return or safety of manuscripts, art work, or models submitted.

The publisher has no knowledge of any proprietary rights which will be violated by the making or using of



The Year That Was

IT was October 3, 1983. "Hello, Barbara," I greeted Coleco's public relations contact at the other end of a telephone line. "How is 'Adam' today?"

Adam wasn't too well, it seemed, though Barbara's exuberant voice didn't betray a hint of this. "It's worth waiting for," she chimed, alluding to the interminable delays in providing reviewers with a sample they could examine.

Adam, as you likely know, is the "family" computer system, announced last June at a trade show, that caused Wall Street analysts to purr and writers about computers to herald its introduction as the first glimpse of a brave new computer world. Causing all the fuss was a computer that comes with a built-in word-processor system and includes a letter-quality daisy-wheel printer for the unlikely package price of \$600 before discount.

Full-page advertisements in *The Wall Street Journal* proclaimed its sterling attributes. Everyone waited for a "hands-on" look at it; department and chain store buyers lined up to place orders for the machine that was displayed originally under a smoked-glass enclosure.

It's been four months since the prototype Adam was unveiled. The bloom faded as the green leaves turned brown and no production model was in sight. Ongoing journalistic outpourings stoked the fire, though. It has become sort of a computer-business soap opera: Production is held up owing to time-consuming FCC tests. . . tape data access time was said to be slowed to ensure reliability. . . part of the system failed FCC tests. . . the word-processor software is being debugged. . . suggested retail price now appears to be hovering around \$700. . . Adam passed its r-f interference tests. . . Christmas-season sales aren't too important because

Adam will be a year-round seller . . . arbitrageurs are taking short positions on Coleco stock. . . WP shortcomings were noted during a controlled demonstration last week. . . etc.

In the background of Coleco's corporate siren song has been a bevy of rumors about the impending introduction of other new computers that would shake the industry to its toes. Apple's "Macintosh," for instance, which is reputed to be a small, Lisa-like computer. Another is IBM's alleged preparations to launch a home computer, code-named "Peanut." In fact, I can't recall as much press copy ever written about a product that has never been officially mentioned by its company.

"It is expected to sell for \$900 retail." "It will sell for \$800." "It'll have 4" disk drives." "Uses 3 1/2" drives." "Will not have an open bus." "No internal expansion." "Upward-compatible with the IBM PC." "Manufactured by another U.S. company, not through Boca Raton, FL nor Greenock, Scotland." "Will be launched in September." "Will be introduced in October." "Won't be sold in 1983." And so on.

Hot on the heels of IBM's non-announcement of its new home computer, there was supposition about the appearance of its new portable—to be called "Crackerjack." Reportedly upward-compatible with the IBM XT, this ghostly computer would cost between \$2000 and \$4000, said the gossips. But, wait, how about "Popcorn"? A \$10,000 competitor to Apple's Lisa, it is reportedly a 32-bit multi-user/multi-task workstation that uses the Unix operating system rather than MS-DOS and a 68000 CPU instead of the PC's 8088 microprocessor.

And speaking of Unix, whatever happened to the Unix-based AT&T computers that were reportedly being readied for 1983 introduction? Word has it that the information-processing giant plans to bundle the multi-user operating system into 32-bit virtual machine chips it is developing.

So maybe the year that was will go down as the year of the "Hype." Meanwhile, Season's Greetings and Happy New Year.

Art Salsberg

LETTERS

MORE ON VIC-20 RECORDING

Regarding "A VIC-20 Cassette Adapter" and a letter on the same subject, both in your September issue, I decided to use a Radio Shack CTR-41 recorder with my VIC-20 (for which I paid only \$88) because I couldn't see putting out more for a recorder than I had for the computer. I put together a little interface with an op amp to recover the cassette audio and a 7414 for TTL input to the VIC-20. It worked fine until I picked up a tape made on a VIC-20 recorder. I couldn't load the tape. Then I found an interface at a hamfest and it worked fine with the VIC-20 tape but not with the tapes made with my old recorder. Examining signals on a scope showed that the Radio Shack recorder introduced an extra phase inversion when the signal went from the VIC onto the tape and then back out from the tape playback. I wound up adding a 7414 stage in the playback and another in the output line.—*Cal Sondgeroth, Mendota, IL.*

In "A VIC-20 Cassette Adapter," under Use, the instructions are to connect

J3 to the microphone input connector on the VIC-20 computer. This should be the microphone input connector on the cassette recorder.—*B. Okigbo, Minneapolis, MN.*

ABOUT BITS & BYTES

I was glad to see Sol Libes in print again. I have recently missed his column in one of the other magazines.—*A Fan in Spokane.*

I noticed two things in October's "Bits & Bytes" that I believe are wrong. First, DEC is not abandoning production of its 36-bit computer line. It announced the cancellation of Project Jupiter, a 50-MIPS general-purpose 36-bit time-sharing super-computer; but production of the current 36-bit CPUs will be continued for at least five more years. Second, DEC's 36-bit computers are not minicomputers. Excluding the KS-2020 CPU, the KL-10 line is a mainframe computer.—*Joe Smith, Golden, CO.*

ADDRESS CORRECTION

We were pleased to see a reference in the article "Unix the Easy Way" (September, p. 43) to our operating system, "UniFlex." However, we have recently

moved to a new location. Our address is: Technical Systems Consultants, Inc., 111 Providence Rd., Chapel Hill, NC 27514 (Tel. 510-920-0540).—*Daniel E. Vanada, Vice President*

OUT OF TUNE

In the "Hex/ASCII/Decimal conversion Chart" (October, p. 68), the ASCII character for hex 0C should read FF not FP; the ASCII characters for hex 5C and 7C are a reverse slash and a vertical rule, respectively. It could be pointed out, also, that the character for hex 27 is an apostrophe and for hex 2C is a comma, since they appear to be identical the way they are shown.

In "Multiple-Character Generation from your Keyboard" (October, p. 66), the designation F on the line from the interface should be deleted.

In "Keyboard Encoding Schemes" (October, p. 79), in Fig. 13, the Delete key should be between 0₁₅ and 1₇; the Escape key between 0₁₁ and 1₁; the Line Feed key between 0₁₀ and 1₀; and the Carriage Return key between 0₁₃ and 1₀. To protect the inputs of 4532 from static electricity, add eight resistors (1 meg-ohm each) between the inputs and the negative supply's ground.

Digital Capacitance Meter

Only **\$49.⁹⁹**

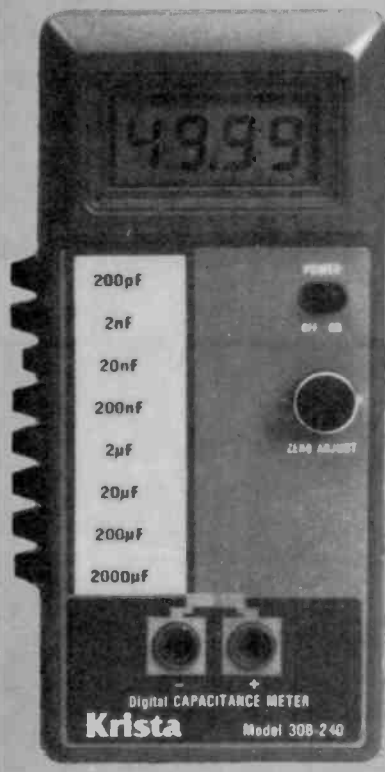

Digital Capacitance Meter

Stock No. 99-240

- 3 1/2 Digit LCD
- Push-button selection
- 0.1 pF to 1999 μF
- Direct lead Insertion jack
- Immediate direct reading
- Fuse protected
- 200 hour battery life

SIZE: 7 1/8" x 3 3/8" x 1 1/2"
WEIGHT: 10 Ounces

Digital Multimeter

Stock No. 99-140

- 3 1/2 Digit LCD
- Push-button selection
- Large 0.5" LCD
- AC/DC to 1000 V, DC to 10A
- Resistance to 2 M ohms
- Auto polarity
- Full overload protection

SIZE: 7" x 3 1/4" x 1 1/2"
WEIGHT: 16 Ounces

Digital Multimeter

Only **\$39.⁹⁹**

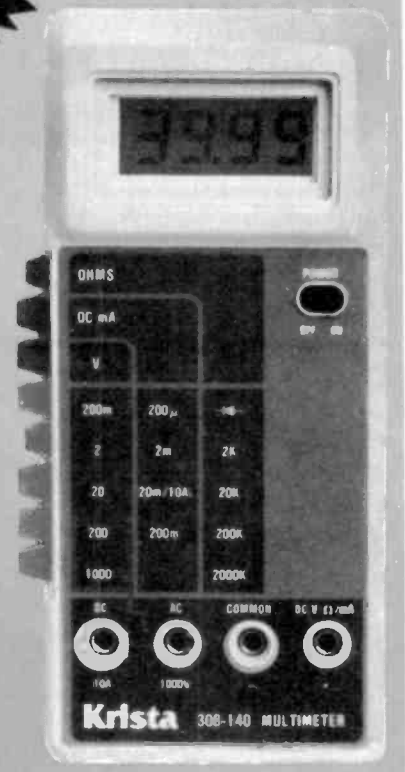

1 Year Warranty

Distributed By

FUJI-SVEA

P.O. Box 3375, Torrance, CA 90510

Toll Free: **1-800-421-2841**

California/Local: **1-213-533-1221**

Shipping/Handling \$4.50 additional. COD Fee \$2.00
California Residents add 6 1/2% Sales Tax

NOW YOUR COMPUTER FITS THE ORIGINAL ARCADE HITS.



DIG DUG
FROM ATARISOFT

**ROBOTRON:
2084**
FROM ATARISOFT

STARGATE
FROM ATARISOFT

PAC-MAN
FROM ATARISOFT

CENTIPEDE
FROM ATARISOFT

**DONKEY
KONG**
FROM NINTENDO
ATARISOFT

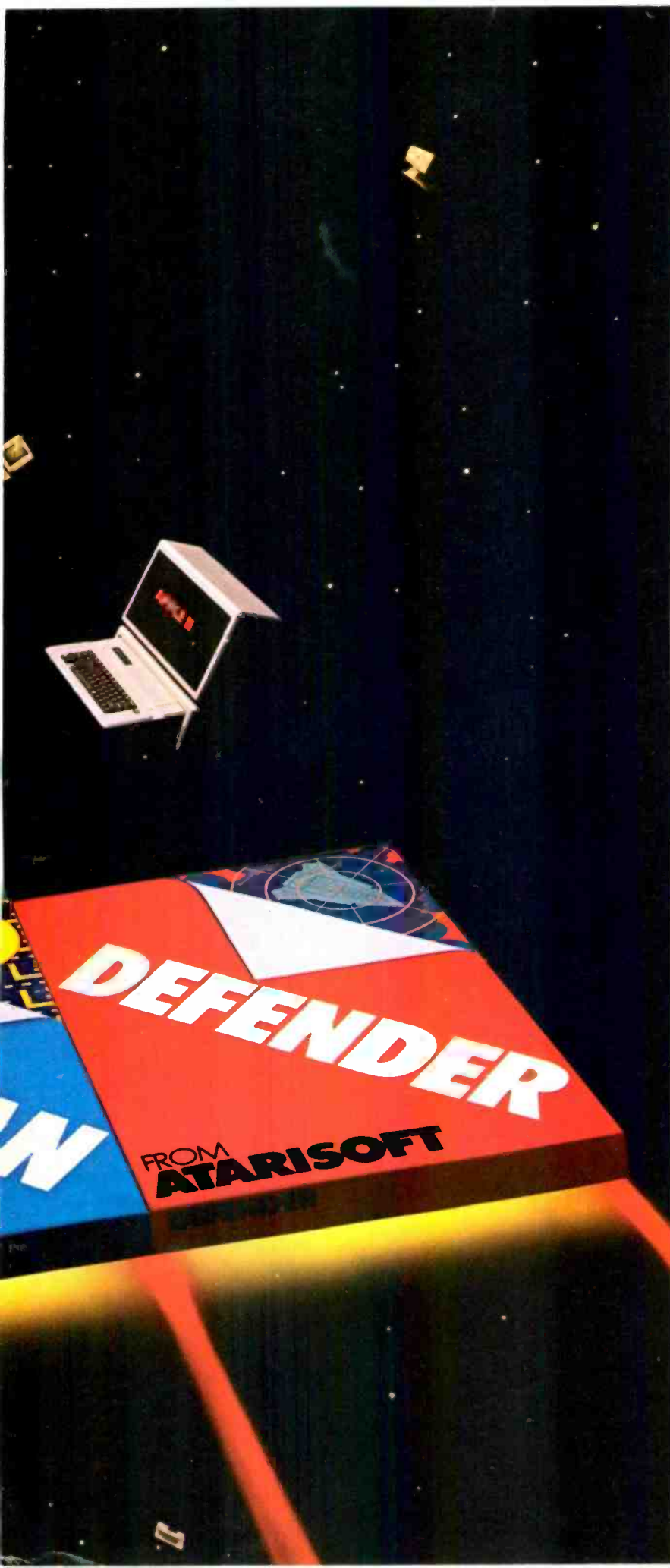

Now the excitement of original arcade graphics and sound effects comes home to your computer.

Introducing ATARISOFT.™ A new source for computer software.

If you own a Commodore VIC 20 or 64, a Texas Instruments 99/4A, an IBM or an Apple II, you can play the original arcade hits.

DONKEY KONG by Nintendo, CENTIPEDE,™ PAC MAN, DEFENDER, ROBOTRON: 2084, STARGATE and DIG DUG. (On the TI 99/4A you can also play Protector II, Shamus, Picnic Paranoia and Super Storm.)

So, start playing the original hits on your computer.

Only from ATARISOFT.

Some games also available on ColecoVision and Intellivision.

ATARISOFT™

Now your computer fits
the arcade hits.

PAC-MAN and characters are trademarks of Bally Midway Mfg. Co. sublicensed to Atari, Inc. by Namco-America, Inc. DIG DUG is created and designed by Namco Ltd. manufactured under license by Atari, Inc. Trademarks and © Namco 1982. DEFENDER is a trademark of Williams Electronics, Inc. manufactured under license from Williams Electronics, Inc. STARGATE is a trademark and © of Williams 1981, manufactured under license from Williams Electronics, Inc. DONKEY KONG, Mario and NINTENDO are trademarks and © Nintendo 1981, 1983. ROBOTRON: 2084 is a trademark and © of Williams 1982, manufactured under license from Williams Electronics, Inc. SHAMUS is a trademark of Synapse Software Corporation, manufactured under license by Atari, Inc. PROTECTOR II is a trademark of Synapse Software Corporation, manufactured under license by Atari, Inc. PICNIC PARANOIA is a trademark of Synapse Software Corporation, manufactured by Atari, Inc. SUPER STORM is engineered and designed by Synapse Software Corporation, manufactured under license by Atari, Inc. A Warner Communications Company. © 1983 Atari, Inc. All rights reserved. ATARISOFT™ products are manufactured by Atari, Inc., for use on the above referenced machines and are not made, licensed or approved by the manufacturers of these machines. COMMODORE 64, VIC 20, TEXAS INSTRUMENTS 99/4A, IBM, APPLE, COLECOVISION and INTELLIVISION are respectively trademarks of Commodore Electronics Limited, Texas Instruments, International Business Machines Corp., Apple Computer, Inc., Coleco Industries, Inc. and Mattel, Inc.

Complete this coupon and we'll keep you up to date on the newest hits from ATARISOFT.™

Name _____

Address _____

City _____

State _____

Zip _____

Telephone _____

PRODUCT OWNED: (Check one)

TI-99/4A

Commodore Vic 20

IBM PC

Intellivision

Commodore 64

Apple II

ColecoVision

Other

Mail to:

Atari, Inc., P.O. Box 2943,
So. San Francisco, CA 94080.

ASM 4

Circle No. 9 on Free Information Card

NEW

PRODUCTS



CP/M FOR COMMODORE 64

Now the Commodore C-64 computer can be made CP/M-compatible with the Convert 80 from Estes Engineering, Inc. The power of CP/M comes from a Z-80 with the capability of a disk drive and DMA controller, all on one card that plugs into the C-64's expansion port. The device's versatility comes from its ability to run CP/M software. The interface card with an 8" disk drive is \$599; with 5 1/4" drive, \$499; and without drive, \$349.

Circle No. 84 on Free Information Card

INTELLIGENT PRINTING BUFFER

Interactive Structures' ShuffleBuffer printing buffer performs mix-and-merge printout operations with any computer equipped with a standard serial or parallel output port. It has the capability of "shuffling" text, graphics, spreadsheet data, and other computer-generated material into any desired combination for printing, plotting, or telephone transmission. It has two additional modes of operation: standard "dumb buffer" function for FIFO printing of material that does not require rearranging or reprinting, and "bypass" to interrupt a printout and produce a separate document on an intermediate basis.

Circle No. 86 on Free Information Card

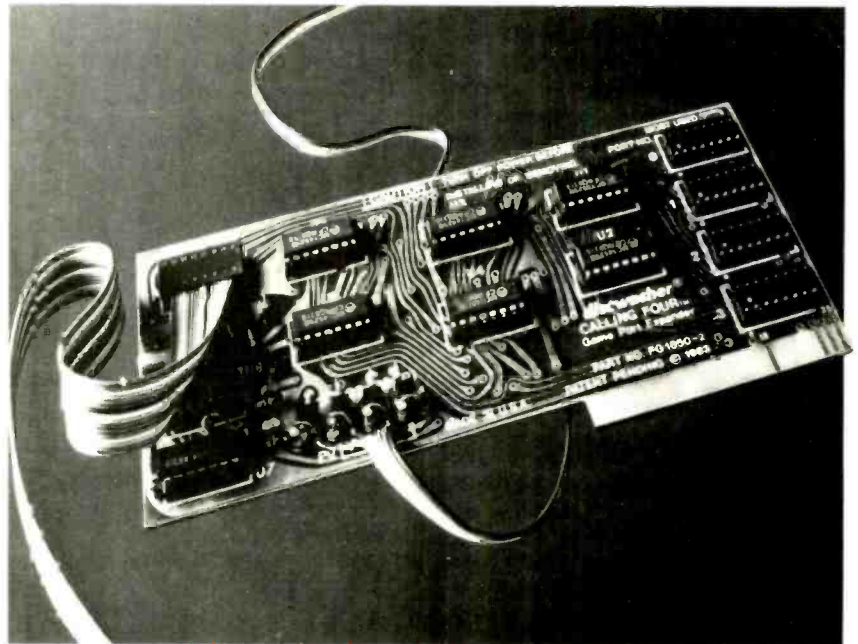
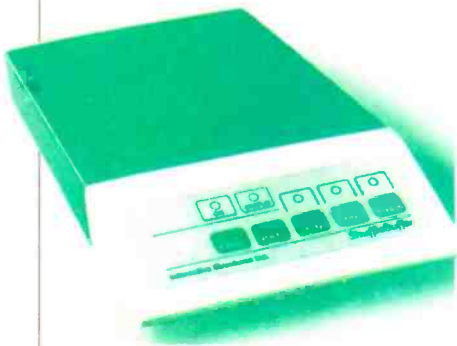

FOUR-GAME CONTROLLER PORT

Discwasher's Calling Four expansion peripheral is designed for use with Apple II, II+, and IIe personal computers. The expander allows the computer to accept such diverse controls as a mouse and a track ball simultaneously, and enables the user to utilize up to four different control devices when writing a program. The card plugs into any one of the

computer's expansion slots. Selection of each control is accomplished through simple keyboard entry or software codes. A LED display is used for indicating which of the four ports is in use. Also provided is a demonstration disk containing two programs that illustrate the unit's features. \$69.95.

Circle No. 85 on Free Information Card

SOFTWARE SOURCES

Financial Planning System. Money Planner from Business Applications Systems is a low-cost financial planning system written for IBM PC and PC-XT and IBM-compatible computers. It lets you plan, budget, forecast, and monitor the effectiveness of your financial activities by providing analyses of three key financial areas: cash flow, net worth, and budgeting. Money Planner is menu-driven and can be used by up to 10 different people or groups, each protected by a special password. Minimum system requirements: 96K of RAM; 80-column video display; two 160K (min.) disk drives; PC-DOS V1.00, V1.10, or V2.00 and diskBASIC; and printer (if print-outs are required). \$34.50 plus \$3.00 S/H. Address: BAS, Inc., PO Box 36008, Oaklandon, IN 46236.

Electronic Spreadsheet. PortaCalc from Skyline Marketing is an electronic spreadsheet program for the Radio Shack TRS-80 Model 100 portable computer. It features a 14-column by 26-row workspace and full use of the built-in function keys to save, load, screen print, report print, and look behind the data at the formulas in use. Worksheets can be saved, loaded, or merged, using the computer's memory or cassette. Often-used templates can be saved in memory for instant recall. Two utility programs are included: Porta-Print is an enhancement of the Model 100's text editor that adds the ability to adjust page length and left, right, and top margins and controls page numbering, headers, centering of lines, flush-right justification, and new page selection. PortaDex is a data exchange program that reformats PortaCalc files into DIF format used by VisiCalc. The program is supplied on tape and requires 24K of RAM. Address: Skyline Marketing Corp., 4510 W. Irving Park Rd., Chicago, IL 60641.

Software Security System. Secure from Wordmovers can transform files into garbled characters that can be unscrambled only by using the same "keys" that scrambled them in the first place. For extra security, it is possible to encrypt a file more than once. The Secure file-protection program can be used with any computer running under CP/M. \$49.95. Address: Wordmovers Inc., 15818 Hawthorne Blvd., Lawndale, CA 90260.



16-BIT MICROPROCESSOR TRAINER

The Model ET-100 Learning Computer from Heathkit/Zenith Educational Systems is an 8088-based trainer, 16-bit computer, and engineering design and test system all rolled into one. Its standard features include a solderless breadboarding system that provides direct access to all address, data, control, and I/O lines, and four voltage supplies; detached typewriter-style keyboard; 32K of ROM programmed with a CP/M assembler, screen editor, and

graphics debugger; 16K (expandable to 64K) of user RAM; cassette port; and composite video output. Price is \$999.95 kit, \$1499.95 wired and tested. Optional extras include the Model EE-8088 Advanced Microprocessors Course (\$99.95) and Model ETA-100 Accessory that adds more memory and I/O ports, disk drive and controller, and a video board (\$1299.95 kit, \$1999.95 wired and tested).

Circle No. 87 on Free Information Card

COMPUTER ROBOT

The Scorpion from Rhino Robots is a small, sophisticated robot kit for the serious computer hobbyist. It is completely software programmable, with two 6522 interface chips providing 32 lines of I/O and four programmable timers (two can be events counters). It can see, make sounds, and move in any direction at 99 different speeds. The Scorpion controls four motors (two are wheel drives), a speaker, two eyes, two ground tracks, and a two-axis optical scanner. The 6502-based robot comes with 8K of EPROM and 2K of RAM, the latter expandable to 64K bytes. It has the ability

to follow a tape on the ground and to read codes on the floor. Its two-axis optical scanner can recognize patterns over a 300° scan horizontally and vertically, with 1.5° resolution of scan per step. The Scorpion follows instructions and answers questions from any host computer with an RS-232C serial interface. \$660.

Circle No. 89 on Free Information Card

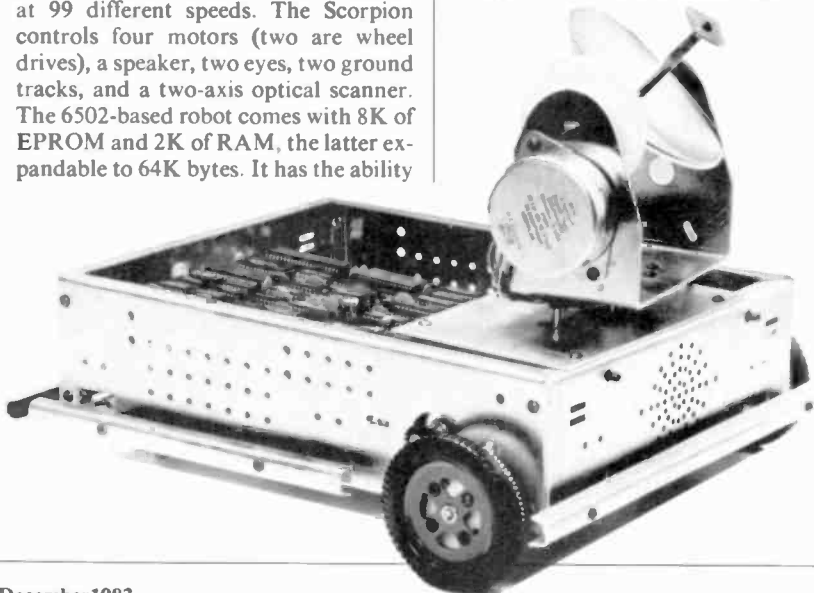

NEW PRODUCTS



INK-JET PRINTER

Radio Shack's TRS-80 Model CGP-220 is a "drop on demand" ink-jet printer that can print text and graphics in as many as seven colors. It prints 2600 dots per second in the graphics mode, with a resolution of 640 dots per line. The text mode offers 12 cpi at a speed of 37 (7 × 5) characters per second. Parallel and Color Computer-compatible serial interfaces (600/2400 baud) permit use of the printer with any Radio Shack computer. A screen print utility for the TRS-80 Color Computer allows the printer to create multicolor printouts of color graphics screens produced from any graphics program. \$699.

Circle No. 88 on Free Information Card

8/16 BIT PERSONAL COMPUTER

The Rainbow 100+ computer from Digital Equipment Corp. offers 8/16-bit processing and built-in 10M hard disk system, plus dual 5¼" floppy drives. It comes with Z80A and 8088 CPUs; 128K of RAM (expandable to 896K); RS-232C/423 printer and asynchronous/synchronous RS-232C/423 communications ports; memory-mapped video; terminal emulation; and computer-based instruction course called Learn Rainbow. Also supplied with the 100+ is DEC's new Investment Protection Plan. \$5475 system unit, \$325 video monitor, \$245 keyboard, \$250 CP/M-80/86 and MS-DOS operating system kit. Owners of Rainbow 100 computers can upgrade to 100+ power with 5M (\$1495) or 10M (\$2995) hard disk kits that come with the operating system kit.

Circle No. 95 on Free Information Card



DAISY-WHEEL PRINTER

NEC's Authentic Model 15-LQ daisy-wheel printer provides 10, 12, and 15 cpi pitch, vertical proportional spacing at 10 and 12 cpi, and print speeds up to 14 cps. The bidirectional printer also features a number of word-processing support functions, including boldfacing, superscripting and subscripting, and automatic underlining. It uses 96-character plastic daisy wheels. The letter-quality printer has a built-in Centronics-type parallel interface for connection to a computer. Includes friction and tractor feed. Dimensions are 17½" W × 5" H × 12½" D. \$695.

Circle No. 94 on Free Information Card

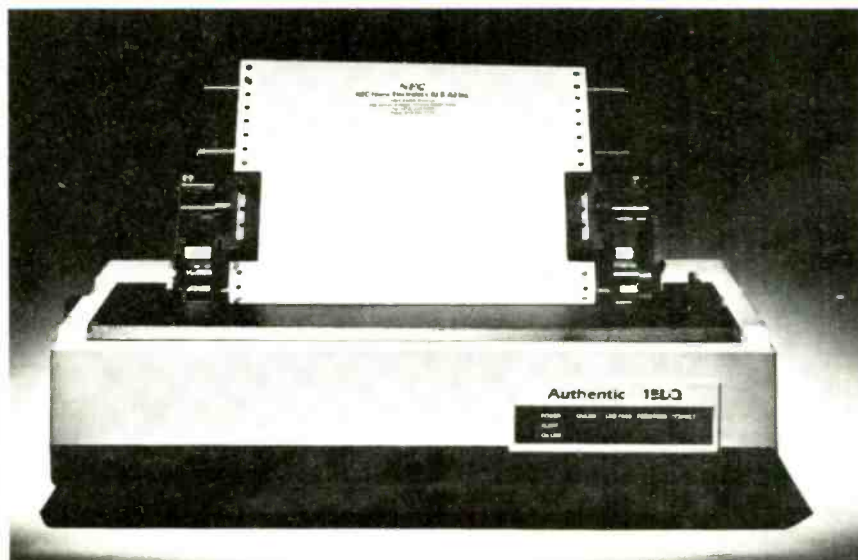



ALL THE HARD PART IS MAKING SURE MINI DISKS COME ERROR FREE.

THEY STAY THAT WAY.

A disk is built with certain safeguards. That's why most disk makers offer guarantees that the product you receive comes to you error free.

We at Memtek Products are concerned that the minidisk remains error free. *Every* time you use it. After exposure to dust, cigarette smoke, fingerprints, even wear caused by your computer. And so, we have built safeguards around the disk, as well.

Memtek Products' latest innovation... acknowledgment of a real world beyond the laboratory.

The hub ring. Designed to prevent our min disks from jamming in your machine. Rigid. Durable. Reinforced.

The coating. A critically-controlled coating of high-energy magnetic oxide particles that covers the disk's surface, which is then micro-polished to improve head to disk contact, preventing dropouts, lowering head abrasion.

The lubrication system. A constant lubricant protects both the disk surface and the drive head from wear.

The sleeve. Comes with a soft liner that protects the disk while gently cleaning the surface.

The guarantee.

We'll replace, free, any minidisk if it fails to accurately store and retrieve data due to a defect in materials or workmanship for up to 5 years from date of purchase. Simply mail the disk back.

The Memtek lineup.

Premium, double and quad density minidisks as well as 10- and 15-minute computer cassettes and a 5¼" disk drive head cleaner.



**WE PLAY
FOR KEEPS™**

NEW PRODUCTS

LOGIC ANALYZER ADD-ON



OmniLogic's Model LA-1680 16-channel logic analyzer is an add-on for Radio Shack TRS-80 Models I, III, and 4 computers with 48K of RAM. It provides both state and timing analysis at frequencies up to 20 MHz. Simple menu-driven operation, with "help" pages, are

provided for every command and display. The LA-1680 can collect 1000 data samples on each of 16 channels. Triggering modes include the basic AND/OR/NOT, with the trigger point positioned within the 1000-word sample memory. Advanced triggering modes

include absence of repetitive event, repeat until correlated with reference memory, and delay by event or time. External trigger and trigger qualifier are also provided. Two connectors supply clock and trigger outputs. \$1250.

Circle No. 92 on Free Information Card

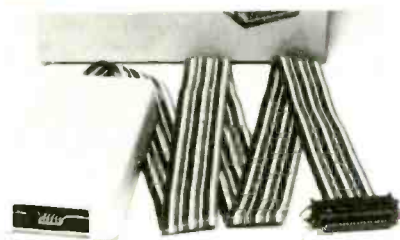

COMPUTER/TYPEWRITER SERVICE

Supercord from Cord Ltd. is a patented interface that links nine different electronic typewriters to an even wider variety of personal computers. It is offered in a range of different combinations to enable attachment to specific computers and typewriter models, including RS-232C serial, IEEE-488, and Centronics parallel interfaces. Among the typewriters supported are those from Adler, Brother, Royal, Smith-Corona, and Silver-Reed, with more to come. There is also a Supercord II model that contains a 4K block of print buffer. \$395. Address: Cord Ltd., 1548 Brookhollow Dr., Santa Ana, CA 92705.

SOFTWARE SOURCES

Graphics Program. Grafox is a stand-alone graphics program written for the IBM PC computer. This is a business graphics package with full color capabilities that draws information directly from any IBM BASIC file or via the Data Interchange Format (DIF). The program is visually oriented and easy to learn, with menu-driven chart description procedures and single-keystroke commands for producing bar, pie, piebar, and line charts. It has the ability to select, sort, average, and total data drawn directly from other databases and then chart it in a variety of ways. \$295.

Circle No. 13 on Free Information Card

Introductory Science Software. Software Arts has a new TKISolverPack for Introductory Science. It includes 12 models, each of which contains the necessary equations, values, and tables for solving particular problems in physics, chemistry, and biology. The models can be used in introductory-level science courses in secondary schools and colleges. The models are usable as is, but

can easily be modified by the user. The software package is currently available for the IBM PC and will run in the DEC Professional 350 and Rainbow 100 and Wang Professional computers. \$100

Circle No. 18 on Free Information Card

Spelling Checker. Sensible Software has released an improved version of its spelling verification program for use in Apple computers. When used with Apple DOS word processing files, the new Sensible Speller IV displays suspect words in context and allows immediate correction of misspelled words. The program also features extensive dictionary-searching capabilities and automatic suggestion of correct spelling for misspelled words. In addition to the improved version for use with Apple DOS word processors, each Sensible Speller package includes versions for use with Apple CP/M, Apple Pascal, and Silicon Valley's Word Handler word processor. \$125. Address: Sensible Software, Inc., 6619 Pelham Dr., West Bloomfield, MI 48033.



LAST NIGHT, COMPU SERVE TURNED THIS COMPUTER INTO A TRAVEL AGENT FOR JENNIE, A STOCK ANALYST FOR RALPH, AND NOW, IT'S SENDING HERBIE TO ANOTHER GALAXY.

NO MATTER WHICH COMPUTER YOU OWN, WE'LL HELP YOU GET THE MOST OUT OF IT.

If you've got places to go, CompuServe can save you time and money getting there. Just access the Official Airline Guide Electronic Edition—for current flight schedules and fares. Make reservations through our on-line travel service. Even charter a yacht through "Worldwide Exchange."

If your money's in the market, CompuServe offers a wealth of

prestigious financial data bases. Access Value Line, or Standard and Poor's. Get the latest information on 40,000 stocks, bonds or commodities. Then, consult experts like IDS or Heinold Commodities. All on line with CompuServe.

Or if, like Herbie, intergalactic gamesmanship is your thing, enjoy the best in fantasy, adventure, and space games. Like MegaWars, the ultimate computer conflict.

To get all this and more, you'll

need a computer, a modem and CompuServe. CompuServe connects with almost any personal computer, terminal, or communicating word processor. To receive an illustrated guide to CompuServe and learn how you can subscribe, contact or call:

CompuServe

Consumer Information Service, P. O. Box 20212
5000 Arlington Centre Blvd., Columbus, OH 43220
800-848-8199
In Ohio call 614-457-0802.

Circle No. 60 on Free Information Card

An H&R Block Company

NEW PRODUCTS

HARDWARE/SOFTWARE DEBUGGER

A powerful hardware/software debugging tool for program development on the IBM PC and compatible systems, called the PC Probe, has been introduced by Atron Corp. It consists of a plug-in card that fits into any available expansion slot in the computer, an umbilical cable and probe that plugs into the computer's 8088 socket, and sophisticated debugging software on a floppy diskette. Designed for all standard PC high-level languages, the PC Probe contains all necessary support for debugging. Since it can access all PC bus signals, as well as the CPU, the device can monitor and trap on interrupts and DMA requests. The Probe's software, including symbol and macro tables, are contained in 64K of on-board memory-protected RAM. \$1595.

Circle No. 93 on Free Information Card

LETTER-QUALITY PRINTER

Olympia's Model ESW 3000 is a formed-character, letter-quality printer designed for high-speed printing. Microprocessor-controlled, it features automatic shortest-path-seeking logic and bidirectional paper and carriage movement. Printing speed averages 40 characters/second, using 100-character

printwheels. The printer can handle forms up to 17" wide and offers 10/12/15-pitch selection, with $\frac{1}{120}$ " horizontal microspacing. Vertical spacing can be $\frac{1}{8}$ ", $\frac{1}{4}$ ", or $\frac{1}{6}$ " and offers 96 positions/in. bidirectionally. Among the printer's attributes are: bidirectional horizontal and vertical tabulation; bold, expanded, and double-print enhancements; ability to produce up to seven copies on a single pass; automatic paper feed to top of form; 4K print buffer; RS-232C serial, Centronics-compatible parallel, and IEEE-488 interfaces; and control panel. Options include a bidirectional forms tractor and a sheet feeder.

Circle No. 90 on Free Information Card

SOUND PROCESSING SYSTEM

The DX-1 Sound Processing System from Decillionix is a hardware/software package for the Apple II computer for recording, processing, and playing back real sound. The record and playback technique is eight-bit analog-to-digital and digital-to-analog "sound sampling." With one of the system's six software menus, a collection of pre-recorded sounds can be played in real time on the Apple keyboard. With another menu, random reproduction of real sounds can be generated. Other software menus enable the user to record and reproduce any sound, and include the ability to program variations in pitch, volume, duration, and sequence. Sounds can be played in reverse and also stored on disk. The DX-1 plugs directly into any slot in the Apple II or IIe and accepts low-to-medium-level signal sources, including a microphone. \$239. Address: Decillionix, PO Box 70985, Sunnyvale, CA 94086.

(Continued on page 20)

LOCAL AREA NETWORK

The PerComNet PN-IBM interface card for the IBM PC is a local area network from Percom Data. It is designed around the Western Digital WD2840 control processor to give the host computer the ability to permit key peripherals, like a hard disk drive, to be shared among two or more computers. Its features include: token passing reliability; 64K FIFO buffer; signal regeneration at each node; user installation simplicity;

NBS encryption for data security; support for simultaneous voice/data security transmissions; and operating-system compatibility for MS-DOS, CP/M, and Unix. The network interface plugs into the IBM PC or similar computer and is then linked to the network through a unique Percom Data cable interface. PerComNet interface adapters will soon be available for S-100, Multi-Bus, and STD Bus microcomputers.

Circle No. 91 on Free Information Card

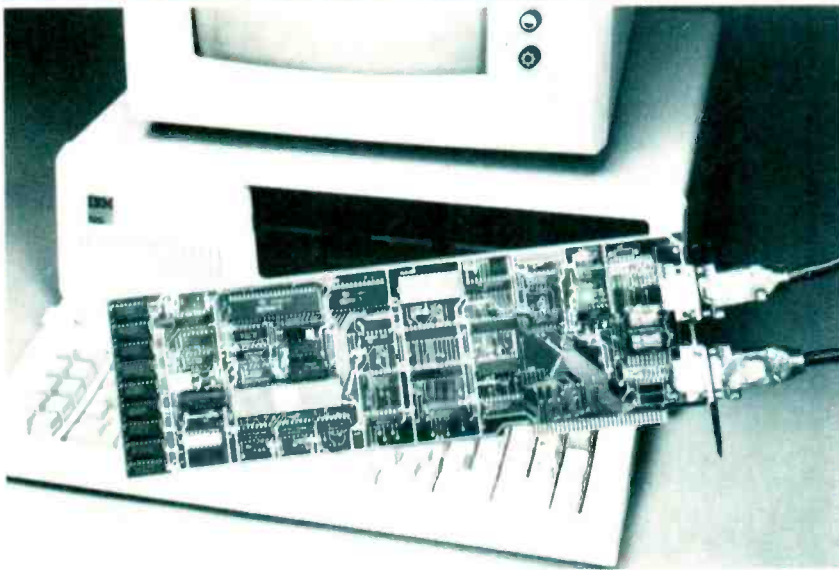
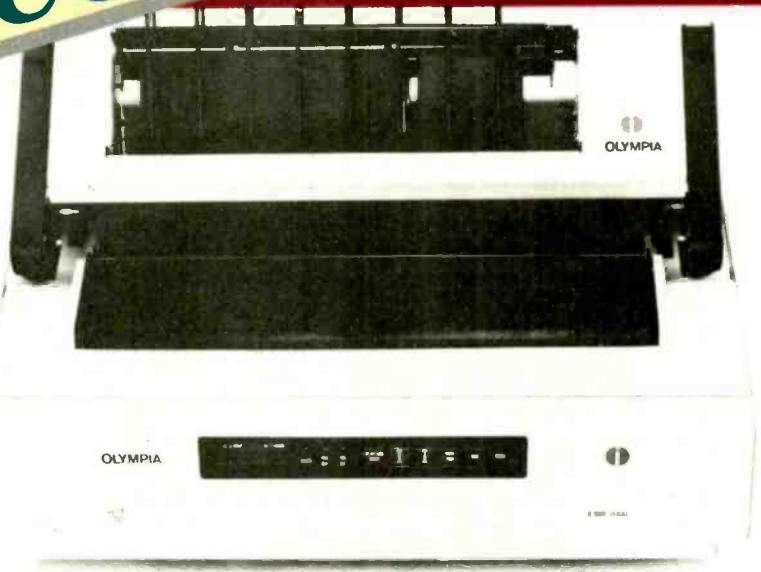

It writes, rates, creates, even telecommunicates. Costs less, does more- the Commodore 64.



When Commodore introduced the 64, the industry suddenly realized that there would be a computer in every home, school and business years before anyone ever dreamed.

That's because Commodore 64 halved the price of high technology: while you can compare the 64's capabilities with those of any sophisticated business PC, you can compare its price with that of an average television.



What can you do with it? Create with its high resolution Sprite Graphics. Add a printer and type with it. Add a disk drive to use spread sheets and other financial programs. Learn and play music through your home sound system on the 64's professional quality music synthesizer.

Add a modem, and hook up with the vast computer networks through your telephone. In short, the Commodore 64 is the ultimate personal computer, at a price you can afford.

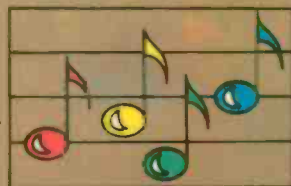

COMMODORE 64

Circle No. 29 on Free Information Card



Wouldn't you like to have a new skill you could call your own? Learn TV, audio, and video servicing with at-home training from NRI.

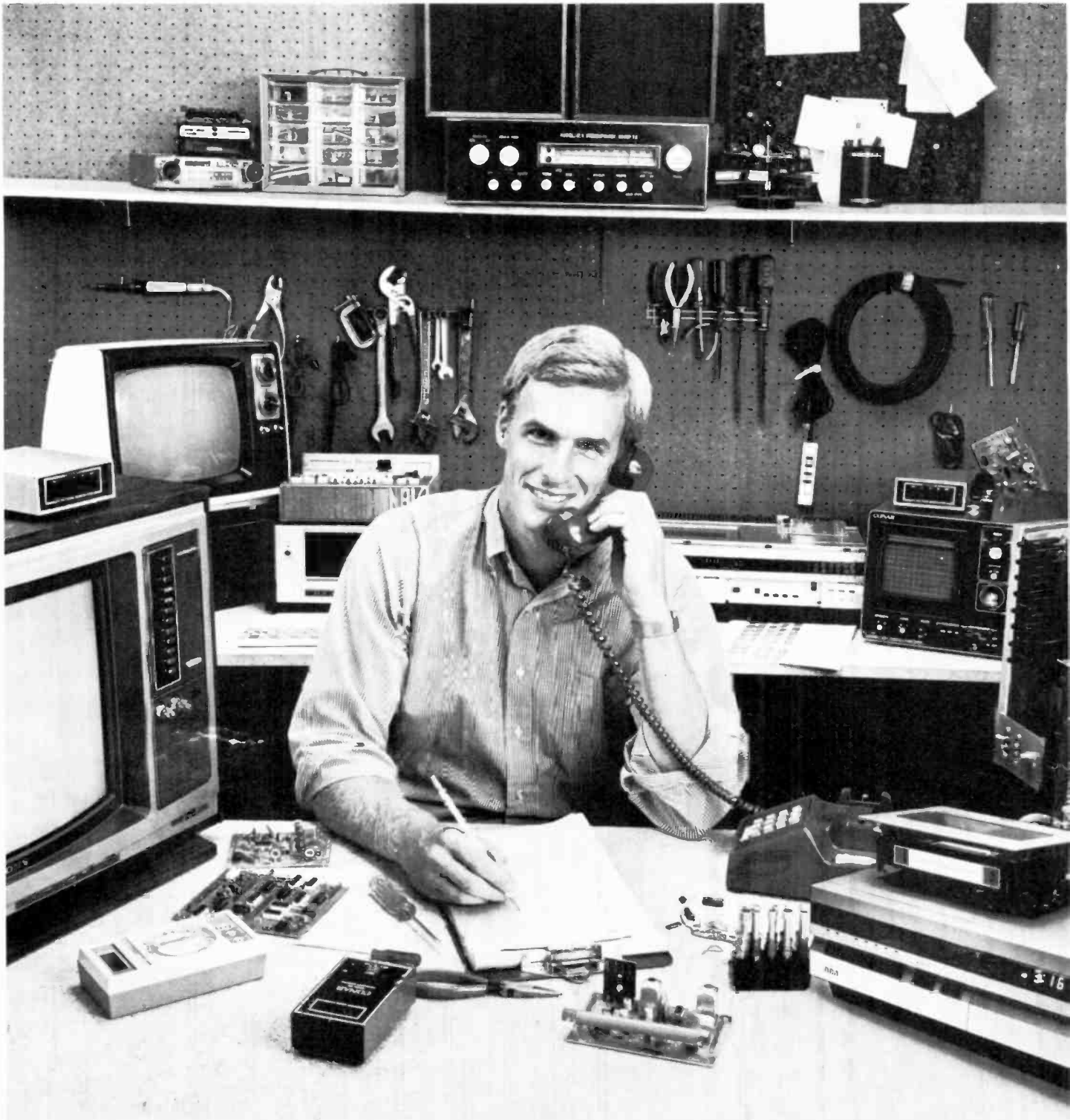

You can learn to service and repair TVs, stereos, electronic musical instruments and amplifiers, car and portable radios, record and tape decks, videocassette recorders and disc players, almost any kind of electronic equipment on the market. And you can learn to do it at home, in your spare time, without quitting your job or wasting time and gasoline on night school. NRI will train you, as it has over a million and a quarter others, with effective methods proven over 69 successful years.

Hands-On Training

NRI training is practical training all the way. Throughout your course, you'll perform hands-on experience projects that make theory come to life and give you real understanding.

Includes Both 25" TV And VCR, Plus DMM And More

As part of your training, you'll build your own 25" Heath/Zenith color TV, a state-of-the-art unit with infrared remote tuning, programmable channel selection, and the incredible space phone for remote calling. You also get a front-loading, remote-controlled videocassette recorder to play your videotaped lessons and learn about servicing this complex instrument.



Practical training on a real state-of-the-art TV, VCR or stereo, using professional equipment

You'll learn troubleshooting techniques using a professional 3½-digit digital multimeter. You'll use it when assembling your TV to check demonstration circuits you build on the NRI Discovery Lab, and in your professional work. It's the equipment and training you need for success.

Exclusive NRI Training On Videotape

In addition to profusely illustrated lessons, you get NRI Action Videocassettes . . . videotaped lessons that show you graphic presentations of electronic systems, vivid closeups of servicing techniques and professional "shortcuts" to study and replay as often as you want.

Training For Success

NRI not only prepares you to become a top technician, we get you ready for independence. NRI Video/Audio servicing gives you a great new way to earn

extra money doing part-time servicing for appliance and department stores—building a good-paying, new career with an electronics firm . . . or even starting your own business. You can start small, even part-time in your basement or garage, make the most of your opportunities to grow into a successful businessman.

Free Catalog . . . Mail Card Today

Send the postage-paid card for our free 104-page color catalog describing our courses in full, showing all equipment, lesson outlines, and career opportunities. It also shows other exciting courses like Microcomputers, Electronics Design, Industrial Electronics, Digital Electronics, and more. Mail the postage-paid card today for your copy. And



see how you can make the most

of your talent. If card has been removed, please write to:



NRI Schools of Electronics
McGraw-Hill Continuing Education Center
3939 Wisconsin Avenue
Washington, DC 20016

We'll give you tomorrow.

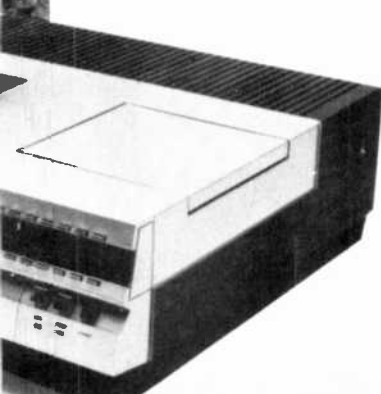

NEW PRODUCTS

SOFTWARE SOURCES

Program Library System. The Arranger II from Triple-D Software provides an automatic means for organizing program libraries. It gathers every program name and useful information about each disk (type of DOS, number of tracks, free space, system or data file) and compiles and stores it on its own disk for future reference. A unique name or number is recorded on each disk in the user's library. Arranger II can then rapidly locate any desired program and print out alphabetical program lists, individual disk contents, free disk space chart, disk labels, and more. The software has an 11,000-word capacity, with 255 per disk. \$49.95. **Address:** Triple-D Software, PO Box 642, Layton, UT 84041.

Text Processor. Logical Systems' The BASIC Answer (TBA) runs on the TRS-80 Model 4 computer under TRSDOS 6.x and 5.1, and on the TRS-80 Models I and III and Lobo Systems Max-80 under 5.1. This is a text-processing utility designed to allow the programmer to construct BASIC code in a

structured manner. TBA allows the BASIC programmer to produce structured, self-documenting code and supports the use of labeled branching that results in relocatable BASIC subroutines. In addition, variable names and labels of up to 14 significant alphanumeric characters are supported. Through "conditional translation," production of multiple program versions is greatly simplified. Global and pseudo-local variable types are supported. \$69.00 for TRS-80 Models I, III, 4, and Lobo Systems MAX-80 TBA V5.1; \$79.00 for TBA V6.x (add \$4.00 S/H

for each). **Address:** Logical Systems, Inc., 8970 N. 55 St., PO Box 23956, Milwaukee, WI 53223.

Tree-Forth. Soft Magic Corp. has announced availability of a version of Forth for the Sinclair and Timex lines of computers. Called Tree-Forth, it is a compiler (not interpreter) directive that operates about 10 times faster than interpreter BASIC, while providing the conversational attribute of BASIC. Tree-Forth is supplied in a 64K EPROM chip that replaces the ROM chip inside the computer. \$49.95 plus \$2.00 S/H. **Address:** Soft Magic Corp., 1210 W. High St., Bryan, OH 43506.

RGB VIDEO MONITOR

The Taxan Model RGBvision 420 is designed to be an IBM-look-alike RGB color video monitor with high-resolution graphics capability at 630 horizontal lines, 0.38-mm dot slit, and 20-MHz bandwidth. Other features include a black-stripe, nonglare picture tube; a mode selector switch for use with computers other than IBM; contrast control; and horizontal, vertical, and screen size controls. \$699. **Address:** TSK Electronics Corp., 18005 Cortney Ct., City of Industry, CA 91748.

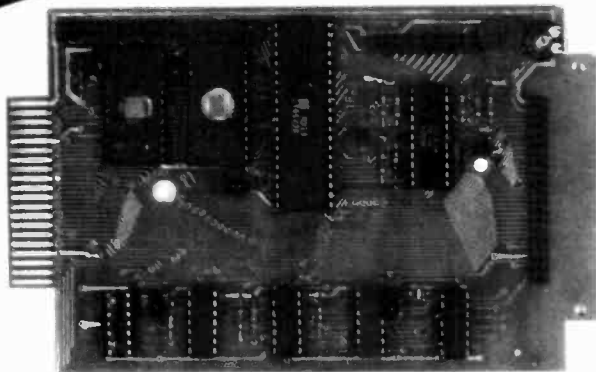

MULTI-FUNCTION SUBSYSTEM

Magnum Distributing has announced availability of the Model CMJ-1F multifunction subsystem for the Radio Shack TRS-80 Color Computer and TDP System 100 personal computer. The device plugs into the cartridge port and provides a speech synthesizer, one serial and two parallel ports, 4K or 8K of EPROM/ROM space, two counter/timers, and an extender port. The

speech synthesizer is said to be able to vocalize any word in any language and is accessed through BASIC. The extender port enables the user to access a disk controller or ROMPAK without having to disconnect the CMJ-1F from the computer. \$199.95. **Address:** Magnum Distributors, Inc., 1000 S. Dixie Hwy. W., Suite 3, Pompano Beach, FL 33060.

structured manner. TBA allows the BASIC programmer to produce structured, self-documenting code and supports the use of labeled branching that results in relocatable BASIC subroutines. In addition, variable names and labels of up to 14 significant alphanumeric characters are supported. Through "conditional translation," production of multiple program versions is greatly simplified. Global and pseudo-local variable types are supported. \$69.00 for TRS-80 Models I, III, 4, and Lobo Systems MAX-80 TBA V5.1; \$79.00 for TBA V6.x (add \$4.00 S/H

for each). **Address:** Logical Systems, Inc., 8970 N. 55 St., PO Box 23956, Milwaukee, WI 53223.

Tree-Forth. Soft Magic Corp. has announced availability of a version of Forth for the Sinclair and Timex lines of computers. Called Tree-Forth, it is a compiler (not interpreter) directive that operates about 10 times faster than interpreter BASIC, while providing the conversational attribute of BASIC. Tree-Forth is supplied in a 64K EPROM chip that replaces the ROM chip inside the computer. \$49.95 plus \$2.00 S/H. **Address:** Soft Magic Corp., 1210 W. High St., Bryan, OH 43506.

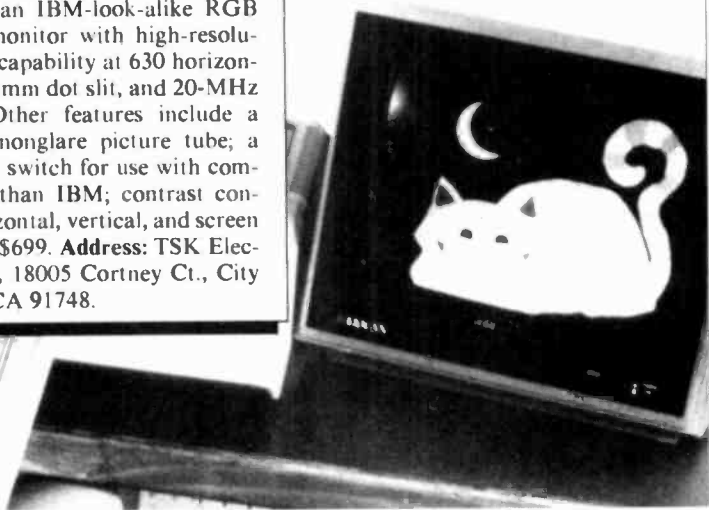



The Computer Book Club®

Your source for software and books at substantial savings!

More programs, more projects, more ways to use your micro for home, hobby, and business!

Select any 6 books for only \$2.95 when you join (values to \$132.70)



7 very good reasons to try The Computer Book Club®

P.O. Box 80 Blue Ridge Summit, PA 17214

- **Exceptional Quality.** All books are first-rate publisher's editions filled with useful, up-to-the-minute information
- **Reduced Member Prices.** Save 20% to 75% on books sure to increase your computer know-how
- **Satisfaction Guaranteed.** All books returnable within 10 days without obligation
- **Club News Bulletins.** All about current selections—mains, alternates, extras—plus bonus offers. Comes 13 times a year with dozens of up-to-the-minute titles you can pick from
- **"Automatic Order."** Do nothing, and the Main selection will be shipped automatically! But . . . if you want an Alternate selection—or no books at all—we'll follow the instructions you give on the reply form provided with every News Bulletin
- **Continuing Benefits.** Get a Dividend Certificate with every book purchased after fulfilling membership obligation, and qualify for discounts on many other volumes
- **Extra Bonuses.** Take advantage of added-value promotions, plus special discounts on software, games, and more



The Computer Book Club®

P.O. Box 80
Blue Ridge Summit, PA 17214

Please accept my membership in The Computer Book Club® and send the 6 volumes circled below, billing me \$2.95 plus shipping and handling charges. If not satisfied, I may return the books within ten days without obligation and have my membership canceled. I agree to purchase 4 or more books at reduced Club prices (plus shipping/handling) during the next 12 months, and may resign any time thereafter.

335 1062 1160 1183 1195 1199 1228
1251 1276 1277 1295 1333 1369 1396 1398
1427 1431 1453 1455 1466 1513 1521 1523
1531 1539 1556 1612 1620 1633 1637

Name _____ Phone _____

Address _____

City _____

State _____ Zip _____

Valid for new members only. (Orders outside U.S. or Canada must be prepaid in International Money Orders in U.S. dollars. Canada must remit in U.S. dollars.) This order is subject to acceptance by The Computer Book Club® PECC-1283

LES SOLOMON ON COMPUTER HARDWARE



An Eye- and Temper-Saving Proposal

IT seems every computer, video game, VCR, or closed circuit TV camera that has provisions for using a TV receiver as a video display employs either channel 3 or channel 4 on the vhf band. There are some other electronic items that use different channels, but they are in the minority.

I called the FCC to try to find out why channels 3 and 4 are so popular. Well, it seems that there is no regulation covering this channel usage; and the whole thing boils down to a sort of "grandfather's clause." (If the FCC wants to clear this up with me, let someone there drop me a line.)

I never liked these channels anyway. Where I work in midtown Manhattan there is terrific r-f power on Channel 2 (CBS) and Channel 4 (NBC). Even with the protective guard band between channels, when using channel 3 (or any other vhf channel) for viewing a computer display, I get enough adjacent-channel interference to make a mess of the video.

Assuming that computers and video games have FCC type approval (as indicated by little labels on the back or underside), does this mean that receiver r-f and i-f design and shielding leaves something to be desired? If so, why do people blame the computer when it's really the TV receiver that's at fault?

It must be a masochist's fantasy come true when he tries to use a channel-3/4 video system in areas where good signals are received on channels 2, 3, 4, and 5. This must make displays for computing and game playing really great!

On the other hand, isn't it nice that some major TV receiver manufacturers are providing a direct video input jack on some of their newer models. To these wonderful folks: Welcome to the computer age!

[Incidental technical note: Channels 4 and 5 can both be used in the same area. Although they are numerically adjacent, they are not frequency-adjacent, since there is a 4-MHz gap between them. There is also an 86-MHz gap (including the FM band) between channels 6 and 7.]

To get a clear display when testing a system here in New York, I have been using a modulator on a high-uhf channel where nobody lives for a bucketful of MHz in either direction (at least around here), and the spectrum is quiet. I am not quite certain that this is legal, but it makes a big difference in the display.

Really, what I want to know is, since the FCC has previously assigned special "quiet" frequencies (10.7 MHz for FM i-f, 43 MHz for TV i-f, etc.), why not assign an unused high-uhf band to be used strictly by computer and video game signals?

There are wide areas of unused uhf frequencies between channels 14 through 83. Why can't we use r-f modulators on an empty channel in the range? We would not interfere with anyone and could watch clean displays for a change.

Protection Circuit. Being an avid dabbler in hardware, I have created my fair share of accidental short circuits. To save the cost of replacing relatively expensive voltage regulators and power supplies when I make such mistakes, I have recently concocted an automatic power-down protection circuit. A schematic is shown in the accompanying diagram.

The circuit is faster than a fuse and

automatically "resets" itself when the short is removed. The normal regulated dc input line is opened, and a phototransistor or photoresistor (any type that can handle the current) is connected in series with the source and regulator. Between the output of the regulator (which can be almost any desired voltage) and ground is a LED and an associated current-limiting resistor, whose value depends on the dc voltage being monitored. The LED is placed physically close to the surface of the photosensitive device and the two are covered by a layer of black electrical tape to form a light-tight enclosure. As long as the regulator is delivering its rated output, the LED glows and causes the photo device to have a low resistance. Full current is thus allowed to flow.

If, for any reason, a short circuit occurs on the output side of the regulator, the LED goes dark, the resistance of the photo device increases, and the regulator shuts off. When the short is removed, the LED glows, and the regulator resumes operation.

Like most of the circuits I have discussed in this column, this one is basic, and the reader is urged to experiment with it. For example, if your power requirements are more than a simple photo device can handle, use a high-power npn transistor whose base is driven by the photo device, which, in turn, is controlled by the LED. In fact, not even the regulator is required since this protection circuit can be used as "plain vanilla" in series with the power lead. Once you get the idea of how the thing works, it's simple. So why not try your ideas. ◇

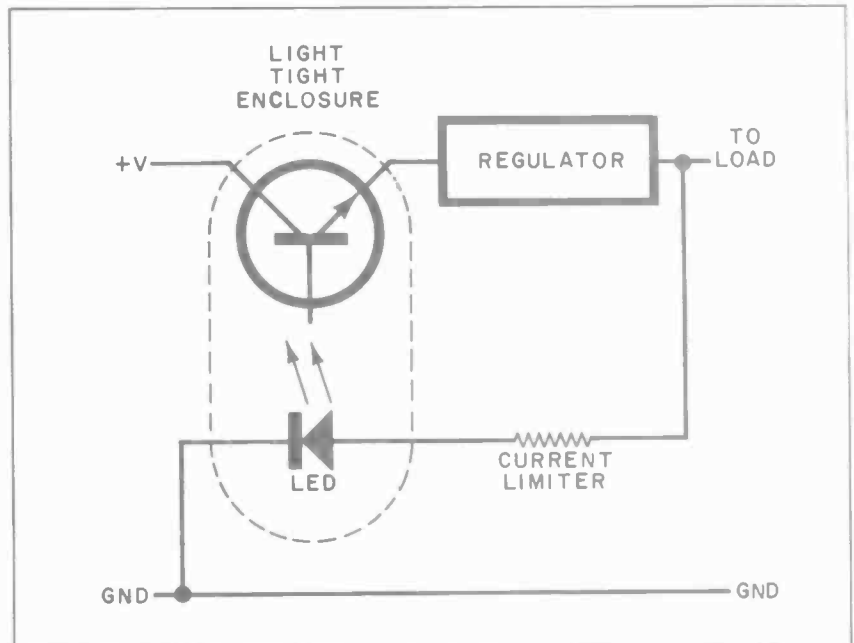

Where's Your **ELECTRONICS** Career Headed?



The Move You Make Today Can Shape Your Future

Yes it's your move. Whether on a chess board or in your career, you should plan each move carefully. In **electronics**, you can *move ahead* faster and further with a

B. S. DEGREE

Put professional knowledge and a COLLEGE DEGREE in your electronics career. Earn your degree through independent study at home, with Grantham College of Engineering. No commuting to class. Study at your own pace, while continuing your present job.

The accredited Grantham non-traditional degree program is intended for mature, fully employed workers who want to upgrade their careers . . . and who can successfully study electronics and supporting subjects through

INDEPENDENT STUDY, AT HOME

Free Details Available from:

Grantham College of Engineering
2500 South La Cienega Blvd.
P. O. Box 35499
Los Angeles, CA 90035

Independent Home Study Can Prepare You

Study materials, carefully written by the Grantham staff for independent study at home, are supplied by the College, and your technical questions related to those materials and the lesson tests are promptly answered by the Grantham teaching staff.

Recognition and Quality Assurance

Grantham College of Engineering is accredited by the Accrediting Commission of the National Home Study Council.

We are located at 2500 S. LaCienega Blvd., Los Angeles, California, but for faster response please use our mailing address: P. O. Box 35499, Los Angeles, CA 90035.

Grantham College of Engineering ET-12-83
P. O. Box 35499, Los Angeles, CA 90035

Please mail me your free catalog which explains your B.S. Degree independent-study program.

Name _____ Age _____

Address _____

City _____ State _____ Zip _____

Bits & Bytes

NEWS, VIEWS & GOSSIP/BY SOL LIBES

RUMORS & GOSSIP

► Look for Commodore to shortly discontinue the VIC-20, drop the price on the 64 even further, and introduce a new portable machine using the Z8000 16-bit microprocessor to sell in the \$500-to-\$600 range. The aim is to undercut new entries from IBM and Apple. . . . Shugart is expected to start demoing its laser-based optical disk soon. Word is that it will cost \$5000 or so and store 1.5 gigabytes (that's 1,500,000,000 characters), and you will not have to worry about a head crash when you bump it or get dirt or moisture on the disk. . . . Atari anticipates the debut of a home computer with integrated telephone and the capability to control home appliances and heating/cooling systems. . . . Sharp Corp., which recently demonstrated a portable computer with an 8-line by 80-character display, is reportedly on the verge of bringing out a liquid-crystal display with a capacity of 24 lines by 80 characters. . . . Beta testing of Version 3.0 of MS-DOS, which was supposed to begin in June, has reportedly been moved to September. This probably means that the product may not appear until next year. It is still not clear whether Version 3 will be adopted by IBM for the PC. Talk is that the new version will include features such as multitasking, mouse input, and enhanced graphics capability. . . . Meanwhile, Apple is expected to present its long-rumored "Macintosh" computer in January with first deliveries to customers expected in February. It is expected to be a 68000-based transportable unit having a 9" display, a resolution of 512 × 375 pixels, and 128K bytes of RAM, and to sell for well under \$1500. Reports are that the unit will use a 3.5" floppy storing a full megabyte, and have a significant portion of the system software in ROM and a user interface similar to the Lisa. When the Mac appears, I expect to see the price of the Apple IIe drop to \$700 or under and become available to mass merchandisers. . . . Anticipated soon from several vendors are Winchester with intelligent interfaces that contain microprocessors capable of re-microcoding themselves to adapt to their environment. In other words, they would contain their own operating systems. It will be possible with this system for the drive to have a signature that marks it by lot and manufacturing date. This could be used to ward off software pirates. The chip to do this is already in evaluation by disk designers. . . . Gavalin shook the industry with the May premiere of a true full-function portable priced at just under \$4000. Now there are rumors that a similar machine is due shortly for one-third the price. . . . It is said that Microsoft will have a plug-in board for the IBM PC that replaces the 8088 microprocessor with an 80286 true 16-bit unit so that users can run Xenix, Microsoft's version of the Unix multi-user, multiprocessing operating system. . . . It is anticipated that Radio Shack will, later in 1984, introduce a new TRS-80 Model 100-like portable that is IBM PC compatible. It will use a CMOS version of the 8086 microprocessor that is now available in sample quantities. The Model 100 (which is currently the hottest selling portable on the market) now uses the CMOS version of the Intel 8085 8-bit microprocessor.



APPLE DOINGS

► Apple, once the bread and butter of Computerland sales, has been largely replaced by the IBM PC. Last year, when Apple tried to renegotiate a better contract with Computerland, the franchiser balked and dropped the line. Many of the Computerland stores were then forced to buy their Apple equipment directly from Apple, losing their Computerland discount, while still paying an 8% royalty to Computerland on each sale. The result was that Computerland stores selling

Apples were at a serious disadvantage compared to independent retailers. Unable to compete with price discounts, many Computerland stores dropped the Apple. Apple responded by reducing the price on equipment, offering it to more retail outlets such as department stores, and packaging together systems with more competitive prices.

Apple has disclosed that it has filed suit against 28 Hong Kong companies selling copies of the Apple II and that, in all but five cases, it has succeeded in getting restraining orders. The units, which sell for as low as \$300, are for the most part made in Taiwan and imported to Hong Kong. Some even bear the Apple nameplate logo.

Another Apple-II compatible machine, called the "Dragon," that has been widely sold in Europe, is expected to be marketed soon in this country by Tano Corp., New Orleans, LA. The price is expected to be \$400 less than that of the Apple IIe.

In the meantime, Apple declared over \$42 million in profits for the last quarter, a 59% increase. It also announced production of its millionth computer and shipped the Lisa right on schedule. However, demand for the IIe has reportedly flattened out as business-user sales have decreased. The bulk of the IIe sales are now to the home and school markets.

Apple has run into some new challenges with the Lisa. Many customers are complaining about the hard disk drive's limited capacity (only 5M bytes with about 4M bytes used by the Lisa software, leaving only about 1M byte for the user's files) and slowness in reading. (It can take more than half a minute to load the word processor and a text file before one can enjoy the machine's marvels.) The company is expected shortly to upgrade the Lisa to a faster drive with 10M-byte capacity. Secondly, Lisa floppy disks, which are unique to the Lisa, are scarce as hens' teeth.

Apple is soon expected to introduce an option for the Lisa to enable it to run IBM PC software. This project is reportedly being handled by Microsoft for Apple, with the product becoming available by '84. The option is seen as an important asset for the business world. Users will then be able to run the Lisa operating system, MS-DOS, CP/M-68K, Xenix, and UniPlus+. The last two are operating systems, and will require addition of a second drive and extra user ports. UniPlus+ is already being distributed by UniPress, Highland Park, NJ; Xenix should be available soon.

Apple is also expected to launch a new marketing strategy involving three computer lines—Apple IIe, Macintosh, and Lisa—with the Apple III being dropped.

TIMEX/SINCLAIR SALES DROP

► Sales of the Timex 1000 (né Sinclair ZX81), once the most popular home computer, have plunged. Orders for its new 1500 and 2000 models are far less than projected. Timex, which pioneered the super-cheap home computer and led in the pricing battles, sold 550,000 units in its first five months. Sinclair had sold 150,000 ZX81s before turning distribution over to Timex. So far, well over a million units have been manufactured.

The 1000 has sold for as low as \$27.95, and typically sells for about \$45. The Commodore VIC-20, TI-99/4A, and Atari 400, which sell for only \$30 to \$40 more, offer color, more memory, better keyboards, and more features. As a result, they've hurt sales of the 1000, and many retailers have abandoned the unit. Even the Timex 1500, which generally sells for about \$80, does not stack up well against these units. And the model 2000 is facing stiff competition from the somewhat higher-priced Commodore 64, which has better keyboards, graphics, and sound.

Timex has therefore begun selling its systems to mail order companies and to companies that will package the unit with encyclopedias and textbooks. Also, the units are being offered by banks and real-estate developers as give-aways in sales promotion programs.

In England, Sinclair has unveiled a continuous-loop tape drive interface for its Spectrum color computer. It has an 85K capacity and an average access time of 3.5 seconds, and sells for \$76, plus \$7.50 for a tape cartridge. The unit is expected to be introduced in the U.S. for the Timex 2000 systems. The drive requires a \$50 interface unit (only \$30 when purchased with drive). The unit that is needed, which fits under the computer, also provides an RS-232 port and local-area network connection device.

COLECO'S ADAM

► Coleco, the only current games maker turning a profit, showed its Adam integrated home computer in June, promising delivery in late August. It then pushed the delivery date back to mid-October and raised its suggested retail price from \$600 to \$700. (The dealer price will be about \$575.) The final unit will have a tape recorder for mass storage and a slow-speed daisy-wheel printer. A modem, memory expansion, and disk drive options are expected early next year. Also, Coleco expects an option that will increase the current 32-character line to 80 characters on a TV.

Coleco disclosed that it has signed an agreement with StarCom to market its "Dragon's Lair" arcade game, which employs a laser disk and, reportedly, a new dimension in game technology. The company has also signed an agreement with AT&T to develop a home video game service via telephone. AT&T will make and sell the video game machine, which includes a modem.

RESEARCH COOPERATIVES BEGIN PROJECTS

► The Semiconductor Research Cooperative, a subsidiary of the Semiconductor Industry Association, disclosed that it is initiating development of a pilot program to demonstrate the manufacturability and reliability of a 4-megabit memory

device. SRC, formed two years ago, is an alliance of 18 companies, among them IBM, GE, Motorola, CDC, DEC, Intel, AMD, HP, Silicon Systems, and Monolithic Memories.

The other research cooperative, Microelectronics & Computer Technology Corp., an R&D venture owned by AMD, Allied Corp., CDC, DEC, Harris, Honeywell, Martin Marietta, Mostek, Motorola, National Semiconductor, NCR, RCA, and Sperry, has announced that it will be doing research in advanced computer architecture, computer-aided design and manufacturing, system and circuit chip packaging, and software technology.

SOMEWHERE OVER THE RAINBOW?

► Digital Equipment Corp. seems to be following in IBM's footsteps in the personal computing area. DEC has assumed that its Rainbow computer was going to take the marketplace by storm, but instead it met with a ho-hum reception. Although a very good design, the heart of the problem was that DEC tried to keep everything to itself so that customers would be totally dependent on DEC for software, peripherals, and even supplies. For example, DEC did not provide any way for users to format disks and therefore forced them to buy pre-formatted disks from it at a very steep cost. And the refusal to release technical documentation discouraged independent software and peripheral suppliers from developing products.

But try as it might, it could not stop the independents. One company brought out a formatting program for the Rainbow. DEC has finally conceded, recognizing that the tactics they used in the minicomputer area are just not going to work in the personal computer market. So DEC has now released a utilities disk with a format program on it, plus other utilities to assist software development. In addition to this, they are promising a technical manual similar to the one published by IBM for its PC.

SEC HALTS SOFTWARE ACCOUNTING METHODS

► The Securities and Exchange Commission has told software developers to stop treating software development costs as an asset in their books and consider it an expense. This accounting technique was used by some companies as a way of increasing paper profits by reducing expenses and increasing the value of the business.

RANDOM NEWS BITS

► One of Tokyo's largest department stores, Seibu, is offering two industrial-type robots for sale in their store. At \$25,000 apiece, they are not likely to sell many but they sure are attracting crowds. . . . Imports of ICs from Japan for the first four months of the year reportedly increased 63% for packaged ICs and a whopping 252% for unpackaged ICs. By contrast, shipments of ICs to Japan increased 11%. . . . According to the "Books In Print" reference guide, there are now 2400 computer books in print, with the overwhelming majority published in the last 18 months. An estimated 20 new titles are released each week. . . . Intel is promising that it will start production on a new 1-megabit bubble memory device late next year that they expect to sell for \$99 in quantity.

If you have put off learning more electronics for any of these reasons, act now!

- I don't have the time.*
- High school was hard for me and electronics sounds like it may be hard to learn.*
- I can't afford any more education.*
- I have a family now.*
- I'm here. You're there. I've never learned that way before. I'm not sure it will work for me.*

Read the opposite page and see how you can get started today!

Be honest with yourself. Are the reasons really excuses? You already know enough about electronics to be interested in reading this magazine. So why not learn more? If you need encouragement, read on and see how excuses can be turned into results.

You don't have the time.

Be realistic. All you have in life is a period of time. Use it. Try to know more tomorrow than you do today. That's the proven way to success.

Electronics sounds like it may be hard to learn.

You already know something about electronics or you wouldn't be reading this. Now, build on that. CIE Auto-Programmed® Lessons help you learn. Topics are presented in simple, logical sequence. All text is clear and concise for quick, easy understanding. You learn step by step, at your own pace. No classes to attend. Nobody pressures you. You *can* learn.

You can't afford any more education.

Actually, you can't afford NOT to gain the skills that can put you ahead of the others. It makes sense to invest in yourself through education — learning a skill. If you are not able to pay full tuition now, convenient monthly payments can be arranged.

You have a family now.

All the more reason why you have the responsibility to advance yourself. For the sake of your family. Do you want them to have what you had or have *more* than you had? The choice is yours. Electronics is a rewarding career choice. CIE can help you to get started on that career.

You're there. We're here. How does CIE help you learn?

First, we *want* you to succeed. You may study at home, but you are not alone. When you have a question about a lesson, a postage stamp gets you your answer fast. You may find this even better than having a classroom teacher. CIE understands people need to learn at their own pace. When CIE receives your completed lesson before noon, it will be graded and mailed back to you the same day with appropriate instructional help. Your satisfaction with your progress comes by return mail. That's how CIE helps you learn.

NOW, IF YOU AGREE CIE TRAINING CAN WORK FOR YOU, HOW ELSE CAN CIE HELP YOU?

CIE is one of the largest independent home study schools in the world that specializes in electronics. Although "big" does not always mean "best," it is evidence that CIE is a strong, successful institution with the people and resources to help you succeed.

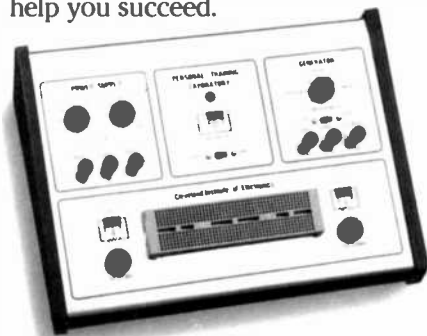

Step-by-step learning includes "hands-on" training.

The kind of professional you want to be needs more than theory. That's why some of our courses include the Personal Training Laboratory, which helps you put lesson theory into actual practice. Other courses train you to use tools of the trade such as a 10MHz, solid-state, triggered-sweep oscilloscope. Or a Digital Learning Laboratory to let you apply the digital theory that's essential today for anyone who



wants to keep pace with electronics in the eighties. Or a Microprocessor Training Laboratory you learn to program and interface with displays, memories, switches, and more.

Your credentials can impress employers.

One of the best credentials you can have in electronics — or any other career field — is a college degree. That's why CIE gives you the opportunity to earn an Associate in Applied Science in Electronics Engineering Technology. Any CIE career course can offer you credit toward the degree...more than half the number needed in some cases.

You can also prepare for the government-administered FCC (Federal Communications Commission) Radiotelephone License, General Class. It can be a real mark in your favor...government-certified proof of your specific knowledge and skills.

Find out more! Today. Now.

There's a card with this ad. Fill it in and return. If some other ambitious person has already removed it, use the coupon.

You'll get a copy of CIE's free school catalog, along with a complete package of personal home study information.

For your convenience, we'll try to arrange for a CIE representative to contact you to answer any questions you may have.

If you are serious about a rewarding career, about learning electronics or building on your present skills, your best bet is to go with the electronics specialists — CIE. Mail the card or coupon today or write CIE (please mention the name and date of this magazine), 1776 East 17th Street, Cleveland, Ohio 44114.

This could be the best decision you've made all year.

PE-01

CIE Cleveland Institute of Electronics, Inc.

1776 East 17th Street, Cleveland, Ohio 44114

Accredited Member National Home Study Council

YES.. I want to learn from the specialists in electronics — CIE. Send me my FREE CIE school catalog...including details about the Associate Degree program... plus my FREE package of home study information.

Print Name _____

Address _____ Apt. _____

City _____ State _____ Zip _____

Age _____ Area Code/Phone No. _____ / _____

Check box for G.I. Bill bulletin on Educational Benefits: Veteran Active Duty

MAIL TODAY!

COMPUTER VIDEO GAMES

Hands-On Reviews of Recently Released Game Software

HIGHRISE

Diskette for Apple II/IIe
MicroLab, Inc., 2699 Skokie Valley Road,
Highland Park, IL 60035; 312-433-7550.
\$30.00

Graphics ★★

Gameplay ★★

Sustained Interest ★★

Type: Keyboard educational strategy game

Memory Required: 48K

MicroLab put this "game" in its MicroLearn educational library since it's supposed to teach skills in spatial relations and planning. Trouble is, it's so much fun it's hard to remember that I'm learning something while playing it.

In it, Barnaby, my master builder, piles blocks of various shapes and sizes on top of each other. When the stack reaches a certain height, he climbs up the "building" to the next level. If the wrong kinds of blocks are juxtaposed, the building collapses; so planning, selection and strategy are important.

You're also running against the clock with this educational game, and it's possible to rack up some really impressive point scores—that is, until you reach level five or six, at which time the shapes of the building blocks get so weird that it's hard to gauge which will balance properly on what.

This game's great for the whole family. It's what games rarely are: educational and a lot of fun.

JUMPMAN JUNIOR

ROM Cartridge for Atari 400/800
EPYX (Automated Simulations, Inc.),
1043 Kies Ct., Sunnyvale, CA 94086;
408-745-0700. \$34.99

Graphics ★★

Gameplay ★★

Sustained Interest ★★+

Type: Joystick action game

Memory Required: Resident ROM

Jupiter Jumpman fans, rejoice! There's now an easier (?) well, at least simplified version of the Epyx classic, and it comes in cartridge form!

Instead of the 30+ levels of the original, Junior has only 12 levels, and as the apprentice, he has to try harder. The game has eight speed levels, and the cart lets you preview all 12 screens before you start.

As with the original, you find yourself on a Jupiter Command Substation that's been invaded and mined by the

Alienators. In your quest to find their bombs, you have to climb, jump and use strategy. You also have to dodge bullets, ride elevators, avoid electrocution traps and moving walls.

You can have up to four players in this game, and each player starts with four lives. You get a free life for every 7500 points you score—easier said than done.

For each bomb collected and defused, you score 100 points and receive bonus points as you leave each level. If you missed Jupiter Jumpman, try this one.

time left to burn in each stage, time into mission, altitude and down-range (distance).

Once you've reached orbit, the screen shows you your orbit path and the orbit of the existing satellite that you must rendezvous with. It takes a lot of practice and patience to maneuver the difficult operations of catching up and not burning up in the atmosphere.

Staging (drop-off of spent booster) is automatic, and you must reach an altitude of at least 192 kilometers to get into orbit. Then the fun really begins with

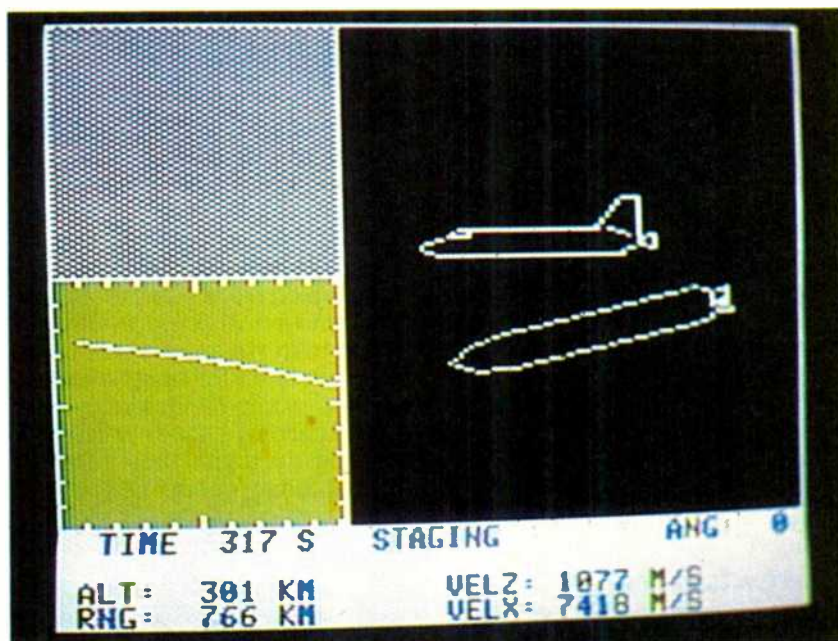

"Rendezvous" is captivating and educational.

RENDEZVOUS

Diskette for Apple II series
Edu-Ware Services, Inc., PO Box 22222,
Agoura, CA 91301-0522; 213-706-0661.
\$39.95

Graphics ★★

Gameplay ★★

Sustained Interest ★★+

Type: Keyboard simulation game

Memory Required: 48K

If you've a yearning to pilot a spacecraft, Rendezvous goes a long way toward fulfilling it. From the moment you start the ignition for the blast-off, your Shuttle spacecraft is under your control.

To hit the right "window" you must immediately start to change the angle of the ascent—as soon as the gantry disappears from the screen. Key parameters are displayed on the bottom of the screen: vertical and horizontal velocity,

course corrections (a lot of guesswork), projections of flight path, and the actual rendezvous. As of this writing, your reviewer still hasn't successfully met up with the satellite, but practice makes perfect. This program is both captivating and educational in a way that's guaranteed to keep you burning the midnight oil.

LUNAR LEEPER

ROM Cartridge for VIC-20
Sierra On-Line, Sierra On-Line Bldg.,
Coarsegold, CA 93614; 209-683-6858.
\$29.95

Graphics ★★

Gameplay ★★

Sustained Interest ★★

Type: Joystick action game

Memory Required: Resident ROM

This new one from Sierra is hard as the

dickens to play without getting clobbered. The graphics are some of the best we've seen for the VIC to date, and the humanitarian aspect of the gameplay (rescuing stranded humans on the moon) isn't lost on us.

Gameplay has a shoot-em-up and dodge-'em script. It isn't at all easy to shoot the Lunar Leepers (the enemy); your spaceship has no brakes, so it takes some dexterity to avoid getting blopped (you don't get zapped and you don't get bopped—just "blopped") while rescuing the stranded humans. It's exciting and different, as twitch games go.

OLD IRONSIDES

Diskette for Apple II
Xerox Educational Publications,
245 Long Hill Road, Middletown,
CT 06457; 203-347-7251. \$39.95

Graphics ★★★★★

Gameplay ★★★★★

Sustained Interest ★★★

Type: Joystick/keyboard strategy/action game

Memory Required: 48K

The combination "Logbook and Instruction Manual" is the first introduction to this classic game of sailing ships and battle on the high seas. Like the program itself and the packaging, it is masterfully presented with loads of space to keep a log of your ship's adventures and battles—but the logbook is so beautiful it's a shame you have to write in it.

The game works with a combination of paddle controllers and keyboard. If you don't have Apple paddles, the key-

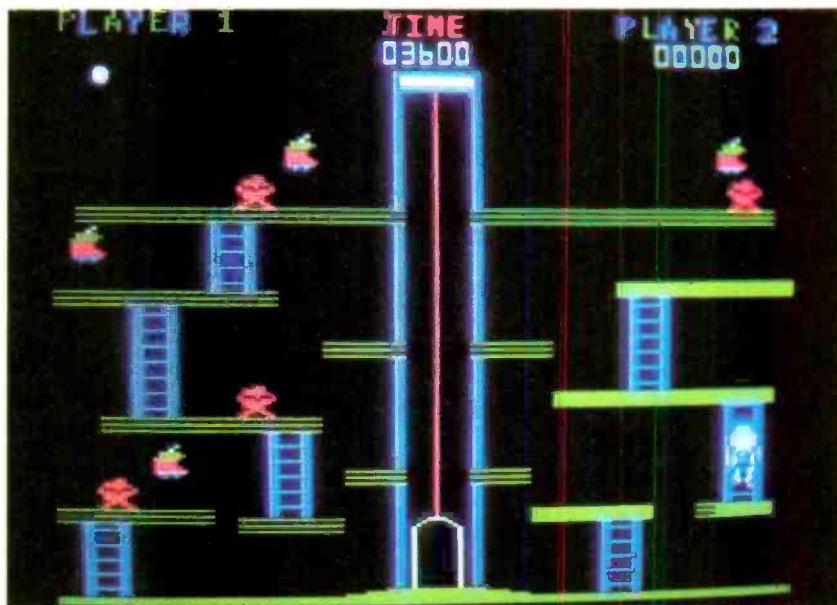

The elevator in "Miner 2049ER" is keyboard controlled.

board is split down the middle for the two players. The screen is artfully framed by a curlicued period-map border. The two ships are beautifully crafted, and the broadsides that you fire are excellent and difficult to learn to control at first.

You can get sunk by cannon fire, ramming, explosion of the powder magazine, losing your mast and drifting into fog, thereby getting lost.

A sense of direction is very important and very hard to come by. Experienced captains can use the wind direction, the fog and ramming routines to advantage, but it's sure hard to learn. I guess that this is what is meant by a *fun-type* educational program. You're forced to

learn compass headings, ship's controls and procedures, and dealing with simulated battle conditions on the high seas of 150 years ago. It's a real winner.

MINER 2049ER

Diskette for Apple II and Atari 400/800
MicroLab, Inc., 2699 Skokie Valley Road,
Highland Park, IL 60035; 312-433-7550.
\$30.00

Graphics ★★★★★

Gameplay ★★★★★

Sustained Interest ★★★★★

Type: Joystick action game

Memory Required: 48K

This game is on its way to becoming a classic. Your hero, Bounty Bob, goes through a total of 10 levels (screens) of increasing difficulty—masking all floor levels by walking on them at least once.

Bob must avoid being destroyed by the roving mutants, but they turn green and can be chomped by Bob after he gets energy from eating an apple. The apples, by the way, look like the computer's logo and hang in the most unconventional locations.

Bob can also be destroyed by falling off a platform, but you have to be a real klutz to let this happen. It takes a little practice to get that miniplatform masked in Screen 1. The third screen has an elevator controlled by the keyboard, and there are moving platforms in levels 5, 6 and 7. Level 6 has a radioactive pool, and other levels contain a lift, and deadly stompers—and finally Bob gets shot out of a cannon.

As with so many games that are multilevel, it takes a long time to become proficient enough to reach the highest (most difficult) level or screen.

The "Old Ironsides" screen is framed by an old map.

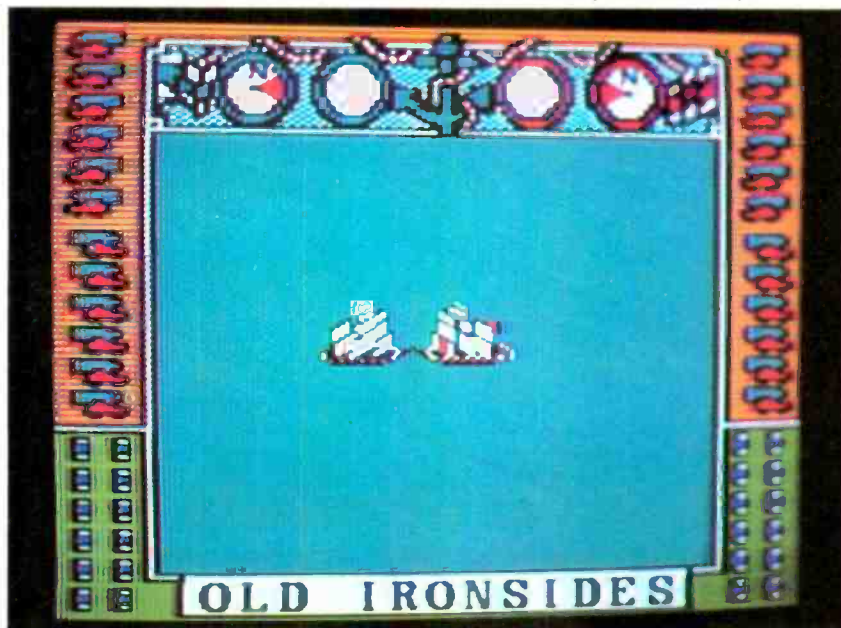



Inside Apple

Vol. 1, No. 4

A dot matrix printer that will improve your image.

Meet the Apple® Imagewriter, the newest dot matrix printer for your Apple Personal Computer.

And with all that it has going for it, just maybe the best dot matrix printer on the market.

Take legibility, for instance.

The Imagewriter crams 140 x 160 dots into each square inch. So you get text that's highly readable and high resolution graphics, besides.

And is it fast.

The Imagewriter cruises at an unbelievable 120 characters per second. And that's just in the text mode. It's even faster printing graphics. 180 characters per second, to be exact.

What's more, the graphics dump is up to 60% faster than other comparably priced dot matrix printers. And that makes the Imagewriter fast enough to handle the Lisa™

Yet it's just as at home with an Apple III or Apple IIe. Thanks to Apple software experts who designed the control electronics to give the Imagewriter perfect compatibility. Not to mention some special capabilities

like superscript and subscript, to name just two.

Now, with all this high-speed performance, you'd expect the Imagewriter to make the Devil's Own Noise. It doesn't. In fact, the Imagewriter is specially constructed — with overlaid seams and special sound-deadening materials — to achieve a remarkable 53 dB. How loud is a remarkable 53 dB? You'd make more noise if you read this aloud.

The Imagewriter even has quiet good looks, since we designed it to look like the rest of the Apple Family.

Yet even with all its improvements, the Imagewriter is a better deal than any other dot matrix printer with comparable

performance. And you can print that.

**APPLE PRESENTS THE
E IMAGewriter APPLE PR
ESENTS THE IMAGewriter APPLE PRESENT
S THE IMAGewriter APPLE PRESENTS THE IMAGewriter APPL**

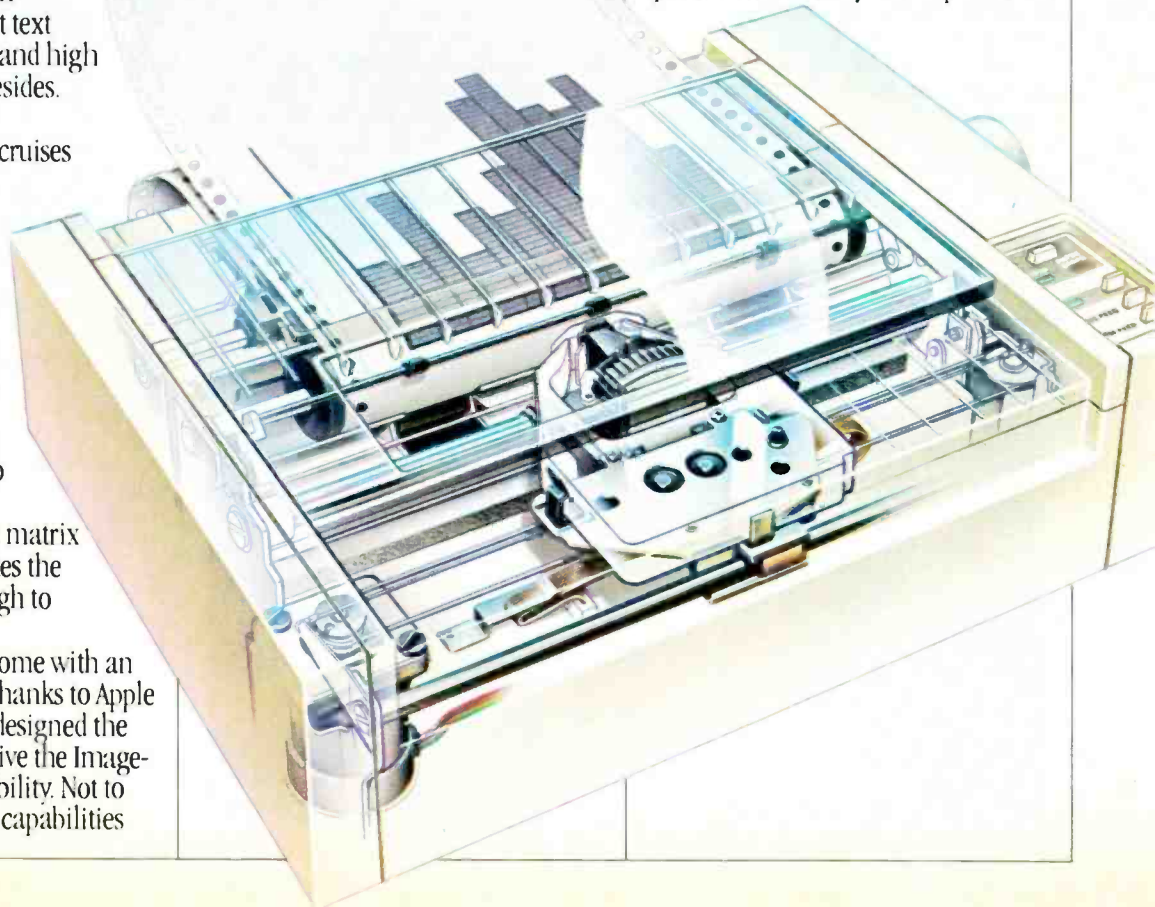



Charge!

Go out there and get the Apple Personal Computer System you really want. Now. Without laying out your extra cash. Without tying up your other lines of credit. With the Apple Card. The only consumer credit card reserved exclusively for the purchase of Apple Computers, peripherals and software.

Like all our products, it works simply:

Fill out an application (short, to the point and annotated in English) at an authorized Apple dealer honoring the Card. Your salesperson will call in the application and in most cases get an approval for you right on the spot.

You can then take your Apple system home. You don't even have to wait for the Card; we'll mail it out to you. And by the time you get it, you'll probably be well into doing whatever you bought your Apple system to do.

There is no annual fee for the Card, although a couple of restrictions do apply. The first purchase must include an Apple Personal Computer and you have to put 10% down. And subsequent purchases need to be at least \$100 if made with the Card. Oh, yes — you'll also have a credit limit.

When you use the Apple Card to make additional purchases, all you have to do is show the Card and sign the invoice. As long as it's within your credit limit, of course. Our dealers get a little nervous when someone signs for half their inventory. You understand.

You'll also receive monthly statements that include the latest purchases, credit available, and the minimum payment due. You'll also be happy to know Apple Card credit terms are affordable and the payments can be spread out. It's all

spelled out for you at the time your Card is approved.

So stop by a participating authorized Apple dealer and get an Apple Card. Just think of it as credit where credit is due.

Give your floppy disks the boot.

We call it the "floppy disk shuffle." It happens when you have two or more software programs on floppies and you need to work with both. What do you do? You put one disk in, boot it, do your work, take it out, put the other disk in, boot it, do your work — you get the idea.

Well, you can stop shuffling any time now.

Thanks to a unique new software program called Catalyst™ from Quark, Inc. Specially designed for your Apple III and ProFile™ hard disk.

Catalyst allows you to take a wide variety of software programs and store them on your ProFile. Once they're on your ProFile, you just select the program you want from the Catalyst menu that appears on your monitor — then Catalyst does the rest. You'll never have to boot those programs again.

What kinds of programs will work with ProFile and Catalyst?

Almost anything written for the Apple III including copy-protected programs like VisiCalc®, Quick File™ and Apple Writer III. Or languages like Pascal, BASIC, or COBOL.

And once you've loaded these programs into your ProFile, the only diskette you may ever need is the Catalyst.

So if you have an Apple III and a ProFile and more floppies than you care to flip through, get yourself a Catalyst. And boot those disks for good.

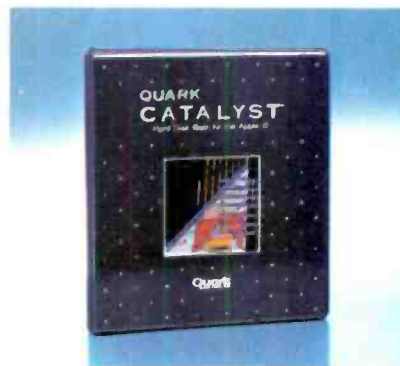

**TALK
TO ME!**



EARS FOR YOUR COMPUTER

Voice-recognition hardware and software are available for several types of personal computers

By Ed Teja

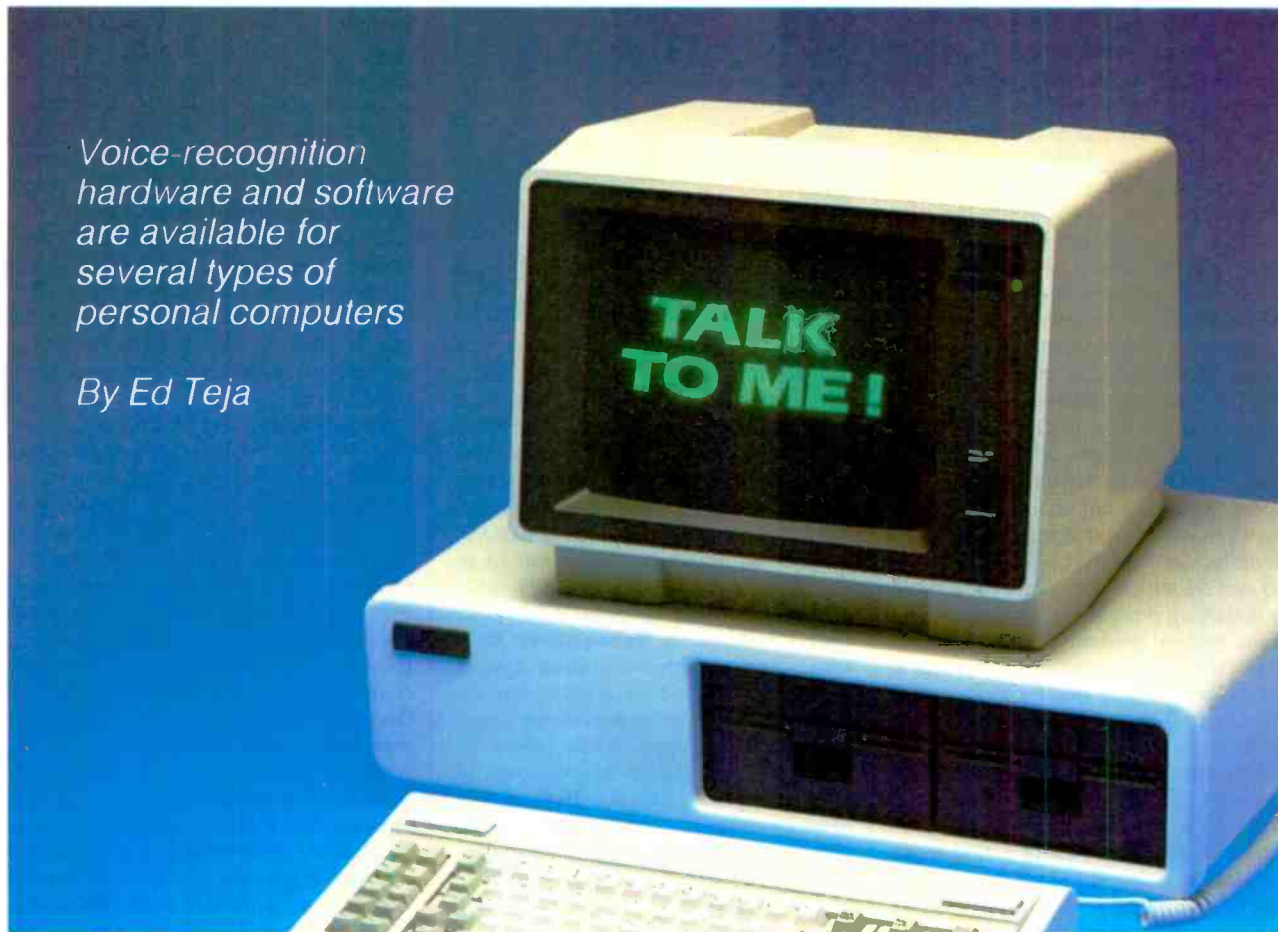

WHEN one person talks to another, it's a natural and efficient means of communication. But when a human being talks to a computer and the machine responds, the process seems like magic. There's nothing magical about computer voice recognition, however. It's currently available for several different types of personal computer systems.

Originally, spoken input (both of commands and data) for computers was restricted to expensive voice data entry systems. Recognizing even a few vocabulary words required a lot of computing power, so these systems had a separate, powerful computer that acted as a speech recognizer. Speech-recognition systems have been around since 1970,

but as late as 1978 a system for banking applications that recognized only digits cost over \$60,000. However, new recognition techniques and advances in VLSI (very-large-scale integration) have made voice input possible and practical for personal computers.

The Technology. Speech recognition is typically a pattern-matching process. The recognizer captures a spoken word and matches it to reference words stored in memory. There are several techniques both for capturing and matching the spoken input, but the differences are subtle.

Basically, as the diagram in Fig. 1 shows, speech enters a microphone as an analog signal—sound waves. The

recognizer filters the sound into as many as 16 separate frequency bands and then digitizes the waveform in each band. These frequency bands contain information that we use when we hear and understand speech. Filtering eliminates a lot of garbage that has nothing to do with speech, such as noise.

After filtering the signal, the recognizer converts the analog signals into digital ones. The digital values represent intensity levels within the frequency band. The human ear can perceive about 250 distinct intensity levels and about 1000 unique pitches in the frequency range from 20 Hz to 16 kHz. Digitizing the data breaks it down into *pitch* (frequency band) and *intensity* (digital value).

There are a number of digitizing techniques: pulse-code modulation (PCM) gives the most accurate digitization, but uses a lot of memory; adaptive pulse-code modulation (ADPCM) uses less memory but loses fidelity. Fortunately, fidelity is not a priority in recognition. Not all of the sounds of speech have meaning. The recognizer only needs those sounds that actually mean something. Nearly every recognizer uses some sort of data compression technique, such as ADPCM, to save memory and speed recognition.

Regardless of the digitization technique, the computer just stores the digital data for each spoken word, or utterance, as an individual data pattern. This is known as the enroll mode. Some systems will average the data from several repetitions of each word in an attempt to get a typical pattern for each vocabulary word. But notwithstanding the number of samples, the recognizer does nothing to the data. It just stores it. The set of data patterns created for each speaker is called a template. In a personal computer, these templates are often stored on a floppy disk until needed.

When you want the recognizer to listen to what you have to say, you put it in its active mode. Now, when the recognizer digitizes the words you speak, it stores them in a buffer for analysis. It can then compare this input pattern to all of the stored patterns (for that speaker) and see which one comes the closest to matching it precisely. Of course, the input pattern seldom if ever matches any of the stored patterns exactly. But it will usually match one far better than any others. The *best fit* will be presented as the word you spoke.

It works like this: Suppose that when you say a particular word, the recognizer senses a 100-Hz sine wave like that shown in Fig. 2A. (Using a real word rather than a simple tone as an example would complicate the example but wouldn't change it. You can imagine this same process going on for the output of each filter bank.) If the recognizer takes four samples of the wave and digitizes it accurately, it would store a reference pattern similar to that shown in Fig. 2B.

Now suppose you repeat the same word, but this time for some reason (stress, perhaps), the sine wave looks like the one shown in Fig. 3A. When the recognizer digitizes this input word, it gets the pattern shown in Fig. 3B. And now you have a problem. The patterns don't match exactly. In fact, when the decimal values of each signal are added, and the sums are subtracted from each other, the result has a decimal value of five. But what does that mean? Nothing by itself; the error must be taken in con-

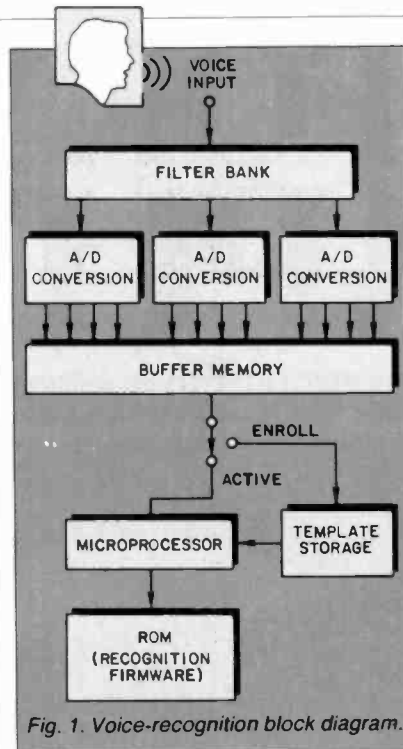

Fig. 1. Voice-recognition block diagram.

text. The context, in this case, is how well the input matches any other reference patterns. When the recognizer looks at the patterns for all of the other vocabulary words, it might not match any other word closer than, say, seven. Although there's no *exact* match between the input and the stored pattern, the desired match does turn out to be the *best* match.

Using a Speech Recognition System. Any speech-recognition system uses a microphone for input. Some require a special noise-cancelling close-talking headset type, while others let you use cheap carbon microphones or even a telephone handset. But the type of recognition strategy doesn't depend

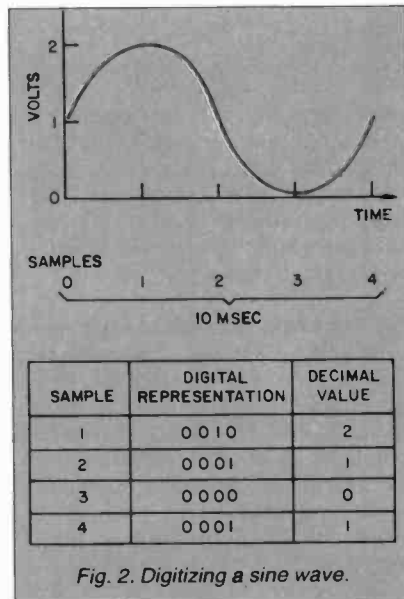

Fig. 2. Digitizing a sine wave.

on the type of microphone you speak into. It's just that more expensive microphones make it easier for the recognizer to do its job.

Some recognizers are *speaker dependent*—that is, they can recognize the input only if a speaker has already recited vocabulary words to it. This process, whereby the speaker is prompted to say all of the words at least once before he or she can use the recognizer, is known as enrollment. A speaker who has stored voice patterns for each word is enrolled in the system. Some manufacturers refer to enrollment as training, but it isn't. Training implies that learning takes place. The recognizer is not an artificial intelligence. It is a machine that matches known patterns to unknown patterns. It cannot be trained.

If you use a speaker-dependent recognizer, you must know how to instruct the computer to call up your particular voice pattern files from storage. It then matches your spoken input with the set of patterns you previously enrolled for the vocabulary words. If it tried to match your words to someone else's patterns, it might not recognize any words at all.

Background noise and other factors that affect the way speech sounds in the air will also affect the accuracy of the recognizer. But you can correct for some problems before they even cause any trouble. If you are going to use the recognizer in a noisy room, you should enroll words while in that same room and under the same conditions. Even factors that have nothing to do with sound directly, such as stress, can affect the way you say a word. This means that you have to pay attention to the environment if you want to get the highest accuracy from your recognizer. Studies indicate that, if you enroll on a system in the relaxed atmosphere of your home and then try to use it in a factory or office, it won't work well at all. Changing the environment between enrollment and use too drastically is almost as bad as enrolling the wrong speaker altogether.

You'll never get a perfect match between the word you just spoke and the pattern you stored previously. However, sometimes the match is closer than others. Most recognizers allow you to adjust the level of match that the recognizer will respond to. You can actually select how close the match has to be before you consider it good enough for your purposes. When you adjust the level of match that you will accept, you are telling the recognizer that a certain error is either acceptable or too far off to be trusted.

This adjustable acceptance level is known as a recognition (if you're an op-

Save \$80 on Radio Shack's New TRS-80® Color Computer 2!



16K Standard BASIC
Reg. 239.95

15995
26-3026

Use Your
CitiLine Card

16K Extended BASIC
Reg. 319.95

23995
26-30E7

As Low As \$25 Per Month
On CitiLine Credit

A Smart Investment. Give your family a colorful Christmas this year with our TRS-80 Color Computer 2. It's the perfect way to join the computer revolution. And, at \$80 off, it's the affordable way, too!

Easy to Use. Just connect your TV, plug in a ready-to-run Program Pak™ and you're all set. Prepare a household budget, monitor your investments, teach your kids or play thrilling outer space and sports games.

Deluxe Features. Both models feature a typewriter-quality keyboard in an attractive white case. Use the built-in Color BASIC language and our entertaining 308-page manual to start writing your own programs with color and sound. Want to create stunning high-resolution graphics and write advanced programs?

Then select our sale-priced 16K Extended BASIC Color Computer 2. Create incredible drawings and designs, business and engineering charts, even animation with simple one-line commands.

Expandable. Best of all, Color Computer 2 can expand easily as your computing skills grow. Add a cassette recorder to store and load your own programs, a telephone modem to access tomorrow's news and stock reports, a printer, joysticks or a color mouse for more exciting game action, disk drives and more.

The Perfect Gift to Give . . . Or Get! Come into a Radio Shack Computer Center, participating store or dealer near you and get a demonstration of our spectacular Color Computer 2.

Radio Shack®
The biggest name in little computers®
A DIVISION OF TANDY CORPORATION

Send for your free 1984 TRS-80 Computer Catalog.

Mail To: Radio Shack, Dept. 84-A-679
300 One Tandy Center, Fort Worth, Texas 76102

NAME _____
COMPANY _____
ADDRESS _____
CITY _____ STATE _____ ZIP _____
TELEPHONE _____

Sale ends Dec. 31, 1983. TV not included. Prices apply at participating Radio Shack stores and dealers.

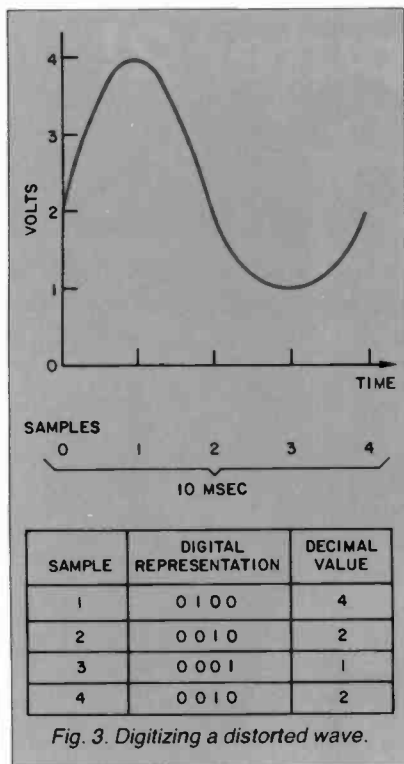

Fig. 3. Digitizing a distorted wave.

timist) or rejection (if you're a pessimist) threshold. If the best match is above the threshold you select, the recognizer will accept the match and pass the word to the host computer. If the best match is below that level, the recognizer will ask you to repeat the word. You'll have to experiment with the recognizer to find the best level. It might even change for each speaker. Some speakers can say each word pretty much the same way each time, others can't. For certain jobs, you'll want to insist on a very close match, such as when the computer is controlling a critical function. Other times, when you are entering a lot of data, for example, it might be easier to allow the recognizer to make a few mistakes and fix them later with an editor.

Another Kind of Speech Recognition System. In order to make voice input easier to use, manufacturers are developing products that are *speaker independent*—they can recognize a word that's in their vocabulary regardless of who says it. You don't need to enroll. To accomplish this, the manufacturer takes extensive samples of large groups of people saying the vocabulary words and then tries to create a template that represents the way most people say the words. So, in a sense, everyone is always enrolled. The templates in this type of system are usually stored in ROM. This is especially useful for games, or when you want a number of people to be able to use the system.

Because research into how we under-

stand what we hear is still quite new, most of these speaker-independent systems have small vocabularies (less than 10 words) that contain carefully selected words. These words require careful selection so that the recognizer won't have trouble distinguishing them from each other.

There are only about 40 basic speech sounds (phonemes) in the English language, and some of them aren't very easy to tell apart, even for a human listener. *Pot* and *pop*, for example, would be bad word choices for a recognizer (speaker dependent or independent) because they are short and quite similar. The shorter the word, the fewer clues that the recognizer has to the word's identity. Pop and pot are easily confused; you wouldn't want the two of them in the same vocabulary. A better choice would be *explosion* and *pot*. These two words would be easy for both humans and machines to distinguish from each other.

But some words are tricky. Eight, for example, sounds like repeat, and nine gets confused with five. The more words a particular vocabulary has, the greater the chance of confusing any two words (and the greater the cost of collecting and analyzing speech samples). Vendors of speaker-independent systems therefore choose to offer smaller, but extremely effective, vocabularies.

Most speaker-independent systems are far less accurate than speaker-dependent (enrolled) systems, but they offer the convenience of letting anyone walk up to a product, such as a toy or personal computer, and operate it with a voice command. Improved recognition techniques, being developed at companies like Votan, Interstate Electronics, and other voice-recognition research facilities, should close the performance gap soon. But at present, speaker-independent systems will make

more mistakes than speaker-dependent systems.

The Chips Themselves. Most of the voice recognition systems you'll find for personal computers are based on custom-designed chips. The chips make it simple to design a complete-voice-input system because they take care of the recognition part of the problem. A designer only needs to add support circuitry, just as for a microprocessor.

The first commercial recognition chips came from Interstate Electronics. This firm's latest speaker-independent chip, the VRC008, which is intended for use in low-cost peripherals, requires only the support components shown in the schematic in Fig. 4. Sanyo Electric Ltd. has licensed the hardware and firmware for use in a Japanese action toy that will recognize six Japanese words. Interstate also offers a two-chip speaker-dependent recognizer, the VRC101 and VRC102.

Intel doesn't make or depend on special speech chips for recognition. Instead, it uses its 2920 family of digital signal processing chips (DSP) to convert the analog signals of words into useful (for the computer) digital signals. Intel's strategy is to produce a recognition board product that plugs into its Multibus computer systems and works with all of the firm's standard products.

Texas Instruments also makes a DSP chip called the TMS320. This high-speed processor can execute five-million instructions per second, and compute thousands of precise data values (reportedly faster than any other DSP chip currently on the market). This ultra-fast computing speed is essential for the computations needed in a speech-recognition system.

Add-On "Ears." One of the first low-cost peripherals to give personal com-

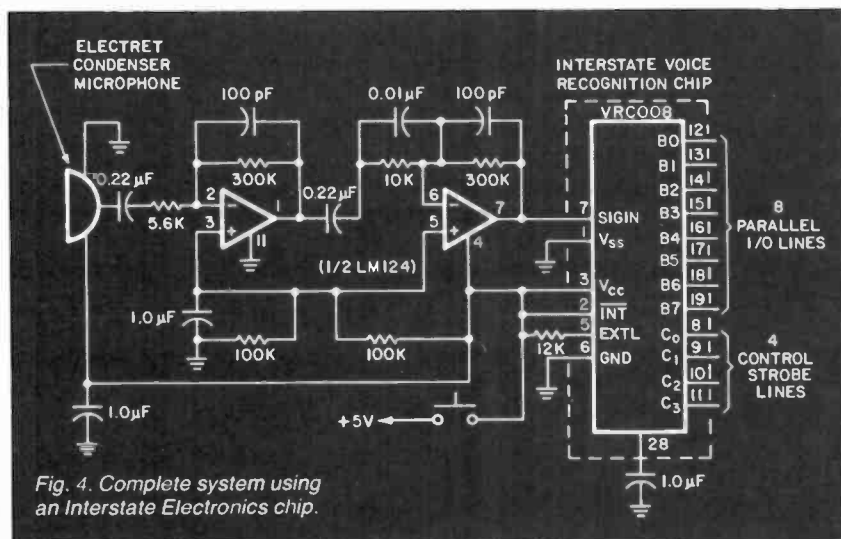

Fig. 4. Complete system using an Interstate Electronics chip.

puters "ears" was Scott Instrument's VET (voice entry terminal). The first models worked with TRS-80s and Apples. Today, the VET/2 (\$895) works with the Apple II+, and the Shadow VET (\$595) works with the Apple II+ and IIe. The VET/2 comes with a software program that enables teachers to write lessons that students can give spoken answers to. The VBLS (voice-based learning system) package costs \$99.95 if you buy it separately. VBLS lets nonprogrammers get into the computer-aided instruction business in a convincing way.

Newer in the marketplace is the Voice Input Module (reviewed on page 40) from Voice Machine Communications. It is designed for the Apple II series of computers.

Tecmar's voice-recognition board is available to software manufacturers who want to make use of the technology with the IBM PC. For example, SuperSoft's ScratchPad with Voice-Drive uses the Tecmar board. Currently under development at Tecmar is a stand-alone voice-recognition product that can be used with commercial software for the IBM PC.

SUPPLIERS

CompuPro
3506 Breakwater Ct.
Hayward, CA 94545

General Instrument
Microelectronics Div.
600 West John St.
Hicksville, NY 11802

Intel Corp.
3065 Bowers Ave.
Santa Clara, CA 95051.

Interstate Electronics Corp.
1001 E. Ball Rd.
Anaheim, CA 92803

Plessey Peripheral Systems
17466 Daimler
Irvine, CA 92714

Scott Instruments
815 Elm
Denton, TX 76201

Tecmar
6225 Cochran Rd.
Cleveland, OH 44139

Texas Instruments Inc.
Box 10508
Lubbock, TX 79408

Voice Machine Communications
1000 South Grand Ave.
Santa Ana, CA 92705

Votan
4487 Technology Dr.
Fremont, CA 94538

A speech-recognition system introduced just recently is the Speech Command system from Texas Instruments (also reviewed in the following pages). The product is for use with the Texas Instruments Personal Computer. You can add ears to a variety of computer terminals also. The C. Itoh, DEC, and Plessey terminals can accept plug-in boards to add voice input to the usual keyboard input. And all the host computer ever sees is ASCII characters from the terminal, so using the terminals doesn't require any special software. Plessey sells its terminal with the speech recognition option and has had great success in using it for "hands-free" programming. Programmers write COBOL programs by dictating the code to the computer.

Votan packages its hardware and software products in attractive boxes for use as stand-alone peripherals as well as selling them as individual boards. And the firm has done consider-

able work on making its products useful even over the telephone. With a recognizer designed for use with telephones, you can call a computer and use it from a remote location without any terminal at all.

The Texas Instruments 99/4A, when enhanced with the Milton Bradley MBX Expansion system, is the only low-cost home computer to offer speech recognition. The unit has a limited vocabulary, but it is sufficient for entering commands for games or educational programs.

Conclusion. In the future, you can expect to see speech capability built right into computers, instead of added on later. After all, semiconductor technology is making voice recognition practical and inexpensive, so it's inevitable that entire recognition systems will someday be available in chip form. And remember, it's not magic, it's just a pattern-matching system. ◇

WHO GOES THERE: SPEAKER IDENTIFICATION



Not all voice input systems are designed to respond to what is said to them. Some provide a quite different service—they determine if the speaker is someone who is allowed to use the system. This application can give a system some protection from intrusion. In such a system, the operator types in an identifier (the operator's name or a password, perhaps). The identifier tells the computer which set of vocabulary patterns to use. The computer can then look up the voice template for that person. It selects one of the vocabulary words and asks the operator to say it. When the operator speaks, the computer compares the input pattern to the one stored in memory for that operator.

A particular person will usually say each word in a reasonably similar manner each time. This strategy is called *speaker verification* because, while it doesn't identify a speaker, it can go a long way toward verifying that a speaker is who he says he is. The technique isn't foolproof; some speakers will produce the same or similar patterns, but it makes it a little harder for someone to use your computer or read your files without your permission.

Another way to use the same hardware is to identify a particular speaker from among a number of speakers. Suppose

that you record someone saying a particular word. You might know that one of five people said the word, but not know which person. The computer can compare the recorded word against the patterns it has stored for all five people and tell you the person who *probably* said the word. In this case, the same hardware that might provide speech recognition is giving you speaker recognition.

This is one of the ways that law enforcement agencies are using voice input. The Los Angeles Sheriff's Department uses the CompuPro computer pictured above (donated for the purpose by Bill Godbout) to perform acoustic analysis of recordings, such as bomb threats and harassing telephone calls to determine whether or not a particular individual could be the one who made the call. But, according to Forensic Voice and Tape Investigator Craig Melvin, the computer's function is primarily to eliminate suspects. It doesn't point the finger of guilt at anyone as much as it proves that a certain person couldn't have made the phone call. If there is no match at all between the accused's voice and that of the tape-recorded voice, the officers will look for other suspects. Technology can acquit but can seldom convict. Not without other, supportive, evidence. ◇

Voice-Recognition Boards for Apple/ Franklin and Texas Instruments Professional Computers

THE two voice-recognition products examined here are the "Voice Input Module" from Voice Machine Communications, Inc. and Texas Instruments' "Speech Command System." These devices are not reviewed so much for comparison as to give you insight into the advanced technology that is available for personal computers today.

Voice Input Module

The Voice Input Module (VIM) is designed for use on the Apple II series of microcomputers or the Franklin ACE 1000. VIM can be integrated with most off-the-shelf Apple applications packages, which means that you can substitute voice input for keyboard entry (as desired) in programs such as VisiCalc, Pie Writer, and many others. And VIM works with languages, too! For example, you can use it when programming in BASIC, Logo, etc. Suggested retail price is \$845 (\$920 with a special noise-cancelling microphone and on/off footpedal), which includes the Magic Window II word-processing package and the MagiCalc financial applications software.

By Joe Desposito

VIM Hardware. The VIM hardware consists of a circuit board that connects to an I/O slot at the rear of the Apple motherboard, and cables that interface the VIM to the Apple keyboard. There is a jack on the board that connects to a microphone.

On the circuit board are a 16-channel audio spectrum analyzer (a proprietary chip designed by Voice Machine Communications, Inc.), 8K RAM, 4K ROM, and Motorola's 68V03 microprocessor.

To install VIM, you must detach the Apple enclosure from its baseplate. The VIM printed-circuit board can be inserted in any unused Apple I/O slot. Then disconnect the keyboard encoder ribbon from the Apple main board and insert it into the VIM board. An additional ribbon connects from the VIM board to the now vacant connector on the Apple board. When this is done, the VIM is completely installed. Owing to the connection to the keyboard, this procedure is not as simple as inserting other types of boards into an Apple.

The Voice Input Module can be used

with a variety of microphones. Supplied with the product is one of three different types: a hand-held microphone with on/off switch; a high-quality noise-cancelling microphone with an 18" gooseneck, a desk top stand, and footpedal switch; a high-quality noise-cancelling headset boom microphone with in-line on/off/momentary switch and plug.

VIM Software. The software (on one diskette) is called the Voice Utility Program (VUP) and is completely menu driven. Also included on the system disk are 10 vocabulary files for specific (such as VisiCalc) and general (such as a calculator command set) applications.

VUP enables you to build vocabulary files and voice-pattern files. If you have an applications package whose vocabulary file is not included on the system disk, you must build one for it before establishing a corresponding voice-pattern file. After creating voice-patterns, you can test the computer's ability to recognize them. When you're satisfied that the computer understands what you have entered, the voice commands can be integrated into your applications package.

Using the Voice Input Module. The first step in using VIM is to load a vocabulary file into the computer. If none exists on the system disk for your application, you must build the file from scratch. The procedure consists of entering a vocabulary word, and then entering the keystrokes for it. It may be simple, such as keying "1" for "one," or complex, such as keying "BLOOD INTBASIC, ASD000 <0D>" for "load integer." The <0D> is a hexadecimal code that represents RETURN, which is a non-displayable character. There are also codes for other characters of this type such as cursor right or left, escape, control characters, etc. A maximum of 80 words can be entered into a single vocabulary file.

Once you have built a vocabulary file, you're ready to "train" the computer to recognize those words or phrases. When a vocabulary word is displayed on the screen, you speak it into the microphone. After one pass through the vocabulary, the words appear again. This time around the computer may or may not accept your spoken input. If the

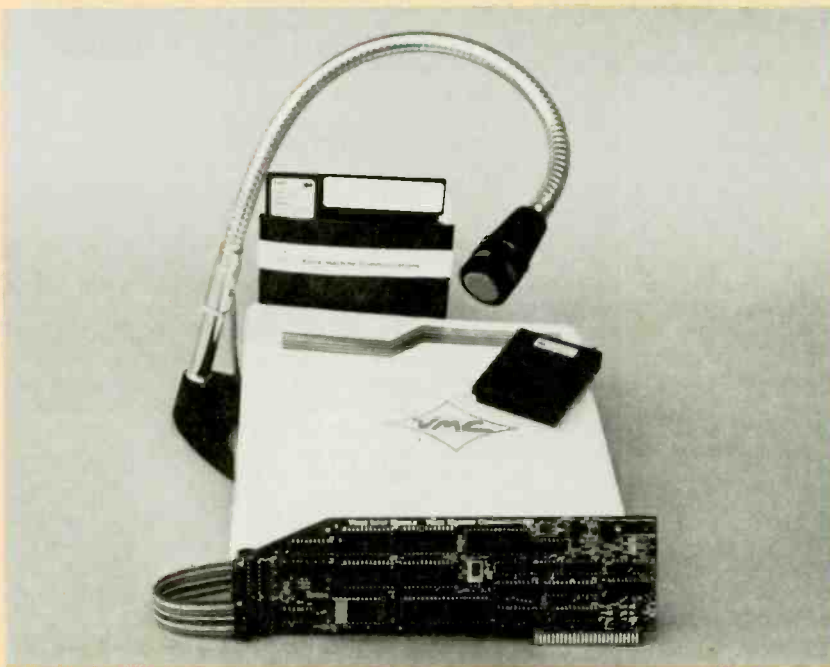

Voice Machine Communications' Voice Input Module



Gain a lot of ground on your future.

By Guarding what's close to you now.



If you're tough and determined, if you can think fast and move faster, there's a challenging job waiting for you in the Army National Guard Infantry.

It's an important job, one of the most important in America. And it's one job where the rewards match the challenge.

In the Army Guard Infantry, you'll gain leadership skills that can be very valuable in civilian life. You'll also learn to rely on yourself, take command, and work as an integral part of a team.

You'll earn excellent part-time income and be entitled to college tuition assistance, PX privileges, a fully-paid retirement plan, life insurance, and lots more.

Even better, you'll be serving close to home, helping people in your community and state when natural disasters or emergencies strike.

After initial training, it takes two days a month and two weeks annual training to serve. So you'll have plenty of time for college or a full-time job.

Infantry in the Army Guard. It's what we call a part-time, smart-time job.

Take a big step for your future. Contact your local Army Guard recruiter, or call **toll-free 800-638-7600.**

*In Hawaii: 737-5255; Puerto Rico: 723-4550; Guam: 477-9957; Virgin Islands (St. Croix): 773-6438; New Jersey: 800-452-7994. In Alaska consult your local phone directory.



The Guard is America at its best.



A1PLGG**123NP

Circle No. 15 on Free Information Card

word is spoken in a similar way each time, there is no problem; otherwise the computer waits for you to give it another input. This procedure concludes after three passes.

At this point, after establishing a vocabulary file and associated voice-pattern file, the computer is ready to listen to you. However, before loading an applications program into the computer, it's a good idea to run some tests just to make sure that the computer really does understand you.

There are two tests available with the VIM system: a separability test and a recognition test. The separability test identifies any words that are likely to be mixed up, such as "or" and "for." In the

creases the probability of correct recognition. Voice Machine Communications, Inc. states that a 98% recognition factor is achievable.

User Comments. Using the Voice Input Module is certainly an experience. The reward for setting up a vocabulary file and voice-pattern file is that your applications software suddenly becomes a joy to use! The first software I tried was Pie Writer, since I felt that word processing would be one of the major uses for a voice-input system. After enrolling the vocabulary that was included on the system disk (which took about 10 minutes), I began to do some word processing. No more control or escape codes for me. I just *told* the computer, "Insert," "Tab," or other such commands and the task was performed. Of course, I still had to type the copy on the keyboard.

Programming in BASIC was also a snap, although I ran into some prob-

was much faster and more complicated to play. To avoid disaster I yelled, "Jump!" but nothing happened and my player was wiped off the screen. I kept trying to play the game, but the computer refused to respond to my voice commands at the expert level of play. Then I realized what the problem was. At the expert level, I was speaking excitedly into the microphone due to the fast-paced action of the game. But when I had enrolled the vocabulary, I did so with dull, monotone commands. Lesson one on enrollment: Try to envision the emotional state you'll be in when you use your applications program, and *then* enroll the vocabulary. In this case, I should have enrolled two sets of commands, one for the lower game levels and another, in a more excited tone, for the higher ones.

To test the speaker dependency of the system, I had a few other people try to use VIM after I had enrolled the vocabulary. I found that a female voice got no response, but a male voice got about a 50% response. The same held true in reverse when a female enrolled the vocabulary.

Conclusions. I think this product has great potential, but also limitations. Being able to use it with off-the-shelf applications packages is a big plus. The VIM can make the computer very accessible to noncomputerists or special groups of people, such as the handicapped. However, someone is needed who can set up the system for maximum proficiency. Installation is not a simple process, and setting up files must be done carefully and creatively. It's a big help, too, to know the applications package well.

I found the separability test lacking. For instance, after enrolling the BASIC vocabulary, I ran the separability test and it pointed out that "for" and "or" would be a potential source of confusion. However, in actual use, many more word pairs were confused.

Another shortcoming I found was that a word could easily be deleted from the vocabulary list, but there was no way to easily delete its corresponding voice pattern. To do this it was necessary to retrain the entire vocabulary! (According to a company spokesman, there is a new "merge file" feature that allows deleting a particular voice pattern without retraining the entire vocabulary.)

Weighing all factors (including cost) my feeling is that a person who purchases the Voice Input Module must have a serious need for it. It takes knowledge and patience to get VIM to the point where it's working at an optimum level. However, once there, using VIM is a most pleasant experience.



Texas Instruments' Speech Command System

recognition test, the computer prompts you to say the words in your vocabulary file (from a printout); and it prints the appropriate word on the display. Along with the input word, the computer prints the "nearest neighbor" and a numerical difference between them. If the difference is small, there is a good probability that the computer might mix up the input word with the nearest neighbor in the future. Sometimes the computer does not recognize the word, which means it will not respond at all or else print the wrong word.

Small difference values and unrecognized words indicate that additional training is called for. This process adds more information to the templates stored in the computer, and thus in-

lems. The computer was confused by some commands. Words like "or" and "for"; "six" and "text"; "oh" and "poke"; and "eight," "delete," and "peek" were constantly misunderstood. There are two ways to get around this. Either retrain your vocabulary or substitute different words for those that are being confused. For example, I substituted "letter" for "text," "erase" for "delete," and "look" for "peek."

I tried building a vocabulary and voice-pattern file for a video game and got some surprises. There were just four commands to the game: right, left, stop, and jump. After enrolling this small vocabulary, I played the game at the lowest level. Everything worked fine. Then I tried the highest level, where the game

Speech Command System

The Speech Command System (SCS) from Texas Instruments is designed specifically for the TI Professional Computer with MS-DOS and at least 256K of memory. Voice recognition can be integrated with any MS-DOS-based applications software.

The suggested retail price of the Speech Command System is \$2600, and you may wonder why. It's because the system also includes a sophisticated telephone management system (not reviewed here) that uses speech synthesis and digital voice recording.

SCS Hardware. The hardware for the Speech Control System consists of two circuit boards, one piggybacked onto the other that connects into one of the expansion slots of the computer. A microphone headset, included with the system, plugs into a jack at the rear of the board (accessible from the outside). Alternately, you may use a different type of microphone or even a telephone handset.

Other than sliding the board into the slot, the only connection is to the internal speaker, which is a simple matter. Once the unit is installed, a diagnostic test disk can be run to make sure that everything is working properly.

On the SCS circuit board is a Texas Instruments 32010 digital signal processor (DSP), an A/D and D/A converter, a programmable low-pass filter, an eight-word FIFO, and 16 × 16K-word RAM. All signal processing on the board is done by the TMS32010, while the FIFO acts as a buffer for input data, and the RAM is used to store vocabulary templates. When the TMS32010 has to process a template, it reads the template into its on-chip RAM.

SCS Software. There are two disks included with the Speech Command System. One is the Speech Command disk, and the other is the Transparent Keyboard disk. The latter is used solely for the speech-recognition functions, although both disks are needed to run the system (remember that a telephone manager is also part of the system).

The software includes vocabulary files for the following: MS-DOS, Multiplan, Easywriter II, NLX Dow Jones, Easyspeller II, MS-BASIC, PFS: REPORT, PFS: FILE, and Lotus 1-2-3. If you have an application not on this list, you may build a file to suit your needs. Also, you may add commands to existing files. Vocabulary files accommodate a maximum of 50 words. How-

ever, if this is too restrictive, you can build additional vocabularies, and the software can "switch" among them.

Using the Speech Command System. SCS is completely menu driven. However, depending on your TI-PC hardware configuration, there are different steps to follow to bring the voice-recognition menu up. I used SCS on a system with one floppy disk drive and one hard disk (a single floppy drive or dual floppy drives are other possibilities).

Before entering the main menu for the first time, you are expected to do a simple calibration routine. This assures optimum system performance for your specific voice and input device. What actually happens is that the computer determines the correct level or "gain" for the combination of your voice and input device. You needn't calibrate again unless you change your input device or environment, or if you think your voice has changed.

When the main menu appears, it includes choices for the telephone manager, calendar manager, and dictation file utility, as well as the transparent-keyboard vocabulary utility that we are concerned with here. Simply pressing function key F4 gets you into the voice-recognition mode. You now enter a command to bring up one of the disk-based vocabularies and begin the enrollment procedure.

When the vocabulary appears, the word that you're enrolling appears highlighted in inverse mode. After you say the word, the next one on the list is highlighted. In this manner, the computer steps you through the enrollment process. After enrolling the vocabulary, it is recommended that you "update" at least three times. In effect, you have created a template with the enrollment procedure, and updating serves to add more information to the stored template.

The next step is to test the vocabulary you've just entered. Here the TI-PC makes good use of its color properties. When the vocabulary appears for test, you say the word and the computer highlights it. On a scale from 1 to 10, you are given an indication of the "closeness of fit" of the current word to the stored template. High numbers indicate the best recognition. Visually, the computer shows words with low numbers in red, high numbers in yellow, and numbers in the middle in green. For numbers in red, you should go back and do further updates on them.

The Speech Command System has one important capability that hasn't been touched on yet. It not only recognizes individual words and short

phrases, but also strings of words spoken in an ordinary way. For proper recognition, you have to enroll the desired word in the string context.

User Comments. I used the Speech Command System with the EasyWriter II word processor. The vocabulary file for this software is included on the disk, so I just needed to enroll my voice. Enrollment, updating, and testing were fairly easy once I became accustomed to the menu choices, which are listed in four columns near the bottom of the screen.

The system showed excellent response to my commands without confusing any of them. However, there were just 31 words in the vocabulary. One word caused a problem. Background noise was interpreted by the computer to be the word "ruler," which was one of the vocabulary words. This was no problem to correct, however, because the system has a "delete" option that allows you to delete a voiceprint, its associated phrase, and equivalent keystrokes form a vocabulary file. I changed the word to "margins."

Another option would have been for me to enroll ruler again. This would have deleted the previous voiceprint and stored a new one. Other options available are add and modify. The former permits you to add a new word to the vocabulary; while modify allows you to change the phrase and equivalent keystrokes associated with a voiceprint.

I also tried the connected-speech capability using MS-DOS commands. I went through the necessary procedures of creating the file, enrolling it, etc. However, the phrases that I entered included "Show me the directory," "of the disk in drive A," "of the Winchester," etc. Thus, when the MS-DOS prompt appeared later on, I was able to say, "Show me the directory of the Winchester," and it was done. Quite impressive!

Conclusions: The speech-recognition feature of Texas Instruments' Speech Command System is an excellent enhancement for its Professional Computer. However, to use it effectively, a skilled operator is needed to set it up. I don't think the vocabulary files offered with the system really exploit its full power.

The menu system is complete and offers all the options you need to prepare SCS for use with a particular application. And the connected speech feature is really a cherry on the ice-cream sundae. Overall, computer voice recognition with the Speech Command System made me feel as if I had entered a new era of computing. ◇

A NEW BREAKTHROUGH

**SAVE UP TO 33% WITH
OUR INTRODUCTORY
SUBSCRIPTION
OFFER!**



Introducing **A+**, the Most Significant Advance in Apple History!

It's here! Big, bold and bursting with page after page of the latest in hardware, software, programming—and more! **A+** is the monthly magazine written exclusively for your Apple microcomputer. Each issue gets you involved with a host of fascinating features, probing updates, unique departments—and reaches to the depths of your imagination to challenge you with daring new strategies and adventures!

Here's just a sampling of what **A+ is all about:**

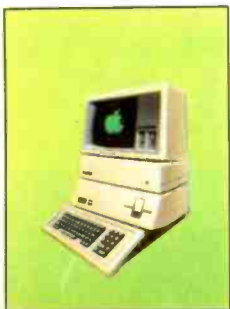

HARDWARE: From the latest advances in telecommunications and networking...to new ways to augment memory and access a wider variety of peripherals with greater ease...each issue of **A+** gets you involved.

SOFTWARE: What's new on the market and how you can make your system more powerful...plus full reviews and programming information.

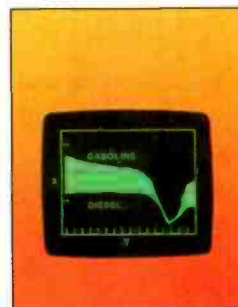

UTILITIES AND DIAGNOSTICS: In addition to language utilities, **A+** helps you troubleshoot problems... makes you faster and more efficient...with utilities ranging from record processing to data transfer.

BUSINESS AND FINANCE AIDS: Software for financial forecasting and analysis...general accounting programs...financial news retrieval services...and business graphics so you can see just where your money is going.

GAMES: Take the **A+** challenge—with hoards of innovative brain teasers...from games to help you learn spelling and arithmetic...to games that provide fun and adventure!

FOR YOUR APPLE™



PROGRAMMING TOOLS: Speed up program development with Apple text editors, testing and debugging aids and data base management systems. Since your Apple can speak many languages—from Cobal to Basic and Pascal—**A+** gives you a wide range of utilities for each language so you can create your own exciting programs.



HOME/PERSONAL PROGRAMS: covers it all...from basic processing...to helping you draw with Apple graphics...to speed reading...music theory and composition...even a course on cooking with your Apple...and then how to monitor your diet easily and accurately...along with many educational programs to learn math, science, and geography.

DATA FILES: Let **A+** probe new data base management systems so you'll be able to organize, store and retrieve information in ways you never thought possible.



YOUR TURN: Speak up with your ideas and innovations and network with other Apple users near and far.

Plug into Savings of Up to 33% with Our Introductory Offer!

YES! I want to subscribe to **A+** for:

- One year (12 issues) only \$19.97—20% off!
- Two years only \$36.97—26% off!
- Three years only \$49.97—33% off!

Savings based on full one-year subscription price of \$24.97.

Name _____ 8H096

Address _____

City _____

State _____ Zip _____

Check One: Payment enclosed. Please bill me.

Please charge my:

MasterCard VISA American Express

Card No. _____ Exp. Date _____

Would you like to receive special offers from qualified users of our mailing list? YES NO

MAIL TO: **A+**, P.O. Box 2964, Boulder, CO 80322



For home or classroom

COMPUTERS IN SCIENCE AND SOCIAL STUDIES

A SOURCEBOOK OF IDEAS

Edited By David H. Ahl

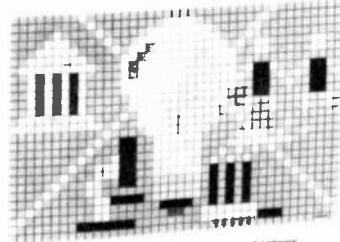

49 thought-provoking simulations, applications, and educational games for microcomputers! User-tested programs are included.



STEPHEN J. ROGOWSKI
PROBLEMS FOR COMPUTER SOLUTION
STUDENT EDITION
Creative Computing Press

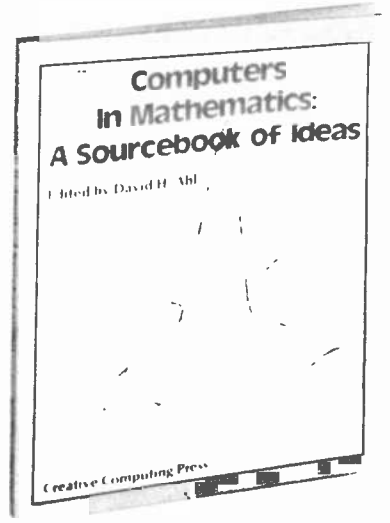

Computers In Mathematics: A Sourcebook of Ideas

Edited by David H. Ahl

Creative Computing Press

Use these three books for state-of-the-art learning material!

COMPUTERS IN SCIENCE AND SOCIAL STUDIES

Edited by David H. Ahl

Are you involved with one of the physical or social sciences? This new book brings together 40 science-oriented computer articles from the pages of *Creative Computing*.

Fields covered include Social Studies, Psychology, Chemistry, Biology, Physics, Health, Ecology, Astronomy, History, Economics, Geography, Medicine—even Interstellar Trade! You'll find games, brief tutorials and programs that bring together the many exciting uses of the computer in social studies and science!

8½" x 11", softcover.
\$14.95 (\$2.00) #9X

PROBLEMS FOR COMPUTER SOLUTION

By Stephen Rogowski

Here are 90 intriguing math and science problems—most consisting of several parts—that will provide hours of fascination and challenge. Each problem is clearly presented and thoroughly discussed, with references made to standard math texts. Problems cover eight areas: arithmetic... geometry... trigonometry... number theory... probability... statistics... calculus... science.

The Student Edition includes only the problems, while the Teacher's Edition contains problems, solutions, a complete listing and run in BASIC for each, and in-depth analyses explaining the algorithms and theory for each problem.

8½" x 11", softcover.
Student Edition \$4.95 (\$1.00) #9Z;
Teacher Edition \$9.95 (\$2.00) #9Y

COMPUTERS IN MATHEMATICS: A SOURCEBOOK OF IDEAS

Edited by David H. Ahl

Scores of ready-to-use, classroom-tested ideas in dozens of areas such as solving differential equations... trigonometric functions and Tchebychev approximations... computer simulations and problem-solving in probability... binary counting... regression analysis. Practice programs, art and graphing problems, program listings and sample runs are included, plus over 250 problems, puzzles and programming ideas.

8½" x 11", softcover, illustrated.
\$15.95 (\$2.00) #12D

For faster service, **PHONE TOLL FREE: 800-631-8112** (In NJ only: 201-540-0445)
Also available at your local bookstore or computer store.

CREATIVE COMPUTING PRESS - Dept. NH9F 39 East Hanover Avenue - Morris Plains, NJ 07950

Please send books listed below:

Book No.	Qty.	Title	Price Each	(P&H) Each	Total Price
CA NJ and NY State residents add applicable sales tax			TOTAL AMOUNT		

Postage and handling charges appear in parentheses () next to price of book

CHARGE MY: (Charge and phone orders \$10 minimum.)
 American Express MasterCard Visa

Card No. _____ Exp. Date _____

Signature _____

Mr./Mrs./Ms. _____
(please print full name)

Address _____ Apt. _____

City _____

State/Zip _____

PAYMENT ENCLOSED \$ _____ Outside USA add \$3.00 per order.

Send me a FREE *Creative Computing* Catalog.

Number Systems for Microcomputers



How binary, decimal, octal, and hexadecimal systems work in relation to your computer

By Randy Carlstrom

ALMOST 800 years ago, the *Arabic number system* was introduced in Europe. Ten symbols were used since man has 10 fingers that he can use for counting purposes. In fact, each symbol is called a *digit* (from the Latin *digitus*, for finger); and because there are 10 digits, the Arabic system is also called the *decimal number system* (from the Latin *decem*, for 10).

When counting in the decimal system, we begin with the digit having the least value, zero. When the count reaches 9, a limit has been reached because 9 is the digit of greatest value and there are no fingers left. An additional count produces a carry, which is equal to 10. The 1 occupies the 10s (10^1) position, whereas the 0 occupies the units (10^0) position. This process continues

each time 9 is reached in the units position. When a 9 appears in the 10s position, the next carry into the 10s position will produce a carry into the 100s (10^2) position.

Note that a number in the 10s position possesses a value (*weight*) 10 times that of the same number in the units position. A number in the 100s position possesses a weight 10 times that of the same number in the 10s position. The same is true for each position of greater weight. Because of this relationship, the decimal numbering system is called a *place value system* and its *base* or *radix* is 10. When dealing with other place value number systems, as we shall be shortly, keep these four relationships in mind: (1) each place position multiplies the value of the digit by the base; (2) a carry from one position to the next increases its weight by a factor of the base; (3) the number of digits used in the system is equal to the base; and (4) the largest digit is one less than the base.

Let's examine a number in the decimal system, for example, the number 634. The 4 is the *least significant digit* (LSD) and occupies the units position. The 3 occupies the 10s position, while 6, the *most significant digit* (MSD), occupies the 100s position. The number 634 in base 10 implies that there are six 100s, three 10s and four 1s. This may be expressed as $(6 \times 100) + (3 \times 10) + (4 \times 1)$, or in scientific notation as $(6 \times 10^2) + (3 \times 10^1) + (4 \times 10^0)$.

Octal. Now let's look at another number system, the *octal* (base-8) system. It has eight digits, the one of greatest value being 7, which is one less than the base. When counting, the sequence is 0 to 7. A carry of 1 from the units position has a weight of 8 because the base is 8. The positional values of the first five positions for the octal number system are shown in Fig. 1.

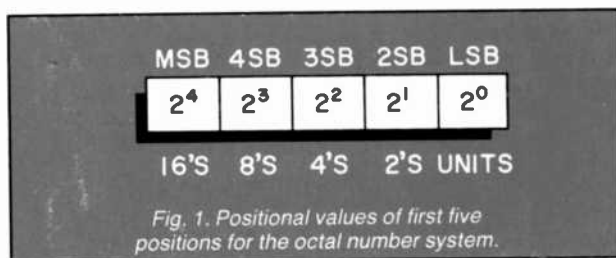

Now let's convert the octal number 1405 to decimal (base 10). Reading this as "one-thousand-four-hundred-five" implies base 10; therefore, this number should be read "one-four-zero-five," which does not imply any base. There are one 512s, which equals 512; four 64s, which equals 256; zero 8s, which equals 0; and five 1s, which equals 5. Summing these subtotals yields $512 + 256 + 0 + 5 = 773$; hence $1405_8 = (1 \times 8^3) + (4 \times 8^2) + (0 \times 8^1) + (5 \times 8^0) = 773_{10}$.

As another example, using Fig. 1 as a guide, let's convert octal 71834 to decimal. There are seven 2048s, which equals 14,336; one 512; eight 64s, which equals 512; but hold on a minute! We can't have "8" in the octal number system because the digit of greatest value is 7; 8 doesn't even exist in octal. Therefore 71834 is an *invalid* octal number!

Let's reverse the process and convert decimal 79 to

octal. Since we are converting to base 8, we will want to repeatedly divide the decimal number by 8 until the quotient is reduced to zero, as follows:

$$\begin{aligned} 79/8 &= 9 + 7 \text{ remainder} \\ 9/8 &= 1 + 1 \text{ remainder} \\ 1/8 &= 0 + 1 \text{ remainder} \end{aligned}$$

The correct octal number is obtained by reading the remainder column from bottom to top, or 117. Hence $79_{10} = 117_8$. The reader should verify this result for himself by converting 117_8 to decimal using the method previously described.

To make sure we understand the process of octal-to-decimal conversion, let's go through one more example and convert decimal 100 to octal:

$$\begin{aligned} 100/8 &= 12 + 4 \text{ remainder} \\ 12/8 &= 1 + 4 \text{ remainder} \\ 1/8 &= 0 + 1 \text{ remainder} \end{aligned}$$

And, after reading the remainders from bottom to top, we have $100_{10} = 144_8$.

Octal is an important numbering system used in computers, as will be explained later.

Hex. *Hexadecimal* (base 16) is another important number system in dealing with computers. Recalling the basic relationships of number systems, how many digits exist in hexadecimal? What is the value of the largest digit? If you guessed 16 and 15, you're right. However, 15 is a decimal number and requires two digits—a 1 and a 5. In the hexadecimal number system, 16 *different* symbols must be used. The conventional zero through 9 are used for the first 10, and A through F are used for the remaining 6, as shown in Fig. 2, with Fig. 3 showing the positional value of a four-digit hexadecimal number.

Conversion from hexadecimal to decimal is done in the same manner as was done with octal-to-decimal conversion. As an example, let's convert the hexadecimal number 7B3F to decimal. There are seven 4096s, which equals 28,672; eleven 256s, which equals 2,816; three 16s, which equals 48; and fifteen 1s, which equals 15. Summing, we obtain 31,551 as our result. Or, in "base-16 scientific notation," $7B3F = (7 \times 16^3) +$

Decimal	Hexadecimal	Octal	Binary
0	0	0	0000
1	1	1	0001
2	2	2	0010
3	3	3	0011
4	4	4	0100
5	5	5	0101
6	6	6	0110
7	7	7	0111
8	8	10	1000
9	9	11	1001
10	A	12	1010
11	B	13	1011
12	C	14	1100
13	D	15	1101
14	E	16	1110
15	F	17	1111

Fig. 2. Equivalent values for the number systems.

MSD	4SD	3SD	2SD	LSD
8 ⁴	8 ³	8 ²	8 ¹	8 ⁰
2048'S	512'S	64'S	8'S	UNITS

Fig. 3. Positional values of a hexadecimal number.

$$(11 \times 16^2) + (3 \times 16^1) + (15 \times 16^0) = 31,551_{10}$$

The conversion of decimal numbers to hexadecimal is the same as decimal-to-octal conversion, except division is by 16 rather than by 8 because the base is 16. What is the hexadecimal for decimal 3,720?

$$\begin{aligned} 3720/16 &= 232 + 8 \\ 232/16 &= 14 + 8 \\ 14/16 &= 0 + 14(E) \end{aligned}$$

Reading the remainders from bottom to top as usual, and substituting the characters A through F for remainders greater than 9 as required yields E88₁₆. Again, the result may be verified by converting it back to decimal to see if it in fact equals 3,720.

Binary. The last number system we'll investigate is the binary (base 2) number system. There are only two digits used in the binary system: 0 and 1. All digital computers employ this number system for internal operations because only two signal levels are required. Binary digits are usually referred to as *bits*; therefore the least significant digit is called the *least significant bit* (LSB) and the most significant digit is called the *most significant bit* (MSB). The positional values of the first five positions of the binary number system are shown in Fig. 4.

MSD	3SD	2SD	LSD
16 ³	16 ²	16 ¹	16 ⁰
4096'S	256'S	16'S	UNITS

Fig. 4. Positional values of a binary number.

Binary-to-decimal conversion is very easy. If a 1 is present in a given position, the weight of that bit is added. If a 0 is present, the weight of that bit is not added. For example, the binary number 10110 = 16 + 0 + 4 + 2 + 0 = 22₁₀.

Decimal-to-binary conversion is similar to that of conversion from decimal to other bases. Let's convert 94₁₀ to binary:

$$\begin{aligned} 94/2 &= 47 + 0 \\ 47/2 &= 23 + 1 \\ 23/2 &= 11 + 1 \\ 11/2 &= 5 + 1 \\ 5/2 &= 2 + 1 \\ 2/2 &= 1 + 0 \\ 1/2 &= 0 + 1 \end{aligned}$$

Therefore 94₁₀ = 1011110₂. Let's verify this result: There is one 64, one 16, one 8, one 4, and one 2, which, after summing, yields 94.

Data Representation. Large numbers in a computer tend to become very long and difficult to work with, since many ones and zeros are required to represent the number. For instance, an 8080 memory address is represented by a binary number 16 bits in length, while larger computers may require up to 32 bits. Other number systems may be used as a shorthand notation of representing binary numbers. If only groups of three bits are considered, 2³ (eight) combinations are possible, namely 000 through 111. The octal number system lends itself nicely to direct substitution of three-bit binary numbers. Let's convert an 8080 memory address for example, 1101000010111100, to octal. We will first want to separate this binary number into groups of three bits each, and then substitute octal digits for each of these groups.

$$\begin{aligned} 001\ 101\ 000\ 010\ 111\ 100 & \text{ (binary)} \\ 1\ 5\ 0\ 2\ 7\ 4 & \text{ (octal)} \end{aligned}$$

Therefore our "lengthy" memory address may also be written as octal 150274. When separating the binary numbers into three-bit groups, we begin at the right (LSB position). Because of this, two zeros were added to fill the most significant octal position. It is important to remember that the number, regardless of the form written, is still in binary form in the computer. The above procedure can be reversed to convert from octal to binary:

Just in time for Christmas! The Handheld Digital Multimeter A practical, useful gift!

The IM-2215 Handheld Digital Multimeter takes the high resolution of a bench instrument into the field with measuring capabilities to 100 μV, 1 μA and 1 ohm. Its 3½ digit liquid crystal display shows DC voltages up to 1000 V, AC voltages up to 750 V, DC and AC current up to 2000 mA and resistances up to 20 megohms. Side pushbuttons allow quick range switching and easy one-handed operation. Kit priced at \$99.95. Send for complete details today using the coupon below. Visa and MasterCard orders call TOLL-FREE: 1-800-253-0570.



FREE COLORFUL CATALOG

Please send me my FREE Heathkit Catalog featuring the IM-2215 Handheld Digital Multimeter and many other quality electronic kits.

Name

Address Apt.

City

State Zip

MAIL TO: Heath Company, Dept. 010-120
CL-765 Benton Harbor, MI 49022

Heathkit
Heath
Company

Circle No. 24 on Free Information Card

1 7 4 6 3 0 (octal)
001 111 100 110 011 000 (binary)

Another (and the most common) base used for writing binary numbers in shorthand notation is hexadecimal. If we separate the binary number into groups of four bits, 2^4 (16) combinations are possible (0000 through 1111). Since there are also 16 digits in hexadecimal, one hexadecimal digit is substituted for each group of four bits. The conversion process from binary to hexadecimal is similar to that of binary to octal, except that the binary number to be converted is broken up into groups of four bits instead of groups of three bits. Let's convert the same memory address used in the example above into hexadecimal.

1101 0000 1011 1100 (binary)
D 0 B C (hexadecimal)

So now our memory address may be represented either by octal 150274 or hexadecimal D0BC. Notice that the hexadecimal representation requires the least number of digits; this and the fact that "filler bits" need not be added to the binary number account for the popularity of this system.

The above procedure of course may be reversed to convert from hexadecimal to binary:

3 A 4 F (hexadecimal)
0011 1010 0100 1111 (binary)

Addition and Subtraction. Now that we have mastered number system conversion, let's go on and find out how addition and subtraction are performed in various number systems. Add the decimal numbers 14 and 35:

1	4
3	5
4	9

When numbers are added, they are added in columns—one number is placed below the other. Either number may be placed first. The digits were separated in the example to emphasize positional differences. The answer is 49 (four 10s and nine 1s).

Now let's add the numbers 85 and 47 in base 10.

1	1	5	(carry)
	8	4	
	4	7	
1	(13)	(12)	
	10	10	(subtract value of carry)
1	3	2	

In this example there is a 12 in the units position. This number is greater than 9, which tells us there must be a carry (10). The digit remaining in the units position will be the difference of 12 and the value of a carry (10), or 2. The 10s position now contains $8 + 4 +$ a carry of 1, or 13. A carry is again indicated by a number greater

than 9. Subtracting 10 from 13, we get 3 with a carry of 1. The third position (100s) contains only the carry. Note that the value of a carry is equal to the base of the number system being used.

Now let's add two octal numbers, say 137 and 461.

1	1	7	(carry)
1	3	1	
4	6	1	
6	(10)	(8)	(decimal sum)
	8	8	(subtract value of carry)
6	2	0	= 620 ₈



Hexadecimal
requires the
fewest
digits...
Thus its
popularity.

As in base 10, the LSD positions are added first. The sum of 7 and 1 is decimal 8. This number is greater than 7 (remember that 7 is the largest digit in base 8), which tells us there must be a carry. Subtracting 8 (the value of a carry) leaves 0 with a carry of 1. The 8^1 position now contains $3 + 6 +$ a carry of 1, or decimal 10. A carry is again indicated by a number greater than 7. Subtracting the value of a carry from 10 leaves a remainder of 2 with a carry into the next position (8^2). This position now contains $1 + 4 +$ a carry of 1, or 6. No carry is generated since the number is less than 8, so 8 is not subtracted. There are six 64s, two 8s and no 1s in our answer.

How about hexadecimal addition? No different! Let's add the hexadecimal numbers 2A4 and 97F.

1	1	4	(carry)
2	A	F	
9	7	F	
12	(18)	(19)	(decimal sum)
	16	16	(subtract value of carry)
C	2	3	= C23 ₁₆

Adding the units column results in decimal 19. Since 19 is greater than the largest hexadecimal digit (F), a carry exists. Subtracting the value of a carry (16) leaves a remainder of 3 with a carry of 1. In the next (16¹) position, the sum of A and 7 plus a carry of 1 is decimal 18. Again a carry is generated, leaving a remainder of 2 with a carry of 1 into the 16² position. Two + 9 + a carry of 1 in the MSD position yields decimal 12, which is C in hexadecimal. The final answer is C23₁₆, indicating that there are twelve 256s, two 16s, and three 1s.

For our last addition problem let's add two binary numbers, say 1010 and 1110.

1	1	1	1	0	0	
1	1	0	1	1	0	(carry)
<hr/>						
1	(3)	(2)	(2)	0	0	(decimal sum)
	2	2	2			(subtract value of carry)
<hr/>						
1	1	0	0	0	0	= 11000 ₂

The method of binary addition is the same as that used with other bases. Any time an addition results in a number greater than 1 (the largest binary digit), a carry is generated. The remainder is then obtained by subtracting the value of a carry (2) from the decimal sum. From this example note that 0+0 always equals 0; 0+1 always equals 1; 1+1 always equals 0 and a carry; 1+1 + a carry always equals 1 and a carry. There is one 16 and one 8 in the answer of the above example.

Let us now examine the process of subtraction in various number systems. Since we are so familiar with base 10 subtraction and the rules involved are the same as those used for other bases, let's review the process of subtraction in base 10. Subtract 24 from 53:

4	(1)3	(minuend)
2	4	(subtrahend)
<hr/>		
2	9	(difference)

As in addition, we start the subtraction process in the LSD position. Since 4 cannot be subtracted from 3, we must "borrow" from the next significant position of the minuend. We may now interpret the 3 as 13 and find the difference, which is 9. Moving to the next position, we must reduce the minuend by 1 because of the borrow. We then subtract the number in the subtrahend from the new minuend, yielding a difference of 2. Remember that the borrow carries with it a weight equal to that of the base.

Keeping these rules in mind, let's subtract two octal numbers.

4	(1)0	
4	3	(1)6
4	3	7
<hr/>		
0	5	7 = 57 ₈

In this example 437₈ is subtracted from 516₈. A borrow is necessary in the first position since 7 is greater than 6. The borrow creates a new number in the minuend LSD position, 16. (This number is read "one-six," not "sixteen," since 16 is a decimal number. One-six in base 8 means 8+6 in base 10). One-six minus 7 equals 7 (if you think in base 10, then (8+6)-7 equals 7). In the next position, 1 was borrowed from the number in the minuend, making its value 0. A borrow is again required; it makes the value of the minuend 10 (or 8+0 in base 10). Subtracting 3 from 10 yields a difference of 5. In the last position, 1 was borrowed from the minuend, making its value 4. The difference in this position is 0.

Applying the same rules as in base 8, let's subtract the hexadecimal number 9AE from the number D96.

C	(1)8	
9	A	(1)6
9	A	E
<hr/>		
3	E	8 = 3E8 ₁₆

A borrow is required in the first position since E is greater than 6. One-six minus E equals 8, or, in base 10, (16+6)-14 equals 8. In the next position A is subtracted from 18 (one-eight), which equals E. Or, in base 10, it would be (16+8)-10 = 14. In the last position we subtract 9 from C (remember that the D became a C because of the borrow), yielding 3.

Finally let's turn our attention to binary subtraction.

Just in time for Christmas! The Most Accurate Clock A great gift idea!

The most accurate consumer clock ever made! The Heath GC-1000 Most Accurate Clock sets and corrects itself automatically by receiving shortwave broadcasts from the National Bureau of Standards. Microprocessor circuitry displays hours, minutes, seconds and even tenths of seconds. Kit priced at \$249.95. Send for complete details today using the coupon below. Visa and MasterCard orders call TOLL-FREE: 1-800-253-0570.



FREE COLORFUL CATALOG

Please send me my FREE Heathkit Catalog featuring the GC-1000 Most Accurate Clock and many other quality electronic kits

Name _____

Address _____ Apt _____

City _____

State _____ Zip _____

MAIL TO: Heath Company, Dept. 010-121
ct 766 Benton Harbor, MI 49022

Heathkit
Heath
Company

Circle No. 28 on Free Information Card

As an example, let's subtract 01101 from 11010:

$$\begin{array}{r}
 0 \quad \swarrow (1)0 \quad \quad \quad 0 \\
 \cancel{0} \quad \quad \quad \cancel{1} \rightarrow (1)0 \quad \quad \quad \cancel{0} \rightarrow (1)0 \\
 0 \quad \quad \quad 1 \quad \quad 1 \quad \quad \quad 0 \quad \quad 1 \\
 \hline
 0 \quad \quad 1 \quad \quad 1 \quad \quad 0 \quad \quad 1 = 1101_2
 \end{array}$$

A borrow is necessary in the LSB (2^0) position since the minuend is 0. The borrow has a weight of 2 since we are working in base 2. In the 2^1 position, 0 from 0 equals 0. A borrow is again required in the 2^2 position since 1 cannot be subtracted from 0. The minuend in the 2^3 position is 0 due to the borrow, so 1 must be borrowed from the 2^4 position. Both MSBs are 0, yielding a difference of 0.

In order to simplify the ALU (Arithmetic Logic Unit—an internal part of the CPU) design, subtraction in a computer is usually performed by addition of the complement of the subtrahend. As an example, subtract 137 from 421:

$$\begin{array}{r}
 421 \\
 -137 \\
 \hline
 284
 \end{array}$$

This same operation may be performed by adding the *ten's complement* of 137 to 421. The ten's complement of a decimal number is the difference between that number and the next higher power of 10. Since the highest power 137 occupies is the hundreds (10^2) position, 10^3 (thousands) would be the next higher power of 10. Therefore, the ten's complement of 137 equals 1000 minus 137:

$$\begin{array}{r}
 1000 \\
 -137 \\
 \hline
 863 \text{ (ten's complement of 137)}
 \end{array}$$

Now perform the subtraction by adding the ten's complement:

$$\begin{array}{r}
 421 \\
 +863 \\
 \hline
 1284
 \end{array}$$

The last step is to subtract the power of 10 used in finding the ten's complement:

$$\begin{array}{r}
 1284 \\
 -1000 \\
 \hline
 284 \text{ (difference)}
 \end{array}$$

Notice that this operation is just a matter of dropping the carry out of the most significant position.

Let's try subtracting 3247 from 9025 using the ten's complement method:

$$\begin{array}{r}
 10000 \\
 -3247 \\
 \hline
 6753 \text{ (ten's complement of subtrahend)}
 \end{array}$$

$$\begin{array}{r}
 9025 \\
 +6753 \\
 \hline
 5778 \text{ (difference) (ignore carry)}
 \end{array}$$

An easier way to obtain the ten's complement of a decimal number is to find the *nine's complement* of that

number and then add 1. The nine's complement of a digit is the difference between 9 and the digit, which may be found by a simple inspection procedure. For instance, the nine's complement of 176 may be found as follows:

$$\begin{array}{r}
 999 \\
 \underline{176} \\
 823 \text{ (nine's complement of 176)}
 \end{array}$$

By adding 1 to the nine's complement, we obtain the ten's complement, or 824.

The computer, of course, cannot perform the ten's or nine's complement directly since it works only in base 2. The computer instead uses what's called *two's complement arithmetic*, which is analogous to ten's complement arithmetic in the decimal system. First let's discuss what the *one's complement* of a binary number is.



All digital
computers use
binary
internally

The one's complement of a binary number is similar to the nine's complement of a decimal number. The one's complement of a bit is the difference between 1 and the bit, which may also be found by a simple inspection procedure. The following example illustrates how the one's complement of 11010110 is found.

$$\begin{array}{r}
 11111111 \\
 -11010110 \\
 \hline
 00101001
 \end{array}$$

Notice that no carries or borrows are involved in this operation (as no carries or borrows were involved in finding the nine's complement of a decimal number). Inspection reveals that the one's complement of a binary number may be found by changing all the zeros in the number to ones and changing all of the ones to zeros. The ALU of the CPU is able to perform this operation very simply with an inverter circuit.

To subtract two binary numbers using the one's complement method, the one's complement of the subtrahend is added to the minuend. The carry out of the MSB

position is then added to the LSB position. This process is called *end-around carry*. Let's find the difference between 10010111 and 01101010 using the one's complement.

$$\begin{array}{r} 10010111 \\ -01101010 \\ \hline \end{array}$$

becomes

$$\begin{array}{r} 10010111 \\ +10010101 \quad (\text{one's complement}) \\ \hline 100101100 \\ (+) \quad \quad \quad 1 \quad (\text{end-around carry}) \\ \hline 00101101 = 101101_2 \end{array}$$

The two's complement is obtained by adding 1 to the one's complement, just as 1 was added to the nine's complement to obtain the ten's complement. When using two's complement subtraction, the carry out of the MSB position is ignored—the end-around carry is not performed as with the one's complement method. When performing a subtraction, the ALU effectively obtains the two's complement of the subtrahend by first obtaining the one's complement (with an inverter), and then starting the addition process with a carry as the following example illustrates:

$$\begin{array}{r} 10110100 \\ -00101111 \\ \hline \end{array}$$

becomes

$$\begin{array}{r} 10110100 \\ +11010000 \quad (\text{one's complement}) \\ (+) \quad \quad 1 \quad (\text{adding a carry produces two's complement}) \\ \hline 110000101 = 1000101_2 \quad (\text{difference}) \end{array}$$

The carryout of the MSB is ignored.

Notice that adding a carry with the subtrahend is the same as performing an end-around carry with the one's complement method. The carry to "complete" the two's complement conversion is simply added at an earlier time as shown in this example.

We can find the two's complement by taking the one's complement and then adding 1, but a faster method exists that enables us to obtain the two's complement by pure inspection. The method is to simply copy down the number to be complemented starting in the LSB position, working left (toward the MSB). Copy all the bits just as they appear up through the first 1. After the appearance of the first 1, all succeeding bits should be written in their one's complement form (1s written as 0s and 0s written as 1s). Consider binary 01001100 for example. We copy this number starting in the LSB (2^0) position, and stop after writing down the 1 in the 3SB (2^2) position. From this point on we invert each bit before writing it down. This process yields 10110100, where we have separated the "inversion point" for clarity. We may check our result by adding to it the original number to be complemented. The result should be 0 (remember that the carry out of the MSB position is ignored) since we are actually subtracting the number from itself.

By now you may have asked yourself, "How does the

computer store negative numbers?" To see how negative numbers are stored let us consider a mechanical register, such as a car's mileage indicator, being rotated backwards. A five-digit indicator approaching and passing through zero would read as follows:

00004
00003
00002
00001
00000
99999
99998
99997
etc.

It should be clear that the number 99997 may also correspond to -3 . If we add

$$\begin{array}{r} 00004 \\ +99997 \\ \hline 100001 \end{array}$$

and ignore the carry out of the MSD position, we have effectively performed the operation of subtraction, which was described previously.

If a system of complements were to be employed for representing negative numbers, the minus sign could be omitted in negative numbers. Use of such a system, however, requires that a convention be established as to what is and what is not a negative number. For example, if the mileage indicator is turned back to 41768, is it

Just in time for Christmas! The Computerized Weather Station Perfect for any season!

This easy-to-assemble ID-4001 personal weather computer gives you up-to-the minute meteorological readouts including time/date, indoor and outdoor (F or C) temperatures, wind speed and direction, and barometric pressure. Past weather data can be recalled with the touch of a button. Kit priced at \$399.95. Send for complete details today using the coupon below.
Visa and MasterCard orders call
TOLL-FREE:
1-800-253-0570.

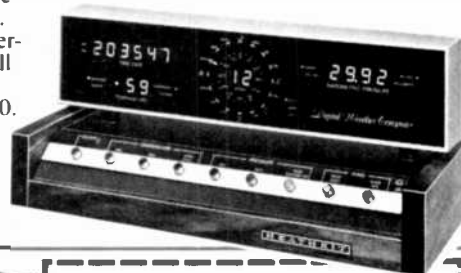

FREE COLORFUL CATALOG

Please send me my FREE Heathkit Catalog featuring the ID-4001 Computerized Weather Station and many other quality electronic kits.

Name _____

Address _____ Apt. _____

City _____

State _____ Zip _____

MAIL TO: Heath Company, Dept. 010-122
CL-767 Benton Harbor, MI 49022

Heathkit
Heath
Company

Circle No. 56 on Free Information Card

27 USEFUL ELECTRONIC DEVICES YOU CAN BUILD YOURSELF AT HOME

Here's how you can use your skills to put the latest electronic technology to work in your home, car, computer or stereo.

The new 1984 *Electronic Experimenter's Handbook* tells you how to build everything from extra keyboards for your microcomputer to an inexpensive auto battery tester and many other useful electronic devices. And you'll complete these projects more quickly and easily than you ever dreamed possible.

Filled with easy-to-follow plans, schematics and instructions for 25 low-cost, functional electronic projects, this invaluable guide—compiled by the publishers of *Computers & Electronics*—belongs in the workshop of every electronics enthusiast.

Here's just a partial list of what you can build with the new 1984 *Electronic Experimenter's Handbook*...

- **Vocal "truth" analyzer**—a hand-held LED display instrument that detects stress in a speaker's voice.
- **Digitally programmed "varmint-zapper"** that delivers a harmless but memorable shock to marauding animals.
- **Degree-day meter** to check your house's heat loss and help you gauge the efficiency of insulation and weather-proofing.

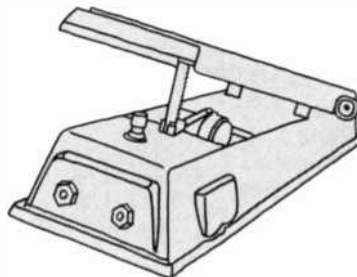
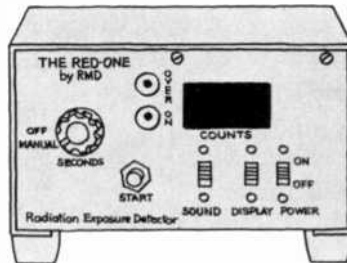
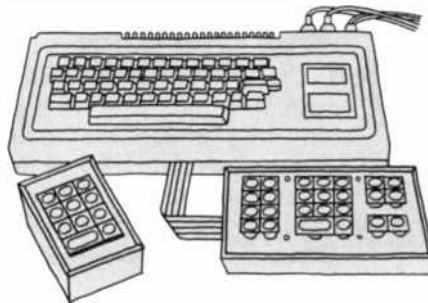

- **Low-cost LED logic monitor** that simultaneously checks all signals on an IC.
- **Sound-effects generator** that enables you to produce any noise you want!
- **"Wah-Wah" foot pedal** attachment for your amplifier.
- **Scratch and rumble filter** that plugs into your preamp jacks and delivers improved audio system performance.
- **Key-down audible signal** for your computer keyboard—to insure proper key selection.
- **Photo-darkroom sink sentinel**, to monitor temperatures and film-process time.

...and many more innovative devices that you'll build with ease and use with pleasure.

Put your skills to work with the 1984 *Electronic Experimenter's Handbook*!

ELECTRONIC EXPERIMENTER'S HANDBOOK

NH5F

CN 1914
Morristown, NJ 07960

YES, send my copy of the *Experimenter's Handbook* for 1984. Enclosed is \$4.95 (\$3.95* plus \$1.00 shipping and handling). \$6.00 outside U.S.A.

Name _____
(please print full name)

Address _____ Apt. _____

City _____

State _____

Zip _____

*Residents of CA, CO, CT, DC, FL, IL, MA, MI, MO, NJ, NY State and VT, please add applicable state tax.

a negative 58232 or a positive 41768? With an ability to represent 100,000 different numbers (0-99999), it would seem reasonable to use half for positive numbers and half for negative numbers. Thus, we could define 0-49999 as positive numbers and 50000-99999 as negative numbers. This is exactly what is done in a computer. Assuming the computer is byte-oriented, each memory location has an ability to represent 256 different numbers (0-255). It is very convenient to reserve the MSB of the byte for what is known as the *sign bit*. When the MSB is 0, it is understood that the remaining (seven) bits represent a positive number. When the MSB has a value of 1, it is understood that the remaining bits represent a negative number *in the two's complement form*. This convention suggests that the largest (most positive) number that may be represented is 0111111_2 , or $+127_{10}$. The smallest (most negative) number that may be represented is 1000000_2 , or -128_{10} .

Fig. 5A illustrates how the decimal number 57 would be stored in a byte-oriented system, while Fig. 5B illustrates how negative 57 would be stored. Try taking the two's complement (the negative) of Fig. 5B and see if in fact the result is positive 57. Note that the inversion process used in producing the two's complement automatically produces a 1 in the MSB position, indicating a negative number. To demonstrate the advantages of us-

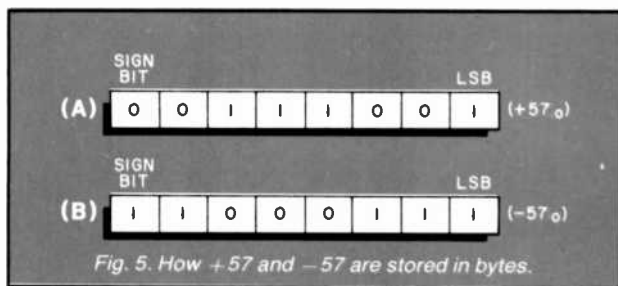

ing the two's complement, let's go through some examples. As our first example, find the sum of positive 5 and positive 9.

$$\begin{array}{r} +5 \\ (+) +9 \\ +14 \\ \hline \end{array} \quad \begin{array}{r} 0000101 \\ +0001001 \\ \hline 0001110 \end{array}$$

Note that the positive numbers are stored in true form and the sum is positive and in true form.

Find the sum of negative 5 and negative 9.

$$\begin{array}{r} -5 \\ (+) -9 \\ -14 \\ \hline \end{array} \quad \begin{array}{r} 1111011 \\ +1110111 \\ \hline 1110010 \end{array}$$

In this case the negative numbers are stored in two's complement form and the sum is negative and already in two's complement form. Remember that the MSB is the sign bit.

Now let's add positive 5 and negative 9.

$$\begin{array}{r} +5 \\ (+) -9 \\ -4 \\ \hline \end{array} \quad \begin{array}{r} 0000101 \\ +1110111 \\ \hline 1111100 \end{array}$$

Again, the sign bit reveals a negative number (-4) in

the two's complement form.

Subtract positive 5 from positive 9.

$$\begin{array}{r} +9 \\ (-) +5 \\ +4 \\ \hline \end{array} \quad \begin{array}{r} 00001001 \\ -0000101 \\ \hline \end{array} \quad \begin{array}{r} 00001001 \\ +1111011 \\ \hline 0000100 \end{array}$$

It was necessary first to complement the subtrahend and then add. The answer is the true form of 4.

Subtract positive 9 from positive 5.

$$\begin{array}{r} +5 \\ (-) +9 \\ -4 \\ \hline \end{array} \quad \begin{array}{r} 0000101 \\ -00001001 \\ \hline \end{array} \quad \begin{array}{r} 0000101 \\ +1111011 \\ \hline 1111100 \end{array}$$

In this case, the difference is negative and appears in the two's complement form.

As a final example, subtract negative 9 from positive 5.

$$\begin{array}{r} +5 \\ (-) -9 \\ +14 \\ \hline \end{array} \quad \begin{array}{r} 0000101 \\ -1111011 \\ \hline \end{array} \quad \begin{array}{r} 0000101 \\ +00001001 \\ \hline 0000110 \end{array}$$

Remember that negative 9 is stored in its two's complement form. To perform the subtraction, the negative 9 is complemented, which puts it in its positive true form, and is added to the minuend (positive 5).

When performing addition and subtraction using the two's complement method, the computer's ALU needs only circuitry to perform the add operation and the two's complementation. Multiplication and division are performed by routines of repeated addition and subtraction. \diamond

Just in time for Christmas! The 16/8-bit H-100 Computer For that someone special!

Power-packed performance works to your advantage with our 16/8-bit H-100 Series Computers. The All-In-One model (shown here) or the sleek Low-Profile model will meet your computing needs now and in the future because of versatile expansion capabilities. Send for complete details today using the coupon below.



FREE COLORFUL CATALOG

Please send me my FREE Heathkit Catalog featuring the H-100 Series Computers and many other quality electronic kits.

Name

Address Apt.

City

State Zip

MAIL TO: Heath Company, Dept. 010-123
CL-768 Benton Harbor, MI 49022

Heathkit®
Heath
Company

Circle No. 57 on Free Information Card

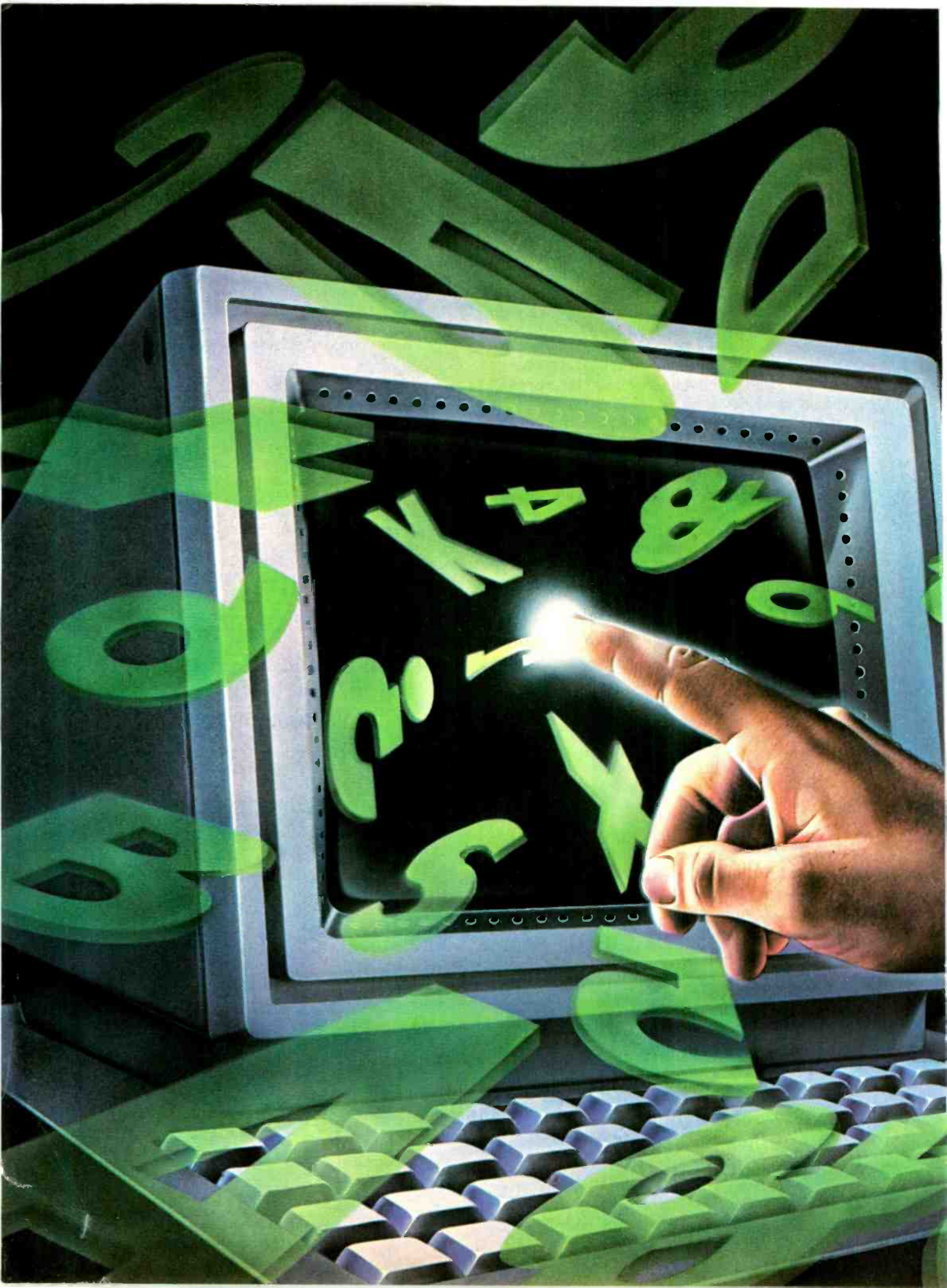



HEWLETT-PACKARD'S NEW TOUCH- SCREEN COMPUTER

Several unique features distinguish the Model HP-150 from other 16-bit microcomputers

By George Mitchell

WHILE some computer manufacturers have been creating systems that resemble the IBM PC, Hewlett-Packard's personal computer division has been working to design the first "intuitive" personal computer. Called the Model HP-150, or HP Touch, this new computer is unlike any system introduced to date. Although it does use an Intel 8088 and Microsoft's MS-DOS 2.0, that's about as far as the Model 150 goes toward being an IBM look-alike.

The differences are enormous and they begin with a basic form-factor that fits in 1.7 sq ft of desk space. Its 8-MHz 8088 microprocessor, 256K of user memory that's expandable to 650K bytes of RAM, 160K bytes of system ROM, 9" green-phosphor monochrome CRT, two expansion slots, three I/O ports, and optional thermal printer are all housed in a single enclosure designed to sit atop the disk subsystem. When equipped with an optional mounting frame, this versatile box of electronics can be tilted

and swiveled to accommodate the user's convenience.

A Touching Moment. There is more to the system enclosure than its compact size. Taking its lead from the interest in Apple's Lisa-like screens and the use of outboard mouse pointing systems, HP incorporated a touch-screen technique for use on the Model 150.

The touch mechanism, based on a design previously used by Xerox in its 5500 series of terminals, utilizes a series of LEDs and photoreceptors to form a 14-by-21-line grid across the screen as shown in Fig. 1. Using individual and multiple grid intersections, a resolution of 1080 points is obtained. The 24 × 80 display actually supports 27 lines, but the three lowest are reserved for identifying the function keys, system status messages, and function blocks for the touch screen where necessary.

The touch screen has fingertip resolution, and therefore is inadequate for applications requiring

high resolution (which, on a business machine, can be handled by business graphics software, rather than a mouse or other drawing devices).

By using the touch-screen technique, applications can be written that use "icons" (pictures of objects that represent a task) or standard menu examples. It's necessary, of course, to ensure that the selection

with the Model 150 system.

Surprisingly, HP didn't make provisions for color, but the 9" screen does support a bit resolution of 390 x 512 pixels. This is sufficient for most business applications, and, by using dithering (changing individual dot intensity) techniques, various depths of shading can be created.

If you're an IBM PC owner, you

may think the color issue important and that HP should consider an add-on color board. Right now, however, HP has no plans to do so, nor does it appear necessary. It's likely that numerous peripheral manufacturers will hop on the bandwagon and offer the option, though.

Two expansion slots are tucked away inside the CRT enclosure. These are for expanding memory and a soon-to-be-released 212A-compatible (300 to 1200 baud) "intelligent" modem.

The built-in interfaces allow the addition of peripherals or attachment of the Model 150 to another 150 or some other system. HP provides two RS-232C ports and HP-IB (IEEE-488) bus. The HP-IB bus is extremely versatile and lets you add an almost unlimited number of devices, including printers, plotters, and more disk drives.

More Hardware Attributes. Although the touch-sensitive CRT seems to be the hot button on the Model 150, HP didn't stop there. The storage systems offered range from dual 256K-byte, 3½" Sony drives (see the box entitled "Small Disks Catch Up") to a 15M-byte Winchester. Unlike previous HP personal computers (such as the HP 80 series), the disk transfer rates are fast and they're based on special in-



Instructions are entered by pointing to the appropriate symbol.

item falls in a box in the grid so that the software is aware of the location. This task is easy both in HP and Microsoft BASIC since the POINT verb can be used to specify screen coordinates.

Though the Model 150 allows an easy way of using applications, the keyboard has eight function keys that correspond to screen labels. This permits the combination of touch-screen zones and function keys that enables the user to select a function quickly.

He is not always forced to use the touch-screen function. By simply entering a keyboard control sequence, the touch functions can be turned off, thus permitting the use of non-touch-oriented software

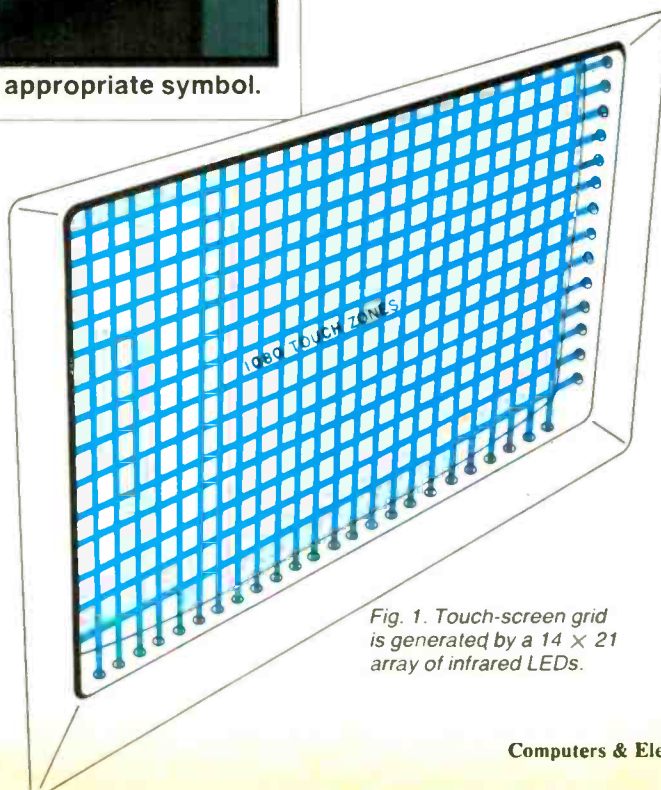
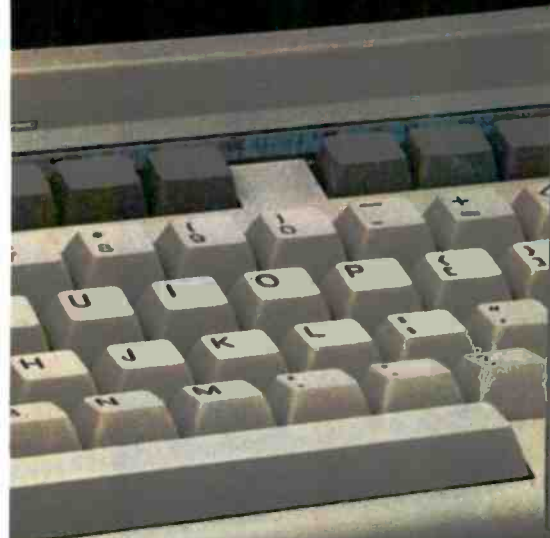

Fig. 1. Touch-screen grid is generated by a 14 x 21 array of infrared LEDs.

...the digital representation...
...the heart, attention and...
...the line...
...the line...
...the line...



Free Post-itTM Note tray from 3M diskettes.

We'll give you a 3M Post-itTM Note tray and a sample pack of Post-it Notes — a \$4.98 value. Absolutely free! Just buy any specially marked box of 3M diskettes and send in the proof of purchase — with 75¢ for postage and handling. Complete details inside specially marked diskette boxes.

One 3M value deserves another.

3M diskettes have long been noteworthy for their unparalleled reliability. A reputation based

on over 30 years experience in manufacturing high quality computer media. Now we're giving you one more good reason to use high quality 3M diskettes.



So buy a specially marked box of 3M diskettes. And send for your free Post-it tray and notes today! Look in the Yellow Pages under computer supplies and parts for the 3M distributor nearest you. In Canada, write 3M Canada, Inc., London, Ontario. If it's worth remembering, it's worth 3M data recording products.

3M hears you...

Circle No. 48 on Free Information Card

3M



The unit has an extremely small footprint. Floppy disks at right are only 3½".

interfaces and protocols developed for much larger systems.

Afforded an early showing of the system at HP's Sunnyvale headquarters, I was unable to benchmark the drives or overall system operation. I do believe, however, that because full-track buffering is used, the system should match the speed of other 16-bit machines.

Although the Model 150 supports the serial and 488 ports without additional hardware, an optional IBM 3270 plug-in emulator card is also available. This gives the Model 150 a direct, high-speed coaxial-cable connector to an IBM host computer, and allows the Model 150 to operate as an intelligent work station.

By using the RS-232 ports, the Model 150 can be connected to an HP 3000 minicomputer, and communications can be established through the 100 DSN/Link software. Further, you can attach any of the popular intelligent RS-232C modems for telephone communications. You might do well to wait for the board-level versions and keep your serial options open, however.

If you really want to keep your desk clutter-free, consider adding the thermal printer (for an extra \$500). This printer can be installed (by you) in the CRT enclosure and it provides an inexpensive way to generate quick notes or dump screen graphics. A graphics example is shown in Fig. 2. The thermal

printer provides a one-to-one relationship to every dot on the screen, so nothing is lost in the translation.

Intuitive Software. Since HP went to the trouble of developing a touch-screen display system, it felt it necessary to create an equally sophisticated software system. With MS-DOS needing some support to ease the user into it, HP developed Personal Applications Manager (P.A.M.). Don't be misled into assuming that P.A.M. is a down-and-dirty front end to MS-DOS. It isn't! In fact, P.A.M. is a sophisticated systems supervisor that surrounds both the operating system and the applications.

The supervisor insulates you

ELECTRONIC GIFT IDEAS!

**NEW! NO INSTALLATION
REQUIRED**

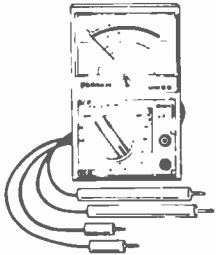

AC/DC 2000 OHM/VOLTMETER MULTITESTER

This pocket size, battery-operated multimeter has 15 ranges, selector switch, and comes with its own test leads. Perfect for hobbyists and technicians who like a bargain.

\$17⁹⁸

only
Model UM 20

3 1/2 DIGIT LOW-COST VOLT/OHM MILLIAMMETER

This low-cost digital meter has: 10 Megohm input impedance AC&DC, with accuracy of DCV $\pm 0.8\% \pm 1$ digit, ACV $\pm 1.2\% \pm 2$ digits. It has auto polarity, auto zero and 24 ranges. Fuse overload protection, test leads, battery and carrying case included at this low price.

\$71⁸⁸

only
Model MD 100



PRECISION DMM WITH $\pm 0.1\%$ DCV ACCURACY AT THIS LOW, LOW PRICE

More features for this price than you would imagine: 10 amp range, AC and DC, extended 2,000 hour battery life, 250 mV for in-circuit resistance measurement, 2.8 Volts for diode testing on "Ohms." Heavy-duty test leads and carrying case included.

\$91⁸⁸

Model MD210

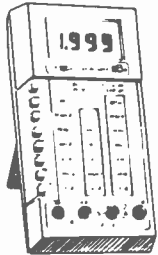

Here's the new low-cost Simpson 470 meter you've heard so much about! With 0.15% DCV accuracy and full measurement capability — 100 mV to 1000 VDC, 100 mV to 750 VAC, 0.1 Ω to 19.99 M Ω , AC/DC current up to 10A, plus a full line of available accessories. Battery, test leads and manual included. Made in U.S.A.

\$138⁸⁸

Model 470

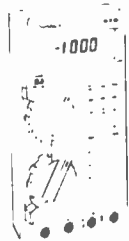

NEW CIRCUITMATE DMM's from BECKMAN

Features .8% DC Volts accuracy, 5 AC/DC ranges, 6 resistance ranges, diode test function, plus the kind of quality you'd expect from Beckman.

\$69⁸⁸

only
Model DM40

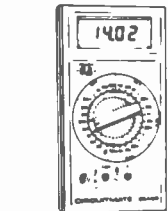

Features .5% DC Volts accuracy, 5 AC/DC Volts ranges, 6 current ranges, 6 resistance ranges, diode test, continuity beeper, and Beckman quality at this very low price.

\$89⁸⁸

Model DM45

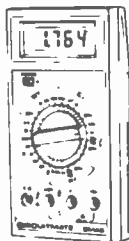

MODEL
PS101
POWER
SUPPLY

\$119⁸⁸ A LOW-COST, QUALITY
TRIPLE-REGULATED
POWER SUPPLY!!!

Designed for hard-to-please, but budget-minded lab technicians, students and hobbyists, the DC triple regulated variable power supply has all the features you could ask for, plus a full 1 year manufacturer's warranty.

3 outputs:

- Fixed 5 VDC $\pm 0.2V$
- 2 variable $\leq 1\frac{1}{2} V$ to $\geq 15 VDC$
- Polarity: floating; can be used as pos. or neg.

Ripple less than 10mV at full load
Regulation $\leq 1\%$ no load to full load
Line regulation $\leq 0.2\%$ 108 VAC to 135 VAC.

Current:

- Fixed supply 1.0 amp max.
- Variable supplies 0.5 amp max.

Protection built in, current limiting, with thermal shutdown.

Power: 108-135 VAC.

Dimensions: 8 1/4" x 3 1/4" x 7 1/4" (WxHxD)

Wood grain finished metal case.

Weight: 4 lbs., 9 ozs.

Lighted on/off power switch, easy-to-read Voltmeter and large binding posts.

Warranty: one year full replacement warranty from date of purchase.

MURA MM-100 COMPUTER TELEPHONE MODEM

Features:

- 0-300 Baud compatible with most time-shared computer systems
- Full duplex operation
- RS232C connector interface
- Carrier Detect indication
- Top quality at this low, low price
- Answer/Originate/Off select switch

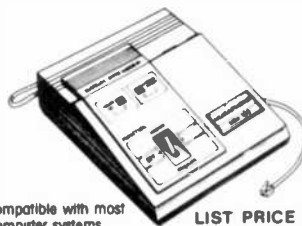

LIST PRICE
\$99.95

Model MM-100

\$79⁸⁸

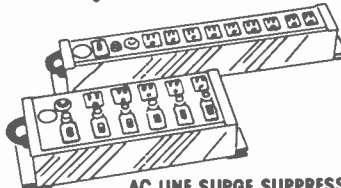

AC LINE SURGE SUPPRESSORS

Protect your delicate computer and expensive equipment from destructive and dangerous transient AC line surges.

Spikes suppressed 6,000 Amps, max. energy absorbed 50 JOULES, spike clamping starts 184V, max. spike voltage allowed 340V.

Model 009 **\$79⁸⁸**
9 outlets

Model 010 **\$85⁸⁸**
5 outlets

Model 012 **\$37⁸⁸**
1 outlet

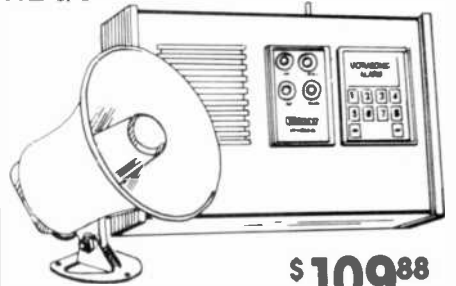

\$109⁸⁸

Model ULTRAR
SP-1212 External
Horn Option \$24.88

BURGLAR ALARM

Ideal for home or office, this ultrasonic burglar alarm requires no installation. Just plug it in, enter your secret code through the push-buttons for operation. Full battery back-up. Covers up to 600 square foot area. Has own internal alarm, or add the external horn (shown) as an accessory. Entry and exit delays—5-minute automatic shut-off and alarm memory.

SPECO HI-FI/STEREO/ BIG SOUND CROSSOVER NETWORKS

HN3-60 **\$10⁸⁸**
60 Watt 3-Way
Crossover Network EACH

HN3-100 **\$16⁸⁸**
108 Watt 3-Way
Crossover Network EACH

HN3-200 (shown) **\$29⁸⁸**
200 Watt 3-Way
Crossover Network EACH

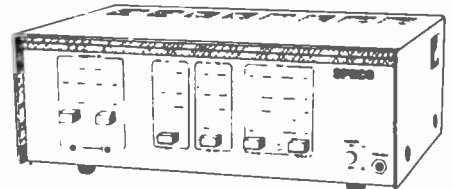
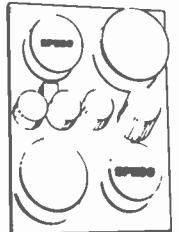

SPECO PROFESSIONAL QUALITY PA AMPLIFIERS

Model PAT-30
30 Watts Music Power
50-18,000 Hz Freq. Response
4 Controls (MIC-1, MIC-2, AUX & TONE) **\$117⁸⁸**

Model PAT-60
60 Watts Music Power
100-20,000 Hz Freq. Response
4 Controls (MIC-1, MIC-2, AUX (Fader) & TONE) **\$147⁸⁸**

Model PAT-120 (shown)
120 Watts Music Power
50-20,000 Hz Freq. Response
6 Controls (MIC-1, MIC-2, VOLUME (Master), BASS, TREBLE & AUX (Fader)) **\$277⁸⁸**



TELEPHONE ORDERS
FILLED FAST! ORDER
DESK OPEN FROM 9
A.M. TO 5 P.M. EST. CALL
(203) 434-8308.



ELECTRONICS WAREHOUSE

Halls Rd. - P.O. Box 624 - Old Lyme, CT 06371

TERMS: U.S. funds, Visa, Amex, MC, Money Order, Check (allow 2 weeks to clear). CT residents add 7 1/2% sales tax. Sale prices for prepaid orders only. Prices and availability of product subject to change without notice. Write for free catalog. C.O.D. orders cash or certified check add \$1.80. Shipping and handling charges add \$3.80 for orders under \$100, add \$7 for orders over \$100 (air freight extra).

ALL ITEMS CARRY FULL
MANUFACTURER'S
WARRANTY PLUS OUR
COMPLETE 45 DAY
MONEY BACK
GUARANTEE!

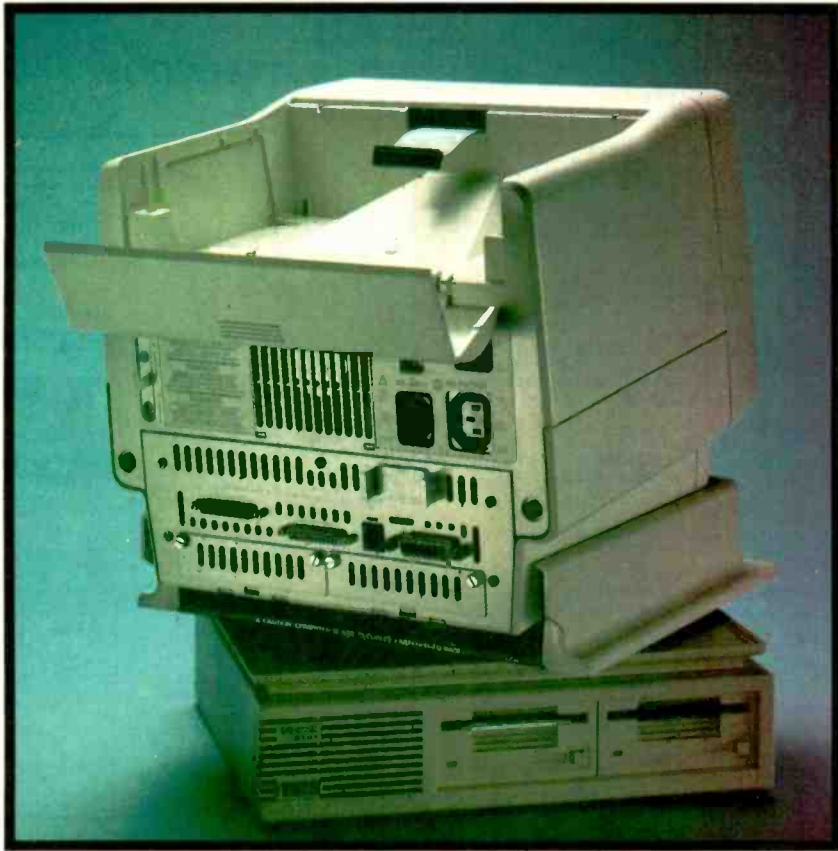

Recess in top of unit accommodates thermal printer.

from the operating system, but you can go to the DOS command level via a series of touch zones with the various applications displayed. To activate one, you touch the correct zone on the screen.

Besides allowing the execution of an application, P.A.M. also handles all the utility functions. For example, if you want to TYPE a file, touching that function on the status row and then the desired file name is all that's required. The same holds true for making backups, formatting diskettes, or listing to the hard-copy device.

If this were all that P.A.M. offered, it would be excellent. But it does still more. Unlike other front ends that only insulate you from the operating system, P.A.M. also serves as a file translator. For example, if you wish to use files created in the touch version of WordStar with dBase II or Condor files, you can do so without any special conversion. The files are automatically converted by P.A.M. in a transparent fashion, thus avoiding the need for separate file manipulation.

Other Software. Working in con-

cert with the P.A.M. concept are two additional HP-supported applications. (When this was written, HP was unsure whether they would be offered separately or bundled.) These include Personal Card File and MemoMaker. The latter is a simple word processor for those who just want to type and print with basic cut-and-paste, as well as on-screen correction capabilities. The files are fully WordStar-compatible

and can also be used in conjunction with other applications. Like all of these, MemoMaker uses the touch-screen functions or, if you like, standard WordStar control-key directives.

The Personal Card File was the application we found the most fascinating. The screen display for entering information looks exactly like a typical roll-type desktop card file. You can, as with the paper card, decide exactly how the information will be entered. All indexing is automatic, making use of the cards easier. Moreover, cards can be linked so that more than one can contain information on the same subject.

In using the card file, the touch-screen functions roll the cards up or down just like a desktop file. Getting the right card is easy. You just touch it, and the screen responds by showing the information on that particular card. Of course, you can print it by simply touching the PRINT SCREEN button. Or, you can print the entire file with a simple touch command.

Although HP software is quite significant, it doesn't stop there. A special version of MicroPro's WordStar takes advantage of all of the touch attributes, and there is a touch version of VisiCalc, a graphics package for creating pie, bar, line, and text charts.

For data communications, HP supplies the DSN/Link. This may be one of the more sophisticated (but basically uncomplicated) communications packages currently

(Text continues on p. 66)

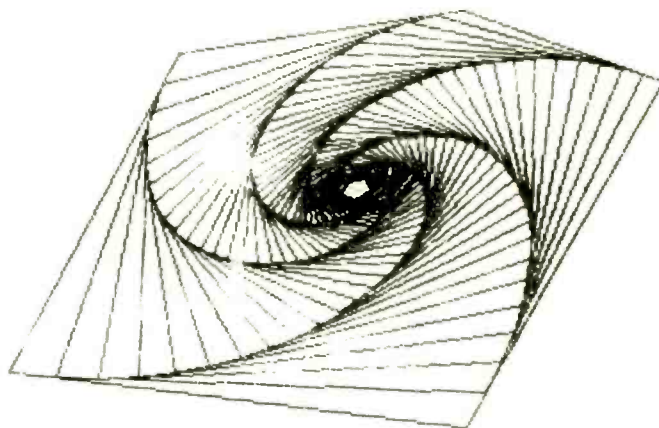
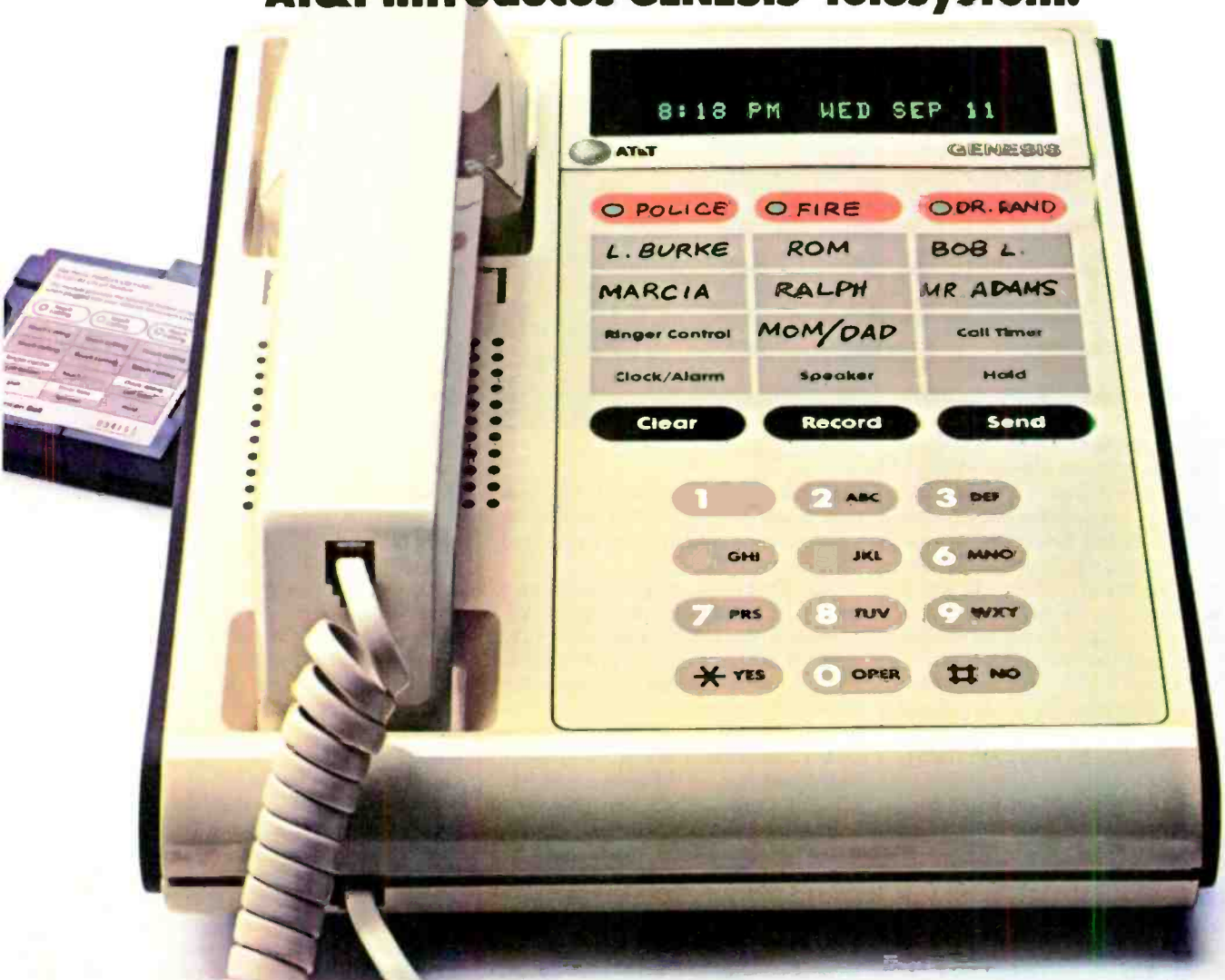

Fig. 2. An example of a screen dump generated by the thermal printer.

Today, you're doing more than ever. So should your phone.

AT&T introduces GENESIS™ Telesystem.



Genesis telesystem is designed to help organize and streamline your life in so many ways.

The Genesis telesystem remembers all your important numbers, including emergency numbers. And it dials with just a touch. It times your calls and even has a built-in speaker.

But the really terrific thing about the Genesis telesystem is that you can customize it to fit your own

needs. Add an optional cartridge, and you've got one-touch access to call forwarding, call waiting, and three-way calling. Or add another cartridge, and you have the convenience of automatic re-dial of busy or unanswered numbers. And that's only half of it.

Soon, you'll be able to add a module with an electronic directory that memorizes names and numbers in alphabetical order.

Or the reminder cartridge, to remind you of special occasions and appointments.

Genesis telesystem. The more you do, the more it will help you do it.

We set the standards.



Counterpoint Views

THE editors of C&E had the opportunity of spending several days with a preproduction model of the HP Model 150. The remarks that follow are first impressions only, on a unit that wasn't fine-tuned for careful examination. Even so, you will observe the diversity of views that comes from subjective analyses.

Josef Bernard: The unit is compact. The disk drive box, with the display *cum* computer sitting atop it, covers not much more than a square foot of desktop area. The full-size keyboard is not small, though. So, although it can be separated from the rest of the system by a coiled telephone-type cable, be prepared to devote a fair amount of desk space to it. Bear in mind also that you will want both the keyboard and the display within arm's reach to use the touch-screen feature.

The display screen is a bit too small for my taste (8½" effective diagonal) and sometimes requires a little peering at. But the display itself is very sharp and the character sets are well defined. On the unit we had, I thought the brightness of the display could have been a little higher. Because of the size of the keyboard and the need to be able to get at the disk drives over the top of the keyboard, the display must, of necessity, be located farther away from the user than might be desirable.

The Model 150 uses an 8088 microprocessor running at a claimed speed of 8 MHz. I was therefore somewhat disappointed by the apparent sluggishness of the system.

Although I did not run benchmark tests on disk-access times, they seemed to be reasonable considering the size of the disks and the files they contained. However, the system appeared to pause for unreasonably long periods of time *after* disk accesses, as if trying to decide what to do with the data it has just read. This annoyed me after a while, especially when I sat with a finger held in the air awaiting the arrival of the next menu on the touch screen.

We did run several benchmark tests from BASIC (Microsoft Version 5.28). The results there were again not as good as we would have expected from an 8-MHz 16-bit CPU. In particular, the popular sieve of Eratosthenes program for finding the first 1437 prime numbers required two minutes and 20 seconds to run to completion. That is just a little

faster than the same program has been run on some 4-MHz Z-80 systems. Take heart, though. The same program took 2 minutes and 57 seconds on an IBM PC.

My first thought was that the overhead of maintaining the touch-screen system was slowing things down, but then I realized that that part of the system was not used (or, at least, did not appear to be used) within BASIC. (Upon questioning Hewlett-Packard

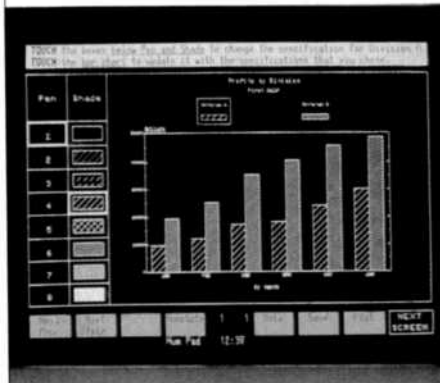

Bar chart shown on an HP-150

about the speed question, I was told that, because of the ROMs used in the preproduction model, the system speed had been reduced.)

One of the most intriguing features of the Model 150 is its touch screen. As explained in the review, the front of the screen is crisscrossed by a grid of infrared light beams spaced less than a finger's width apart. Breaking a pair of beams with a finger or pencil indicates to the computer a set of coordinates and, depending on the software in use, causes a command to be carried out.

In theory, the touch-screen principle is a good one, especially for those who are not familiar with working from a keyboard. The screen displays an array of boxes or pictures, each of which is labeled with a command. All that has to be done to have that command carried out is to touch the appropriate screen area.

In practice, I found it to be a mixed blessing in several senses. Although I must qualify my comments by noting that the WordStar release used was marked "Preliminary," it appears that a few of the word processor's commands—like cursor movement by line and character—could not be carried out using the touch function, but had to be given from the keyboard. Some, like changing the logged disk drive, required

the use of both the screen and the keyboard.

Perhaps there is a reason for the way the commands are divided between the keyboard and the screen, but I have not been able to figure it out. Furthermore, it seems rather silly, in a program devoted to keyboard use, to have to keep moving one's finger(s) between the keyboard and the screen. (I concede, though, that all the WordStar functions can still be carried out from the keyboard alone, without resorting to the touch screen.)

The RPN (Reverse Polish Notation) calculator program supplied us by HP makes a much more sensible use of the touch screen. A full calculator keyboard, including financial functions, is displayed, and all you have to do is touch the appropriate keys on the screen to perform your calculations.

Which brings us to another point about the touch-screen feature. With the system set up so the display unit sits in its swivel mount atop the disk drive unit, and the keyboard far enough in front of them to allow access to the disk-eject buttons on the front of the disk drive box, the screen is elevated rather far above the work surface. This means that, to touch it, you have to extend your arm straight out, or even up at an angle. Over an extended period this can become quite fatiguing, particularly if you have to wait for menus to change and decide to keep your finger at screen level to make the next selection. If the screen were not so far away or were located so that you could point down at it instead of out or up, it would be much more convenient to use.

This is not to say that the touch-screen concept is a bad one, just that it could have been better implemented in this system. Certainly, for simple data-retrieval, as typified by HP's Personal Card File (seen only in demo form), once the data has been entered, the touch method is a convenient way to select and view it. Getting data into the system, however, is a matter better suited to someone with 10 agile fingers than with one finger extended.

Art Salsberg: What a neat little package this is! It's certainly a space-saver on a desk. I'm favorably impressed by the handling ease and apparent ruggedness of the 3½" disk, too. They kept sliding out of a plastic pocket onto the floor again and again without harm.

The touch screen? I love it! In partic-

ular, I found HP's Memomaker program very amenable to such operation. I could block out an entire section of copy for deletion or transfer by simply moving my finger about the screen instead of using the keyboard to move the cursor and mark appropriate locations. It performed as though my finger was a magnet that an opposite-pole cursor followed around. Better than a mouse. And you don't have to memorize commands with either, but the touch screen doesn't take up extra desk space and control is easier. In fairness, though, a cursor can pinpoint a screen object more finely than any finger can. Also, using a touch screen for long time periods may be tiring as well as break the rhythm of a proficient typist.

I found the positioning of the monitor just perfect for this work, contrary to Bernard's feelings. I was also extremely comfortable with viewing the display. Resolution was truly excellent. But then, I've done most of my computing with transportables and all-in-one machines. The keyboard's clustering of keys and touch were really fine.

The one area that was a bit bothersome to me was the slower-than-anticipated data loading speed. Irksome, too, was a rather lengthy screen output de-

lay at times. The computer acted as if it was searching for one of a variety of options, much as one experiences with a higher level on a computer chess program. The HP people advised that production models will be speedier.

If you've got an IBM mainframe in an office, HP's plug-in emulator card links

it locally or remotely. This is an obvious asset.

All this telegraph's Hewlett-Packard's intention to widen its customer base. So does its plan to triple the number of dealers who sell its products, give them better profit margins, higher credit limits, and so on. \diamond

SMALL DISKS CATCH UP

If you're a regular reader of this magazine, you may remember the article on disk storage systems in the July 1983 issue (page 36). As mentioned there, disk systems are getting more capable and, in most cases, smaller.

The Sony 3 1/2" 256K-byte, single-density disk drive is just one of the marvels in storage systems to become available in the last two years. It is the one that Hewlett-Packard has chosen to supply with its Model 150.

The tiny diskettes, which are housed in a plastic cartridge with an automatic shutter to protect the magnetic surface, are capable of storing about 256K bytes of formatted data. To ensure integrity of the data, HP developed a Media Monitor system that automatically tracks the disk's age by counting the number of

times it rotates and tells you when to replace it.

The small diskettes are laid out with 66 tracks/surface broken up into 16 sectors of 256 bytes each. The drives spin at 600 rpm, transfer data at 17.8K baud, and provide a 415-ms average access time.

Although 256K bytes doesn't sound like much storage, especially when you can buy 5 1/4" drives that offer as much as 1M byte per drive, don't despair. Currently, Sony is offering a double-sided, double-density version of the tiny drive that delivers 500K bytes/side and yields 1M byte of storage. These aren't available yet; and, reportedly, some problems still exist in reliability. The drives may, however, begin showing up as early as mid-1984.

Diskette Users...

When you've heard from all the animals in the diskette zoo, but you need fast delivery and high quality diskettes...



Call Communications Electronics

Diskette order desk
800-521-4414
In Canada 800-265-4828

CE...your best source for diskettes

For you the diskette buyer, it's a simple one there. There are so many different brands to choose from, you need to get a dealer to find a good brand at a reasonable cost. Fortunately, CE has already hunted for the best diskettes and offers you an excellent choice at a CE price. To save you even more, CE also offers bulk product where 100 diskettes are packaged in the same box without envelopes or labels. Since we save packaging costs, these savings are passed on to you. Diskette envelopes are also available from CE.

Other Useful Computer Accessories

When the magnetic heads on your computer are dirty, they can cause you a lot of grief. With CE Head Cleaning Station, you can clean the magnetic heads on the diskette drive without to pull 95 seconds. Each kit contains two head cleaning swabs, one enough solution for 25 cleanings. Order 6-CFL for 6" disks and order 6-CLE for 5 1/4" disks. Only \$29.95 each. Includes everything you need to clean the heads. The DC168A data eraser is a small eraser of the DC168A data eraser. The DC168A eraser is 1 1/2" long by 1 1/2" wide by 1 1/2" high. The DC168A eraser is a small eraser of the DC168A data eraser. Order 1-168 for \$14.95 each. The DC168A is a pre-treated head eraser. Order 1-168 for \$14.95 each. The DC168A is a pre-treated head eraser. Order 1-168 for \$14.95 each. The DC168A is a pre-treated head eraser. Order 1-168 for \$14.95 each. The DC168A is a pre-treated head eraser. Order 1-168 for \$14.95 each.

Quantity Discounts Available

Our diskettes are priced 18 cents to 6 or 10 cents to a case. The economy bulk pack is packaged 100 disks in a case without envelopes or labels. Please order only in increments of 100 units for quantity 100 pricing. With the exception of bulk packs, we are also willing to accommodate your smaller orders. Quantity less than 100 units are available in increments of 10 units at a 20% surcharge above our 100 unit price. Quantity discounts are also available. Order 300 or more disks at the same time and deduct 1% 500 or more units you 2% 1,000 or more units you 3% 2,500 or more units you 4% 5,000 or more units you 5% 10,000 or more units you 6% 20,000 or more units you 7% 50,000 or more units you 8% 100,000 or more units you 9% 200,000 or more units you 10%. Minimum order quantity 100 units. Almost all our diskettes are immediately available from CE. Our 5 1/4" and 3 1/2" double-density diskettes are packaged in 100-unit bulk packs only. You need, when you need it. If you need further assistance, to find the Republic diskette dealer right for you, we have an extensive map of the U.S. and Canada showing the telephone number listed at the bottom of this ad. Dealer inquiries invited.

Buy your diskettes from CE with confidence

To get the fastest delivery from CE of your computer products, we recommend you phone your order directly to our Computer Products Division and charge it to your credit card. Be sure to calculate your price using the CE price in the U.S. When purchases orders are processed from approved government agencies and most mail order firms at a 30% surcharge for net 30 billing. For maximum savings, your order should be prepaid. All sales are subject to availability, quantities and verification. All sales are in U.S. dollars. All prices are in U.S. dollars. Prices, terms and specifications are subject to change without notice. Out of stock items will be placed on backorder automatically unless CE is notified differently. Minimum prepaid order is \$50.00. Minimum purchase order \$300.00. All shipments are F.O.B. CE warehouse. No COD's. Non-certified and foreign checks require bank clearance. For shipping charges add \$6.00 per 100 diskettes and/or any fraction of 100 diskettes, or \$6.00 per 100 diskettes and/or any fraction of 100 5 1/4-inch mini-diskettes. For cleaning kits, add \$3.00 per kit. For tape data cartridges, add \$1.00 per cartridge. For envelopes, add \$3.00 per pack of 100 envelopes. For software add \$20.00 each for U.S. ground shipping and handling in the continental U.S. For Canada, Puerto Rico, Hawaii, Alaska, or APO/FPO delivery, shipping charges are three times continental U.S. rates. Mail orders to: Communications Electronics, Box 1002, Ann Arbor, Michigan 48106 U.S.A. If you have a Visa or Master Card, you may call and place a credit card order. Order toll-free in the U.S. Dial 800-521-4414. In Canada, order toll-free by calling 800-265-4828. If you are outside the U.S. or in Michigan dial 313-973-9888. Telex anytime 810-223-2422. Order today. Copyright 1983 Communications Electronics. As of 10/7/83.



Computer Products Division
215 Mueller Dr. Box 1002, Ann Arbor, Michigan 48106 U.S.A.
CEN TEL: FREET 800-521-4414 or within U.S. 313-973-9888

Product Description	Wabash Part #	CE part. 100 pricing per disk (R)	Ultra Part #	CE part. 100 pricing per disk (R)	3M Part #	CE part. 100 pricing per disk (R)	Memorex Part #	CE part. 100 pricing per disk (R)	Burroughs Part #	CE part. 100 pricing per disk (R)	Dyan Part #	CE part. 100 pricing per disk (R)
8" BDDI IBM Compatible 1260/5, 26 Sectors	W11 1	1.00	U1790	1.00	30880	1.94	3005	1.94	PD-101	2.00	DD0001	2.00
8" BDDI Shugart Compatible 32 Hard Sectors	W1A	1.00	U2000	2.40	30880-32	1.94	3015	1.94	PD-106	2.00	DD0018	2.00
8" BDDI IBM Compatible 1120/8, 20 Sectors	W1B1	2.30	U1701	3.10	30880	2.40	3090	2.40	PD-100	2.04	DD0026	3.00
8" BDDI Soft Sector (Uniform)	W1AB	2.90	U2010	2.70	30880	3.14	3100	3.14	PD-108	3.00	DD0030	3.00
8" BDDI Soft Sector (256 B/S, 26 Sectors)	W1AC	2.90	U2011	2.70					PD-110	3.20		
8" BDDI Soft Sector (512 B/S, 16 Sectors)	W1AD	2.90	U2012	3.10					PD-111	3.20		
8" BDDI Soft Sector (1024 B/S, 6 Sectors)	W1AE	2.90	U2013	1.70					PD-112	3.20		
8" BDDI Soft Sector w/Hub Ring	W1A	1.40	U2014	1.70							DD1184	2.00
8" BDDI Same as above but bulk product	W1AB	1.20	U2015	1.30								
8" BDDI 10 Hard Sectors w/Hub Ring	W1A	1.40	U2016	1.70							DD1188	2.00
8" BDDI 18 Hard Sectors w/Hub Ring	W1B	1.40	U2017	1.70							DD1188	2.00
8" BDDI Soft Sector w/Hub Ring	W1C	1.70	U2018	1.00							DD1187	3.10
8" BDDI Same as above, but bulk product	W1C	1.50	U2019	1.00								
8" BDDI Soft Sector Flange (with both sides)	W1D	2.00	U2020	2.70								
8" BDDI 10 Hard Sectors w/Hub Ring	W1E	1.70	U2021	1.00								
8" BDDI 18 Hard Sectors w/Hub Ring	W1F	1.70	U2022	1.00								
8" BDDI Soft Sector w/Hub Ring	W1G	2.00	U2023	2.70								
8" BDDI Same as above, but bulk product	W1G	1.80	U2024	2.40								
8" BDDI 10 Hard Sectors w/Hub Ring	W1H	2.00	U2025	3.70								
8" BDDI 18 Hard Sectors w/Hub Ring	W1I	2.00	U2026	2.70								
8" BDDI Soft Sector w/Hub Ring (26 Sectors)	W1J	2.00	U2027	2.50								
8" BDDI Soft Sector w/Hub Ring (32 Sectors)	W1K	2.00	U2028	3.00								

For more information about this brand call:

8 year warranty on Wabash all Per more info on Wabash call 800-323-9888 In Michigan 313-983-6363

Lifelong warranty on Ultra all Per more info on Ultra call 408-728-7777 Monday-Friday 9 am-4 pm PT

Lifelong warranty on 3M all Per more info on 3M call 800-328-9438 In Massachusetts 617-26-9824

8 year warranty on Memorex all Per more info on Memorex call 800-538-8080 In California 800-672-5629

1 year warranty on Burroughs all Per more info on Burroughs call 800-448-1422 Monday-Friday 9 am-4 pm ET

1 year warranty on Dyan all Per more info on Dyan call 800-525-2211 In California 408-970-8080

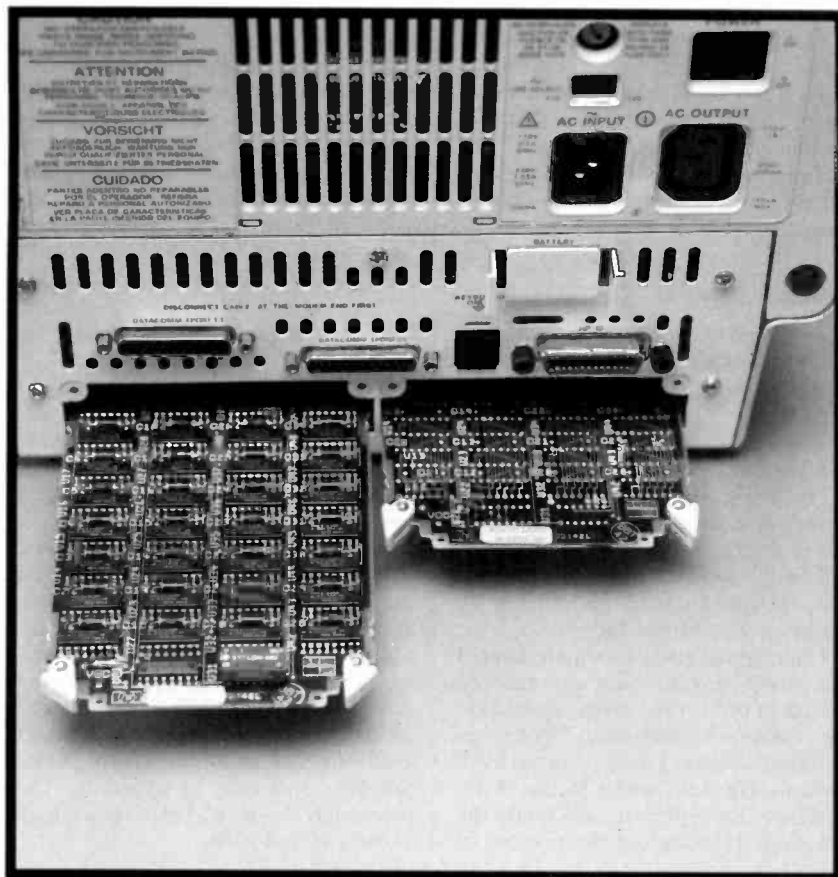

Expansion slots for extra memory and peripherals.

available for micros. It allows the passing of files from one Model 150 to another; from a Model 150 to a mainframe; or, via a modem, to Micronet, The Source, or your favorite bulletin board.

Although DSN/Link is quite good, we were surprised that HP didn't include provisions for background operation. We would have liked to have had the communications functions operating while being able to use another program. This would permit the grabbing of data from a remote system when needed or, if necessary, sending other messages via a spooling mechanism while performing other work. The HP spokesman said that the intent was to provide a single-task work station and that multiple tasks were something that could come later.

Notably, the Model 150 architecture supports task segmentation, and MS-DOS 2.0 seems to have all the necessary links to implement such functions. A number of packages for the IBM PC purport to support such functions already.

An interesting aspect of the Mod-

el 150 software philosophy is that no ROM BASIC is provided, nor is there the HP-BASIC normally offered by HP. Instead, they are offering the standard Microsoft BASIC. (GW BASIC is planned for a later date, as is Pascal.)

Multiple Formats. Even though Hewlett-Packard has settled on 3½" Sony disk drives and has established methods for third-party software vendors to provide software in this format, they are aware that 5¼" double-sided, double-density drives are here to stay for a long time. As a result, you can choose the type of drive you want without stretching the size of the system. Half-height drives are used to keep the space requirements unchanged and you can expect the same for a Winchester.

Although IBM PC compatibility wasn't high on the HP list, you can use software written for the PC. Be aware, however, that the screen presentation won't be the same, and in most cases you probably won't be able to change the screen display attributes easily.

A Top-Notch Selection. Overall, I was impressed by the Model 150's operation and the attention that has been paid to the user's needs. I'd like to see HP bundle the Memo-Maker and Personal Card File as part of the basic purchase price. Possibly, they could also consider adding color display later, and I'd like to see the optional printer made to work with plain paper, rather than special thermal paper. This can be done, as in printers from

"I was impressed by the operation and attention to user's needs."

Brother Ltd., by adding a ribbon carriage. Even color functions can be added by this method.

Though the ability to slide in a printer for \$500 impressed me, not everyone I talked to thought it was that important, or even necessary. Nevertheless, I believe that, for the creation of the fast internal memo or roughing out graphics for a special presentation, it seems to be a low-cost viable solution to diminishing the amount of space usurped on one's desk.

Regarding the paucity of expansion slots, HP feels that it is solving the problem by including the interfaces as standard equipment. The PC and compatibles generally require that you add on those interfaces. We think that the idea isn't all that bad. The Model 150 doesn't require the addition of a multi-function card to supply a continuous clock—it's also built in—and for machine or test equipment control you have the HP-IB. It's doubtful you really need more. And you get all that for under \$4000. A similarly priced IBM PC comes with 64K of RAM, two disk drives, and only a parallel and CRT interface. To get the rest requires anywhere from an additional \$1000 to \$2000.

The only thing I could see that would be beneficial to add to the Model 150 would be voice I/O, and somehow I think that may just be in the wind. ◇

Move up to Microsystems

**THE JOURNAL FOR SOPHISTICATED
MICROCOMPUTER USERS.**

Microsystems is not, in any sense, for beginners. Unlike "personal computer" magazines, *Microsystems* is written *exclusively* for expert users and designers in the software and support hardware field.

If you need a reliable, high-level, up-to-date journal devoted to CP/M,[®] MP/M,[®] MS-DOS,[™] UNIX,[®] XENIX,[™] OASIS and other operating systems, then *Microsystems* is for you. We feature tutorials on the modification and special use of systems, offer short-cut routines, show you debugging procedures, techniques for interfacing, and much more. Our one purpose is to keep the advanced microcomputer professional at the leading edge of DOS development and use.

In a few recent issues of Microsystems you would have seen:

- Reviews of four C compilers: BDS C, Small C, tiny c TWO[™] and Whitesmiths C.
- A programming style comparison: Digital Research PL/I-80[™] vs. Microsoft BASIC.
- Twenty-seven 16-Bit DOS compared.
- Virtual segment procedures under UCSD Pascal.
- An in-depth look at MP/M-80 II.[™]
- A simple 6-byte hexadecimal ASCII conversion routine.
- Using CP/M's undocumented "Autoload" feature.
- An explanation of double density disk controllers.

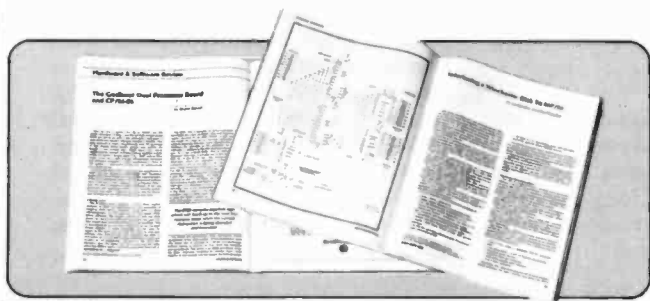

- A comparison of five popular S-100 disk controller cards.
- OS-1—a UNIX-like DOS with a CP/M adapter.

Every issue of *Microsystems* keeps you at the forefront of the industry in customizing software and adapting hardware to meet new requirements and standards. You'll also find industry news, book and new product reviews, plus our regular *Software Directory* listing newly available programs.

To get the high-level systems information you want, join the club of serious microcomputer professionals who subscribe to *Microsystems*. Use the coupon below to order, and save up to 33%!

PROFESSIONALS
PLEASE NOTE:

Your subscription to *Microsystems*
may be tax deductible. Check
with your accountant.

Trademarks:
XENIX: Microsoft; tiny c TWO, tiny c assoc.,
PL/I-80, MS-DOS, MP/M-80 II: Digital Research
Registered Trademarks:
CP/M, MP/M: Digital Research; UNIX: Bell
Laboratories.

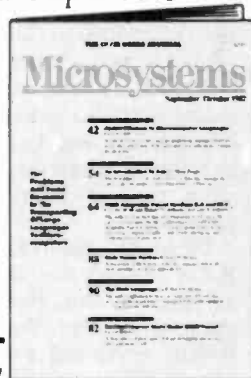

Microsystems CN 1987
Morristown, New Jersey 07960

YES, enter my subscription to *Microsystems* for:

- 12 issues at \$21.97—I save 19%
- 24 issues at \$40.97—I save 24%
- 36 issues at \$55.97—I save 31%

Savings based on full 12-issue subscription price of \$26.97

Mr. _____ 8H518
Ms. _____
(please print full name)

Company _____

Address _____

City _____

State _____ Zip _____

CHECK ONE: Payment enclosed. Bill me later.

Offer valid in U.S. and possessions only. Please allow 30 to 60 days for delivery of first issue. Satisfaction guaranteed or a prompt refund for unmailed issues.

NEW SUBSCRIBERS ONLY

'ARTIFICIAL' EXPANSION OF TIMEX-1000 MEMORY

Programming techniques that will help you make the best possible use of available memory • By William Largent, Jr.

IF you're into programming your Timex 1000 or Sinclair ZX81 computer, you are probably constantly trimming, altering, or scrapping programs due to the lack of sufficient memory to hold them. As a result, you may be spending a quarter of your programming time in fighting the memory problem.

Of course, the 16K, 32K, and 64K RAM add-ons that are available offer an easy way out. However, an understanding of how the Timex/Sinclair BASIC works and is stored in memory can aid you in making the best possible use of whatever amount of memory you have available. Memory conservation will then become an integral part of program design, rather than an afterthought when memory space runs out.

RAM Organization. The built-in RAM of the Timex 1000 consists of 2048 bytes. Since each 1024-byte segment of memory is referred to as a "K," the size of the Timex's memory would be called 2K. But everything that's been written about the computer says that it has only 1K of usable storage!

The discrepancy is resolved when you realize that the computer's BASIC needs 1K of RAM to store a program and another 1K to execute it. That means that there's 1K for you, the programmer (and that's the amount referred to in the literature), and 1K for the computer.

For the purposes of this article, we'll break the 1K of memory available to the

programmer into two segments. The first segment contains the actual text of the BASIC program, such as:

```
100 FOR A=1 TO 100
110 LET B=1+1
120 NEXT A
```

The second segment is broken down into six types of areas, which contain the values of different variables used in the program. In the program excerpt above, the values of variables A and B would reside in this segment.

By understanding how these two segments are used by the computer, a programmer can make the most efficient

The LENGTH component uses another two bytes of memory, and contains a numeric value representing the length of the TEXT and ENTER components.

The TEXT component contains the text of the actual program statement, excluding the line number. Its length can be from 1 to *n* bytes. Finally, the ENTER component contains the ENTER code (118 decimal), and is used to denote the end of a program statement.

Consider the following example:

```
100 IF A=1 THEN PRINT "HI"
```

This statement consumes 21 bytes of memory. However, the actual logic or

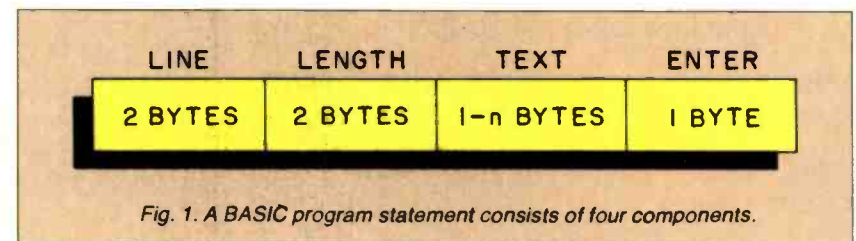

use of the memory available to him. That allows larger, more complex, programs to be written in a memory space where less efficient techniques would have prohibited them.

Memory Requirements. A BASIC program statement, as shown in Fig. 1, consists of four components. The LINE component is two bytes long, and contains a numeric value that represents the line number of the statement.

text of the statement is only 16 bytes in length. Every statement contains five bytes of overhead that serve only to help BASIC execute the program. Therefore it is important to keep the number of statements needed to perform a particular task to a minimum. Each additional statement wastes five bytes of memory! In the following program excerpt, 63 bytes of memory are used to write a program to test three variables producing identical results:

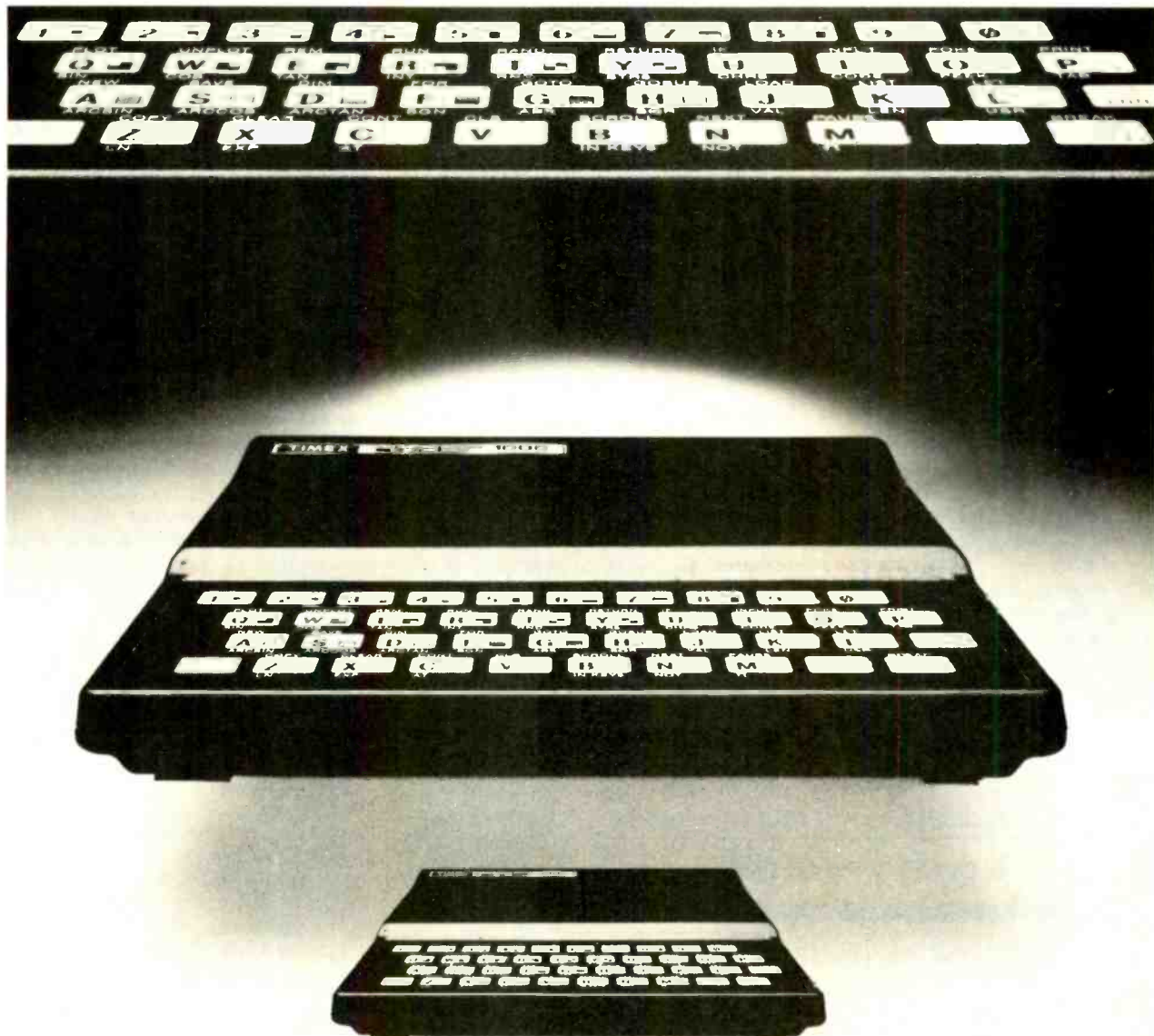

```

100 IF A=1 THEN PRINT "HI"
110 IF B=1 THEN PRINT "HI"
120 IF C=1 THEN PRINT "HI"

```

This could have been coded more efficiently as shown below, and would have used only 41 bytes of memory:

```

100 IF A=1 OR B=1 OR C=1 THEN
PRINT "HI"

```

Remember, not only do extra program statements carry five bytes of overhead, they also consume memory with duplicated code that should be combined with like logic.

As mentioned above, the second—or variable—segment of memory contains six different types of areas. There are three that are important to us. The first two are used for numeric or character

arrays. These arrays are normally associated with the storage of large amounts of data, which is a fact of life in modern computing. In our case, only the data needed from one execution of a program to the next should be stored.

The third area is used to contain numeric variables that are identified in the program by names longer than a single character: i.e., SALES as opposed to S. This convention of using full names is good from the standpoint of being able

to identify what is going on in a program and is fine for computers that have an abundance of memory; but on smaller computers, it should be avoided in the interest of conserving memory.

The variables that are of particular interest to us are single-letter numeric variables, single-letter character variables, and the control variables used in FOR/NEXT loops.

A single-letter numeric variable is created and/or referenced when BASIC encounters a LET or INPUT statement while executing a program. Such a variable is shown in Fig. 2. The LETTER component is one byte in length and contains the unique character that identifies the variable. The VALUE component uses five bytes of memory to contain a representation of the actual numeric value for the variable.

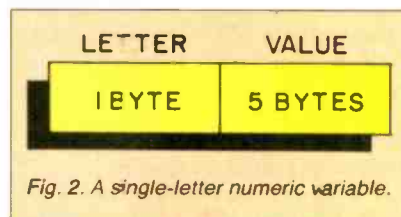

As in the case of a single-letter numeric variable, a single-letter *character* variable is created and/or referenced by BASIC when it encounters a LET or INPUT statement. Its three components are shown in Fig. 3. The LETTER component, which requires one byte, con-

fixed value, as in "LET X=255".) It is frequently more efficient to use a variable than it is to use a literal. Consider the following program excerpt:

```
100 LET A=(RND*100)
110 IF A<100 THEN GOTO 100
```

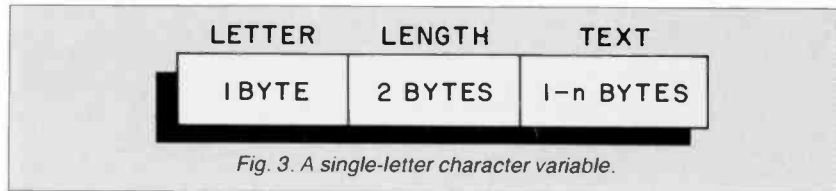

Fig. 3. A single-letter character variable.

tains the character that represents the variable.

The LENGTH component uses two bytes of memory to hold a numeric representation of the length, in bytes, of the actual text represented by the variable LETTER, and can occupy from one to *n* bytes of memory.

The FOR/NEXT loop-control variable is created and/or referenced when BASIC encounters a FOR or NEXT statement while executing a program. Its storage requirements are shown in Fig. 4.

The LETTER component is one byte long, and serves to identify the variable. VALUE is the component that contains a

```
120 IF A=100 THEN GOTO 200
130 IF A>100 THEN GOTO 300
```

Here, after generating a random number, that number is tested to determine which line the program should branch. This sequence of statements requires 111 bytes of memory. What would happen if the same program excerpt were coded as follows?

```
95 LET B=100
100 LET A=(RND*B)
110 IF A<B THEN GOTO B
120 IF A=B THEN GOTO 200
130 IF A>B THEN GOTO 300
```

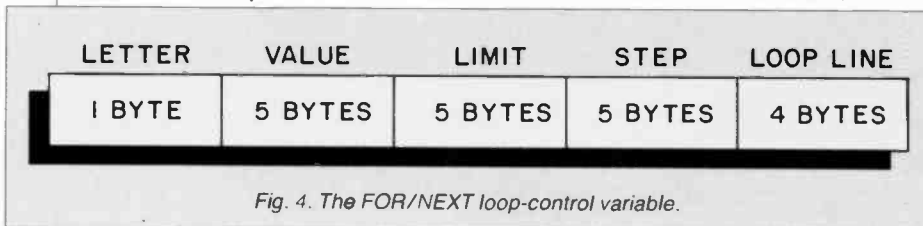

Fig. 4. The FOR/NEXT loop-control variable.

numeric representation of the initial value of the FOR/NEXT loop. Similarly, LIMIT contains the upper limit of the loop. Both VALUE and LIMIT require five bytes of memory. The STEP component is also five bytes long, and represents the increment by which VALUE will be brought up to LIMIT. (This is set to one, unless a different step value is specified.) Finally, LOOP LINE contains a numeric representation of the line number of the first program statement that is to be executed by the loop. It takes up two bytes of memory.

By realizing how to use these three variable types most efficiently, a programmer can make the most of the memory available to him. By the same token, a "full steam ahead" approach to programming, with no consideration given to conserving memory space, can lead to unwanted results. Let's now examine each type of variable in greater detail.

Numeric Literals or Variables. It would be safe to say that 90% of all BASIC programs contain at least one numeric literal or variable. (A literal is a

We added a LET statement assigning a value of 100 to a variable, B. That action created a single-letter numeric variable of the type discussed earlier. Each numeric literal of 100 was then replaced by the single numeric-variable B. That resulted in a saving of 17 bytes.

Where did we steal that extra memory from? Each numeric literal of "100" in the original program used three bytes, while the representation of that number in memory took up six bytes, for a total of nine. Since "100" was replaced by "B," which required only one byte, five times, the initial saving was $(9 \times 5) - (1 \times 5) = 45 - 5$, or 40 bytes. Part of that was used by the new LET statement (17 bytes), and the single-letter numeric variable in that statement (6 bytes). Subtracting $(17 + 6)$, or 23, from 40 gives a total of 17 bytes saved.

Furthermore, if the numeric literal "100" were replaced elsewhere in the program by "B," another eight bytes would be saved each time. Table I shows when it is most efficient to use a numeric literal or single-letter variable.

A normally overlooked feature of Timex/Sinclair BASIC is the fact that a

numeric literal can be replaced by a single-letter numeric variable in GOTO, GOSUB and PAUSE statements. Keep that in mind when determining whether to use literals or variables for particular values in a program. Remember, a few minutes spent setting up variables can save hours of grief later.

Character Literals, Variables, and VAL. Character (as opposed to numeric) literals and variables are typically used to make communication between the computer and the individual using it easier (on the individual). They behave within the computer in much the same way as their numeric counterparts, and large character-variables and -literals should be avoided in the interest of keeping memory use to a minimum.

One aspect of character literals and single-letter character variables that should not be overlooked is their ability—at the expense of a sacrifice in execution speed—to substitute as numeric literals or single-letter numeric variables. That is accomplished by using the VAL function.

The 94-byte program excerpt that evolved from the original 111-byte one can be further simplified by rewriting it to use the VAL function as follows:

```
100 LET A=(RND*VAL "100")
110 IF A<VAL "100" THEN
  GOTO VAL "100"
120 IF A=VAL "100" THEN
  GOTO VAL "200"
130 IF A>VAL "100" THEN
  GOTO VAL "300"
```

By removing line 95, which contained the LET statement, and replacing the single-letter numeric variable "B" with VAL functions, another four bytes can be saved. The total memory space required for this program segment has now gone from the original 111 bytes to 90 bytes. And, an even more efficient version is possible. By reinserting the LET statement and replacing the numerical literals "100" with the single-letter numeric variable "B," the total memory space required for the program segment can be reduced to 85 bytes. Compared to the original 111-byte version, this is shorter by 26 bytes. That represents a 23% reduction in program length, and realizes a greater than 2.5% increase in the amount of total memory available when the program is run.

VAL is a very powerful function, but bear in mind that a program using it, while it will be more memory-efficient, will run more slowly than if numeric variables or single-numeric variables were used.

FOR/NEXT Loops. FOR/NEXT loops

are useful and powerful when applied to a task for which they were intended. However, because of the 18 bytes that a FOR/NEXT loop-control variable requires, its use should be carefully weighed. For programming infinite loops, usually used in games, a FOR/NEXT loop can be somewhat less than efficient. Consider the following program excerpt:

```
100 FOR A=VAL "1" TO VAL
    "9999"
110 IF INKEY$="F" THEN
    GOSUB VAL "500"
120 NEXT A
```

Here, the program will go into an "infinite loop," testing INKEY\$ for the character "F." (This is presumably part of a game program.) These three lines take up 64 bytes of memory. Let's look at a more efficient way of obtaining the same result:

```
100 IF INKEY$="F" THEN
    GOSUB VAL "500"
110 GOTO VAL "100"
```

These two lines, which accomplish the same thing as the three above, now use only 31 bytes, a saving of 33 bytes. In addition, the routine executes more quickly.

If a set of program statements must be executed a specific number of times, use a FOR/NEXT loop. If, on the other hand, an infinite loop that can be halted by the BREAK key is desired, use a GOTO statement.

Subroutines. The use—or lack of use—of subroutines can have a profound effect on the amount of memory consumed by a program. Subroutines

should not be used indiscriminately, though. There are certain guidelines that should be applied. Consider this:

```
100 INPUT A$
```

Just because this line may occur twice in a program does not mean that it should be treated as a subroutine. To do so would cost you 12 bytes of memory. To be eligible for subroutine status, a program statement (or group of statements) should occur more than once in a program, and *should have a collective length greater than 20 bytes*. Anything smaller will waste, not conserve, memory.

Space Available. As you've read this, you've been bombarded with quotes as to how much memory one sequence of statements would use as opposed to another. Programmers soon learn that to be proficient in memory conservation they must have a tool available that shows how much memory any component of a program consumes. Table II shows just such a program written for the Timex/Sinclair with 1K of usable memory. The program can be entered into the computer as shown and can then be executed during program design, or even while the program is being entered. Here's how it works.

The program monitors the size of the program and variable segments of memory. The size of the system variables has been accounted for, as well as a full display screen. (Remember, the characters displayed on the video screen are stored in memory.) It's necessary to take the video display into account because, even though a program, when run, may not use the screen much, *listing* the program does. Therefore, a full video memory should always be assumed.

What the program does is subtract the value of the system variable STKEND (the bottom of the stack area) from RAMTOP, the top of memory, and also compensates for the area used for the video display. STKEND is situated at memory locations 16412 and 16413, and RAMTOP at 16388 and 16389. The video memory area occupies 793 bytes, and the program itself takes up 76 bytes. The figure obtained by running the program is accurate to within 25 bytes.

This program can be used in several ways. The first mode of operation measures the number of bytes used by the program statements under consideration. During this phase, variables are not counted. The program statements are entered into the computer, followed by the RUN command. Since line 2 of the program is a STOP command, BASIC will not get the opportunity to allocate space to any of the variables. If the num-

ber that appears in the upper-left-hand corner of the display is subtracted from 977, the result will be the amount of memory, in bytes, used by the statements in question.

To determine the amount of memory needed for both statements and variables, use this program, but do not run it! Instead, enter GOTO 1. That will preserve the variable area so that an accurate determination of the amount of memory it uses can be made. If your program uses LET statements, you will have to reenter them in the command mode to initialize the variables since that is normally done when the program is run.

Finally, only the variable portion of memory can be analyzed by deleting the program statements prior to issuing a GOTO 1 command. Just make sure that the variable space has been initialized, as previously described. Since the RUN statement was not used, the variable portion of RAM will still be intact.

Note that if the memory size of your computer differs from that of the standard Timex 1000, the locations of the variable areas in the program will have to be changed. They can be found in your User Manual. (The figures used here for STKEND and RAMTOP are found in chapters 26 and 27 of the Timex manual.)

Despite their limited memories, the Timex/Sinclair computers can be put to a number of entertaining and practical uses. To get the most out of them and make the best use of the RAM that's available, use the techniques described here. ◇

MEMORY EFFICIENT VERSIONS OF FAMILIAR STATEMENTS

```
FOR L=VAR "n" TO VAR "n" STEP
    VAR "n"
FOR L=variable TO variable
    STEP variable
GOSUB VAR "n"
GOSUB variable
GOTO VAR "n"
GOTO variable
LET L=VAR "n"
LET L=variable
PAUSE VAR "n"
PAUSE variable
PLOT VAR "n"
PLOT variable
RAND VAR "n"
RAND variable
UNPLOT VAR "n"
UNPLOT variable
```

TABLE I—NUMERIC LITERALS VS. SINGLE-LETTER VARIABLES

For 1- or 2-byte literals:
Used less than 3 times, use
literal.
Used more than 2 times, use
variable.
For 3- to 10-byte literals:
Used less than 3 times, use
literal.
Used more than 2 times, use
variable.

TABLE II—PROGRAM FOR SIZE MONITORING

```
1 PRINT (PEEK VAL "16388"
+ VAL "256" * PEEK VAL
"16389") - (PEEK VAL
"16412" + VAL "256" * PEEK
VAL "16413" - VAL "798")
2 STOP
```

COMPUTER MAIL ORDER

FRANKLIN



CALL FOR PRICING ON
ACE 1000 Color Computer
w/Cover & 1100 Disk Drive, ACE 1200
Computer w/Disk Drive & ACE PRO
PACK: ACE 1000, Disk Drive, 80 Column
Card, ACECalc & ACEWriter.

APPLE IIe STARTER PACK
64K Apple IIe, Apple Disk Drive,
Apple Disk Controller, Apple 80 Column
Card and Apple Monitor... \$1599.00
Koala Apple/Franklin Pad... \$95.00

MICRO-SCI
Apple/Franklin Disk Drives
A2 \$219.00
A40 \$299.00
A70 \$319.00
C2 Controller \$79.00
C47 Controller \$89.00

RANA
Elite I (Apple/Franklin) \$279.00
Elite II (Apple/Franklin) \$319.00
Elite III (Apple/Franklin) \$569.00

MODEMS HAYES
Smart \$219.00
Smart 1200 (1200 Baud) \$509.00
Chronograph \$199.00
Micromodem 100 \$309.00
Micromodem II \$279.00
Micromodem II (with term.) \$299.00
Smart Com II \$99.00
Smart 1200B \$469.00

NOVATION
J-Cat \$119.00
Cat \$144.00
D-Cat \$159.00
103 Smart Cat \$189.00
Apple Cat II \$279.00
103/212 Smart Cat \$439.00
212 Apple Cat II \$609.00
Apple Cat II 212 Upgrade \$309.00

ANCHOR
Mark I (RS-232) \$79.00
Mark II (Atari) \$79.00
Mark III (T.I.99) \$109.00
Mark IV (CBM/PET) \$125.00
Mark V (Osborne) \$95.00
Mark VI (IBM-PC) \$179.00
Mark VII (Auto Ans./Auto Dial) \$119.00
Mark VIII \$269.00
TRS-80 Color Computer \$99.00
9 Volt Power Supply \$9.00

ZENITH
ZT1 Terminal \$389.00



EAGLE
IIE-1 \$1369.00
IIE-2 \$1649.00
IIE-3 \$2399.00
IIE-4 \$3199.00
PC-E \$1579.00
PC-1 \$2399.00
PC-2 \$2799.00
PC-XL \$3599.00
1620 \$3599.00
1630 \$5499.00
1640 \$6499.00
Cyma Software CALL

TeleVideo



TERMINALS

910 \$559.00
912 \$689.00
920 \$739.00
925 \$719.00
950 \$929.00
970 \$1069.00

COMPUTERS

800A \$1099.00
802 \$2699.00
803 \$1949.00
802H \$4695.00
806/20 \$4999.00
816/40 \$9199.00
1602 \$3399.00
1603 CALL

Commodore



CBM 8032
\$599

CBM64 ... \$219
VIC 20 \$89

CALL ON

Executive 64 Portable

1520 Color Printer/Plotter \$169.00
1525 80 Column Printer \$219.00
1530 Datasette \$69.00
1541 Single Disk Drive \$249.00
1600 VIC Modem \$59.00
1650 AD/AA Modem \$89.00
1702 14" Color Monitor \$249.00
Pet 64 \$569.00
Pet 4032 \$599.00
CBM 8032 \$599.00
Super Pet \$999.00
B128-80 \$769.00
2031 \$299.00
8050 \$949.00
8250 \$1199.00
9060 \$1999.00
9090 \$2199.00
4023 \$379.00
6400 \$1399.00
64K Upgrade \$269.00
Spell Master \$149.00
Z-Ram \$549.00
Silicon Office \$749.00
The Manager \$209.00
Soft Rom \$129.00
Jinsam CALL
Call Result 64 \$139.00
CodeWriter 64 \$75.00

PROFESSIONAL SOFTWARE
Word Pro 2 Plus \$159.00
Word Pro 3 Plus \$189.00
Word Pro 4 Plus \$279.00
Word Pro 5 Plus \$279.00
InfoPro \$179.00
Administrator \$399.00
Power \$79.00
Word Pro 64 Plus \$65.00

CAROCO
for VIC 20/C 64
Light Pen \$32.00
Cassette Interface \$29.00
Parallel Printer Interface \$69.00
3 Slot Expans. Interface (20) \$32.00
6 Slot Expans. Interface (20) \$79.00

HOME COMPUTERS



ATARI 600XL \$149
ATARI 800XL \$269
ATARI 1200XL CALL
ATARI 400 CALL
ATARI 800 CALL

1010 Program Recorder \$74.00
1020 40 Col. Printer/Plotter \$249.00
1025 80 Column Printer \$449.00
1027 Letter Quality Printer \$299.00
1050 Disk Drive \$379.00
1030 Direct Connect Modem CALL
CX30 Paddles \$12.00
CX40 Joystick \$8.00
CX42 Remote Joystick CALL
CX77 Touch Tablet \$69.00
CX80 Trak Ball \$49.00
85 Keypad \$105.00
CX418 Home Manager \$69.00
CX488 Communicator II \$229.00
KX7098 Atari Accountant \$209.00
KX7101 Entertainer \$69.00
KX7102 Arcade Champ \$75.00
Koala Atari Pad \$89.00

PERCOM

AT88-S1 \$329.00
AT 88-A2 \$269.00
AT 88-S2 \$569.00
AT 88-S1 PD \$469.00
AT 88-DDA \$145.00
RFD 40-S1 \$449.00
RFD 40-A1 \$279.00
RFD 40-S2 \$729.00
RFD 44-S1 \$539.00
RFD 44-S2 \$869.00
TX 99-S1 (Texas Inst.) \$279.00

RANA
1000 Atari Disk Drive \$319.00
TRAX
AT-D2 CALL

PRINTERS

EPSON
MX80 FT, MX100, RX80, FX80, FX100 CALL
OKIDATA
82, 83, 84, 92, 93 CALL
STAR
Deita 10 \$559.00
Gemini 10X \$299.00
Gemini P15 \$449.00
Serial Board \$75.00
SMITH CORONA
TP-2 \$469.00
Tractor Feed \$119.00
CITOH
Gorilla \$209.00
Prowriter 8510P \$379.00
Prowriter 1550P \$689.00
Starwriter F10-40P \$1149.00
Printmaster F10-55P \$1549.00
Tractor Feed \$199.00

DAISYWRITER
2000 Letter Quality \$1049.00
2500...NEW CALL
Tractor Feed \$109.00

DIABLO
620 \$949.00
630 \$1749.00

IDS
Call for ALL Configurations on
IDS PRISM PRINTERS.

COMREX
ComWriter II Parallel Printer \$499.00
NEC

8023 AN \$399.00
8025 \$729.00
3510 \$1449.00
3530 \$1499.00
3550 \$1799.00
7710/7730 \$1949.00

BMC
401 Letter Quality \$699.00
BX-80 \$259.00

MONITORS

AMDEK
300G \$149.00
300A \$159.00
310A \$169.00
Color I Plus \$279.00
Color II \$399.00
Color III \$349.00
Color IV \$999.00

USI
Pi 1, 9" G \$99.00
Pi 2, 12" G \$119.00
Pi 3, 12" A \$149.00
Pi 4, 9" A \$139.00
1400 Color \$279.00

ZENITH
ZVM 122A \$109.00
ZVM 123G \$99.00

BMC
12" Green \$85.00
9191 AU 13" Color \$249.00

TAXAN
12N Green \$129.00
12A Amber \$139.00
12" RGB I \$299.00

NEC
JB 1260 \$119.00
JB 1201 \$149.00
JB 1205 \$169.00
JC 1215 \$299.00
JC 1216 \$429.00
JC 1203 \$469.00

GORILLA
12" Amber \$95.00
12" Green \$89.00

CALL FOR PRICING ON TIMEX, SHARP & HEWLETT PACKARD!

= WEST = = CANADA = = EAST =

1-800-648-3311 1-800-268-4559 1-800-233-8950

In NV call (702)588-5654, Dept. 1207
P.O. Box 6689, Stateline, NV 89449
Order Status #: 588-5654

In Toronto call (416)828-0866, Dept. 1207
2505 Dunwin Ct., Unit 1B,
Mississauga, Ontario, Canada L5L1T1
Order Status #: 828-0866

In PA call (717)327-9575, Dept. 1207
477 E. Third St. Williamsport, PA 17701
Order Status #: 327-9576

No risk, no deposit on C.O.D. orders. Pre-paid orders receive free shipping within the UPS Continental United States with no waiting period for certified checks or money orders. Add 3% (minimum \$5.00) shipping and handling on all C.O.D. and credit card orders. Larger shipments may require additional charges. NV and PA residents add sales tax. All items subject to availability and price change. We stock manufacturer's and third party software for most all computers on the market. Call today for our new catalog.

CANADIAN ORDERS: All prices are subject to shipping, tax and currency exchange fluctuations. Call for exact pricing in Canada.

Circle No. 11 on Free Information Card

C&E Reviews
Spectravideo's
SV-318
Personal Computer

WITH the low-end computer war inflicting monumental casualties on even powerful companies, new computer makers have to have an appealing mousetrap to stay alive, let alone prosper. It appears that Spectravideo has striven to achieve this by joining with software giant Microsoft and 15 Japanese computer hardware makers (who are just itching to get a toehold in the U.S. market) to develop a universally compatible software standard.

Spectravideo's \$299 (suggested retail price) SV-318 personal computer has apparently been chosen as the group's front-line hardware standard for compatible software called "MSX" (based on Microsoft's super-extended BASIC). A special adapter to use such software is not yet available. Regardless of whether MSX ever sees daylight—and we think

By Its Joystick Ye Shall Know It



"Typing on the SV-318 is not a total joy. . . . The overall value of the computer appears to be good."

that the so-called standard is doomed before it begins—let's examine this modestly priced machine for what it is without MSX.

Description. The Spectravideo SV-318 personal computer is easily recognized by its colorful integrated joystick, which looks like a red golf ball on a tee on the right-hand side of the white plastic enclosure. The machine has a host of features that include CPM "compatibility," top-loading cartridge port, built-in Microsoft BASIC, 16 colors, graphic sprites, extended sound capability, 32K user memory expandable to 256K, and more.

The internal structure includes a Z80A microprocessor, a TI9918A graphics chip, GI8910A sound chip, and Intel's 8255 programmable peripheral interface (PPI). There are ports for expansion and interface purposes, cassette input/output, extra joysticks, and video output.

The keyboard has 67 keys made from what feels like hard, black rubber (sometimes called "chiclet" keys). Each has a stark white identification. Five of them—F1 through F5—can be switched to other functions (F6 through F10) by using the SHIFT key. The bottom line of the video display constantly identifies just what these keys are, even when the user redefines them.

Three other keys, also double-function via the SHIFT key, are for text editing. The alphabet keys, besides providing upper and lower case, carry two graphic symbols each, selected by LEFT GRPH and RIGHT GRPH keys positioned beside the space bar. When held down, every key on the keyboard goes into auto-repeat.

The joystick consists of two elements. The first is a 2" diameter black plastic disk called a "control pad" mounted on the upper surface of the computer just to the right of the keyboard. The top of the control pad has four fingertip indentations, each identified by a directional arrow to indicate cursor motion. The bright red joystick arm is usually plugged into the center hole of the control pad, but it can be removed if desired. The joystick can be used to place the cursor anywhere on the screen, for text editing as well as game playing and other purposes.

The only other item on the upper part of the computer is a small spring-loaded

door that opens to accept plug-in cartridges. As mentioned before, a cartridge adapter must be plugged into this slot to run MSX cartridges. Although there is no keyway on the cartridge edge connector, a cartridge can be inserted in only one direction.

The rear apron supports a large and small card-edge connector and a DIN connector. The large edge connector is used primarily to connect the SV-601 Super Expander, which, in turn, allows increasing the memory to 256K of RAM and 96K of ROM and the connection of other peripherals. The small edge connector permits the use of the special Spectravideo cassette recorder for storage of data. The DIN connector allows hooking to a video monitor (color if desired), or to an r-f modulator (provided in the basic system) for connection to a monochrome or color TV receiver.

On the right-end panel is a pair of joystick ports that accept most commercial joysticks, the main power on-off switch (power on is indicated by a red LED on

the keyboard), and the power supply input. The actual power supply is housed in a separate metal box about 3" on a side and 2" high. This keeps heat from the power supply away from the computer.

On power-up, the Spectravideo logo appears. It remains for a few seconds, and then the display snaps to BASIC. When a game module is plugged in, the same logo appears, and then the system reverts to the game instructions.

Although there is no feedback from the keys, either audible or physical, you can "feel" when the key bottoms out. However, if you press the top or bottom edge of a key, it does not make proper contact. When using the TV as a video monitor, you can hear a slight "click" when a key is fully and correctly depressed.

SV-318 Software. Since no operating system is available with the basic system, only the BASIC interpreter PEEK, POKE, and USR functions allow access to machine language. The BASIC, from Microsoft, includes all of that company's excellent interpreter plus both graphic and sound commands.

The 52 built-in graphic symbols are accessed via the alphabet keys in conjunction with either the RIGHT GRPH or LEFT GRPH function keys. What shows up on-screen is a set of block graphics similar to those used on comparable systems. The graphic symbols can be concatenated to form any desired design.

Up to 32 "sprites" can be created using the BASIC graphic commands. Each sprite can be user-defined to any shape and color desired within an 8 × 8 array. Since each sprite can be given a name, it can be "called" on-screen and moved around. It is easy to include joystick positions to create various games, and begin to achieve arcade-like effects.

The BASIC graphics commands include such useful functions as drawing lines, boxes, circles, parts of a circle, etc.; and they can have any size and positioning desired. A PAINT command allows the use of color both within and without the sketched-in area. The high-resolution graphics of the machine produce 256 × 192 pixels.

The SV-318 can generate sounds when used with an external audio amplifier or a TV receiver. Up to eight octaves can be covered by the built-in sound capabilities of the GI 8910A

SPECTRAVIDEO SV-318 SPECIFICATIONS AND FEATURES

Microprocessor: Z80A operating at 3.6 MHz.

Memory: 32K ROM holding BASIC, expandable to 96K; 32K dynamic RAM, expandable to 256K.

Keyboard: 67 keys, QWERTY style, u/lc; 52 graphics symbols, 10 user-definable keys.

Display: TV or video monitor, 40 char./24 lines using 5 × 9 matrix, 256 × 192 pixels in graphics. HiRes, 16 colors, 32 sprites, and three sound channels with eight octaves per channel.

I/O: Data cassette interface, built-in joystick, expander port, external joystick/graphic tablet port, and game cartridge port.

Software: Built-in 32K-byte Extended Microsoft BASIC with graphics and sound commands.

Peripherals: Data cassette, 300-baud modem, graphics tablet, 80-column printer, floppy disks, RAM and ROM expansion modules, Coleco game cartridge adapter, and an expansion unit for connecting multiple high- and low-power peripherals. Interface cartridges include floppy disk drive controller, Centronics and RS-232 interfaces, IEEE 488 interface, 80-column display card.

Dimensions: 16¼" L × 8¾" W × 3" H. Weight 8 lb.



The joystick is used to place the cursor anywhere on the screen.

sound chip. A simple PLAY command followed by the appropriate coding produces the desired sounds. The octave, tempo, volume, and length of each note can be specified.

As the basic system is shipped, there is ROM (the BASIC) occupying the first 32K bytes of memory, with 32K bytes of RAM above it. Since page one has ROM, we questioned the advertising claim to CP/M compatibility. According to Spectravideo, when you add an expansion interface, a disk controller, and a disk drive, the software (which includes CP/M) performs a memory-map swap so that the RAM is at the bottom. This allows a 32K CP/M, which, with the addition of more RAM, can be increased in size.

A considerable amount of software, both in ROM and cassette, is said to be available. The software includes educational, personal interest and business, recreational, and programming aids.

We did receive three games. Two of these were in ROM plug-ins that booted up when system power was turned on.

The third game was on cassette, which we found very easy to load. In all three cases, the games and their sound effects were of high quality.

We also received a Spectravideo SV-903 cassette recorder for data storage. Since it has no volume or tone controls, it is simple to load and save programs. At the time of writing, neither the SV-601 Super Expander nor the disk system were available for test. A brochure that came with the SV-318 illustrated a large number of peripherals soon to be made available, however. These include a printer, a graphics tablet, interface cards, modem, an 80-column card, various sizes of RAM cards, joysticks, and a Colecovision game adapter.

Conclusion. The Spectravideo SV-318 is an excellent starting system for the beginning computerist. Its broad range of features will satisfy a young student/game player as well as an adult who is interested in learning how to use a computer.

To use the machine with CP/M, how-

ever, would be an exercise in foolishness. Adding up all the expansion hardware to provide a single floppy drive and 64K more memory, the total system would "list" at more than \$1600. Add a video display and software costs to this.

Typing on the SV-318 is not a total joy, owing to the type of keypad it incorporates. Moreover, keys have to be hit dead center to generate a character, which obviates serious touch-typing. But given the computer's price category, combined with the "extra" facilities offered, the overall value of the Spectravideo computer appears to be good.

Will all the promised peripherals be available for sure? How much third-party software support will be given this computer? What kind of price discounting will be practiced by dealers? These are among the cutting questions that come to mind at this time. The performance/price ratio itself is promising for recreational and educational applications.

—Leslie Solomon

Circle No. 83 on Free Information Card

THIS year there were more books published about computers than there were works of fiction. Review copies pour into our office on a regular basis. Many of them treat their subjects with competence and sometimes with a humor that takes the "sting" out of what might otherwise be dry technical material.

Here is a potpourri of recent arrivals that appear to be noteworthy for one reason or another, whether to upgrade one's personal knowledge of a specific computer, a computer language or application, or personal computers in general. The sampling might serve you well during this season of gift-giving, too.



Your IBM PC IBM Personal Computing Guide Book 80-3
 TRS-80® Color Computer Interfacing, With Experiments
 The Potential of Computing in Business Book

VERBAL CONTROL WITH MICROCOMPUTERS RIGSBY TAB 1468

cp/m bible Waite & Angermeyer 22015
 Herget **MASTERING VisiCalc** 0 000

Learning TIMEX/Sinclair BASIC by David A. Lien

WORDSTAR WITH STYLE 13

COMMODORE 64® User's Handbook FIRST EDITION
 Small, Small & Blank THE CREATIVE ATARI

THE APPLE II CIRCUIT DESCRIPTION GAYLER 21959

HOW TO DO IT on the TRS-80 William Barden, Jr.

Data Base Management Systems A Guide to Microcomputer Software Kruglinski 23

An IBM PC Business User's Guide - Controlling Financial Performance Curtis & Lunde Inc. Business Edition

COMPUTER BOOKS

A sampling of interesting books on specific computers, applications software, and personal computing in general

An IBM PC Business User's Guide

Controlling Financial Performance for Higher Profits



Controlling Financial Performance for Higher Profits, subtitled "An IBM PC Business User's Guide," is a wonderful hands-on type of book that guides the reader through the many facets of the popular VisiCalc electronic spreadsheet as used in an IBM PC or XT computer. Detailed screen examples of what different inputs produce and a host of working tips make it easy for the user to start on the road quickly to financial planning and budgeting with an IBM desktop machine. Happily, the guide is written for managers and small business owners, rather than accountants and

computerists. (Published by Curtin & London, Inc. and Van Nostrand Reinhold Co., softcover, 170 pages, \$15.50)

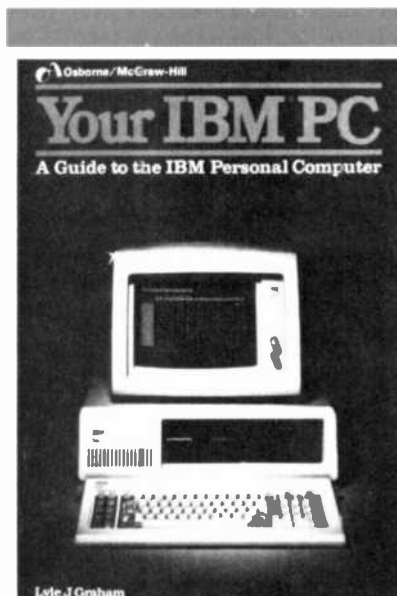

Your IBM PC: A Guide to the IBM Personal Computer, by Lyle J. Graham, offers something for everyone interested in the IBM Personal Computer. It brings into focus on two levels all the key elements that make up one of the most popular business-oriented personal computing systems. For the novice, it

presents an overview of PC hardware and software, step-by-step operating instructions, and an introduction to IBM BASIC programming. For the experienced PC user, it goes into more technical detail, with discussions of PC DOS and CP/M-86 operating systems and IBM BASIC programming, color graphics, and sound. (Published by Osborne/McGraw-Hill, softcover, 400 pages, \$16.95)



Learning Timex/Sinclair BASIC, by David A. Lien, offers a simplified, nonintimidating approach

to learning how to use the Timex/Sinclair TS-1000's built-in language for programming. In his usual witty style, the author takes the reader through the ins and outs of BASIC programming and even includes a helpful tutorial on using the BASIC EDITor to rectify typing errors and to insert and delete material in a BASIC program. To benefit the greatest number of readers, the book is written for the T/S-1000 (as well as Sinclair ZX80 and ZX81) computers without any expansion memory modules. (Published by CompuSoft Publishing, softcover, 331 pages, \$14.95)

THE CREATIVE ATARI



The Creative Atari is an exciting compendium of informative articles for Atari home computers published in *Creative Computing* magazine, plus new material written just for this book. It is written for the nonexpert Atari user who has a limited knowledge of BASIC and simple programming. It shows in elementary terms how to get the most out of Atari computers in graphics, sound, memory, animation, disk storage, and dozens of other topics. In addition to the hardware discussed, a variety of ready-to-run program listings is included. (Published by Creative Computing Press, softcover, 243 pages, \$15.95)

William Barden, Jr. **HOW TO DO IT** on the TRS-80

For the
Model I, II, III,
Color Computers,
and Model 100

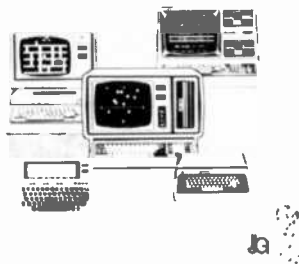

How To Do It on the TRS-80, by William Barden, Jr., is an encyclopedia of information on Radio Shack computers. It brings together in a single volume all the small details a TRS-80 Model I, II, III, 100, or Color Computer owner either can't find in his user's manual or the manual doesn't cover. Using an extensive four-character alphabetic coding system, with substantial cross-indexing, the book helps the reader to rapidly locate just about any information he may need on software, hardware, operating procedures, and computer-related topics like converting from binary to hexadecimal and inserting an IC in its socket. This is a book that any serious TRS-80 user should have handy. (Published by IJG Inc., softcover, 339 pages, (\$29.95)

The Personal Computer in Business Book

Peter A. McWilliams
Author of *The Personal Computer Book*

The Personal Computer In Business Book, by bestselling author Peter A. McWilliams, gives the reader a serious but lighthearted look at computers from the business point of view. Intended for the business person who knows nothing about computers but feels he must know something, the book describes what a computer is and what it can—and *can't*—do in the business environment. There is a comprehensive, if slightly opinionated, guide to the various systems available, as well as a section on how to go about purchasing a computer for business use. (Published by Prelude Press, softcover, 287 pages, \$9.95)

TAB 1468

\$11.95

VERBAL CONTROL WITH MICROCOMPUTERS

BY MIKE RIGSBY



Verbal Control With Microcomputers, by Mike Rigsby, is a book for serious experimenters who want to use their computers to control external devices. It presents a variety of practical applications of sound (not specific voice) recognition technology for using a computer in some fascinating control applications. Using Radio Shack's TRS-80 Model I computer with 16K of RAM as the test bed, the author discusses concepts of sound recognition and explains, through diagrams and program listings, how to implement sound recognition with projects that can be built for less than \$100. (Published by TAB Books Inc., softcover, 404 pages, \$11.95)

Mitchell Waite • John Angermeyer

22016

cp/m bible

The
Authoritative
Reference
Guide to
CP/M®

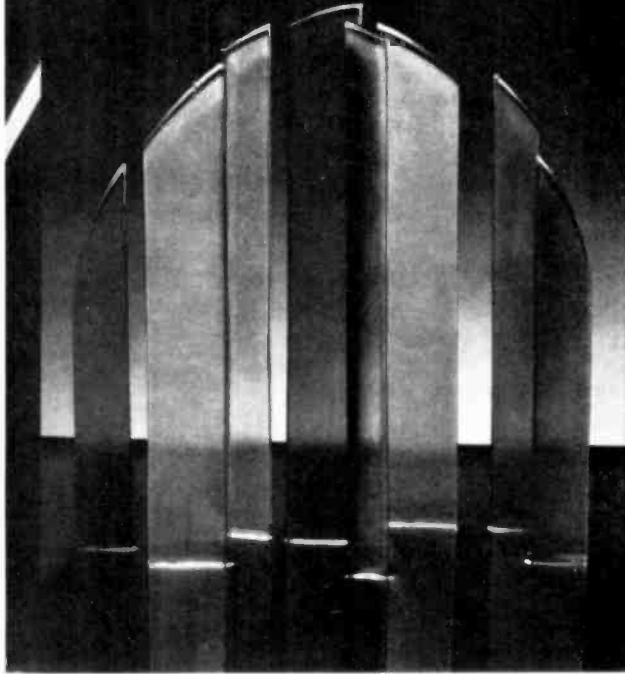

- Covers all CP/M built-in and transient commands
- Compares CP/M 1.3, 1.4, 2.0, 2.2 and 3.0
- Includes optional utilities MAC, SID, LB, LINK and DISPOOL
- Describes BASIC, PASCAL, MAC, CBASIC, and C8-80
- Compares MP/M-II, CP/M-86, MP/M-86, CP/Net, and Concurrent CP/M
- Includes detailed command summary card and extensive bibliography

CP/M Bible, by Mitchell Waite and Howard Angermeyer, subtitled "The Authoritative Reference Guide to CP/M," is indeed authoritative. Rather than serving as a tutorial guide to this popular disk operating system, as so many CP/M books do, this one is more an encyclopedia of CP/M's built-in commands, transient commands, and

operating procedures. Emphasis is on CP/M 2.2 and earlier versions, but CP/M 3.0 is given the once-over as well. Anyone who uses CP/M, whether beginner or experienced, should have the *CP/M Bible* within easy reach. (Published by *Howard W. Sams & Co., Inc.*, softcover, 429 pages, \$19.95)

MASTERING VisiCalc



Mastering VisiCalc, by Douglas Hergert, is one of those rare books that brings to life the normally dry prose of a technical subject. Written in an easy-to-read format, it details most of what a user might wish to know about using the very flexible VisiCalc spreadsheet program. The book even provides a complete introduction to the use of the DIF function for communicating data between the VisiCalc spreadsheet and a BASIC program. This book by itself can serve as both a tutorial course in using VisiCalc and as a quick reference guide for people already familiar with the spreadsheet program. (Published by *Sybx Inc.*, softcover, 217 pages, \$11.95)

WORDSTAR

WORDSTAR
WORDSTAR
WORDSTAR
WORDSTAR

WORDSTAR WITH STYLE

13

WITH
Style

Roger B. White, Jr.

WordStar With Style, by Roger B. White, Jr., is another in a long list of books written for the only word processor that appears to need how-

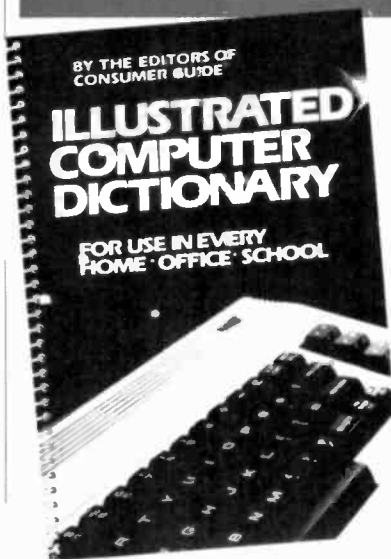

Illustrated Computer Dictionary, by the editors of *Consumer Guide*, brings together the most popular (and some not so popular) terms in common usage among computerists and explains their meanings in lively, down-to-earth language. Beyond the fact that it contains lots of useful information, in bite-sized pieces, this handy spiral-bound book is notable for its airy layout and liberal sprinkling of informative line art. Unlike other dictionaries that present dry facts, this one invites casual reading. (Published by *Exeter Books*, softcover, 180 pages, \$4.98)

to guides owing to its enormous flexibility and great popularity. Written in a project demonstration format, the book is valuable to both the beginner and intermediate user of WordStar. By following the informal exercises presented, the reader learns how to use WordStar's functions and, equally important, why these functions work as they do. The reader is shown how to produce almost any document in a wide variety of print formats. In addition, some of the other software packages that work with WordStar are described. (Published by Reston Publishing Co., Inc., softcover, 181 pages, \$14.95)

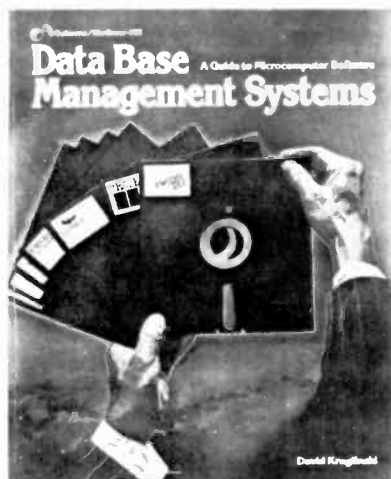

Data Base Management Systems, by David Kruglinski, is an interesting primer that can be used by the reader to choose a database management program that suits his particular needs. It gives an overview of DBMSs and microcomputers and smoothly eases the reader into use of specific types of programs available in the marketplace, using examples and actual screen displays. Detailed descriptions of the Condor Series, dBASE II, FMS-80, and MDBS III database management systems are used to familiarize the reader with the power of these productivity tools. (Published by Osborne/McGraw-Hill, softcover, 260 pages, \$16.95)



TRS-80 Color Computer Interfacing With Experiments, by Andrew C. Stugaard, Jr., is an experimenter's delight because it gets the reader involved in both hardware and software in detailing how to connect useful devices to Radio Shack's popular Color Computer. Instead of describing how to add onto the computer specific devices, emphasis is on how to go about making interfaces. Only a working knowledge of Color BASIC programming and the binary number system are required to understand the procedures detailed. (Published by Howard W. Sams & Co., Inc., softcover, 203 pages, \$14.95)

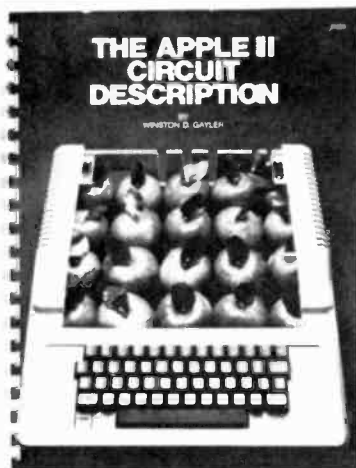

The Apple II Circuit Description, by Winston D. Gayler, is to the Apple II computer what shop manuals are to an automobile. It takes the reader right down to the nuts and bolts level of the computer through

detailed technical descriptions of all versions of the main logic board and current two-piece and older single-piece keyboards. Written on two levels, the text provides an overview for beginners and a detailed circuit analysis for the more advanced. Full technical descriptions are backed up with fold-out logic, schematic, and timing diagrams to help in servicing the computer and successfully interfacing peripherals. This is one book every Apple II owner should have on his shelf. (Published by Howard W. Sams & Co., Inc., softcover, 260 pages, \$22.95)

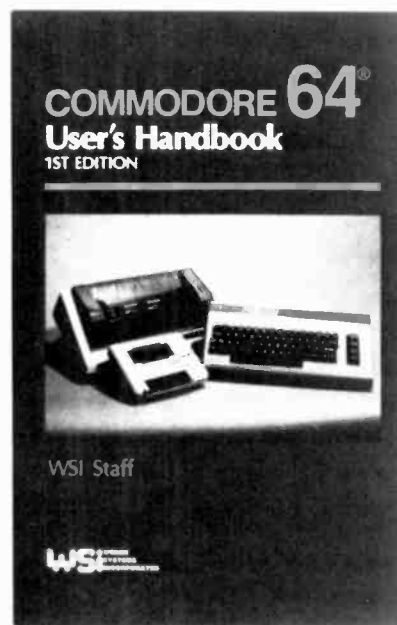

Commodore 64 User's Handbook takes the reader, even if he or she is a first-time computer user, far beyond the user's manual supplied with the versatile Commodore 64 home computer. In meeting its stated aim to serve as a setup, operating, and programming guide for the C-64, this hands-on instruction book makes extensive use of examples and even presents a mini-course in Commodore BASIC programming. Used as a supplement to the C-64 user's manual supplied by Commodore, the book will tell you just about anything most users want to know about this powerful home computer. (Published by Weber Systems Inc., softcover, 307 pages, \$14.95)

Now, the most significant advance in DEC software ever

Announcing DIGITAL REVIEW...the monthly magazine exclusively for your DEC microcomputer.



HARDWARE: Each and every month, you'll get all the latest technological developments—minicomputers... microcomputers... peripherals... telecommunications—and what they mean to you.

I/O FEEDBACK: A chance for you—the user—to network your application needs and ideas.

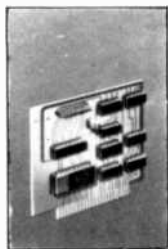

SOFTWARE: Whether it's the newest in operating systems... or advances in computer networks, DIGITAL REVIEW keeps you up-to-date... and spotlights releases that are changing the way businesses conduct their business.



PROGRAMMING: All the latest in programming techniques with special features devoted exclusively to traditional and new software applications.

WORD PROCESSING: You'll learn the newest techniques that will make your office as efficient and as cost-effective as possible.



COMPUTER GRAPHICS: Color visual tools for the financial analyst, the laboratory technician, and the physics major. DIGITAL REVIEW reports on the latest innovations and how you can use them in your field.

Save up to 36%!

Now, through this Special Introductory Offer, you can save up to 36% when you subscribe to DIGITAL REVIEW.

digital
REVIEWS

P.O. Box 2989
Boulder, CO 80322

YES! I want to subscribe to Digital Review for:

- One year (12 issues) for \$24.97—I save 17%!
- Two years for \$43.97—I save 27%!
- Three years for \$57.97—I save 36%!

Savings based on full one-year subscription price of \$29.97

Name _____

Address _____ 8H120

City _____ State _____ Zip _____

Add \$13 for Canada and all other foreign countries. Please allow 30 to 60 days for delivery of first issue.

Check one: Payment enclosed Bill me

Charge my: American Express MasterCard VISA

Account No. _____ Exp. Date _____

Would you like to receive special offers from qualified users of our mailing list? Yes No

Fail-Safe, Real-Time Clock for TRS-80

A REAL-TIME clock accessory for a TRS-80 that will continue to keep time even when the computer is turned off could be a handy thing to have for many applications. Even if your set-up includes an expansion interface, you can add this useful function for about \$30 worth of hardware and a little programming. Here's how: The circuit (below) is based on the MSM5832RS IC that functions as a real-time clock-calendar for use in a bus-oriented microprocessor application. The IC contains all the circuitry necessary to keep track of the seconds, minutes, hours, day of the week, day of the month, and year. It even keeps track of leap years.

Low-cost accessory keeps time even when computer is turned off

By John C. Mein

The MSM5832 normally requires a 5-volt $\pm 5\%$ supply, but will operate satisfactorily from as little as 2.2 volts. This allows a back-up battery to be used.

The chip select line of IC1 (CS, pin 8) is connected to system power. When CS is high (power on), all chip inputs and outputs are enabled. Loss of system power lets R12 pull CS to ground, disabling all inputs and outputs. The

threshold voltage of CS is higher than all other inputs to insure correct operation of this function.

Three 1.2-volt NiCd cells connected in series (B1) are kept at full charge by the 12-volt supply through current-limiting resistors R13 and R14. Diodes D1 and D2 prevent the batteries from discharging back through the supplies when power is turned off.

A standard 32.768-kHz clock crystal (XTAL) is used as a timing reference. (This crystal can be salvaged from a discarded digital wristwatch.) Resistors R1 through R11 insure proper source and sink currents between IC1 and IC2.

Parts layout is not critical and any method of construction can be used in-

PARTS LIST

- B1—1.2 V NiCd cell (3)
 - C1—4.7 μ F, 6-V tantalum capacitor
 - C2, C3—20-pF mica or polystyrene capacitor
 - D1, D2—1N4001 or similar diode
 - IC1—MSM5832RS clock (OKI Semiconductor)
 - IC2—8255 programmable peripheral interface
 - IC3—74LS30 8-input NAND gate
 - IC4—74LS04 hex inverter
 - R1 through R12—10k Ω , $1/8$ -W resistor
 - R13—100- Ω , $1/4$ -W resistor
 - R14—220- Ω , $1/4$ -W resistor
 - XTAL—32.768-kHz crystal
 - Misc.—40-pin connector to TRS-80, wire, prototype board or similar.
- Note**—The following are available from Appcomp, 8255 Jellison Ct., Arvada, CO 80005: MSM5832RS clock chip and 32.768-kHz crystal for \$15.00 postpaid in USA. Colorado residents, add sales tax.

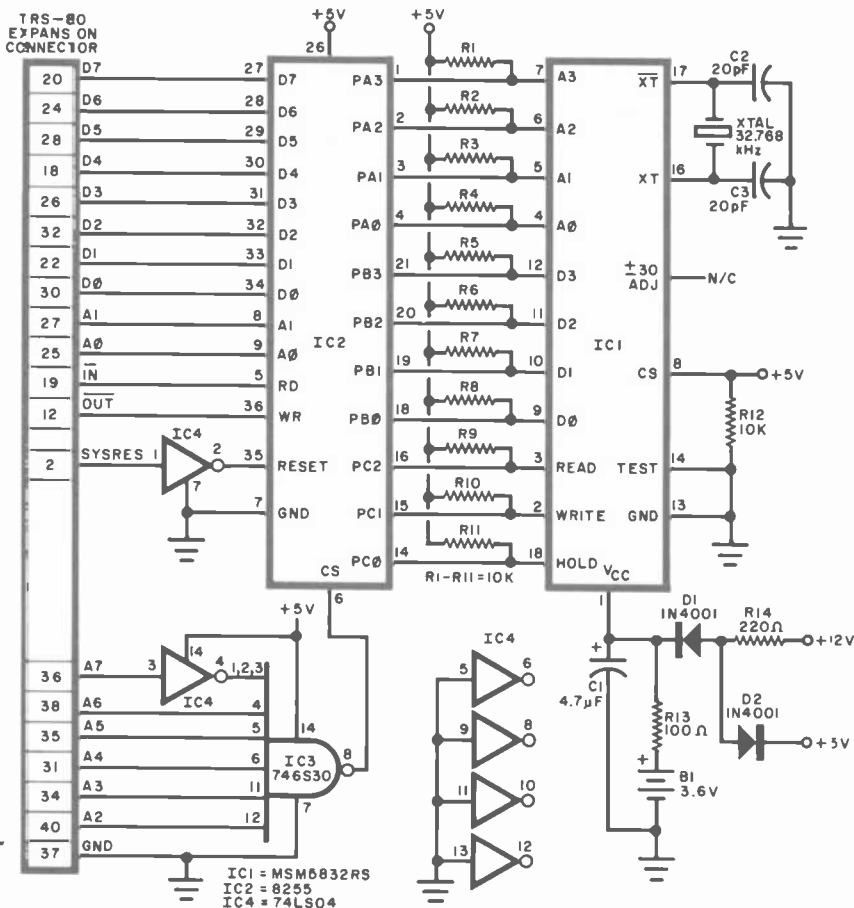

The heart of the clock is an MSM5832RS IC containing all the necessary circuitry to keep track of seconds, minutes, hours, days, months, and years.

1984 Business Activity Planner

Imagine! A complete Appointment Book, Financial Record Keeping System, Travel Information Guide, Health and Fitness Aid and Directory... All in one book!

No matter how organized and successful you are today, our Planner will make you even better in the future... or your money back!

IT'S A GREAT GIFT IDEA, TOO!

Business Activity Planner

IT'S AN APPOINTMENT BOOK! SEE-A-WEEK CALENDAR

■ A full week... at a glance! Time planning becomes easy when your appointments, meetings, luncheon and dinner engagements and special activities are in front of you.

HALF-HOUR TIME SCHEDULING

■ Convenient scheduling... seven days a week.

THINGS TO DO TODAY

■ Keep track of important follow-ups, telephone calls and correspondence.

SEVEN SNAP-LOCK RINGS

■ The seven ring format insures that your pages won't pull out... unless you want them to!

BEAUTIFUL, SOFT, LEATHER-LIKE BINDER

■ Padded front and back, your 9½ x 11½ Planner is comfortable to carry. You can take it with you wherever you go. The sturdy, permanent bookmark always keeps you in the right week and the two inside pockets enable you to keep all your important papers in your 1984 Activity Planner.

YOUR CHOICE OF IMPRINTS

■ Order the 1984 Business Activity Planner for everyone in your office... and select the cover imprint for

each person! Available with Business Activity Planner, Chairman of the Board Activity Planner, Executive Woman Activity Planner, or Executive Activity Planner.

IT'S MUCH MORE!

■ Each Section is Index-Tabbed for Instant Retrieval of Information.

FINANCIAL RECORD KEEPER

- 12 Income and Expense Reports
- 1984 Business Tax Calendar
- Executive Compensation Checklist
- Personal Investment Portfolio

HEALTH AND FITNESS AID

- Fat - Cholesterol - Calorie Charts
- Value of Various Exercises

- Substitution Chart for Better Health

- First Aid Tips

TRAVEL INFORMATION

- Average Temperatures for Most Major Cities
- Rank and Population of the Top 100 U.S. Cities
- Traveling Distances
- Toll-Free Telephone Numbers for Major Airlines, Auto Rentals, Hotels, Motels and much more!

MISCELLANEOUS

This section is filled with valuable information including Principal Holidays, French and California Wine Vintage Charts and more.

DIRECTORY

Places all emergency and important telephone numbers at your fingertips.

ZIFF-DAVIS ACTIVITY PLANNER PO. Box 16-2354, Miami, FL 33116
Please send me the following 1984 Activity Planners at \$38.95* each plus \$5 per copy postage and handling. Outside U.S.A. add \$10 per copy postage and handling.

Specify quantity for each cover imprint ordered:

- ___ Business Activity Planner(s)
- ___ Chairman of the Board Activity Planners)
- ___ Executive Woman Activity Planner(s)
- ___ Executive Activity Planner(s)

QUANTITY DISCOUNTS

(on total number of Planners)

6-20	10% off	(\$4 P&H each)
21-50	15% off	(\$3 P&H each)
51-or more	20% off	(\$2 P&H each)

Payment enclosed. American Express Visa MasterCard Purchase Order enclosed.

Card No. _____ Exp. Date _____

Signature _____

Name _____ (please print)

Company _____

Address _____

City/State/Zip _____

*Florida residents add 5% sales tax.
SATISFACTION GUARANTEED or return
CE-12 within 10 days for a prompt refund!

FOR FASTER SERVICE CALL TOLL FREE
800-327-1969
(In Fla. and Canada call (305) 595-8744)

cluding Wire Wrap or printed circuit. Power requirements are low, and any +12-V and +5-V supply capable of supplying 100 mA will do. The circuit is connected to the TRS-80 via the expansion interface connector as shown in the schematic.

The program used to set the clock to the proper time is shown in Table I. After entering all the time parameters, depressing the "ENTER" key starts the clock. This allows synchronization with an external time reference. The program that displays the contents of the clock on screen is shown in Table II. In operation, this program continually accesses the clock and displays the current time in the upper lefthand corner of the video display.

If you intend to use the clock to control timing functions, you need only occasionally access the clock to determine the time. For instance, when the time reaches a preset value, via external circuitry, the computer could turn various electrical loads on or off.

When accessing the clock chip for reading or writing purposes, make sure that the ICI HOLD line, (pin 18) is *not held high for more than one second*, otherwise, the clock timing is disturbed and a second or two may be lost. With the programs given, this should not be a problem. ♦

TABLE I—CLOCK SETUP ROUTINE

```

1000          'THIS PROGRAM ALLOWS US TO SET THE CLOCK.
1010 OUT 127,128 'FIRST WE SET UP THE PPI FOR ALL OUTPUTS.
1020 DIM A(20)
1030 INPUT"WHAT YEAR IS THIS (LAST TWO DIGITS)";A(15)
1040 INPUT"WHAT MONTH IS THIS (IN NUMBERS)";A(16)
1050 INPUT"WHAT DAY OF THE MONTH IS THIS";A(17)
1060 INPUT"12 OR 24 HOUR FORMAT (ENTER 12 OR 24)";A(18)
1070 IF A(18)=12 OR A(18)=24 THEN 1080 ELSE 1060
1080 IF A(18)=24 THEN 1110
1090 INPUT"AM OR PM";A$
1100 IF A$="AM" OR A$="PM" THEN 1110 ELSE 1090
1110 INPUT"WHAT HOUR WILL IT BE";A(19)
1120 INPUT"WHAT MINUTE WILL IT BE";A(20)
1130 INPUT"IS THIS A LEAP YEAR (YES OR NO)";Y$
1140 IF Y$="YES" OR Y$="NO" THEN GOTO 1150 ELSE 1130
1150 A(0)=A(1)=0 'ZERO OUT THE SECONDS REGISTERS.
1160 A(2)=10*(A(20)/10-FIX(A(20)/10)) 'GET THE MIN 1'S
1170 A(3)=INT(A(20)/10) 'GET THE MIN 10'S
1180 A(4)=10*(A(19)/10-FIX(A(19)/10)) 'GET THE HRS 1'S
1190 A(5)=INT(A(19)/10) 'GET THE HRS 10'S
1200 A(7)=10*(A(17)/10-FIX(A(17)/10)) 'GET THE D.O.M. 1'S
1210 A(8)=INT(A(17)/10) 'GET THE D.O.M. 10'S
1220 A(9)=10*(A(16)/10-FIX(A(16)/10)) 'GET THE MONTHS 1'S
1230 A(10)=INT(A(16)/10) 'GET THE MONTHS 10'S
1240 A(11)=10*(A(15)/10-FIX(A(15)/10)) 'GET THE YRS 1'S
1250 A(12)=INT(A(15)/10) 'GET THE YRS 10'S
1260 IF A(18)=24 THEN A(5)=A(5)+8 'ADJ FOR 24 HR FORMAT
1270 IF A$="PM" THEN A(5)=A(5)+4 'ADJ FOR PM
1280 IF Y$="YES" THEN A(8)=A(8)+4 'ADJ FOR LEAP YEAR
1290 INPUT"HIT ENTER TO START THE CLOCK";D$ 'WAIT TO SYNCHRONIZE THE CLOCK.
1300 OUT 126,1 'ASSERT HOLD TO STOP CLK
1310 FOR I=0 TO 12 'ADDRESSING LOOP
1320 OUT 124,I 'ADDRESS THE PROPER REGISTER.
1330 OUT 125,A(I) AND 255 'AND OUTPUT THE DATA
1340 OUT 126,3 'TURN THE WRITE LINE ON
1350 OUT 126,1 'AND OFF TO WRITE.
1360 NEXT 'DO ALL 12 REGISTERS.
1370 OUT 126,0 'AND AWAY WE GO.
1380 END

```

**TABLE II
CLOCK DISPLAY ROUTINE**

```

10          'THIS PROGRAM DISPLAYS THE CLK ON THE SCREEN.
20 CLS 'START WITH A FRESH, CLEAN SCREEN.
30 DIM A(15) 'SET UP AN ARRAY TO READ THE CLK VALUES INTO.
40 OUT 127,130 'SET UP THE PPI FOR A,C IN AND B OUT.
50 OUT 126,1 'ASSERT HOLD TO PREVENT FALSE READINGS.
60 OUT 126,5 'ALSO ASSERT READ TO READ THE CLOCK
70 FOR I=0 TO 12 'ADDRESSING LOOP
80 OUT 124,I 'ADDRESS THE REGISTERS SEQUENTIALLY
90 A(I)=15 AND INP(125) 'INPUT ONE REGISTER AT A TIME AND
100 NEXT 'MASK OFF UNWANTED BITS.
110 OUT 126,0 'RESUME REGULAR CLOCK TIMING
120 H=10*(3 AND A(5)) + A(4) 'PUT THE HRS INTO THE PROPER FORMAT.
130 IF H(<=9 THEN PRINT @ 0,"0";H;":"; ELSE PRINT @ 0,H;":"; 'AND PRINT THEM OUT.
140 M=10*A(3) + A(2) 'PUT THE MINUTES INTO THE PROPER FORMAT
150 IF M(<=9 THEN PRINT "0";M; ELSE PRINT M; 'AND PRINT THEM OUT.
160 PRINT ":"; 'PRINT THE COLON
170 S=10*A(1) +A(0) 'PUT THE SECONDS INTO THE PROPER FORMAT
180 IF S(<=9 THEN PRINT "0";S; ELSE PRINT S; 'AND PRINT THEM OUT.
190 PRINT " ";10*A(10) + A(9); 'PRINT THE MONTH
200 PRINT"/";10*A(8) + A(7); 'AND THE DAY OF THE MONTH
210 PRINT"/";10*A(12) + A(11); 'AND THE YEAR.
220 GOTO 40 'LOOP FOR CONTINUOUS DISPLAY.

```

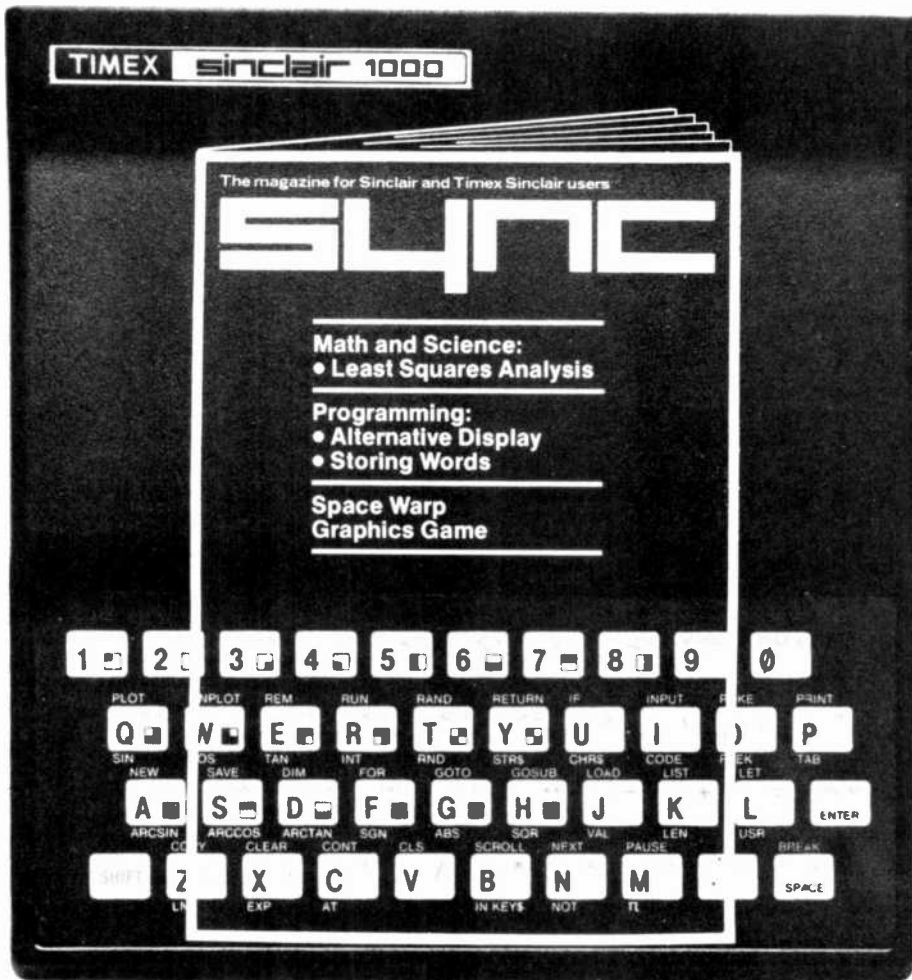

FOR SINCLAIR AND TIMEX SINCLAIR OWNERS ONLY

If you own a Timex Sinclair, a ZX81, or any other Sinclair computer, you've probably discovered that the big microcomputer magazines cover only the bigger computers. Where can you find helpful articles on the Sinclair? In *Sync*!

Sync is the one magazine that's written exclusively about Clive Sinclair's marvelous inventions, the Sinclair computers. And it's the one magazine to read if you want to get more from your Sinclair.

You'll find program listings for games, helpful programming techniques, hardware upgrades, math and science programs, news of new products for the Sinclair—in short, everything you need to use and enjoy your Sinclair to the fullest.

In just two recent issues, for example, we covered:

- Putting a Reverse Character in a String
- How to Double Your Memory
- Least Squares Data Analysis With the ZX80/81
- Space Warp: A Graphics Space Game
- How to Reduce "Blank Screen Time"

- Storing Three-Letter Words in an Array
- Software Review: ZX Galaxians
- An Introduction to Expression Evaluation
- Short Programs Just for Fun
- The ZX81 Parser and User-Defined Commands
- Understanding Floating Point Arithmetic
- Handling Strings from Another Dimension
- Book Review: Understanding Your ZX81 ROM
- How to Add a Keyboard to Your Sinclair
- Translating Other Basics: DEF on the ZX81
- Six Outer Space Games—With Program Listings
- Hardware Review: Sinclair ZX Spectrum High Resolution Color/Sound Computer

If you own a Sinclair microcomputer, *Sync* is the only computer magazine you really need. Subscribe now to *Sync*, and you can save up to 33%! Just complete and return the postage-paid reply card or the coupon at right.

**SAVE UP TO 33%
ON SYNC!**

SYNC

CN 1986 • Morristown, NJ 07960

YES! Please send me *Sync* for:

- One year (6 issues) for \$12.97—I save 19%.
- Two years (12 issues) for \$22.97—I save 28%.
- Three years (18 issues) for \$31.97—I save 33%.

Savings based on full 1-year subscription price of \$16.

Mr. _____
Mrs. _____
Ms. _____
(please print full name) 8H203

Address _____ Apt. _____

City _____

State _____ Zip _____

CHECK ONE:

- Payment enclosed. Bill me later.

Offer valid in U.S. and possessions only. Please allow 60 to 90 days for delivery of first issue.

NEW SUBSCRIBERS ONLY



The World's First 16-Bit CMOS Microprocessor Experimenting with a Piezoelectric Speaker

By Forrest M. Mims, III

WITH the arrival of portable notebook computers such as Radio Shack's Model 100, Convergent Technologies' Workslate, and Epson's HX-20, the era of truly *personal* computing has finally arrived. Now all we need is a portable machine that will run software developed for IBM's Personal Computer.

Thanks to the development of the first commercial 16-bit CMOS microprocessor, the 80C86, the availability of such a machine may not be far away. This month we'll take a detailed look at this important new microprocessor and its applications.

Next, we'll cover a favorite subject of mine, ultrasonics, and experiment with low-cost piezoelectric tweeters. Then we'll build an ultrasonic siren that may stop the annoyance of barking dogs.

The 80C86 CMOS Microprocessor

In my opinion, the major microprocessor news of 1983 was the development by Harris Corporation of a CMOS version of Intel's popular 8086 microprocessor. The 8086 is software compatible with the 8088, the chip IBM uses in its phenomenally successful Personal Computer. Indeed, the 8086 and 8088 share the same basic set of 108 instructions.

The new chip is the world's first com-

mercial 16-bit CMOS microprocessor. Designated the 80C86, it provides all the capabilities of the 8086 at considerably reduced operating power. Furthermore, unlike the NMOS 8086, which must be operated at a fixed clock frequency, the 80C86 can be operated over a clock frequency of dc to 5 MHz. Since the power consumption of a CMOS chip increases with the clock speed, the 80C86 can be operated at reduced clock rates to lower its power consumption.

Another important benefit of a variable clock speed is the ability to single-step the 80C86 through its programs for easier debugging. This capability is sure to make the new chip popular with programmers.

In operation, the 80C86 consumes only 500 μ A in its dc standby mode. In this condition, the clock is stopped, but the contents of all internal registers are saved. When the clock is activated, the 80C86 consumes a maximum of 10 milliamperes per megahertz. Therefore, at its highest clock frequency of 5 MHz,

the 80C86 consumes a maximum of 50 mA. This is substantially less than the 275 mA consumed by the NMOS 8086.

The 80C86 incorporates several unique design features, some of which were necessary due to important operating drawbacks of CMOS chips. For example, one of the most important CMOS problems is what to do with unconnected ("floating") inputs.

If you've assembled working CMOS circuits, you already know that a floating input acts like an antenna. It can pick up stray signals that can cause a CMOS gate to switch erratically and possibly consume excessive current. Consequently, a firm rule of CMOS circuit design is that all inputs *must* go somewhere.

This rule can be unintentionally but easily broken when applied to a CMOS microprocessor. In a working system a microprocessor often accesses external memory and other chips via a three-state bus. If one or more lines connected to any of the microprocessor's many ad-

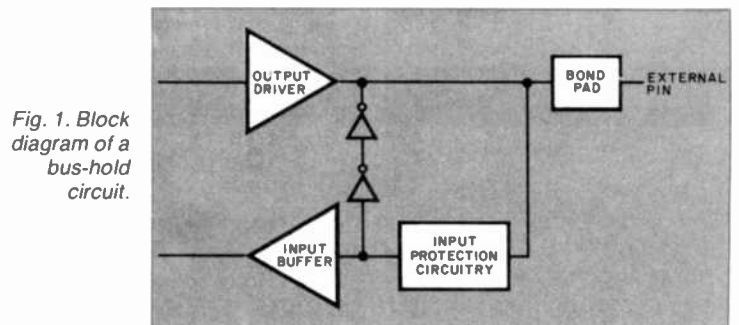

Fig. 1. Block diagram of a bus-hold circuit.

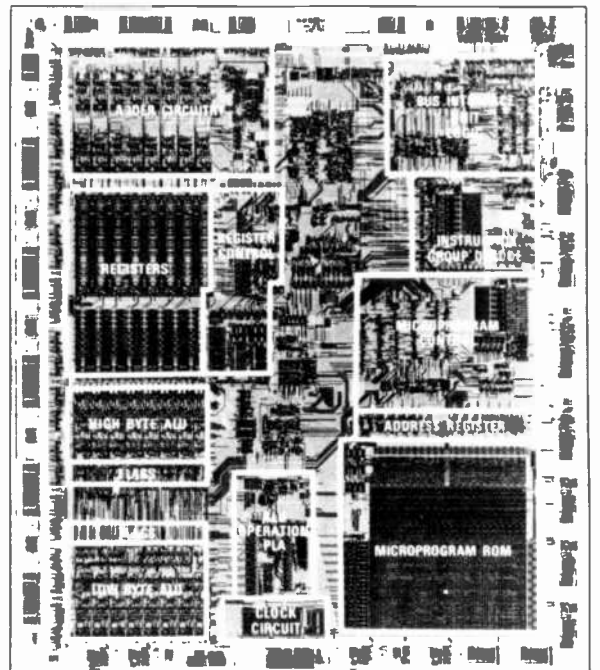

Fig. 2. Photo of an actual Harris 80C86 chip.

dress, data and control inputs assume the high-impedance state, then the affected inputs are essentially unconnected and in a floating state. The system may then behave erratically and serious errors or malfunctions may occur.

This problem can be alleviated by connecting all input pins to V_{cc} by means of pullup resistors. However, this imposes additional complexity and expense. It also requires additional space, a drawback for the portable, battery-powered systems for which CMOS microprocessors are ideally suited.

The 80C86 overcomes this problem entirely by means of "bus hold" circuits at each of its inputs. Should an input or bus line assume the high-impedance state, the bus-hold circuit maintains the input at its last defined logic state. When the input line is again active, the bus-hold circuit can be "overdriven" by an incoming logic signal.

Figure 1 is a simplified block diagram provided by Harris of a bus-hold circuit. However, the diagram doesn't adequately reveal the workings of the circuit. Apparently the two inverters form part of a bistable (two-state) feedback loop that keeps the input at the prior state so that it is not allowed to float.

Comparing the 8086/80C86 and the 8088. Since the 8088 is used in the IBM PC, it's important to understand why the 8086/80C86 can be used to make a so-called "IBM compatible" computer, that is, one that accepts software written for the PC.

Figure 2 is a photograph of an actual Harris 80C86 chip. The chip contains 38,000 transistors and measures only 0.243" x 0.284". From the photo, it's evident that a considerable percentage of the chip's surface is occupied by an extensive network of interconnecting bus and control lines.

The chief difference between the two microprocessors is that the 8086/80C86 has a 16-bit data bus, while the 8088 has only an 8-bit data bus. The 8088 overcomes this apparent disadvantage by accepting 16-bit data as two sequentially entered bytes.

Both the 8086/80C86 and the 8088 have a 20-bit address bus. This means each microprocessor can address up to a megabyte (1,048,576 bytes) of external RAM. The 16-bit program counter in each chip, however, allows direct access to only 65K (65,536) bytes of memory. The full address capability is made available by a method called *segmented addressing*.

The memory is organized into as many as sixteen 65K segments. Four 16-bit registers are used to store memory-segment addresses. All memory refer-

als are then made with reference to the addresses stored in the *segment registers*. The complete 20-bit address is obtained by shifting the address in the segment register four bits to the left and adding the result to the memory-referential address.

Segments can be located anywhere within a full megabyte of memory and can even overlap one another. However, all the information in a segment must be logically related (e.g. program code or data). Three of the four segment regis-

ters are designed for three specific categories of information: data (DS), stack contents (SS), and program code (CS). The fourth register (ES) is available for extra segments.

Figure 3 is a simplified block diagram of the 8086/80C86 that shows the location of the segment registers. You can find out much more about how the 8086/80C86 handles large memory addresses by studying the technical literature available from Intel and Harris.

Both the 8086/80C86 and 8088 are

PROGRAMMER'S GUIDE TO

CP/M

EDITED BY SOL LIBES

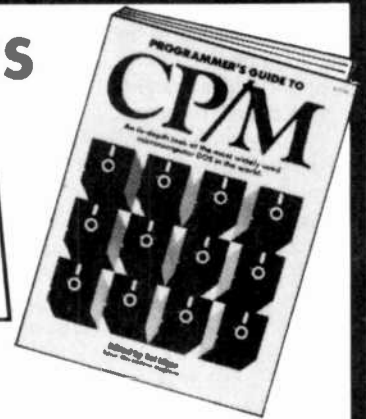

Here's an important collection of CP/M insights that you'll never find in any CP/M manual. CP/M is the most popular microcomputer DOS in use today, and this widespread use has generated many innovative techniques and enhancements of CP/M. *Programmer's Guide to CP/M* tells you what these enhancements are and how to put them to use, how to get around apparent limitations of a CP/M system and why CP/M is far more versatile than you might have imagined. Every article in *Programmer's Guide to CP/M* originally appeared in MICROSYSTEMS between

January 1980 and February 1982. Except for this collection, these articles are now unavailable! *Programmer's Guide to CP/M* gives you an in-depth look at CP/M from the viewpoint of the programmer—the individual who creates the software that interfaces directly with CP/M, or who is installing CP/M on systems for which configurations do not already exist.

Contents include "An Introduction to CP/M," "The CP/M Connection," "CP/M Software Reviews," "CP/M Utilities & Enhancement," "CP/M 86" and "CP/M Software Directories." 200 pages, \$12.95.

Microsystems

MICROSYSTEMS PRESS

Dept. NE7H, 39 East Hanover Avenue
Morris Plains, NJ 07950

Send me _____ copies of *Programmer's Guide to CP/M* at \$12.95 each, plus \$2 for postage and handling. #14C

Outside USA add \$3.00 per order.

PAYMENT ENCLOSED \$_____. CA, NJ and NY State residents add applicable sales tax.

CHARGE MY: American Express MasterCard Visa

Card No. _____ Exp. Date _____

Signature _____

Print Name _____

Address _____ Apt _____

City _____ State _____ Zip _____

For faster service, CALL TOLL FREE; 800-631-8112
(In NJ only, call 201-540-0445)

supplied in 40-pin dual-in-line packages. Since both microprocessors have more than 40 input, output, and power-supply connections, it's necessary for some of the address pins to double as data pins. The status of a special memory/input-output (M/IO) pin determines whether a pin functions as an address or data pin.

Eight status and control pins also serve dual functions. Their functions are collectively changed by means of a logic signal at a special pin designated *MN/MX*.

80C86 Support Chips. Intel makes a complete family of support chips for the 8086. The 8086 can also be used with support chips designed for the 8080 and 8085 microprocessors.

Along with its introduction of the 80C86, Harris announced the availability of CMOS support chips. These include the 80C54 Programmable Interval Timer, the 82C55A Parallel Peripheral Interface, the 82C59A Priority Interrupt Controller, and the 82C59A Octal Latching Bus Driver. Other CMOS support chips include the 82C84A System Clock and 82C88 Bus Controller.

Figure 4 is a typical 80C86 system diagram that shows how these various support chips are used. Each of the support chips performs a range of functions beyond its primary purpose. For example, the 82C84A System Clock provides a power-on/reset signal. It also synchronizes other 82C84As (if used) and coordinates local and system bus synchronization.

The Harris-Intel Connection. Since the 8086 is an Intel chip, you may be wondering how Harris can make and sell a CMOS version of the same chip! It's very common for semiconductor companies to license the rights to their chip designs to one or more competitors. While licensing agreements can provide additional income, they serve an even more important purpose by guaranteeing a second source for the licensed chip.

Rarely will a major manufacturer commit to manufacture an electronic product if the circuitry uses chips available from only one supplier. Should the supplier not be able to deliver chips, a product may be cancelled. This, of course, is the real reason Intel was happy to permit Harris to make the 80C86.

Harris Semiconductor, a division of Harris Corporation, has produced special-function CMOS chips for years. Many of their chips are used in sophisticated military electronic systems.

Though Intel is, by comparison, a rel-

ative newcomer in the CMOS business, the company has already introduced such CMOS chips as the 80C51, 80C49 and 80C48 single-chip microcontrollers. Intel plans to introduce its own version of the 80C86, along with a family of CMOS support chips, by mid-1984.

What It All Means. Simply put, the 80C86 means that portable, battery-powered 16-bit microcomputers are on the way. Though their 16-bit capability will enhance the microprogramming of such machines, the real advantage to the end user will be massive memory.

It's easy to foresee a portable, notebook-sized computer similar to Radio

Shack's Model 100 but with a full megabyte of internal RAM. With this kind of storage, many applications can be handled without the need for a floppy disk. If I can type this entire column into a 32K Model 100, imagine the capacity of a full megabyte!

Since the 80C86 is a U.S. chip, it's enticing to conclude that the new generation of 16-bit portable computers will be made in this country. IBM, for instance, now owns 14% of Intel's stock.

But IBM and other U.S. computer makers will have to keep a wary eye on Japan. According to a new report in *Electronics* magazine, both Oki Electric Industry and NEC Corporation, two

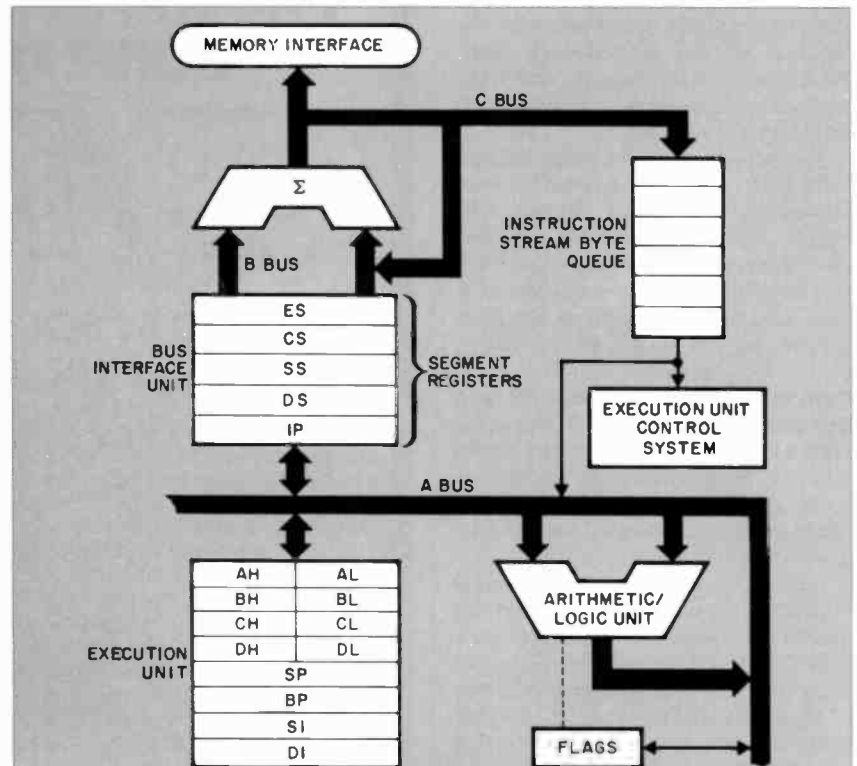

Fig. 3. Simplified block diagram of the 8086/80C86 showing segment registers.

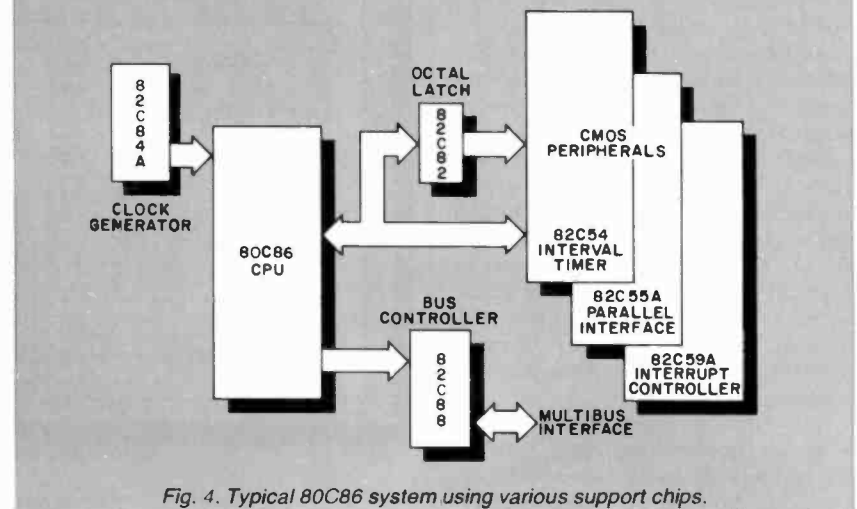

Fig. 4. Typical 80C86 system using various support chips.

major Japanese semiconductor companies, are working to develop CMOS versions of the 8086. The *Electronics* news item predicted that another Japanese company, Kyocera Limited, will be the first customer for the Oki CMOS 8086. The significance of this is that Kyocera Limited is the manufacturer of the 8-bit Model 100.

A Piezoelectric Speaker Siren

Piezoelectric speakers are commonly used as high-frequency tweeters in high-fidelity speaker systems. Since the moving surface of such speakers is comparatively small, sounds having a frequency approaching 40 kHz can be generated.

Figure 5, for example, is the frequency response curve for a typical piezoelectric tweeter, Radio Shack's Realistic® Super Horn (catalog number 40-1381). This tweeter has an impedance greater than 1 kilohm at 1 kHz and more than 20 ohms at 40 kHz. It has good transient response and faithfully reproduces single-frequency tones. It's also lightweight, sturdy, and vibration resistant.

Piezoelectric tweeters can be connected directly across conventional electromagnetic speaker terminals without a crossover network and with or without a level control. Figure 6 shows how to implement a straightforward level control to adjust the volume from the tweeter.

Applications for Piezoelectric Tweeters. Aside from their intended function as hi-fi tweeters, piezoelectric speakers have several additional applications. For instance, a piezoelectric tweeter can be used as a high-impedance microphone.

More significant, however, are appli-

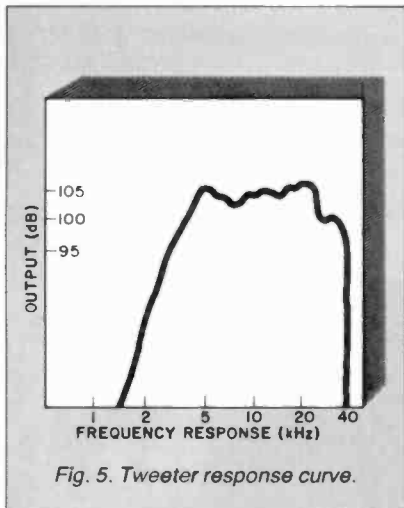

The professional breadboard.

(For professional, hobbyist or student.)

Global Specialties' PB-203A Proto-Board®

The solderless breadboard that set the industry standard for speed, versatility and convenience. With a capacity up to twenty-four 14-pin DIPs and three regulated power supplies (one fixed, two variable), PB-203A features a large array of sockets and bus strips that emulates standard PC layouts. Permitting instant insertion and removal of virtually any component from the largest DIP to the smallest discretes. Helping you design, assemble, test and modify circuits almost as fast as you can think! And built with professional durability, for all types of applications.

Our PB-203A. Only \$174* (kit \$149.95*) or PB-203 with single 5V supply, \$133.* One more reason so many people say "Proto-Board" for solderless breadboarding.



GLOBAL SPECIALTIES CORPORATION

70 Fulton Terr., New Haven, CT 06509 (203) 624-3103 TWX 710-465-1227
OTHER OFFICES: San Francisco (415) 648-0611, TWX 910-372-7992, Europe: Phone Salfron-Walden 0799-21682, TLX 817477
Canada: Len Finkler Ltd. Downsview, Ontario

Call toll-free for details **1-800-243-6077** During business hours

*Suggested U.S. resale. Prices, specifications subject to change without notice. © Copyright 1981 Global Specialties Corporation

Circle No. 46 on Free Information Card

FREE

McIntosh STEREO CATALOG and FM DIRECTORY

Get all the newest and latest information on the new McIntosh stereo equipment in the McIntosh catalog. In addition you will receive an FM station directory that covers all of North America.

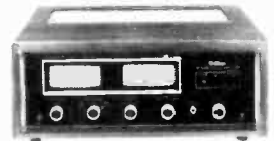
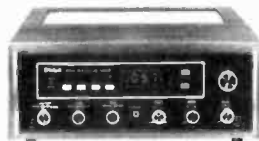
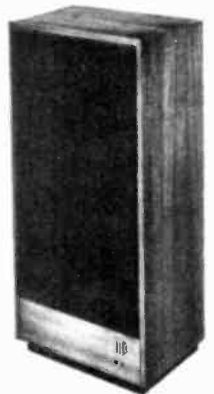

SEND TODAY!

McIntosh Laboratory Inc. CE
East Side Station P.O. Box 96
Binghamton, N.Y. 13904-0096

NAME _____
ADDRESS _____
CITY _____ STATE _____ ZIP _____

If you are in a hurry for your catalog please send the coupon to McIntosh. For non rush service send the Reader Service Card to the magazine.

CIRCLE NO. 31 ON FREE INFORMATION CARD

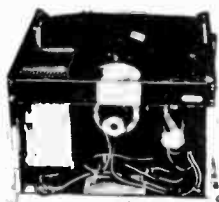

15" ATARI
GRAPHIC X,Y
DISPLAY UNIT

Ideal for Arcade
games, oscilloscope
test equipment.

\$24.95 (plus
\$5.00 shipping charge)



AUDIO
CASSETTE TAPE

90 minutes of recording.

Model D10633 \$.75 ea. (in lots of 10)



TRAVELING
ALARM CLOCK

Snooze alarm, light.
\$9.95



VHS T120 2-4-6 HOUR
VIDEO CASSETTE

Full color or black & white
recordings.

Model D10684 \$9.95

Add \$2.00 shipping & handling.

**ELECTRONICS
INTERNATIONAL**

has many other VCR audio
& electronic items.

Write for FREE catalog.

P.O. BOX 3919

SARASOTA, FLORIDA 33578

Circle No. 33 on Free Information Card

**PREVENT
HI-TECH
HEADACHES**

Our Isolators
eliminate
equipment
interaction.

clean up interference,
curb damaging power line spikes and
lightning bursts.



ISO-1 Isolator

3 isolated sockets; quality spike
suppression; basic protection. . . \$76.95

ISO-3 Super-Isolator

3 dual isolated sockets; suppressor;
commercial protection. 115.95

ISO-17 Magnum Isolator

4 quad isolated sockets; suppressor;
laboratory grade protection. . . 200.95

ESD Electronic Specialists, Inc.

171 S. Main St., Box 389, Natick, MA 01760

Toll Free Order Desk 1-800-225-4876
MasterCard, VISA, American Express

Circle No. 51 on Free Information Card

cations in which the speaker serves as a sound-emitting source for a warning device or ultrasonic generator. I've experimented with several circuits that implement these functions. They're easy to assemble, and you may wish to try the two described here.

A Multi-Output Alarm. Figure 7 is a simple but very effective multiple-output alarm circuit made from both halves of a 556 dual-timer chip. When connected to a piezoelectric tweeter, this circuit emits three different attention-getting alarm signals.

In operation, the left timer is connected as a multivibrator that switches on and off at a rate of about 0.5 Hz. Let's refer to this circuit as the *autoswitcher*. The right timer is connected as a multivibrator that oscillates at a frequency of a few kilohertz. We'll refer to this portion of the circuit as the *audio oscillator*.

Switch *S1* permits three operating modes to be selected. When *S1* is in position 1, the audio oscillator operates independently of the autoswitcher and the speaker emits a steady, piercing tone. With *S1* in position 2, the output from the autoswitcher is connected to the trigger input of the audio oscillator through *R3*. The speaker then emits a distinctive alternating tone that resembles a "twee-dell" siren. When *S1* is in position 3, the output from the autoswitcher is connected directly to the audio oscillator's trigger input and the speaker emits a series of penetrating tone bursts.

The circuit in Fig. 7 can be used to drive a small 8-ohm electromagnetic speaker, but a piezoelectric tweeter provides much better results. The sound is very penetrating and very loud. The volume can be increased by raising the supply to 15 V. The various sound outputs can be altered by simply changing the various RC components.

A Sonic/Ultrasonic Siren. A piezoelectric tweeter makes a very effective

sound source for a sonic/ultrasonic siren. I've designed and assembled an experimental version of such a siren to test its effectiveness as an alarm.

Figure 8 is a schematic of the siren. The SN76488 complex sound generator operates as a self-recycling, swept-frequency, up-down oscillator. The frequency range of the oscillator is determined by *R2* and *C2*. The sweep rate is determined by *R1* and *C1*.

With the values shown in Fig. 8, the oscillator can be adjusted via *R2* and *C2* to sweep from a lower range of a few hundred hertz to a few kilohertz and an upper range of about 15 kHz to 50 kHz.

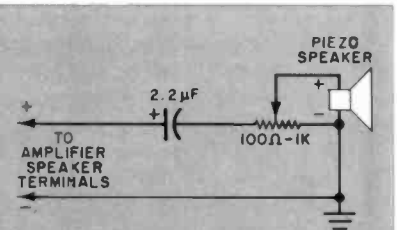

Fig. 6. Tweeter volume control.

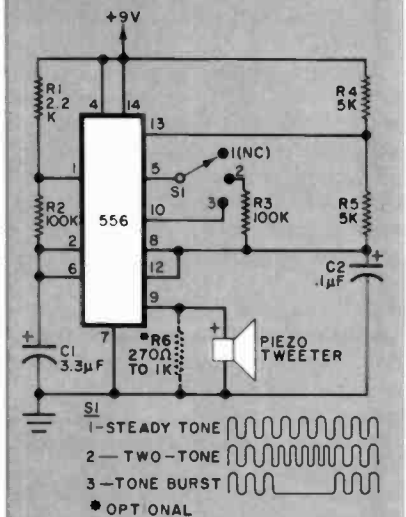

Fig. 7. Speaker driver circuit.

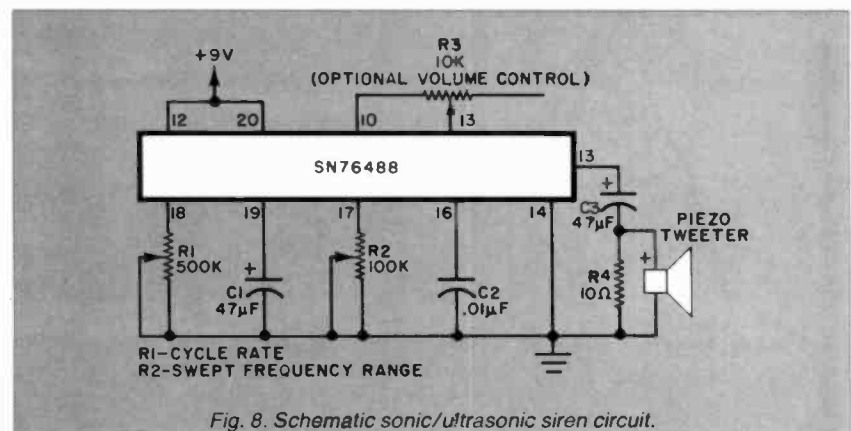

Fig. 8. Schematic sonic/ultrasonic siren circuit.

The cycle rate can be varied from a few tenths of a hertz to several hertz by altering R1's setting.

Testing the Siren. There's really no need to explain how to test the siren circuit when it's operated in the audible frequency mode. You simply adjust it for the sound you prefer. Caution: The sound can be very penetrating. You should cover the speaker while testing the siren indoors to protect your ears.

Operating the siren in its ultrasonic mode is trickier, since you cannot hear the output. I have used this operating mode in an experiment to silence barking dogs.

A young person with normal hearing can detect sounds having frequencies approaching 24 kHz. Animals such as dogs and, especially, bats can hear sounds having even higher frequencies. The upper limit for older people is usually much lower, perhaps 10 kHz or even considerably less. People whose hearing has been impaired by exposure to excessive sound or disease may have even lower frequency response levels. The siren in Fig. 8 can cover this entire range of frequencies and beyond.

While testing the siren circuit in my

office, a neighbor's pack of four dogs began a chorus of yelping when a fifth dog wandered too close to their territory. I connected a Realistic® Super Horn to the siren, adjusted R2 for ultrasonic operation, went outdoors and pointed the tweeter at the dogs. They immediately stopped barking! The worst offender repeatedly shook his head as he walked away.

While this brief experiment achieved the desired result, later the dogs completely ignored a second barrage of ultrasonic waves during another barking episode. I'm not sure why the second experiment was not successful. Perhaps the wind was blowing from the wrong direction. Or maybe the sound of their own barking blocked the effect of the ultrasonic waves.

In any event, I quickly stopped a third round of barking the next day with a few quick bursts of ultrasonic waves. Unfortunately, all subsequent attempts to discourage the dogs from barking have been unsuccessful. Indeed, the siren now causes the dogs to bark even more vigorously.

Though I've concluded my brief experiment aimed at curing barking dogs, I would be interested to hear from any

readers who obtain better results. Of course you should be careful that your experiments do not offend the owners of the barking dogs or that, as in my case, they don't stimulate rather than eliminate barking spells.

I'm also curious to know if an ultrasonic source, as some companies claim, drives away insects, mice, rats, and other pests. While I cannot respond to individual letters, I'll be happy to pass along any interesting results in a future column. Be sure to send all the details of any experiment that might interest other readers. And indicate whether or not you would like your address used.

Assembling a Permanent Siren. The circuit in Fig. 8 uses so few parts you can assemble it *inside* the empty space in the plastic enclosure of a Realistic® Super Tweeter (Cat. No. 40-1380) or similar enclosed piezoelectric tweeter. This tweeter's enclosure can be opened by removing the screws inside the three recessed holes on the back panel of the enclosure. When the screws have been removed, place the enclosure on its back panel and remove the front portion of the enclosure. This will keep the fragile piezoelectric element and its paper cone

• TRS-80 • Apple • Franklin • Epson • Okidata • Service, Selection, & Price! Nobody beats us on Computer Systems.

Franklin ACE 1000 Business or Personal System

Ready-to-Run System Includes:

- Franklin ACE 1000 64K Computer
- Franklin Color Board
- Franklin ACE 10 Disk Drive
- Franklin Controller Card
- Epson RX80, 100 CPS High Speed Printer
- Printer Stand
- BMC Green Phosphor Monitor for Word Processing
- Card and Cable Interface

BONUS! Software Package \$350 Value

Included with System Franklin ACE Writer Franklin ACE Calc Franklin 80 Column Board

List Price \$2532

Only \$1777

Apple IIe Super System for both business and (Baker's Dozen Special) personal

System Includes:

- Apple IIe 64K Computer
- Apple 1st Disk Drive
- Rana Elite 2nd Disk Drive
- Apple II Green Phosphor Monitor
- Apple Controller Card
- Apple 80 Column Card
- Apple Writer IIe Word Processor Software
- Grappler Plus Interface
- NEW! Hi-Speed Okidata Microline 92 Printer 160cps

NEW! Yes! 2 Disk Drives

List Price \$4042

Now Only \$2777

Above System w/Epson FX-80 Printer — \$2888

• Printer Dust Cover

• Case of 3200 sheets fan-fold paper

• Box of 10 Diskettes

• System Dust Cover

These are a sample of the computers & accessories we have in stock, ready to ship. Don't give up service and selection — call us. The only thing we discount is price.

ORDER TOLL FREE: 800-526-5313

COMPUTER DISCOUNT OF AMERICA, INC.

15 Marshall Hill Road, West Milford Mall West Milford, New Jersey 07480-219 In New Jersey Call 201-728-8080

Computer Discount of America

Circle No. 37 on Free Information Card

FREE SOCKETS!

Send **\$1.00** postage and handling for DIP Socket Deal!

One each of 8, 14, 16, 24 and 40 pin tin low profile DIP Sockets **plus** we will send you FREE our 56 page catalog with \$1.00 OFF Coupon on any purchase.

How can you lose?

SINTEC COMPANY We Carry Over 1500 Parts in Stock!!

28 8th Street Box 410 Frenchtown, NJ 08825 (201) 996-4093

Fill in below for Socket Deal

I want the Socket Deal Enclosed is my \$1.00 cash.

Name _____

Address _____

City _____ State _____ Zip _____

Circle No. 36 on Free Information Card

CALCULATOR SAVINGS



HP-10C Scientific	57.99	82160A HP-IL Module	194.99
HP-11C Programmable	74.99	82181A Cassette Drive	347.99
HP-12C Financial	99.99	82182A HP-IL Printer	347.99
HP-15C Programmable	99.99	82164A RS-232 Interf.	249.99
HP-16C Hexadecimal	99.99	92198A 80 col Video Int	269.99
HP-32C Scientific	29.99	7470A HP-IL Plotter	899.99
HP-34C Programmable	54.99	82180A Extnrd Functns	59.99
HP-37C Financial	29.99	82181A Extnrd Memory	59.99
HP-38C Financial	69.99	82182A Time Module	59.99
HP-41C Alpha Progrmb	149.99	82183A Extnrd I/O	59.99
HP-41CV Full Memory	207.99	HP-41 System Case	79.99
HP-41CX Extnrd Functn	259.99	Port-X-Tender to 10 pts	129.99
82104A Card Reader	149.99		
82143A Printer	289.99		
82153A Wand	99.99		
HP-75C Computer	739.99		
82700A 8K Mem for 75C	149.99		

Call for Low Prices on all Accessories and Software

Texas Instruments 99/4A	1149.99	PHP 1100 Joysticks	129.99
PHP 1200 Expansn Box	149.99	PHP 2700 Recorder	59.99
PHP 1220 RS-232 Card	84.99	PHM 3058 Mini Memory	84.99
PHP 1240 Disk Cntrlr	99.99	PHM 3026 Extnrd BASIC	84.99
PHP 1250 Disk Drive	149.99	PHM 3055 Edt/Assm	34.99
PHP 1260 32K Memory	99.99	PHM 3111 TI Writer	84.99
PHP 1270 P-Code	84.99	PHM 3113 Multiplan	84.99
PHP 1500 Speech Synth	84.99	PHM 3035 Term Em It	39.99
PHP 1600 Modem	84.99	CC-40 Compact Cmptr	199.99

Sharp PC-1250 Pocket Extended BASIC Computer	469.99
CE-125 Printer/Microcassette for PC-1250	149.99
PC-1500 Advanced Handheld Computer	139.99
PC-1500A Advanced 8K Handheld Computer	179.99
CE-150 Cassette Intfrc/4-color Printer Plotter	179.99
CE-151 4K Memory for 1500/A	39.99
CE-155 8K Memory Expansion Box for 1500/A	79.99
CE-158 RS-232C & Parallel Interface for 1500/A	179.99
CE-159 8K Memory Expan with Battery Back-up	99.99
CE-161 16K Memory Expan with Battery Back-up	149.99
PC-1500/A ROM Software Modules	49.99

Casio FX-700P Handheld Computer, 1568 steps	469.99
FA-3 Cassette Adapter for FX-700P	34.99
FP-12 20-column Printer for FX-700P	59.99
FX-96 Credit Card Solar Scientific Calculator	24.99
FX-450 Scientific Calculator with Hexadecimal	29.99
TE-2500 Spanish Translator Watch	69.99
TC-500 Touch Sensor Calculator Watch	59.99
CFX-20 Scientific Calculator Watch	34.99

Use cashier's check, postal money order, VISA, or M/C. Personal checks take five weeks to clear. Add shipping 1% of your order (P.S. minimum). East of Mississipp. extra 1% SD. Call rate add 6%. Subject to availability, USA prices.

ORDER **800-421-5188** Outside CA, AK, HI
TOLL-FREE information line (213) 633-3262



Tam's Inc, Dept CE-12
14932 Garfield Ave.
Paramount, CA 90723
(213) 633-3262

Circle No. 42 on Free Information Card

AMAZING DEVICES

LASERS
RUBY LASER RAY GUN — intense visible red beam, burns and welds the hardest metals. HAZARDOUS device. Kits available.
RUB3 PLANS includes part sources **\$15.00**
CARBON DIOXIDE BURNING AND CUTTING LASER — produces a continuous beam of energy. HAZARDOUS device — Kits available. LC5 PLANS includes part sources **\$15.00**
VISIBLE LASER LIGHT GUN — produces intense red beam for special effects and other various optical applications. Hand-held enclosure houses batteries.
LGU3 PLANS \$10.00 LGU3K KIT/PLANS (minus tube) **\$99.50**
IR PULSED LASER RIFLE — produces 15-30 watt pulses at 9000A at 200-2000 per second.
LRG3 PLANS \$10.00 LRG3K KIT/PLANS (minus diode) **\$119.50**
BEGINNER POCKET LASER — visible red simulated device produces an excellent monochromatic source of light.
LHC2 PLANS \$5.00 LHC2K KIT/PLANS **\$24.50**

PHASORS
HIGH ENERGY VARIABLE AND PROGRAMMABLE PAIN FIELD GENERATORS, REQUIRE NO CONTACT — Recently developed device produces directional fields of moderate to high SPL, capable of producing intense pain and discomfort. HAZARDOUS IF NOT USED WITH DISCRETION. SOLD FOR ANIMAL CONTROL — MAY BE USED IN CERTAIN INSTANCES TO DISCOURAGE UNWANTED ENCOUNTERS.
PPF1 PROG/VAR PLANS \$15.00 PPF1K KIT/PLANS **\$175.00**
PSP3 VAR HAND-HELD PLANS \$7.00 PSP3K KIT/PLANS **\$44.50**
PHASOR BURNING WAND — capable of burning flesh, generates 3500 volts of continuous DC power.
PSW3 PLANS \$8.00 PSW3K KIT/PLANS **\$59.50**
PARALYZING SHOCKING WAND — produces 100,000 watt pulses of stunning power.
PG1W PLANS \$10.00 PG1WK KIT/PLANS **\$79.50**
 Above electrical devices are hand-held and may be used for **PERSONAL DEFENSE**.

SECURITY
SNOOPER PHONE — allows user to call his premises and listen in without the phone ever ringing.
SNP2 PLANS \$7.00 SNP2K KIT/PLANS **\$49.50**
LONG RANGE WIRELESS MIKE — miniature device clearly transmits over 1 mile.
FBT9 PLANS \$7.00 FBT9K KIT/PLANS **\$34.50**
WIRELESS TELEPHONE TRANSMITTER — long range all automatic undetectable.
VWPM5 PLANS \$7.00 VWPM5K KIT/PLANS **\$34.50**
TALK AND TELL — clearly and automatically records both sides of a telephone conversation when phone is being used.
TAT2K KIT/PLANS \$14.50 TAT2D READY TO USE **\$24.50**

Our order phone is available 24 HOURS, 7 DAYS A WEEK. Write for FREE catalog of our many products

We accept Master Charge or Visa. Please allow 10% for shipping. On orders OVER \$50.00 WE PAY freight

SEND TO: SCIENTIFIC SYSTEMS
 DEPT 01, P.O. BOX 716 AMHERST, NH 03031
 OR CALL FOR ORDERING ONLY, 1-603-673-4730

from falling out of its receptacle and possibly being damaged.

There's ample room in the enclosure for the necessary components, controls, and a 9-V battery. Figure 9 shows one way the components can be installed.

Begin assembly by carefully removing the piezoelectric speaker element from its plastic mounting cylinder. In the side of the cylinder, drill a hole for mounting a 9-V battery holding clip. Then drill holes for R1 and S1 as shown in the view of the back panel in Fig. 10.

I assembled the siren circuit on a 1.5" x 2" piece of perforated board with pre-etched copper foil patterns suitable for a DIP IC (Radio Shack 276-153 or similar). Figure 11 shows the parts layout.

You can mount the completed board directly to the speaker connection solder tabs inside the enclosure (back side of the back panel). First, unsolder the piezoelectric element's leads (careful, they're fragile). Then plaster (melt) some solder blobs on the back side of the board. Melt some more solder on the solder tabs. Then hold the board against the tabs (component side facing the speaker cylinder) while remelting the solder on one tab. When the solder hardens, heat the second tab. The board will then be anchored securely in place.

Next, carefully solder the speaker leads to the circuit board. Then solder the leads from a 9-V battery clip to the board and one pole of S1. Finally, connect leads between the board and the second pole of S1 and the terminals of potentiometer R1.

You'll have to adjust the swept frequency range before replacing the back panel on the enclosure since R2 is attached to the circuit board. If you want to make quick frequency changes, you can mount R2 in the side of the enclosure. There isn't room to mount it on the back panel of the speaker I used.

Going Further. There are many ways to make sonic and ultrasonic sirens. Over the years many different transistorized and integrated circuit versions have been published, and you may want to experiment with some of them.

Of course, sound generator chips greatly simplify the design and construction of such circuits. In addition to the SN76488 I used for this circuit, you can use the SN76495, SN94281 and various other sound-synthesizing chips.

If you're troubled by barking dogs, you may want to consider adding a sound-activated trigger to the siren. Adjust the circuit to deliver a burst of ultrasonic waves each time it detects a bark. This approach may very well solve your problem.

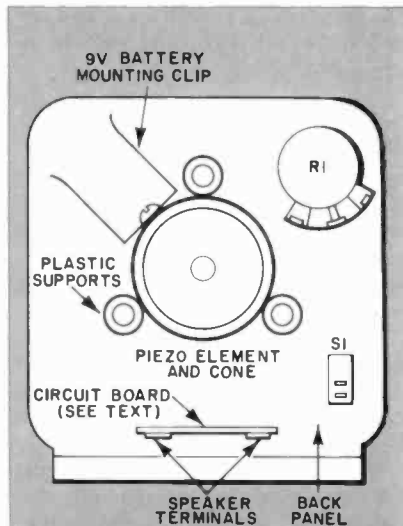

Fig. 9. Assembly of the siren.

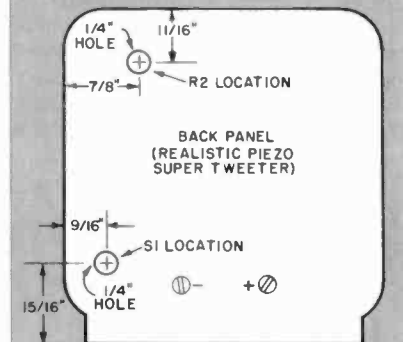

Fig. 10. Back panel of the tweeter.

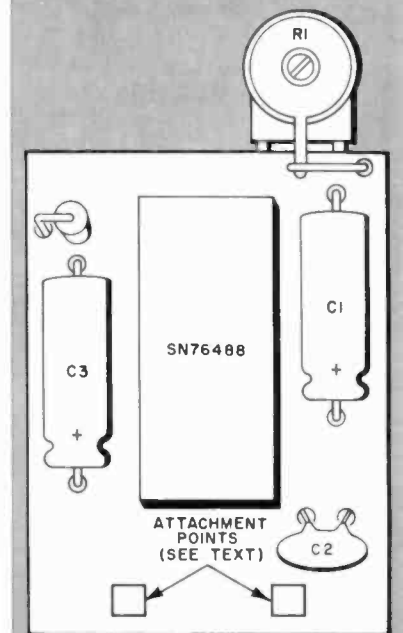

Fig. 11. Parts layout of the siren circuit board.

An Iso-Gate™ SCR Driver. In "The Electronics Scientist" in the June 1983 issue of C & E, I described a novel line of optoisolators introduced by Dionics, Inc. (65 Rushmore St., Westbury, NY 11590). These optoisolators, which are called Iso-Gates™, employ an integral infrared emitting diode and one or two integrated photovoltaic diode arrays to directly drive the gates of power MOSFETs.

Recently, Dionics announced a new Iso-Gate that *directly* drives sensitive-gate SCRs. When the infrared LED is driven by an incoming 50-mA current pulse, the infrared that is then emitted causes the miniature photovoltaic array to generate a 4-V output pulse having a current of about 50 μ A. This pulse is applied directly to the gate of the SCR being triggered.

Since the new Iso-Gate drives an SCR without the help of an external power source, Dionics believes it "... provides unprecedented immunity to the normal threats of false triggering and noise problems..." Furthermore, the company notes, "Since the Iso-Gate output acts as its own power supply, it is truly floating and completely removed from the main terminals. Therefore, the output is totally immune to any power supply spikes, surges, or noise-related interference."

Of course, few, if any, electronic components are totally fail-safe. Even an Iso-Gate can be falsely triggered should the LED receive an unintended pulse of current. Nevertheless, it seems safe to assume the Iso-Gate offers considerably more noise immunity than previous SCR triggering methods.

Iso-Gates may have some interesting applications beyond straightforward optoisolation. For example, the Iso-Gate is a true optoelectronic analog of the transformer. It converts a low-voltage, high-current input into a high-voltage, low-current output. In actual practice, the device is not very efficient; but the fact that it multiplies the input voltage by a factor of three suggests possible applications worth exploring.

I'll try to get some sample Iso-Gates for evaluation. In the meantime, if you want more information about the latest Iso-Gate, mention its label, the DIG-11-OH-200F, when you write to the company. The new Iso-Gate is available in a standard miniDIP, TO-5 metal can, or ceramic chip carrier. The devices sell for \$2.82 in quantities of 1000.

A High-Resolution LCD. I have previously discussed liquid-crystal displays like the one used on the Radio Shack Model 100 Portable Computer. This display is capable of showing eight rows

of 40 characters each.

While the Model 100 display is certainly impressive, it's only a hint of what's to come in portable, notebook-style computers. By the time you read this, Sharp Corporation will be manufacturing a liquid-crystal display with a remarkable capacity of 16 rows of 80 characters each! The display can also be used for graphics. Its 480-by-128-dot resolution exceeds that of some computers that use CRT readouts!

Sharp's new display has a viewing

area that measures 230 by 61 millimeters. This means it will fit nicely in a space not much larger than that occupied by the display in my Model 100. It's obvious, therefore, that the second generation of notebook portables will have as much display capacity as today's desktop machines.

Incidentally, Sharp doesn't plan to slow its development of high-resolution liquid-crystal displays. They are now developing a display capable of showing a full page of text! \diamond

We'll back you up!



ATTENTION COMMODORE 64 OWNERS

If you own a disk drive then you'll need "The Clone Machine". Take control of your 1541 with this package that includes:

- 1.) Complete and thorough users manual
- 2.) Copy with one or two drives
- 3.) Investigate and back-up many "PROTECTED" disks
- 4.) Copy all file types including relative types
- 5.) Edit and view track/block in Hex or ASCII
- 6.) Display full contents of directory and print
- 7.) Change program names, add, delete files with single keystroke
- 8.) Easy disk initialization
- 9.) Supports up to four drives

Price \$95

Special intro \$39.95

Dealers & Distributors
Inquiries Invited

CALL (201) 838-9027

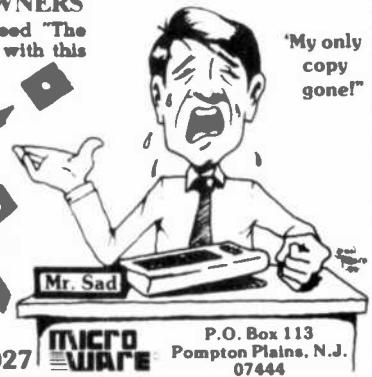

MICRO
WARE

P.O. Box 113
Pompton Plains, N.J.
07444

Circle No. 34 on Free Information Card

ANNOUNCING creative computing's 1984 BUYER'S GUIDE TO PERSONAL COMPUTERS & PERIPHERALS

Here's advice you can trust on selecting personal computers, peripherals and electronic games—in a comprehensive collection of product reviews and consumer-oriented shopping advice from *Creative Computing* magazine. You'll get a rundown of what's new on the market. Analysis of new product performance, reliability, operation, applications, cost—even what kind of repair service you can expect. Easy-to-understand comparisons between different models. And much more.

Send to: NA85
Creative Computing Buyer's Guide
CN 1914, Morristown, NJ 07960

YES! Please rush me Creative Computing's 1984 Buyer's Guide to Personal Computers & Peripherals. Enclosed is my check or money order for \$3.95 plus \$1 for postage and handling.

Mr./Mrs./Ms _____
(please print)

Address _____

City _____

State _____ Zip _____

Please make check payable to Creative Computing Buyer's Guide. CA, NJ and NY State residents please add applicable sales tax. Price outside USA is \$6

CABLE TV

CONVERTERS

Largest Selection
of Equipment Available
\$ Buy Warehouse Direct & Save \$



36 channel
converter
\$45.95

36 channel
wired remote
converter
only
\$88.95



Send \$2 for complete catalog
of converters and equipment

Quantity Discounts • Visa • Master Charge
Add 5% shipping—Mich. residents add 4% sales tax

C&D Electronics, Inc.
P.O. Box 21, Jenison, MI 49428
(616) 669-2440

Hire a fast thinker.

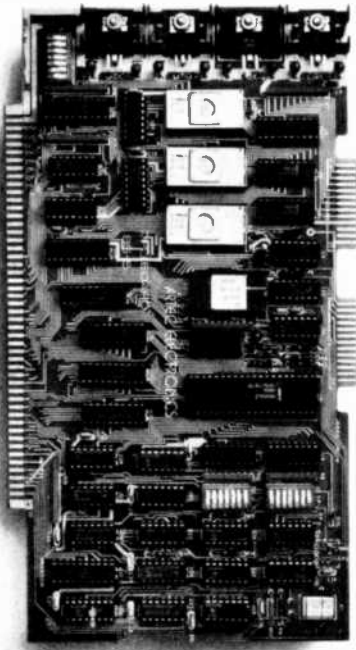

5 MHz CPU Card

■ Intel 8085A-2 microprocessor ■ Hardware floating point ■ Performs calculations six times faster than other CPUs ■ On-board monitor in PROM ■ 1K RAM scratch pad ■ Keyboard or RS232C terminal ■ Variable clock frequency

PRICE—\$450

(California residents add 6% sales tax)

Call or write Artec for details.

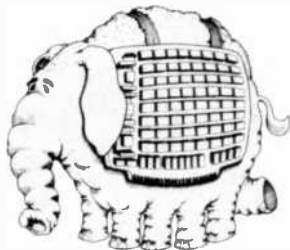

ARTEC ELECTRONICS, INC.

605 Old County Rd., San Carlos, CA 94070

Telephone (415) 592-2740

Circle No. 55 on Free Information Card

1983 EDITORIAL INDEX

COMPUTER HARDWARE		Mo./Pg.
Add EEPROM to your Computer (Keryan)	Oct	88
Axlon's Ramdisk, Review of (Marx)	June	33
Baud-Rate Matching for CoCo (Harding)	Oct	85
Breaking the 40-Column Barrier (Solomon)	Nov	35
Briefcase Computers, Combine Power & Versatility (Veit)	Feb.	58
British Are Coming! The (Veit)	March	39
By Its Joystick Ye Shall Know It (Spectravideo's SB-318 Computer)	Dec	73
Cassette Controller for TRS-80 Computers (Ting)	Nov	42
Clock for TRS-80, A Fail-Safe, Real-Time (Mein)	Dec	82
Commodore 64 Microcomputer . . . Its Wonders and Potential (Veit)	April	51
Computerized Dialing System for the TRS-80 Model II, A (Barbarelo)	Sept	64
Customize your Apple with an EPROM Plug (Mitchell)	Nov	58
DAC for TRS-80 Interfacing, A (Mangieri)	April	76
Data Converter for the Apple II, Part 1, High-Grade (Nicklin)	July	54
Data Converter for the Apple II, Part 2, High-Grade (Nicklin)	Aug	63
Davong 5-Mb Winchester Hard Disk System (Walton)	Oct	90
Desktop Appliance Computers (Veit)	July	62
Desktop Computers, A Trio of (Veit)	Jan	86
Heath/Zenith 8/16-Bit Desktop Computer, The New (Burawa)	Oct	44
Hewlett-Packard's New "Touch-Screen" Computer (Mitchell)	Dec	56
In This Corner . . . (Desposito)	June	48
Interfacing with Parallel and Serial Ports, Matchmaker! Matchmaker! (Marx)	Nov	74
Kaypro II, Off and Running with the (Solomon)	June	57
Microcomputer Joystick Interfacing Methods (Carlstrom and Tenny)	March	52
Microcomputer Technology, Learning 16-Bit (Meyerle)		
Part 1: The first in a series on learning about an 8088-based computer	March	81
Part 2: Hardware for the 16-bit 8088-CPU computer	April	91
Part 3: Details of the programmable DMA controller	May	78
Part 4: Details of the PIT and PPI circuit elements	June	74
Part 5: The Dynamic RAM and Asynchronous Communications Port	July	92
Part 6: How to use machine language programming	Aug	93
Part 7: How to use the monitor to create software	Sept.	72
Modularized Computer—Sony's New SMC-70, The (Veit)	Sept.	59
Multiple-Character Generation (Carlstrom)	Oct.	66
One-Upmanship from Radio Shack (Veit)	May	51
"Peek" into a ROM Cartridge, How to (Hardy/McGoff)	Oct.	52
Protecting Your Computer From Power Line Disturbances (Stifter)	Oct.	34
Pseudo-Cursor for Oscilloscopes, A (Patrick)	March	92
Spreadsheet-Based Portable Computer For Business, A (Desposito)	Nov.	48
Talk Can Be Cheap (Dighera)	Feb	39
Tenseness Level?, "Biobox" What's Your (Barbarelo)	Feb.	76
Timex/Sinclair Tape Loading, Improving (Stoner)	Sept.	80
Timex/Sinclair Video, Upgrading (Pence)	May	82
Timex/Sinclair's New Color Computer, First Look at (Bleichman)	Nov	68
Touch Tablet, Fast and Easy Graphics with a Low-Cost (Desposito)	Sept	51
VIC-20 Cassette Adapter, A (Sheehan)	Sept	84
Voice-Recognition Boards for Apple/Franklin and Texas Instruments Professional Computers	Dec	40
COMPUTER SOFTWARE		Mo./Pg.
"Artificial" Expansion of Timex-1000 Memory (Largent)	Dec	68
Computer-Aided Logic Design (Rubenstein)	May	67
Ears for Your Computer (Teja)	Dec.	34
Soul of CP/M, The (Waite and Lafore)		
Part 1	May	35
Part 2	June	65
Part 3	July	73
Part 4	Aug.	80
Synonyms for Word Processing (Mau)	Oct.	76
War of the Words (Veit)	Jan.	62
CONSTRUCTION		Mo./Pg.
Active Voltage Reference, An (Andrews)	April	50
Automobile Idiot Lights (Hilbert)	March	98
Broadband-Notch Filter, A (Shields)	Feb.	68
Cassette Controller for TRS-80 Computers (Ting)	Nov.	42
Clock for TRS-80, A Fail-Safe, Real-Time (Mein)	Dec.	82
Computerized Dialing System for the TRS 80 Model II, A (Barbarelo)	Sept.	64
Customize your Apple with an EPROM Plug (Mitchell)	Nov.	58
DAC for TRS-80 Interfacing, A (Mangieri)	April	76
Data Converter for the Apple II, Part 1, High Grade (Nicklin)	July	54
Data Converter for the Apple II, Part 2, High Grade (Nicklin)	Aug.	63
DC-Motor Speed Controller, A (Coppola)	Oct.	56
Graphic Equalizer, Part 2, The Optimized (Gorn)	Jan.	56
Guard Precious Components From Overload Damage (Wright)	June	39
Intelligent Thermometer, Part 1, Build the (Fox)	Jan.	74
Intelligent Thermometer, Part 2, Build the (Fox)	Feb.	95
Light Chaser, A Microprocessor Controller for Light Shows (Viesca)	Oct.	70
Magnify your Calculator's Display (Souder)	Feb.	52
Microcomputer Joystick Interfacing Methods (Carlstrom and Tenny)	March	52
Microcomputer Technology, Learning 16-Bit (Meyerle)		
Part 1: The first in a series on learning about an 8088-based computer	March	81
Part 2: Hardware for the 16-bit 8088-CPU computer	April	91
Part 3: Details of the programmable DMA controller	May	78
Part 4: Details of the PIT and PPI circuit elements	June	74
Part 5: The Dynamic RAM and Asynchronous Communications Port	July	82
Part 6: How to use machine language programming	Aug.	93
Part 7: How to use the monitor to create software	Sept.	72
Multiple-Character Generation (Carlstrom)	Oct.	66
"Peek" into a ROM Cartridge, How to (Hardy/McGoff)	Oct.	52
Power-Failure Sensor, Beep! Beep! (Antonakos)	Sept.	79
Program Any Waveshape You Can Imagine (Lasher)	July	67
Programmable Function Generator, A (McClellan)	Feb.	85
Pulse Duration Counter (Hartkopf)	May	56
Switchable Test Socket, The Ingenious (Moskowitz)	June	56
Talk Can Be Cheap (Dighera)	Feb.	39
Telephone Peripheral, Super Hold A (Black)	May	59
Tenseness Level?, "Biobox" What's your (Barbarelo)	Feb.	76
Test-Point Monitor, A Multiple (Gooder)	Sept.	76
Timex/Sinclair Tape Loading, Improving (Stoner)	Sept.	80
Timex/Sinclair Video, Upgrading (Pence)	May	82
Triple-Threat IC, Use A (Shakir)	March	95
Two-Way Remote Security Communicator, A (Bergan)	April	66
VIC-20 Cassette Adapter, A (Sheehan)	Sept.	84
Water-Leak Detector, A (Lee)	June	61
EQUIPMENT REVIEWS		Mo./Pg.
ADS "Atelier" T2 AM/FM Tuner	Nov.	84
Apple III Desktop Computer	Jan.	86
Apple II Microbuffer II Printer Interface	Aug.	78
Axlon Ramdisk 320	June	33
BBC Computer	March	39
Beaman Porter Power Text Word-Processing System	Jan.	62
Commodore 64 Microcomputer	April	51

PROFESSIONAL SOFTWARE FOR MICRO'S



- * Insurance Agency Management
- * Medical Office Management
- * Dental Office Management
- * Property Management
- * Legal Time Accounting
- * Professional Time Accounting



On-Line Order Entry
 Super Ledger Accounting
 General Ledger Accounting
 Accounts Receivable
 Accounts Payable



Data Base Management

Runs On CP/M, CP/M-86 & MS-DOS

UNIVAIR SYSTEMS

UNIVAIR INTERNATIONAL
 9024 ST. CHARLES ROCK ROAD
 ST. LOUIS, MISSOURI U.S.A. 63114

(314) 426-1099

MS-DOS is a registered trademark of Microsoft
 CP/M and CP/M-86 are registered trademarks of Digital Research

Dealers Welcome

Circle No. 79 on Free Information Card



Active Electronics

NUMBER ONE IN QUALITY SERVICE AVAILABILITY

THE WORLD'S MOST COMPLETE PROFESSIONAL AND HOME ELECTRONICS ENTHUSIAST INVENTORY

- * Semiconductors + Memories
- * Microprocessors + Support Circuits
- * Microcomputer Systems + Peripherals
- * Passive Electronic Components
- * Hand Tools, Wire Wrapping, Soldering Equipment + Hardware

NOW AVAILABLE — FREE 1983 80-page catalog

A complete listing of products and specifications

Call, write or circle the inquiry card for your free copy today.

P.O. Box 8000, Westboro, Mass. 01581
CALL TOLL FREE: 1-800-343-0874

Mass customers call (617) 366-0500

Circle No. 50 on Free Information Card

Cromemco C-10 Super Pak Computer	July	62
Davong 5-Mb Winchester Hard Disk System	Oct.	90
Elco Model 482 Dual-Trace Oscilloscope	April	98
Epson HX-20 Portable Computer	Feb.	58
E/Z Associates LogicSim Logic Simulator	May	67
Heath/Zenith H/Z-120 Desktop Computer	Oct.	44
Hewlett-Packard HP-75C Portable Computer	Feb.	58
Hewlett-Packard Model 150 "Touch-Screen" Computer	Dec.	56
Information Unlimited Easywriter II Word-Processing System	Jan.	62
JVC Model HR-C3U Portable VHS Video Cassette Recorder	Jan.	97
JVC Teistar 19" Monitor/Receiver	Oct.	95
Kaypro II Portable Computer	June	57
Kloss Novabeam Model Two Projection TV	July	31
Koalapad Touch Tablet	Sept.	51
Kyocera R-651 Stereo Receiver with MOSFET Power Output	June	24
Lifetree Volkswriter Word-Processing System	Jan.	62
Luxman Model RX-103 AM/FM Stereo Receiver	Feb.	22
Magnavox Model FD1000SL Compact Disc Player	Aug.	50
Marantz SR620CX AM/FM Stereo Receiver	March	22
Mark of the Unicorn Final Word Word-Processing System	Jan.	62
MicroPro WordStar Word-Processing System	Jan.	62
Morrow Micro Decision Computer	July	62
NEC 25" Component Color TV	June	79
Northstar Advantage Desktop Computer	Jan.	86
Radio Shack Hero-1 Robot	Jan.	83
Radio Shack MC-10 Micro Color Computer	Aug.	60
Radio Shack TRS-80 Model 100 Briefcase Computer	May	51
Radio Shack TRS-80 Model 4 Computer	Aug.	53
Random House Electronic Thesaurus	Oct.	76
RCA Model 2023S 25" Color TV Receiver	Feb.	104
RCA Model VJP900 Convertible VCR	Nov.	80
Sansui Model Z-5000 FM/AM Stereo 70-W/Channel Receiver	May	20

Scott Model 458A Integrated Stereo Amplifier	Jan.	100
Sears, Roebuck and Co. Component Color TV	May	23
Select Information Systems Select Word-Processing System	Jan.	62
Simpson Model 454 Dual-Trace Oscilloscope	Nov.	87
Soar Model ME-531 3 1/2-Digit Multimeter	June	83
Sony Model XL-MC1 Moving Coil Cartridge	April	24
Sony SMC-70 Microcomputer	Sept.	59
Spectravideo Model SB-318 Personal Computer	Dec.	73
Spectrum Software Electronics Logic Designer/Logic Simulator	May	67
Texas Instruments Speech Command Systems	Dec.	42
Timex/Sinclair T/S 2068 Color Computer	Nov.	68
Torch Microcomputer	March	39
Victor 9000 Desktop Computer	Jan.	86
Voice Machine Communications Voice Input Module	Dec.	42
Workslate Spreadsheet-Based Portable Computer	Nov.	48
Zenith System 3 Model SY1963W 19" Color TV Receiver	March	16

FEATURES	Mo./Pg.
Breaking the 40-Column Barrier (Solomon)	Nov. 35
Compact Disc Digital Audio Systems (Ranada)	Aug. 40
Computer Books	Dec. 76
Computer Network Maze, Part 1, The Veit	March 60
Computer Network Maze, Part 2, The Veit	April 84
Computing Comfort and Efficiency, Maximize Your (Solomon and Burawa)	April 34
Crossed Signals Quiz (Roberts)	March 59
Data Storage in A Nutshell (Solomon and Veit)	July 36
Ears for Your Computer (Teja)	Dec. 34
Graphic Equalizer, Part 2, The Optimized (Gorin)	Jan. 56
Hero I, Robotmate of the Month (Staff)	Jan. 46
HEX/ASCII Decimal Conversion Chart (Solomon)	Oct. 68

How RAM Memory Drives Work (Anderton)	June 33
Interfacing with Parallel and Serial Ports, Matchmaker Matchmaker! (Marx)	Nov. 74
Keyboard Encoding Schemes (Tenny)	Oct. 79
New Breed of Computer Products, A (Desposito)	Sept. 32
Number Systems for Microcomputers (Carlstrom)	Dec. 47
Personal Robots, The New Wave of (Staff)	Jan. 37
Peter Nero at the Computer Keyboard	Nov. 62
Printers for Small Computers (Burawa)	Aug. 71
Protecting Your Computer From Power Line Disturbances (Stuffer)	Oct. 34
Robotic Arms (Solomon)	Feb. 74
Smart Modern, Do You Need A (Desposito)	Jan. 48
Super Chip for Next-Generation Personal Computers, A (Zingale)	Aug. 30
Teletext Experiments By Networks (Solomon)	Aug. 95
Unix The Easy Way (Fiedler)	Sept. 43
Video Connection, The (Trowbridge)	March 69

DEPARTMENTS AND COLUMNS	Mo./Pg.
Computer Hardware (Solomon)	
Preparing a Standard for Minifloppies	Jan. 12
Mixing and Matching Inputs/Outputs	Feb. 25
Adding a Video Monitor to Sinclair ZX81	March 31
It's a Long Haul Since Altair	April 14
Talking About Standards	May 16
Computer/Video Game Interference	June 12
Hardware Tricks to Improve Usage	July 20
The "Truly Portable" Sinclair/Timex	Aug. 22
Invisible Short Circuits in Digital Equipment	Sept. 26
By Hook, Crook, or Flip-Flop	Oct. 22
Smaller is Better?	Nov. 24
An Eve- and Temper-Saving Proposal	Dec. 22
Computer Software (Veit)	
Lotus 1-2-3 Word-Processing System	Jan. 20
Micro Mainframes Must Have Humongous Memories	Feb. 32
Software for Mass Markets and Integrated Packages	March 35

(continued overleaf)

The Latest CP/M Software and Hardware, Including CP/M-Plus	April	17
The Battle of the Disk Operating Systems	May	19
Where the UCSD P-System Fits in the DOS War	June	14
What Makes a DBMS Tick and What Kind Do you Need?	July	22
DX Listening (Hauser)		
News of Stations and Programs Around the World	March	109
News of Stations and Programs Around the World	April	107
News and Notes on Shortwave Stations and Programs	May	94
Editorial (Salsberg)		
Royalty Is More Than Royal	Jan.	9
Beyond Pac-Man	Feb.	6
The Calculator Connection	March	6
Robot Shacks	April	4
Sexism and the Computer	May	6
Mims the Word	June	4
Shades of de Gaulle	July	6
Friendly Computers	Aug.	4
Compuphobia	Sept.	6
AT&T and the Seven Dwarfs	Oct.	4
Future Speed Shock	Nov.	4
The Year That Was	Dec.	6
The Electronics Scientist (Mims)		
Ultrasonic Sound/Polaroid Rangefinder/LM3905 AP Note/Lower Supply Voltages/Device Developments	June	84
Thermoelectric Modules/MF-10 Universal Active Filter	July	86
Flat Panel Displays/A Tunable 60-Hz Hum Filter	Aug.	96
Homemade Electroscopes and Experimenting with a Geiger Counter	Sept.	90
Visible-Light Laser Diodes/More About Ultrasonics/A New Non-Volatile RAM	Oct.	99
Optical Data Communications/An Experimental Joystick Interface/A New Class of Semiconductors	Nov.	90
The World's First 16-Bit CMOS Microprocessor/Experimenting With a Piezoelectric Speaker	Dec.	86
English Broadcasts Audible in No. America (Hauser)		
	Jan.	108
	July	95
	Aug.	101
Entertainment Electronics (Feldman)		
Better TV Pictures with Comb Filters	Feb.	18
Two New Products Go A Step Beyond PCM	April	20
Better Sound for VCRs with Beta Hi-Fi	June	20
Are Those Digital Discs All They're Cracked Up to Be	July	28
Digital TV—How Soon?	Sept.	85
A New Approach to Tape Azimuth Alignment	Oct.	30
Stereo TV—Is There a Better Way?	Nov.	25
Experimenter's Corner (Mims)		
Experimenting with Kodak's Disc Camera Part 3. Radio Control & Aerial Photography	Jan.	28
Experimenting with a Low-Cost Fiber-Optic Link	Feb.	113
Experimenting with VMOS Power Transistors	March	111
Solderless Breadboards for Experimenters	April	104
Experimenting with Electronic Flash Circuits	May	90
Programmer's Notebook (Keogh)		
Designing Subroutines for A Board Game	Feb.	72
How to Use Subroutines	March	100
Project of the Month (Mims)		
A Multifunction VMOS Oscillator	Jan.	113
A Photonic Door and Window Intrusion Alarm	Feb.	118
A Digitally Programmable VMOS Variable Resistor	March	114
Adjustable Threshold Temperature and Light Alarms	April	109
Constructing a Two-Way Optoisolator	May	96
Solid-State Developments (Mims)		
Keeping up with the New Microprocessors	Jan.	82
Flash Analog/Digital Converters Come of Age	Feb.	110
New Peripheral Transforms Apple II into A Computerized Oscilloscope	March	103
Personal Radiation Detectors	April	100
Introducing the Varistor	May	88

OPERATION ASSIST

If you need information on outdated or rare equipment—a schematic, parts list, etc.—another reader might be able to assist. Simply send a postcard to Operation Assist. COMPUTERS & ELECTRONICS, 1 Park Ave., New York, NY 10016. For those who can help readers, please respond directly to them. They'll appreciate it. (Only those items regarding equipment not available from normal sources are published.)

Supreme, Inc. Model 655 oscilloscope. Need .5 mfd-1500 VDC capacitor and schematic. George Karastas, 3701 Mt. Aladin Ave., San Diego, CA 92111.

Atari CS-2600. Need schematic and specific information on the I/O port. Paul Yoes, 245 Koy Rd., Bellville, TX 77418.

Crosley Radio Corp. U.S. Army radio receiver and transmitter #3C-654A, Serial #46716. Need repair manual, operations manual and schematic. Michael J. Cedeck, 2903 Gene Lane, Arlington, TX 76010.

Hallcrafters Model PC-210F radio. Need schematics. Narciso R. Villafane, Lemay 108 Ramey Base, Aguadilla, PR 00604.

Weston Model 983 oscilloscope. Need schematic and operation manual. Bill Allen, 35 Eagle St., Terryville, CT 06786.

Zenith Model G454IW Chromcolor II TV. Need schematic or service manual. C. G. Malseed, 331 Penny St., McKeesport, PA 15132.

General Electric Model #GEL-740 radio. Need schematic, instructions, alignment information and service manual. Richard R. Egggers, 191 N. Park Victoria Dr., Milpitas, CA 95035.

Craig Model 6408 videotape receiver. Need manual, parts list and schematic. T. Langley, 52 Sarles Lane, Pleasantville, NY 10570.

Hammarlund Model HQ100 receiver. Need manual, parts list and schematic. T. Langley, 52 Sarles Lane, Pleasantville, NY 10570.

Hickock Model OSK-4 teaching systems oscilloscope Model OSK-4. Need manual and schematic. Mark Abrams, 79 Nichol Ave., New Brunswick, NJ 08901.

Mercury Model 880 picture tube tester. Need instruction book. James E. Stewart, 1607R NE 15th Ave., Fort Lauderdale, FL 33305.

Precision Model ES-500A oscillograph. Need schematic and parts list and/or service manual. Jon M. Sobel, Box 7282, St. Petersburg, FL 33714.

Dumont Model TO-100 television camera. Need schematic and/or service manual. Gary Montgomery, 1011 Westwood Drive, Elkview, WV 25071.

Electrodata Co. Model AG-1 audio generator. Need schematic. R.H. Klapheke, 4113 Sunflower Dr., Louisville, KY 40216.

Conair Model 224 tube tester. Need CRT testing chart and adapter description(s). Jim Vassil, Box 4691, Redding, CA 96099.

Elco Model 625 tube tester. Need schematic and operating manual. John O. Tjebban, 5008 Will-O-Dean Rd., Raleigh, NC 27604.

Hallcrafters Model SX96 receiver. Need schematic, alignment data and operating manual. George Zintak, 8617 S. Karlov, Chicago, IL 60652.

Lafayette HA-800 Receiver. Need schematic and alignment manual. Robert W. Halcro, U.S. Army Element Alifsee, Box 2195, APO NY, NY 09224.

Tequipment oscilloscope Model D61A. Need service manual or schematic. M. Repouic, Box 403, Boston, MA 64080.

General Electric Model M-81 receiver. Need schematic. George Henley, 502 N. Armstrong, Pleasant Hill, MO 64080.

Texas Instruments Model PHP 1700. Need accessories interface. Rovert Fein, 48 Pratt St., Allston, MA 02134.

Educational microcomputer systems Model M68K. Need schematics and documentation. Motorola Macsbug monitor. Need assembly language source listing. Joseph R. Stewart, 586 Plain St., Stoughton, MA 02072.

RCA Model TMV-97-B, r.f. oscillator. Need schematic and other available information. Russ Sandman, 560 Forest Hills Blvd., Waverly, OH 45690.

Digicom Data Products Modem Model AC-312. Need manual and schematics. Harold Wright, 7144 Center St., Highland, CA 92346.

EMC Model 502. Need schematic and NTS construction manual and parts list. M.M. Zamir, Box 1253, NY, NY 10451.

Philco Model 37-640 multiband radio and Lear model G511 phono and wire-recorder with model WC311A radio. Need schematics, service manuals and source of replacement parts. Mike Miller, Box 105, Bethel CT 06801.

Tennelec memory scan Model MS-1 monitor. Need schematic. Ernest Clark, R.D. 3, Box 426, Homer City, PA 15748.

Hallcrafters SX-4Z. Need schematic, parts list and operating manual. William F. Chapman, Lakeside Village, Wales, MA 01081.

Scott Model 99-C amplifier and **Sinclair Model X-20** Class-D hi-fi amplifier. Need schematics. Patrick E. Chung, 11 Faulkner Avenue, Duhaney Park, P.A. Washington Blvd. Jamaica, West Indies.

YORX Model M2601 stereo. Need technical manual, schematic, or owner's manual. Roman Budek, 65 Dover Dr., Des Plaines, IL 60018.

Advent VB225 projection T.V. Need schematics and parts list. Waldo Senechal, 2727 Pacific 141, Highland, CA 92346.

Video Systems Corp. Model 2000 video terminal. Need schematic, operating manual and service data. Don Morar, 3663 Hipsley Mill Road, Woodbine, MD 21797.

Mercury Model 204 tube tester. Need meter, charts and schematic. Philco 10L43 T.V. Need schematic and picture tube 17DRP4. Tom Schenk, c/o Ed Knapstein, 105 Bradford LN, Madison, WI 53714.

Realistic Model 150-A receiver. Need service manual and schematic. Jesus Pulgar, Box 11243, Santurce, PR 00910.

Precision Apparatus ES 500A oscilloscope. Power transformer needed. Vincent Werdein, 2517 Wehrle Dr., Williamsville, NY 14221.

Automatic Radio Phone Secretary Model TPS-3173. Need instruction manual and schematic. Gary Cook, Box 5, Centerville, MO 63633.

RCA Model 96K2 radio. Need schematic and parts list B. Murray, Route 1, Box 658, Capshaw Road, Harvest, AL 35749.

Analab dual trace scope Type 1120. Need any available information. Peter J. McManus, Box 38, Porter, ME 04068.

Micro-Q Z-80 based controller. Need schematic and operating manual. K.W. Keck, 9201 Hooker, Westminster, CO 80030.

Elco VTVM Model 221. Waterman Products industrial and television pocketscope Model S-11-A. **Precision Apparatus Co. Inc.** tube tester Model 912, Serial No. 16479. Need owners or service manuals and tube charts. Edward Skiret, Wickham Ave., Box 339, Mattituck, NY 11952.

Precision Apparatus Co. Series E-200 C signal generator. Need schematic, operating instructions and service manual. Rustan R. Crespo, 440 59th St., West New York, NJ 07093.

QUALITY PARTS AT DISCOUNT PRICES!

SUB-MINIATURE D TYPE CONNECTOR

SOLDER TYPE SUB-MINIATURE CONNECTORS USED FOR COMPUTER HOOD UPS

DB-15 PLUG	\$2.75
DB-15 SOCKET	\$4.00
DB-15 HOOD	\$1.50
DB-25 PLUG	\$2.75
DB-25 SOCKET	\$3.50
DB-25 HOOD	\$1.25

KEY ASSEMBLY



CONTAINS 5 SINGLE-POLE NORMALLY OPEN SWITCHES MEASURES 3 1/4" LONG



CONTAINS 6 SINGLE-POLE NORMALLY OPEN SWITCHES MEASURES 4 1/4" LONG

BCD DIP SWITCH

10 POSITION ROTARY SCREWDRIVER ADJUST. FITS 6 PIN DIP

SOLID STATE RELAYS

2 AMP MOTOROLA #MP 120D2 RATED

CONTROL—3 6VDC LOAD—120VAC 2 AMPS T.T.L. COMPATIBLE SIZE 1 7/8" x 1" HIGH \$3.50 EACH 10 FOR \$32.00

10 AMP

TELEDYNE P/N 615 CONTROL 3 32 VDC LOAD 10 AMP 140 VAC \$9.50 EACH

WIRE 15 CONDUCTOR

COLOR CODED 24 GA STRANDED GRAY JACKET 25 FEET \$12.00 100 FEET \$37.50

FREE! FREE! FREE! SEND FOR NEW LARGER 48 PAGE CATALOG

MINIATURE TOGGLE SWITCHES
ALL ARE RATED 5 AMPS @ 125 VAC

S.P.D.T. (on-on) P.C. STYLE NON-THREADED BUSHING 79¢ EACH 10 FOR \$7.00	S.P.D.T. (on-on) SOLDER LUG TERMINALS \$1.00 EACH 10 FOR \$9.00 100 FOR \$80.00	S.P.D.T. (on-off-on) SOLDER LUG TERMINALS \$1.00 EACH 10 FOR \$9.00 100 FOR \$80.00
S.P.D.T. (on-off-on) NON-THREADED BUSHING P.C. STYLE 79¢ EACH 10 FOR \$7.00	S.P.D.T. (on-on) P.C. LUGS THREADED BUSHING \$1.00 EACH 10 FOR \$9.00 100 FOR \$80.00	D.P.D.T. (on-on) SOLDER LUG TERMINALS \$2.00 EACH 10 FOR \$19.00 100 FOR \$180.00

POWER SUPPLY

REGULATED FULLY ADJUSTABLE 5 VDC AT 3 AMPS \$18.50 EACH

EDGE CONNECTORS

22/44 22/44 GOLD PLATED CONTACTS 156 CONTACT SPACING \$2.00 EACH 10 FOR \$18.00

28/56

28/56 GOLD PLATED CONTACTS 156 CONTACT SPACING \$2.50 EACH 10 FOR \$22.00

50/100

MICRO PLASTIC #MP 0125 50-DS-1 STANDARD 5 100 CONNECTOR 125 SPACING GOLD PLATED P.C. MOUNT \$3.75 EACH 10 FOR \$35.00

ALL ELECTRONICS CORP.

905 S. VERMONT • P.O. BOX 20406 • LOS ANGELES, CA 90006

TOLL FREE ORDERS • 1-800-826-5432

(IN CALIFORNIA: 1-800-258-6666)

AK, HI, OR INFORMATION • (213) 380-8000

- QUANTITIES LIMITED
- MINIMUM ORDER \$10.00
- USA \$2.50 SHIPPING
- NO C.O.D.
- FOREIGN ORDERS INCLUDE SUFFICIENT SHIPPING
- CALIF. RES. ADD 6.12%

Circle No. 3 on Free Information Card

For more information on advertised products, equipment tested, etc., circle appropriate number on postpaid Free Information Card.

Build Your Own IBM-PC Compatible!

Here are the boards, assembly instructions and parts you need... plus full back-up service from Netronics!

Complete instructions show you how to build an IBM-PC compatible that can run ANY—not just "popular"—IBM-PC programs!

Motherboard functionally duplicates IBM-PC... features IBM-PC compatible BIOS ROM plus five empty sockets for ROMs of your choice. Sockets will accept IBM-PC PROMs or other PROMs.

Instructions include step-by-step procedure for transferring ROMs from a pc onto a floppy disk, which can then be mailed away for ROM duplication.

Board kits include printed circuit board, some hard-to-get parts, and detailed assembly instructions. Complete kits include printed circuit boards, all parts, and detailed assembly instructions. Manuals only, \$5.00 per kit.

IBM-PC Compatible 16-bit Motherboard with IBM compatible BIOS ROM—□ Board kit, \$89.95/□ Complete kit, add \$140.00

IBM-PC Compatible Keyboard in cabinet (wired & tested), \$229.95

64k/256k Memory with serial port with DB-25 connector □ Board kit (64k), \$39.95/□ Complete kit (64k), add \$134.00/□ Each additional 64k block (to 256k), add \$75.00

Four Drive Disk Controller with hard disk SASI interface, parallel printer port, clock/calendar—□ Board kit, \$69.95/□ Paris for Four Drive Disk Controller, add \$130.00/□ Paris for Parallel Printer Port, add \$30.00/□ Clock/Calendar, add \$45.00/□ SASI Interface, add \$50.00/□ All 4 functions wired and tested, \$329.95.

IBM-PC Compatible Color Board (or B&W)—□ Board kit with ROM, \$89.95/□ Wired and tested, \$299.95.

Printer/Spooler Board with 64k buffer, clock calendar, parallel printer ports—□ Board kit with ROM, \$49.95

Modem Board, 300 BPS, direct connect/originate/auto-dial/auto answer plus 2 serial ports—□ Board kit with telephone company connectors, \$49.95

Power Supply □ Complete kit, \$179.95/□ Extra power for hard disk option, add \$20.00

□ Cabinet for PC, steel with brushed aluminum front panel and simulated oak cover, \$199.95

□ 5 1/4" Disk Drive, DSDD (wired & tested), \$269.95

□ 10 Megabyte Hard Disk with controller & software (wired & tested), \$1295.50

Netronics offers complete service department to customers.

TERMINALS

(Terminals require ASCII keyboard and power supply.)

□ Power Transformer for either terminal, \$9.95

SmartWd Deluxe Terminal, 80 characters by 24 lines, microprocessor controlled with editing, reverse video and more—□ Board kit (includes board, character generator, video controller, 2k system ROM), \$99.95/□ Complete kit, add \$100.00

FastVid Deluxe Terminal, 64 or 32 characters x 16 lines, baud rate to 19 kilobaud—□ Board kit (includes controller, character generator, and PROM), \$49.95/□ Complete kit, add \$50.00

SPEECH

Electronic Mouth Apple/S-100 Speech Board, with National NSC Digitalker speech chip—□ Apple/□ S-100 (Please check your choice.)/□ Board kit (with Digitalker and 150 word vocabulary set), \$69.95/□ Complete kit, add \$30.00/□ 2nd Word Set (150 words), add \$39.95

SpeakEasy Universal Talking Board, operates with computers and terminals or in the stand-alone mode. Uses same power supply as terminals (see above). □ Board kit (includes VORTRAX speech chip and system ROM), \$89.95/□ Complete kit, add \$60.00/□ Cabinet, add \$15.00

S-100 DYNAMIC RAM BOARD

16k/64k RAM Board uses popular 4116 chips—□ Board kit (includes 8202 controller), \$69.95/□ Complete kit (16k), add \$79.95/□ Each additional 16k, add \$50.00

ELF II BEGINNER'S PAK

ELF II is a complete 256 byte, fully expandable learning computer with excellent documentation that explains hardware and software fundamentals. Learn to program in machine language! Learn the essence of how all computers operate and "think"! If you can afford to think about an IBM-PC or IBM-PC compatible, you can't afford not to have an ELF II beginner's pak! □ Complete kit, \$139.95

USE YOUR CREDIT CARD! CALL TOLL FREE 1-800-243-7429 (In Connecticut call 203-354-9375)

To order by mail, check boxes above for products you desire. Mail entire ad with remittance to:

Netronics R & D, Ltd.

333 Litchfield Road, New Milford, CT 06776

Total enclosed \$ _____ (Conn. res. add tax) □ Visa

□ MasterCard Act. # _____

Exp Date _____ Signature _____

Print Name _____

Address _____

City _____

State _____ Zip _____

Computers & Electronics

ADVERTISERS INDEX

RS no.	ADVERTISER	PAGE no.
	24,28 Heath Co.	49,51,53,55
	56,57	
	21 Jameco Electronics	106
	22 JDR Microdevices	102-103
	23 J & R Music World	87
	20 Leading Edge	Cover 4
	48 3M Company	59
	30 Maxell	Cover 2
	31 McIntosh Laboratory, Inc.	89
	Memtek Products	11
	34 Micro-Ware Distributing	93
	29 Commodore Computer	15
	19 Communications Electronics	65
	60 CompuServe	13
	37 Computer Discount of America	91
	11 Computer Mail Order	72
	C & D Electronics	93
	Classified Advertising	107-116
	Cleveland Institute of Electronics, Inc.	26-29
	29 Commodore Computer	15
	19 Communications Electronics	65
	60 CompuServe	13
	37 Computer Discount of America	91
	11 Computer Mail Order	72
	14 Digi-Key Corp.	98-99
	33 Electronics International	90
	51 Electronic Specialist	90
	52 Electronic Warehouse	67
	Fuji SVEA	5
	46 Global Specialties	89
	Grantham College of Engineering	23
	79 Univair, Inc.	95

DIGI-KEY CORPORATION

In An., Ill., Mi. Call 216-881-6674



NATIONAL SEMICONDUCTOR • PANASONIC • QUALITY - Name brand products from nationally recognized manufacturers.
DAVID • CHEMVAR • ATLANTIC DIODES • N ARKES • PLESSEY • MOLEX • DAVIS • E F J OK MACHINE • UNGAR • GC CHEMICALS • A NATIONAL SEMICONDUCTOR • PANASONIC • SAVINGS - Volume Discounts • OEM Quantity Pricing • Toll Free 800 Number

CHEMICALS • ARKES • PLESSEY • MOLEX • E MACHINE • DIAMOND TOOL • UNGAR • GC CH AS INSTRUMENTS • D K A • PRODUCERS D ICH AND TOOL • UNGAR • GC CHEMICALS • ARKES CHEMICALS • ARKES • PLESSEY • MOLEX • E



SILICON RECTIFIERS ZENER DIODES



Part No.	Description	Price
1N4001	1N4001	...
1N4002	1N4002	...

3 AMP SILICON RECTIFIER

Part No.	Description	Price
1N4001	1N4001	...
1N4002	1N4002	...

National Semiconductor MA1023 Time-Temp. Clock Module

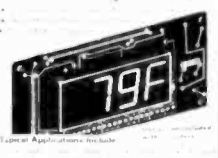

Part No.	Description	Price
MA1023	MA1023	...

Programmable Clock Modules

Part No.	Description	Price
MA1023	MA1023	...
MA1024	MA1024	...

Silicon Transistors

Part No.	Description	Price
2N3055	2N3055	...
2N2222	2N2222	...

1% Metal Film Resistors

Part No.	Description	Price
9501	9501	...
9502	9502	...

8" 4-Digit LCD Clock



Part No.	Description	Price
8001	8001	...

3AG Panel Fuseholder



Part No.	Description	Price
3AG1	3AG1	...

Termination Jumpers

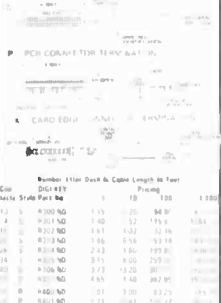

DIP Jumper Cable Assembly

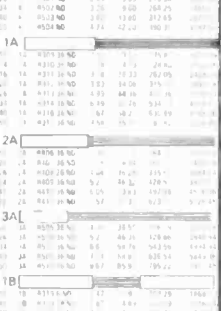

3AG JAG BLD FUSES

Part No.	Description	Price
3AG1	3AG1	...
3AG2	3AG2	...

alpha wire cable tubing

Part No.	Description	Price
AW100	AW100	...
AW200	AW200	...

Part No.	Description	Price
AW300	AW300	...
AW400	AW400	...

DIP Jumper Cable Assembly

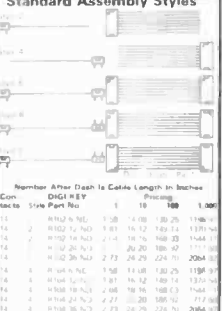

3AG JAG BLD FUSES

Part No.	Description	Price
3AG1	3AG1	...
3AG2	3AG2	...

alpha wire cable tubing

Part No.	Description	Price
AW100	AW100	...
AW200	AW200	...

Part No.	Description	Price
AW300	AW300	...
AW400	AW400	...

DIP Jumper Cable Assembly

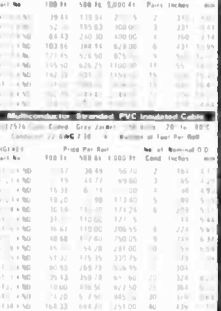

3AG JAG BLD FUSES

Part No.	Description	Price
3AG1	3AG1	...
3AG2	3AG2	...

8
8
88
8888

3AG Panel Fuseholder

Part No.	Price
3AG1	...

The Digi-Key volume discount and handling charges are simple to apply. Most items sold by Digi-Key may be combined for a volume discount. Items that are not discountable are identified by the suffix ND following the part number. After writing your order, total all of the discountable items and apply the appropriate discount. To this subtotal, add the non-discountable items. Then add the handling charge. We pay all shipping and insurance to addresses in the U.S.A., Canada and Mexico when check or money order accompanies order.

HANDLING CHARGES
\$ 0.08 - \$ 9.99 Add \$2.00 + 5%
\$ 10.00 - \$25.00 Add \$2.75 + 5%
\$ 25.00 - \$49.99 Add \$3.50 + 5%
\$ 50.00 - \$99.99 Add \$4.25 + 5%
\$ 100.00 & Up Add \$5.00 + 5%

VOLUME DISCOUNT
\$ 0.00 - \$ 9.99 Less 10%
\$ 10.00 - \$25.00 Less 15%
\$ 25.00 - \$49.99 Less 20%
\$ 50.00 - \$99.99 Less 25%
\$ 100.00 & Up Less 30%

Get the most from your SINCLAIR or Timex Sinclair with these practical books from Sync!



The ZX81 Companion
by Bob Maunder

The ZX81 Companion follows the same format as the very popular *ZX80 Companion*, and assists the ZX81 or Timex Sinclair 1000 user in four applications areas: graphics, information retrieval, education and games. This practical guide contains scores of fully documented short routines plus complete programs and a disassembled listing of the ZX81 ROM Monitor. "Thoughtfully written, detailed, and illustrated with meaningful programs."
—MUSE
5½" x 8", Softbound. #17P \$9.95 (\$2.00)

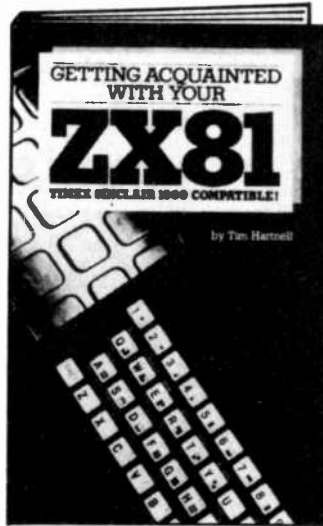

Getting Acquainted With Your ZX81
by Tim Hartnell

This informative volume for the new ZX81 or Timex Sinclair 1000 user contains more than 80 programs to help the reader get the most from his Sinclair computer. Game programs include Checkers, Alien Imploders, Blastermind, Moon Lander, Breakout, Star Burst and Derby Day. The book also shows programs for cascading sine waves, plotting graphs and tables, data sorting, equation solving, plus the use of PLOT, SCROLL, PRINT, TAB, PEEK, POKE and much more!
5½" x 8", Softbound. #15Y \$9.95 (\$2.00)



The Gateway Guide to the ZX81 and ZX80
by Mark Charlton

The Gateway Guide is a practical programming manual for the beginner that furnishes over 70 fully documented programs. The majority of the programs have been written for easy conversion from machine to machine (ZX81 or Timex Sinclair 1000, 4K ZX80 or 1K ZX80). *The Gateway Guide* describes each function and statement, illustrates it with a demonstration routine or program, and combines it with previously discussed material to help you understand your computer.
5½" x 8", Softbound. #160 \$9.95 (\$2.00)



Computers for Kids (Sinclair Edition) by Sally Larsen

This new edition of *Computers for Kids* is written specifically to introduce children aged 8 to 13 to the ZX81 or Timex Sinclair 1000. The book requires no previous knowledge of algebra, variables or computers, and it enables a youngster to program a Sinclair in less than an hour. There's also a section for parents and teachers. "*Computers for Kids* is the best material available for introducing students to their new computer."

—Donald T. Piele, Professor of Mathematics,
University of Wisconsin-Parkside.

8½" x 11", Softbound. #12S \$5.95 (\$1.00)

Also available at your local bookstore or computer store.

Creative Computing Press Dept. NH6F, 39 East Hanover Ave., Morris Plains, NJ 07950

Please send books listed below:

Item No.	Qty.	Price Each	(P&H)	Total Price

Postage and handling charges appear in parentheses () next to price of book

Outside U.S.A. add \$3.00 per order—

ENCLOSED IS \$_____. CA, NJ and NY State residents add applicable sales tax.

CHARGE MY: American Express Visa MasterCard
Card No. _____ Exp. Date _____

Signature _____

Print Name _____

Address _____

City/State/Zip _____

Check here for FREE Creative Computing Catalog.

**For faster service, PHONE TOLL FREE: 800-631-8112
(In NJ only: 201-540-0445)**

WHY DO SMART BUILDERS SHOP THE SHACK®?

High Quality!

No Minimum Order!

No Mail-Order Delays!

Replacement Transistors

Type	Cat. No.	Each
2N1305	PNP 276-2007	1.19
MPS222A	NPN 276-2009	.79
PN2484	PNP 276-2010	.89
MPS3904	NPN 276-2016	.69
TIP31	NPN 276-2017	.99
TIP3055	NPN 276-2020	1.59
MPS2907	PNP 276-2023	.79
MJE34	PNP 276-2027	1.49
2N3053	NPN 276-2030	.89
MPS3638	PNP 276-2032	.79
TIP120	NPN 276-2068	1.29
2N3055	NPN 276-2041	1.99
MJ2955	PNP 276-2043	2.19
2N4124	NPN 276-2057	.59
2N4401	NPN 276-2058	.59
MPSA06	NPN 276-2059	.59
MPSA13	NPN 276-2060	.59
MPSA42	NPN 276-2061	.69
MU4891	UJT 276-2029	.99
2SD313	NPN 276-2048	1.79
2SC945	NPN 276-2051	.79
2SC1308	NPN 276-2055	7.95
2N3819	N-FET 276-2035	.99
MPF102	N-FET 276-2062	.99

4000-Series CMOS ICs

With Pin-Out and Specs

Type	Cat. No.	Each
4001	276-2401	.79
4011	276-2411	.79
4013	276-2413	.99
4017	276-2417	1.49
4023	276-2423	.99
4049	276-2449	.99
4066	276-2466	.99

TTL Digital ICs

With Pin-Out and Specs

Type	Cat. No.	Each
7400	276-1801	.59
7404	276-1802	.79
7408	276-1822	.79
7447	276-1805	1.19
7490	276-1808	.89

Operational Amplifiers

Type	Cat. No.	Each
741	(Single) 276-007	.79
MC1458	(Dual) 276-038	.99
LM324	(Quad) 276-1711	1.29
TL082	(Dual) 276-1715	1.89
TL084	(Quad) 276-1714	2.99
LM3900	(Quad) 276-1713	1.39
LM339	(Quad) 276-1712	1.49

Audio Power Amplifiers

Type	Cat. No.	Each
LM383/TDA2002	276-703	3.19
LM386	276-1731	1.09
TA7205AP	276-705	2.99
LM380	276-706	1.59

Voltage Regulator ICs

Type	Adjustable	Cat. No.	Each
LM723	0 to 40 VDC	276-1740	.89
LM317T	1.2 to 37 VDC	276-1778	2.79

Type	Fixed Output	Cat. No.	Each
7805	+5 VDC	276-1770	1.59
7812	+12 VDC	276-1771	1.59
7815	+15 VDC	276-1772	1.59
7905	-5 VDC	276-1773	1.59
7912	-12 VDC	276-1774	1.59

Computer Connectors

Type	Positions	Cat. No.	Each
ID Card Edge	34	276-1564	4.95
ID Card Edge	50	276-1566	4.95
Card-Edge Socket	44	276-1551	2.99
ID D-Sub Male	25	276-1559	4.99
ID D-Sub Female	25	276-1565	4.99
Solder D-Sub Male	25	276-1547	2.99
Solder D-Sub Female	25	276-1548	3.99
Hood	—	276-1549	1.99

Power Transformers

120VAC Primaries

Type	Volts	Current	Cat. No.	Each
Mini	6.3	300 mA	273-1384	2.59
Mini	12.0	300 mA	273-1385	2.79
Mini	24.0	300 mA	273-1386	2.99
Mini	12.0	CT 450 mA	273-1365	3.59
Mini	24.0	CT 450 mA	273-1366	3.99
Std.	6.3	1.2A	273-050	3.79
Std.	12.6 CT	1.2A	273-1505	3.99
Std.	25.2	1.2A	273-1480	4.39
H-D	12.6 CT	3.0A	273-1511	5.99
H-D	25.2 CT	2.0A	273-1512	6.29
H-D	18.0 CT	2.0A	273-1515	6.99

Tantalum Capacitors

• 20% Tolerance
• Standard IC Pin Spacing

μF	WVDC	Cat. No.	Each
0.1	35	272-1432	.49
0.47	35	272-1433	.49
1.0	35	272-1434	.49
2.2	35	272-1435	.59
10	16	272-1436	.69
22	16	272-1437	.79

Special-Purpose ICs

Voice Synthesizer Set

 **1295**
Set of 2 ICs

SP0256, 28-Pin SPR16, 14-Pin

SP0256 Speech Processor. The easy, low-cost way to get into "solid-state" talk! NMOS LSI device uses a stored program to synthesize speech or complex sounds. It operates with a few simple support parts, or use the SPR16 Serial Speech ROM, included, for microcomputer interfacing. SPR16 contains 32 "talking clock" statements, three melodies. With data, circuit examples. Requires 3.12 MHz clock crystal—order through your local Shack. 276-1783 Set 12.95

Dual Switched Filter

NEW!
799  20-Pin

Capacitors Not Required

MF10. Versatile CMOS building block for active filters—eliminates the need for expensive, close-tolerance parts. High performance, yet very easy to use. Requires only six resistors and 150 kHz clock for a 4th order, 1 kHz Butterworth low-pass. A complete filter for a full-duplex 300-baud modem needs only two MF10s, 5 resistors, clock and ±5VDC! Center frequencies up to 20 kHz. Clock to center frequency ratio accuracy: 6%. Single or split supply. With data. For more information, see article by Forrest Mims III, page 86, July "Computers & Electronics" 276-2329 7.99

1/4-Watt, 5% Resistors

39¢ Pkg. of 5

Ohms	Cat. No.	Ohms	Cat. No.
10	271-1301	10k	271-1335
100	271-1311	15k	271-1337
150	271-1312	22k	271-1339
220	271-1313	27k	271-1340
270	271-1314	33k	271-1341
330	271-1315	47k	271-1342
470	271-1317	68k	271-1345
1k	271-1321	100k	271-1347
1.8k	271-1324	220k	271-1350
2.2k	271-1325	470k	271-1354
3.3k	271-1328	1 meg	271-1356
4.7k	271-1330	10 meg	271-1365
6.8k	271-1333	—	—

Miniature PC-Mount Pots

1/4-Watt, Horizontal-Mount

Ohms	Cat. No.	Each
1k	271-333	.49
10k	271-335	.49
25k	271-336	.49
100k	271-338	.49
500k	271-339	.49

1/4-Watt, Vertical-Mount

Ohms	Cat. No.	Each
500	271-226	.59
1k	271-227	.59
5k	271-217	.59
10k	271-218	.59
50k	271-219	.59
100k	271-220	.59
500k	271-221	.59
1 meg	271-229	.59

Miniature 4PDT Relay

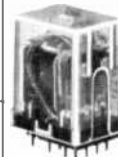

469 Switches up to four circuits! For PC or socket mounting. 120 VAC coil 1 3/8" x 1 1/8" x 1 3/16". 275-214 4.69

Illuminated Switch

495 SPDT Push-On/Push-Off. 3 amps at 120VAC. Built-in 12-volt, AC/DC lamp. Mounts in 1/2" dia. hole. 275-676 4.95

Learn Robotics

Fully illustrated and written in everyday language, this 256-page book covers everything from single-loop systems to complex robots used in industry. Learn how electronics can help increase productivity. 62-1387 2.95

Sale! 27-Range Multitester

Save Reg. 34.95
\$5 29.95



Reduced 14% Measures 0 to 1000 volts, AC and DC. 0 to 10 amps DC current in five ranges. Resistance to 10 megohms. Decibels: -10 to +52. 30,000 ohms per volt sensitivity. 6 1/4 x 4 1/2 x 2 3/4". With test leads and manual. Batteries extra. 22-203 Sale 29.95

Big 4" Meter

2114 450 NS 8/\$995

2114 250 NS 8/\$1095

7400

Table listing 7400 series components with columns for part number, quantity, and price.

LINEAR

Table listing Linear components with columns for part number, quantity, and price.

RCA

Table listing RCA components with columns for part number, quantity, and price.

CMOS

Table listing CMOS components with columns for part number, quantity, and price.

TI

Table listing TI components with columns for part number, quantity, and price.

BI FET

Table listing Bi FET components with columns for part number, quantity, and price.

H TO-5 CAN

T TO-220

K TO-3

74S00

Table listing 74S00 series components with columns for part number, quantity, and price.

IC SOCKETS

Table listing IC sockets with columns for pin count, quantity, and price.

VOLTAGE REGULATORS

Table listing Voltage Regulators with columns for part number, quantity, and price.

LED LAMPS

Table listing LED lamps with columns for color, quantity, and price.

LED DISPLAYS

Table listing LED displays with columns for part number, size, and price.

DIP SWITCHES

Table listing DIP switches with columns for position, quantity, and price.

INTERFACE

Table listing interface components with columns for part number, quantity, and price.

MISC.

Table listing miscellaneous components with columns for part number, quantity, and price.

CLOCK CIRCUITS

Table listing clock circuits with columns for part number, quantity, and price.

INTERSIL

Table listing Intersil components with columns for part number, quantity, and price.

9000

Table listing 9000 series components with columns for part number, quantity, and price.

EXAR

Table listing Exar components with columns for part number, quantity, and price.

DATA ACQUISITION

Table listing data acquisition components with columns for part number, quantity, and price.

SOUND CHIPS

Table listing sound chips with columns for part number, quantity, and price.

ORDER TOLL FREE 800-538-5000 800-662-6279 (CALIFORNIA RESIDENTS)

ALL MERCHANDISE 100% GUARANTEED



CALL US FOR VOLUME QUOTES

1983 JOM MICRODEVICES, INC.

Circle No. 22 on Free Information Card

TIMEX/SINCLAIR PRODUCT DIRECTORY

	Cassette signal conditioner	Connectors cables	Hardware power supply	Hardware repeat keys	Hardware sound generator synthesizer	Hardware video	Hardware misc	Interface analog	Interface floppy disk	Interface parallel printer	Interface serial	Joystick	Keyboard	Keyboard overlay	Memory RAM	Memory ROM	Memory non-volatile	Modem	Monitors	Printers	Software business	Software educational	Software entertainment	Software graphics	Software personal home	Software utility	Supplies cassette	Supplies diskette	Supplies misc	Books magazines
1	Byte Back Rt. 3, Bx. 147 Brodie Rd., Leesville, SC 29070					•				•		•		•			•		•	•										
2	Cinagro Software 155 Seventh St. Rochester, NY 14609														•											•				
3	Compusa 1101 Bristol Road Mountainside, NJ 07092		•	•	•	•		•			•	•	•	•						•	•	•	•	•	•	•	•	•	•	
4	Compusoft Publishing 535 Broadway El Cajon, CA 92021																											•		
5	Computer Add-Ons 664 North Michigan Ave., Suite 1010 Chicago, IL 60602						•								•															
6	Computer Continuum 301 16th Ave. San Francisco, CA 94118		•				•	•													•				•		•			
7	Data Assette 52 S. 3 Third St. Oxford, PA 19363		•	•			•		•	•		•	•	•	•						•	•	•		•					
8	Datacon P.O. Box 41 Flossmoor, IL 60422																				•	•	•	•	•					
9	Down East Computers Box 3096 Greenville, NC 27834		•					•									•													
10	E. Arthur Brown Co. 1702 Oak Knoll Dr. Alexandria, MN 56308				•					•					•					•	•	•					•			
11	E.Z. Key Suite 75, 7111 Southern Artery Quincy, MA 02169										•	•															•			
12	Filesixty P.O. Box 1469, Murray Hill Station New York, NY 10156												•																	
13	Group Technology Ltd. P.O. Box 87J Check, VA 24072						•																							
14	Heath Computer Services 950 E. 52 South Greentown, IN 46936																				•	•			•		•			
15	Hunter 1630 Forest Hills Dr. Okemos, MI 48864																•													
16	Intercomputer Box 90, Prudential Center Boston, MA 02199		•				•	•	•	•		•	•	•			•			•	•	•	•	•	•	•	•	•	•	
17	Jameco 1355 Shoreway Rd. Belmont, CA 94002												•	•	•					•	•	•	•							
18	Leading Edge 225 Turnpike Street Canton, MA 02021																			•	•									
19	Memotech 7550 W. Yale Ave., Suite 200 Denver, CO 80227		•						•	•		•		•						•	•		•		•		•			
20	Pleasantrees 7760 N. Hopdown Tucson, AZ 85741																					•	•		•		•	•		
21	Practical Programs Inc. P.O. Box 93104 Milwaukee, WI 53203																									•				
22	Quicksilva, Inc. 426 West Nakoma San Antonio, TX 78216																					•								
23	Ramex International P.O. Box 50 Utica, MI 48087			•		•	•		•	•		•		•						•	•	•	•		•					
24	Robotec, Inc. P.O. Box 55 Rossford, Ohio 43460																				•	•		•	•					

	Cassette signal conditioner	Connectors, cables	Hardware power supply	Hardware repeat keys	Hardware sound generator/synthesizer	Hardware video	Hardware misc	Interface, analog	Interface, floppy disk	Interface, parallel printer	Interface, serial	Joystick	Keyboard	Keyboard overlay	Memory, RAM	Memory, ROM	Memory, non-volatile	Modem	Monitors	Printers	Software business	Software educational	Software entertainment	Software graphics	Software personal/home utility	Supplies, cassette, diskette	Supplies, misc	Books magazines
25	Simplex Software 55 Sutter St., Suite 623 San Francisco, CA 94104																											
26	Sinclair Place P.O. Box 2288 Redmond, WA 98052																											
27	Sinware Box 323 Dixon, NM 87527																											
28	Solutions P.O. Box 1144 Piscataway, NJ 08854																											
29	Sophia Systems 15122 Pheasant Drive Surrey, B.C. Canada V3R 4X6																											
30	Sourceware, Inc. P.O. Box 1579 Vernile, VT 84038																											
31	Speedware 2611 W. 49th Austin, TX 78731																											
32	Strategem Cybernetics 286 Corbin Place 2E Brooklyn, NY 11235																											
33	Suntronics 12621 Crenshaw Blvd. Hawthorne, CA 90250																											
34	Sybex Inc. 2344 Sixth St. Berkeley, CA 94710																											
35	Sync Master Route 1, Box 122 Oak Ridge, NC 27310																											
36	Tapemasters P.O. Box 38651 Dallas, TX 75238																											
37	Timeworks P.O. Box 321 Deerfield, IL 60015																											
38	21st Century 6813 Polk St. Guttenberg, NJ 07093																											
39	York-10 Computerware 24573 Kittridge St., Dept. S-4 Canoga Park, CA 91307																											
40	Zebra Systems, Inc. 78-06 Jamaica Ave. Woodhaven, NY 11421																											

INSTRUCTIONS:

This Product Directory will help you locate manufacturers and suppliers of Timex/Sinclair products and services. If you would like further information, please fill in the coupon completely and circle the number corresponding to the company(s) you would like more information from.

Mail to:

Sync Magazine
One Park Avenue
New York, N.Y. 10016

SYNC MAGAZINE

DSPD 1283

One Park Avenue, New York, N.Y. 10016

Name _____

Title _____ Occupation _____

Company Name _____

Address _____

City _____ State _____ Zip _____

1. How many microcomputer(s) do you own? (Void after Feb. 15, 1984)
 A. None B. 1 C. 2 D. 3 Or More

2. Which Brands? (Check all that apply)

- | | | |
|--|--|--|
| A. <input type="checkbox"/> Apple | E. <input type="checkbox"/> Heath/Zenith | I. <input type="checkbox"/> Texas Instruments |
| B. <input type="checkbox"/> Atari | F. <input type="checkbox"/> IBM | J. <input type="checkbox"/> Timex/Sinclair |
| C. <input type="checkbox"/> Commodore/PET | G. <input type="checkbox"/> Osborne | K. <input type="checkbox"/> Other (please specify) |
| D. <input type="checkbox"/> DigitalEquipment/DEC | H. <input type="checkbox"/> Radio Shack/Tandy/TRS-80 | |

I would like more information on the following companies:

1 2 3 4 5 6 7 8 9 10 11 12 13 14 15 16 17 18 19 20
 21 22 23 24 25 26 27 28 29 30 31 32 33 34 35 36 37 38 39 40
 41 42 43 44 45 46 47 48 49 50 51 52 53 54 55 56 57 58 59 60

Computers & Electronics Marketplace

CLASSIFIED RATES: Per Word, 15 Word Minimum. **COMMERCIAL:** \$5.00. **PERSONAL:** \$3.00. **EXPAND-AD:** \$7.50. Ads set in all bold type @ 20% premium. Ads set with background screen @ 25% premium. **DISPLAY:** 1" x 2 1/4", \$605.00. 2" x 2 1/4", \$1,165.00. 3" x 2 1/4", \$1,675.00. **GENERAL INFORMATION:** Frequency rates and prepayment discounts available. Payment must accompany order except credit card—Am. Ex., Diners, MC, VISA (include exp. date)—or accredited ad agency insertions. Copy subject to publisher's approval; must be typewritten or printed. First word set in caps. Advertisers using P.O. Boxes MUST supply permanent address and telephone number. Orders not acknowledged. They will appear in next available issue after receipt. Closing date: 1st of the 2nd month preceding cover date (e.g., Mar. issue closes Jan. 1). Send order & remittance to: Classified Advertising, **COMPUTERS & ELECTRONICS Magazine** 1 Park Avenue, New York, NY 10016. To Charge your ad to a major credit card, call Lois Price at (212) 725-7226. For Customer Service, call (212) 725-4312.

FOR SALE

GOVERNMENT and industrial surplus receivers, transmitters, snooper scopes, electronic parts. Picture Catalog 25 cents. Meshna, Nahant, Mass. 01908.

ELECTRONIC PARTS, semiconductors, kits. FREE FLYER. Large catalog \$1.00 deposit. BIGELOW ELECTRONICS, Bluffton, Ohio 45817.

RECONDITIONED TEST EQUIPMENT \$1.00 for catalog. WALTER'S TEST EQUIPMENT, 2697 Nickel, San Pablo, CA 94806, (415) 724-0587.

ELECTRONIC CATALOG. Over 4,500 items. Parts, & components. Everything needed by the hobbyist or technician. \$2.00 postage & handling (United States Only), refundable with first \$15.00 order. T & M Electronics, 472 East Main St., Patchogue, NY 11772, (516) 289-2520.

PRINTED CIRCUIT BOARDS, your artwork. Quick delivery. Reasonable. Atlas Circuits, Box 892, Lincoln, NC 28092, (704) 735-3943.

SATELLITE TELEVISION. HOWARD/COLEMAN boards to build your own receiver. For more information write: ROBERT COLEMAN, Rt. 3, Box 58-APE, Travelers Rest, S.C. 29690.

RF MODULATORS for SATELLITE TELEVISION, MICRO-COMPUTERS CCTV. Also monitors, cameras, kits. FREE VIDEO CATALOG. Phone (402) 987-3771. Dealers Welcomed. ATV RESEARCH, 13-P Broadway, Dakota City, NE 68731.

CABLE TV CONVERTERS & EQUIPMENT. Plans and parts. Build or buy. For more information send \$2.00: C & D ELECTRONICS INC., P.O. Box 21, Jenison, MI 49428.

FREE FLYER! IC's, resistors, capacitors, jacks, etc., plus SSM music synthesizer/audio IC's, power amp modules, analog delay IC's, computer books, and more. Also plans for analog delay/chorus unit! PGS Electronics, Route 25, Box 304 Terre Haute, IN 47802.

CABLE TV

Buy Direct & Save

SUPER SPECIALS



40 CHANNEL
CONVERTER
\$29⁹⁵

Advanced Solid State design and circuitry allows you to receive mid & super band channels. Restores programming to Video Recorders



36 CHANNEL
REMOTE CONTROL
CABLE CONVERTER
\$69⁹⁵



JERROLD 400
THE ULTIMATE CABLE TV
CONVERTER



60 CHANNEL
INFRARED
REMOTE
CONTROL
\$129⁹⁵

Send \$5 for Complete Catalog

DIRECT VIDEO SALES
P.O. BOX 1329
JEFFERSONVILLE, INDIANA 47130
CALL
1-812-282-4788

POLICE CODE UNSCRABLERS, lets you hear the coded messages of Police, Fire and Medical channels; plus other scanner accessories, satisfaction guaranteed. DNE Inc., Rt. 7, Box 257-A, Hot Springs, AR 71901, (501) 623-6027.

RESISTORS, 1/4W-1/2W-5% C.F., 3¢ ea., 1% Metallfilms. NO MINIMUMS. Quantity Discounts. Write: JR INDUSTRIES, 5834-A Swancreek, Toledo, OH 43614.

FHEE CATALOG. Large selection of electronic kits and parts. Chaney Electronics, Box 27038, Denver, Colorado 80227, (303) 781-5750.

IF YOU ARE READY TO BUY OR SELL GAMES OR SOFTWARE, YOU NEED...

COMPUTER SHOPPER

Over 100 pages each month Deal with individuals nationwide Low ad rate, only 12¢ a word Subscription \$10/year MC & VISA Money back guarantee 407 S Washington, P.O. Box F599, Titusville, FL 32780 (305) 269-3211

CABLE TV

CONVERTERS & EQUIPMENT

We have the largest selection of JERROLD and OAK cable converters and equipment. Such as: Jerrold SB-3, Oak N12 and Jerrold 61 channel remote control converter with FULL features DRX3-DIC-105. Plus others.

CABLE TV KITS

Cable TV Kit (Jerrold gated pulse) 39.95.

We also have a large selection of cable TV and kits including all parts, silk screen, PC board and complete instructions.

Send for informative catalogue \$2.00

J & W ELECTRONICS, INC.

P.O. BOX 61-K

CUMBERLAND, RI. 02864

CABLE TV SECRETS, the informative publication the cable companies are trying to ban. HBO, Movie Channel, Showtime converters, etc. Send \$8.95 to: CABLE FACTS, Box 711-PE, Pataskala, Ohio 43062.

WHOLESALE- MATV/CATV/VCR equipment. Antennas, Audio, Cables, Adapters, Original and Replacement Cartridges, Styl, Telephone Accessories, Radios, Cassette Recorders, Speakers, etc. Send letterhead for catalog, 212-897-0509. D&WP, 66-19 Booth, Rego Park, NY 11374.

SATELLITE TELEVISION INFORMATION \$4 Build or buy your Earth Station. Satellite Television, RD 3, Oxford, NY 13830.

ELECTRONIC KITS—Low cost Power Supplies, Amplifiers, Alarm Systems, etc. Catalog \$0.25. CBBI, Box 222, North Granby, CT 06060.

World's Most Remarkable Radar Jammer!



Causes speed radar guns and devices to read out your choice of either a percentage of your true speed when in automatic mode (example: Your speed, 78 mph, auto mode set for 75%, speed displayed — 57 mph), or the speed that you dial in when in manual mode. Transmits only in the presence of speed radar, or by manual override. Operates on both K and K bands. WARNING: The device described in this literature is not legal for use against police radar, and is not FCC approved.

For complete literature and plan package, send \$14.95 to:

Phillips Instrument Design Co. Inc.
8136 S.W. Nimbus, Building #11, Suite #114 C
Beaverton, Oregon 97005

MICROWAVE ANTENNA SYSTEMS

Freq. 2.1 to 2.6 GHz • 34 db Gain • COMPLETE SYSTEMS (as pictured)

Commercial 40" Rod Style	\$89.95
Parabolic 20" Dish Style	\$79.95

TWO YEAR WARRANTY PARTS AND LABOR

CALL OR WRITE FOR KITS • PARTS • INDIVIDUAL COMPONENTS

We Repair All Types Down Converters & Power Supplies

Phillips-Tech Electronics
P.O. Box 34772
PHOENIX, AZ 85067
(602) 265-8255

Special Quantity Pricing • Dealers Wanted

NEW! MULTI-CHANNEL MICROWAVE

Complete Antenna Systems from \$69⁹⁵

Full 800 Mhz Range
Tune 1.9-2.7 Ghz
Includes all
ITFS Channels

DEALERS WANTED

COB's and Credit Card
Orders call TOLL FREE
1-800-247-1151

GALAXY ELECTRONICS
6009 N. 61 Avenue
Glendale, AZ 85301
1-602-247-1151

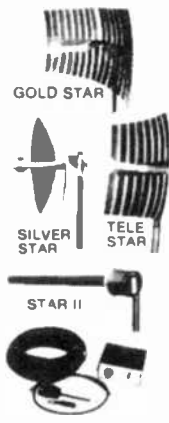

A SINGER'S DREAM!

TVE

REMOVES VOCAL FROM MOST STEREO DISCS

The Thompson Vocal Eliminator can actually remove most or virtually all of a solo vocalist from a standard stereo record and yet leave most of the background music untouched! Not an equalizer! We can prove it works over the phone. Write or call for a 24 page brochure and demo record.

Write to: **LT Sound**, Dept. CE, P.O. Box 338, Stone Mountain, GA 30086
Phone (404) 493-1258

FREE Catalog of special function IC's and quality components. Goldsmith Scientific, Box 318M, Commack, New York 11725.

Personalize your computer 1"x3" golden stickback nameplate. Specify 15 letters maximum. 4.95 ML Productions Box 47 Willimantic, CT 06226.

LCD PEN WATCH, ideal for Christmas. Special, 2 for \$7.00. Calculator alarm wristwatch, \$14.00. Telephones. Guaranteed. Fantastic, unusual gift items available. Send \$1.00 for catalog. Visa/Master Card. Starburst Industries, 6354 Van Nuys Blvd Suite 161, Van Nuys, CA 91401 (213) 994-5671.

MONEY BACK GUARANTEE. Easy to install circuit adds intercom/hold capability to phones for under \$10. Plans \$5.00. Information SASE dB Enterprises, Box 8, Oradell, NJ 07649.

GEARMOTORS \$35.00. 12VDC (6-36) 60 RPM. 1/6 HP. Instructions. Also speed controls. Drives robots, antenna doors, gates, carts. Sepac, 625 NW 41 Street, Seattle, WA 98107.

CORDLESS TELEPHONE OWNERS: prevent unauthorized calls with Call-Garde. Write: Broadcast Company Ltd., Box 59, Westmont, IL 60559.

ANTENNA (antimultipath type) for TV (UHF, VHF) & FM. Patented slotted array, 26" x 48", hanging vertically, inside outside use. Patented, guaranteed. Sent for only \$12 but FOB. Cash, VISA, COD OK by SAOCO, 11621 Hughes NE, Albuquerque, N.M. 87112 (FOB about \$4.00).

PCB 15" sq-in. FREE DRILLING. Quantity Discounts. International Enterprise, 6452 Hazel Circle, Simi-Valley, CA 93063.

DISCOUNT SOFTWARE-35% MINIMUM BELOW RETAIL. We carry all available educational, business, entertainment software for Apple, Atari, TI 99/4, VIC20, Commodore 64, IBM-PC, TRS-80. Hardware: Gemini 10x-\$300. Okidata, Prowriter, Banana-\$200. Hayes smartmodem-\$200. Over 100 more hardware catalog for your computer. Specify make. MULTI VIDEO SERVICES P.O. Box 246, East Amherst, N.Y. 14051

TOP QUALITY G-10 CIRCUIT BOARD less than 1" sq. in. 10 lb. Assortment \$19.95, or cut to size 4" sq. in. (min. \$10). Harris, 193 Clinton Heights, Columbus, OH 43202

PRINTED CIRCUIT BOARDS ... Projects this issue. Also custom boards, your artwork or ours. Quality. Competitive prices. Century Instruments, 400 Maxey Court, #4, Yukon, Oklahoma 73099. (405) 354-0347.

SATELLITE TV RECEIVER BREAKTHROUGH! Build your own commercial quality receiver now! Instruction manuals, schematics, circuit boards! Send stamped envelope: XANDI, Box 25647, Dept. 22T, Tempe, AZ 85282.

1983 TAX RETURN HELPER for TIMEX and COMMODORE. Form 1040 and Schedules A, B, C, D and E. TS1000 \$15.50, TS2000 \$19.50, VIC20 & C64 \$24.50. KSOFT CO., 845 Wellner Rd., Naperville, IL 60540.

SEND FOR FREE DISCOUNT CATALOG: electronic components, parts. HORIZON SALES, P.O. Box 646, Framingham, MA 01701. (617) 875-4433.

VIC, CBM 64 basic compiler subset, two pass Assembler, spread sheet programs. 40 column display on VIC via software. \$15 each. VIC 8K required. Specify computer, free complete list for SASE. Software Solutions, P.O. Box 542, Sylvania, Ohio 43560.

PRINTED CIRCUIT ARTWORK, DESIGN/LAYOUT. Quality, professional, prompt. SOMMER CIRCUIT DESIGN, P.O.B. 635, Wooster, OH 44691. (216) 263-6930

DIGITAL TRAINERS AND POWERED BREADBOARDS ... The most complete selection available ... at the lowest prices. For free catalog write, C-Systems, Box 2482, Evergreen, CO 80439.



MAGIC COMPUTER "INPUT/OUTPUT" MUGS

When hot liquid is poured in, one message disappears and another takes its place on the computer screen. Fascinating to watch. Big 10 oz. size. Fine quality white English porcelain. MUG "B" - "Computer Expert on/off duty."

*\$8.95 ea. Plus \$2 ea. for ship. & handling. Fla. residents add 5% sales tax.

Visa or MasterCard accepted. Include card #. Expiration date and signature with order.

Send for our free COMPUTERMANIA Catalog of other unique items for the computer buff.

Call Toll-Free Mon.-Fri. 9am-6pm
1-800-B-E-S-W-E-E-T • In Fla. (305) 687-9338

sweet gum inc.

15490 NW 7th Ave., Dept. CE123, N. Miami, FL 33169

MULTI-CONDUCTOR CABLE—2 to 36 COND. AVAIL. FOR FREE INFO SHEET, WRITE: GORDON DEWEY, RD1, CENTRAL SQUARE, N.Y. 13036.

CABLE T.V. EQUIPMENT. Channel 3 or 4 notch filter \$20.00. Information \$1.00. Goldcast, P.O. Box 63/6025A, Margate, FL 30363. (305) 752-9202



TIME-SHARE

Only you and your fellow computer experts will know what time it is with this binary numeral wall clock. Hand-

some simulated walnut finish, accurate quartz movement with sweep second hand. Perfect for office or home. Runs on one AA battery (not incl.). 11 1/4" diagonal. 1 yr. warranty. 10 day money-back guarantee.

***\$39.95** Plus \$3.50 ea. for ship. & handling. Fla. residents add 5% sales tax.

Visa or MasterCard accepted. Include card #. Expiration date and signature with order.

Send for our free COMPUTERMANIA Catalog of other unique items for the computer buff.

Call Toll-Free Mon.-Fri. 9am-6pm
1-800-B-E-S-W-E-E-T • In Fla. (305) 687-9338

sweet gum inc.

15490 NW 7th Ave., Dept. CE123, N. Miami, FL 33169

LOWEST POSSIBLE PRICES ANYWHERE! Computers. Hardware—Software—Printers, Audio, Video, Car Stereo. ELECTRIFIED DISCOUNTERS, 996 Orange Ave., West Haven, CT 06516. MC/VISA. (203) 937-0106.

KEYPAD operated ELECTRONIC LOCKS. Previously unavailable! Detailed information and construction techniques on the LATEST in pushbutton convenience... Your private code prevents unauthorized access to: HOMES, TV's-VCR's, COMPUTERS, APPLIANCES, STEREOS, even TELEPHONES... Eliminate tampering, theft, or possible injury. ILLUSTRATED manual full of plans, diagrams, hints, parts-lists & sources. JUST \$6.95 ppd! MILTONOMNI-SEARCH, Box 5044 Dept. C, Ormond Bch., FL 32074.

USA **CABLE TV UNITS** CANADA

AMAZING PRICE BREAKTHROUGH! ONLY **\$7995***

Our model TX-200 is fully with the Jerrold Starbase-3 (SB-3). The TX-200 is engineered with Automatic Gain Control (A.G.C.) and uses only the highest quality components. All our units come to you fully assembled and thoroughly tested. They are finished in simulated walnut, or matte black to match any decor. The TX-200 is fully guaranteed for a period of one year, including all parts and labour. We also have units which are compatible with the Oak, Hamlin and many other systems. Our deluxe catalogue is available for \$3.00.

TELTECH LTD 120 Wall St. Suite 1044 Dept. CE-12
New York, NY 10005

*Please add \$3.00 postage and handling Dealer inquiries invited

USED COMPUTER TERMINALS, printers, modems, cables, surplus electronic parts. Specials: CRT's \$20.00, Modems \$35.00. Catalog \$1.00. Rondure Company, "The Computer Room" CE, 2522 Butler Street, Dallas, TX 75235. (214) 630-4621.

COMPUTER EQUIPMENT/PARTS

SAVE 90% Build Your Own Minicomputer. Free Details. Digatek, 2723 West Butler Dr., Suite 20C, Phoenix, AZ 85021.

WANT A PLEASANT SURPRISE? Call or write for quotes: Atari, Commodore, Timex, T.I., Corona (IBM work-alike), Amdek, Anadec, Apple & IBM accessories, Hayes, More. GET SURPRISED! HARDWARE SOFTWARE ANYWARE CO., 10 Coles Street, Brooklyn, NY 11231, (212) 596-3592.

APPLE BUILDERS—Send stamp for our flyer of Apple parts. IC sets, ROM sets, component packages, Shugart—Apple modification kits, Apple 9-track tape drives etc. Electrovalve, P.O. Box 376-P, Morris Plains, NJ 07950.

HARD DISK DRIVE LIQUIDATION. Major OEM is liquidating inventory of unused Shugart 8" SA 1002 5.33 megabyte hard disk drives. \$380 each. Western Digital's controller. \$350. Call: LIQUIDATORS, 803-877-9828, or send check/money order to: 105 S. Main St., Greer, SC 29651.

FREE! Computer supplies catalog—Low prices—Satisfaction guaranteed—DATA SYSTEMS, Box 99, Fern Park, Florida 32730. (305) 788-2145.

DISK FILE—\$9.95 holds 150 disks: includes dividers, labels, backstops for 5 1/4" and 8". Call: 800/225-0044. Weber's, Box 104CA, Adelphia, NJ 07710.

COMPUTER SOFTWARE

TI-99/4A MOON TRIP animated graphic program on cassette. Guide module through astroid belt. Then land on moon Speech synthesizer and joyst capability. \$12.00 postpaid. JAG Software, P.O. Box 2225, Dept 1CE, Ocean, New Jersey 07712.

DISCOUNT SOFTWARE—Available for Apple, TRS-80, IBM/PC and TI 99/4 personal computers. Professional applications for the doctor, dentist, attorney, school administrator, teacher, contractor and general office personnel. Catalog \$1.00. Write for MONTHLY SPECIAL OFFERS! Creative Discount Software, 256 S. Robertson Blvd., Suite 2156, Beverly Hills, CA 90211.

COMPUTER PAPER—SAVE\$\$\$; Top quality. Fast shipping. Low single—carton prices. Super quantity discounts. Call A-1, 405 Third, Long Beach, Ca., (800) 628-8736 or (213) 804-1270.

FREE money saving bulletin on popular brand name programs and books for your small computer. Superior, Dept CE, 8030 Westchester Road, Westchester, OH 45069.

TI-99/4A PROGRAMMERS: Affordable Software! Catalog, only \$1. PROGRAMS SOFTWARE, 1435 Burnley Square North, Columbus, Ohio 43229.

FREE VIC-20 and COMMODORE 64 USERS GROUP MEMBERSHIP with software purchase. Why pay to belong to a users group when you don't have to? Benefits: Newsletter, extensive club library, discounts, contests, questions hot-line and more! Free details—(803) 797-1533. Lords of Basic, P.O. Box 459, Dept. 102 Ladson, SC 29456.

COMMODORE OWNERS VIC-20 and Commodore 64 unique hardware and software free catalog from: Micro-ware Distributing, Inc., 1342B Route 23, Butler, NJ 07450. 201/838-9027.

TI-99/4A SOFTWARE: Programs for Astronomy, Mathematics, Finance, Education. Write: Eastbench Software, 1290 Cliffside Drive, Logan, UT 84321.

VIC 20/s64—WHOLESALE PRICES ON ALL PRODUCTS! Send SASE: Omni Micronics, 404 Auburn Road, Waynesville, NC 28786.

T/S 100 PROGRAMS: Financeaid (Barcharts, interest, record keeping), Math Quiz (20 levels), Dectrosolve (solves most electronic circuit problems) \$6.95 each. Bill Kemp, Box 26086, Bluff Park, AL 35226.

COMMODORE-64 OWNERS Craps, Address Filer, 21, Sprites, Reflex tester, Family Budget, Decision Maker, Adding Machine, Numbers Game and Hangman. All 10 great programs for only \$14.95. Please specify whether disk or tape is desired. Mail check or Money Order to C.M. Andre & Co., P.O. Box 5062, Glendale, AZ 85312.

TRS-80, ATARI SOFTWARE: Science, Mathematics, Astronomy, Music, Curve Fitting, Fourier Analysis, Statistics, Graphics, Finance. BROCHURE. Benchmark Computing Services, P.O.B. 385-B, Providence, Utah 84332.

VIC 20/COMMODORE 64 SOFTWARE. FREE CATALOG! Inexpensive and practical programs in education, home, and business. Mailing list/64 (disk) \$16.00 typing practice (tape) \$6.00 many more. FARTHEST FRING S.A., 101 Highway Blvd., N. Pekin, IL 61554.

STOCK MARKET SOFTWARE ... Send \$10.00 for STOCK TREND DETECTOR basic program to: S.M. Decisions, Box 362, Dublin, IA 18917.

ZX81, TS1000, TI 99/4A Software, Send for FREE Catalog: Midwest Software, 9922 Harwich, Crestwood, MO 63126.

COMMODORE 64-BUSINESS SOFTWARE PACKAGE. Includes checkbook program. \$10.00. Behen, 709 N. Shore Dr., Milford, DE 19663.

TI-99/4A OWNERS. Send for free list of new and exciting, low cost software. D.E. Box 124 Hicksville, NY 11801.

48K computer U.S. \$380.00 or hundreds Apple compatible softwares details U.S. \$1.00 Reliant P.O. Box 33610, Sheungwan Hong Kong.

JOIN THE PERSONAL ROBOT REVOLUTION. Meet Heath's Hero-1 and RB Robot's RB5x at Cal-Robot, P.O. Box 5973, Sherman Oaks, CA 91413. (213) 905-0721.

MONEY BACK GUARANTEE. Easy to install circuit adds Intercom/Hold capability to phones for under \$10. Plans \$5.00. Information SASE dB Enterprises, Box 8, Oradell, NJ 07649.

Horse Race Software-TRS-80, C64 VIC20, CALL OR WRITE for free catalogue, Computer Research Tools, 725 South Evanwood Ave., West Covina, Calif. 91790 (213) 962-1688.

DISKETTE FORMAT CONVERSIONS/DOWNLOADING, from \$500. Port-A-Soft, 423 #800 N, Orem, UT 84057, 801/226-6704.

VIC 20 40 COLUMN DISPLAY. On tape, 8.95: NDPE, 102 Hickory Ct., Portland, IN 47371.

COMPUTER HARDWARE

Eagle PC-2 \$2738; Compu Pro 816A \$3998; Daisy Rider 2000 \$1197; Epson, Call: Okidata 92 \$509; Hayes 1200 \$505; etc. WCB (707) 544-5304, 1800C Hobbie Lane, Santa Rosa, CA 95407.

HARD DISKS 10MB for Apple and IBM only \$1395, Apple Compatible Disk Drives \$189, Controller Card \$55, IBM compatible 1/2bt drive \$205, Monitors 12 inch \$115, VERBATIM DISKETTES 5 1/4 inch ssdd \$23.55 BX. OZ tech, (800) 222-6677, in California, (408) 980-9987.

COMPUTER PUBLICATIONS

SAVE \$ ON COMPUTER BOOKS & SOFTWARE! For FREE DISCOUNT CATALOG write: Downtown Book Bazaar, Dept. C, P.O. Box 2490, Brooklyn, NY 11202.

USER'S BOOK for HP-41C/41CV. Hundreds of techniques and RPN subroutines. Send \$15 per copy U.S.A./Canada, (elsewhere \$20) to: Corvallis Software, P.O. Box 1421, Corvallis, Oregon. 97339. (503) 754-9245.

AMATEUR RADIO

VIDEOSCAN 1000 Slow Scan TV — HIGH RESOLUTION (amateur, phone line, monitoring, teleconferencing). CODE*STAR — DECODE Morse, RTTY, ASCII. LARGE LEDs or connect computer/printer. MORSE-A-KEYER — CW Keyboard. TRI-VOLTAGE POWER SUPPLY. Kits/Assembled. FREE brochures. MICROCRAFT CORPORATION, Box 513-PE, Thiensville, WI 53092. (414) 241-8144.

TIMEX/SINCLAIR

KROK., STAR SEARCH, NOAH'S ARK, finest programs available. Machine Language action, graphics. SASE Brown Cottage, 5486 Bright Hawk, Columbia, MD 21045.

MAX "Z-Z" TECH TIMEX HI-TECH educational programs. Hardware coming soon. For samples mail \$2.00 to: CASH Progs., P.O.B. 318C, NFLD., NJ 07431.

ZX DATA-FINDER, ZX PRO/FILE & much more professional/game/hobby machine language software. Catalog 50¢ (refundable). ROBOTEC, INC., Box 55, Rossford, OH 43460. (419) 666-2410. VISA/MC.

TIMEX SINCLAIR owners—get monthly news, tips, programs, projects to expand 1000/1500/ZX81, \$29 per year. Back issues available. SYNTAX, RD2 Box 457, Harvard, MA 01451.

5 TS/1000 PROGRAMS FOR \$5. Send SASE for details: Programs 3763 W. Crocus, Phoenix, AZ 85023.

"MUST-HAVE" UTILITY SOFTWARE. Cassettes-relocatable machine language. SASE for BROCHURE—SIRIUS WARE, 6 Turning Mill Rd., Lexington, MA. 02173.

TIMEX 1000 SOFTWARE. David Leithauser's "MINE FIELD" \$9.95. Many More. \$1.50 shipping per order. For a FREE catalog send a 20¢ U.S. stamp to: Software Development Associates, Dept. C4, 3328 W. Las Palmaritas, Phoenix, AZ 85021. Arizona residents add 6% tax.

TIMEX/SINCLAIR VIC-20 Bible pack design build any peripheral imaginable includes cassettes \$39.95. Info. \$6.00 refundable. Jorge Sampson, Box 38663, Houston, TX 77288.

ARTIFICIAL INTELLIGENCE PROGRAM. Converse with ZX-81/TS 1000. 16K. Cassette, \$10. Dynabyte, Box 2021 Michigan City, IN 46360.

FREE CATALOG for ZX81/TS1000. More than 60 different programs from \$9.95-\$14.95. Discount Software, P.O. Box 2530, New York, NY 10185.

FREE Timex/VIC-20/TI99-4A/Commodore-64 programs! SASEs bring catalogs. Inexpensive! EZRAEZRA, Box 5222-CD, San Diego, CA 92105.

NEW CHRISTMAS CATALOG. Send three 20¢ stamps: JPR SOFTWARE, P.O. Box 4155, Dept. -B, Winter Park, FL 32793.

C.B. EQUIPMENT

CB MODIFICATIONS, conversions, books, plans, kits, repairs. Catalog \$2. CBCL, Box 31500PE, Phoenix, AZ 85046. (602) 996-8700.

CABLE TV

CHANNEL 3—60db notch filter. 63.5MHZ. \$32. Crosley, Dept. 607, Box 840, Champlain, NY 12919.

PLANS AND KITS

FREE KIT CATALOG contains test equipment. Phone (209) 772-2076. DAGE SCIENTIFIC, Box 144, Valley Springs, CA 95252.

ROBOTICS—BOOKS—build your own robot. Write now for FREE catalog! Kohn Co./JCE11, Box 16265, Alexandria, VA 22302.

MAILING LISTS

COMPUTER SHOW ATTENDEES N.Y., N.J.: 15,000 NAMES. \$30/M. P/S labels. For info, (201) 297-2526.

ALARMS

BURGLAR-FIRE ALARMS for home, business, auto. Install yourself and save. Installation manual/catalog shows how. Shows latest equipment, accessories. Lowest prices. Send \$1.00 (refundable). BURDEX SECURITY, Box 82802-CEL, Lincoln, NE 68501.

PROTECT MICROCOMPUTERS AND ELECTRONICS! Free catalog of systems for SCHOOLS, OFFICES, HOMES. SGM Corporation, 6 West Main, Bound Brook, NJ 08805. (201) 469-8585.

WANTED

GOLD, electronic, circuit board scrap, silver, platinum, tantalum, mercury. Ores, metals assayed. Samples evaluated. Wholesale Terminal, toll free 1-800-932-1010, (617) 326-3442 in Mass.

WANTED: Old Western Electric, RCA, tubes, Amplifiers, Speakers. McIntosh, Marantz, Amplifiers, THORENS, Garrard Turntable. 713-728-4343.

GOVERNMENT SURPLUS

IS IT TRUE YOU CAN BUY JEEPS FOR \$44 THROUGH THE U.S. GOVERNMENT? Get the facts today! Call (312) 742-1142 Ext. 4649.

ELECTRONIC COMPONENTS/EQUIPMENT thru Government Surplus. Updated Guidebook. How and where to buy. \$2.00. Hammer Industries, P.O. Box 227, Glen Falls, NY 12801.

TUBES

TUBES: "Oldies", Latest. Supplies, components, schematics. Catalog Free (stamp appreciated). Steinmetz, 7519-PE Maplewood, Hammond, Ind. 46324.

HUGE INVENTORY! Thousands of types. Wholesale prices. FREE CATALOG! ETCO Electronics, DEPT. 290, Plattsburgh, NY 12901.

PERSONALS

MAKE FRIENDS WORLDWIDE through international correspondence, illustrated brochure free. Hermes-Verlag, Box 100660/Z, D-1000 Berlin 11, W. Germany.

SUNBELT SINGLES looking for a person of quality. Check our group. Details Box 83395, Oklahoma City, OK 73148.

UNIVERSITY DEGREES BY MAIL! Bachelors, Masters, Ph.D.s . . . Free revealing details. Counseling, Box 317-PE12, Tustin, California 92680.

FREE WORLD'S LARGEST PARTNER PHOTO CATALOG for friendship and marriage. Personalized introductions INTERCONTACT, Box 12 Toronto, Canada M4A 2MB.

USA/CANADA/EUROPE—Sophisticated singles seek correspondence, meaningful relationships. Details: (Send Stamp) Scannaclub-(CE), Box 4, Pittsford, NY 14534.

BEAUTIFUL PHILIPPINE LADIES seek nice friendship, correspondence!! Photos, information, free!! Transcor-(B), Box 2321 Manila, Philippines 2801.

INSTRUCTION

LEARN WHILE ASLEEP! HYPNOTIZE! Astonishing details, strange catalog free! Autosuggestion, Box 24-ZD, Olympia Washington 98507.

UNIVERSITY DEGREES BY SPECIAL EVALUATION of existing credits and Job Experience. Fast, inexpensive. Call (614) 863-1791. Or write: EVALUATION, Box 13151-A12, Columbus, Ohio 43213.

REPAIR ELECTRONIC ORGANS—Revised home study course covers all current makes and models. Free booklet. Niles Bryant School, P.O. Box 20153, Sacramento, CA 95820.

F.C.C. COMMERCIAL RADIOTELEPHONE LICENSE. Home Study. Fast, inexpensive! Free details. COMMAND, D-100 Box 2223, San Francisco 94126.

UNIVERSITY DEGREES BY MAIL! Bachelors, Masters, Ph.D.s . . . Free revealing details. Counseling, Box 317-PE12, Tustin, California 92680.

UNIVERSITY Degrees! Economical home study for Bachelor's, Master's, Doctorate. Prestigious faculty counsels for independent study and life experience credits. Free proof—Richard Crews, M.D. (Harvard), President, Columbia Pacific University, 1415 Third Street, Suite D511, San Rafael, CA 94901; Toll Free: 800/227-1617, Ext. 480; California: 800/772-3545, Ext. 480.

EXPERIMENTAL ANALYSES of solar activity and Pacific area meteorology and seismology. Info: Sase. IWS 11625 W. McKinney Ave. Fresno CA 93711.

UNIVERSITY DEGREES without classes. Bachelors, Masters, Doctorates. Accredited, inexpensive, fast. Dr. John Bear, P.O. Box 11447-C12 Marina Del Rey, CA 90291.

MEDICAL ELECTRONICS TECHNOLOGY, home study. Troubleshoot medical instruments. WTI, P.O. Box 3124, Fresno, CA 93650-3124.

..... CLASSIFIED ADVERTISING ORDER FORM
1 _____ 2 _____ 3 _____ 4 _____ 5 _____
6 _____ 7 _____ 8 _____ 9 _____ 10 _____
11 _____ 12 _____ 13 _____ 14 _____ 15 (MINIMUM)
16 _____ 17 _____ 18 _____ 19 _____ 20 _____
21 _____ 22 _____ 23 _____ 24 _____ 25 _____
26 _____ 27 _____ 28 _____ 29 _____ 30 _____
Please refer to heading on first page of this section for ad placement information
COMMERCIAL: \$5.00. PERSONAL: \$3.00, EXPAND-AD*: \$7.50.
OF WORDS _____ # OF INSERTIONS _____
 PAYMENT ENCLOSED \$ _____
 CHARGE You will be billed monthly American Express Diners Visa MasterCard-Interbank # _____
Account # _____ Exp. Date _____
SIGNATURE _____
PRINT NAME _____
ADDRESS _____
CITY _____ STATE _____ ZIP _____
CE-1283

FOR INVENTORS

INVENTORS! IDEAS HAVE VALUE!

Ever think of an idea, forget it and see it later on the market? Many people don't forget, act quickly and are rewarded by American Industry. Write down your idea! We offer free disclosure registration and initial consultation regarding your idea's potential value. Call or write without delay for your free information package.

AMERICAN INVENTORS CORPORATION
82 Broad St., Dept. CE
Westfield, MA 01086
413-568-3753

A fee Based Marketing Company
Offices Coast to Coast

INVENTIONS, IDEAS, NEW PRODUCTS WANTED! Industry presentation/national exposition. Call free 1-800-528-6050—Arizona, 1-800-352-0458, X831.

PATENT AND DEVELOP your invention. **FREE PATENT INFORMATION.** Richard L. Miller, P.E., 3612-E, Woolworth Building, New York, NY 10007, (212) 267-5252.

BUSINESS OPPORTUNITIES

FREE CATALOGS. Repair air conditioning, refrigeration. Tools, supplies, full instructions. Doolin, 2016 Canton, Dallas, Texas 75201.

MECHANICALLY INCLINED individuals desiring ownership of Small Electronics Manufacturing Business—without investment. Write: **BUSINESSES**, 92-K11 Brighton 11th, Brooklyn, New York 11235.

ERASE DEBTS with little-known law—create wealth!! Details **FREE**—Wealth Kit, No. EE12, Billings, NY 12510.

MAILORDER OPPORTUNITY! Start profitable home business without experience or capital. Information free. Mail Order Associates Inc., Dept 78, Montvale, NJ 07645.

ONE MAN CRT FACTORY. T.V.'s, Business machines, Monitors, Scopes, VDT's. \$3.00 rebuilding nets \$100-\$500 each tube. Higher profits overseas. New/used. **FACTORY**, 1909 Louise, Crystal Lake, IL 60014. (815) 459-0666.

BORROW \$300-\$30,000 INTEREST FREE! Keep indefinitely! Free Details. Write: American, 1601 Main, Plainfield, Indiana 46168.

"PROFESSIONAL" GIANT SCREEN PROJECTION TV... "Don't be fooled by cheap imitations!"... "Build and sell the best with lenses and screens utilized by Sony, Zenith, Pioneer, and Magnavox!"... Simple Construction!... Unlimited profits!... Illustrated dealers information and complete parts catalog \$2.00... Money back guarantee!... **POLI-VISION**, 187-C Cypress St., Throop, PA 18512.

PICTURE TUBE REBUILDING EQUIPMENT—new and used. **ATOLL TELEVISION**, 6425 Irving Park, Chicago, Illinois 60634, (312) 545-6667.

U.S. GOVERNMENT DATA PROCESSING CONTRACTS for small business. Soft and hardware. Solicitation subscriptions \$10.00 each. (800) 457-0522.

MAIL ORDER FIRM in **EDUCATIONAL** product desires to acquire computer related product or firm. G. George Fox Warner Electric Company Dept. CE-M 1512 West Jarvis Chicago, IL 60626.

ACQUIRE WEALTH BORROW \$30,000 INTEREST FREE! Keep indefinitely. Erase debts with little-known law! Free details: Financial technologies, Box 40434 E Fayetteville, NC 28309.

MAILORDER OPPORTUNITY! Start profitable home business without experience or capital. Information free. Mail Order Associates Inc., Dept 78, Montvale, NJ 07645.

REAL ESTATE

NEW... FREE CATALOG! Top real estate values coast to coast! Please specify types, property and location desired. **UNITED FARM AGENCY**, 612-EP West 47th, Kansas City, MO 64112.

EMPLOYMENT OPPORTUNITIES

ELECTRONICS/AVIONICS EMPLOYMENT OPPORTUNITIES. Report on jobs now open. Details **FREE.** Aviation Employment Information Service, Box 240E, Northport, New York 11768.

GOVERNMENT JOBS—Thousands of vacancies must be filled immediately. \$17,634 to \$50,112. Call 716-842-6000, Ext 3909.

JOBS OVERSEAS - Big money fast. \$20,000 to \$50,000 plus per year. Call 1-216-453-3000, ext. 4601.

OVERSEAS Positions. Hundreds of top paying positions available. **TAX free incomes.** Attractive benefits. Opportunities for all occupations, skilled trades, professionals, management, technicians etc. Free details. Overseas Employment Services, Dept. CE, P.O. Box 460, Town of Mount Royal, Quebec, Canada H3P3C7.

BOOKS & MAGAZINES

PUBLISHERS' OVERSTOCKS. BARGAIN BOOKS 2,000 titles, all subjects! Free catalog: Hamilton's, 98-85 Clapboard, Danbury, CT 06810.

DON'T WASTE YOUR MONEY! If you are buying a computer you need to read **101 QUESTIONS AND ANSWERS YOU MUST CONSIDER BEFORE YOU BUY.** Also included as a **FREE Bonus. THE PLAIN ENGLISH COMPUTER GLOSSARY**—over 40 pages. \$5.00. Triple-C Publishing, P.O. Box 699A, Demopolis, Alabama 36732.

"HOW to Debug BASIC Programs." \$6 PP. MBG. TIS, Box 921, Dept. CE 12, Los Alamos, NM 87544.

RUBBER STAMPS

RUBBER STAMPS, BUSINESS CARDS. Free catalog 1-800-851-4945, Jackson's, E-100, Brownsville Rd., Mt. Vernon, Ill. 62864.

GAMES

ATTENTION-VIC20 SOFTWARE! Writer for a free catalog: **ORA**, 22 Georgia Avenue, Providence, RI 02905.

MISCELLANEOUS

VOLUME II PIES, send \$3 & BSASE (40*). Recipes, P.O. Box 396, Hubbard, TX 76648.

SUCCEED WITH WOMEN! Famous Symphony Catalog **FREE!** Over 40 books/cassettes to make you a hit with the ladies. **SYMPHONY CATALOG**, Dept. ZD, Box 515, Tenafly, NJ 07670.

RETAIL ROSTER

CALIFORNIA

P.C. COMPUTERS, 10166 San Pablo Ave., El Cerrito 94530. (415) 527-6044. Commodore 64, VIC-20, Pet Specialists. In-House Maintenance.

CONNECTICUT

C&E DISTRIBUTING—Edgewood Drive, Jewett City 06351 (203) 423-0657. Retail outlet and wholesaling for dealers.

NEW HAMPSHIRE

COMPUTER MART of NEW HAMPSHIRE, 170 Main Street, Nashua 03060. 603-883-2386. **THE APPLE SPECIALISTS.** Full line Hardware/Software. Training/Service.

WASHINGTON

LYNNWOOD-MEDIA MAN—18500 33rd W., Suite B-2 (98036) (In the Alderwood Plaza), 206/775-8544. Software and supplies for Apple, Atari, IBM, Commodore.

FREE CATALOG!

Send for your **FREE Creative Computing** Catalog of books, buyer's guides, and more! Write to

Creative Computing Catalog
Dep NA 1 X 39 East Hanover Ave
Morris Plains, NJ 07950

Computer Mart

RATE: Ads are "by 3". 1 insertion: \$935.00. 6 insertions: \$900.00 ea. 12 insertions, \$865.00 ea. Closing date: 1st of the 2nd mo. preceding cover date. Send order and remittance to Computer Mart, Computers & Electronics, 1 Park Ave., N.Y., N.Y. 10016. Direct inquiries to (212) 725-4215.

ATTENTION!
Superstars of the Future
As a firm representing such fine artists as: Harry Blackstone, Jimmy Walker, Rupert Holmes, Richie Havens, Sherman Hemsley, Beatlemania, Blood, Sweat & Tears and many others, we have realized that the **INCREDIBLY TALENTED ARTISTS** of the software industry desire and need expert representation.

Whether you have already received acclaim or are a budding new artist, please call or write so that we may discuss your potential further.

Contact: Valerie Koob Ass't. to the President
Software Superstars Management
Div. of Spolite Entertainment Enterprises, Ltd.
221 West 57th Street, New York, N.Y. 10019
(212) 586-6750 TELEX 640552 SPOTLITE NYK

Spolite Enterprises Limited

CIRCLE NO. 138 ON FREE INFORMATION CARD

A/D 8 channels + D/A 8 channels



APPLY YOUR MICRO TO ANALOG SIGNAL PROCESSING & CONTROL
Connects to μ processor buses of most Z80 & 8502 computers including Timex, TRS-80, Apple, CBM 64. Our pin rearrangement feature eases interfacing **FAST:** 200,000 samples per sec with Z80A
EASY TO PROGRAM: One PEEK chooses the channel, starts conversion & gets data. Routines provided
SOFTWARE AVAILABLE: FFT in Z80 256 points in one second! storage scope for Time
LOW COST: Assembled & tested \$195. Cable \$15. Please call or write for free catalog

Computer Continuum
301 Sixteenth Avenue
San Francisco, CA 94118 (415) 752-6294

CIRCLE NO. 139 ON FREE INFORMATION CARD

Home Control System for the VIC 20



VIC controller

- * Control up to 256 lights & appliances
- * ON OFF ALLON ALLOFF Commands
- * 9 levels of Brightness
- * Manual & Time Control Software
- * Uses BSR remote switches
- * Plugs into User Port

only **\$59⁹⁵**
MasterCard or VISA Accepted
Call 215 861-0850 to Order
GENESIS COMPUTER CORP.
1444 Linden Street
Bethlehem, PA 18018

CIRCLE NO. 140 ON FREE INFORMATION CARD

Computer Mart

RATE: Ads are " by 3". 1 insertion: \$935.00. 6 insertions: \$900.00 ea. 12 insertions, \$865.00 ea. Closing date: 1st of the 2nd mo. preceding cover date. Send order and remittance to Computer Mart, Computers & Electronics, 1 Park Ave., N.Y., N.Y. 10016. Direct inquiries to (212) 725-4215.

SPEECH SYNTHESIS **NEW!** SAVE \$5 ONLY **\$59** KIT

TR80 ZX81 TIMEX VIC20 APPLEII

• UNLIMITED VOCABULARY \$39
• AMPLIFIER + SPEAKER BUILT
• INPUT FOR TAPE - MUSIC UNITS

SMART EARS! **SPEECH RECOGNITION** **\$99**

SPEECH INPUT FOR ABOVE LISTED COMPUTERS & OTHERS CALL (SOME NEED I/O)

Hugely successful Speech Recognition System, complete with microphones, software and full instructions. BUILT TESTED & GUARANTEED

MUSIC SYNTHESIS **STEREO 16 LINE CONTROL PORT** **PLAY 3 PART MUSIC, EFFECT, DRUMS ECT.** **1/0 PORT TO CONTROL ROBOT, 649KIT** **HOME SECURITY FARM ECT BUILT \$39**

AUDIO VISION 1279 N. NORMANDIE LOS ANGELES, CA 90027 **SPEECH CHIP SX-01 \$36** **ADD \$3 SHIPPING** **CALL (213) 860-8217**

CIRCLE NO. 98 ON FREE INFORMATION CARD

64K for VIC 20 **SELECT-A-RAM**



SELECT-A-RAM **STANDARD FEATURES**

- 8K BLOCKS SELECTABLE FROM THE KEYBOARD OR BY SOFTWARE COMMAND
- TWO EXPANSION SLOTS
- WRITE PROTECTION
- EXPANSIBLE TO 128K WITH ADDITION OF 44K EXPANSION MODULES
- COMPATIBLE WITH NEW CARETAGES
- ONE YEAR WARRANTY ON PLAYS AND LABOR
- 15 DAY MONEY BACK GUARANTEE

SELECT-A-RAM \$100
44K EXPANSION MODULE \$110

TRADE INS ACCEPTED
IN \$1. 20 \$110. 100 \$300

WE ACCEPT TRADE IN OF COMMODORE, ELECTRONIC, APPLE, ATARI AND IBM AND ARE TRADE MARKS OF ATARI INC.

512-441-3202 PO BOX 43006 Austin, Tx. 78745-0001

AP5-52A **52K MEMORY FOR ATARI 400/800** \$119.00

The AP5-52A memory expansion board (also advertised) and tested with a 90-day warranty covering hardware and supporting boards, come with complete documentation including operation and installation instructions and a memory test program.

100% TRADE INS ACCEPTED \$19.00

ATARI AND IBM ARE TRADE MARKS OF ATARI INC.

JKK **ADVANCED PROCESSOR SYSTEMS**

CIRCLE NO. 99 ON FREE INFORMATION CARD

TRS-80 DISCOUNT COMPUTERS

CALL US LAST for the **LOWEST** price!



918-825-4844
it will be worth the call!

AMERICAN BUSINESS COMPUTERS Small Business

118 S. MILL ST. PRYOR, OK. 74361

CIRCLE NO. 100 ON FREE INFORMATION CARD

PRINTER STAND or DESK

• Size, 27h x 24d x 27" w.
• Black Painted Steel
• Sh. Wt. 75 Lbs.
• Shipped Freight Collect
• Use Order No. 2A70585 **\$39.95**

FAN CONTROL Controls Speed Of AC MOTORS!

ONLY **\$3.88** 3 for 10.00

Muffin Fans, Caravel Fans, Blowers, ETC... Good for 115/220 VAC up to 6 amps stall current. Control rated at 1.6 amps. Size: 1 1/2 x 2 x 1 1/2" Shaft mounting. Use Order No. 3BS0269.

BNF Enterprises **Free!**

119r FOSTER St. Peabody MA 01960 (617) 531-5774 40 Page Catalog

Customer Pays All Shipping Charges.

CIRCLE NO. 101 ON FREE INFORMATION CARD

Best Prices On TRS-80 Computers

Our 6th year of discounts Ed or Joe McManus Fgt. Prepaid. Save Tax. Toll Free 800-231-3680

Marymac Industries, Inc.
22511 Katy Fwy., Katy (Houston) Tx 77450
1-713-392-0747
Telex 774132

See us in the Wall Street Journal every Tues. Wed Thurs

HAVING LOADING PROBLEMS ?

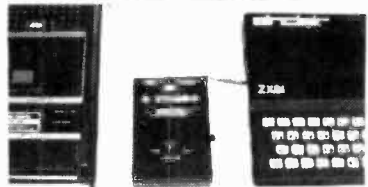

GET A Z-DUBBER

Because of the great variation in cassette recorders used with the ZX80 & ZX81, some in very poor shape, you may be having a hard time loading cassette programs. The (Z-Dubber) connects between the cassette recorder and the computer and its circuitry produces a much better signal for the computer to read. The (Z-Dubber) also allows you to connect two cassette recorders together to make perfect backup copies. This Z-Dubber can be yours for \$11.95 post paid. Add \$2.10 for shipping outside the US. Canada & Mexico.

CHARGE OR COD ORDERS CALL 1-800-227-3800
ASK FOR OPERATOR 225

BYTESIZE MICRO TECHNOLOGY PO BOX 12309 DEPT. C/J SEATTLE, WA 98111 (206) 236-BYTE

CALL OR WRITE FOR DEALER INFORMATION

CALL US for Medical Systems

Below are just a handful of our special features.

- **AMA Claim Form**
- **Multiple Providers**
- **Superbill**
- **RVS/ICDA Codes**
- **Private A/R Aged**
- **Manual and Training Systems Available**

Medical systems available for the Apple, IBM, TRS-80 and Wang Personal Computers.

Also, inquire about our Construction, Dental, Accounting and Educational Administrative programs.

CMC

MICRO COMPUTER DIVISION
55722 Santa Fe Trail Yucca Valley, CA 92284 (619) 365-9718

CIRCLE NO. 102 ON FREE INFORMATION CARD

COMMODORE 64-VIC TIMEX

Printer Packages

Includes: Printer, Smart Interface, Cable, and Paper

40 Col. Thermal Printer
Commodore 64-VIC \$149.95
TIMEX 1000.1500.2068... \$98.95
Extra Paper \$5.95/3 Rolls

80 Col. Thermal Printer
Commodore 64-VIC \$199.95
Extra Paper \$10.95/2 Rolls

80 Col. Gorilla Printer
Commodore 64-VIC \$299.95
TIMEX 1000.1500 \$294.95
Extra Paper \$39.95/Case

To Order: Include \$6.95 Shipping in the U.S.A. Foreign customers call or write for shipping charges. VISA and Mastercard accepted. Include exp. date. We carry a complete line of Commodore/TIMEX items. Write for our free catalog. Foreign, include \$2.00 postage.

Copyright 1983 by **E. Arthur Brown Company**
Dept. C1E 1702 Oak Knoll Drive Alexandria, MN 56308 612/762-8847

CIRCLE NO. 103 ON FREE INFORMATION CARD

SAVE 90%

IBM Machine with a 40% plus in performance-8086 based system with 128KB memory two RS232 Ports plus a Centronics Port for ~\$235 Upgradable!

CPM Machine-4MHz Z80A based 64KB memory, two RS232 Ports for ~\$120.00

16/32 bit commercial workhorse a 68000 based, 128KB memory three RS232 Ports for ~\$265 Expandable!

Floppy Interface \$60, 25 x 80 CRTs \$200, Software, Boards ROMs, Parts and MORE!

FREE CATALOG

DIGATEK CORPORATION
SUITE 7
2723 West Butler Drive
Phoenix AZ 85021

Why waste money on a Commodore, Atari, TI, etc. when a system with a future costs less?

CIRCLE NO. 104 ON FREE INFORMATION CARD

COMPUTER FURNITURE

CD 3624

PS 3024



Genuine Oak

Veneer \$89.95 Each

Completely Finished — Ready for Use
Excellent for Student, Home or Office

Send name and address with check or money order for \$89.95 per unit. Specify model no. Add \$15.00 for castors. Include \$10.95 for prompt shipping. Mail to: C.F.M.

P.O. Box 520652 • Salt Lake City, UT 84152



MONEY BACK GUARANTEE

A Division of
Timeless Computer Furniture Manufacturers

CIRCLE NO. 105 ON FREE INFORMATION CARD

Apple Compatible Drives

\$195

Includes:

- 40 TRK, 163 K Drive
- Cabinet & Cable
- Free Shipping
- 6 Month Warranty

Free Shipping

Order Toll Free:



1-800-531-5475 (Outside Of Texas)
(512) 250-1489 (In Texas)

CompuAdd Corp

13010 Research Blvd., Suite 101
Austin, Texas 78750

CIRCLE NO. 105 ON FREE INFORMATION CARD

EPROM ERASER \$39.95 EPROM PROGRAMMER \$146



ERASER

- contains same features as competitor's but cost less than one-half their price
- erases up to 9 chips
- 6 mW/cm² on chips
- chip drawer prevents UV exposure to users
- long life UV tube

PROGRAMMER

- PROGRAMS & COMPILES: 2516, 2532, 2716, 2732, 2732A.
- 4K INTERNAL RAM FOR FIRMWARE CAPACITY.
- NO PERSONALITY MODULE REQUIRED.
- POWER CAN BE REMOVED FROM ZIF SOCKET WHEN LOADING EPROMS.
- BINARY ADDRESS AND DATA DISPLAY.
- INDEPENDENT UNIT — VERIFIES PROGRAMS, INPUTS DATA FROM BINARY KEYBOARD, LOADS DATA FROM EPROM TO RAM, AND CHANGES ANY BIT OF DATA.
- FULL 90-DAY GUARANTEE ON ALL PRODUCTS FOR ANY DEFECTS IN MATERIALS AND WORKMANSHIP.

ANGO ELECTRONICS CORP.
P.O. BOX 112 HARRISON, NJ 07029 TEL: 212-685-6336

MAIL ORDERS: PLEASE ADD \$3.00 HANDLING CHARGE NEW JERSEY RESIDENTS: PLEASE ADD 6% SALES TAX

CIRCLE NO. 106 ON FREE INFORMATION CARD

It's simple. . . .
CALL & SAVE MONEY

1-800-841-0860

Commodore 64

DRIVES • PRINTERS
MONITORS • SOFTWARE
CALL FOR BEST PRICES

TRS-80 FRANKLIN

COLUMBIA EPSON

Albert SMITH
CORONA

MICRO MANAGEMENT SYSTEMS

TELEMARKET DEPT. #12
2803 THOMASVILLE RD. EAST
CAIRO, GEORGIA 31728
GA. & INFO 912-377-7120

CIRCLE NO. 107 ON FREE INFORMATION CARD

PROMPT DELIVERY! AND
TRY TO BEAT THESE IC PRICES:

DYNAMIC RAM		
64K	200 ns	\$ 5.40
64K	150 ns	5.62
64K	120 ns	6.06
16K	200 ns	1.56
EPROM		
27128	300 ns	\$19.20
2764	250 ns	5.99
2732	450 ns	3.89
2732A-2	200 ns	7.70
2716	450 ns	3.31
2532	450 ns	4.60
STATIC RAM		
6264P-15	150 ns	\$38.00
6116P-3	150 ns	4.79
6117P-3	150 ns	4.20

Prices 9/15/83

MasterCard VISA or UPS CASH COD
Factory New, Prime Parts
MICROPROCESSORS UNLIMITED
24,000 South Peoria Ave. (918) 267-4961
BEGGS OK 74421

Prices subject to change. Please expect higher prices on some parts due to world wide shortages. Call for volume prices. Subject to available quantities. Shipping & Insurance extra. Cash discount prices shown. Federal Express is \$5.99.

CIRCLE NO. 108 ON FREE INFORMATION CARD

TS1000 ZX81



3-Color Keyboard Symbols with Conversion Instructions

- Plastic TS1000-ZX81 keyboard symbols in Black, Red and Blue. Opaque background. Will fit all standard-size keys. Adhesive backing for easy application.
- Simple illustrated instructions will show you how to convert a cheap (about \$20) surplus keyboard to a full-size TS1000/ZX81 console. "...as easy as stringing wire on a fence."
- Do's and Don'ts for selecting a surplus keyboard.
- Bonus for the "pro" - Schematic Diagram of Computer.

MULE Electronics \$12*

Dept. 310
444 Lincoln Blvd.
Venice, California 90291

*Add \$1.50 P&H. California residents add 6.5% tax. Money-back guarantee, of course.

CIRCLE NO. 109 ON FREE INFORMATION CARD



\$9.95

FITS KEYBOARDS UP TO 14.25" x 5.5"

FOR USE WITH MOST MICRO COMPUTERS

APPLE ATARI COMMODORE TEXAS INSTRUMENTS TRS-80...

- PAYMENT ENCLOSED \$_____ * Add \$1.00 per order for postage and handling. Outside USA add \$2.50 per unit ordered, send US funds only Visa MasterCard



P.O. BOX 7008
ROSEVILLE MI 48305
1-800-732-0614

Michigan Residents Add 4%

CIRCLE NO. 110 ON FREE INFORMATION CARD

NEW \$99 DISK DRIVE TEST KIT for KAYPRO 2†

Test it yourself and save money. At last, an easy to use drive test kit for owners of Kaypro 2. Don't wait until you get DDOS ERROR! Our \$99 kit will save you time and let you use your Kaypro 2 confidently!

Now you can know exactly how good or bad your disk drives are doing. This is imperative when you wish to exchange data with other Kaypro 2 users. In less time than it takes to make an omelette you can perform these four important tests on any Kaypro 2.

SPINDLE CONE CENTERING
SPINDLE SHAFT SPEED
INDEX SENSOR TIMING
HEAD RADIAL POSITION

Here is the best part. You do not have to open the case nor need expensive equipment! See your Kaypro 2 screen become a bright graphic drive test display!

Order now and receive our TEST program disk and a special DDD (Digital Diagnostic Disk) †† You also get a thick service manual for your disk drives and our own easy to read Drive Diagnostic Users Guide. We even put in photos and gadgets to help you adjust or repair either disk drive yourself.

We pay postage in North America. COD orders please add \$2. Check/Money Order/VISA/MasterCard. Calif. add 6% tax. Phone Mon.-Sat. 9 a.m. to 9 p.m. Pacific Time.

Sheephead Software™
P.O. Box 486
Boonville, CA 95415
(707) 463-1833

† Available only for Kaypro 2, not for Osborne 1.
†† DDD is Copyright of Dysan Corp.

CIRCLE NO. 111 ON FREE INFORMATION CARD

QUADRA-SCOPE™

4 CHANNELS WITH A SINGLE TRACE SCOPE

- EZ HOOK LEADS
- 4 CHANNEL MULTIPLEXER
- RANGE : 9 VOLTS
- USE ON ANALOG AND DIGITAL SIGNALS
- SOLID STATE RELIABILITY
- 1 MEGOHM INPUT IMPEDANCE
- COMES WITH 110 VAC POWER SUPPLY

Send \$49.95 plus \$2.50 shipping and handling (Check or M.O.) to

EACO, INC.
PO BOX 2962
RICHMOND, VA
23235

CIRCLE NO. 112 ON FREE INFORMATION CARD

**ATTENTION APPLE
LOVERS**
100% APPLE COMPATIBLE

DISK DRIVE \$199.
DUAL DISK CONTROLLER \$ 49.
Z-80 BOARD \$ 85.
80 COLUMN BOARD \$159.

MONITORS

ZENITH ZVM 121
12" Green Screen \$ 89.
AMDEK COLOR I+
13" Color \$289.

FREE BROCHURE

**!!CALL US FOR
LOWEST PRICES ON
OTHER ACCESSORIES!!**

XICOM COMPUTER PRODUCTS
414 B. West Fifth Street
Naperville, Illinois 60566
(312) 961-1616

MC, Visa

CIRCLE NO. 131 ON FREE INFORMATION CARD



The new Series V Digital/Analog Keyboard Controllers from PAIA offer enough standard features and options to fill every need from stage to studio. Standard features include Pitch & Modulation Wheel, Gate and Re-trigger outputs, Low Note Hute -Priority, Smooth Pratt-Read Action, Light weight and only 2" high.

You have your choice of:

- 37 or 61 Note Actions
- Exponential Or Linear C.V.
- MIDI or Parallel Digital
- Mono or Poly
- Factory Assm. or Low Cost Kits

Best of all, prices start at less than \$120

**call our toll-free line for price
& ordering details & get your free
PAIA catalog! 1-800-654-8657**

9am to 5pm cst mon-fri.

Direct mail orders and inquiries to: Dept. 11P

PAIA Electronics, Inc.

1020 W. Wilshire, Oklahoma City, OK 73116 (405) 843-9626

CIRCLE NO. 132 ON FREE INFORMATION CARD

POWER LINE PROBLEMS?



SPIKE-SPIKERS™... The Solution!

Minimize equipment damaging spikes and conducted RF noise to or from sensitive equipment. Transient surge protection plus low pass RFI hash filtering. All units 120V 15A

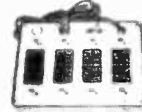

MINI II \$44.95

Wall Mount
3-stage filter
2 sockets

QUAD II \$59.95

Wall mount, Dual 3-stage filter
4 sockets & light



DELUXE \$79.95

Dual 5-stage filtered
ccts. 8 switch sockets
main switch, fuse, light

Kaiglo Electronics Co., Inc.

65 84 Ruch Rd. Dept. C E
Bethlehem, PA 18017

Order Factory Direct

215-837-0700

Out of State
800-523-9685

DEALERS INVITED

PA Res. Add 6% * COD add \$3.00 + Shipping

CIRCLE NO. 133 ON FREE INFORMATION CARD

**TRS-80
COMPUTER
DISCOUNTS**

- Factory Direct
- Best Prices Anywhere
- No Out-of-State Taxes
- 100% Radio Shack Warranty
- Free Price List
- Authorized TRS-80

**SCOTT TASSO
ASSOCIATES**

175 North Delsea Drive
Vineland, N.J. 08360
800-257-0426

NJ 609-691-7100

CIRCLE NO. 134 ON FREE INFORMATION CARD

**VIC-20
— SOFTWARE —**

Did you know that you can transfer just about any software on expansion ROM cartridges for the VIC-20 onto cassette tape or disc for your own use?

Well, with our board, which plugs into the VIC-20 expansion port and 8k or 16k of expansion RAM, you can copy games (Sargon Chess™), programming aids (VICMON™), music, word processors, and just about anything else on expansion cartridges, for about the price of one cartridge!

only **\$34.95** (postage paid in cont. us)
Calif. Res. add sales tax.

nimrod computer

3823 OCEAN VIEW BLVD.
MONTROSE, CA 91020, SUITE 433

CIRCLE NO. 135 ON FREE INFORMATION CARD

PLEASE....

Give us a chance to save you the largest amount possible on...

TRS-80 PRODUCTS

Get your Best Price

Then...



Call Us At:

1-800-762-6661

Rand's

COMPUTER CORNER

101 Fry Blvd. Sierra Vista

Instate: (602) 488-4080

**COMMODORE
OWNERS!**

New Release From
Home Software Co.

FILE MASTER-PLUS

EXTENDED ALL-PURPOSE FILING PROGRAM

- flexible file design
- completely menu driven
- cue/response oriented
- selective totaling
- selective printing
- easy data modification
- 'star search' accessing

49.95 TAPE - 52.95 DISK

FREE BROCHURES

Home Software Co.
P.O. Box 206
Bridgewater, VA
(703) 434-8418

..... for useful home software

CIRCLE NO. 137 ON FREE INFORMATION CARD



Scotch

DISKETTES

Call Toll-Free

1-800-328-DISC for prices and information. Dealer inquiries invited. C.O.D. and charge cards accepted.

All orders shipped from stock, within 24 hours. Call toll FREE



North Hills Corporation

4-64 Rolling View Dr.
White Bear Lake, MN 55110
1-800-328-DISC

MN Call Collect 1-612-770-0485

**COMPUTER MART
FORMAT
2" X 3"**

PICTURE YOUR AD HERE!

**NEXT CLOSING DATE:
NOV 30**

CONVERT YOUR TV TO A HIGH QUALITY MONITOR



USE WITH COMPUTERS, VCR's & CAMERAS

Kit permits Dual Mode operation on B&W or Color sets

- Hi-Resolution • Up to 80 characters per line • Wide bandwidth • Direct Video • Safe-Easy installation

34⁹⁵ ACVM

DVM-1 Hot Chassis kit with Audio available. Send for complete Audio/Video equipment catalog.

VAMP Inc.
Box 411, Los Angeles, CA 90028
(213) 466-5533

CIRCLE NO. 113 ON FREE INFORMATION CARD

MODULES FOR TIMEX-Sinclair NEW MD-2 DIRECT CONNECT MODEM

\$119⁹⁵ Kit
\$149⁹⁵ W&T

with New SMART Menu Driven, SOFTWARE Included FREE

- Send & Receive Programs by Phone
- Copy Information Into Memory, Print It, Review It, Save It On Tape, Send Text From Memory
- Use Timex 2040 Printer or Any RS-232 Printer
- RS-232 Printer Port Provided
- No Extra Memory Required, But With 64K Memory You Can Store Up To 60 Full Screens

RS-232 Printer Interface \$59⁹⁵ Kit \$69⁹⁵ Ass
BB-1 Control Module: 8 Relays 8 TTL Inputs \$69⁹⁵

UM-64 64K Memory
Battery Backup, Prom/Rom Socket, Reset Sw. Plus Exclusive Feature: Copy the Timex Rom into the 0-8K Area of Ram, flip a Sw. & operate out of RAM. MODIFY it to suit your needs. Add new commands \$119⁹⁵ Kit \$129⁹⁵ Assembled

Gorilla/Banana Printer Discounted to only \$239⁹⁵
See "Leading Edge" Ad in this magazine

BYTE-BACK CO. Rt. 3 Box 147 Brodie Rd.
Leesville, S.C. 29070 Ck. COD VISA M/C AM EXP
Ph. 803-532-5812 Add \$4.95 shipping to all orders
10 day money back guarantee plus 90-day warranty

CIRCLE NO. 114 ON FREE INFORMATION CARD

GET THE MOST FROM YOUR VIC-20/C64

CASSETTE INTERFACE

- USE ANY STANDARD CASSETTE RECORDER
- CONNECTS TO THE CASSETTE PORT
- CONTROLS THE CASSETTE MOTOR
- NEEDS NO BATTERIES
- COPY FROM RECORDER TO RECORDER
- THIS IS THE BEST ONE FOR LESS \$\$\$
- ONLY \$4.95 POSTPAID, ADD \$2.50 FOR SHIPPING OUTSIDE US (CANADA, MEXICO)



THE MODEM INTERFACE

- OPERATES TO THE USER I/O PORT
- NEEDS NO BATTERIES/SOLDERING
- CONNECTS ANY STANDARD MODEM
- USES AN IN-BOARD AUTOMATIC ANSWER FEATURES
- COMES WITH A FREE TYPE IN BASIC TERMINAL PROGRAM
- ONLY \$4.95 POSTPAID, ADD \$2.50 FOR SHIPPING OUTSIDE US (CANADA, MEXICO)



CHARGE OR COD ORDERS CALL 1-800-227-3800

ASK FOR OPERATOR 225

BYTESIZE MICRO TECHNOLOGY PO BOX 12309 DEPT. CJ
SEATTLE, WA 98111 (206) 236-BYTE

CALL OR WRITE FOR DEALER INFORMATION

\$1,250.00 FRANKLIN SYSTEM

SYSCOM II (Apple Compatible) \$ 550
APPLE IIe SYSTEM \$1,675
FRANKLIN 1200 \$1,599

*APPLE TYPE DRIVE \$ 180.

128 K Card \$ 250
GEMINI 10 \$ 300

FREE BROCHURE
**!!WE WILL BEAT
ANY PRICE!!**

SOFTSELL SYSTEMS
P. O. Box 18928
Philadelphia, Pa. 19119 (215) 665-5639
Visa, MasterCard preferred or C.O.D.
Apple is a trademark of Apple Computer

CIRCLE NO. 115 ON FREE INFORMATION CARD

PROTECT YOUR COMPUTER FROM DESTRUCTIVE POWER LINE SURGES

Surges—momentary variations of thousands of volts strike daily on your home AC power line. Unchecked surges can disrupt normal computer operation and damage hardware.

Now, CUTS Company offers surge protectors engineered specifically for personal computers.

- Both models protect your system from losing memory, misregistering programs, and blowing out components
- Both models contain a unique three-stage filter that clamps, limits, and dissipates incoming surges instantaneously for reliable and effective surge protection.
- Both models are compatible with all makes of computers and accessories

DON'T DELAY—PROTECT YOUR INVESTMENT NOW, ORDER TODAY:

SURGE BLOCK (shown) Portable protected dual outlet that plugs into any 3 wire outlet. Includes neon light that monitors protector and ground path. 125v 10A. \$29.95

SURGE BUS Five outlet, surge protected plug strip with 6 power cord, includes line fuse, On/Off switch with pilot light in a sturdy steel case. 125v 10A. \$49.95

• 12 Month Warranty on all Products

Specify model, send name, address and check or M.O. to include \$2 postage (NY Res. add Sales Tax) to
PO. Box 6918
SYOSSET, N.Y. 11791
(516) 921-2327



CIRCLE NO. 116 ON FREE INFORMATION CARD

TRS-80+ MOD I, III, COCO, T199/4a
TIMEX 1000, OSBORNE, others

GOLD PLUG - 80

Eliminate disk reboots and data loss due to oxidized contacts at the card edge connectors. GOLD PLUG 80 solders to the board edge connector. Use your existing cables. (if gold plated)

GOLD PLUG 80 Mod I (6)	\$54.95
Keyboard/EI (mod I)	18.95
Individual connectors	9.95
COCO Disk Module (2)	18.95
Ground tab extensions	1.00
Disk Drives (all R.S.)	9.95
Gold Disk Cable 2 Drive	29.95
Four Drive Cable	39.95
GOLD PLUG 80 Mod III (6)	54.95
Internal 2 Drive Cable	29.95
Mod III Expansion port	10.95
USA shipping \$1.45	
Foreign \$7.	Can/Mex \$4. TEXAS 5% TAX

E.A.P. CO.
P.O. BOX 14
KELLER, TEXAS 76248
(817) 498-4242

MC/VISA
+ trademark Tandy Corp

Join the Click!

FOR FASTER & EASIER DATA ENTRY
WITH YOUR I/O KEYBOARD

Meet just a few of the replacement I/O keyboards available from E-Z Key. All keyboards feature a unique, ergonomic design that allows you to type with ease and comfort. The I/O keyboard is the only keyboard that features a unique, ergonomic design that allows you to type with ease and comfort. The I/O keyboard is the only keyboard that features a unique, ergonomic design that allows you to type with ease and comfort.

IT'S THE ONLY KEYBOARD WITH ALL OF THE FOLLOWING:

- 80 character keyboard with numeric keypad
- Ergonomic design with the best angle possible for your hand
- Multiple support (20 different ways to hold it)
- A lightweight design (no shifting, no strain on your hands)
- A quiet design (noisy, noisy, noisy... no more)
- A sturdy design
- A clean design
- A simple design (no complicated controls)
- A simple design (no complicated controls)

\$84.95
80 day warranty

Free literature of the product line. \$10 off the purchase of 3 keyboards. \$15 off the purchase of 5 keyboards.

E-Z KEY
North Hills Corp.
211 Southern Bldg.
Channah, Mississippi 39218
(601) 779-1147

GOT A TS-1000? GET STARTED WITH BOSS SOFTWARE

DISCOUNT

CASSETTE PROGRAMS FOR THE TIMEX 1000/1500 COMPUTERS

GAMES, BUSINESS, EDUCATION, TUTORIAL

ALSO

START YOUR OWN SOFTWARE COMPANY ON A SHOELSTRING. DUPLICATE 1 TO 50 CASSETTES WITH THE DIGITALIZER AMPLIFIED CLEAN COPY OUTPUT, EXPENSIVE, PROFESSIONAL CASSETTE DUPLICATING EQUIPMENT AND WE SHOW YOU HOW!

WRITE FOR FREE CATALOG

EULYN ENTERPRISES
4N 650 RIDGEWOOD
BENSENVILLE, ILL., 60106
(312) 832-1599

CIRCLE NO. 116 ON FREE INFORMATION CARD

maxell®

Floppy Discs

CALL NOW - TOLL FREE 1-800-328-DISC

Dealer inquiries invited. C.O.D.'s and charge cards accepted.

All orders shipped from stock, within 24 hours. Call toll FREE.



North Hills Corporation
3564 Rolling View Dr.
White Bear Lake, MN 55110
1-800-328-DISC
MN Call Collect 1-612-770-0485

WE SELL TIME!

TIME FOR DECISIONS. TIME FOR LEISURE. YOUR TIME. ISA's software gives it back to you.

SUPER™ DATABASE - \$199.00

- EASY! FAST!
- General purpose business program DBMS

ManageMint™ — \$395.00 & up.

- PERT/CPM project control system

(Both menu driven for IBM PC, CPM & all TRS-80)

INSTITUTE FOR SCIENTIFIC ANALYSIS
P.O. BOX 7186, DEPT. C-1
WILMINGTON, DE. 19803

(215) 358-3735 / orders only (800) 441-7860
M.C. & VISA accepted

CIRCLE NO. 117 ON FREE INFORMATION CARD



LEO ELECTRONICS, INC.
8921 S. Sepulveda • 208
Los Angeles, CA 90045
(213) 641-3101 (800) 421-2418
TLX: 664-688 Interline LSA

LOOK!! LOW PRICES

RAMS		EPROMS	
4116 (200ns)	1.10	2708	2.50
4116 (150ns)	1.25	2716	3.20
4164 (200ns)	4.65	2716-1	5.00
4164 (150ns)	4.85	TMS 2716	4.75
2114 (200ns)	1.50	2732	3.95
6116P-3	4.25	2532	4.50
		2764	8.00
MICROPROCESSORS		REGULATORS	
Z-80A	4.50	ALL	.75
8080A	2.75	TO-220	
8085A	6.00		

TERMS: Check, Visa, Mastercard. Call for C.O.D.
U.S. Funds only. California residents add 6% sales tax.
SHIPPING: Add \$2.00 for Ground and \$5.00 for Air.
ALL MAJOR MANUFACTURERS
ALL PARTS 100% GUARANTEED
Prices subject to change without notice.

CIRCLE NO. 118 ON FREE INFORMATION CARD

BUSINESS SOFTWARE PACKAGE

\$59

Reg. \$159

Features:

- Accounting Ledger
- Inventory Control
- Letter Writer
- Mail-Out

For TI-99 VIC-20
ATARI COM-64

Toll Free 1-800-221-7171
In Ga. 1-404-925-4686

BIZWARE, INC./5014 Hwy. 29/Lilburn, Ga. 30247

CIRCLE NO. 119 ON FREE INFORMATION CARD

Put 64K CP/M 2.2 in your TRS-80 Model III.

Our plug-in Shuffleboard III comes with 16K and gives you the full power of 64K CP/M 2.2, the industry standard operating system.



Tap into over 2,000 off-the-shelf business programs such as dBASE II, SuperCalc, WordStar, etc.

READ/WRITE and RUN software from Osborne, Xerox, Superbrain, Kaypro II, HP 125 and TeleVideo. You can even READ/WRITE IBM PC software for CP/M 86.

Simple to install. Shuffleboard III plugs into two existing sockets inside your Model III. No permanent modifications, no cut traces, no soldering. You'll be up and running in minutes. For only \$299. Includes MBASIC Interpreter, a software manual and a first class user's manual. Coming soon: an 80 x 24 Video Board and a Floppy Disk Controller.

See the Shuffleboard at your local computer store or order directly from us. Credit card orders shipped directly from stock. Sorry, no COD's. Free 12 page brochure. Call (415) 483-1008

Memory Merchant

14888 Opacville Drive

\$299.

San Leandro, CA 94577

CIRCLE NO. 120 ON FREE INFORMATION CARD

Get more out of your Apple with the MICRO on the Apple Series

Vols. 1, 2, & 3 **\$24.95**
+ \$2.00 shipping each volume

Each book includes more than 30 programs —
all on DISKETTE

Machine Language Aids
I/O Enhancements
Runtime Utilities
Graphics & Games
Hardware & Reference
Information

To order toll free:

1-800-345-8112

In PA 1-800-662-2444

MICRO INK, Dept. CE

P.O. Box 6502

Amherst, NH 03301

603-889-4330

CIRCLE NO. 121 ON FREE INFORMATION CARD

Now we can make any computer sing as well as talk, for only \$219.



As featured in Garcia's
Circuit Cellar
"BYTE" Magazine,
September,
October 1982.

Microvox.

- MICROVOX is a completely self contained professional voice quality text-to-speech synthesizer. MICROVOX may be easily interfaced to any computer, modem, RS-232C serial or parallel output device.
- 1602 Microprocessor based text-to-speech algorithm
 - SE-01A phoneme based speech synthesizer
 - 64 crystal controlled inflection levels
 - 3000 character buffer
 - RS-232C and parallel port interfaces
 - On board power supply
 - Music and sound effects capability

MY01 Microvox Assembled & Tested \$299.00
MY02 Microvox, complete kit \$219.00



To Order: Call Toll Free
1-800-645-3479
In N.Y. 1-516-374-6793
MICROMINT, INC.
561 Willow Avenue
Cedarhurst, NY 11516

MICROSETTE

5 1/4-inch DISKETTES

- Single or double sided, all double density (SSDD, DSDD).
- Soft sector, reinforced hub.

CASSETTES

- Error-free computer grade.

ITEM	10 PACK	50 PACK
SSDD	\$25.00	\$100.00
DSDD	35.00	150.00
C-10	7.50	32.50
C-20	9.00	39.00
C-60	11.00	50.00
C-90	15.00	70.00

UPS SHIPPING INCLUDED
in Continental USA
CA Customers add taxes

MICROSETTE CO.
475 Ellis St., Mtn. View,
CA 94043 (415) 968-1604

CIRCLE NO. 122 ON FREE INFORMATION CARD

VIC-20

NEW

VIC-20 INTERFACING BLUE BOOK
Did you know that your VIC can be used to control a 99c toy motor so effectively that it runs like a precision machine? Or that you can build an accurate digital thermometer using the VIC and four parts costing less than \$5?
These and other 33 interfacing projects selected for usefulness, ease of construction and low cost are detailed in the VIC-20 Interfacing Blue Book, a veritable gold mine of practical information on how to build a variety of interfaces for your computer.
Projects include: Connecting VIC to your stereo; Pickproof digital lock; Capacitance meter; Liquid level sensor; Telephone dialer; Voice output; 8K/16K RAM/ROM expansion; 128K RAM expansion; 8-bit precision D/A; 8-bit A/D converter; MX-80 Interface and more.
Written by a college professor in a friendly and informative style, the Blue Book gives you theory of operation, schematics, program listings, parts list, construction hints and sources of materials for each one of the 30 projects.
If you want to get the most out of your VIC this book is a must. Cost is \$14.95 (less than 50¢ per project!). Price includes postage.

microsignal Dept 9
P.O. BOX 22
MILLWOOD NY 10546

VIC-20

SALES POWER

Computers & Electronics not only sells itself at a nice profit, it helps sell the hardware and software in your store too. Because it goes home with customers and continues to influence buying decisions long after you're closed for the day. Let's talk now.

CALL COLLECT:
(212) 725-7679

Or write:
Ziff-Davis Publishing
One Park Avenue
New York, NY 10016



Minimum order 10 copies. We pay all shipping costs.

**Radio Shack TRS-80™
Computers**

At Guaranteed Savings



from
Pan American Electronics

1117 Conway Ave.
Dept. CE
Mission, Texas 78572
Ph. 512/581-2766

Telex 767339
TO ORDER
CALL TOLL FREE
800-531-7466

Full Line
Computers
Printers &
Peripherals

CIRCLE NO. 123 ON FREE INFORMATION CARD



**KCS
ELECTRONICS
CORPORATION**

SEMICONDUCTOR PARTS & PRODUCTS

FACTORY PRIME DEVICES INCLUDE:
Capacitors — all types & styles • Chokes & Coils • Connectors
Digital & Linear IC's
Hardware & Accessories
IC Sockets • Memory
Resistors — fixed & variable • Transformers
Transistors & More



MANUFACTURERS SUCH AS: Motorola, National, NEC, J.W. Miller, Texas Instruments and more!

WE STOCK & SUPPLY DEVICES FOR: OEM's, Distributors, Hobbyists, Magazine Projects, Engineers, Schools, Technicians & You!

Send for **FREE Catalog** or Call:
(602) 274-2885 P.O. Box 33205
Phoenix, AZ 85067

CIRCLE NO. 124 ON FREE INFORMATION CARD

**TIMEX
SINCLAIR ZX81
\$99.95**

64K RAM PACK
No Ram Pack Wobble

REMEX
INTERNATIONAL

48945 VAN DYKE, UTICA MI 48087
Check or Money Order add \$5.00 s/h
Michigan residents add 4% tax



EXTENSIVE CATALOG AVAILABLE

CIRCLE NO. 125 ON FREE INFORMATION CARD

**R.I.S.T. Inc. ANNOUNCES
SPEECH
SYNTHESIZER**

ORDER NOW **SALE** ORDER NOW

\$59.95

ACT NOW Receive

Phrase Finder Program \$5 VALUE FREE
Speech Synthesis Manual \$10 VALUE FREE

Apple II, II+

TRS80 Models I, III
Commodore 64, VIC 20
ZX80/81 and TS1000
Regularly \$89.95 Now Only \$59.95
plus \$4.00 SH/HD EA.

Complete or Starter Kits Available
Inquire about our complete line
of TALKING Software Programs

Send check or M.O. COD add \$1.50 to: R.I.S.T. Inc.
Dept. GZ108, P.O. Box 499 Ft. Hamilton Station
Brooklyn, NY 11209 212-259-4934
N.Y.S. RESIDENTS ADD 8% TAX

CIRCLE NO. 126 ON FREE INFORMATION CARD

**Votrax™ SC-01A
SPEECH SYNTHESIZER**

\$42 Each (\$32 in hundreds)

Order in Ones or Thousands

The SC-01A Speech Synthesizer is a completely self-contained solid state device. This single chip phonetically synthesizes continuous speech of unlimited vocabulary.

Computer interfaces and text-to-speech algorithms also available for product development

Micromint is the largest U.S. distributor of the SC-01A. Call us for a price quote

Call 1-800-645-3479, in N.Y. 1-516-374-6793

MICROMINT INC.
561 Willow Avenue
Cedarhurst, NY 11516



Add \$2.00 for shipping & handling

CIRCLE NO. 127 ON FREE INFORMATION CARD

**THE ONE - THE ONLY
"THE BOX"**

New Innovation for TIMEX SINCLAIR users.

- Eliminates Save-Load Program troubles
- Saves time on Save-Load Programs
- Stops ground loops - Easy VU METER MONITOR
- Remote pause cassette switch
- Easy hook up between Computer and recorder (Pin plug cable included)

DOES NOT VOID TIMEX-SINCLAIR Warranty



Dimensions 3" x 2" x 4"

Send \$26.95 Check or Money Order To: SCONZO & SONS
724 Montauk Hwy., Bayport, NY 11705
M/C - VISA Call: (516) 472-1700 or (212) 297-0976
COD - ADD \$2.00 - Allow 4-6 week delivery
N.Y.S. Res. add sales tax
90 DAY GUARANTEE

CIRCLE NO. 127 ON FREE INFORMATION CARD

COMPUSETTE

- Precision 5 Screw Cassette
- Premium Quality Tape
- Labeled Both Sides
- Individually Boxed
- Freight Paid On All Orders
- Guaranteed Against Defects

	COMPUSETTE (5 MIN. PER SIDE)	COMPUSETTE+ (10 MIN. PER SIDE)
25	\$20.00 (80")	\$22.50 (90")
100	\$70.00 (70")	\$80.00 (80")
500	\$330.00 (66")	\$365.00 (73")

OUT OF STATE (800)527-1227
TEXAS (214)349-0081 C.O.D.





EACH CASSETTE INCLUDES A NORELCO CONTAINER

TEXAS RESIDENTS ADD 5% SALES TAX

BUY NOW SAVE 10%
IF CHECK OR MONEY ORDER ACCOMPANIES ORDER
GOOD ONLY IN THE CONTINENTAL UNITED STATES

P.O. BOX 38651 DALLAS, TX 75238

CIRCLE NO. 128 ON FREE INFORMATION CARD

TOROIDAL POWER TRANSFORMERS
Small size • Low noise • Easy mounting



Ideal for audio amps, CRT monitors and computers where low hum is required.

Includes mounting washer with center hole for screw.

A wide selection of toroidal power transformers for 117V 60Hz available from stock. Included are transformers in sizes below with dual secondaries 2 x 8.5V or 2 x 15V or 2 x 18V, your choice. (Rated current = Power/2 x Volts)

Power	Size OD x H	Net wt. lbs.	Price 1	Price ea. 24
20VA	2.4" x 1.2"	.7	\$24.30	\$20.40
40VA	2.8" x 1.3"	1.1	\$26.10	\$22.00
70VA	3.2" x 1.4"	1.5	\$27.90	\$24.20
100VA	3.7" x 1.4"	2.2	\$30.00	\$25.70
180VA	3.7" x 1.8"	2.9	\$34.60	\$29.30

Call to place order, or write for complete listing of US made off-the-shelf toroidal power transformers in sizes 20VA 600VA.

We custom make toroids 20VA-3,600VA

Terms: C.O.D. VISA MASTERCARD or Money Order
Shipping: Add \$1.00/lbs for UPS (- \$1.50 for C.O.D.)

1 (811) 459-8898 TOROID CORPORATION OF MARYLAND
4720 Q Boston Way, Lanham, MD 20708

CIRCLE NO. 129 ON FREE INFORMATION CARD

Tele Video® Users!

TEACH YOUR TELEVIDEO® WORDSTAR®

TV2000 PRICES SLASHED!! NOW \$179!!
(was \$220)

FEATURES

- 92 WordStar® commands
- The Power of a dedicated word processor
- No loss of TeleVideo® attributes
- Soft switch activated
- Cuts WordStar® learning time to an hour

INCLUDES

- microprocessor
- 46 Keycaps with WordStar® legends
- 45 Page WordStar® manual

WordTechSystem
953 Mountain View Dr., Suite 114
Lafayette, California 94549
(415) 254-7747



TRADEMARKS WORDSTAR MICROPRO INTERNATIONAL
TELEVIDEO TELEVIDEO SYSTEMS INC

CIRCLE NO. 130 ON FREE INFORMATION CARD

100 MHz scope, counter, timer, multimeter: All one integrated system.

100 MHz dual time base scope. 3.5 ns risetime; sweeps from 0.5 s to 5 ns/div; alternate sweep; $\pm 2\%$ vertical/horizontal accuracy; vertical sensitivity to 2 mV/div @ 90 MHz.

9-digit fluorescent display. Digitally accurate readouts accompany the CRT waveform. Error messages and prompts also appear on the display.

Dc volts and ac coupled true RMS volts. Measured through the Ch 1 scope input.

Gated measurements. Use the scope's intensified marker to measure frequency, period, width and to count events within specified portions of the signal.

Auto-ranged, auto-averaged counter/timer. Frequency, period, width, delay time, Δ -time, plus totalize to more than 8 million events—with 7 digits plus exponent displayed.

Auto-ranged DMM. Use floating DMM side inputs with up to 5000-count resolution. Get precise readouts of average dc and true RMS voltage. Measure resistance from milliohms to gigohms.

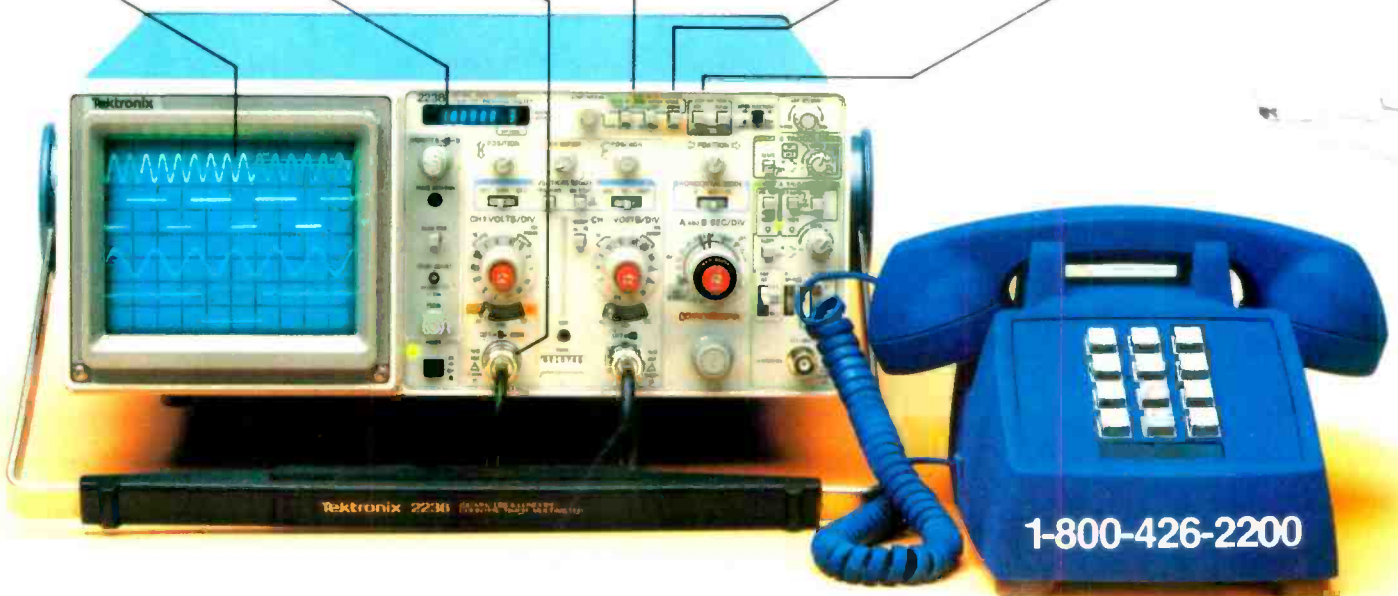

1-800-426-2200

Now make measurements faster, easier, with greater accuracy and user confidence. The Tek 2236 makes gated counter measurements, temperature, time, frequency, resistance and voltage measurements push-button easy. You see results concurrently on the 9-digit numeric readout and CRT display.

Its complete trigger system includes pushbutton trigger view, plus peak-to-peak auto, TV line, TV field, single sweep and normal modes.

At just \$2650*, the 2236 includes the industry's first 3-year warranty on all parts and labor, including the CRT.

Integrated measurement system. 3-year warranty. 15-day return policy. And expert advice. One free call gets it all! You can order, or obtain literature, through the Tek National Marketing Center. Technical personnel, expert in scope applications, can answer your questions and expedite delivery. Direct orders include operating and

service manuals and worldwide service back-up.

**Call toll-free:
1-800-426-2200,
Extension 109.**

In Oregon, call collect:
(503) 627-9000, Ext. 109.
Or write Tektronix, Inc.
P.O. Box 1700
Beaverton, OR 97075

Tektronix
COMMITTED TO EXCELLENCE

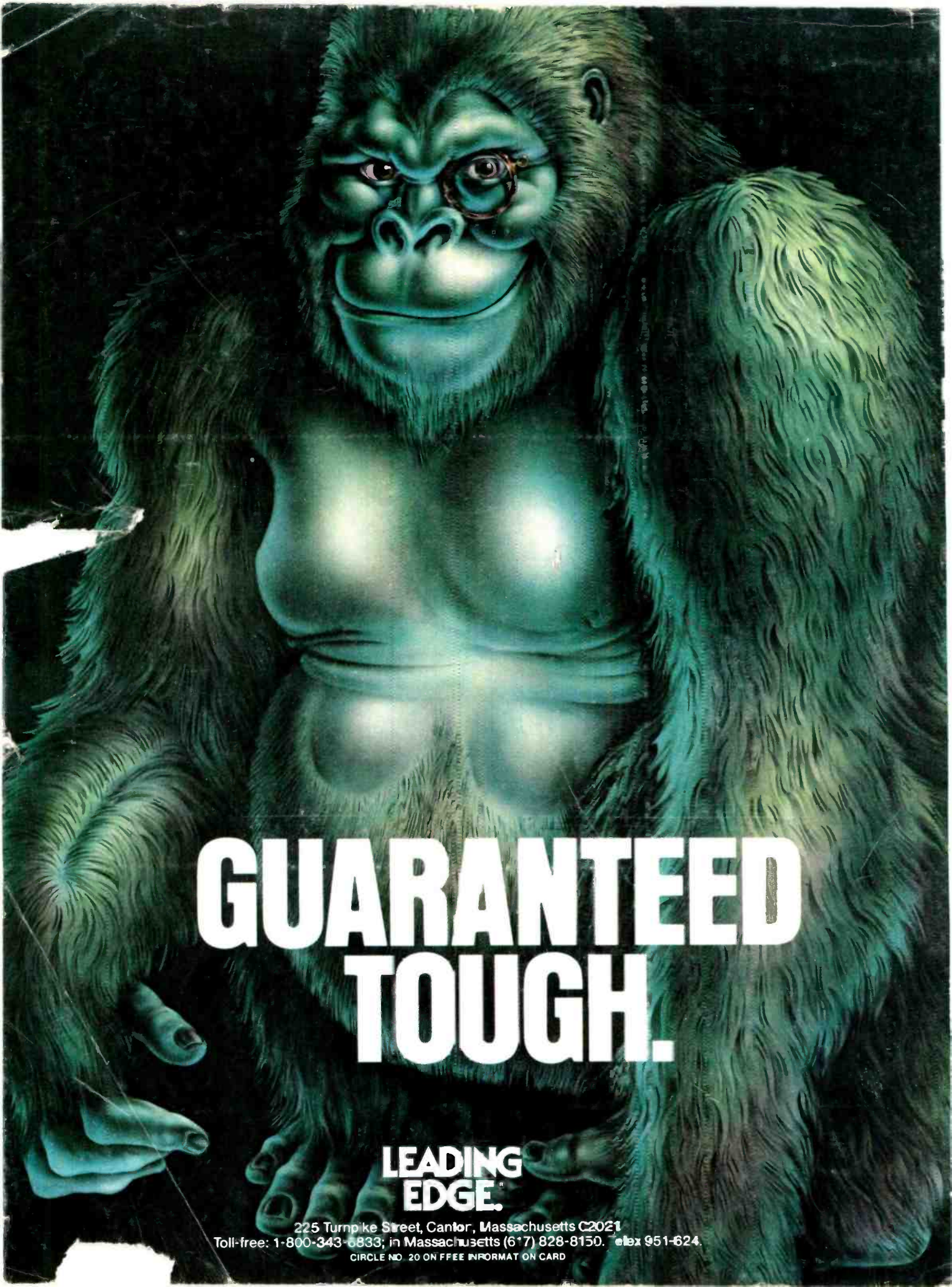

GUARANTEED TOUGH.

**LEADING
EDGE.**

225 Turnpike Street, Canton, Massachusetts 02021
Toll-free: 1-800-343-6833; in Massachusetts (617) 828-8150. ^{telex} 951-624
CIRCLE NO. 20 ON FREE INFORMATION CARD